



HAL
open science

Peridynamics modeling of hydraulic fracture interaction with natural fractures in fractured rock mass

Mingqi Qin, Diansen Yang, Yun Jia, Yun Zhou

► **To cite this version:**

Mingqi Qin, Diansen Yang, Yun Jia, Yun Zhou. Peridynamics modeling of hydraulic fracture interaction with natural fractures in fractured rock mass. *Engineering Fracture Mechanics*, 2024, pp.110299. 10.1016/j.engfracmech.2024.110299 . hal-04654798

HAL Id: hal-04654798

<https://hal.science/hal-04654798>

Submitted on 20 Jul 2024

HAL is a multi-disciplinary open access archive for the deposit and dissemination of scientific research documents, whether they are published or not. The documents may come from teaching and research institutions in France or abroad, or from public or private research centers.

L'archive ouverte pluridisciplinaire **HAL**, est destinée au dépôt et à la diffusion de documents scientifiques de niveau recherche, publiés ou non, émanant des établissements d'enseignement et de recherche français ou étrangers, des laboratoires publics ou privés.

Journal Pre-proofs

Peridynamics modeling of hydraulic fracture interaction with natural fractures in fractured rock mass

MingqiQin, Diansen Yang, Yun Jia, Yun Zhou

PII: S0013-7944(24)00462-4

DOI: <https://doi.org/10.1016/j.engfracmech.2024.110299>

Reference: EFM 110299

To appear in: *Engineering Fracture Mechanics*

Received Date: 21 March 2024

Revised Date: 15 May 2024

Accepted Date: 9 July 2024

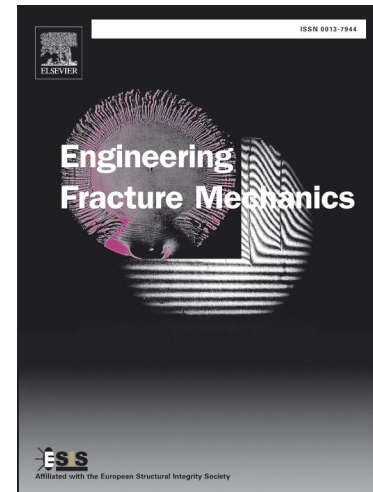

Please cite this article as: MingqiQin, Yang, D., Jia, Y., Zhou, Y., Peridynamics modeling of hydraulic fracture interaction with natural fractures in fractured rock mass, *Engineering Fracture Mechanics* (2024), doi: <https://doi.org/10.1016/j.engfracmech.2024.110299>

This is a PDF file of an article that has undergone enhancements after acceptance, such as the addition of a cover page and metadata, and formatting for readability, but it is not yet the definitive version of record. This version will undergo additional copyediting, typesetting and review before it is published in its final form, but we are providing this version to give early visibility of the article. Please note that, during the production process, errors may be discovered which could affect the content, and all legal disclaimers that apply to the journal pertain.

© 2024 Published by Elsevier Ltd.

1 **Peridynamics Modeling of Hydraulic Fracture Interaction with Natural** 2 **Fractures in Fractured Rock Mass**

3 Mingqi Qin^a, Diansen Yang^{a*}, Yun Jia^b, Yun Zhou^c

4 ^aSchool of Civil Engineering, Wuhan University, Wuhan 430072, Hubei, China

5 ^bUniversit'e de Lille, CNRS, Centrale Lille, UMR 9013 - LaMcube - Laboratoire de
6 M'ecanique, Multiphysique, Multi-echelle, F-59000 Lille, France

7 ^cInstitute of Rock and Soil Mechanics, Chinese Academy of Sciences, Wuhan, Hubei
8 430071, China

9

10 **Abstract**

11 In this paper, hydraulic fracturing in fractured rock masses are studied using
12 peridynamics, with a special attention to the interaction mechanisms between
13 hydraulic fractures (HFs) and natural fractures (NFs). To achieve this objective, a
14 two-dimensional numerical model is firstly analyzed to understand the effects of the
15 in-situ stress, fracturing fluid viscosity, fracturing fluid injection rate, fracture friction
16 coefficient and fracture approach angle on the interaction between HFs and NFs. The
17 obtained results reveal that larger in-situ stress ratio, elevated friction coefficient,
18 increased fluid viscosity, enhanced injection rate and wider approach angle create
19 more favorable conditions for HF penetration into NF. After that, the fracture
20 morphologies in fractured rock are analyzed under three-dimensional, successfully
21 reproducing the 'diversion' interaction pattern between fractures, a phenomenon
22 unattainable in 2D modeling. It was observed that there exists a mixed interaction
23 mode between penetration and diversion, particularly when the length of NF is limited
24 and the angle between NF and HF is less than 90°. Finally, the propagation of HFs
25 within a 3D fractured rock mass featuring arbitrarily distributed joints (NFs) is
26 simulated, providing new insights into complex real-world scenarios.

27 Key words: Hydraulic fracturing; Peridynamics; **Jointed rock**; **Interaction mechanism**;
28 **Three-dimensional modeling**.

29 **1. Introduction**

30 Hydraulic fracturing in fractured rock formations is a challenging task. In fracturing
31 operations, the discontinuous interfaces, natural fractures (NFs) and joints will
32 interact with hydraulic fractures (HFs), affecting the propagation of HFs. The
33 existence of NFs and joints will also have an important impact on the formation of HF

*Corresponding author.

E-mail address: dsyang@whu.edu.cn(D. Yang)

34 networks. The study of the interaction mechanisms between HF and NFs is crucial
35 for the construction and design of hydraulic fracturing in fractured reservoirs.

36 In practice, understanding the interaction mechanisms between HF and NF
37 presents an important challenge due to the absence effective criteria for predicting the
38 interaction patterns and outcomes among the fractures. The theory of linear elastic
39 fracture mechanics (LEFM) is generally used to judge crack propagation based on
40 geometric information, such as position and direction at the crack tip. However, when
41 a HF is close to a NF, and the HF tip may coincide with the NF, the specific
42 geometric information of the fracture tip cannot be obtained, and the propagation
43 direction of the HF cannot be judged by the LEFM theory. Therefore, the interaction
44 mechanism between HF and NFs can hardly be analyzed and simulated by LEFM
45 theory.

46 Some scholars have studied the interaction mechanism between HF and NFs by
47 analyzing field data or experimental data. Warpinski and Teufel[1] conducted a
48 theoretical analysis based on the measured data of a mining site and considered that
49 the in-situ stress difference is the main factor determining whether HF can penetrate
50 NF. Blanton[2, 3] analyzed **experimentally** the influence of the approach angle and
51 principal stress difference on the interaction between HF and NF experimentally. The
52 closer the approach angle was to 90° , the easier HF passed through NF. Bungler et
53 al.[4] further studied the effect of approach angle on propagation morphology when a
54 HF penetrated a NF. Based on the experimental results, Beugelsdijk et al.[5]
55 summarized the effect of the stress distribution on the crack shape during the
56 interaction of a HF and NF. Llanos et al.[6] studied the influence of different factors
57 such as the friction coefficient of NF surface and viscosity of the fracturing fluid on
58 the interaction between HF and NFs and pointed out that the higher the friction
59 coefficient and viscosity of the fracturing fluid, the more conducive it was to the HF
60 penetrating the NF. Guo et al.[7] also studied the influence of in-situ stress
61 distribution, fracturing fluid viscosity and treatment volume on the HF propagation in
62 fractured rock masses based on true triaxial tests. They pointed out that reasonable
63 fracturing fluid viscosity and displacement were the key factors, controlling the
64 fracturing effect in the studied fractured rock masses. In addition, Hanson et al.[8, 9],
65 Pippan et al.[10], and other scholars[1, 11] compared the effects of the in-situ stress
66 distribution, friction coefficient, approach angle and other factors on the interaction
67 **processes** between HF and NFs. These obtained experimental studies revealed that
68 the influence of various factors on the interaction between HF and NFs. However, it
69 is still difficult to analyze the interaction mechanism between HF and NF because
70 these tests cannot directly obtain crucial physical quantities, such as stress
71 distribution, pressure distribution and fracture aperture.

72 To explain the observed phenomena and quantitatively analyze the interaction
73 between HF and NFs, series of theoretical analysis have been performed. Blanton et
74 al.[2] proposed a criterion to judge whether a HF can pass through a NF. In the
75 experimental tests, HF and NF were assumed to be perpendicular to each other with

76 the neglect of the influence of fracturing fluid flow. According to this criterion, the
77 rock mass located on the side of the NF that is away from the HF may experience
78 tension-induced damage. Warpinski and Teufel[12] assumed that when the fracturing
79 fluid pressure at the intersection was higher than the normal stress on the NF surface,
80 the NF opened, On the other hand, when the rock mass slipped on both sides of the
81 NF, the HF could not penetrate the NF and consequently proposed a penetration
82 criterion considering the fracturing fluid pressure. Renshaw and Pollard[13] proposed
83 a criterion (the RP criterion) to verify whether a HF can penetrate a NF when the
84 approach angle is 90° . Gu and Wen[14] and Sarmadivaleh[15] improved the criterion
85 to judge whether HFs could penetrate NFs at any approach angle. In addition,
86 Anderson[16], Hanson et al.[17] and other scholars[18-20] theoretically analyzed the
87 influence of the friction coefficient, in-situ stress ratio and approach angle on the
88 interaction between HFs and NFs. These theoretical models often require additional
89 assumptions for simplification, and the models suitable for these criteria need to
90 satisfy certain geometric and boundary conditions (for example, the HF and the NF
91 should be perpendicular to each other), so they are difficult to apply to numerical
92 simulation and engineering design.

93 In parallel, a number of researchers have investigated the interaction mechanism
94 between HFs and NFs by numerical simulation. Shi et al.[21], Kohei et al.[22] and
95 Wang et al.[23] simulated the propagation process of a HF approaching a NF using
96 the extended finite element method (XFEM). However, due to the limitation of LEFM
97 theory, these models cannot judge the propagation path after the convergence of HF
98 and NF. After that, based on the previous theoretical research results mentioned
99 above, some scholars have improved the XFEM model to judge the propagation path
100 of cracks after HFs interact with NFs[24-26]. In addition, some scholars have
101 simulated the interaction process between HFs and NFs based on the displacement
102 discontinuous method (DDM) and finite element method (FEM) and studied the
103 influence mechanism of in-situ stress, layer properties, friction coefficient and
104 approach angle on the interaction process between fractures[27-34]. Zhang et al.[35]
105 have numerically investigated the process of HFs intersecting with NFs, and pointed
106 out that the fractures' offsets can hinder hydraulic opening of segments under high
107 compression, reducing their permeability and consequently increasing overall
108 upstream fracture pressure and opening. Moreover, they observed that some injected
109 fluid is lost into closed empty fractures intersecting the main HF, thereby delaying the
110 necessary pressure increases for growth beyond the intersecting fracture. Behnia et
111 al.[36] studied the influence of the relative positions (approach angle and distance)
112 between HFs and NFs on the propagation path of HF based on DDM. Moradi et
113 al.[37] used the higher-order displacement discontinuous method (HODDM) to
114 simulate the propagation of HF in rock masses containing NFs. They proposed a
115 criterion to assess the interaction between HF and NF, noting the potential for HF to
116 penetrate opened NFs. Additionally they observed that once HF penetrates an NF,
117 subsequent penetrations decrease due to the decrease in fracturing fluid pressure.
118 Zhang et al.[38] simulated hydraulic fracturing in rock masses containing complex NF
119 networks using DDM. They pointed out that the most complex fracture patterns can

120 be obtained when the maximum principal stress direction is perpendicular to the
121 principle natural fracture direction. Moreover, they found that increasing viscosity can
122 mitigate the adverse effects of stress anisotropy on fracturing efficiency. These
123 methods based on LEFM theory and traditional continuum mechanics still have some
124 problems in judging the initiation of newly generated cracks after HFs interact with
125 NFs. To overcome these problems, some scholars have used the discrete element
126 method (DEM)[39-43], the virtual multidimensional internal bond (VMIB)
127 method[44]and the FEM with damage elements[45, 46]. Compared with traditional
128 methods such as XFEM and BEM, these methods have advantages to simulate the
129 interaction process between HFs and NFs without additional assumptions. To
130 numerically study hydraulic fracturing in fractured rock masses more effectively, it is
131 necessary to solve the problem of fracture initiation (accompanied by penetration,
132 capture, offset, etc.) when the HFs interacts with the NFs and obtain sufficient
133 physical information (fracturing fluid pressure, fracture aperture, stress distribution)
134 to analyze the mechanism of interaction between the HFs and the NFs. Therefore, it is
135 necessary to establish a numerical framework that can not only simulate the
136 interaction between fractures without additional assumptions and criteria but also
137 obtain detailed physical information.

138 Peridynamics (PD)[47-49] is a recently developed numerical analysis method
139 based on nonlocal theory. PD solves physical fields by calculating integral in the
140 neighborhood of particles instead using differential calculations. It no longer
141 distinguishes between continuity and discontinuity, making it highly suitable for
142 modeling systems with arbitrarily distributed non-continuous interfaces. Based on
143 these characteristics, this paper establishes the hydraulic fracturing model based on
144 PD. Because the PD-based numerical framework is not constrained by the LEFM
145 theory, our model can simulate the interaction between HFs and NFs in a fractured
146 rock mass more effectively.

147 This paper employs a two-dimensional hydraulic fracturing numerical model to
148 comprehensively investigate the interaction mechanisms between HF and NF. The
149 study also explores the specific influences of geological conditions (in-situ stress
150 distribution), rock mechanics properties (friction coefficient), and construction
151 parameters (fracturing fluid viscosity and injection rate) on the interaction process.
152 Afterwards, utilizing a fully three-dimensional hydraulic fracturing numerical model,
153 the interaction patterns between HF and NF in three-dimensional rock mass will be
154 investigated. This revealed interaction modes between fractures that cannot be studied
155 through two-dimensional models. Finally, a fully three-dimensional fractured rock
156 mass model is constructed to simulate hydraulic fracturing within a rock mass
157 containing arbitrarily distributed natural fractures. The study focused on the
158 propagation patterns and distribution laws of HFs within the fractured rock mass.

159 2. Hydraulic fracturing model of a fractured rock mass based on PD

160 Based on the advantages of PD in simulating rock-like material fracture and

161 progressive failure, we have developed and tested a 2D/3D fluid structure coupling
 162 PD-based numerical framework for hydraulic fracturing[50, 51]. On the basis of our
 163 self-developed hydraulic fracturing numerical model, this paper combines the
 164 previously proposed PD contact-friction model, PD interface model[52],
 165 bond-breaking criterion based on bond stress[53], and parallel computing based
 166 calculation method[50] to establish a fractured rock mass numerical model, and
 167 applies it to the investigation of hydraulic fracturing and the interaction mechanism
 168 between fractures.

169 2.1. PD-based model of the fractured rock

170 In the PD-based model, a material point interacts with other material points
 171 within its influence domain (referred to as the "family" region) through "bonds". The
 172 interaction force between material points is termed as "bond force". The equation of
 173 motion for a material point can be written as[54]

$$174 \quad \rho(x)\ddot{\mathbf{u}}(x,t) = \int_{H_x} \mathbf{F}(\boldsymbol{\xi},t)dV_{x'} + \mathbf{F}_b(x,t) + \int_{H_x} \mathbf{T}(\boldsymbol{\xi},t)dV_{x'} \quad (1)$$

175 where H_x is the influence domain of the material. $\boldsymbol{\xi}$ is the relative position vector
 176 between the material points ($\boldsymbol{\xi}=\mathbf{x}'-\mathbf{x}$). $V_{x'}$ is the volume of the material point. $\mathbf{F}_b(x,t)$
 177 is the body force density of the material point x . $\mathbf{F}(\boldsymbol{\xi},t)$ is the bond force density between
 178 the material points associated with the elongation, which can be express as

$$179 \quad \mathbf{F}(\boldsymbol{\xi},t) = C \frac{|\boldsymbol{\xi}+\boldsymbol{\eta}|-|\boldsymbol{\xi}|}{|\boldsymbol{\xi}|} \mu(\boldsymbol{\eta},\boldsymbol{\xi},t) \cdot \frac{\boldsymbol{\xi}+\boldsymbol{\eta}}{|\boldsymbol{\xi}+\boldsymbol{\eta}|} dV_{x'} \quad (2)$$

180 where C is the micro modulus[49], $\boldsymbol{\eta}$ is the relative displacement vector of the
 181 material points on the either side of the bond($\boldsymbol{\eta}=\mathbf{u}_{x'}-\mathbf{u}_x$). $\mu(\boldsymbol{\eta},\boldsymbol{\xi},t)$ is a historical scalar
 182 indicating whether the bond is broken. When the bond between two material points is
 183 broken, the value is 0; otherwise, the value is 1.

184 $\mathbf{T}(\boldsymbol{\xi},t)$ in Equation (1) represents the equivalent repulsive force applied to the
 185 pairs of material points on either side of the broken bond, used to simulate the effect
 186 of fluid pressure. Its expression is[55]:

$$187 \quad |\mathbf{T}(\boldsymbol{\xi},t)| = \begin{cases} \frac{6P}{\pi\delta^3} & \text{for 2D} \\ \frac{6P}{\pi\delta^4} & \text{for 3D} \end{cases} \quad (3)$$

188 As mentioned in the first chapter, frictional forces play a significant role in the
 189 interaction between HFs and NFs. Investigating the influence mechanism of frictional
 190 on the interaction between the HF and the NF is one of the main focuses of this paper.

191 The contact-friction model we developed earlier for PD-based models is capable of
192 effectively simulating hydraulic fracturing in a jointed rock mass[55, 56].

193 In the contact-friction model applicable to PD, there may be normal contact force
194 and frictional force between the adjacent particles if the bond between them has been
195 broken ($|\xi| = \Delta x, \mu(\mathbf{n}, \xi, t) = 0, |\xi + \mathbf{n}| \leq \Delta x$). The normal contact force is expressed as[55,
196 56]

$$197 \quad \mathbf{F}_{\text{con}}(\xi, t) = \min\left(\alpha \frac{C}{\delta} S_n, 0\right) \mathbf{n} \cdot dV_x \quad (4)$$

198 where S_n is the relative normal displacement between the adjacent material points, \mathbf{n} is
199 the unit normal vector, and α is the adjustment coefficient (in this paper, $\alpha=2$).

200 According to Coulomb's law of friction, during the static friction phase
201 ($|\mathbf{F}_{\text{fri}}| \leq \mu_{\text{fri}} |\mathbf{F}_{\text{con}}|$), the static friction between the adjacent points can be written as

$$202 \quad \mathbf{F}_{\text{fri0}}(\xi, t) = \beta \frac{C}{\delta} S'_t \mathbf{t} \cdot dV_x \quad (5)$$

$$203 \quad S'_t = S_t - S_{\text{slide}}^0 \quad (6)$$

204 where \mathbf{t} is the unit tangential vector of the relative displacement, β is the adjustment
205 coefficient (in this paper, $\alpha=3$). S'_t is the increment of relative tangential displacement,
206 S_t is the relative displacement and S_{slide}^0 is the historical relative sliding displacement.
207 When the direction of the relative tangential velocity between the points is opposite to
208 the direction of the relative tangential displacement, the value of S_{slide}^0 is updated to
209 S_t .

210 In addition to the contact-friction model applicable to PD, we have also proposed
211 a cohesive interface model suitable for PD (please refer to the published literature[57,
212 58]), which is crucial for simulating hydraulic fracturing of fractured rock masses.

213 **In PD**, material damage is characterized by the breakage of bonds between
214 material points. When a bond breaks, there is no longer interaction between the
215 material points on either side of that bond[47]. In the classical PD-based model, when
216 the elongation rate of a bond exceeds a critical elongation rate S_0 that is related to the
217 material's fracture energy G_c , bulk modulus k , and the radius of the material point's
218 family δ (as shown in Equation (7)), the bond will fracture ($\mu(\mathbf{n}, \xi, t) = 0$)[59].

$$219 \quad S_0 = \begin{cases} \sqrt{\frac{\pi G_c}{3k\delta}} & \text{for 2D} \\ \sqrt{\frac{5\pi G_c}{9k\delta}} & \text{for 3D} \end{cases} \quad (7)$$

220 The aforementioned bond-breaking criterion based on critical elongation rate is
 221 inadequate for predicting shear failure, which plays a significant role in underground
 222 engineering. Therefore, in our previous research, we have developed a bond-breaking
 223 criterion based on the bond stress (Please refer to the published literature for
 224 details[50]).

225 The damage value of a material point is calculated using the following equation:

$$226 \quad D(\mathbf{x}, t) = 1 - \frac{\int_{H_x} \mu(\boldsymbol{\eta}, \boldsymbol{\xi}, t) dV_{\mathbf{x}'}}{\int_{H_x} dV_{\mathbf{x}'}} \quad (8)$$

227 Equation (9) is employed to determine the locations of macroscopic fracture
 228 segments: when the bond between the adjacent material points break, and the damage
 229 values of both material points are no less than 0.24, it is considered that there is a
 230 macroscopic fracture segment between the adjacent material points. More details on
 231 the method for determining the position of macroscopic fractures can be found in our
 232 published article[50].

$$233 \quad \begin{cases} |\boldsymbol{\xi}| = dx \\ \mu(\boldsymbol{\eta}, \boldsymbol{\xi}, t) = 0 \\ D(\mathbf{x}, t) \geq 0.24 \\ D(\mathbf{x}', t) \geq 0.24 \end{cases} \quad (9)$$

234 Due to the absence of intense dynamic responses or dynamic failure in the
 235 hydraulic fracturing process, and also to enhance the stability of the numerical model,
 236 the calculation of solid displacement adopts the adaptive dynamic relaxation method
 237 (ADR)[54, 60].

238 2.2. Fracturing flow

239 This paper assumes that the fracturing fluid inside the fractures behaves as steady
 240 state laminar flow. The fracture position is determined by Equation (9), and the
 241 aperture of the fracture w can be obtained by calculating the relative displacement of
 242 material points on either side of the fracture[53]. The flow rate Q per unit volume of
 243 material point can be expressed as

$$244 \quad Q = \rho_f \frac{k_f}{\mu_f} \nabla P \quad (10)$$

245 where ρ_f is the density of the fracturing fluid, μ_f is the viscosity of the fracturing fluid,
 246 and k_f is the permeability of the fracture following the Cubic law as

247

$$k_f = \frac{w^2}{12} \quad (11)$$

248

Based on Equations (10), the flow equation in the fracture can be written as

249

$$Q(x, t) = \sum_{i=1}^n q(\xi, t) \cdot A_{x\xi} + I(x, t) \quad (12)$$

250

$$q(\xi, t) = \gamma \frac{\rho_f k_f}{\mu_f |\xi|} (P(\mathbf{x}', t) - P(\mathbf{x}, t)) \quad (13)$$

251

where n is the number of fractures connected to fracture segment, $I(x, t)$ is the input flow rate per unit volume of fracture and γ is the volume of the fracture. For a 3D

252

253 model, when the radius of the family of the fracture $\delta_f = \Delta x$, $\gamma = \frac{1}{dx^2 \cdot w}$. $q(x, t, \xi)$ is

254

255 the flow rate to the fracture segment x along the bond ξ , $A_{x\xi}$ is the sectional area of the fracture.

256

257 Based on the compressibility of the fluid, the rate of change of hydraulic pressure within the fracture segment can be expressed as

258

$$\dot{P}(x, t) = \left(\frac{Q(x, t)}{\rho_f} - \frac{\dot{w}(x, t)}{w(x, t_0)} \right) K_f \quad (14)$$

259

where K_f is the bulk modulus of the fracturing fluid.

260

261 Equations (12), (13), and (14) implement simulations of hydraulic fracturing fluid flow within the fractures. Equation (3), along with the terms related to fracture aperture w in Equations (11) and (14), demonstrate that the numerical framework can 262 achieve hydro-mechanical coupling. To ensure the convergence of the model, 263 different time step lengths are selected for the iteration of rock movement and hydraulic pressure during fracturing. Specifically, the time step length Δt_f chosen for 264 simulating hydraulic fluid flow is significantly shorter than the time step length Δt_s selected for simulating rock movement. To maximize computational efficiency while 265 ensuring model convergence, within each main time step Δt , the calculation proceeds as follows: first, after computing the flow of fracturing fluid for n time steps, the 266 results (pressure changes) from the fluid flow simulation are incorporated into the calculation of rock displacement. Upon completing the calculation of rock 267 displacement, the results (fracture opening rates) are then utilized for the subsequent n time steps of fracturing fluid flow calculation. It is necessary to satisfy the condition 268 $\Delta t_s = n\Delta t_f = \Delta t$. Due to the significant computational time required for 3D models, parallel computing is introduced in this study to improve the computational efficiency 269 (the parallel computing process is described in our previously published work[56]). 270 The algorithmic flow of the numerical model is illustrated in Fig. 1. 271 272 273 274 275 276 277

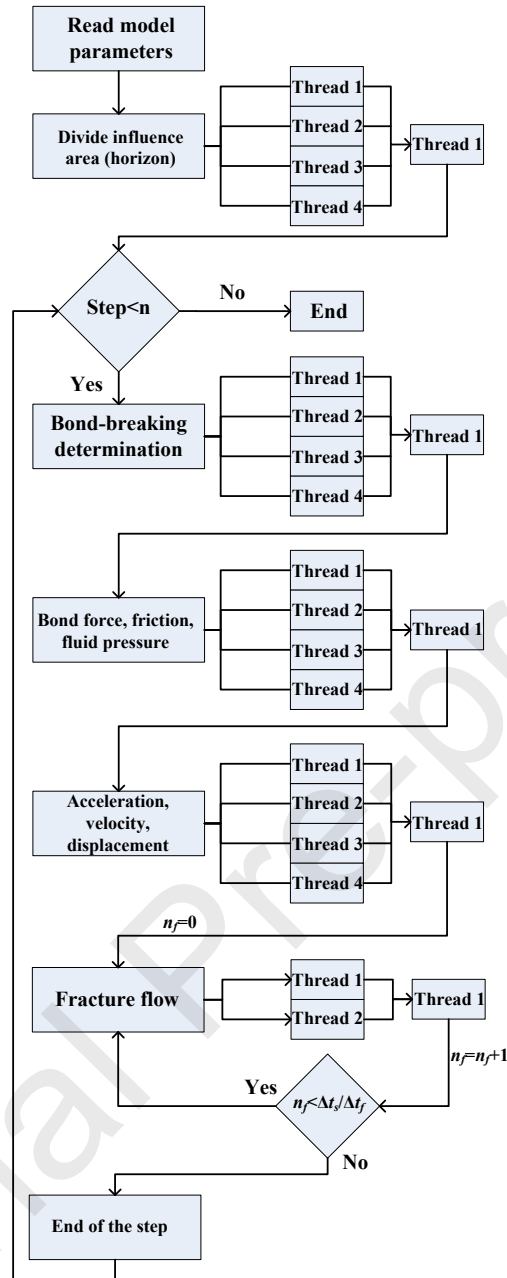

278

279 **Fig. 1. Algorithm flow chart.**

280 The accuracy and performance of the numerical framework used in this paper
 281 have been validated in our published works[50, 61].

282 2.3. Validation of the numerical model for hydraulic fracturing in fractured rock

283 In our previous work, we have compared the numerical solution of this model with
 284 the analytical solution based on the Khristianovich-Geertsma-de Klerk (KGD) model
 285 to verify the accuracy of the proposed model[62]. In this paper, the interaction
 286 between HFs and NFs is simulated, and the numerical results are compared with the
 287 experimental results of Khoei et al.[24]. The numerical model is shown in Fig. 2.
 288 There is a single NF in the model, and the displacement around the model is

289 constrained. The test conditions and model parameters are shown in Table 1.

290 **Table 1** Test conditions and model parameters

Specimen	W	H	(x1,y1)	(x2,y2)	y0	Young's modulus E	Poisson's ratio ν
1	111mm	45mm	(30.5,4) (mm, mm)	(55.4,42.16) (mm, mm)	27.9mm	36.5GPa	0.25
2	110mm	54mm	(55.4,42.16) (mm, mm)	(98.12,46.07) (mm, mm)	26.9mm	32.5GPa	0.25

291

Specimen	Fracture energy G_c	Internal friction angle ϕ	Cohesive force C
1	330J/m ²	48°	20 MPa
2	330J/m ²	48°	20 MPa

292

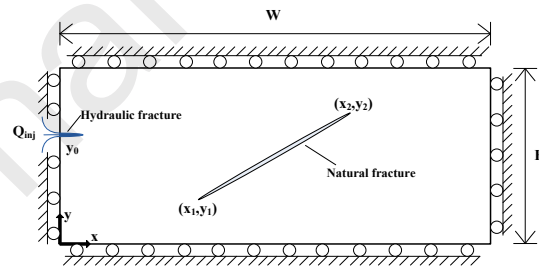

293 **Fig. 2.** Numerical model of the studied experimental tests.

294 It can be seen from Figs. 3 and 4 that the numerical simulation of HF
 295 propagation path is basically consistent with the experimental results, indicates that
 296 the developed model used in this paper is capable of reproducing the interaction
 297 process of HFs and NFs correctly.

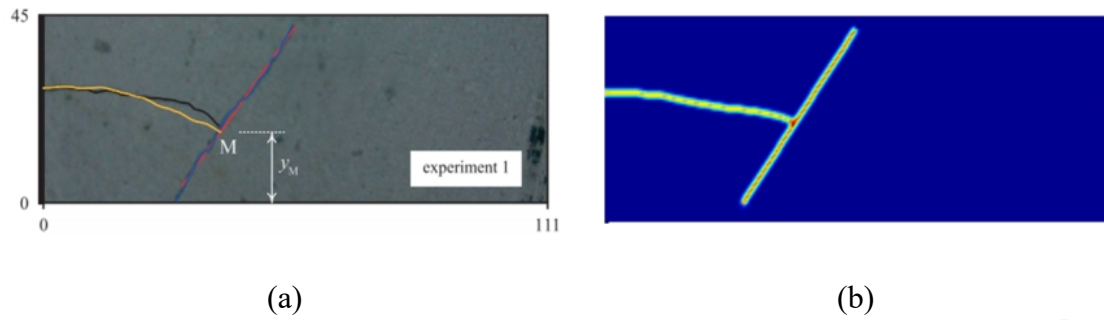

298 **Fig. 3.** Comparison of test 1 results: (a) experimental results; (b) simulation results.

299

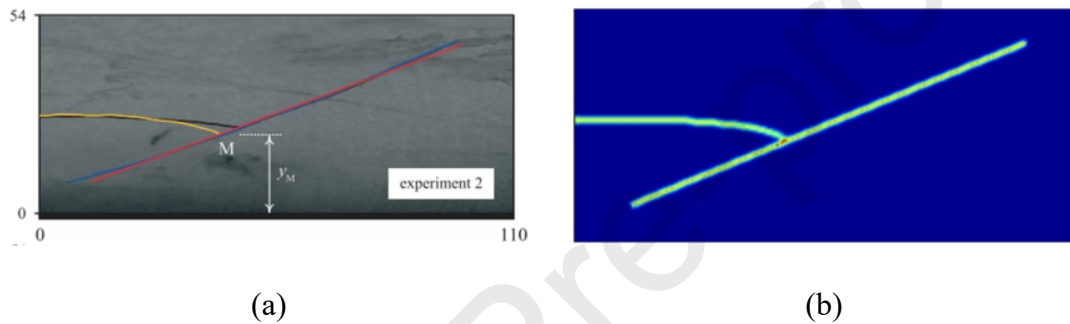

300 **Fig. 4.** Comparison of test 2 results: (a) experimental results; (b) simulation results.

301 3. Interaction mechanism between HF and NF

302 When a NF is close to a HF, two competing processes occur simultaneously. One
 303 process is that with the opening of HF, the rock mass on the other side of NF will
 304 crack under the action of friction (as shown in Fig. 5 (a)). The other one is that the
 305 fracturing fluid enters NF and induces the opening of NF, weakening the friction
 306 effects on the other side of the NF and preventing it from cracking (as shown in Fig. 5
 307 (b)). These two processes compete with each other and influence each other. When
 308 the first process is dominated, HF tends to penetrate NF. However, when the second
 309 process dominates, HF tends to be captured by NF.

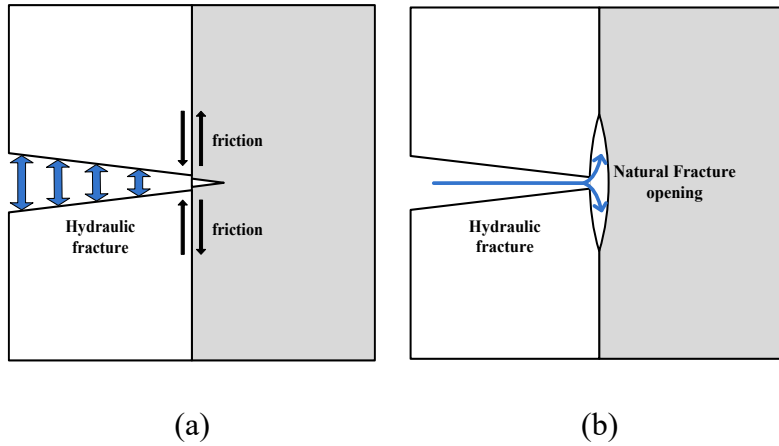

310 **Fig. 5.** Two main processes occur when a NF approaches a HF: (a) the rock mass on
 311 the other side of the NF cracks under the friction; (b) the fracturing fluid enters the NF
 312 and induces the NF opening.

313 To study the influence of the friction coefficient, fracturing fluid viscosity,
 314 in-situ stress and fracturing fluid injection rate on the interaction results of HF and NF
 315 (i.e., the influence of different factors on the above two processes), the 2D model is
 316 shown in Fig. 6. The model dimension is 3m * 3m, with an elastic modulus E of the
 317 model is 15 GPa, and a Poisson's ratio ν of 0.25. The characteristic length Δx
 318 of material particles is 0.025 m, and the individual time step Δt is 5e-5 s (where the time
 319 step for simulating rock deformation Δt_s is 5e-5 s, and the time step for simulating
 320 hydraulic fracturing fluid flow Δt_f is 5e-10 s). There is a vertical NF (noncohesive
 321 fracture) in the center of the model. The HF propagates from the left side of the model
 322 to the NF. The aperture of NF, the distribution of tensile stress on the right side of the
 323 NF and the change in fracturing fluid pressure in NF are observed. This paper will
 324 study the mechanisms of interaction between HF and NF by investigating the
 325 distribution of in-situ stress (by adjusting the maximum horizontal stress σ_H and
 326 minimum horizontal stress σ_h), mechanical properties of fracture surfaces (by
 327 adjusting the friction coefficient μ_{fr}), and construction parameters (by adjusting the
 328 fracturing fluid viscosity μ_f and injection rate Q). The loading condition and model
 329 parameters are given in Table 2.

330 **Table 2** Loading conditions and model parameters of the sample with a vertical NF

Case	Minimum horizontal stress σ_h	Maximum horizontal stress σ_H	Friction coefficient μ_{fr}	Fracturing fluid viscosity μ_f	Injection rate Q
A	3 MPa	4 MPa	0 to 0.65	1e-3 Pa·s	1e-3 m ³ /s

B	3 MPa	3 to 6 MPa	0.25	1e-3 Pa·s	1e-3 m ³ /s
C	3 MPa	4 MPa	0.25	2.5e-4 to 5e-3 Pa·s	1e-3 m ³ /s
D	3 MPa	4MPa	0.25	1e-3 Pa·s	2.5e-4 to 1e-3 m ³ /s

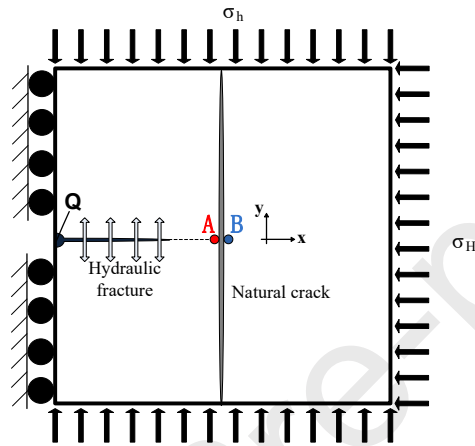

331

332

Fig. 6. Diagram of the numerical model with a vertical NF

333 3.1. Effect of friction coefficient

334 Case A in Table 2 illustrates the effect of the friction coefficient on the interaction
 335 between HF and NF. When HF is close to NF, the change of tensile stress at point B
 336 with the change of friction coefficient μ_{fri} is shown in Fig. 7(a). When HF extends to
 337 point A (here, 1000 steps after the HF reaches point A is considered), the distribution
 338 of tensile stress on the right side of the surface of NF is shown in Fig. 7(b).

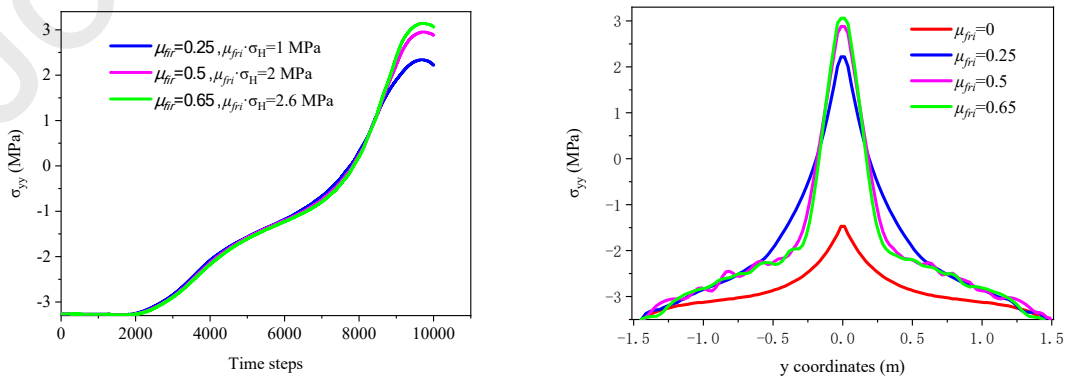

(a)

(b)

339 **Fig. 7.** Effect of the friction coefficient on the distribution of tensile stress on the right
 340 side of the HF: (a) variation curve of tensile stress at point B; (b) distribution of
 341 tensile stress on the right side of NF.

342 The obtained results show that, the tensile stress on the right side of NF increases
 343 with friction coefficient, which may induce the HF penetrating the NF. Additionally,
 344 Fig. 8(a) indicates that the tensile stress σ_{yy} on the right side of the NF is not directly
 345 linearly proportional to the friction coefficient μ_{fri} , while the friction force is
 346 significantly higher than $\mu_{fri} \cdot \sigma_H$. This observation is related to the fact that the sliding
 347 friction is a typical nonlinear process and then the magnitude of frictional forces
 348 acting on the fracture surfaces in each set of cases is not linearly proportional to the
 349 friction coefficient. Since the areas of stress concentration near the HF tip (as shown
 350 in Fig. 8), the friction force on the right side of NF will be significantly higher than
 351 that of $\mu_{fri} \cdot \sigma_H$.

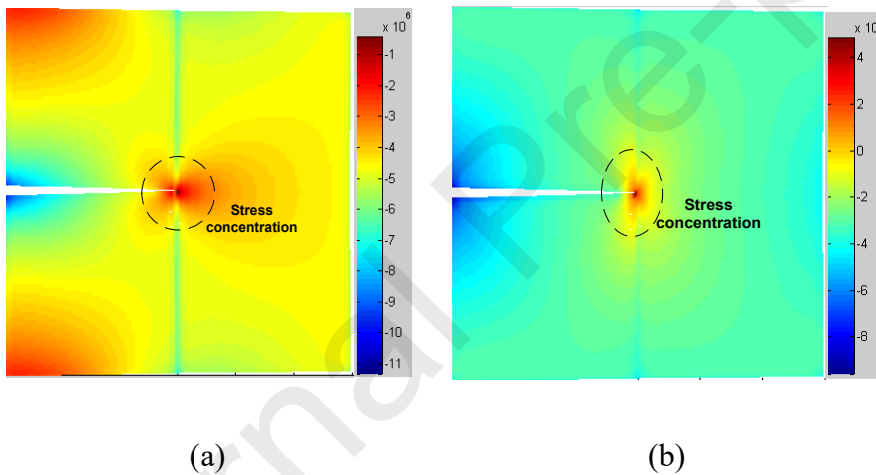

(a)

(b)

352 **Fig. 8.** Schematic diagram of the stress concentration at the tip of the HF: (a)
 353 distribution of σ_{xx} ; (b) distribution of σ_{yy} .

354 3.2. Effect of in-situ stress distribution

355 Case B illustrates the effect of the in-situ stress distribution (in-situ stress ratio) on the
 356 interaction between HF and NF. In hydraulic fracturing, in-situ stress is an important
 357 factor affecting the fracturing behavior. When HF is close to NF, the distribution of
 358 in-situ stress will affect the contact force of NF surface, thus affecting the friction
 359 force on the right side of the NF. At the same time, the distribution of in-situ stress
 360 also affects the opening process of NF, as well as the interaction between the HF and
 361 the NF. When HF is close to NF, the change in tensile stress at point B is shown in
 362 Fig.9(a). When HF extends to point A, the tensile stress distribution on the right side
 363 of the NF is shown in Fig. 9(b). The simulation results in Fig. 9 show that with the

364 increase of in-situ stress ratio, the tensile stress on the right side of the NF increases.
 365 Therefore, the greater the in-situ stress ratio is, the more likely the HF is to penetrate
 366 the NF. Meanwhile, Fig. 9(a) shows that the in-situ stress ratio has little effect on the
 367 crack propagation rate and rock mass deformation rate.

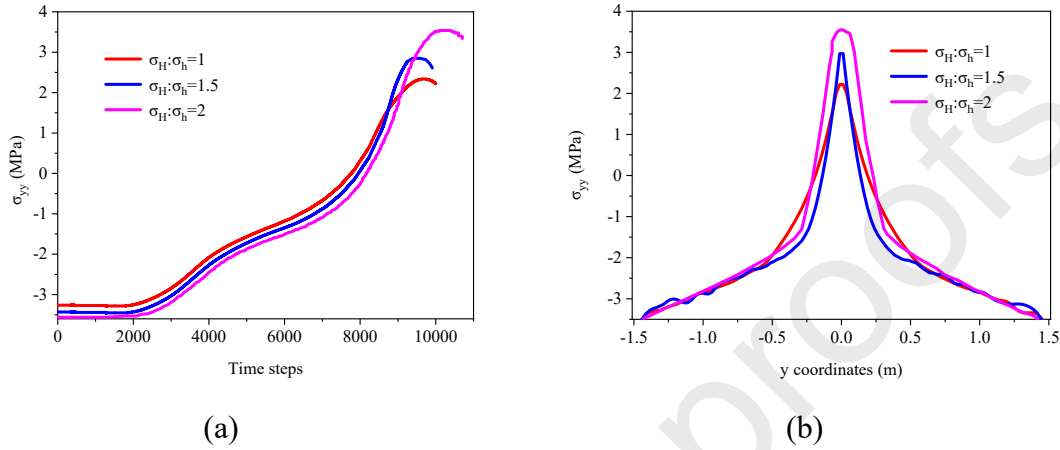

368 **Fig. 9.** The influence of in-situ stress ratio on the distribution of tensile stress on the
 369 right side of the HF: (a) the curve of tensile stress at point A (when the value reaches
 370 its peak); (b) the distribution of tensile stress on the right side of the NF.

371 Combined with the contents of sections 4.1 and 4.2, following the model shown
 372 in Fig. 10 and resetting the boundary conditions, the interaction results of HF and NF
 373 under different in-situ stress ratios and friction coefficients are obtained by fixing σ_h
 374 to 6 MPa and adjusting σ_H and μ_{fri} . The numerical simulation results are compared
 375 with the prediction results of the RP criterion (as shown in Equation (15), the
 376 compressive stress is negative. T_0 is the tensile strength of the rock, and in PD, T_0 can
 377 be related to the critical elongation of the bond[63]). The simulation results of this
 378 model are consistent with the prediction results of the RP criterion[64] (Fig. 10).

379

$$\frac{-\sigma'_{xx}}{T_0 - \sigma'_{yy}} > \frac{0.35 + \frac{0.35}{\mu_{fri}}}{1.06} \quad (15)$$

380

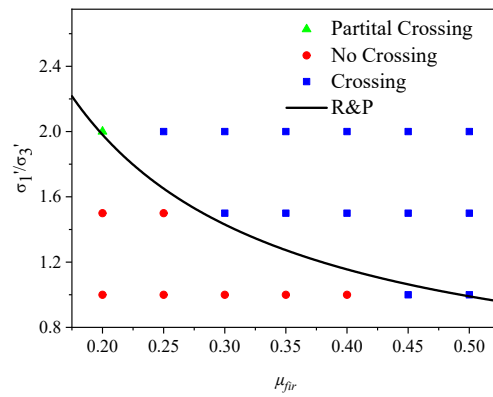

381 **Fig. 10.** Comparison of numerical results and R&P criteria on prediction results.

382 3.3. Effect of fracturing fluid viscosity

383 Case C illustrates the effect of fracturing fluid viscosity on the interaction between the
 384 HF and the NF. The fracturing fluid viscosity affects the flow velocity and pressure
 385 distribution of the fracturing fluid in the fractures. With the increase in the viscosity
 386 of the fracturing fluid, the fracturing process changes from "toughness dominated"
 387 to "viscosity dominated"[65]. At this time, the propagation speed and opening degree
 388 of HF are decelerated. This observation can be explained by the fact that the speed of
 389 the fracturing fluid entering the NF decreased.

390 Under different fracturing fluid viscosities, when HF propagates toward the point
 391 A (1000 steps after the HF reaches point A), the numerical results are given in Fig.
 392 11.

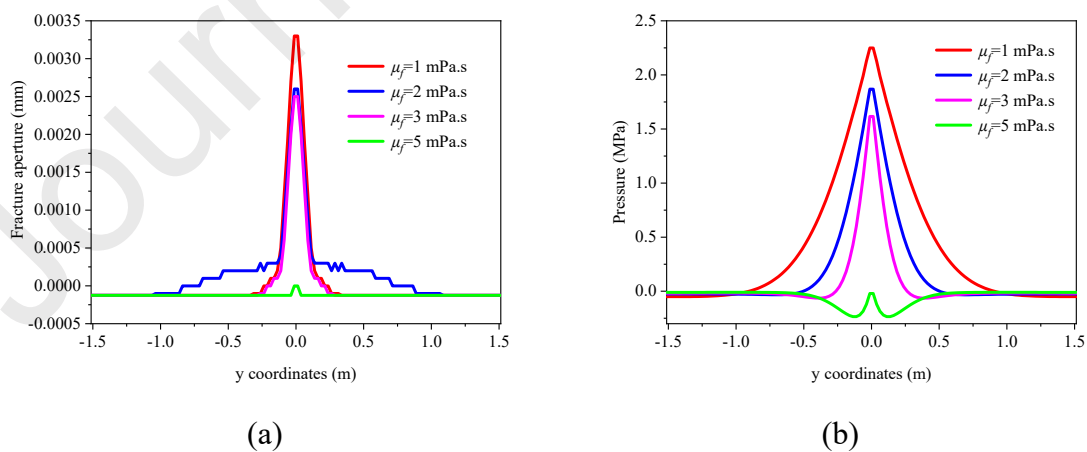

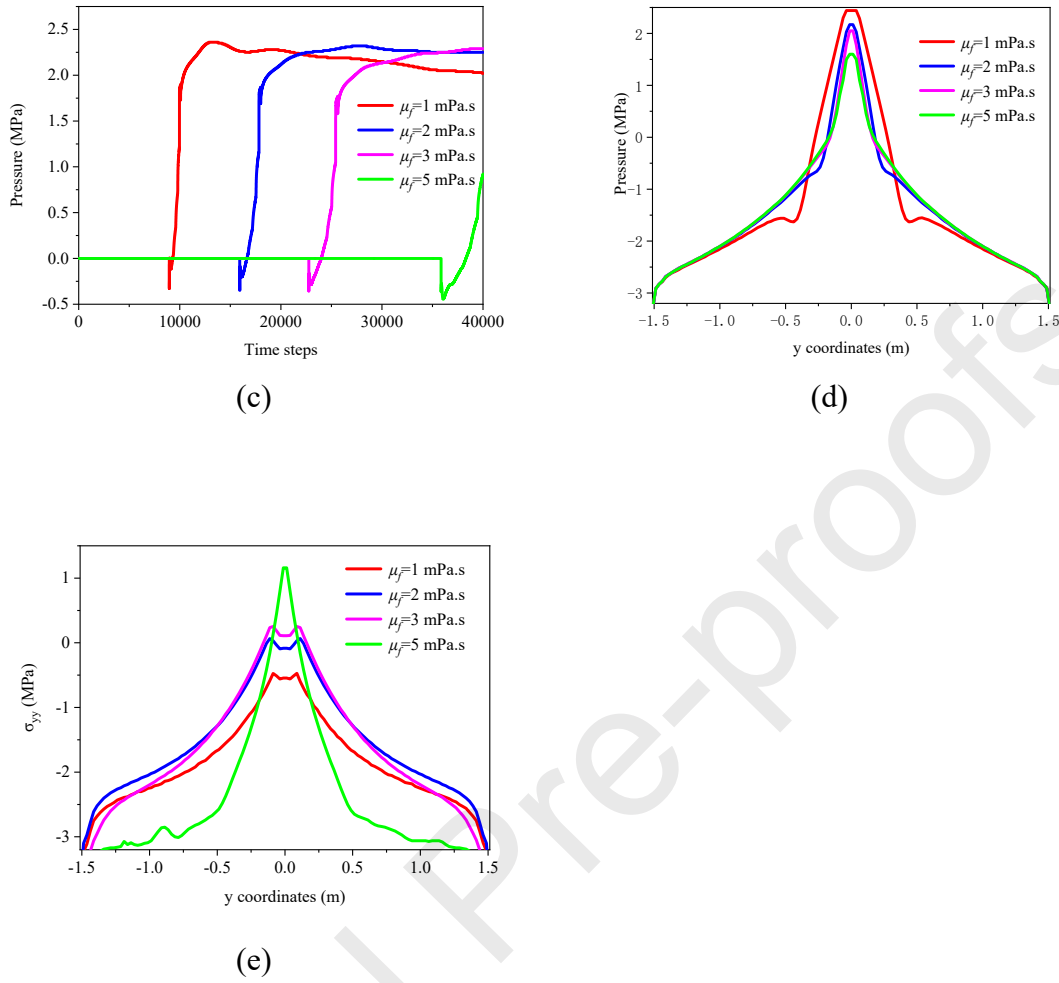

393 **Fig. 11.** Influence of fracturing fluid viscosity on the interaction between HF and NF:
 394 (a) aperture distribution of NF; (b) pressure distribution in the NF; (c) curve of tensile
 395 stress change at point B; (d) tensile stress distribution on the surface of NF (when the
 396 value reaches its peak); (e) tensile stress distribution on the surface of NF (5000 steps
 397 after the HF come into contact with NF).

398 According to the calculation results, with the increase in fracturing fluid
 399 viscosity, the speed of the fracturing fluid entering the NF decreases significantly (as
 400 shown in Fig. 11(c)). When $\mu_f = 5$ mPa·s, the fracturing fluid could not completely fill
 401 the newly expanded space in the NF, so negative pressure arises in the NF), and the
 402 HF aperture also decreases significantly (Fig. 11(a)). Although the peak friction on
 403 the right side of the NF (at point B) decreases slightly with the increase in fracturing
 404 fluid viscosity (Fig. 11(d)), the period during which friction is maintained at a high
 405 value is significantly prolonged (Fig. 11(c) and (e)); after 5000 steps of the HF
 406 propagating to point A, the tensile stress acting on the right side of the NF is much
 407 greater when μ_f is 5mPa·s than when u_f is 1mPa·s). Therefore, the higher the
 408 fracturing fluid viscosity, the more favorable it is for the HF to penetrate the NF. This
 409 conclusion is consistent with that obtained by Llanos et al[6].

410 3.4. Effect of injection rate

411 Case D illustrates the effect of the injection rate on the interaction between HF and
 412 NF. With the increase in the injection rate of the fracturing fluid, the HF propagation
 413 tends to be "toughness dominated". The injection rate affects the propagation and
 414 opening rate of the HF, as well as the opening rate of NF. Therefore, the injection rate
 415 also affects the interaction between NF and HF. Fig.12(a) shows the change curve of
 416 the tensile stress at point B of NF surface for different injection rates; similarly, Fig.
 417 12(b) shows the change curve of the fracturing fluid pressure in the NF near point B,
 418 and Fig.12(c) reflects the change curve of the aperture of the NF near point B.

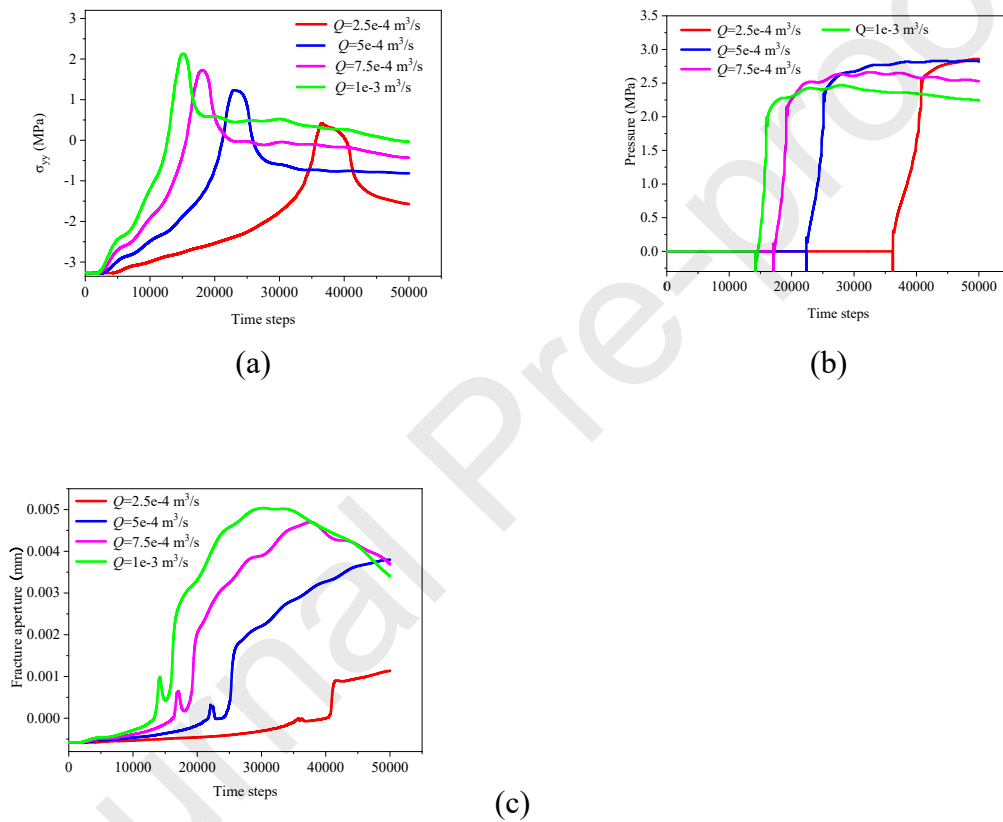

419 **Fig. 12.** The influence of the fracturing fluid injection rate on the interaction between
 420 HF and NF: (a) variation in the tensile stress at point B; (b) the pressure curve in the
 421 NF near point B; (c) variation in the tensile stress at point B.

422 Fig. 12 shows that with the increase injection rate, although the increase in the
 423 opening rate of NF (Figs. 12(b) and (c)) leads to the decrease in the period of high
 424 friction force of the rock mass on the right side of NF (Fig. 12(a)), the increase in
 425 injection rate can significantly increase the friction force of the rock mass on the right
 426 side of the NF (Fig. 12(a)). Therefore, at higher injection rates, the rock mass on the
 427 right side of NF is more likely to crack, and HF is more likely to penetrate NF.

428 3.5. Effect of approach angle

429 To study the effect of the approach angle on the interaction between a HF and a NF, a
 430 new hydraulic fracturing model is established, as shown in Fig. 13. The model size
 431 and material parameters are the same as those in sections 4.1 to 4.4, and an inclined
 432 cohesive joint is arranged in the model. The cohesive joint model can be referred to in
 433 our published works[52]. The parameters and loading conditions of the model are
 434 shown in Table 3. The emphasis here is that, to simulate real conditions as closely as
 435 possible, the joint in this section is a cohesive fracture before opening (reference can
 436 be made to our published work on the cohesive fracture PD model[52]). When the
 437 cohesive fails and the joint opens, the frictional force and contact force on the fracture
 438 surface come into effect.

439 **Table 3** Loading conditions and model parameters.

Approach angle θ	Minimum horizontal stress σ_h	Maximum horizontal stress σ_H	Friction coefficient μ_{fr}	Fracturing fluid viscosity μ_f	Injection rate Q
15-90°	10 MPa	12.5 MPa	0.6	15e-3 Pa·s	1e-3 m ³ /s
Fracture energy of the rock G_{c1}		Fracture energy of the joint G_{c2}			
100 J/m ²		20 J/m ²			

441

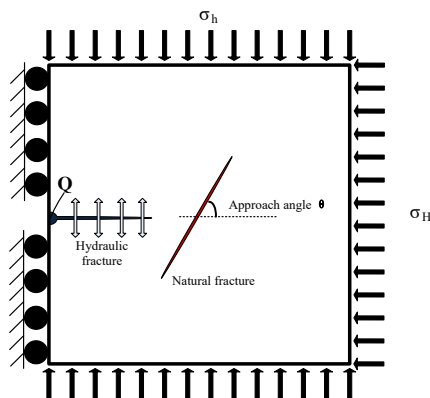

442

443 **Fig. 13.** Diagram of the model with a cohesive joint.

444 Because the NF is inclined, the rock mass on the right side of the NF is damaged
 445 by not only tension but also the combined action of tension and shear. The failure
 446 mechanism is complex, so it is not convenient to analyze the interaction between HF
 447 and NF by comparing the stress distribution on the right side of the NF. When NF is
 448 inclined, it is difficult to predict the position where NF will be penetrated by HF as
 449 HF may not propagate along a straight line. Therefore, it is difficult to analyze the
 450 influence of the approach angle on the interaction between the HF and the NF by
 451 directly presenting the aperture and pressure distribution of the NF. Therefore, the
 452 fracture propagation path and distribution will be studied to analyze the interaction
 453 between NF and HF under different approach angles. The results of fracture
 454 distribution at different approach angles are shown in Fig. 14, and the evolution of
 455 fracture length is shown in Fig. 15.

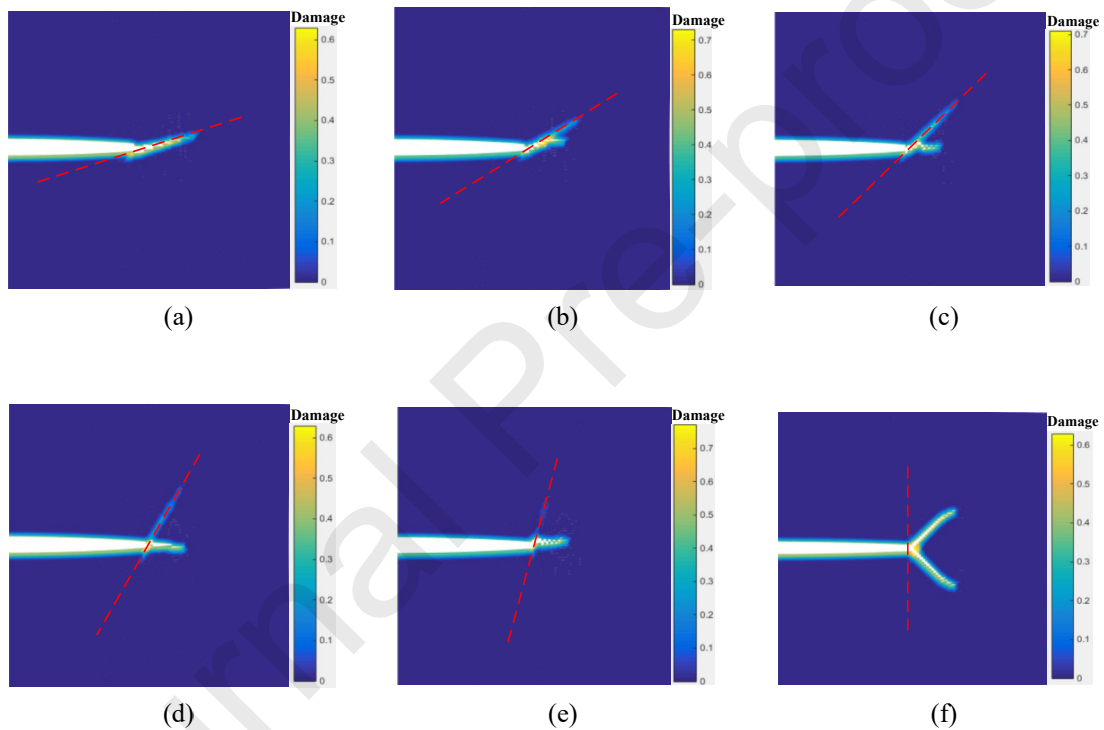

456 **Fig. 14.** Fracture distribution in the case with different inclination angle of NF: (a)
 457 $\theta=15^\circ$; (b) $\theta=30^\circ$; (c) $\theta=45^\circ$; (d) $\theta=60^\circ$; (e) $\theta=75^\circ$; (f) $\theta=90^\circ$.

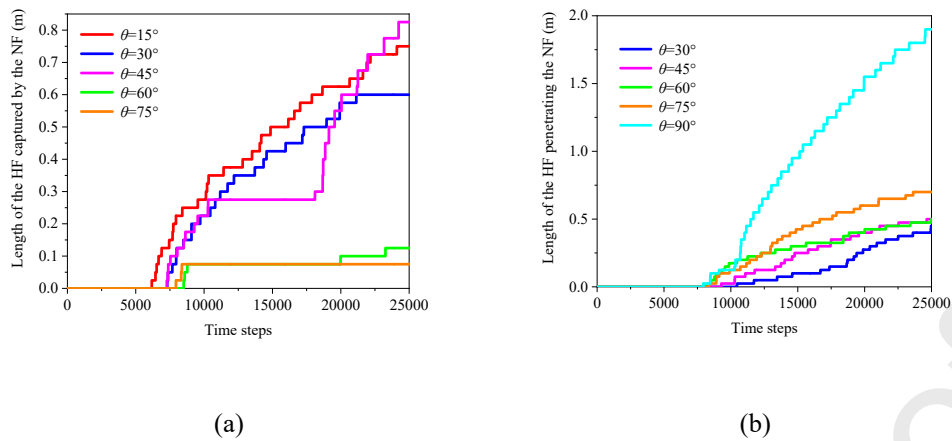

458 **Fig. 15.** Evolution of fracture length: (a) length of the HF captured by the NF; (b)
 459 length of the HF captured by the NF.

460 According to the simulation results, when the dip angle of NF is below 30° , HF
 461 is completely captured by NF (Fig. 14(a)). When the dip angle of NF is between 30°
 462 and 60° , HF bifurcates near NF: one branch being captured by the NF and the other
 463 one penetrating it. Moreover, one observes that the propagation speed of HF increases
 464 with the increase in the dip angle of NF (Fig. 15). When the dip angle of NF is 75° or
 465 more, HF penetrates NF without capture. When the dip angle of HF is approximately
 466 75° , it deviates slightly before penetrating NF (Fig. 14(e)). Whereas, when the angle
 467 is 90° , HF bifurcates and traverses NF (both bifurcations directly penetrate the
 468 interface, as shown in Fig.14(f)). The simulated bifurcation of fracture, while
 469 penetrating a weakly adhesive interface, mirrors a previously verified experiment.
 470 This phenomenon is coherent with the experimental data of [66], which is worthy of
 471 further investigation. The simulation results also reveal a significant influence pattern
 472 of HF and the morphology and propagation mode of the NF: when HF interacts with
 473 NF (e.g. HF capture or deviation along NF), HF propagation slows while the aperture
 474 widens. If HF directly penetrates the interface, it propagates faster, but with a lower
 475 aperture (compare Fig. 14(f) with other images in Fig. 14, as well as compare the light
 476 blue curve in Fig. 15(b) with other curves).

477 4. Interaction patterns between a HF and a NF in three-dimensional rocks

478 In the previous section, the interaction mechanisms between HF and NF have
 479 been analyzed under 2D conditions. Additionally, the influencing factors, such as the
 480 stress distribution, fracture surface friction coefficients, and hydraulic fracturing
 481 construction parameters, on the interaction between HF and NF are investigated.
 482 However, in actual hydraulic fracturing operations, both HF and NFs present as
 483 complex discontinuity in three-dimensional space[67]. In addition, the fracture
 484 propagation depends on the in-situ triaxial stress field[52]. Although two-dimensional
 485 hydraulic fracturing models are capable of revealing the **principal** interaction

486 mechanisms between NF and HF, the propagation patterns of fracture surfaces **cannot**
 487 be captured by them. Another noteworthy point is that, based on the two-dimensional
 488 model, researchers[68] have classified the interaction patterns between HF and NF as
 489 penetration, deflection, and captured, **et.** Under three-dimensional conditions,
 490 "diversion" is also identified as a significant interaction pattern (as shown in Fig. 16),
 491 wherein HF bypasses NF and continues to propagate without penetration[69]. This
 492 particular interaction pattern can only be simulated using a three-dimensional model.
 493 In this section, the interaction patterns between HF and NFs under three-dimensional
 494 conditions are investigated, as well as the propagation modes and distribution
 495 characteristics of fracture surfaces.

496 The **model's** dimensions are 1.05 m*1.05 m*1.8 m. The elastic modulus of the
 497 studied material E is 15 GPa, and the critical energy release rate G_c is 100 J/m². The
 498 characteristic length of material points Δx is 0.03 m, and the time step Δt used in the
 499 calculations is 2.5e-5 s. The injection rate of the fracturing fluid is 2e-4 m³/s.

500 For the convenience of studying the interaction morphology between HF and NF
 501 in 3D, their relative positional relationships will be categorized into x-z oblique
 502 intersection (NF's outward normal parallel to the x-z plane), y-z oblique intersection
 503 (NF's outward normal parallel to the y-z plane), and x-y oblique intersection (NF's
 504 outward normal parallel to the x-y plane).

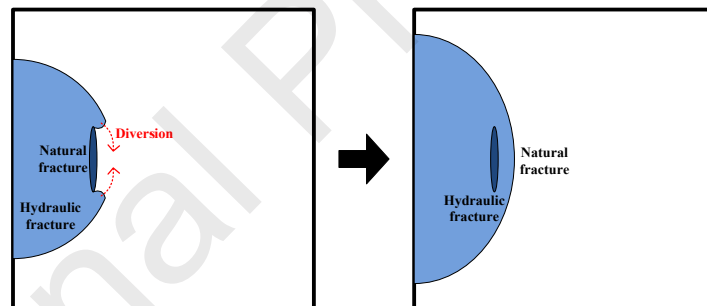

505
 506 **Fig. 16.** Diagram of the HF bypassing the NF.

507 4.1. The x-z oblique intersection

508 The "x-z oblique intersection" refers to the situation where the outer normal of NF is
 509 parallel to the **x-z** plane (Fig. 17). This case is similar to a two-dimensional model,
 510 which has been studied in previous section. Different interaction modes between HF
 511 and NF can be obtained by adjusting in-situ stress distribution (σ_x , σ_y , and σ_z),
 512 fracturing fluid viscosity μ_f , and NF dip angle θ . The boundary conditions and
 513 construction parameters for each group of cases are given in Table 4.

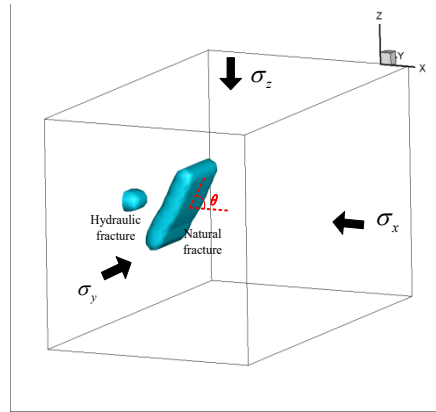

514

515

Fig. 17. Diagram of the x-z oblique intersection.

516

Table 4 Boundary conditions and construction parameters of the x-z oblique intersection model.

517

Case	Horizontal stress σ_x	Horizontal stress σ_y	Vertical stress σ_z	Friction coefficient μ_{fir}	Fracturing fluid viscosity μ_f	θ
A	10 MPa	10 MPa	10 MPa	0.45	10 mPa·s	60°
B	10 MPa	10 MPa	10 MPa	0.45	60 mPa·s	60°
C	10 MPa	30 MPa	10 MPa	0.45	10 mPa·s	60°
D	10 MPa	10 MPa	10 MPa	0.45	10 mPa·s	75°
E	20 MPa	10 MPa	10 MPa	0.45	10 mPa·s	75°

518

The injection volume of fracturing fluid pump Q_v is approximately $2.5e-5 \text{ m}^3$ in each case (Fig. 18). The simulation results indicate that the "capture" state in the 3D (Fig. 18(a)) differs significantly from those in 2D[68, 70]. In 3D model, the edges of HF and NF come into contact and fuse, resulting in the upper end of the NF forming a shape resembling a "sunshade" (i.e., after HF is captured by NF, NF not only propagates in the x-direction but also extends in the x-z plane). In Case B, the increased viscosity of the fracturing fluid ($\mu_f=60 \text{ mPa}\cdot\text{s}$) leads to a reduced rate of fluid influx into NF, limiting the opening of NF and thereby promoting HF to bypass it. As revealed in our previous research[50], an increase in horizontal stress along the y-direction can promote the propagation of HF in the perpendicular direction (x-direction). Therefore, in the Case C, with the increasing of σ_y , HF not only penetrates NF but also bypass the NF, propagating on the other side of NF (as shown

529

530 in Fig. 18(d)). In the Case D, despite having construction parameters and boundary
 531 conditions identical to Case A, the increased dip angle ($\theta=60^\circ$ in case A, while $\theta=60^\circ$
 532 in case D) of NF induces HF to bypass it. Therefore, with the growing inclination
 533 angle, the diversion occurrence becomes more likely (comparing Fig. 18(f) to Fig.
 534 18(a)). Furthermore, although HF bypasses NF in both Case B and Case D, in the
 535 scenario with a smaller dip angle (Case B), there is also lateral displacement of HF
 536 during bypassing. In other words, the simulation results of the Case B exhibit a mixed
 537 form of bypassing and deflection. The Case E (Figs. 18(g) and (h)) further validates
 538 the conclusions from Section 4. These observations indicate the horizontal stress
 539 increases, the frictional forces acting on the surface of NF also increase and then
 540 facilitate the penetration of HF through NF. In this particular case, due to the incline
 541 of NF, there is also lateral displacement of HF as it penetrates NF, resulting in an
 542 arched distribution of HF on the other side of NF. The obtained results further
 543 indicate that, despite the distribution pattern of fractures in 2D closely resembling the
 544 x-z intersection, the 3D model is still capable of reproducing numerically a more
 545 diverse and accurate pattern of fracture propagation.

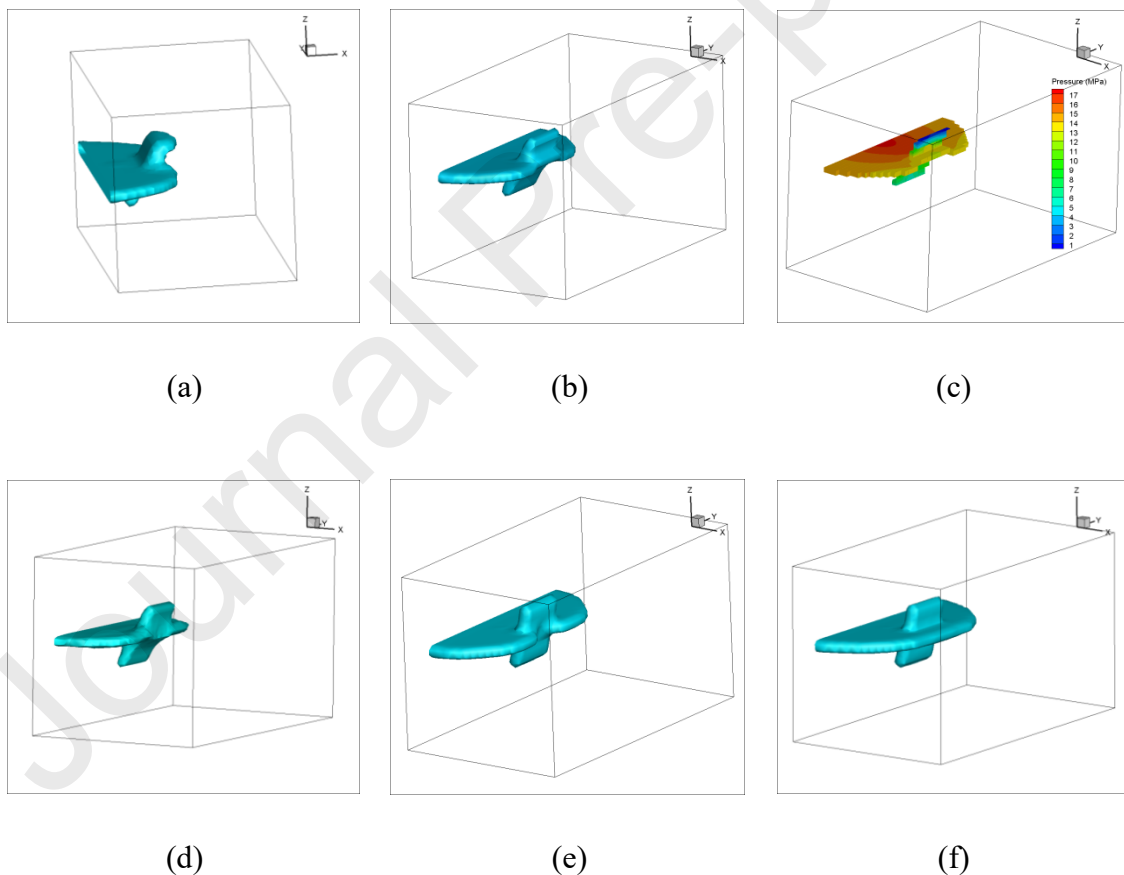

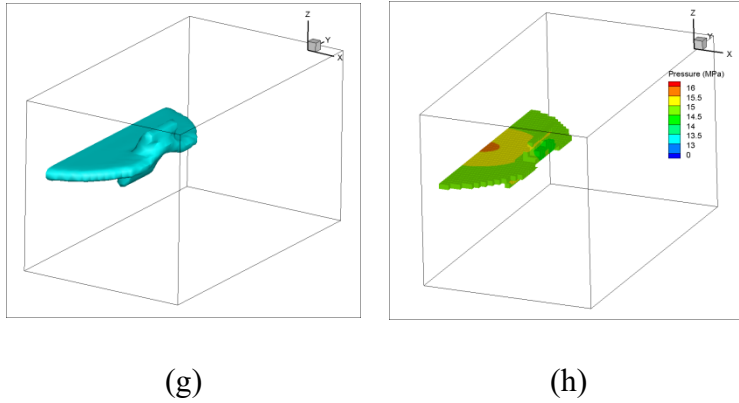

546 **Fig. 18.** Fracture distribution of different cases in x-z oblique intersection: (a) case A;
 547 (b) case B; (d) case C; (e) case D ($Q_v=2.25\text{ m}^3$); (f) case D ($Q_v=2.25\text{ m}^3$); (g) case E;
 548 and fracturing fluid pressure distribution of case B (C) and case E (h).

549 Furthermore, the three-dimensional model's capacity to accurately simulate the
 550 propagation of HF in the height (or width) direction presents a challenge for NF
 551 propagation once it intersects with HF. This presents a notable deviation from the
 552 assumption made in 2D, where fractures are typically assumed to extend infinitely in
 553 the height direction. This phenomena has been discussed in our previous studies[50].

554 4.2. The x-y oblique intersection

555 The "x-y oblique intersection" refers to the crack distribution pattern when the
 556 external normal of HF is parallel to the x-y plane, which cannot be studied in a
 557 two-dimensional model. Table 5 lists the boundary conditions and construction
 558 parameters for each group of cases. The angle between HF and the y-z plane is 25° .
 559 The remaining fundamental parameters of the numerical model in this section are
 560 consistent with those outlined in Section 5.1.

561 **Table 5** Boundary conditions and construction parameters of the x-y oblique
 562 intersection model.

Case	Horizontal stress σ_x	Horizontal stress σ_y	Vertical stress σ_z	Friction coefficient μ_{fr}	Fracturing fluid viscosity μ_f	Length of the NF L
F	15 MPa	10 MPa	10 MPa	0.45	10 mPa·s	0.6 m
G	15 MPa	10 MPa	10 MPa	0.6	10 mPa·s	0.6 m
H	15 MPa	10 MPa	10 MPa	0.45	50 mPa·s	0.6 m

I 15 MPa 10 MPa 10 MPa 0.45 10 mPa·s 0.3 m

563 The simulation results of the fracture distribution and fracturing fluid pressure
 564 distribution when the injection volume of fracturing fluid pump Q_v is approximately
 565 $2e-5m^3$ are shown in Fig. 19. In Case F, HF is entirely captured by NF, incapable of
 566 penetrating or bypassing it (Fig. 19(a)). Conversely, in Case I, due to the halving of
 567 the NF's length compared to that in Case F, the HF bypasses the NF (Fig. 19(g)).
 568 Hence, the length of the NF significantly influences the HF's ability to bypass it. In
 569 Case G, due to the increased friction coefficient of the fracture surface, HF penetrated
 570 NF. In contrast, in Case H, the elevated fracturing fluid viscosity restricted the rate of
 571 pressure increase within NF (Fig. 19(f)), consequently limiting the opening speed of
 572 NF. This restriction facilitated HF penetration through NF, while simultaneously
 573 giving rise to the phenomenon of HF bypassing NF (Fig. 19(e)), thus a mixed
 574 propagation form involving both penetration and circumvention occurs in Case H.
 575 This also results in the boundary of HF in Case H being closer to a smooth arc
 576 compared to that in Case G.

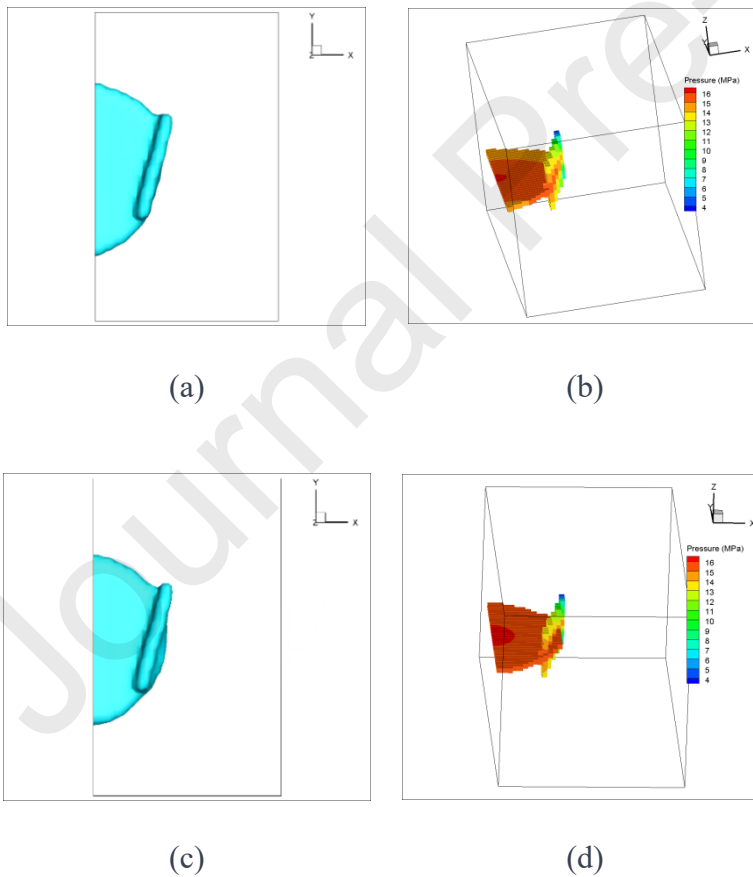

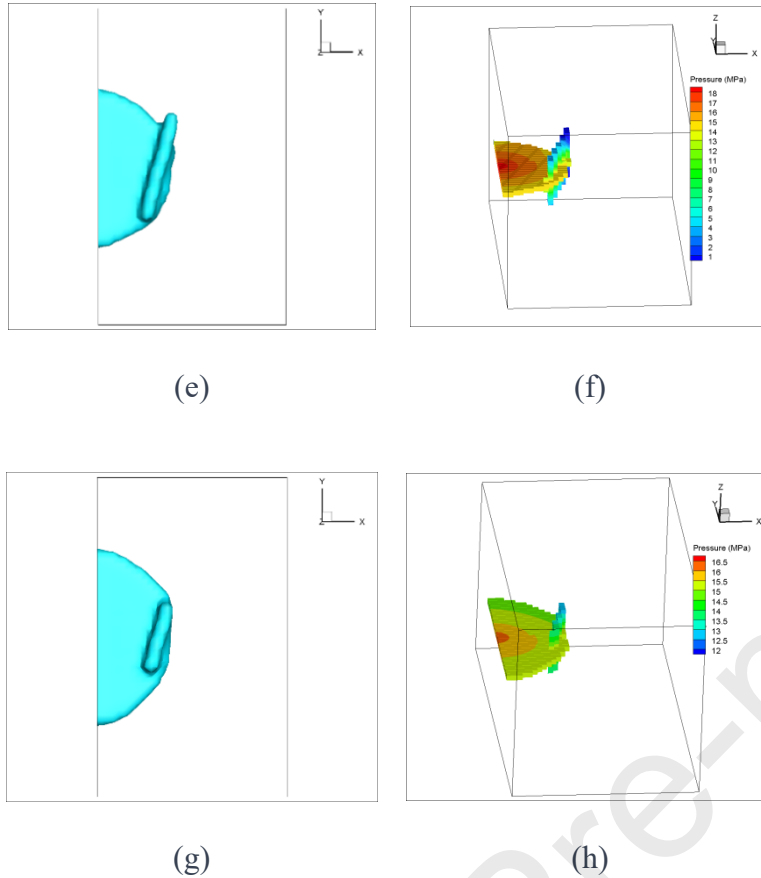

577 **Fig. 19.** Simulation results of the x-y oblique intersection: (a) fracture distribution of
 578 case F; (b) fracturing fluid pressure distribution of case F; (c) fracture distribution of
 579 case G; (d) fracturing fluid pressure distribution of case G; (e) fracture distribution of
 580 case H; (f) fracturing fluid pressure distribution of case H; (g) fracture distribution of
 581 case I; (h) fracturing fluid pressure distribution of case I.

582 4.3. The y-z oblique intersection

583 The "x-y oblique intersection" refers to the crack distribution pattern when the
 584 external normal of HF is parallel to the x-y plane, which cannot be studied using a 2D
 585 model. The used boundary conditions and model parameters are listed in Table 6,
 586 where θ represents the angle between NF and the x-y plane. In this section, the
 587 friction coefficient μ_{fri} is 0.3, the fracturing fluid viscosity μ_f is 10 mPa·s. In cases J,
 588 K, and L, the angle between the hydraulic fractures (HF) and the x-y plane is 90°,
 589 which represents a special fracture distribution pattern known as "orthogonal".

590 When the NF is parallel to the y-z plane, HF does not penetrate NF, and the
 591 propagation pattern of HF is a combination of "capture" and "diversion". Whether NF
 592 can separate the influx of fracturing fluid and expand is the focal point of this section.
 593 Therefore, the friction coefficient and fracturing fluid viscosity are fixed in this set of
 594 cases (these two parameters mainly affect the penetration of the HF), and different
 595 fracture propagation patterns are obtained by adjusting the in-situ stress distribution.

596 **Table 6** Boundary conditions of the y-z oblique intersection model.

Case	Horizontal stress σ_x	Horizontal stress σ_y	Vertical stress σ_z	θ
J	10 MPa	10 MPa	10 MPa	90°
K	10 MPa	5 MPa	10 MPa	90°
L	10 MPa	10 MPa	20 MPa	90°
M	10 MPa	10 MPa	15 MPa	45°
N	10 MPa	5 MPa	10 MPa	45°

597 Fig. 20 shows the simulation results of the distribution of fracture and fluid
598 pressure of cases J to N. During hydraulic fracturing, the HF are only likely to
599 propagate when the fracturing fluid pressure is roughly not lower than the sum of the
600 normal stress on the fracture plane and the tensile strength of the rock. This also
601 explains one of the influencing mechanisms in the propagation of HFs and NFs
602 concerning the distribution of in-situ stress. In case J, the normal stress acting on the
603 HF ($\sigma_z=10$ MPa) is equal to the normal stress acting on the HF ($\sigma_y=10$ MPa).
604 Additionally, due to the viscosity of the fracturing fluid (resulting in higher fracturing
605 fluid pressure near the wellbore compared to the far end), the fracturing fluid pressure
606 within the NF does not meet the conditions (as described above) required to sustain
607 the expansion of the natural fractures (as shown in Fig. 20(c)). Therefore, the NF in
608 case J dose not open or propagate (Figs. 20(a) and (b)). In case K, the normal stress
609 acting on the HF is significantly higher than the normal stress acting on the HF.
610 Therefore, the pressure of the fracturing fluid flowing from HF into NF is sufficient to
611 cause the NF to open and propagate (Fig. 20(d)). In case L, due to the significant
612 increase in vertical in-situ stress ($\sigma_z=20$ MPa) compared to horizontal in-situ stress
613 ($\sigma_x=\sigma_y=20$ MPa), the HF bifurcates and propagates in the vertical direction (Fig.
614 20(e)). This is in line with the theory that the HF propagates parallel to the maximum
615 principal stress direction. Based on the simulation results of the two-dimensional
616 model, we preliminarily believe that when the ratio of the difference between vertical
617 in-situ stress and rock tensile strength to horizontal in-situ stress is higher than a
618 certain critical value, HF will bifurcate and deflect towards the vertical direction. The
619 mechanism by which the originally horizontally distributed HF bifurcates and deflects
620 to the vertical direction is still worth further discussion in the future. In cases M and
621 N, the normal stress acting on the HF (σ_z) is significantly greater than that acting on
622 the NF ($\sigma_y*\cos\theta+\sigma_z*\sin\theta$), resulting in the NF opening and propagating. In case M,

623 where $\sigma_y = \sigma_z$, the NF does not deflect but rather propagate within their respective
 624 plane. On the other hand, in case N, where σ_z is greater than σ_y , the net force
 625 experiences deflection and propagate within the x-z plane. Due to the significantly
 626 smaller difference between the normal stresses acting on the HF surface and NF
 627 surface in Case M ($\sigma_z - (\sigma_y \cdot \cos\theta + \sigma_z \cdot \sin\theta)$) compared to the difference in Case N
 628 ($\sigma_z - \sigma_y$), the propagation rate of the HF in Case M is noticeably greater than that in
 629 Case N. Conversely, the propagation rate of the NF in Case M is significantly slower
 630 than that in Case N.

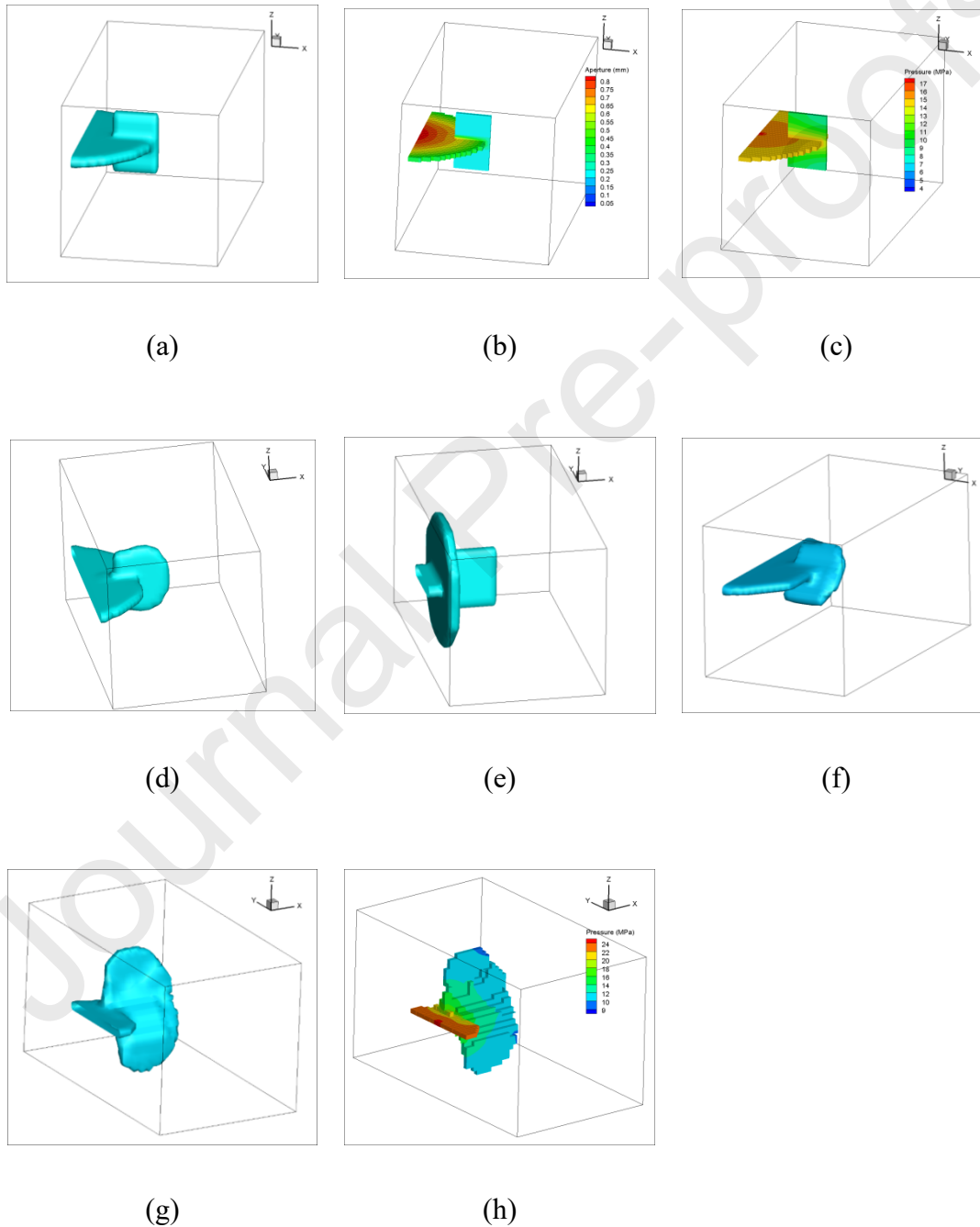

631 **Fig. 20.** Simulation results of the x-y oblique intersection: (a) fracture distribution of

632 case J; (b) fracture aperture distribution of case J; (c) fracture fluid pressure
 633 distribution of case J; (d) fracture distribution of case K; (e) fracture distribution of
 634 case L; (f) fracture distribution of case M; (g) fracture distribution of case N; (h)
 635 fracture fluid pressure distribution of case N.

636 5. Numerical simulation of hydraulic fracturing in a jointed rock mass

637 Based on the careful investigation of the interaction mechanisms between HF and a
 638 single NF, as well as the morphology of fracture propagation mentioned earlier, this
 639 section conducts simulations of hydraulic fracturing in reservoirs containing fractures
 640 with arbitrary distributions. Despite a significant amount of numerical research
 641 published on hydraulic fracturing in fractured rock formations, much of it has been
 642 based on two-dimensional models or pseudo-three-dimensional (P3D) models. As
 643 revealed in this work, the interaction between HFs and NFs are challenging to analyze
 644 using two-dimensional models. Therefore, it is a needed to develop more
 645 sophisticated true-three-dimensional models to simulate the hydraulic fracturing of
 646 jointed rocks.

647 A three-dimensional jointed rock model, as shown in Fig. 21, has been
 648 constructed with dimensions of 1.8m*1.8m*1.05m. The elastic modulus of the rock E
 649 is 15 GPa, and the critical energy release rate for the rock G_c is 100 J/m². The
 650 characteristic length of material points Δx is 0.03 m, and the time step Δt used in the
 651 calculations is 2.5e-5 s. The injection rate of the fracturing fluid is 2e-4 m³/s. The
 652 boundary conditions and model parameters are listed in Table 7, where θ represents
 653 the angle between the NF and the x-y plane.

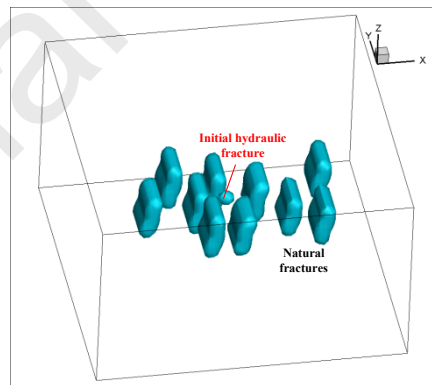

654

655 **Fig. 21.** 3D fractured rock mass model diagram

656 **Table 7** Boundary conditions and construction parameters of the jointed rock model.

Case	Horizontal stress σ_x	Horizontal stress σ_y	Vertical stress σ_z	Friction coefficient μ_{fri}	Fluid viscosity μ_{fi}	θ

A	10 MPa	10 MPa	10 MPa	0.45	15 mPa·s	60°
B	20 MPa	10 MPa	10 MPa	0.45	15 mPa·s	60°
C	20 MPa	10 MPa	10 MPa	0.8	15 mPa·s	60°
D	20 MPa	10 MPa	10 MPa	0.8	50 mPa·s	60°
E	10 MPa	10 MPa	10 MPa	0.45	15 mPa·s	75°
F	20 MPa	10 MPa	10 MPa	0.8	15 mPa·s	75°

657 Fig. 22 shows the simulation results of hydraulic fracturing in jointed rock when
658 the injection volume Q_v is about $1e-4$ m³. In Cases A and E, the vertical and
659 horizontal stresses are equal. Therefore, after being captured by the nearest NF, the
660 HF primarily propagates within the plane where the NF is located, rather than
661 continuing to propagate within the horizontal plane. Therefore, when the difference in
662 in-situ stresses is small, NFs will significantly deflect the propagation direction of HF
663 and restrict the propagation of HF in the length direction. When the difference
664 between vertical stress and horizontal stress reaches 10 MPa (case B), the HF will
665 penetrate or bypass the NF and mainly propagate in the x-y plane (as shown in Figs.
666 22(c) and (d)). As the fracturing fluid viscosity further increases ($\mu_f=50$ mPa·s), the
667 surface of the HF becomes smoother, indicating that the HF tends to propagate more
668 within the x-y plane. On the basis of the construction parameters and boundary
669 conditions in Case B, increasing the dip angle of NFs to 75°, it is obvious that the HF
670 has a faster propagation rate in the x-y plane, which also verifies an obvious rule that
671 a larger approaching angle is more conducive to HF penetrating NF.

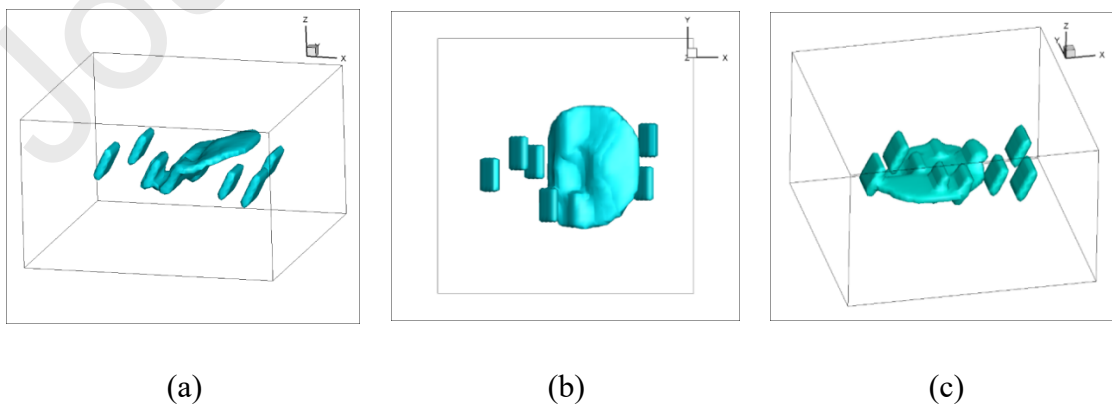

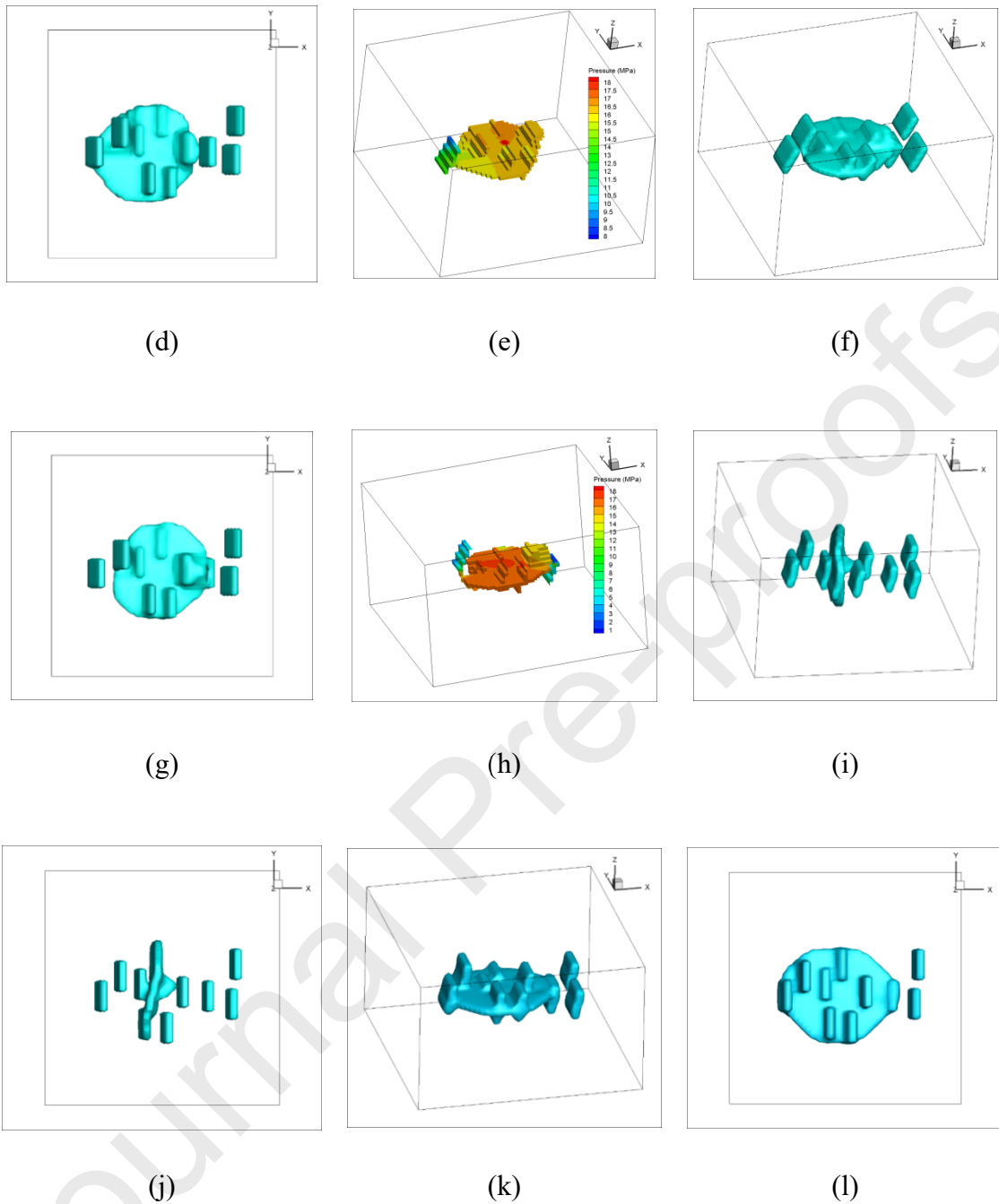

672 **Fig. 22.** Simulation results of hydraulic fracturing in a jointed rock mass: (a) fracture
 673 distribution of case A ($Q_v=0.5e-4$ m³); (b) the projection of fractures in the x-y plane
 674 of Case A ($Q_v=0.5e-4$ m³); (c) fracture distribution of case B; (d) the projection of
 675 fractures in the x-y plane of Case B; (e) fluid pressure distribution of case C; (f)
 676 fracture distribution of case C; (g) fracture distribution of case D; (h) the projection of
 677 fractures in the x-y plane of Case D; (i) fracture distribution of case E ($Q_v=0.5e-4$
 678 m³); (j) the projection of fractures in the x-y plane in Case E ($Q_v=0.5e-4$ m³); (k)
 679 fracture distribution of case F; (l) the projection of fractures in the x-y plane in Case
 680 F.

681 6. Conclusions and discussions

682 In this article, a self-developed 2D/3D hydraulic fracturing model for fractured rock
683 masses is constructed and used to study the mechanism of fracture interaction and the
684 morphology of fracture propagation in hydraulic fracturing of jointed rock masses.
685 The main research conclusions of this article are as follows:

686 (1) Based on the two-dimensional numerical model, we clearly illustrated the
687 influence of the in-situ stress ratio, fracture surface friction coefficient, fracturing
688 fluid viscosity, injection rate and fracture dip angle (approach angle) on the
689 interaction between HF and NFs. The results show that the greater the in-situ stress
690 ratio, the greater the friction coefficient on the NF surface is, and the more likely the
691 HF penetrates the NF. **The simulation results closely align with predictions based on**
692 **the RP criterion[64] and are also consistent with the conclusions obtained by Zhou et**
693 **al.[68] through numerical simulations.** With the increase in fracturing fluid viscosity,
694 the rate of fracturing fluid entering a NF decreases, and the rate of pressure rise in the
695 NF also decreases. At this time, the action time of tensile stress on the NF surface is
696 prolonged, which is more conducive for the HF to penetrate the NF. **The numerical**
697 **research results on the effect of fracturing fluid viscosity on the interaction between**
698 **HF and NF are consistent with the experimental ones of Llanos et al[6].** A higher
699 injection rate is beneficial to increase the peak tensile stress on the surface of the NF,
700 which is also conducive for the HF to penetrate the NF. As the dip angle of the NF
701 increases, the HF undergoes a sequence of propagation modes, including complete
702 captured, bifurcation and penetration, deviation and penetration, and complete
703 penetration (possibly with bifurcation). Compared to the scenario where the HF
704 directly penetrates the NF, the interaction between the HF and the NF significantly
705 restricts the propagation velocity of the HF and increases the aperture of the HF,
706 **which is consistent with the conclusion obtained by Zhang et al.[35] through**
707 **numerical simulation.**

708 (2) The subsequent study focused on the interaction morphology between the HF and
709 the NF in three-dimensional rocks. The simulation results indicate that “diversion” is
710 an important interaction mode between the HF and the NF in three-dimensional rocks.
711 Larger dip angle of the NF and higher fracturing fluid viscosity are beneficial for the
712 HF to bypass the NF, and this interaction mode cannot be simulated using
713 two-dimensional models. The simulation results of the 3D model also indicate that
714 there exists a mixed interaction mode of penetration and diversion when the length of
715 the NF is limited and the angle between the NF and the HF is less than 90° . The
716 fracturing fluid will preferentially flow into the fracture with the lowest sum of
717 normal stress and rock tensile strength. Only when the normal stress acting on the
718 surface of the HF is significantly greater than the normal stress on the surface of the
719 NF can the NF propagate.

720 (3) Simulation results of hydraulic fracturing in three-dimensional fractured rock
721 masses indicate that larger horizontal stress differentials, higher fracturing fluid

722 viscosity, and greater dip angle of NFs are favorable for the horizontal propagation of
723 the HF within the horizontal plane, reducing HF roughness. When the horizontal
724 stress differential is relatively small, the HF may be captured by NFs, altering the
725 propagation direction and causing propagation in the vertical direction. **The**
726 **simulation results are similar to the conclusions drawn by Beugelsdijk et al.[71], as**
727 **well as Fan and Zhang[72] from the experiment.**

728 Acknowledgements

729 The authors gratefully acknowledge the support of the National Natural Science
730 Foundation of China (Grant Nos. U22A20595, 12202463, 52108366).

731 References

732 [1] Warpinski NR, Teufel LW. Influence of geologic discontinuities on hydraulic
733 fracture propagation. *Journal of Petroleum Technology*. 1987,39:209-220.

734 [2] Blanton TL. An experimental study of Interaction between hydraulically induced
735 and pre-Existing fractures. SPE. 1982.

736 [3] Blanton TL. Propagation of hydraulically and dynamically induced fractures in
737 naturally fractured reservoirs. SPE Unconventional Resources Conference/Gas
738 Technology Symposium: SPE, 1986.

739 [4] Bunger AP, Kear J, Jeffrey RG, et al. Investigation of hydraulic fracture growth
740 through weak discontinuities with active ultrasound monitoring. ISRM Congress:
741 ISRM, 2015.

742 [5] Beugelsdijk LJJ, Pater C, Sato K. Experimental hydraulic fracture propagation in
743 a multi-fractured medium. SPE Asia Pacific Conference on Integrated Modelling for
744 Asset Management: SPE, 2000.

745 [6] Llanos EM, Jeffrey RG, Hillis R, et al. Hydraulic fracture propagation through an
746 orthogonal discontinuity: a laboratory, analytical and numerical study. *Rock*
747 *Mechanics and Rock Engineering*. 2017,50:2101–2118.

748 [7] Guo TK, Zhang SC, Qu ZQ, et al. Experimental study of hydraulic fracturing for
749 shale by stimulated reservoir volume. *Fuel*. 2014,128:373-380.

750 [8] Hanson ME, Anderson GD, Shaffer RJ, et al. Some Effects of Stress, Friction, and
751 Fluid Flow on Hydraulic Fracturing. *Society of Petroleum Engineers Journal*.
752 1982,22:321-332.

753 [9] Hanson ME, Shaffer RJ, Anderson GD. Effects of various parameters on hydraulic
754 fracturing geometry. *Society of Petroleum Engineers Journal*. 1981,21:435-443.

755 [10] Pippin R, Flechsig K, Riemelmoser FO. Fatigue crack propagation behavior in

- 756 the vicinity of an interface between materials with different yield stresses. *Materials*
757 *Science & Engineering A*. 2000,283:225-233.
- 758 [11] Wang SL, Xing CL, Zhang DS, et al. The Fracture Behavior in the Vicinity of
759 Interface Based on the Digital Speckle Experiment. *Spe Asia Pacific Oil & Gas*
760 *Conference & Exhibition*2016.
- 761 [12] Warpinski NR, Teufel LW. Influence of Geologic Discontinuities on Hydraulic
762 Fracture Propagation (includes associated papers 17011 and 17074). *Journal of*
763 *Petroleum Technology*. 1987,39:209-220.
- 764 [13] Renshaw CE, Pollard DD. AN EXPERIMENTALLY VERIFIED CRITERION
765 FOR PROPAGATION ACROSS UNBOUNDED FRICTIONAL INTERFACES IN
766 BRITTLE, LINEAR ELASTIC-MATERIALS. *International Journal of Rock*
767 *Mechanics & Mining Science & Geomechanics Abstracts*. 2009,32:237-249.
- 768 [14] Gu H, Weng X. Criterion for fractures crossing frictional interfaces at
769 non-orthogonal angles. *Us Rock Mechanics Symposium & Us-canada Rock*
770 *Mechanics Symposium*2010.
- 771 [15] Sarmadivaleh M, Rasouli V. Modified Reinshaw and Pollard Criteria for a
772 Non-Orthogonal Cohesive Natural Interface Intersected by an Induced Fracture. *Rock*
773 *Mechanics&Rock Engineering*. 2014,47:2107-2115.
- 774 [16] Anderson GD. Effects of mechanical and frictional rock properties on hydraulic
775 fracture growth near unbonded interfaces. 1979.
- 776 [17] Hanson ME, Shaffer RJ, Anderson GD. Effects of various parameters on
777 hydraulic fracturing geometry: Hanson, M E; Shaffer, R J; Anderson, G D *Soc Petr*
778 *Engr J*, V21, N4, Aug 1981, P435–443. *international journal of rock mechanics &*
779 *mining sciences & geomechanics abstracts*. 1982.
- 780 [18] Leguillon D. Strength or toughness? A criterion for crack onset at a notch.
781 *European Journal of Mechanics - A/Solids*. 2002,21:61-72.
- 782 [19] Yew CH, Lodde P. Propagation of a hydraulically induced fracture in layered
783 medium. *SPE 11870*. 1983.
- 784 [20] Cleary MP. Comprehensive design formulae for hydraulic fracturing. *SPE*
785 *Annual Technical Conference and Exhibition: Society of Petroleum Engineers*, 1980.
- 786 [21] Shi F, Wang X, Liu C, et al. An XFEM-based method with reduction technique
787 for modeling hydraulic fracture propagation in formations containing frictional
788 natural fractures. *Engineering Fracture Mechanics*. 2017,173:64-90.
- 789 [22] Khoei AR, Vahab M, Hirmand M. An enriched–FEM technique for numerical
790 simulation of interacting discontinuities in naturally fractured porous media.

- 791 Computer Methods in Applied Mechanics & Engineering. 2017,331:197-231.
- 792 [23] Wang XL, Shi F, Liu C, et al. Extended finite element simulation of fracture
793 network propagation in formation containing frictional and cemented natural
794 fractures. Journal of Natural Gas Science and Engineering.
795 2017:S1875510017304833.
- 796 [24] Khoei AR, Hirmand M, Vahab M, et al. An enriched FEM technique for
797 modeling hydraulically driven cohesive fracture propagation in impermeable media
798 with frictional natural faults: Numerical and experimental investigations. International
799 Journal for Numerical Methods in Engineering. 2015,104:439-468.
- 800 [25] Cruz F, Roehl D, Vargas E. An XFEM element to model intersections between
801 hydraulic and natural fractures in porous rocks. International Journal of Rock
802 Mechanics and Mining Sciences. 2018,112:385-397.
- 803 [26] Khoei AR, Vahab M, Hirmand M. Modeling the interaction between fluid-driven
804 fracture and natural fault using an enriched-FEM technique. International Journal of
805 Fracture. 2015b:1-24.
- 806 [27] Yew CH, Chiou YJ. Effects of in-situ stresses and layer properties on the
807 containment of a hydraulic fracture. SPE 12332. 1983.
- 808 [28] Cooke ML, Underwood CA. Fracture termination and step-over at bedding
809 interfaces due to frictional slip and interface opening. Journal of Structural Geology.
810 2001,23:223-238.
- 811 [29] Zhang X, Jeffrey RG, Thiercelin M. Deflection and propagation of fluid-driven
812 fractures at frictional bedding interfaces: A numerical investigation. Journal of
813 Structural Geology. 2007,29:396-410.
- 814 [30] Zhang X, Jeffrey RG. Reinitiation or termination of fluid-driven fractures at
815 frictional bedding interfaces. Journal of Geophysical Research: Solid Earth.
816 2008,113:-.
- 817 [31] Dong CY, Pater CJD. Numerical implementation of displacement discontinuity
818 method and its application in hydraulic fracturing. Computer Methods in Applied
819 Mechanics & Engineering. 2001,191:745-760.
- 820 [32] Akulich AV, Zvyagin AV. Interaction between hydraulic and natural fractures.
821 Fluid Dynamics. 2008,43:428-435.
- 822 [33] Abdollahipour A, Marji MF. A thermo-hydromechanical displacement
823 discontinuity method to model fractures in high-pressure, high-temperature
824 environments. Renewable Energy. 2020,153:1488-1503.
- 825 [34] Abdollahipour A, Fatehi Marji M, Yarahmadi Bafghi AR, et al. Numerical

- 826 investigation of effect of crack geometrical parameters on hydraulic fracturing process
827 of hydrocarbon reservoirs. *Journal of Mining and Environment*. 2016,7:205-214.
- 828 [35] Zhang X, Jeffrey RG, Thiercelin M. Mechanics of fluid-driven fracture growth in
829 naturally fractured reservoirs with simple network geometries. *Journal of Geophysical*
830 *Research: Solid Earth*. 2009,114(B12).
- 831 [36] Behnia M, Goshtasbi K, Marji MF, et al. Numerical simulation of interaction
832 between hydraulic and natural fractures in discontinuous media. *Acta Geotechnica*.
833 2015,10:533-546.
- 834 [37] Moradi M, Tokhmechi B, Rasouli V, et al. A Comprehensive Numerical Study of
835 Hydraulic Fracturing Process and Its Affecting Parameters. *Geotechnical and*
836 *Geological Engineering*. 2017,35:1035-1050.
- 837 [38] Zhang Z, Li X, Yuan W, et al. Numerical analysis on the optimization of
838 hydraulic fracture networks. *Energies*. 2015,8:12061-12079.
- 839 [39] García X, Nagel N, Zhang F, et al. Revisiting Vertical Hydraulic Fracture
840 Propagation Through Layered Formations – A Numerical Evaluation. 47th US Rock
841 Mechanics/Geomechanics Symposium2013.
- 842 [40] Fatahi H, Hossain MM, Sarmadivaleh M. Numerical and experimental
843 investigation of the interaction of natural and propagated hydraulic fracture. *Journal*
844 *of Natural Gas Science and Engineering*. 2017,37:409-424.
- 845 [41] Wasantha P, Konietzky H, Weber F. Geometric nature of hydraulic fracture
846 propagation in naturally-fractured reservoirs. *Computers and Geotechnics*.
847 2017,83:209-220.
- 848 [42] Zhang F, Dontsov E, Mack M. Fully coupled simulation of a hydraulic fracture
849 interacting with natural fractures with a hybrid discrete-continuum method.
850 *International Journal for Numerical and Analytical Methods in Geomechanics*.
851 2017,41:1430-1452.
- 852 [43] Bakhshi E, Rasouli V, Ghorbani A, et al. Hydraulic Fracture Propagation:
853 Analytical Solutions versus Lattice Simulations. *Journal of Mining and Environment*.
854 2019,10:451-464.
- 855 [44] Zhang Z, Ghassemi A. Simulation of hydraulic fracture propagation near a
856 natural fracture using virtual multidimensional internal bonds. *International Journal*
857 *for Numerical and Analytical Methods in Geomechanics*. 2015,35:480-495.
- 858 [45] Zhao HJ, Ma FS, Liu G, et al. Influence of different scales of structural planes on
859 propagation mechanism of hydraulic fracturing. *Journal of Engineering Geology*.
860 2016,024:992-1007.

- 861 [46] Song CP, Lu YY, Jia YZ, et al. Effect of Coal-Rock Interface on Hydralnic
862 Fracturing Propagation. *Journal of Northeastern UniVersity (Natural Science)*.
863 2014,35:1340-1345.
- 864 [47] Madenci E, Oterkus E. *Peridynamic Theory and Its Applications*. New York:
865 Springer, 2014.
- 866 [48] Silling SA. Reformulation of elasticity theory for discontinuities and long-range
867 forces. *Journal of Mechanics Physics of Solids*. 2000,48:175-209.
- 868 [49] Silling SA, Lehoucq RB. *Peridynamic Theory of Solid Mechanics*. *Advances in*
869 *Applied Mechanics*. 2010,44:73-168.
- 870 [50] Qin M, Yang D, Chen W. Three-dimensional hydraulic fracturing modeling
871 based on peridynamics. *Engineering Analysis with Boundary Elements*.
872 2022,141:153-166.
- 873 [51] Qin M, Yang D, Chen W, et al. Hydraulic fracturing network modeling based on
874 peridynamics. *Engineering Fracture Mechanics*. 2021,247.
- 875 [52] Qin M, Yang D. Numerical investigation of hydraulic fracture height growth in
876 layered rock based on peridynamics. *Theoretical and Applied Fracture Mechanics*.
877 2023,123.
- 878 [53] Qin M, Yang D, Chen W. Numerical investigation of the effects of fracturing
879 fluid parameters on hydraulic fracture propagation in jointed rock mass based on
880 peridynamics. *Engineering Analysis with Boundary Elements*. 2022,135:38-51.
- 881 [54] Madenci E, Oterkus E. *Peridynamic theory and its applications*. New York:
882 Springer Scienc, 2014.
- 883 [55] Qin MQ, Yang DS, Chen WZ, et al. Hydraulic fracturing model of a layered rock
884 mass based on peridynamics. *Engineering Fracture Mechanics*. 2021,258.
- 885 [56] Qin MQ, Yang DS, Chen WZ. Three-dimensional hydraulic fracturing modeling
886 based on peridynamics. *Engineering Analysis with Boundary Elements*.
887 2022,141:153-166.
- 888 [57] Qin M, Yang D. Numerical investigation of hydraulic fracture height growth in
889 layered rock based on peridynamics. *Theoretical and Applied Fracture Mechanics*.
890 2023,125:103885.
- 891 [58] Qin M, Yang D. Numerical investigation of hydraulic fracturing in a
892 heterogeneous rock mass based on peridynamics. *Rock Mechanics and Rock*
893 *engineering*. 2023,56:4485-4505.
- 894 [59] Bobaru F, Foster JT, Geubelle PH, et al. *Handbook of peridynamic modeling*.

- 895 Boca Raton: Crc Press, 2016.
- 896 [60] Kilic B, Madenci E. An adaptive dynamic relaxation method for quasi-static
897 simulations using the peridynamic theory. *Theoretical and Applied Fracture*
898 *Mechanics*. 2010,53:194-204.
- 899 [61] Qin M, Yang D, Yang S. Hydraulic fracturing model of a layered rock mass
900 based on peridynamic. *Engineering Fracture Mechanics*. 2021,258.
- 901 [62] Qin MQ, Yang DS, Chen WZ, et al. Hydraulic fracturing network modeling
902 based on peridynamics. *Engineering Fracture Mechanics*. 2021,247.
- 903 [63] Gerstle W, Sau N, Aguilera E. Micropolar peridynamic constitutive model for
904 concrete. *Transactions, SMiRT 19*. Toronto2007.
- 905 [64] Renshaw CE, Pollard DD. An experimentally verified criterion for propagation
906 across unbounded frictional interfaces in brittle, linear elastic materials. *International*
907 *Journal of Rock Mechanics & Mining ence & Geomechanics Abstracts*.
908 1995,32:237-249.
- 909 [65] Hu J, Garagash DI. Plane-strain propagation of a fluid-driven crack in a
910 permeable rock with fracture toughness. *Journal of Engineering Mechanics*.
911 2010,136:1152-1166.
- 912 [66] Sundaram BM, Tippur HV. Dynamic crack propagation in layered transparent
913 materials studied using digital gradient sensing method. *Proceedings of the 2014*
914 *Annual Conference on Experimental and Applied Mechanics: Springer International*
915 *Publishing*, 2015. p. 197-205.
- 916 [67] Smith MB, Montgomery CT. *Hydraulic fracturing*. New York: CRC Press, 2015.
- 917 [68] Zhou Y, Yang D, Zhang X, et al. Numerical investigation of the interaction
918 between hydraulic fractures and natural fractures in porous media based on an
919 enriched FEM. *Engineering Fracture Mechanics*. 2020,235.
- 920 [69] Zhang F, Damjanac B, Maxwell S. Investigating hydraulic fracturing complexity
921 in naturally fractured rock masses using fully coupled multiscale numerical modeling.
922 *Rock Mechanics and Rock Engineering*. 2019,52:5137–5160.
- 923 [70] Khoei AR, Vahab M, Hirmand M. Modeling the interaction between fluid-driven
924 fracture and natural fault using an enriched-FEM technique. *International Journal of*
925 *Fracture*. 2015,197:1-24.
- 926 [71] Beugelsdijk LJJ, De Pater CJ, Sato K. Experimental hydraulic fracture
927 propagation in a multi-fractured medium. *SPE Asia Pacific conference on integrated*
928 *modelling for asset managemen: SPE*, 2000.

929 [72] Fan T, Zhang G. Influence of injection rate and fracturing fluid viscosity on
930 hydraulic fracture geometry in coal. Journal of China University of Petroleum.
931 2014,38:117-123.

932

933 **Highlights**

934

935 (1) A self-developed peridynamics-based 2D/3D hydraulic fracturing model to
936 simulate fracture propagation in fractured rock.

937 (2) The hydro-mechanical coupling mechanism of the interaction between hydraulic
938 fracture and natural fracture is revealed.

939 (3) The interaction modes between fractures in a 3D rock mass are explored,
940 including scenarios where the hydraulic fracture bypasses the natural fracture.

941 (4) The propagation of intricate fracture networks in a 3D fractured rock mass is
942 simulated.

943