



22nd ISCB & 20th ISLS

Fluorescent microbial biosensor for environmental monitoring

Jouanneau Sullivan, Delaunay Eva, Durand-Thouand Marie-José, Thouand Gérald



Context : The environmental characterization



Freshwater



Seawater



Industrial waters
(wastewaters)

Issues

Evaluating the ecological state of these environments to determine the level of degradation induced by anthropogenic activity.

Context : The environmental characterization



Freshwater



Seawater



Industrial waters
(wastewaters)

| Chemical parameters | Physical parameters | Biological parameters |
|--------------------------------------------------------------------------|---------------------|-----------------------|
| Dissolved oxygen | Turbidity | Biodegradation |
| Organic matter | Temperature | Ecotoxicity |
| Specific ions (NO_3^- , Cl^- , NH_4^+ , ...) | pH | ... |
| Emerging pollutants (PFAS, antibiotics, ...) | ... | |

Context : The environmental characterization

Journal of Hazardous Materials 469 (2024) 133933

Chemosphere 308 (2022) 136463

Ecotoxicology and Environmental Safety 207 (2021) 111554

Contents lists available at ScienceDirect

Ecotoxicology and Environmental Safety

journal homepage: www.elsevier.com/locate/ecoenv

Research paper

Toxicity assessment of total petroleum hydrocarbons in aquatic environments using the bioluminescent bacterium *Aliivibrio fischeri*

Marzieh Mirjani^a, Mohsen Soleimani^{a,*}, Vahid Salari^{b,c}

^a Department of Natural Resources, Isfahan University of Technology, Isfahan, 84156-83111, Iran
^b Department of Physics, Isfahan University of Technology, Isfahan, 84156-83111, Iran
^c Department of Physical Chemistry, University of the Basque Country UPV/EHU, Apdo. 644, 48080, Bilbao, Spain



How to transpose these results to the environment ?



Industrial waters (wastewaters)

Overall approaches aimed at determining the toxicological impact of a mixture of pollutants on the ecosystem, and specifically on the biological component.

The probably most well-known method: ISO 11348 (based on the inhibition of bioluminescent strain *Aliivibrio fischeri*).

| | | |
|---------------------|-----|--|
| Emerging pollutants | ... | |
|---------------------|-----|--|

Context : The environmental characterization

Issue: Increasing the representativeness of metrological approaches.

Concept of Bioelectronic Tongue :

IUPAC definition : “The electronic tongue is a multisensor system, which consists of a number of low-selective sensors and uses advanced mathematical procedures for signal processing based on the pattern recognition and/or multivariate analysis (artificial neural networks (ANNs), principal component analysis (PCA), etc.).”

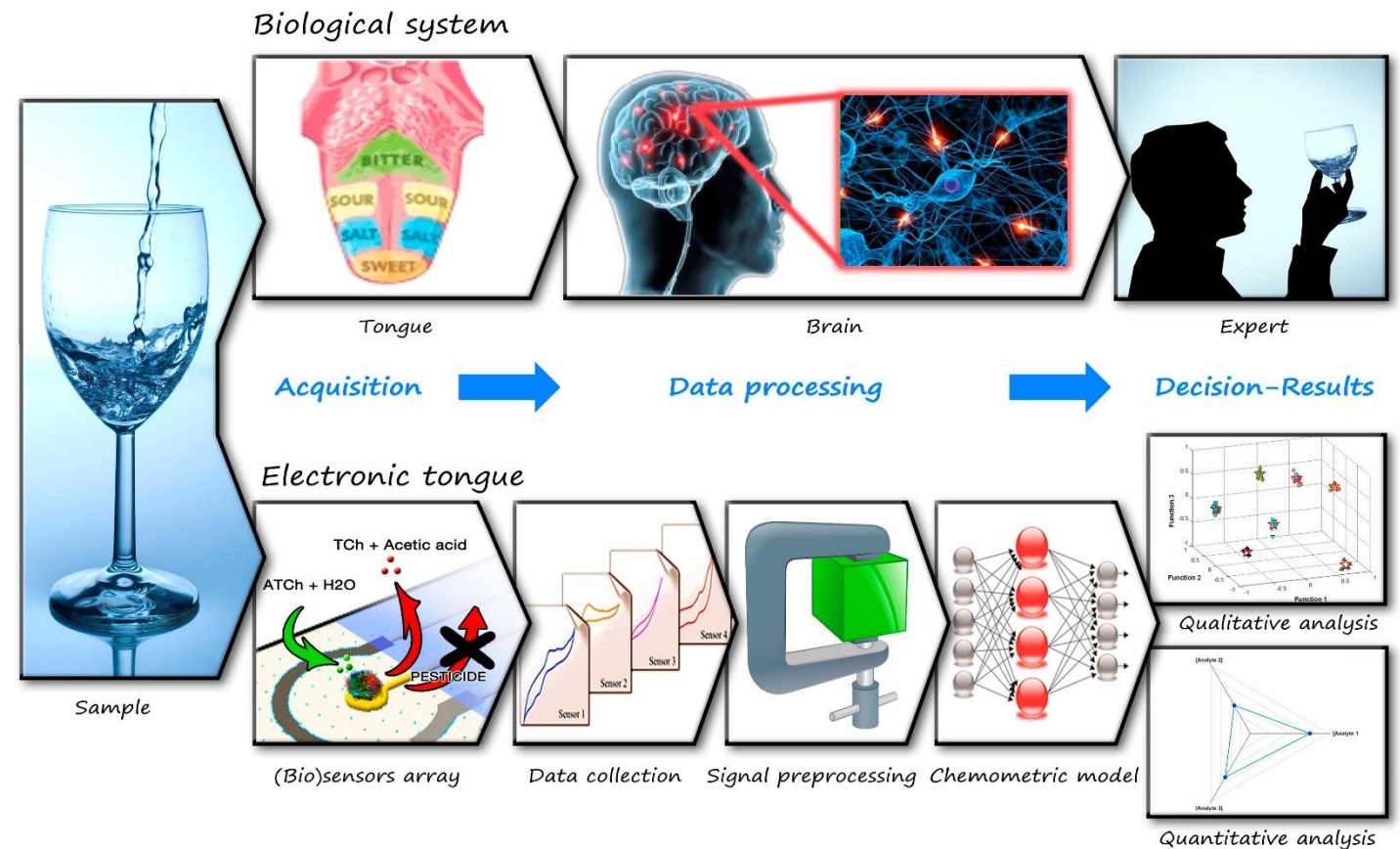

Context : The environmental characterization

Issue: Increasing the representativeness of metrological approaches.

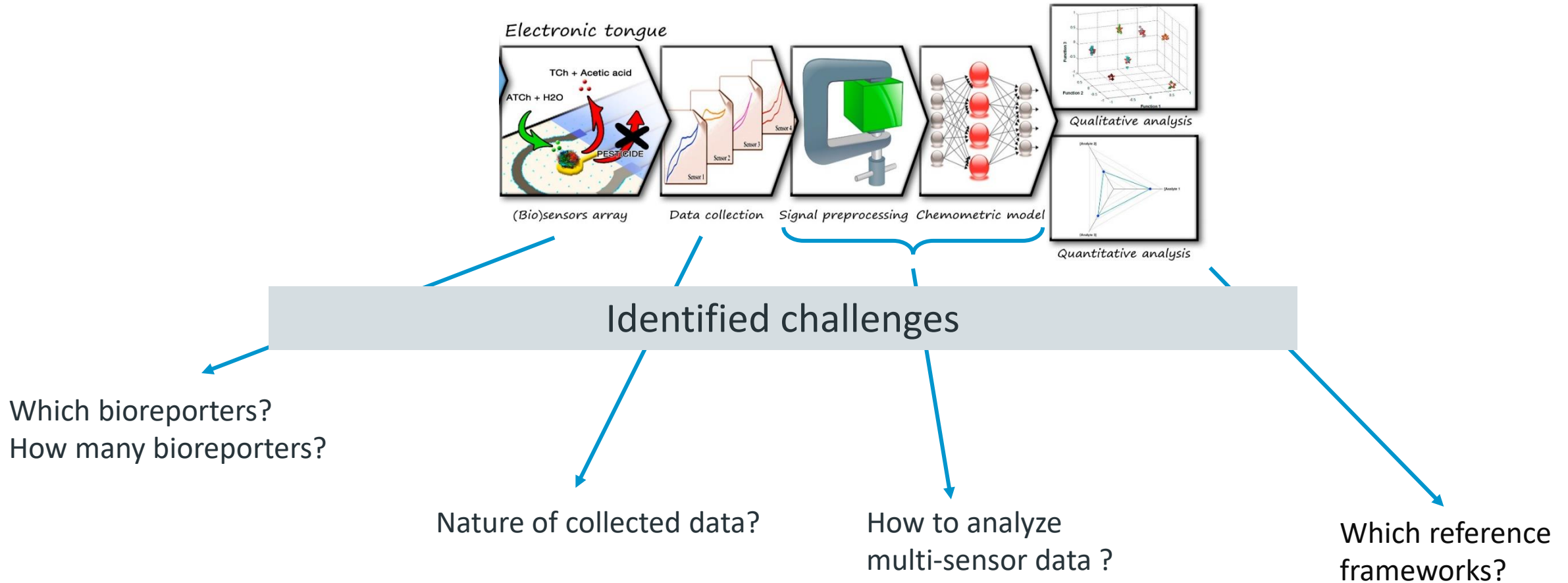

TOXLAB

Domestic WWTP

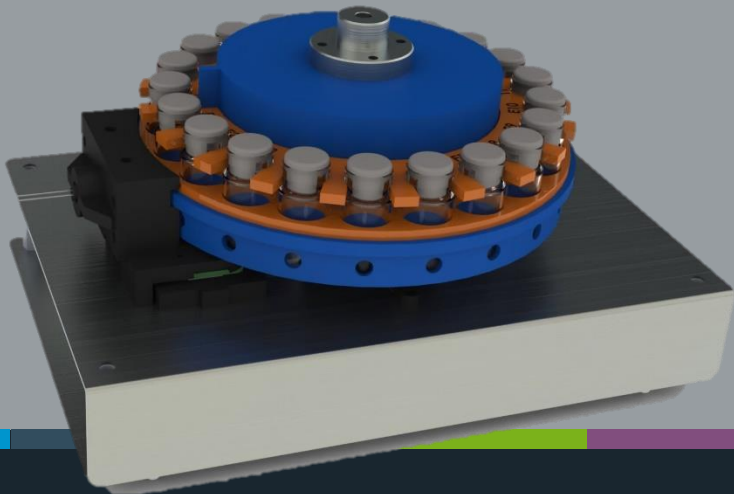

MOBILTOX

Seawater



TOXLAB : Context

Domestic
wastewater

Toxicity monitoring
on bioprocess



Domestic WWTP



Objective : To propose a strategy for assessing the toxicity of raw water in order to anticipate its potential effects on biological part of this process.

Electronic tongue

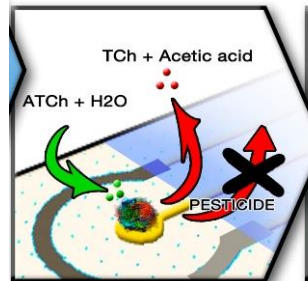

(Bio)sensors array

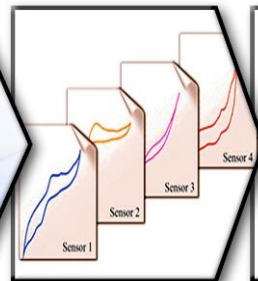

Data collection

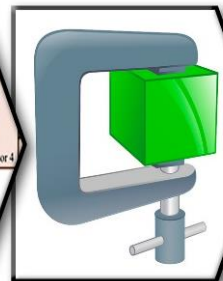

Signal preprocessing

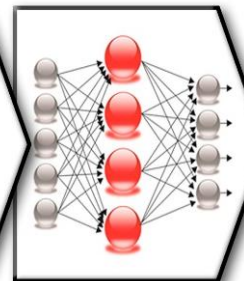

Chemometric model

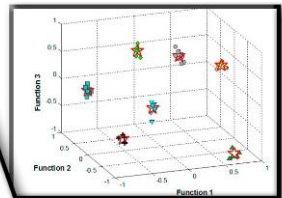

Qualitative analysis

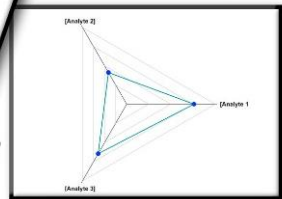

Quantitative analysis

TOXLAB : Strategy

1 Bioreporters arrays

STEP 1 :
Characterization of
the WWTP
ecosystem

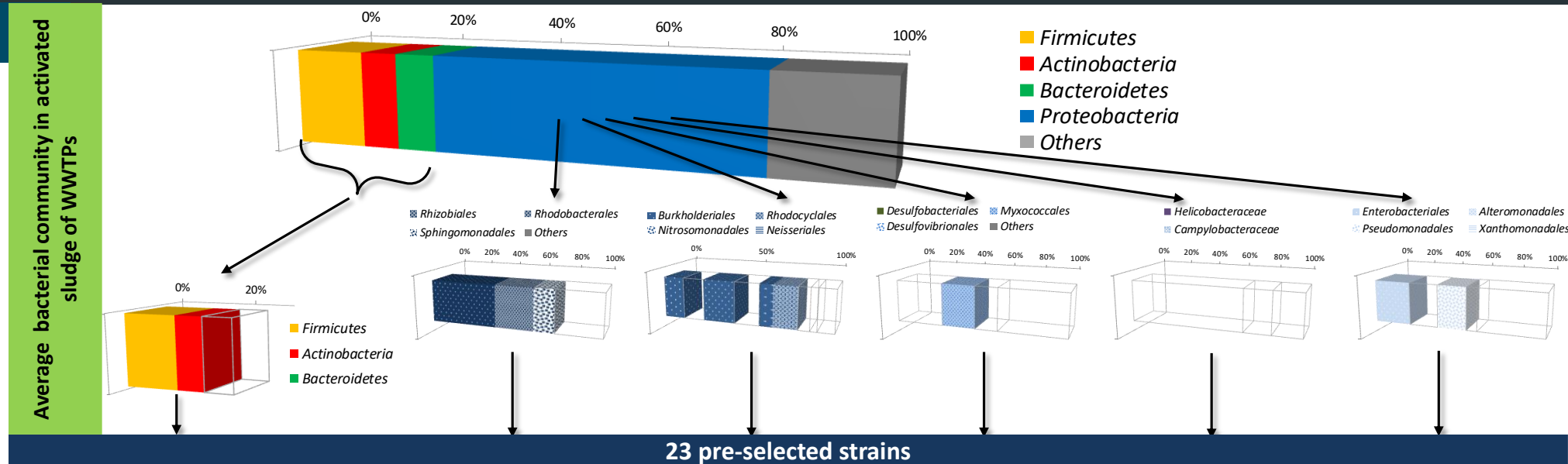

23 bioreporters were pre-selected

- Representative of this ecosystem
- Ensuring a relative diversity compared to the WWTP community
- In accordance with the metrological objective (aerobic, Non pathogenic, resistant to freeze-drying)

TOXLAB : Strategy

1 Bioreporters arrays

STEP 2 : Selection of the bioreporters

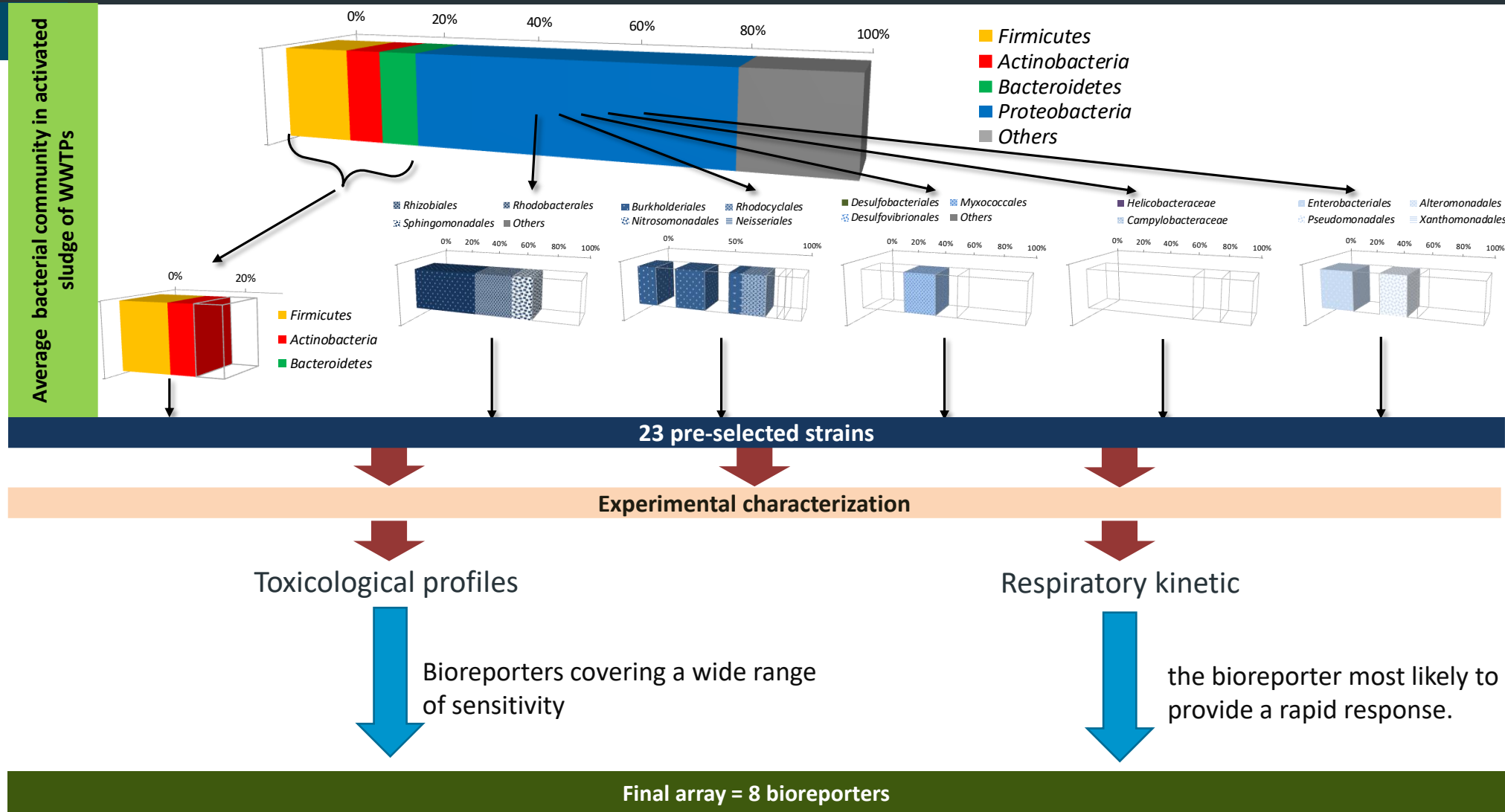

TOXLAB : Strategy

2 Data collection

Principle : Approach based on the monitoring of respiratory activity of aerobic strains using a fluorescent marker, resazurin.

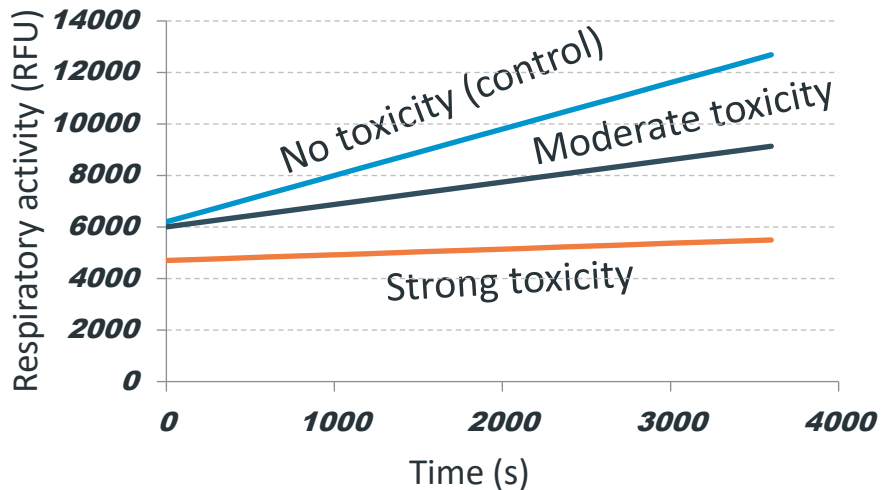
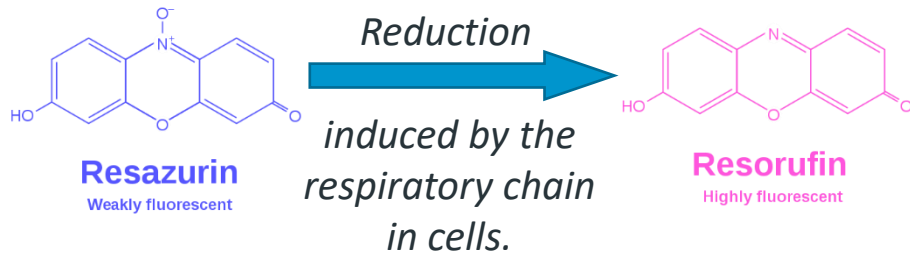

TOXLAB : Strategy

2 Data collection

Principle : Approach based on the monitoring of respiratory activity of aerobic strains using a fluorescent marker, resazurin.

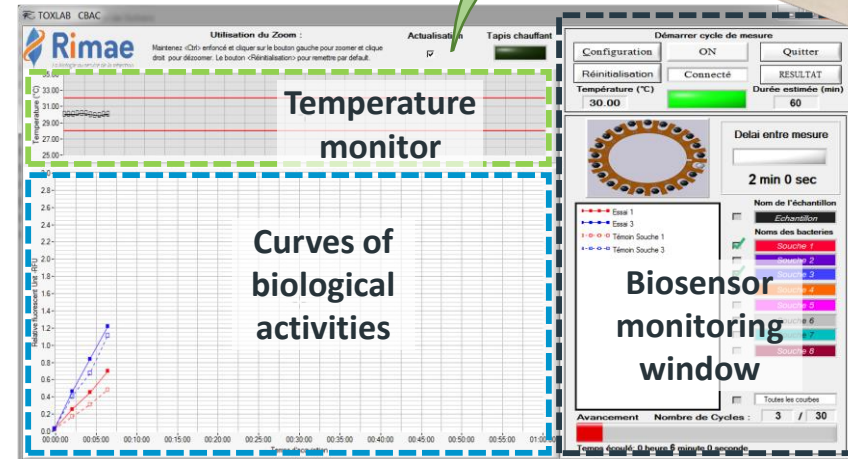
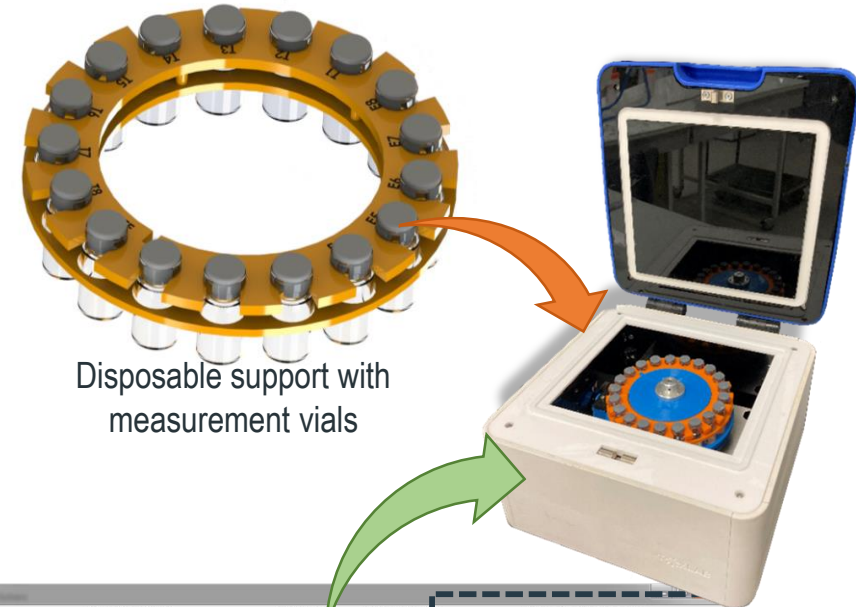
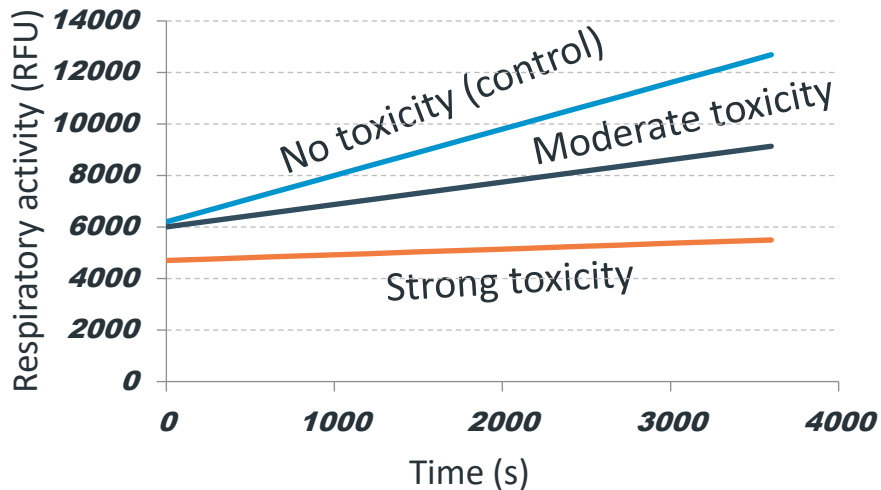
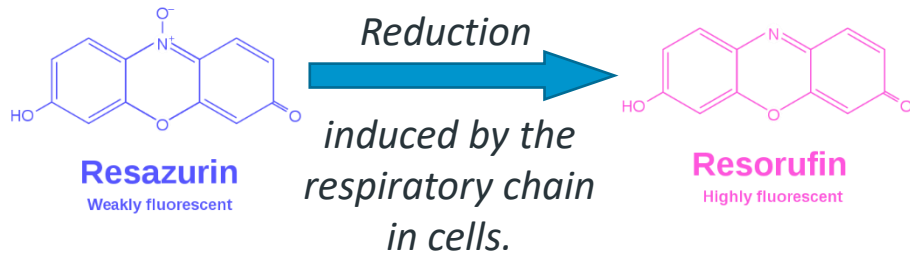

Dedicated interface for controlling the biosensor and monitoring biological activities

TOXLAB : Strategy

3 Data processing and validation

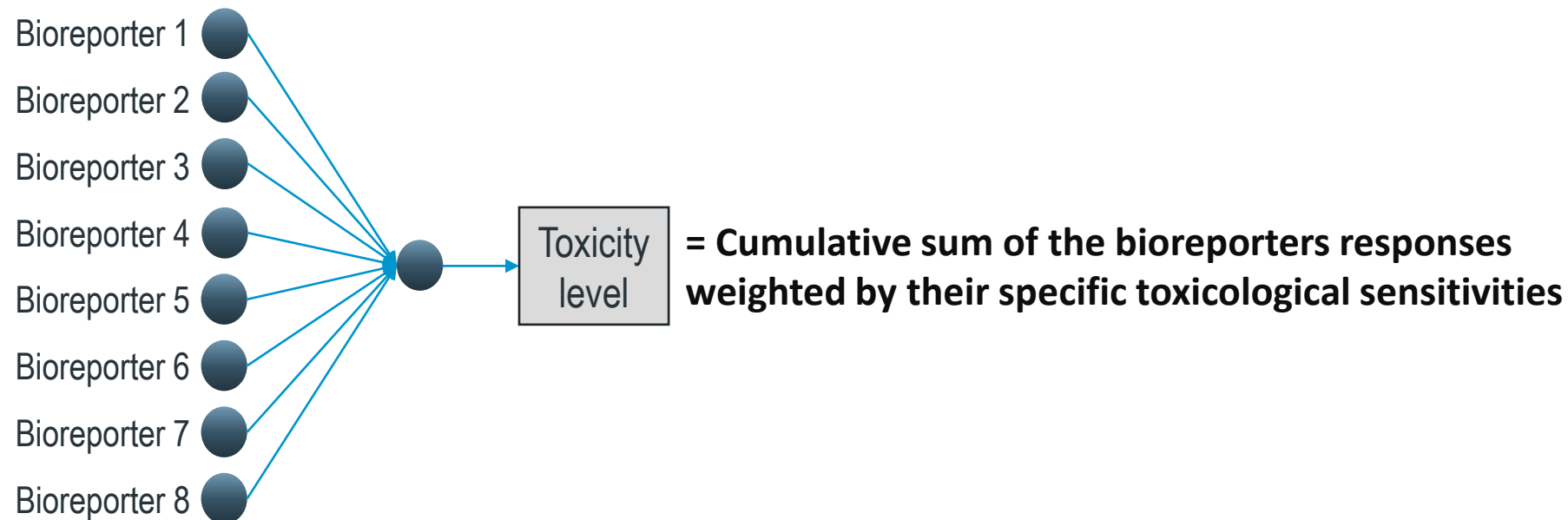
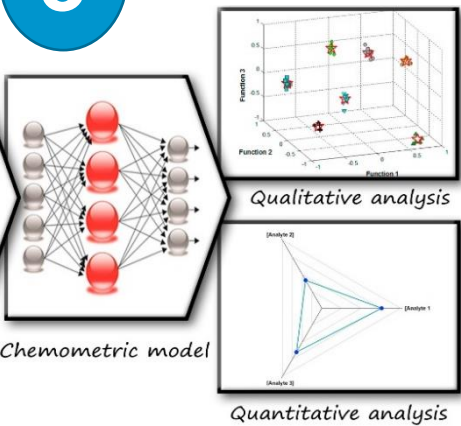

TOXLAB : Results

3 Data processing and validation

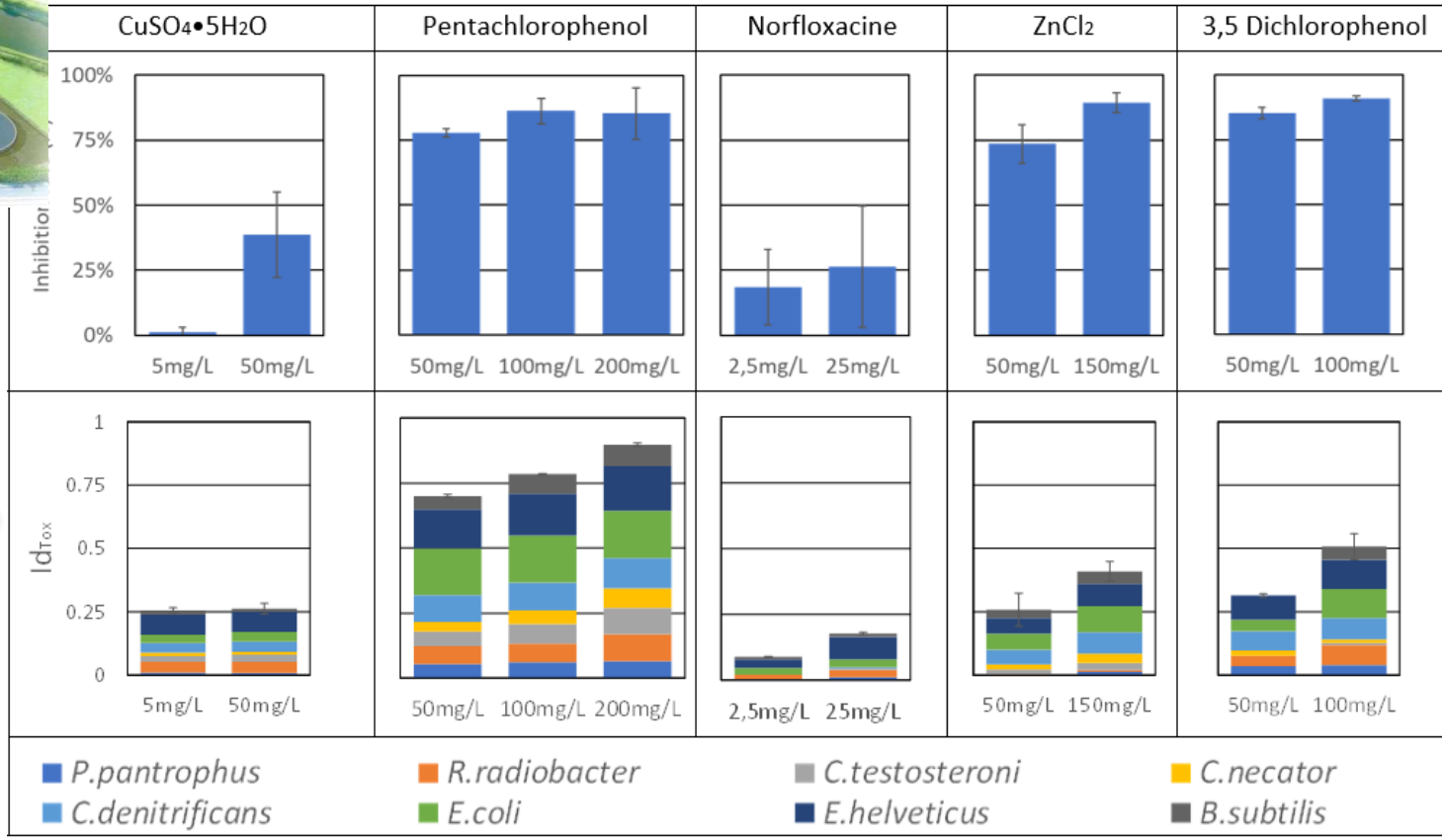
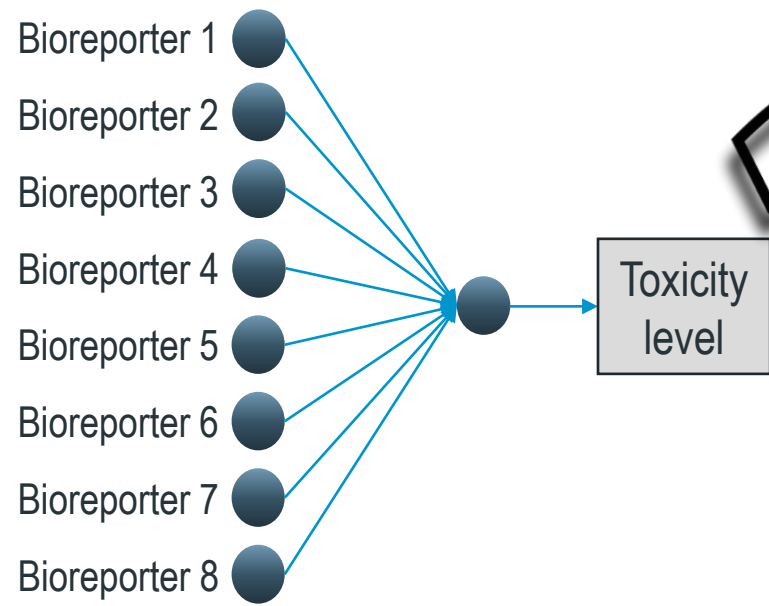
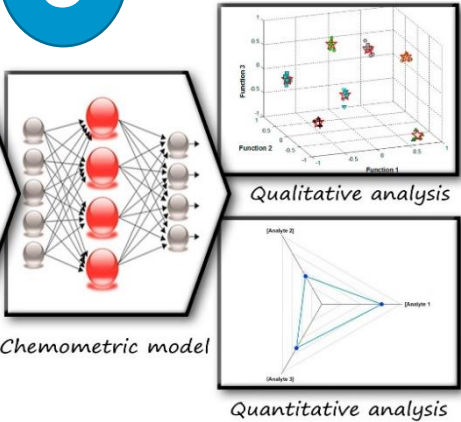

TOXLAB : Limit

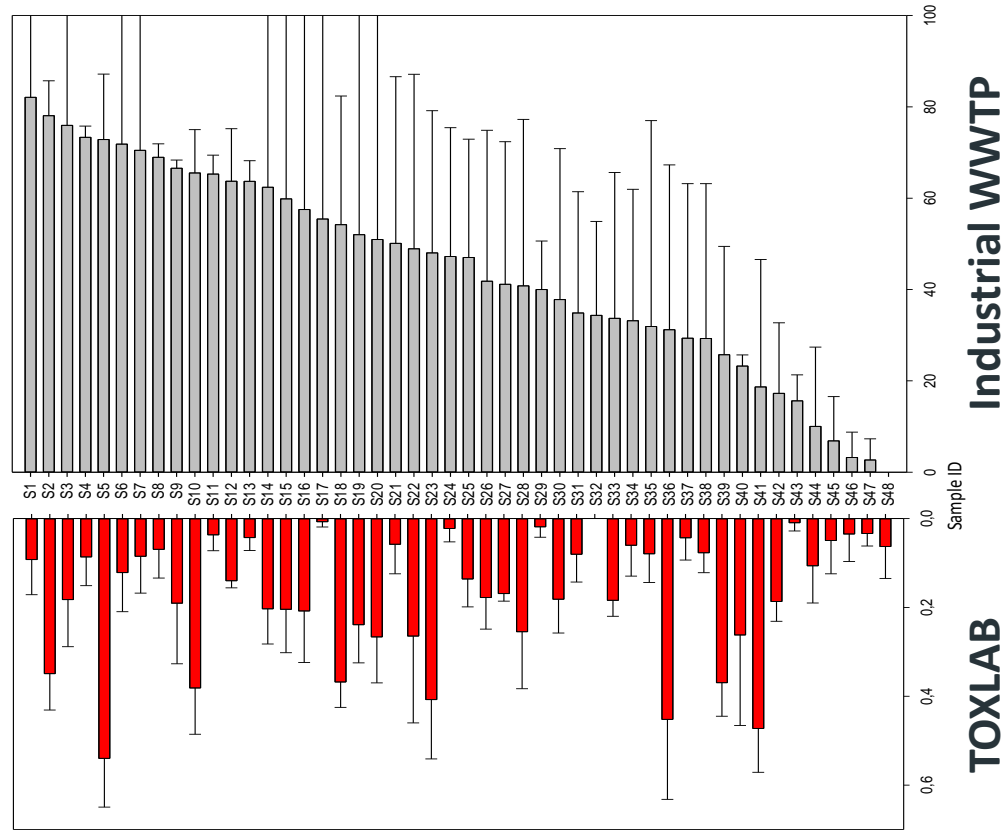
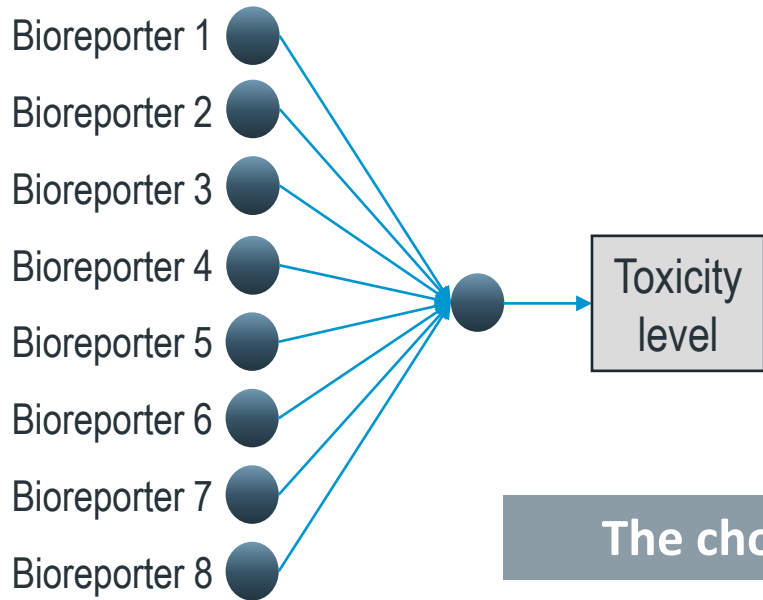

Industrial WWTP

TOXLAB

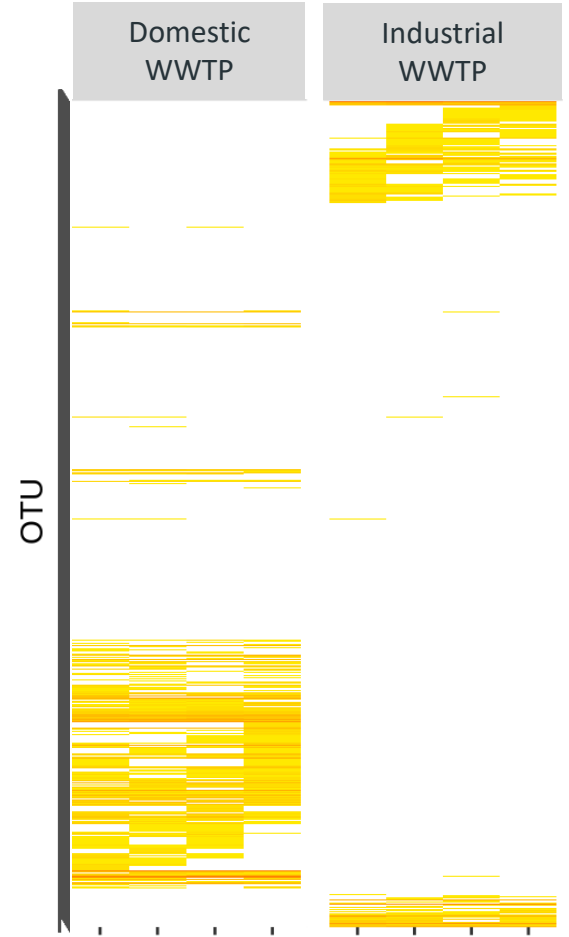

The choice of bioreporters is crucial in a context of toxicity assessment

MOBILTOX : Context



MarTERA
ERA-NET COFUND

anr

U&Fiscdi

GEPEA
UMR CNRS 6144

Nantes
Université



Objective : To develop an in-field assessment method dedicated to the health state of marine environments.

Measurement strategy

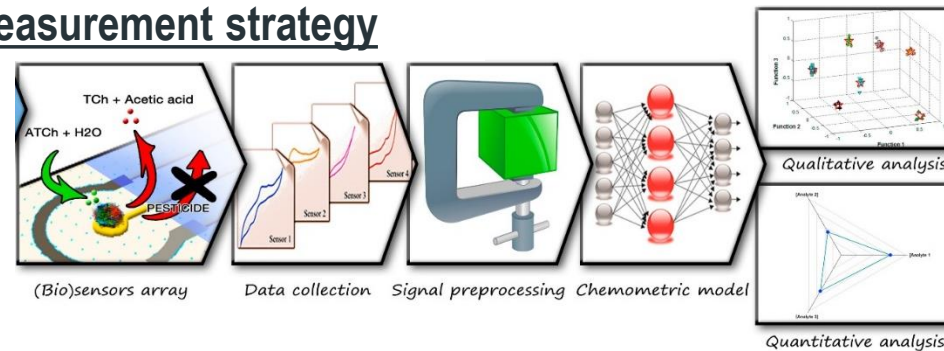

Field deployment

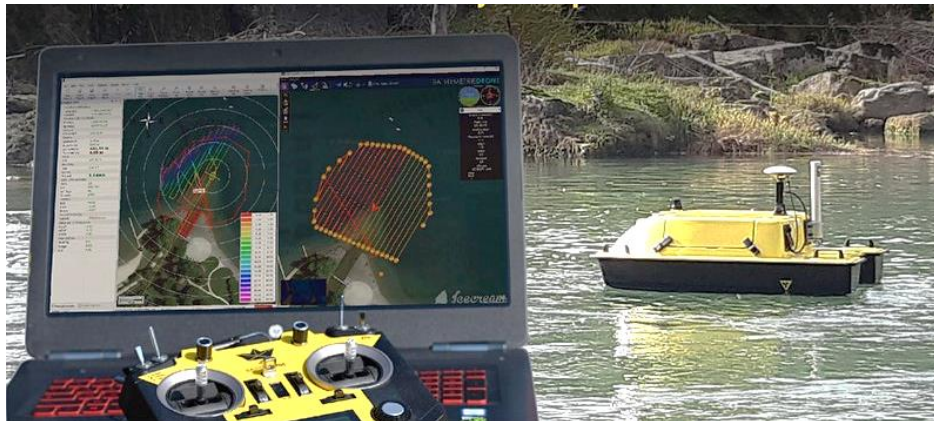

- Sampling
- Measurement

MOBILTOX : strategy

1

Measurement strategy

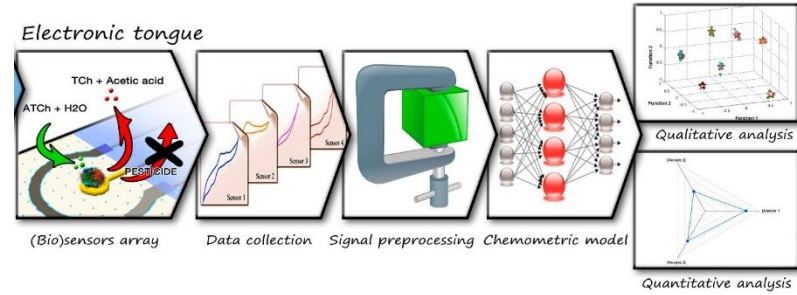

Experimental characterization :
Genetical diversity
(16S rRNA)

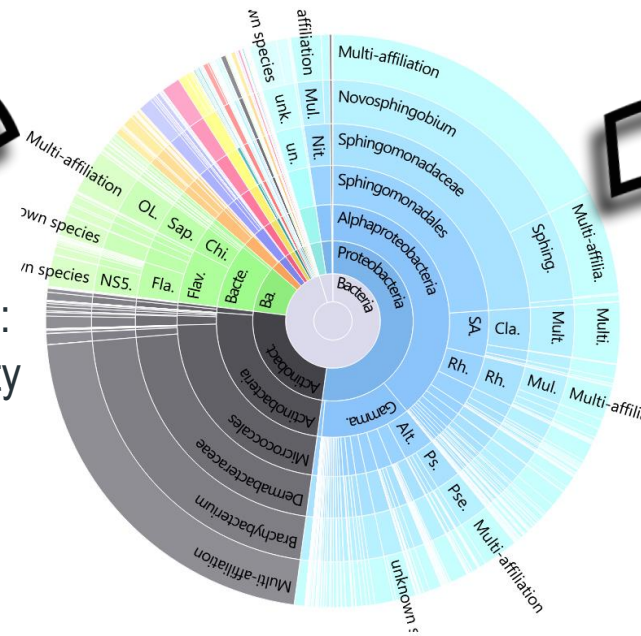

40 potential bioreporters
(bacterial strains isolated from
this specific environment)

MOBILTOX : strategy

1

Measurement strategy

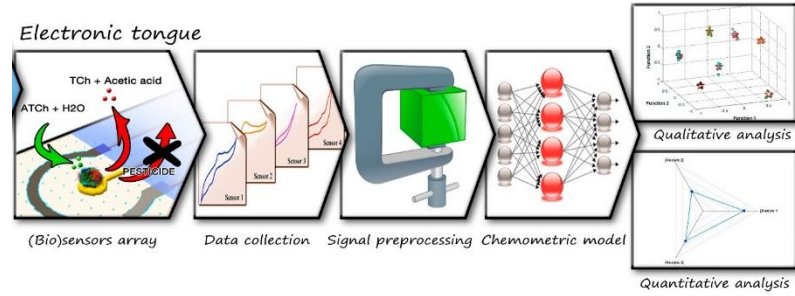

40 potential bioreporters
(bacterial strains isolated from
this specific environment)



Metabolic capabilities

| | 1 | 2 | 3 | 4 |
|---------------|---|---|---|---|
| Bioreporter 1 | | | | |
| Bioreporter 2 | | | | |
| Bioreporter 3 | | | | |

Metabolic capabilities

Environmental community

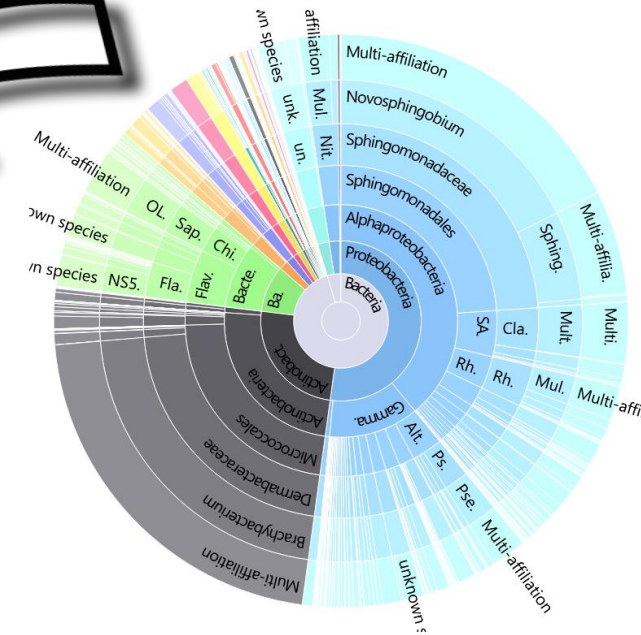

Final bioreporters array = 7
bioreporters

MOBILTOX : strategy

2

Field deployment

- Sampling



2 functions

- Measurement

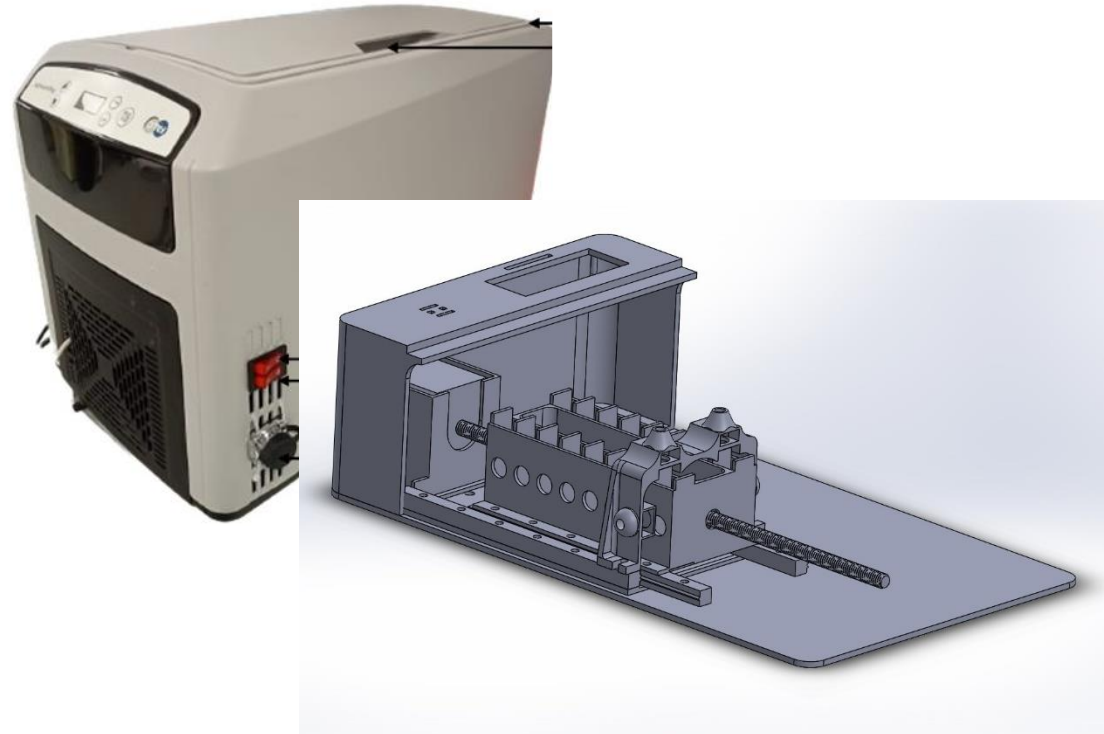

MOBILTOX · strategy

2

Field deployment : Sampling

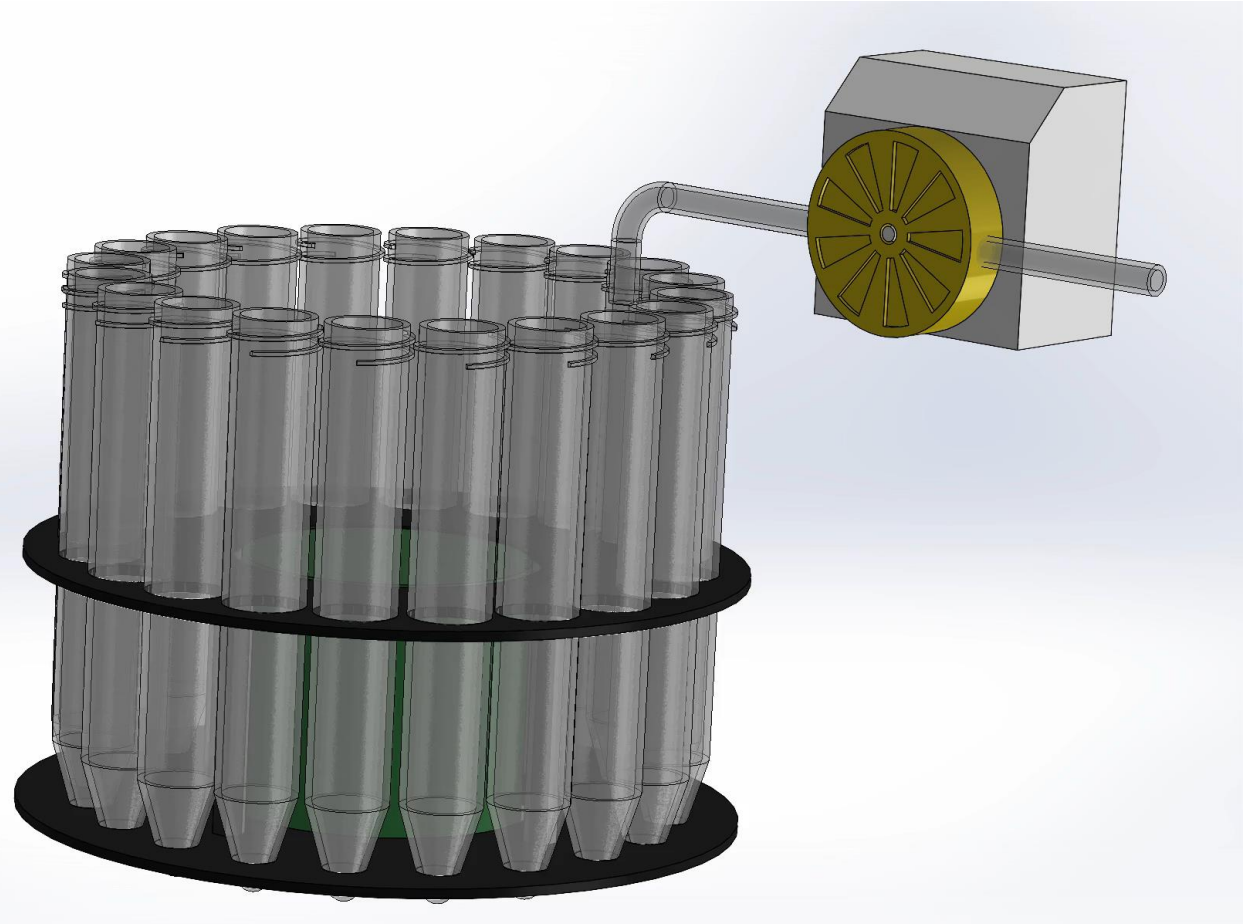
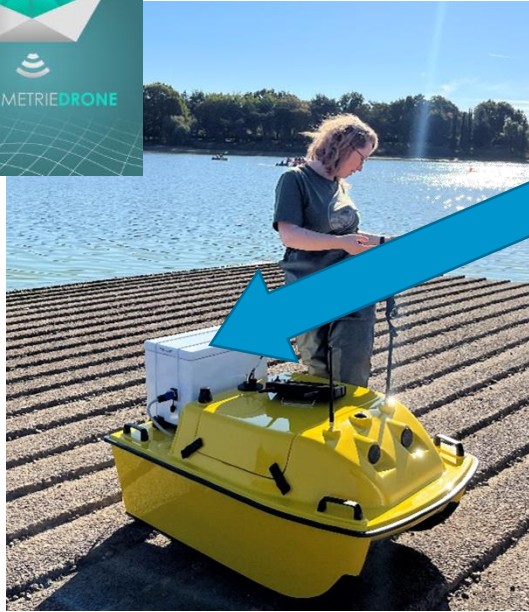
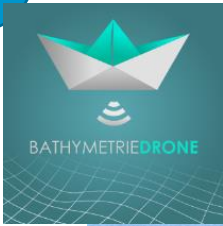

MOBILTOX : strategy

2

Field deployment : Sampling

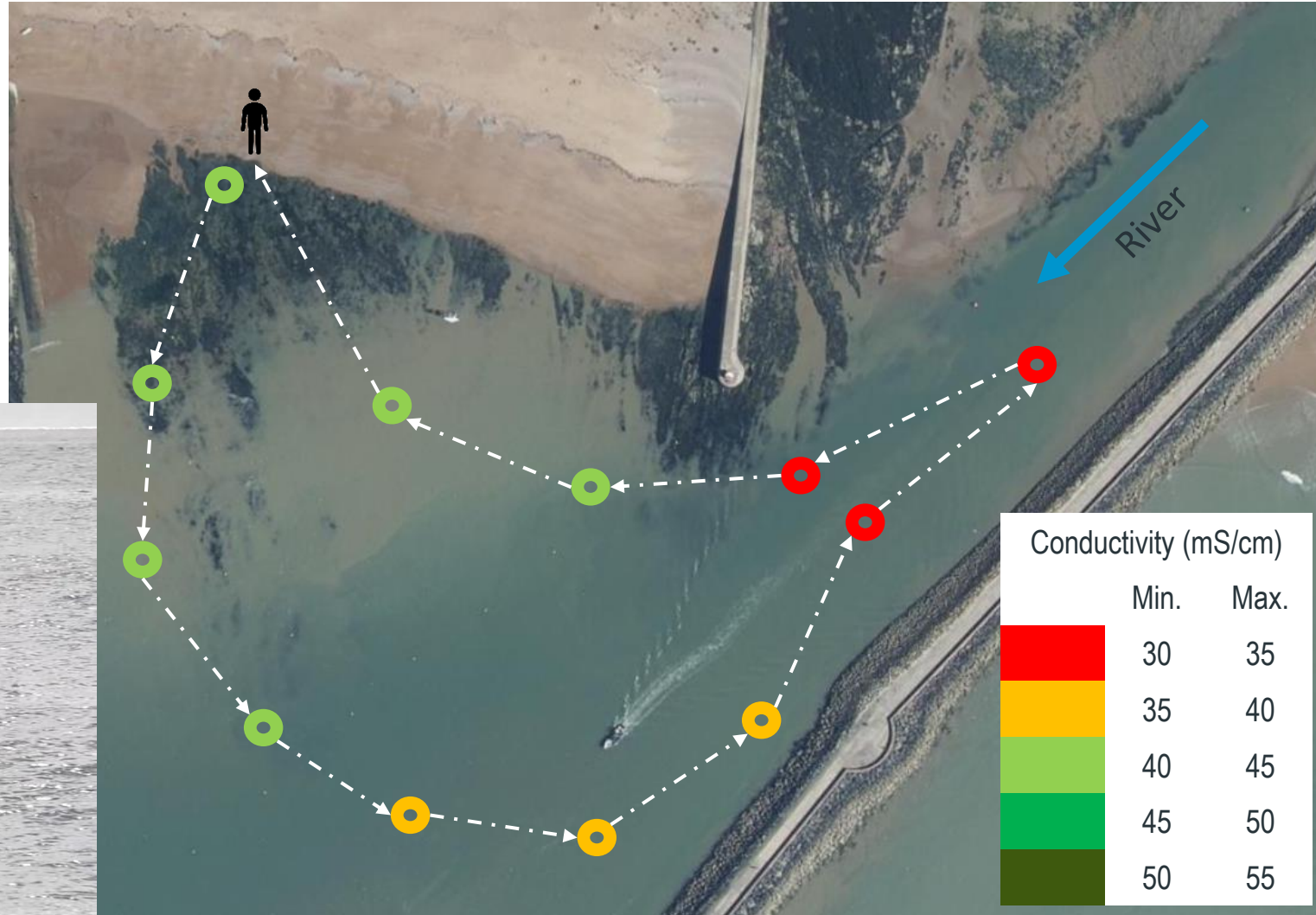
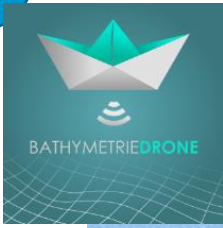

MOBILTOX : strategy

2 Field deployment : Measurement

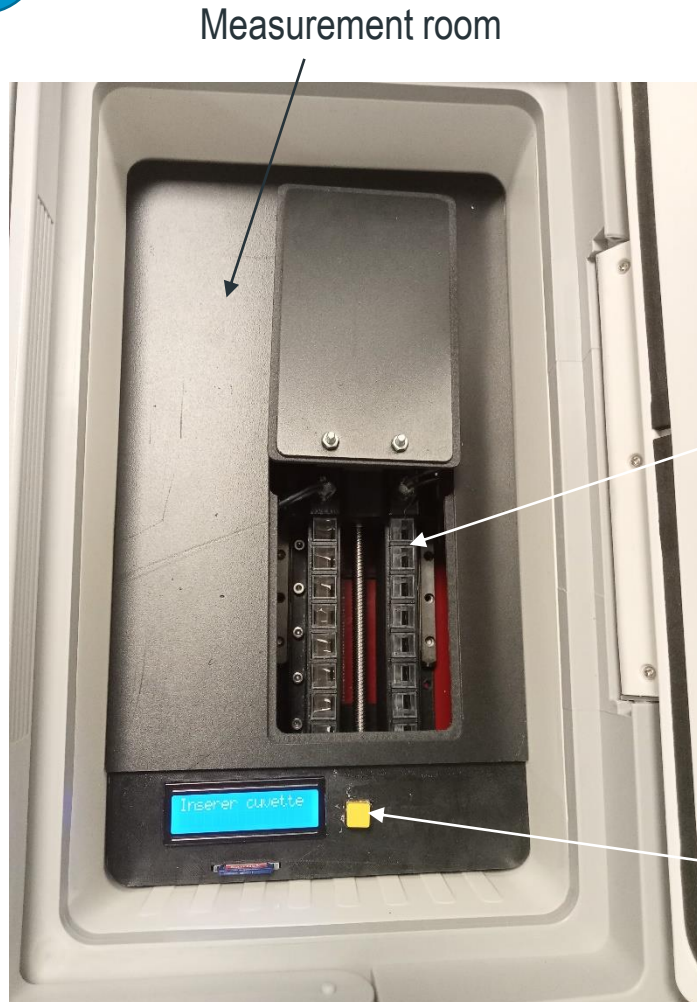

Biosensor designed for in-field measurement and ensuring optimal conditions for measurement.



MOBILTOX : strategy

2 Field deployment : Measurement

Measurement method :

- simple
- without specific skills



MOBILTOX : Results

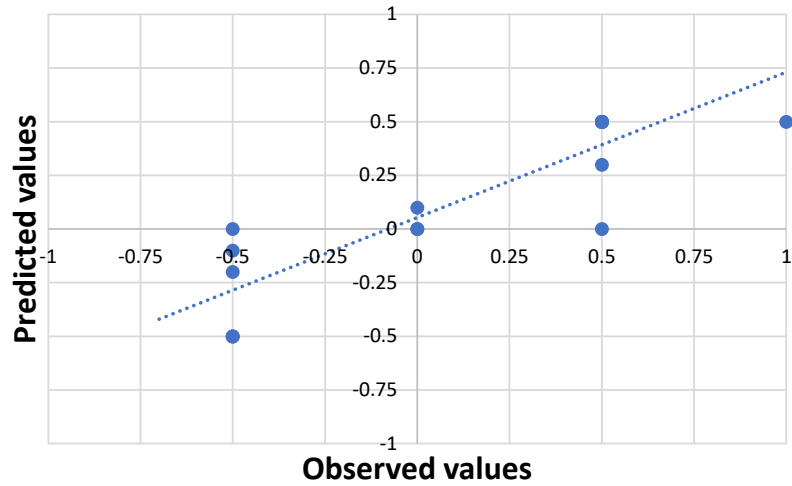

Prediction on functional diversity
 $r^2=0.81$

Metabolic capabilities

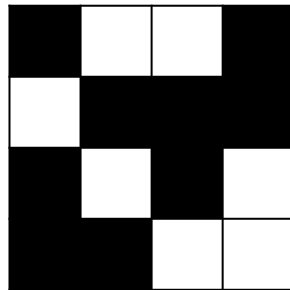

Environmental community

Final bioreporters array = 7 bioreporters

Neural networks

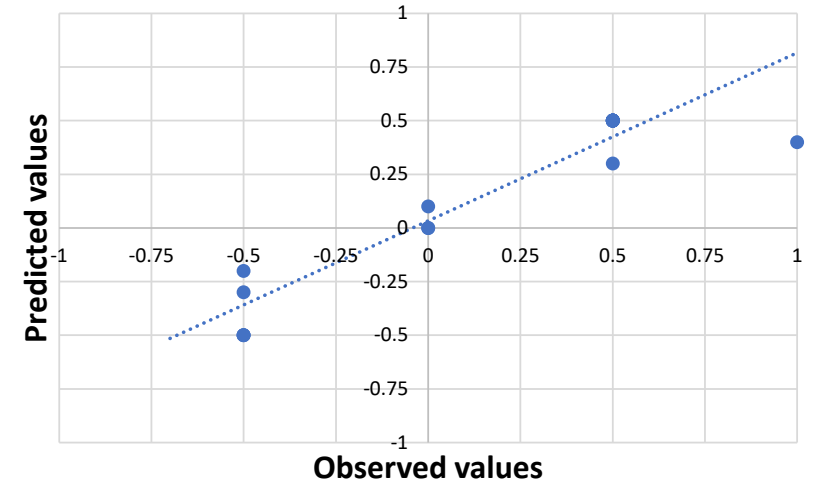
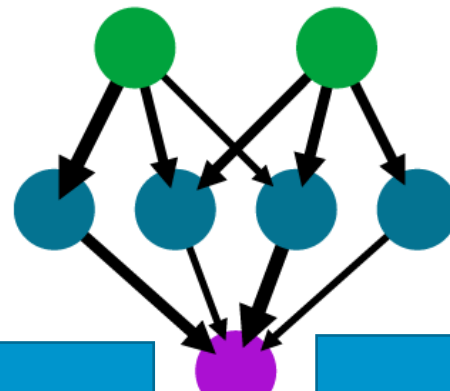

Prediction on population diversity
 $r^2=0.86$

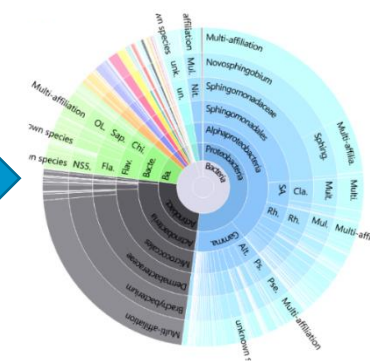

Conclusion

TOXLAB *Domestic WWTP*

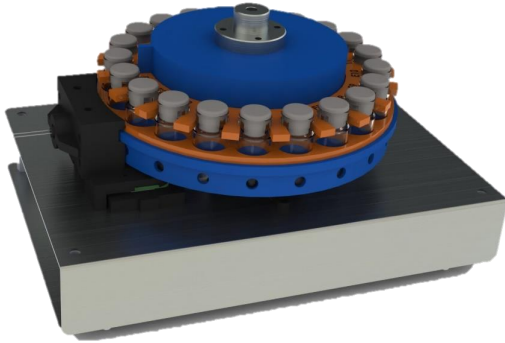

MOBILTOX *Seawater*



Easy to use
methods

Representative data

- Intensity of toxic effect on community
- Impact on population diversity
- Impact on ecosystemic functions

Powerful
tool

Crucial choice
of bioreporter



22nd ISCB & 20th ISLS

Thanks for
your attention

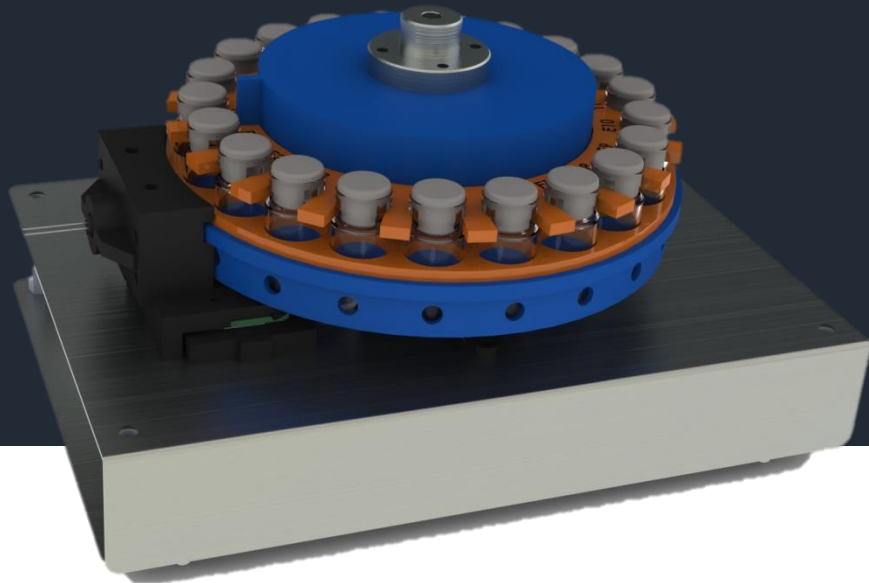
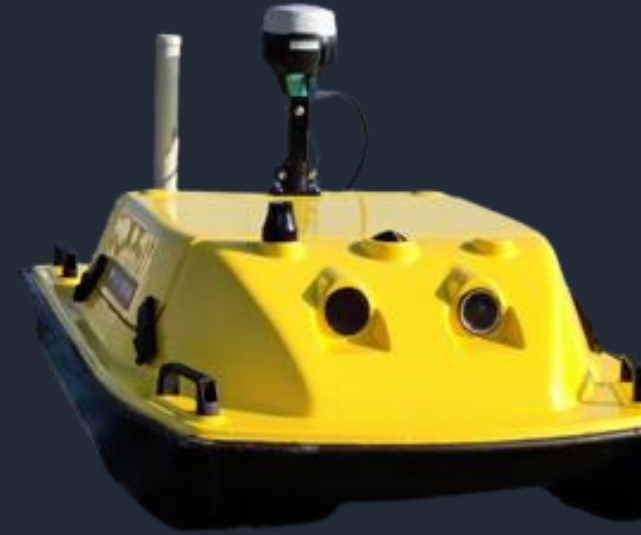

Sullivan.jouanneau@univ-nantes.fr



TOXLAB : Strategy

1 Bioreporters arrays

STEP 2 : Selection of the bioreporters

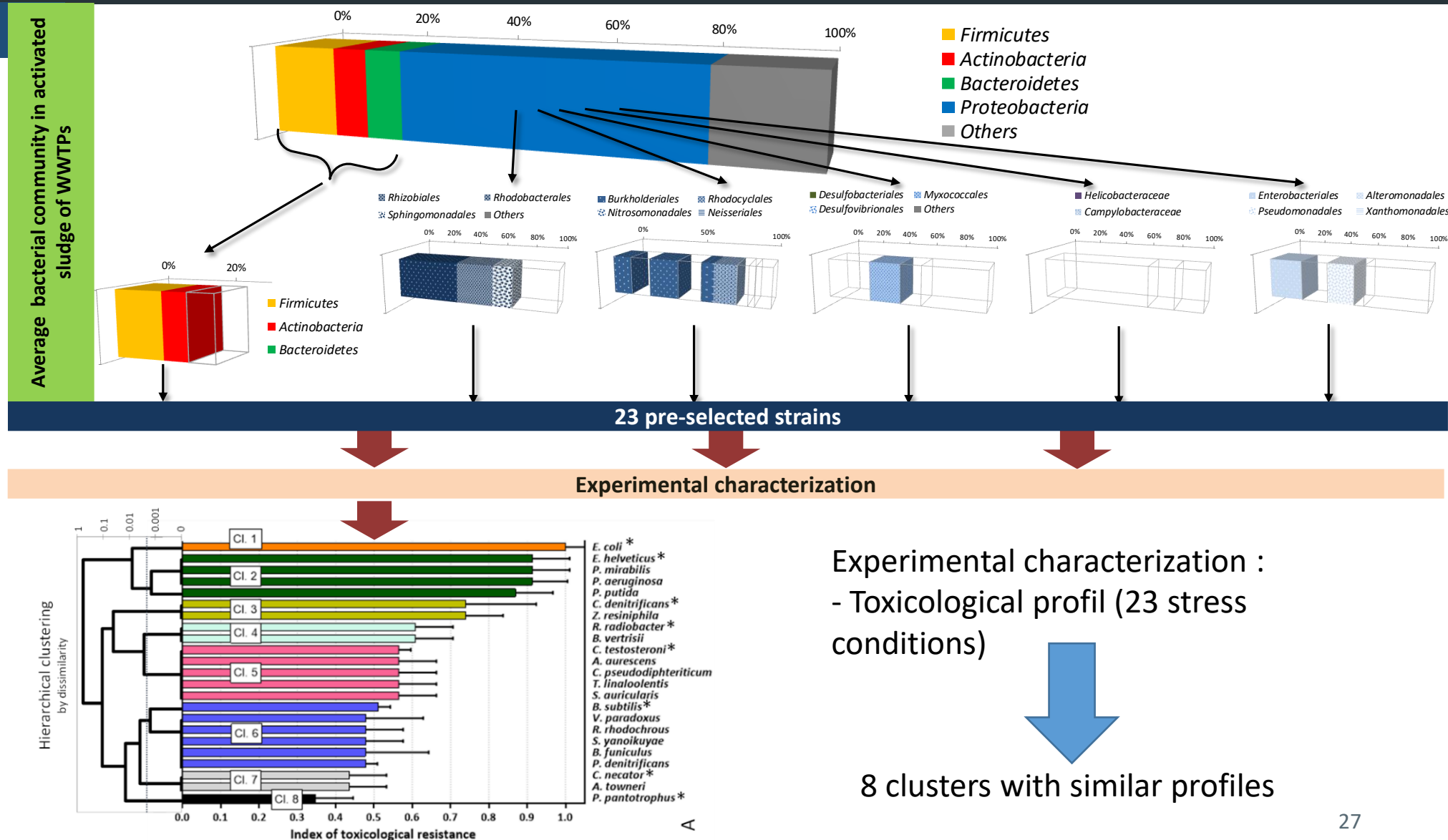

TOXLAB : Strategy

1 Bioreporters arrays

STEP 2 : Selection of the bioreporters

