



HAL
open science

Analysis of wrinkled membrane structures using a Plane Stress projection procedure and the Dynamic Relaxation method

H. Le Meitour, G. Rio, H. Laurent, A.S. Lectez, P. Guigue

► **To cite this version:**

H. Le Meitour, G. Rio, H. Laurent, A.S. Lectez, P. Guigue. Analysis of wrinkled membrane structures using a Plane Stress projection procedure and the Dynamic Relaxation method. *International Journal of Solids and Structures*, 2021, 208-209, pp.194-213. 10.1016/j.ijsolstr.2020.10.026 . hal-04649889

HAL Id: hal-04649889

<https://hal.science/hal-04649889v1>

Submitted on 18 Nov 2024

HAL is a multi-disciplinary open access archive for the deposit and dissemination of scientific research documents, whether they are published or not. The documents may come from teaching and research institutions in France or abroad, or from public or private research centers.

L'archive ouverte pluridisciplinaire **HAL**, est destinée au dépôt et à la diffusion de documents scientifiques de niveau recherche, publiés ou non, émanant des établissements d'enseignement et de recherche français ou étrangers, des laboratoires publics ou privés.

Analysis of wrinkled membrane structures using a Plane Stress projection procedure and the Dynamic Relaxation method

H. Le Meitour^a, G. Rio^a, H. Laurent^{a,*}, A. S. Lectez^b, P. Guigue^b

^a*Univ. Bretagne Sud,*

UMR CNRS 6027, IRDL, F-56100 Lorient, France

^b*CNES, Centre Spatial de Toulouse,*

18 avenue Edouard Belin, F-31401 Toulouse cedex 9, France

Abstract

Deployable membrane structures such as inflatable stratospheric balloons are known to be sensitive to the occurrence of local instabilities such as wrinkles. The wrinkling phenomenon affects the working performances of the membrane and the occurrence of this phenomenon has to be controlled numerically in order to predict the best means of deployment during the inflation of aerospace balloons. To improve their performances and reliability during flight, the balloons also need to be sized appropriately without the stress field being disturbed by the wrinkles. These instabilities originate numerically from the membrane elements which have a negligible bending stiffness. Several wrinkling models have been presented in the literature in order to solve this problem. However, in most of these models an elastic law and the Green deformation approach have been used for this purpose.

The new model called the PS-DPS model presented here for correcting the effects of wrinkles on membrane structures was implemented in the in-

*Corresponding author

Email address: herve.laurent@univ-ubs.fr (H. Laurent)

URL: <http://irdl.fr/> (H. Laurent)

house finite element software Herezh++. A projection technique based on a Newton-Raphson method is used to control the stress plane and the in-plane contraction. Using the Almansi strain formulation, this model also accounts for the changes in membrane thickness liable to occur during simulations. The problems due to numerical instabilities are overcome by determining the equilibrium with the so-called Dynamic Relaxation method using kinetic damping procedures. Unlike other membrane models of literature, the PS-DPS model can be used with materials showing complex mechanical behaviour of all kinds. Several benchmark problems are analysed with the present wrinkling model and compared with results available in the literature, focusing first on an elastic law and then on a non-linear hyperelastic law. Lastly, the inflation of a square cushion test and that of a Zero Pressure Balloon are simulated with this non-linear law. The results obtained indicate that the PS-DPS model is valid and accurate to take into account the wrinkles in flexible structures with all these linear and non-linear behaviours.

Keywords: Wrinkling model, Membrane structures, Inflated structures, Dynamic Relaxation method, Plane Stress projection procedure, Non-linear behaviour

1. Introduction

Inflated stratospheric balloons made of thin plastic film are widely used by the French Space Agency (CNES) for studying atmospheric and astrophysical phenomena and testing technological innovations. Due to the large size of these balloons (which measure anything up to 180 m in height) and the flexibility of their polyethylene envelope (which is only a few tens of μm thick), inflation of the stratospheric balloons causes local buckling phenomena, which appears as wrinkling. These buckling processes are due to the fact that these membrane structures, which have been referred to as "without compression", have a negligible bending stiffness. If no compressive stress is induced in the membrane, an out-of-plane displacement of the membrane will occur, resulting in wrinkles.

The number of numerical studies on wrinkled structures such as flexible membranes and fine fabric structures has increased considerably since the 1990s. Jenkins in his 1996 review [1](#) was the first to not only outline the problem of wrinkling, but also to cover all the aspects of the theory and applications of thin structures that can be defined as membranes. Several reviews [2-9](#) have been subsequently published on the various finite element methods developed for simulating wrinkling problems. The basic idea was introduced by Wagner [10](#), based in particular on Tension-Field (TF) theory, and on the assumption that a membrane has no bending stiffness and cannot resist any compression forces. Many wrinkling models (see for example [6; 11](#)) have since been developed on these lines for predicting the wrinkling direction and eliminating the in-plane stiffness in the direction perpendicular to the wrinkles.

Thus, the first type of wrinkling model was to modify the deformation gradient tensor to represent TF responses of wrinkled membranes [12; 13](#).

28 By introducing the concept of relaxed energy density, Pipkin <14> defined
29 membrane wrinkling as a problem of energy minimization arising in the case
30 of elastic bodies devoid of bending rigidity. This method inspired several
31 other models <15–17>, and Epstein and Forcinito <18> extended this re-
32 laxed energy function model to include anisotropic membranes by introducing
33 the idea of saturated elasticity and by modifying the Green’s strain tensor.

34 The second approach, on which this paper focuses, is based on a local
35 modification of the stress-strain relationship within an element, *i.e.* the
36 constitutive equation is modified in order to eliminate all the compressive
37 stresses <19>. In this case, there exist several possible solutions. One of
38 them consists in modifying the stiffness tensor of elasticity by adding a cor-
39 rective factor <4; 20–22>. Another one consists in modifying the constants
40 of the material such as the modulus of elasticity and/or the Poisson’s ratio
41 <23–26>. Another method consists in post-multiplying the stiffness matrix
42 with a projection matrix that eliminates the compressive stresses <19; 27>.
43 The influence of these various solutions can be seen in the paper by Wang
44 et al. <6>. These previous approaches provide a rigorous mathematical
45 formulation of the wrinkling mechanism and can easily be applied to existing
46 finite element codes for the analysis of membrane structures with wrinkles.
47 However, the exact physical significance of the modified elasticity matrix is
48 somewhat obscure because of the arbitrary choice of projection matrix.

49 The last approach to modelling wrinkles worth mentioning consists in
50 using thin shell elements that include both membrane and bending contribu-
51 tions and can be used to model the amplitude and wavelength of wrinkles.
52 This method has been adopted in several studies (*e.g.* <3; 28>). Unfor-
53 tunately, in order to obtain sufficiently realistic results, the mesh size must
54 be sufficiently fine which requires fairly long computational times. Shell el-

55 elements are naturally more expensive in terms of computational time than
56 membrane elements because a large number of degrees of freedom (rota-
57 tions) and integration points (through the thickness) is required. During the
58 last few years, however, shell elements devoid rotational degrees of freedom
59 have been developed <29–32> and used to model the shape of wrinkles on
60 isotropic and anisotropic flexible structures <33>. Elements of this kind are
61 the most efficient for modelling the wrinkles phenomena in small structures,
62 but in the case of large structures such as stratospheric balloons, this option
63 does not seem to be the most efficient due to the long computational times
64 induced by the mesh size. In addition, it is worth noting that the wrinkling
65 behaviour (*i.e.* buckling) often depends on the size and type of mesh.

66 Finding suitable means of modelling wrinkling processes in the design
67 stage is therefore an important challenge for constructing reliable membrane-
68 based space structures <34>. It is of the utmost importance to be able to
69 predict the behaviour of membrane wrinkles, including the direction in which
70 they occur and what stresses are at work in the case of inflated stratospheric
71 balloons <11>. However, most previous studies have focused so far on de-
72 termining the direction of the wrinkling process and the corresponding stress
73 state in the case of materials with isotropic <7; 14; 35> or anisotropic linear
74 behaviour <12; 17; 18; 22; 36> as well as for linear viscoelastic behaviour
75 <37–40>. However, in the case of materials with non linear behaviour, this
76 subject still requires further investigation <41; 42>, and in the context of
77 stratospheric balloons, it should be noted that thin films show complex be-
78 haviour characterized by large irreversible strains and strain rate dependency,
79 and therefore, elasto-visco-plastic behaviour. In this context, the aim of this
80 paper is to present a new simple, accurate method of modelling membrane
81 structures giving the wrinkling directions for all kinds of material behaviours.

82 This model, which we have called the "Plane Stress-Double Plane Stress"
83 (PS-DPS) model, is based on two approaches. The first approach consists in
84 adjusting the components of the constitutive tensor in the direction of the
85 compressive stress. The principle underlying this method is in fact consistent
86 with other approaches used in <4; 19; 43>, for example, but the Newton-
87 Raphson method of projection used here makes it possible to control the
88 constitutive matrix in the case of materials of all kinds. In this case, the aim
89 is not to simulate the shape of the wrinkles but to account for their occurrence
90 on the equilibrium state of the membrane. Another originality feature of this
91 model is that the thickness of the membrane structure is updated throughout
92 the simulation.

93 The second approach used in the PS-DPS model overcomes the numeri-
94 cal instabilities that are liable to occur due to the poor convergence of the
95 numerical resolution of the membrane structure. This is can be explained
96 by the fact that the local stiffness of the membrane can vary between large
97 positive values and zero during the iterative process. A Dynamic Relaxation
98 (DR) method (which is also known as the pseudo-Dynamic method) is then
99 introduced to determine the global equilibrium in the analysis of undercon-
100 strained membranes <44; 45>.

101 These two approaches and the DR method are implemented in the in-
102 house finite element software Herezh++ <46-48>. In the literature, wrinkled
103 membrane models have been classically written based on the initial config-
104 uration of the structure using the Green strain tensor <6; 7; 27> whereas
105 the PS-DPS model is written here based on the current configuration of the
106 structure using the Almansi strain measure and the Cauchy stress tensor.

107 This paper is structured as follows: the numerical methods used to de-
108 velop the PS-DPS model are presented in Section 2. The distinctive char-

109 acteristics of the Plane Stress and Double Plane Stress approaches are ex-
110 plained in sections 2.3 and 2.4 respectively. The pseudo-Dynamic process
111 is then described in section 3. To show the accuracy and potential of the
112 present model, several benchmark examples are modelled and analysed in
113 section 4 using isotropic elastic law and compare with results available in the
114 literature. First, structures constrained in their planes are studied. Shear
115 test is first analysed since this is the most widely used test for checking the
116 validity of wrinkling models. In this test, the membrane is fully wrinkled
117 (in either a single direction or all possible directions) in order to check the
118 accuracy of the PS-DPS model. The results of a torsion test in which the
119 membrane shifts locally from a wrinkled to a taut state is then compared
120 with an analytical solution. Next, a square cushion deployment is carried
121 out in order to test the model on a structure resembling that of stratospheric
122 balloon. In this test, comparisons are also made with finite element simula-
123 tions performed with Abaqus <49> using the "No compression" procedure,
124 in which the elastic behaviour is modified by imposing the appropriate prin-
125 cipal stress at zero. To determine the influence of behavioral laws on the
126 results obtained, the inflation of a square cushion test is also simulated using
127 a hyperelastic law with the PS-DPS model in section 4.4. Lastly, in section 5,
128 to show the applicability of the PS-DPS model in a real case of balloon in-
129 flation, simulations of the deployment of a Zero Pressure Balloon with both
130 elastic and non linear laws are presented.

131 2. The PS–DPS model

132 Before presenting the PS–DPS model, some notations are introduced in
133 order to explain the kinematic hypotheses and tensor notations used. First,
134 let us take a Gauss point M and the associated material frame $\{M, \vec{g}_i\}$ (where

135 $i = 1 \dots 3$). The covariant base vectors, which follow the point M as a func-
 136 tion of time t , are defined in the tangent membrane plane, using a curvilinear
 137 coordinate system θ^α , by:

$$\vec{g}_\alpha(t) = \frac{\partial \vec{M}(t)}{\partial \theta^\alpha} \text{ with } \alpha = 1, 2 \quad (1)$$

138 In the Herezh++ software, these curvilinear coordinates constituting a set
 139 of material coordinates are those used in the base of the reference element
 140 (for further details, see for instance <30; 50>). The normal vector of the
 141 tangent plane is obtained by taking $\vec{g}_3 = \vec{g}_1 \wedge \vec{g}_2$. The norm of \vec{g}_3 is arbitrarily
 142 set at 1 (see fig. 1).

143 The contravariant components σ^{ij} of the Cauchy stress tensor $\boldsymbol{\sigma}$ are de-
 144 fined at each Gauss Point M in the current configuration using these covari-
 145 ant base vectors according to:

$$\boldsymbol{\sigma} = \sigma^{ij} \vec{g}_i \otimes \vec{g}_j \quad (2)$$

146 The Almansi strain tensor can also be defined in the contravariant current
 147 base vector taking:

$$\boldsymbol{\epsilon} = \epsilon_{ij} \vec{g}^i \otimes \vec{g}^j \quad (3)$$

148 2.1. Evaluation of the membrane states

149 In the literature, to denote the various states of the membrane (taut,
 150 slacked and wrinkled), three criteria based on the signs of the components
 151 σ_I and σ_{II} of the principal stresses and/or the principal strains ϵ_I and ϵ_{II} are
 152 now widely used (see table 1).

153 According to Liu et al. <21>, the stress criterion underestimates the state
 154 of "*slackness*" and the strain criterion underestimates the state of "*tautness*"
 155 of the membrane. Several authors <20; 51> have suggested that the mixed
 156 criterion seems to be the most useful means of differentiating between these

Membrane states	Stress criterion	Strain criterion	Mixed criterion
Taut	$\sigma_{\text{II}} > 0$	$\varepsilon_{\text{II}} > 0$	$\sigma_{\text{II}} > 0$
Wrinkled	$\sigma_{\text{II}} < 0 \ \& \ \sigma_{\text{I}} > 0$	$\varepsilon_{\text{II}} < 0 \ \& \ \varepsilon_{\text{I}} > 0$	$\sigma_{\text{II}} < 0 \ \& \ \varepsilon_{\text{I}} > 0$
Slacked	$\sigma_{\text{I}} < 0$	$\varepsilon_{\text{I}} < 0$	$\varepsilon_{\text{I}} < 0$

Table 1: The three membrane states defined by the stress, strain and mixed criteria as a function of the principal stresses and strains.

157 states. Wang et al. <6> recently presented a new means of modelling
158 these three states, taking the previous state obtained in the membrane and
159 a combination between the stress criterion and the strain criterion. This
160 new approach seems to be as effective as the mixed criterion but it requires
161 the use of the Poisson’s ratio, which restricts its use to material with linear
162 elastic behaviour. In view of this constraint, the mixed criterion was adopted
163 in the PS–DPS model. From a numerical point of view, a first computation
164 without taking into account the wrinkles is carried out to determine these
165 zones.

166 2.2. Principles underlying the PS–DPS model

167 As mentioned above in the Introduction, there are several ways of ap-
168 proaching wrinkles numerically. In the PS–DPS model, the aim is not to
169 model the shape of the wrinkles, but to predict the consequences of the
170 presence of wrinkles on the mechanical equilibrium of the membrane. From
171 the practical point of view, the PS–DPS is intended to apply to a wrinkled
172 structure, regarded as a unwrinkled planar membrane. The out-of-plane
173 displacement caused by compressive stresses is simply approached like an
174 in-plane contraction, as shown in fig. 1.

175 The PS–DPS model is based on two numerical assumptions. First, in

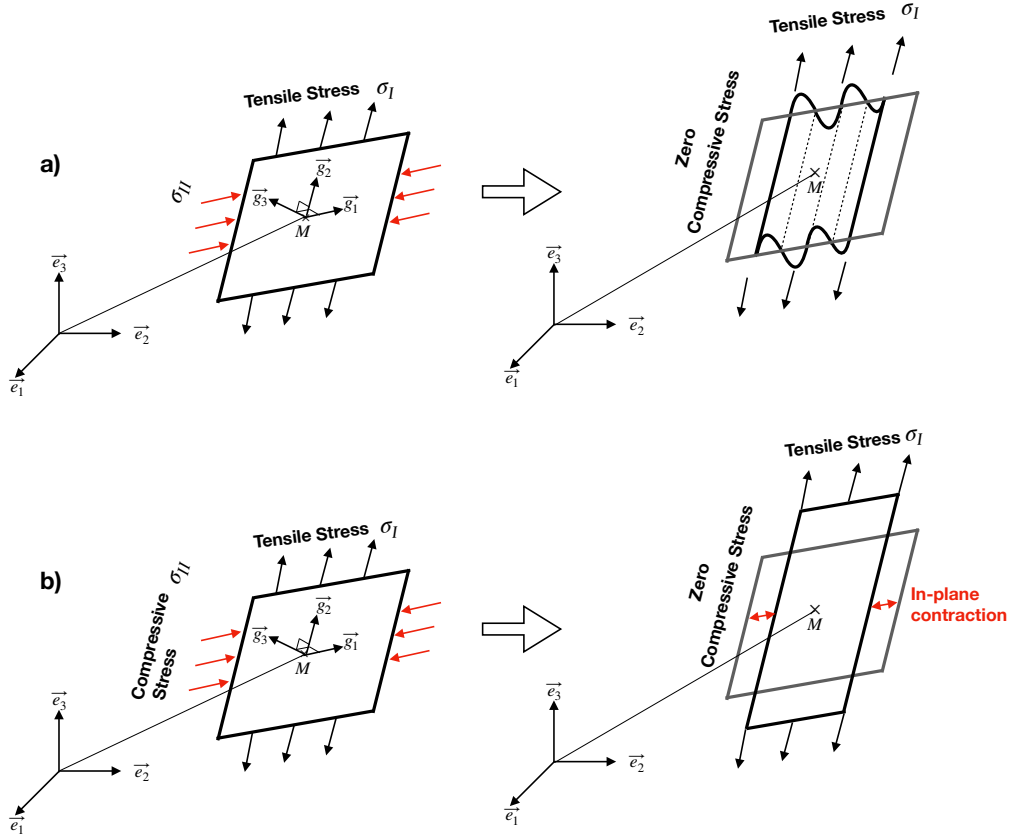

Figure 1: Diagram of the position and stress state of a Gauss point M in the membrane plane formed by (\vec{g}_1, \vec{g}_2) in the Cartesian coordinate system \vec{e}_i . a) Real membrane stress with wrinkles. b) Accounting for the behaviour of wrinkles with the PS–DPS model.

176 the case of any 3D behavioural law, a Newton-Raphson technique is used
 177 to impose a "Plane Stress" (PS) state on the membrane structures. In the
 178 second step, the assumptions of the TF theory, which we refer to here as the
 179 "Double Plane Stress" (DPS), are applied to the wrinkled part in a state of
 180 uniaxial tension on the plane of the membrane.

181 2.3. Membrane behaviour without any wrinkles: the PS state

182 During the equilibrium incremental, we assume that we have reached the
 183 end of an increment of time $t + \Delta t$, in which the kinematic displacements are

184 known, *i.e.* the 3D deformation state $\boldsymbol{\varepsilon}_{(t+\Delta t)}$, the increment of deformation
 185 $\Delta_t^{t+\Delta t} \boldsymbol{\varepsilon}$ between t and $t + \Delta t$, the strain rate tensor $\mathbf{D}_{(t+\Delta t)}$ and the 3D stress
 186 state $\boldsymbol{\sigma}_{(t+\Delta t)}$ are all known.

187 The first step in this approach consists in finding a PS state such that
 188 $\sigma^{3i} = 0$ as a function of the unknowns ε_{3i} , where $i = 1 \dots 3$, at each Gauss
 189 point M . In this case, as \vec{g}_3 is assumed to be a principal direction (*i.e.* an
 190 eigenvector for stress and strain tensors) and $\varepsilon_{31} = \varepsilon_{32} = 0$, the sole condition
 191 which has to be found is:

$$\sigma^{33}(\varepsilon_{33}) = 0 \quad (4)$$

192 To obtain this no stress compression state $\sigma^{33}(\varepsilon_{33}) = 0$, which is denoted
 193 $\boldsymbol{\sigma}_{(int)}$, a scheme based on a three steps Newton-Raphson algorithm is used
 194 (see also the first algorithm scheme of the PS state in fig. 2):

195 1. The initial value of the strain tensor is such that $\varepsilon_{\gamma\eta(t+\Delta t)}$ where $\gamma, \eta =$
 196 $1, 2$ is due to the kinematic displacement of the membrane at the point
 197 M , taking: $\varepsilon_{31} = \varepsilon_{32} = 0$. These values will stay constant during the
 198 Newton loops during the n iterations. The unknown ε_{33} is initialized
 199 at the beginning of the initial step $n=1$, by: $\varepsilon_{33(t+\Delta t)}^{(n=1)} = \varepsilon_{33(t)}$

200 2. Do while $\| \sigma_{(int)}^{33} \| < e_1$ where e_1 is a given level of precision (in the
 201 loop on n):

202 (a) evaluate $\sigma^{ij(n)}$ and $\frac{\partial \sigma^{ij(n)}}{\partial \varepsilon_{kl}}$ from the 3D behaviour

203 (b) calculate $\delta \varepsilon_{33} = - \left[\frac{\partial \sigma^{33(n)}}{\partial \varepsilon_{33}} \right]^{-1} \sigma^{33(n)}$, resulting from the applica-
 204 tion of the condition eq. (4)

205 (c) then $\varepsilon_{33(n+1)} = \delta \varepsilon_{33} + \varepsilon_{33(n)}$ and increment n as: $n = n + 1$

206 (d) update the membrane thickness.

207 At the end of this first intermediate state "*int*", after convergence, the
208 data obtained are:

- 209 • the 3D stress tensor $\boldsymbol{\sigma}_{(int)}$ that satisfies the first PS condition,
- 210 • the new thickness deformation $\varepsilon_{33(t+\Delta t)}$ and the associated new
211 thickness $h_{(t+\Delta t)}$ of the membrane.

212 3. In the case of an implicit scheme, the tangent matrix of the behavioural
213 law is also calculated: $\left[\frac{\partial \sigma^{\alpha\beta}}{\partial \varepsilon_{\gamma\eta}} \right]$ where $\alpha, \beta, \gamma, \eta = 1, 2$ which includes
214 the PS condition. Details of the calculation of the tangent matrix in
215 the PS condition are given in appendix [A](#).

216 Thanks to this process, the plane stress state can be applied to any type of
217 mechanical behavior.

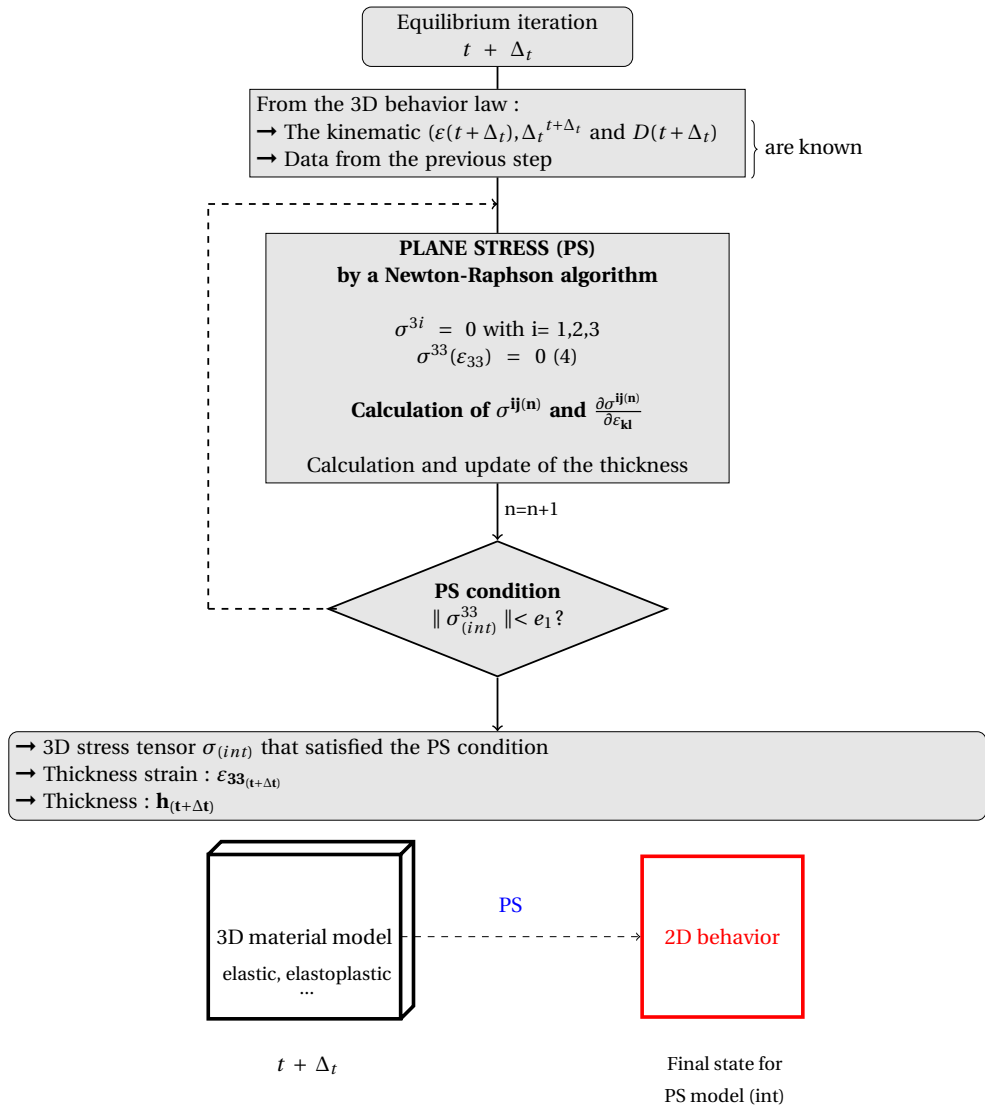

Figure 2: First algorithm used to define the PS state at a Gauss point on the membrane.

218 At the end of this state "int", the wrinkling areas are located in the
 219 membrane using the mixed criterion (see table 1). A new double plane stress
 220 (DPS) is then built into these wrinkles areas in order to release the compres-
 221 sion by using a new Newton-Raphson algorithm (which will be discussed in
 222 the next section). The global equilibrium of the membrane is then updated
 223 with this new behaviour, which yields a new final stress $\boldsymbol{\sigma}_{(end)}$ and strain
 224 tensors $\boldsymbol{\varepsilon}_{(end)}$ that can be used in the next equilibrium iteration. In the ten-
 225 sile areas of the structure, the local state of the membrane satisfies the PS
 226 condition.

227 To define these wrinkled zones, eigenvalues of tensors $\boldsymbol{\sigma}_{(int)}$ and $\boldsymbol{\varepsilon}_{(int)}$ are
 228 calculated based on the notations $\sigma_{(int)_I}$, $\sigma_{(int)_II}$ which are the major and
 229 minor principal stresses, and $\varepsilon_{(int)_I}$, $\varepsilon_{(int)_II}$ which are the major and minor
 230 principal strains, respectively.

231 According to the mixed criterion (see section 2.1), the membrane could
 232 be in one of the following three states:

- 233 1. $\sigma_{(int)_II} > 0$: the membrane is in a state of tension in all the directions
 234 on its median plane,
- 235 2. $\varepsilon_{(int)_I} < 0$: the membrane lacks of tension in all the directions on its
 236 median plane,
- 237 3. $\sigma_{(int)_II} < 0$: there are wrinkles in the direction of the eigenvector \vec{V}_2
 238 associated with $\sigma_{(int)_II}$.

239 2.4. Membrane with wrinkles: the PS–DPS Wrinkles Model

240 After determining the presence of wrinkles in the structure with the mixed
 241 criterion and the orientation of these wrinkles, the new stress and strain
 242 fields obtained with the DPS condition are determined using a new Newton-

243 Raphson algorithm. This DPS condition consists in imposing a new plane
 244 stress state in the direction of the wrinkles.

245 Take the eigenvector frame \vec{V}_α with $\alpha = 1, 2$, where \vec{V}_1 is the direction of
 246 the tension and \vec{V}_2 the transverse direction of the wrinkles. \vec{V}_3 is identical to
 247 \vec{g}_3 and gives a complete 3D eigenvector frame. In this frame, the presence of
 248 wrinkles must lead to $\sigma^{22} = 0$ and the PS model implies that: $\sigma^{33} = 0$. So
 249 the local behaviour is like a DPS constrain and the local stress state has to
 250 be studied again with the new conditions:

$$\sigma^{\alpha\alpha} \left(\varepsilon_{11}, \varepsilon_{22(mec)} \right) = 0 \quad (5)$$

251 where $\alpha = 2, 3$ and a new unknown $\varepsilon_{22(mec)}$ is introduced to denote the
 252 transverse mechanical strain, which differs from the kinematic deformation
 253 of the membrane $\varepsilon_{22(kin)}$.

254 A Newton-Raphson scheme for the DPS state is therefore written in the
 255 frame \vec{V}_i according to the following algorithm (see also this algorithm in
 256 fig. 3):

- 257 1. Initialization of the strain tensor component: $\varepsilon_{11(t+\Delta t)}$ with the kine-
 258 matic displacement of the membrane at the point M, taking $\varepsilon_{12} =$
 259 $\varepsilon_{31} = \varepsilon_{32} = 0$. These values will stay constant during the New-
 260 ton loops on the n iterations. The unknowns are initialized by:
 261 $\left\langle \varepsilon_{22(t+\Delta t)}, \varepsilon_{33(t+\Delta t)} \right\rangle^{(n=1)} = \left\langle \varepsilon_{22(t)}, \varepsilon_{33(t)} \right\rangle$ for $n = 1$.
- 262 2. Do while $\| \left\langle \sigma_{(int)}^{22}, \sigma_{(int)}^{33} \right\rangle \| < e_2$ where e_2 is a given precision (loop on
 263 n):

- 264 (a) evaluate $\sigma^{ij(n)}$ and $\frac{\partial \sigma^{ij(n)}}{\partial \varepsilon_{kl}}$ from the 3D behaviour
- 265 (b) calculate $\langle \delta \varepsilon_{ff} \rangle = - \left[\frac{\partial \sigma^{ee(n)}}{\partial \varepsilon_{ff}} \right]^{-1} \sigma^{ee(n)}$ with $e, f = 2$ and 3 , be-
 266 cause of the double conditions of eq. (5)

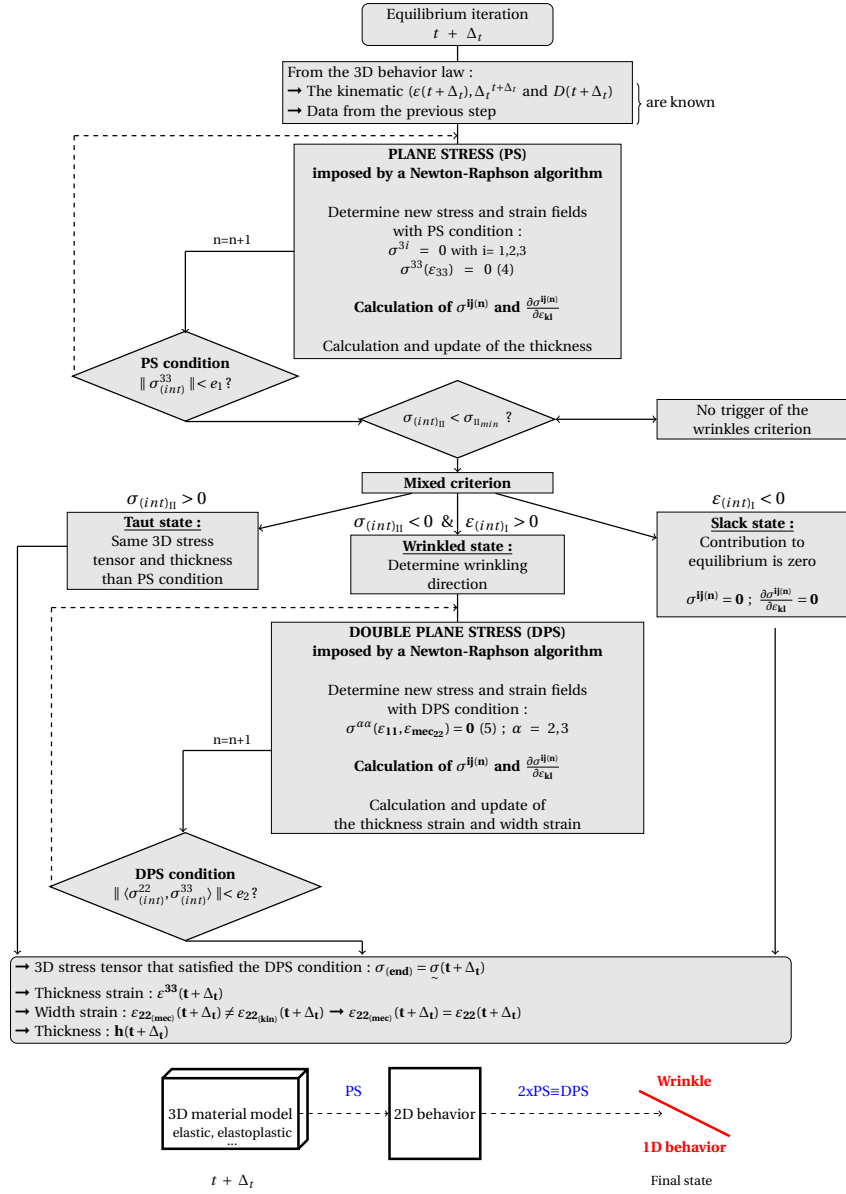

Figure 3: Total algorithm used to model the PS–DPS state with any type of 3D mechanical behaviour.

- 267 (c) then take $\varepsilon_{ff(n+1)} = \delta\varepsilon_{ff} + \varepsilon_{ff(n)}$ and increment n as: $n = n + 1$,
 268 with $f = 2$ and 3
- 269 (d) update the membrane thickness.

270 At the end of the process, after convergence has been reached, which
 271 is denoted $\boldsymbol{\sigma}_{(end)}$, the following data are obtained:

- 272 • the 3D stress tensor $\boldsymbol{\sigma}_{(end)}$ that satisfies the DPS condition (*i.e.*
 273 only one value differs from zero: $\sigma_{(end)}^{11}$).
- 274 • the new thickness strain $\varepsilon_{33(t+\Delta t)}$ and the new thickness $h_{(t+\Delta t)}$ of
 275 the membrane, the transverse mechanical strain $\varepsilon_{22(t+\Delta t)}$ which is
 276 noted $\varepsilon_{22(mec)}$. The difference between the strain $\varepsilon_{22(kin)}$ due to the
 277 kinematic effects and the new $\varepsilon_{22(mec)}$ is the presence of wrinkles.

- 278 3. as with the PS Newton scheme, in the case of an implicit scheme, the
 279 tangent behavioural matrix is also calculated based on: $\frac{\partial\sigma^{11}}{\partial\varepsilon_{11}}$ which
 280 includes the DPS condition. Details of the calculation of the tangent
 281 matrix of the DPS condition are given in appendix B.

282 The shape of the wrinkle is not simulated in the PS–DPS model, *i.e.* the
 283 membrane remains locally plane. The aim of this approach is simply to obtain
 284 the effects of the wrinkles. In this context, the kinematic deformation $\varepsilon_{22(kin)}$
 285 is the global deformation due to the undulation of the wrinkled membrane,
 286 and the mechanical deformation $\varepsilon_{22(mec)}$ is the local behaviour of the material
 287 due to a single tension. $\varepsilon_{22(kin)}$ could be much higher than $\varepsilon_{22(mec)}$ and does
 288 not depend directly on the behaviour of the material, but mainly on the
 289 intensity of the undulation of the wrinkles, which is responsible of the global
 290 equilibrium.

291 *Comment 1.* Let us consider a length l of a membrane strip with a thickness
 292 h_0 and assume that a uniform simple tensile stress is applied along \vec{g}_2 as
 293 described in fig. 1. This stress makes it possible to obtain a unidirectional
 294 tensile state. In this case, wrinkles may appear in the direction \vec{g}_1 on the
 295 membrane. If no condition is imposed in the direction \vec{g}_1 , the mechanical bal-
 296 ance of the wrinkled membrane will be identical to that of the non-wrinkled
 297 structure, and it is possible to have the following cases:

- 298 • If the structure remains flat (no wrinkles), the new thickness and the
 299 width of the membrane will be those corresponding to the initial di-
 300 mensions modified by the strains required to obtain zero transverse
 301 stresses.
- 302 • If the structure undulates, the width in the absence of any particular
 303 conditions along \vec{g}_1 can be arbitrary. In this case, the calculation of the
 304 tensile force required to achieve the balance of the structure creates an
 305 issue since the cross section (the thickness and width) can be arbitrary.

306 In this context, two types of thickness have to be considered:

- 307 1. The physical thickness $h_{(mec)}$ of the undulating membrane. This thick-
 308 ness will decrease with the tensile stress. In this paper, this thickness
 309 is also called the mechanical thickness.
- 310 2. The geometric thickness $h_{(kin)}$, which is associated with the geometric
 311 width of the corrugated strip $l_{(kin)}$ must yield a correct tensile force.

312 The length of the strip l is identical whether the membrane is wrinkled or
 313 not. On the other hand, the section of the non-wrinkled membrane given by
 314 the dimensions $h_{(mec)} \times l_{(mec)}$ must be identical to the section of the wrinkled

315 membrane $h_{(kin)} \times l_{(kin)}$. To obtain an identical volume, it is necessary to
 316 assume that:

$$h_{(kin)} = \frac{h_{(mec)} \times l_{(mec)}}{l_{(kin)}} \quad (6)$$

317 The geometric thickness will therefore tend to increase when wrinkles are
 318 present. This finding is described in the numerical shear test presented in
 319 section 4.1.

320 *Comment 2.* The given precisions e_1 and e_2 may be different. In sections 4
 321 and 5, for example, the values of these parameters are $e_1 = e_2 = 1.10^{-3}$.

322 *Comment 3.* In principle, the PS–DPS model rules out the possibility of
 323 compressive stresses in the structure. In reality, infinitely small compression
 324 forces can accumulate in flexible structures, such as the plastic films used
 325 to make balloons. This admissible compression in the structure depends on
 326 many parameters such as the nature of the material used and its thickness.
 327 It can be observed with numerical simulations using shell elements as in the
 328 validation example tested in section 4.1. In the PS–DPS model, it is also
 329 possible to leave some compression in the structure by using a parameter
 330 named: $\sigma_{II_{min}}$ (see item item 3 of the algorithm in section 2.3). During a
 331 calculation, if the value of $\sigma_{(int)II}$ is less than $\sigma_{II_{min}}$ then the mixed criterion
 332 is activated and all compressive stresses are eliminated. In the numerical
 333 examples presented in section 4.1, the value of the admissible compression is
 334 taken to be a very small value of $\sigma_{II_{min}} = -1.10^{-15}$.

335 *Comment 4.* In section 4, several numerical benchmarks will be simulated.
 336 The PS model presented in section 2.3 will also be compared with the
 337 PS–DPS model for analysing the effects of wrinkles on the local and global
 338 equilibrium.

339 3. The Dynamic Relaxation method

340 The complexity of the numerical modelling of stratospheric balloons is
341 due in particular to the lack of flexural rigidity of the membranes and the
342 occurrence of wrinkles on their surface. During an equilibrium search with
343 a Newton-Raphson type algorithm, a singular stiffness matrix was obtained.
344 Various methods such as the use of a numerical viscosity as in the Abaqus
345 software <49>, for example, have been conventionally used to remove this
346 singularity. With an implicit approach, it is difficult to accurately model
347 the deployment phases which occur while the structures are being inflated;
348 whereas explicit methods are more suitable for dealing with these phases
349 involving large displacements. On the other hand, these explicit methods
350 require a large number of computational steps and the final static balancing
351 of the structure is often very time consuming. For this reason, the Dynamic
352 Relaxation (DR) method has proven to be useful. This method has the ad-
353 vantages of the explicit approach while minimizing the computational times
354 involved. This method, which has also been called pseudo-Dynamic method
355 <44; 45; 52>, has been used by several authors for the simulations of pres-
356 surized balloons <40; 53–56> and wrinkling problems <11; 15>.

357 In line with our previous studies <52; 57; 58>, an original DR method was
358 used here to deal with inflatable structure shape search problems. The main
359 idea underlying the classical DR methods is that a static solution corresponds
360 to the limit case of a damped dynamic system. Starting with the fundamental
361 dynamic equation (eq. (7)), since the mass matrix intervenes only during the
362 transient phase, the idea is to replace its real value by a fictitious value
363 $[M']$, which is optimized with respect to the Courant-Friedrichs-Lewy (CFL)
364 stability condition <59>.

$$[M'] \{\ddot{X}'\} + [C'] \{\dot{X}'\} + R(X, \dot{X}) = 0 \quad (7)$$

365 where $\{\ddot{X}'\}$, $\{\dot{X}'\}$ and $\{X\}$ are the acceleration vector, the velocity and the
 366 position of nodes, respectively. $[C']$ is the fictitious viscous damping matrix
 367 and $R(X, \dot{X})$ stands for the residual internal and external forces. $\{\ddot{X}'\}$ and
 368 $\{\dot{X}'\}$ are regarded fictitious because these terms do not correspond to the
 369 real acceleration and the real velocity of the structure.

370 At convergence, the nodes tend to oscillate around the equilibrium posi-
 371 tion. The introduction of a damping term thus make it possible to approach
 372 the state of static equilibrium. The kinetic or viscous damping have been
 373 classically used for this purpose. These two types of damping stabilize the
 374 structure in very different ways <58>. In the present study, the kinetic
 375 damping method of stabilization, proposed by <44>, with which the overall
 376 balance of the structure can be obtained very quickly, was used.

377 In the case of the kinetic damping, an "undamped" movement is taken
 378 to occur with $[C'] = 0$ and the kinetic energy given in eq. (8) is used:

$$[M']\{\ddot{X}'\} + R(X, \dot{X}) = 0 \quad (8)$$

379 where the term $[M']\{\ddot{X}'\}$ is the generalized expression for the acceleration
 380 forces.

381 In the case of a conservative system, the kinetic energy reaches a maxi-
 382 mum when the potential energy reaches a minimum. However, a minimum
 383 potential energy defines a state closely resembling the state of equilibrium.
 384 At each peak in the kinetic energy, the velocities are reset at zero and the
 385 computation is relaunched starting at the current position. This process,
 386 which consists in freezing the geometrical state of each peak in the kinetic
 387 energy, tends to dampen the oscillations. The addition of an artificial damp-
 388 ing parameter leads the structure to gradually adopt a statically balanced
 389 form. The condition for stopping the calculation is defined by a fixed param-
 390 eter, named ε_{DR} , which corresponds to the equilibrium state of the structure.

391 This parameter is calculated using the relation:

$$\max \left(\frac{\| \text{Residual static} \|_{\infty}}{\| \text{Reactions} \|_{\infty}}, \frac{\text{Kinetic energy}}{\text{Internal energy}} \right) \leq \varepsilon_{DR} \quad (9)$$

392 *Comment.* In section 4, the precision is set at $\varepsilon_{DR} = 1.10^{-4}$ which makes it
 393 possible to make novel comparisons with data in the literature. In section 5, a
 394 numerical test on the inflation of a stratospheric balloon is performed with the
 395 PS–DPS model and a non-linear behavioural law. In this case, the precision
 396 is set at $\varepsilon_{DR} = 5.10^{-3}$. This value is currently used by the CNES in all their
 397 balloon simulations because it gives precise local and global equilibria.

398 To solve the time problem, the method used here is based on the explicit
 399 Centered Finite Differences (CFD) method. The flow of the process is con-
 400 trolled by a fictitious time with an increment which is arbitrarily set at 1.
 401 The fictitious mass matrix is sized so as to satisfy the stability condition of
 402 eq. (10) more closely. For this purpose, a mass matrix calculated from the ef-
 403 fective stiffness matrix is used, based on the Gershgorin theorem <45>. The
 404 mass matrix is updated only at specific times: at the start of the calculation
 405 and possibly after a damping step, which limits the time required to perform
 406 the computation. The mass matrix is calculated here only at the beginning
 407 of the simulation, taking:

$$m_i = \frac{\lambda \Delta t'^2}{2} S_i \rightarrow S_i = \sum_j |K_{ij}| \quad (10)$$

408 where m_i is the mass at node i , $\Delta t'$ is the fictitious time, S_i is calculated
 409 from the matrix K_{ij} which is the local stiffness matrix of each elements. S_i
 410 is calculated by taking the maximum value of the sum of the absolute values
 411 of the stiffness along the three axes of the Cartesian coordinate system. This
 412 maximum is applied in all the three directions. An increase occurs in the
 413 three eigenvalues obtained via the Gershgorin theorem applied locally to

414 each matrix <45>. λ is an adjustable parameter used to compensate for
415 the instability of the schema resulting, for example, to the approximation of
416 Gershgorin's theorem.

417 **4. Numerical experiments**

418 To investigate the performances of the present wrinkling model, several
419 numerical benchmarks are modelled here and compared with data presented
420 in literature.

421 First, by reproducing shear and torsion tests, structures subjected to in-
422 plane loading are studied. The deployment of a square cushion is then carried
423 out in order to test the validity of the model on a structure resembling that of
424 stratospheric balloons. These complementary tests have been frequently used
425 in previous studies on wrinkling models. In some cases, the membrane shifts
426 locally from a wrinkled to a taut state (in torsion and cushion tests). In other
427 cases, the membrane is completely wrinkled (either in one direction or in all
428 directions), as in shear tests. In shear and torsion tests, an isotropic elastic
429 law is used, and these tests are carried out under small strains, as performed
430 in literature. In the case of the inflation of a square cushion, finite strains
431 and elastic behaviour are first tested, but a hyperelastic model is then used to
432 analyse the responses of the PS–DPS model with this non-linear behaviour.

433 *4.1. Rectangular membrane under shear loading*

434 A two-dimensional rectangular membrane under shear loading was first
435 tested. This test has been widely used in the literature <3; 4; 6; 17; 60–62>.
436 The solutions obtained with the PS and PS–DPS models were compared
437 with numerical and experimental results previously obtained with an elastic
438 law.

439 The geometry, loading conditions and material parameters used in this
 440 shear test are presented in fig. 4. A 0.025 mm thick 2D rectangular mem-
 441 brane (the plane of the membrane) measuring 380 mm x 128 mm in the XY
 442 plane was fixed at the lower edge, while the upper edge could move only in
 443 the horizontal direction. The geometry was meshed with 300 linear triangu-
 444 lar membrane elements. These elements include one Gauss point and finite
 445 transformations (*i.e.* large displacements and deformations) were taken into
 446 account. The parameters λ used in the DR method were set at 2.

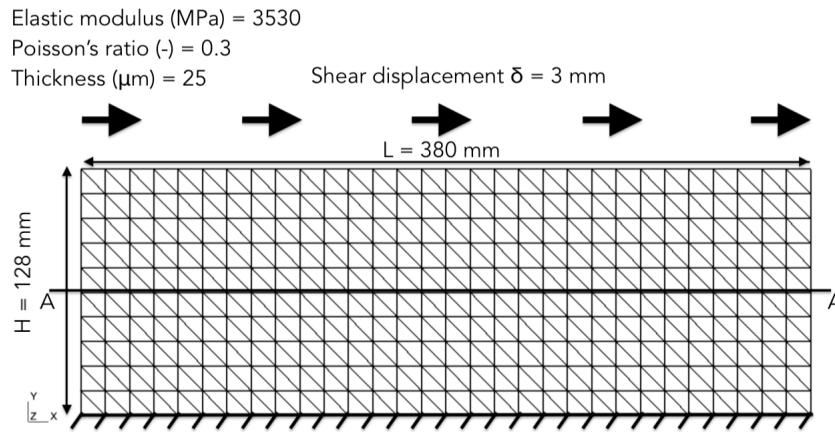

Figure 4: Membrane properties and kinematic boundary conditions in shear test with 300 linear triangular membrane elements performed with the PS and the PS–DPS models.

447 The flat membrane was loaded with a prestress with a magnitude of 1.5
 448 N/mm^2 in the Y –direction to introduce an initial stiffness. The prestress
 449 was then held constant while the upper edge was gradually moved in the
 450 horizontal direction until this movement had covered a distance of +3 mm
 451 (see fig. 4).

452 In order to compare our results with data in the literature, this test was
 453 also simulated with shell elements in Abaqus <49> using the same method
 454 presented by Wong and Pellegrino in <3>. In this case, this simulation was

455 performed by taking 3960 S4R5 shell elements. As with membrane elements
 456 in Herezh++, a 1.5 N/mm^2 prestress was prescribed on the upper side of
 457 the rectangular membrane in order to induce an initial stiffness. After cal-
 458 culating the first buckling modes, the out-of-plane displacements caused by
 459 these modes were imposed like imperfections in addition to the boundary
 460 conditions of displacement of 3 mm in the X -direction. If the shell mesh is
 461 sufficiently fine, this method gives the shape of the wrinkles and eliminates
 462 the compression stresses due to the wrinkles.

463 The shear forces applied to the membrane using the PS, PS-DPS and
 464 shell models are presented and compared in fig. 5a as a function of the shear
 displacement.

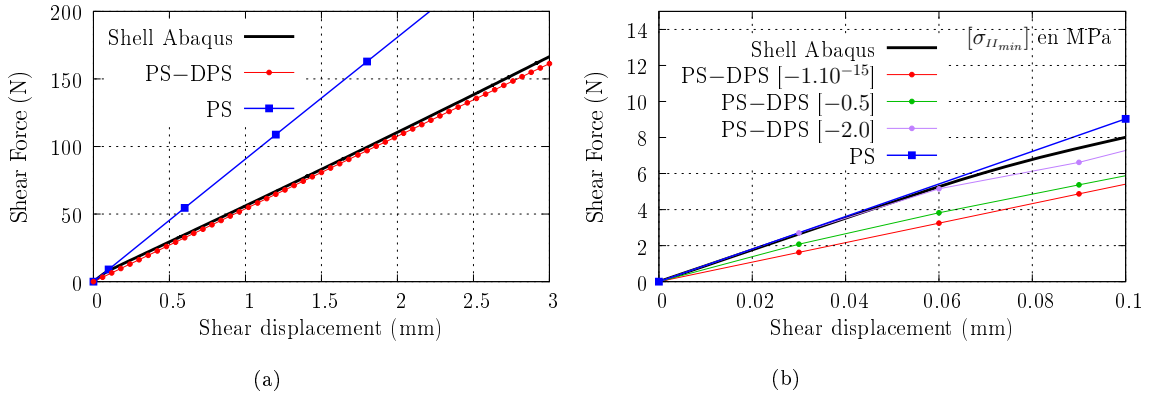

Figure 5: (a) Comparison of shear force/displacement relationships obtained using the shell model, the classical PS membrane model and the PS-DPS wrinkle model. (b) Zoom of the beginning of the shear force/displacement relationship showing the influence of the compressive stress $\sigma_{I_{min}}$ (indicated in brackets) used in the PS-DPS model.

465

466 The initial in-plane shear stiffness of the shell model is approximately
 467 equal to 101 N/mm , which corresponds to the value given by Wong and
 468 Pellegrino. This stiffness obtained with the shell model decreases quickly
 469 at a value of 55 N/mm , showing a similar trend to that observed with the

470 PS–DPS model. This loss of stiffness is due to the development of wrin-
 471 kles on the structure <3>. The PS membrane model does not account for
 472 the softening associated with the formation of wrinkles. Contrary to what
 473 occurs with the shell model, the relationship between force and displace-
 474 ment remains linear with the PS–DPS model, with which no compression
 475 by default can be included in its formulation. However, as explained in the
 476 Comment 3 in section 2.4, it is possible in the PS–DPS model to control the
 477 compressive stress state with the parameter σ_{IImin} . Figure 5b shows the influ-
 478 ence of the compressive stress parameter σ_{IImin} on the initial stiffness at the
 479 beginning of the shear-displacement curve. By default, this value was set at
 480 -1.10^{-15} MPa and in this case, during the initiation of buckling, the stiffness
 481 remains linear, contrary to what is predicted by the shell model. When this
 482 compression stress value is increased to almost 2 MPa, the PS–DPS model
 483 is then reflect the initial decrease in the stiffness, as observed with the shell
 484 model used by Wong and Pellegrino.

485 The principal stresses σ_I and σ_{II} across the middle of the membrane (see
 486 cross section A-A in fig. 4) are plotted in fig. 6a. This distribution of the prin-
 487 cipal stresses is compared with that obtained with the Abaqus shell model
 488 using 3960 S4R5 elements, the membrane model proposed by Deng and Pele-
 489 grino <38> and the PS–DPS model. The PS–DPS model gives results
 490 which are consistent with the Abaqus shell solution and the membrane wrin-
 491 kling model previously studied in the literature. The minor principal stress
 492 σ_{II} is null in all these cases.

493 According to Deng and Pellegrino <38>, the orientation of wrinkles is
 494 equal to 45° at the centre of the membrane. The major principal strain ε_I
 495 and the major principal stress σ_I are exerted in the same direction as the

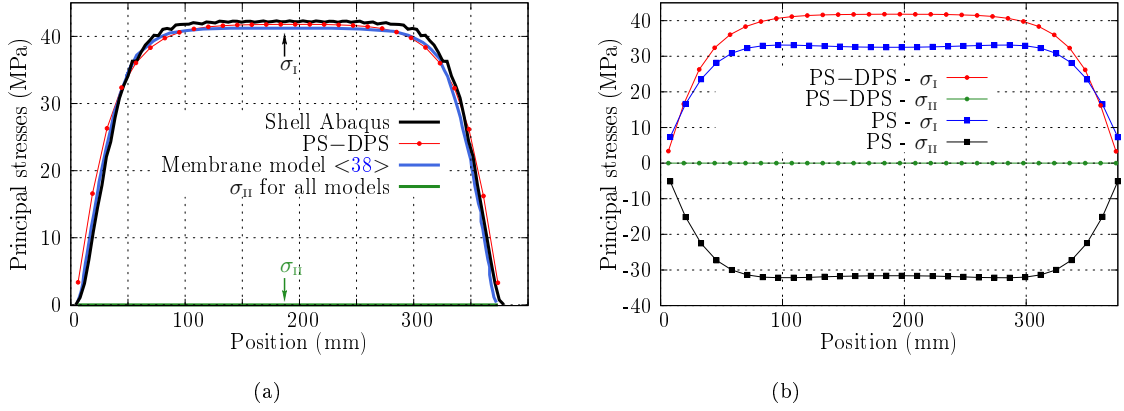

Figure 6: (a) Distribution of the principal stresses σ_I and σ_{II} along the middle of the membrane for the Abaqus shell model, the membrane model presented in <38> and the PS–DPS model. (b) Comparison of these stresses between our PS membrane model and the PS–DPS model.

496 wrinkles. The following equations can be used to determine σ_I in this region:

$$\varepsilon_I = \frac{\lambda}{2} \text{ and } \sigma_I = E \times \varepsilon_I \quad (11)$$

497 where $\lambda = \frac{\delta}{H}$ is the elongation along X , δ is the horizontal displacement
 498 imposed, H is the height of the membrane (see fig. 4) and E is the Young's
 499 modulus.

500 Based on these equations, Wong and Pellegrino <63> have established
 501 that this major principal stress, is equal to 41.37 MPa. With the PS–DPS
 502 model, a value of 41.79 MPa is obtained, amounting to a difference of 1%.
 503 Figure 6b gives the major and minor principal stresses obtained with the PS
 504 and PS–DPS models in order to show the impact of the wrinkles on the local
 505 equilibrium of the structure. With the PS model, the major principal stress
 506 σ_I is lower than in the PS–DPS model, giving a difference of 20.7% and a
 507 minor principal stress of $\sigma_{II} \approx -30$ MPa is obtained. This value of σ_{II} was
 508 also obtained by Jarasjarungkiat et al. <19> with a classical PS membrane
 509 model.

510 As described in section 2.4, the PS–DPS model makes it possible to
 511 account for the wrinkles in a membrane structure without modelling the
 512 out-of-plane displacement. The mechanical strain that the structure actually
 513 undergoes is different from the geometric strain caused by the wrinkles. As
 514 mentioned above, the geometrical thickness $h_{(kin)}$ is due to the presence of
 515 wrinkles and the mechanical thickness $h_{(mec)}$ is equivalent to the physical
 516 thickness. The mechanical and the geometrical thicknesses obtained along
 517 the section of the membrane at the end of the shear test are compared in
 fig. 7.

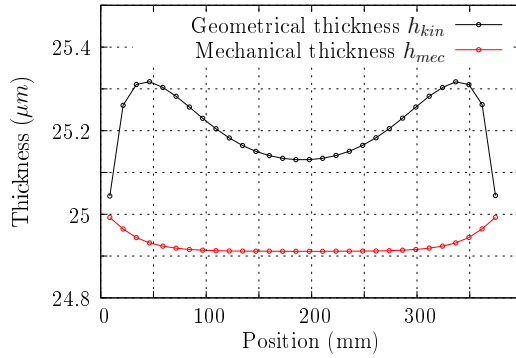

Figure 7: Distribution of the geometrical thickness $h_{(kin)}$ and the mechanical thickness $h_{(mec)}$ along the middle of the membrane in the case of the PS–DPS model.

518

519 The geometrical thickness $h_{(kin)}$ increases in the wrinkled area due to the
 520 out-of-plane movement caused by the formation of the wrinkles, whereas the
 521 mechanical thickness is negative because the membrane is in a uniaxial tensile
 522 state. The distribution of geometric thickness consists of two high peaks
 523 ($h_{(kin)} \approx 25.3 \mu m$) located near the free edges on both sides of the membrane.
 524 The geometrical thickness decreases in the middle of the membrane, but it
 525 is still greater than the initial thickness ($h_{(kin)} \approx 25.1 \mu m$). Similar results
 526 were obtained experimentally by Wong et al. <62> in a study in which they
 527 subjected a rectangular membrane to a state of simple shear. These authors

528 reported that the out-of-plane deflection was greater near to the free edges
529 on both sides of the membrane. In the middle, the out-of-plane displacement
530 decreased and the region was characterised by fairly uniform wrinkles.

531 To conclude this part, although the PS–DPS model is not suitable for
532 modelling the shape of wrinkles, the geometrical thickness is a good indica-
533 tion to the wrinkling pattern in the membrane. This shear test was the first
534 step in the validation of the PS–DPS wrinkle model. The torsion test which
535 will now be described was performed in order to analyse the response of the
536 PS–DPS model under these new loading conditions with an elastic law.

537 *4.2. Torsion test on an annular membrane*

538 In this numerical test, an annular membrane is attached to a rigid hub
539 along the inner edge and to a guard ring along the outer edge as shown in
540 fig. 8. The rotation of the rigid disc causes wrinkling of the membrane <12>.
541 Two tests, classically used in the literature, are simulated: the first is a torsion
542 test without any initial prestress <4; 19> and an initial prestress is added in
543 the second test <7; 27>. In both cases, an analytical solution is presented
544 in <64> and these solutions are also obtained with a Python script. In the
545 case of the prestress torsion test, the membrane shifts locally from a one-
546 directional wrinkled state to a stretched state (devoid of wrinkles). The aim
547 of this prestress torsion test is to determine the robustness of the PS–DPS
548 model when moving from one state to another. The value of parameter λ
549 adopted in the DR method was set at 4 in all these torsion tests.

550 *4.2.1. Torsion without any prestress*

551 In this test, all translations of the outer nodes are fully constrained and
552 the inner rigid disk is rotated clockwise by the angle θ (see fig. 8). The mesh is
553 composed of 180 quadrangular membrane elements with linear interpolation.

Elastic modulus (Pa) = 10^5
Poisson's ratio (-) = 0.45
Thickness (m) = 1.0

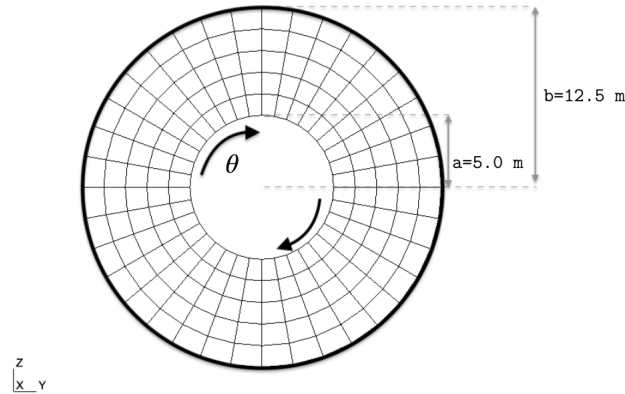

Figure 8: Geometry, physical properties and load at the inner edge of the annular membrane.

554 These elements include four Gauss points and involve finite transformations
555 (*i.e.* large displacements and deformations). The dimensions and loading
556 conditions of the membrane studied here are given in fig. 8 as well as the
557 properties of the linear elastic law used.

558 In the studies by Jarasjarungkiat et al. <4; 19>, the angle θ imposed
559 on the inner rigid disk is 10° . However, with this angle, the strain values
560 obtained are significantly greater than 10% which results relatively large
561 strains. As explained above in the Introduction, the PS–DPS model involves
562 the Almansi strain measure whereas in literature, the Green strain measure
563 has been generally used so far with wrinkle models. As shown in fig. 9, the
564 directions of the major principal stresses are nevertheless compatible with
565 those reported in <12; 65> with an angle of 10° . In order to compare the
566 numerical results obtained with the PS–DPS model and data presented in
567 previous numerical studies, an analytical solution given by Mikulas <64>

568 in the case of small deformations was used with an angle of 0.728° , which
 569 corresponds to a moment equal to 10^5N.m . This small angle makes it possible
 570 to compare data obtained in the case of small rotations with strain fields of
 571 less than 10%.

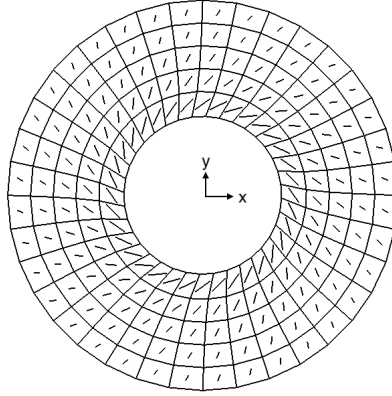

Figure 9: Deformed mesh with representation of the principal stress vectors involving an angle $\theta = 10^\circ$ in the case of a linear elastic material.

572 In this case, wrinkling occurs over the entire membrane as soon as an
 573 angle is applied to the hub. Based on equations given in <64>, it is possible
 574 to compute the stress state in the membrane in two steps.

575 The first step consists in determining the value of the constant C_2 which
 576 satisfies the boundary conditions on the edges of the membrane, according
 577 to the following equation:

$$\frac{1}{\frac{4\pi^2 t^2 C_2^2 a^2}{M^2} - 1} + \log\left(\frac{4\pi^2 t^2 C_2^2 a^2}{M^2} - 1\right) - \frac{1}{\frac{4\pi^2 t^2 C_2^2 b^2}{M^2} - 1} - \log\left(\frac{4\pi^2 t^2 C_2^2 b^2}{M^2} - 1\right) = 0 \quad (12)$$

578 where a is the inner radius, b is the outer radius, t is the membrane thickness
 579 and M is the torque applied.

580 When the constant C_2 is known, the second step consists in calculating

581 the radial σ_r and tangential stresses σ_θ based on the following equations:

$$\begin{cases} \sigma_r = \frac{1}{r} \sqrt{C_2 - \frac{M^2}{4\pi^2 t^2 r^2}} \\ \sigma_\theta = \frac{M^2}{4\pi^2 t^2 r^4} \frac{1}{\sigma_r} \end{cases} \quad (13)$$

582 where r is the radial position in the membrane.

583 To determine the angle of the wrinkles α , as shown in fig. 10, the stress
584 field can be written as follows:

$$\begin{cases} \alpha = \arcsin \left(\frac{M}{2\pi t \sqrt{C_2} r} \right) \\ \sigma_I = \frac{\sigma_r}{\cos^2 \alpha} = \frac{\sigma_\theta}{\sin^2 \alpha} \end{cases} \quad (14)$$

585 This same problem has been solved using TF theory by Reissner <66>,
586 who established that the tension lines start from the inner edge, and because
587 of the symmetry, each of these lines forms along the inner edge the same
angle with the radius from the origin (fig. 10).

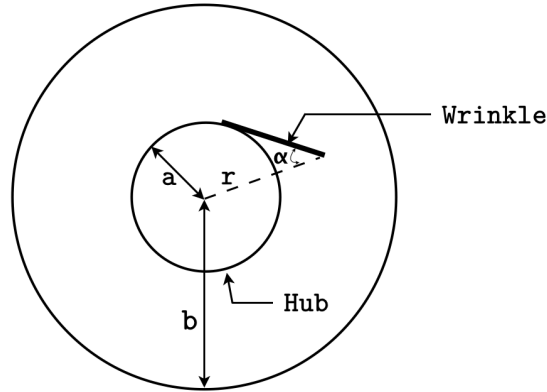

Figure 10: Angles of wrinkles α as described in <64>.

588

589 One simulation was performed with the PS–DPS model with an angle
590 θ equal to 0.728° and compared with this analytical solution, as shown in
591 fig. 11. The results show the evolution of the major principal stress σ_I along

592 the radius of the structure. The PS–DPS model predicts the same evolution
 593 of the decrease of the principal stress along the radius as the analytical so-
 594 lution. The PS–DPS model can be used to simulate a completely wrinkled
 595 membrane state. The next test consists in adding an initial prestress to the
 torsion test.

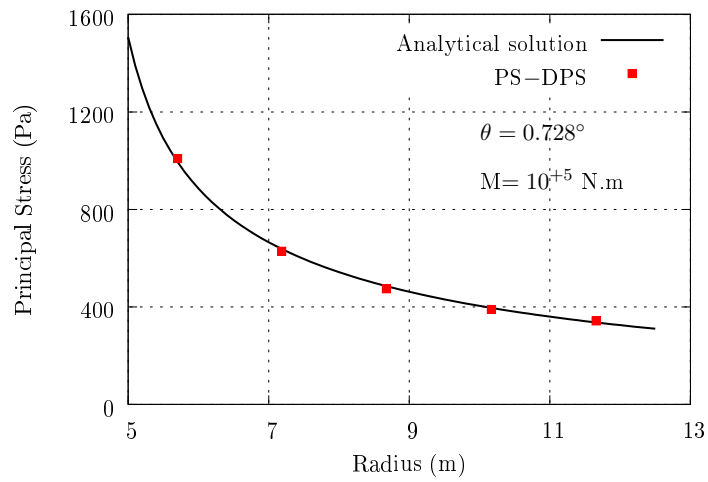

Figure 11: Comparison between the results obtained with the analytical model <64> and the PS–DPS model on the evolution of the major principal stress σ_1 with $\theta = 0.728^\circ$ and 180 quadrangular membrane elements.

596

597 4.2.2. Torsion with prestress

598 The rigid hub was then subjected to a torque loading M and rotated
 599 through an angle ϕ , and this membrane was subjected to a uniform prestress
 600 σ_0 . The geometric and elastic material parameters used in this test are
 601 presented in fig. 12a.

602 When the torsion loading was applied by increasing the moment M , wrin-
 603 kles began to form around the hub up to some radius R , as explained for
 604 example by Akita et al. <27>. The two meshes, described in fig. 12b, with
 605 quadrangular membrane elements, with linear interpolation and four Gauss

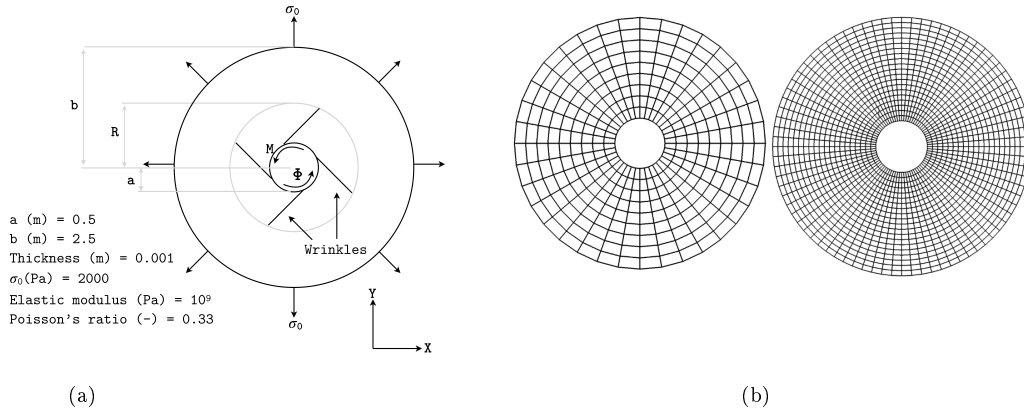

Figure 12: **a)** Dimensions and material properties in the annular membrane test under torque applied to the inner edge with prestress σ_0 . **b)** Coarse (324 elements) and fine (1600 elements) meshes used to simulate this test.

606 points, are tested in order to determine the influence of the finite element
 607 size. The coarse mesh was composed here of 324 elements and the fine mesh,
 608 of 1600 elements.

609 The analytical solution of this problem presented in <64; 67> has been
 610 used by several authors <27; 68>. In this analytical solution, the relation
 611 between the wrinkle radius R and the moment M is given by the following
 612 equations. The quadratic eq. (15) has to be solved to determine the constant
 613 C_1 . This constant C_1 can be used to calculate C_2 with eq. (16). Lastly, we
 614 checked the values of this constant with eq. (17).

$$C_1^2 - \left[1 + 2C_1 \left(\frac{a^2}{b} \right) \right]^2 \bar{R}^4 + \bar{M}^2 = 0 \quad (15)$$

$$C_2 = (\bar{R} + [\frac{1}{\bar{R}} + 2\bar{R}\frac{a^2}{b}])C_1^2 + (\frac{\bar{M}}{\bar{R}})^2 \quad (16)$$

$$\frac{1}{A} + \frac{1}{B} - \ln\left(\frac{B}{A}\right) - \frac{2}{3} = 0 \quad (17)$$

615 where $\bar{M} = \frac{M}{2\Pi\sigma_0 t a^2}$; $A = \frac{C_2}{\bar{M}^2} - 1$; $B = \bar{R}^2 \frac{C_2}{\bar{M}^2} - 1$ in which $\bar{R} = \frac{R}{a}$,
616 R being the radial extent of the wrinkled region, C_1 and C_2 are constants
617 which can be used to calculate the stress field, t is the thickness of the film
618 and a and b are the inner and outer radii, respectively.

619 The relation between the moment M and the twist angle ϕ is given by:

$$\bar{\phi} = \frac{3\bar{M}}{8(1 - \frac{a^2}{b^2})} \left[\frac{\frac{1}{\bar{R}^2} - 1}{B} + \ln\left(\frac{B}{A}\right) + \frac{1}{\bar{R}^2} - \frac{8}{3} \left(\frac{a^2}{b^2}\right) + \frac{5}{3} \right] \quad (18)$$

620 where:

$$\phi = \frac{4\bar{\phi}\sigma_0 \left(1 - \frac{a^2}{b^2}\right)}{3E} \quad (19)$$

621 In the simulation, the angle ϕ determined by eq. (19) is imposed on the
622 inner radius a .

623 The moment applied causes the occurrence of wrinkles on a certain radius
624 denoted \bar{R} . Contrary to the torsion test without any prestress presented in
625 section 4.2.1, the structure falls into two areas. With values of $\bar{R} = 1.2, 1.4$
626 and 1.6, the membrane is in a wrinkled state in one direction and beyond
627 these values, the membrane is stretched. Comparisons are made here only
628 with these values of \bar{R} .

629 After solving the previous equations, the ratios $\frac{\sigma_I}{\sigma_0}$ and $\frac{\sigma_{II}}{\sigma_0}$ between the
630 principal stresses and the prestress (with $\sigma_I > \sigma_{II}$) are given in the wrinkled
631 zone $\bar{r} < \bar{R}$ according to the following relations:

$$\begin{cases} \frac{\sigma_I}{\sigma_0} = \frac{\frac{C_2}{\bar{r}}}{\sqrt{C_2 - \frac{\bar{M}^2}{\bar{r}^2}}} \\ \frac{\sigma_{II}}{\sigma_0} = 0 \end{cases} \quad (20)$$

632 where $\bar{r} = \frac{r}{a}$.

633 These ratios are obtained in the wrinkle-free zone ($\bar{r} \geq \bar{R}$), where:

$$\begin{cases} \frac{\sigma_I}{\sigma_0} = 2C_1 \frac{a^2}{b^2} + 1 + \sqrt{\frac{C_1^2 + \bar{M}^2}{\bar{r}^2}} \\ \frac{\sigma_{II}}{\sigma_0} = 2C_1 \frac{a^2}{b^2} + 1 - \sqrt{\frac{C_1^2 + \bar{M}^2}{\bar{r}^2}} \end{cases} \quad (21)$$

634 Figs. 13a to 14b give the ratios $\frac{\sigma_I}{\sigma_0}$ and $\frac{\sigma_{II}}{\sigma_0}$ as a function of $\bar{r} = \frac{r}{a}$,
635 respectively, with various torques values in the case of coarse and fine meshes.

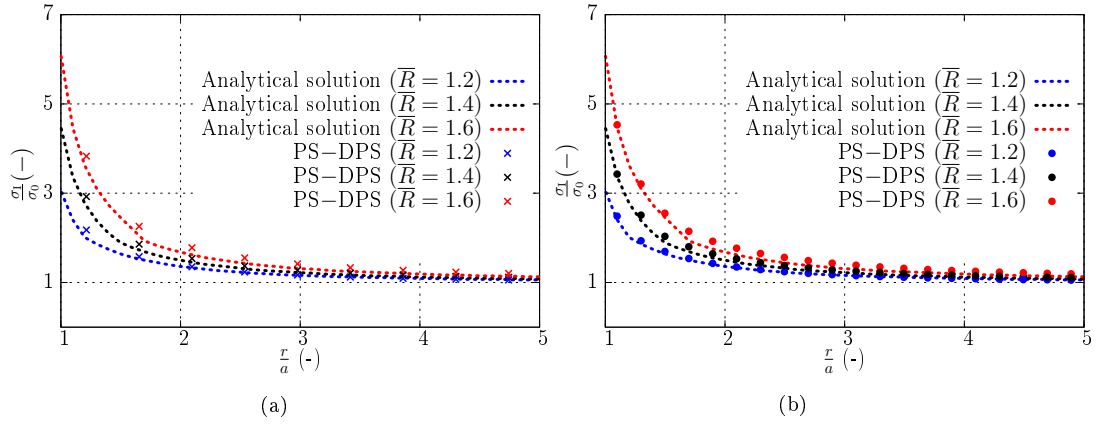

Figure 13: Comparison between the analytical solution and the results obtained with the PS-DPS model for $\frac{\sigma_I}{\sigma_0}$, depending of the radial position $\frac{r}{a}$. (a) Coarse mesh (324 elements). (b) Fine mesh (1600 elements).

636

637 The switch between the wrinkled area and the stretched area is shown
638 in fig. 14. The ratio $\frac{\sigma_{II}}{\sigma_0}$ is equal to zero when the structure is wrinkled,
639 but increases along the radius in the stretched area. Figure 13 shows that
640 the evolution of $\frac{\sigma_I}{\sigma_0}$ is accurately predicted by the PS-DPS model with both
641 coarse and fine meshes. However, in the case of the evolution of $\frac{\sigma_{II}}{\sigma_0}$, the
642 solution obtained with the fine mesh resembles the analytical solution slightly
643 more closely than that obtained with the coarse mesh. In fact, the influence of
644 the mesh is quite weak on the results of this test with the PS-DPS model. The

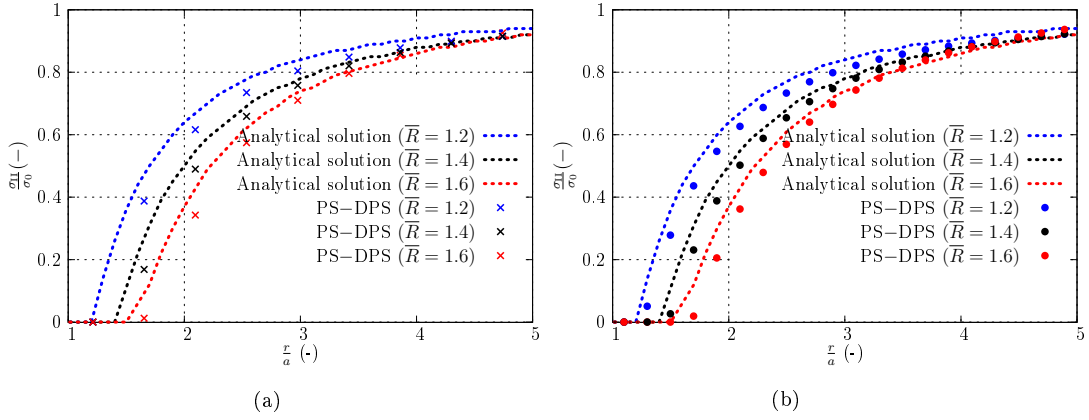

Figure 14: Comparison between the analytical solution and the results obtained with the PS–DPS model for $\frac{\sigma_{rr}}{\sigma_0}$, depending of the radial position $\frac{r}{a}$. (a) Coarse mesh (324 elements). (b) Fine mesh (1600 elements).

645 results here resemble the analytical solutions, even with a mesh composed of
 646 only a few elements, which is not the case with a shell mesh, as observed in
 647 the shear test presented in section 4.1.

648 4.3. Inflation of a square cushion with an elastic law

649 In this example, the efficiency of the PS–DPS model is tested in the case
 650 of an inflatable structure. This test has been extensively studied with an elas-
 651 tic law in the literature <4; 19; 20; 35; 43>. It consists in gradually inflating
 652 a flat square elastic isotropic membrane, increasing the constant pressure up
 653 to 5 kPa. The material properties and dimensions of the undeformed cushion
 654 are given in fig. 15.

655 By applying appropriate boundary conditions in the horizontal mid-plane,
 656 it is only necessary to model one upper quarter of the cushion. This eighth
 657 of the square cushion was simulated with various mesh sizes. The initial
 658 discretization was 4×4 and refined as 5×5 , 8×8 and 10×10 quadrangular
 659 elements with linear interpolation and 4 Gauss points, consecutively. Figs

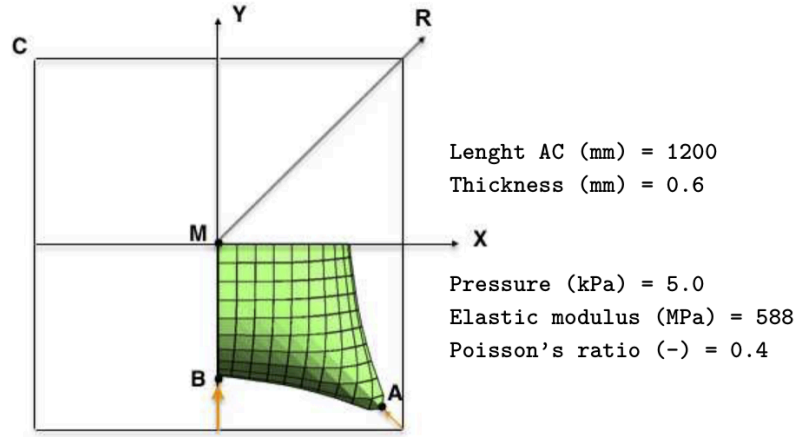

Figure 15: Membrane geometry and material properties of the inflated square cushion test.

660 16a and 16b show the deformed mesh given by the PS–DPS and PS models,
 661 respectively (showing the symmetrical parts of the meshes). The parameter λ used in the DR method was set in this case at 1.5.

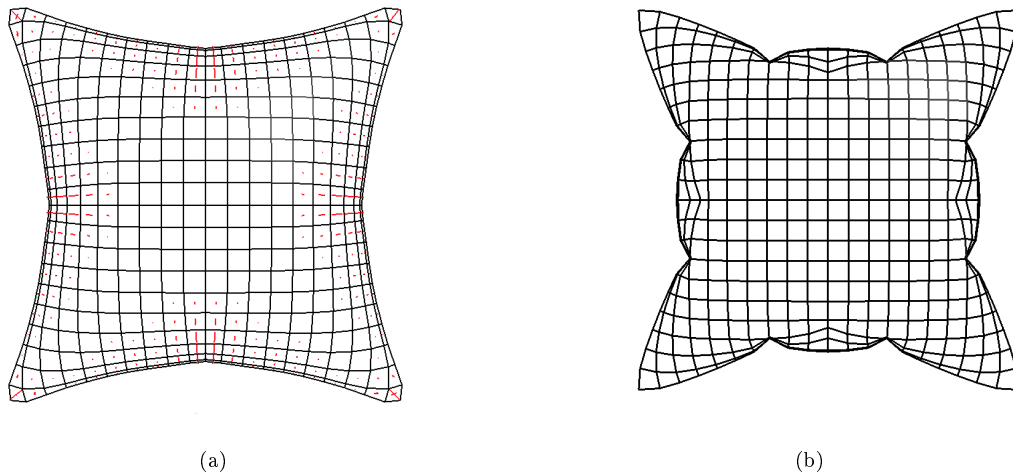

Figure 16: Deformed shape of the inflated square cushion testes at a pressure of 5 kPa with a mesh consisting of 5×5 elements. (a) With the PS–DPS model showing the wrinkled zones (in red). (b) With the PS model without taking the wrinkles into account.

662

663 Previous authors have compared four quantities: the distribution of the
 664 stresses along in the direction X , the major principal stress and the vertical
 665 displacement occurring in the centre M and the displacement in the direction
 666 Y at point B (see fig. 15). The results obtained with PS–DPS model were

667 compared with data previously published in the literature <4; 19; 20; 35; 43>
668 and simulations performed using the "No compression" model implemented
669 in Abaqus. This model approaches the elastic behaviour by first solving for
670 the principal stresses assuming linear elasticity and then setting the appro-
671 priate principal stress values to zero. The associated stiffness matrix compo-
672 nents were also set at zero. "No compression" model can be rather unstable,
673 which explains why convergence problems are liable to occur.

674 In figs 17a and 17b, data obtained in previous studies and those obtained
675 with the PS–DPS model are compared in terms of the displacement of points
676 M and B . The results obtained with the PS–DPS model are almost identical
677 to those obtained with the models presented in <4; 19; 20; 35; 43>. These
678 figures show that the shape of the cushion is accurately predicted at points M
679 (in the stretched area) and B (in the wrinkled area) by the PS–DPS model.
680 Note that the "No compression" Abaqus model gives strange displacements
681 at point B in the wrinkled area, as previously reported by Contri and Schre-
682 fler <35>. These models involve the used of a static implicit scheme to solve
683 the wrinkling problem. An equilibrium position of the membrane is first de-
684 termined with active compressive stresses and tensile stresses. If at least one
685 such principal stress is found to be compressive in an element, a new stress
686 state with only the tensile stresses active is obtained. These models do not
687 seem to be as effective as the PS–DPS model.

688 In fig. 18a, the major principal stress σ_1 occurring at point M , depending
689 of the mesh size used, is compared with results obtained in <19; 43>. The
690 stress states predicted with the PS–DPS model show good agreement with
691 these previous data. Figure 18b shows the evolution of the stresses σ_{11} and
692 σ_{22} in the direction X in the cushion predicted by the PS–DPS model and
693 the membrane model presented by Lee et al. <11>, in the only study in

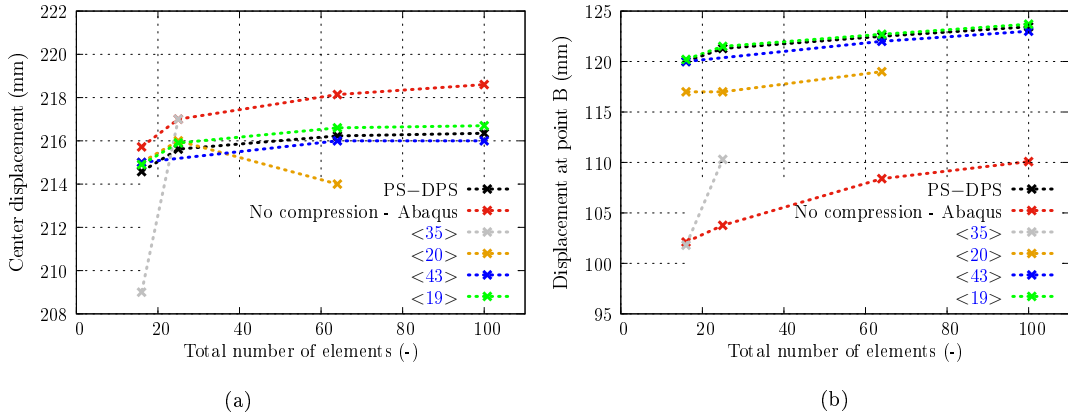

Figure 17: Displacement at the centre (point M) (a) and point B (b) predicted with various mesh sizes (4×4 , 5×5 , 8×8 and 10×10 elements) in comparison with data obtained in <4; 19; 35; 43>, the "No compression" model and the PS–DPS model.

694 the literature to deal with this evolution. The results give a picture of the
695 wrinkling behaviour and the tensile area in the cushion. σ_{22} is equal to zero
696 and σ_{11} is almost equal to 1.5 MPa in the wrinkled area. In the taut area,
697 the values of σ_{22} and σ_{11} both increase. The values of σ_{22} and σ_{11} are equal
698 in the centre of the cushion (position ≈ 25 mm). The stress field predicted
699 with the PS–DPS model is similar to that obtained in previous studies.

700 This test finishes the validation section of the PS–DPS model with a
701 linear elastic law in comparison with literature cases. These previous tests
702 showed the ability of the PS–DPS model to account for the formation of
703 wrinkles in flexible structures. The tests described in the next section were
704 performed on the PS–DPS model with a non linear law in order to determine
705 the effects of the mechanical behaviour on the shape of the cushion and the
706 local equilibrium.

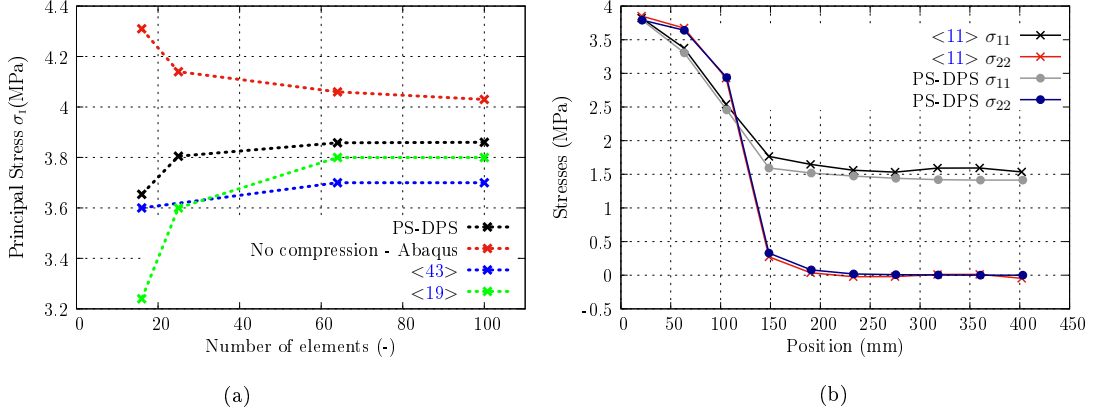

Figure 18: (a) Major principal stress σ_1 at point M with meshes consisting of 4×4 , 5×5 , 8×8 and 10×10 elements in comparison with data presented in previous studies <19>, <43>, the "No compression" model and the PS–DPS model. (b) Comparison between the stresses σ_{11} and σ_{22} occurring in the X direction of the cushion obtained in <11> and with the PS–DPS model.

707 4.4. Inflation of a square cushion with a non-linear law

708 Stratospheric balloons are made of very fine plastic films showing complex
709 mechanical behaviour. In order to approach this non linear behaviour, a
710 simulation was performed on the inflation of a square cushion using the
711 PS–DPS model and the original hyperelastic law initially defined by Favier
712 et al. <69>. This hyperelastic part was previously used in a study of Zrida
713 et al. <70> to simulate the behaviour of polymers.

714 The hyperelastic potential W involved in this law was defined on the basis
715 of four material parameters, using the invariants of the Almansi measure ϵ
716 according to the relation:

$$W = \frac{K}{6} \ln^2(V) + \frac{Q_{0r}^2}{2\mu_0} \ln \left(\cosh \left(\frac{2\mu_0 Q_\epsilon}{Q_{0r}^2} \right) \right) + \mu_\infty Q_\epsilon^2 \quad (22)$$

717 where in the case of a shear test, μ_∞ denotes the final slope of the stress
718 τ -strain γ curve, $\mu_0 + \mu_\infty$ denotes the initial slope τ versus γ and Q_{0r} stands

719 for the level of the final tangent to the curve (*i.e.* the intersection between
720 the final tangent and the vertical stress axis) (for details of these material
721 parameters, see fig. 19). K is the bulk modulus, on which the changes in
722 volume mainly depend. V stands here for the relative changes in volume and
723 Q_ε denotes the intensity of the deviatoric part of ε :

$$Q_\varepsilon = (2\bar{\mu}_\varepsilon)^{1/2} \quad \text{with} \quad \bar{\mu}_\varepsilon = \frac{1}{2} \text{trace}(\varepsilon \cdot \varepsilon) - \frac{(\text{trace}(\varepsilon))^2}{6} \quad (23)$$

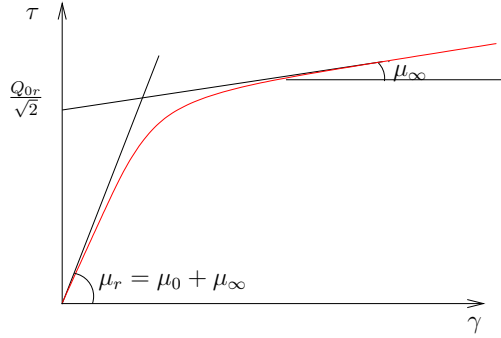

Figure 19: Material parameters involved in the hyperelastic law proposed by Favier et al. <69; 70> during a pure shear test.

724 To determine the influence of this behavioural law, numerical comparisons
725 were performed on the displacement of the cushion and its stress distribution
726 in the case of both this non linear evolution and an equivalent elastic law.
727 The stress-strain curves obtained with both of these two laws are presented
728 in fig. 20 and compared with those obtained a uniaxial tensile test performed
729 in <71> at a strain-rate of 3.6%/min on a film with the same thickness as
730 that of which this cushion was made.

731 The material parameters involved in these two laws are presented in ta-
732 ble 2. Contrary to the test on a cushion described in section 4.3, a pressure
733 of 2 kPa was applied here to a square cushion 2000 mm in length and 0.25
734 mm thick. Due to the symmetry, only an eighth of the square was simulated.

735 These simulations were performed with a mesh consisting of 15×15 quadran-
736 gular elements, using linear interpolation methods. The value of parameter
 λ involved in the DR method was set at 3.

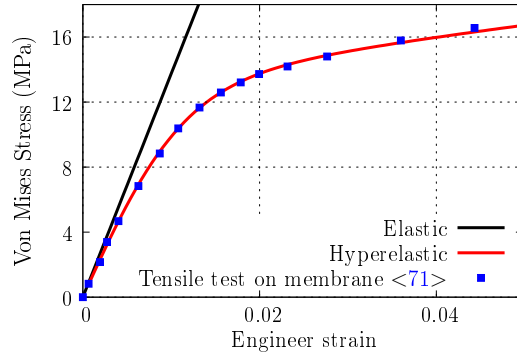

Figure 20: Comparison between the elastic and hyperelastic responses during a uniaxial tensile test presented in <71>.

737

Elastic parameters		Favier's Hyperelastic parameters			
E (MPa)	ν	K (MPa)	Q_{or} (MPa)	μ_r (MPa)	μ_∞ (MPa)
1375	0.4	3000	10.5	430	35

Table 2: Material parameters of the elastic and hyperelastic laws used to simulate the inflation of a cushion.

738 The global equilibria obtained with the two laws can be compared in
739 Figure 21a. This figure gives the vertical displacement of the symmetrical
740 horizontal line of the cushion at the end of the inflation. The shape of the
741 cushion is almost identical with both the elastic and hyperelastic laws. The
742 evolution of the major principal stress σ_1 along the symmetrical horizontal
743 line of the cushion is presented in fig. 21b. The non-linearity of the hyper-
744 elastic law results in a different pattern of stress distribution, especially in
745 the centre of the cushion. However, it is worth noting that the location of

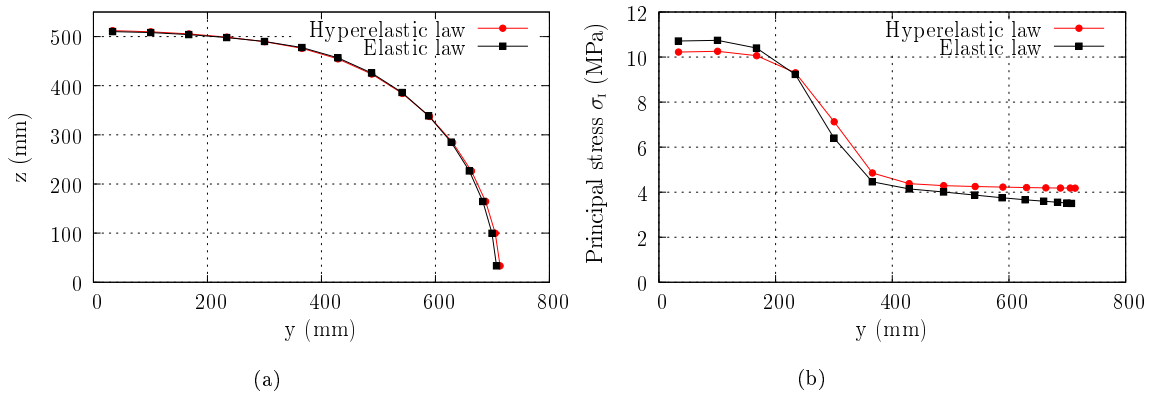

Figure 21: (a) Vertical displacement and (b) Evolution of the major principal stress σ_1 along the symmetrical horizontal line of the cushion with elastic and hyperelastic laws.

746 the wrinkles is independent of the constitutive law used. Their location is
 747 similar to that previously observed in fig. 16a.

748 5. Application of the PS–DPS model: Zero Pressure Balloon in- 749 flation

750 In this section, the inflation of a Zero Pressure Balloon (ZPB) is simu-
 751 lated using the PS–DPS model both with an elastic law and with the same
 752 hyperelastic law as in the previous section.

753 During stratospheric missions, the volume of these balloons depends on
 754 their altitude (see fig. 22.a). These variations are caused by changes of tem-
 755 perature and pressure inside the balloons. At the start of the take-off and
 756 throughout these missions (see fig. 22.b), the wrinkles on the balloon con-
 757 tinue to evolve. Accounting numerically for wrinkles in these structures is
 758 particularly important because the gas pressure, which depends on the vol-
 759 ume of the balloon, affects the stress field. The DR method has often been
 760 used to simulate these inflation and wrinkle processes <40; 53–56>.

761 To test the validity the operation of the model and investigate the impact

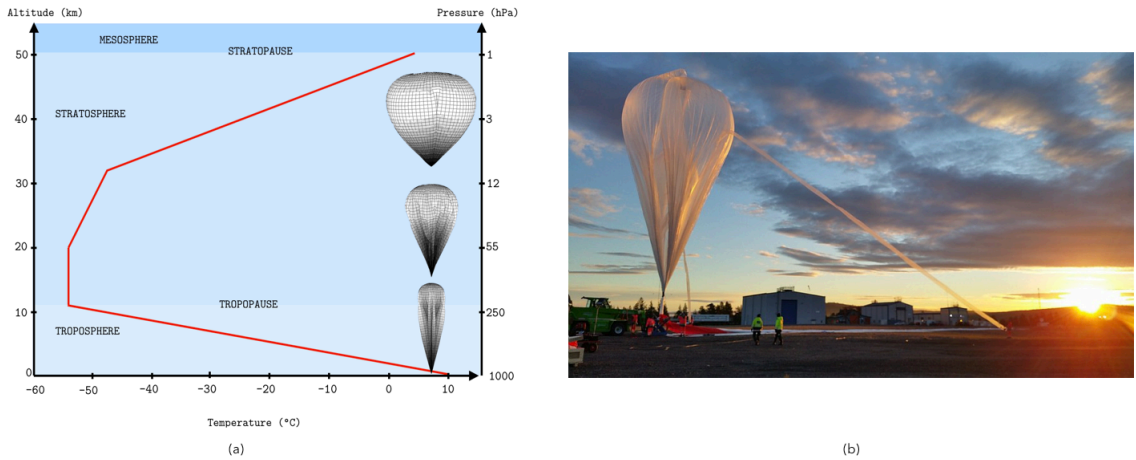

Figure 22: (a) Evolution of the pressure and temperature during a flight mission. (b) Photo of a ZPB before take-off <72>.

762 of wrinkles on a real structure, equilibrium configurations were calculated
 763 during all the phases of a ZPB flight (during take-off and flight, depending
 764 on the altitude and the internal pressure) using both elastic and hyperelastic
 765 laws. The numerical conditions used in the simulations are presented in
 766 fig. 23 and table 3.

767 The ZPB is composed of 74 gores, but only one gore of the balloon was
 768 simulated, and conditions of cyclic symmetry were imposed on the edges of
 769 the gore in order to account for this hypothesis. The gores, which are made
 770 of an LLDPE film, are assembled with polyester fiber reinforced tapes. In
 771 the case of these large-sized balloons, the main load to be simulated is the
 772 pressure gradient Δp in the balloon, which reflects the effects of the gas on the
 773 film. This gradient is calculated by subtracting the pressure in the balloon
 774 from the external pressure. It depends on the balloon's altitude z , which is
 775 an input parameter in the simulation and the thickness h of the film. The
 776 weight of the film and that of the tapes is accounted for in the simulations by
 777 a loading gravity condition. The mass of the pole piece (9.2 kg) is significant

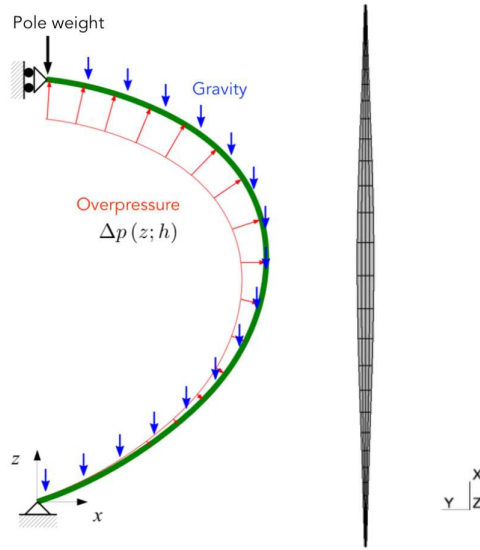

Figure 23: Mesh and loads applied during the ZPB simulations <73>.

Properties	Film	Tapes
Young's modulus (MPa)	1883	5986
Thickness h (μm)	25	-
Poisson's ratio	0.45	0.3
Density ρ (kg/m^3)	913	830

(a) Film's and tapes' elastic properties

Favier's hyperelastic parameters of the film			
K (MPa)	Q_{or} (MPa)	μ_r (MPa)	μ_∞ (MPa)
1000	18.95	614.17	0.6

(b) Hyperelastic parameters used to model the film

Table 3: Material properties of the film and tapes.

778 since it affects the shape of the balloon, and it is therefore simulated here in
 779 terms of its weight in the form of vertical point forces applied to the nodes
 780 at the end of the gore. These various loads and the mesh used are presented

781 in fig. 23. This mesh is composed of 120 quadrangular elements with linear
782 interpolation, and 90 bar elements with linear interpolation stand for the
783 assembly tapes. These tapes are located in the middle of the gore with an
784 equivalent section of 9.586 mm². The contact between film and tapes is
785 assumed to be perfect.

786 To simulate all the phases in the ZPB inflation process, two stages are
787 defined:

- 788 1. The first stage consists in inflating the gore by applying the hydrostatic
789 pressure gradually until the maximum altitude of 32.5 km is reached.
790 During this phase, the boundary conditions for the hook and pole are
791 applied but not the conditions of cyclic symmetry. The parameter λ in
792 the DR method is set at 0.6. To speed up the calculation time, only
793 the PS model is used at the start of the calculation. At the end of this
794 step, the PS–DPS model is activated.
- 795 2. The second stage consists in applying the conditions of cyclic symme-
796 try by means of linear boundary conditions. During this stage, the
797 parameter λ is set at 2 and 12 with the elastic and hyperelastic law,
798 respectively.

799 *Comment 1.* The initial configuration is the flat shape of the gore.

800 *Comment 2.* The parameter λ involved in the DR method is greatly increased
801 in the case of the hyperelastic model because the non-linear part gives rise
802 to many kinetic peaks at the end of the simulation.

803 Figure 24a shows the shape of the balloon with the PS and PS–DPS
804 models in the case of elastic behaviour and with the PS–DPS model using
805 the hyperelastic model. The overall shape of the gore differs slightly between
806 the models tested because modelling a single gore of the balloon constrains

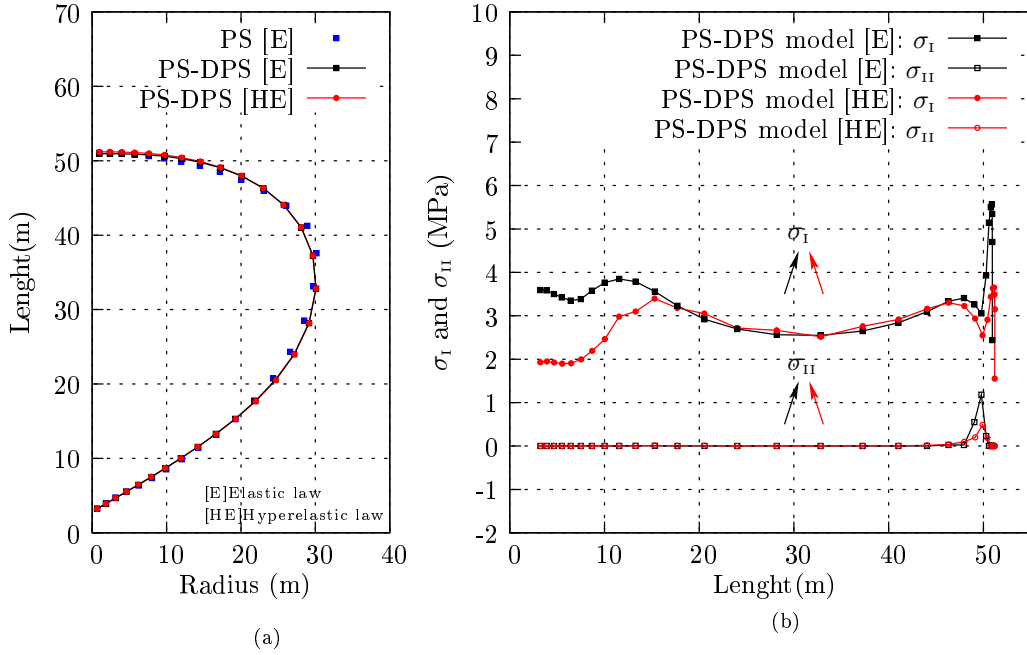

Figure 24: (a) Comparison on the ZPB shape between the PS and PS–DPS models, depending on the behavioural laws used. (b) Comparison on the local stress equilibrium in the ZPB between the elastic law [E] and the hyperelastic law [HE] with the PS–DPS model.

807 the shape of the final gore, which results in a slight difference in the overall
808 shape depending on the type of law used. The major and minor principal
809 stresses $\sigma_{I_{max}}$ and $\sigma_{II_{min}}$ in all the gores are presented in table 4. Contrary to
810 the shape, the stress field differs considerably between the PS and PS–DPS
811 models. During these simulations, the ZPB is not very heavily loaded me-
812 chanically. However, contrary to results obtained with the PS–DPS model,
813 stress patterns obtained with the PS model are greatly disturbed by the
814 presence of wrinkles on the balloon, which shows that taking these wrinkles
815 into account greatly affects the simulations. The distribution of the major
816 and minor principal stresses along the middle of the gore with the PS–DPS
817 model are presented in fig. 24b. The stress levels obtained with the elastic

818 and hyperelastic laws are very low in these cases. However, the top and
 819 bottom of the balloon are the places where the films are the most heavily
 loaded, and where the influence of the constitutive law is the strongest.

	Elastic law		Hyperelastic law
	PS model	PS–DPS model	PS–DPS model
σ_{IImin} (MPa)	-1820.	0.	0.
σ_{IImax} (MPa)	115	5.56	3.65
Computation time for one iteration in the second stage (s/it)	0.150	0.542	1.097

Table 4: Major and minor principal stresses obtained in all the surface of the ZPB with the PS and PS–DPS models. Impact of the behavioural law used on the computational time in the case of a balloon.

820

821 The results of the stress fields presented in the table 4 and the figure 24b
 822 are in adequacy with the numerical results of the balloons of the same types
 823 <74; 75>. However, the materials, the number of balloon gores, the tapes
 824 assemblies used and the weight carried during a mission make comparisons
 825 between studies difficult.

826 Figure 25 shows the kinetic energy versus the iterations performed during
 827 the final stage in the calculations (pressure at the altitude targeted, activation
 828 of the wrinkling model in two cases). With the PS model, the evolution of
 829 the kinetic energy is very pronounced between each peak. Table 4 shows
 830 the time required by the two models to perform an iteration in this final
 831 stage. In the case of the PS model, this time was 0.15 s in the case of the
 832 elastic law, but 3.6 times longer in that of the PS–DPS model. However,
 833 contrary to the PS–DPS model, a larger number of iterations was necessary

834 to reach convergence with the PS model, but the time required was very short
 835 due to the simplicity of the elastic law used. When the balloon is inflated
 836 without using the wrinkling model, the local stress field is very noisy because
 837 of the presence of these wrinkles. Balancing these internal stresses can be
 838 detrimental to the convergence with the PS model, whereas the number of
 839 iterations required to reach convergence is much smaller with the PS–DPS
 model.

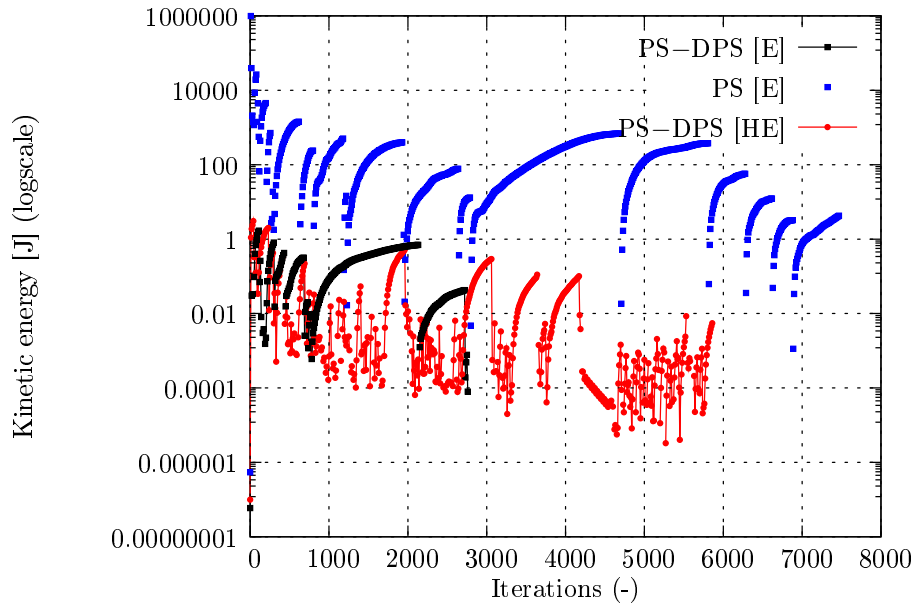

Figure 25: Evolution of the kinetic energy in the last step of the calculations in the case of the PS–DPS model with an elastic law and a hyperelastic law and that of the PS model with an elastic law.

840

841 The use of the non-linear hyperelastic law and the PS–DPS model yielded
 842 many peaks in the kinetic energy. The evolution of the kinetic energy between
 843 peaks was less visible than with the other models with a linear law. However,
 844 despite the increase observed in the λ factor (which increased by 6 fold in
 845 comparison with the elastic law), the simulation was still rather unstable.
 846 The calculation time required for each iteration was twice as long as with

847 the PS–DPS model with an elastic law. During this simulation, the kinetic
848 damping used in the DR algorithm was found to slow down the convergence.
849 In fact, a large number of kinetic energy peaks was always observed, especially
850 at the end of the calculation. This somewhat chaotic nature of the kinetic
851 damping may be increased by the non-linear law used to simulate the film.
852 These results therefore show that the long computational times are mainly
853 due to the complexity of the non-linear law used in this case, which also gives
854 rise to convergence problems

855 These simulations point to the conclusion that the use of the PS–DPS
856 and PS models is indicated on real-life structures. They show that the local
857 stresses at work in the structure are more intense and differently distributed
858 when complex behavioural laws are used in the simulations. In the context
859 of stratospheric balloons, the use of a non-linear model resembling real-life
860 behaviour more closely is essential to the successful design and development
861 of these structures. The possibility of using a wrinkling model with more
862 complex constitutive laws provides the most reliable means of predicting
863 balloons’ process of inflation during their missions.

864 **6. Conclusion and outlook**

865 A new wrinkling model named the PS-DPS model, which can be used with
866 non-linear behaviour of all kinds is presented here. This model, based on the
867 Almansi strain involves the use of a pseudo-Dynamic Relaxation method to
868 determine the shape of flexible structures. Two plane stress conditions are
869 imposed to simulate the wrinkled part in a state of uniaxial tension on the
870 plane of the membrane. This model was first tested with a linear elastic
871 behavioural law on numerical data in the literature in order to check its effi-
872 ciency in classical cases. Lastly, the PS-DPS model was used to simulate the

873 inflation of a zero pressure balloon and found to be compatible with complex
874 laws such as non-linear hyperelastic behavioural laws on real-life structures.
875 A constitutive model of this kind was found to be the most suitable for de-
876 scribing the mechanical behaviour of the films of which stratospheric balloons
877 are made.

878 Further studies on the PS-DPS model are also under way in order to
879 improve its responses when used with incremental anisotropic laws. Another
880 drawback observed when the pseudo-Dynamic Relaxation method was used
881 with complex constitutive laws is that the time to convergence required to
882 determine local equilibria is very long. In addition, with the wrinkling model,
883 the computational time tends to be slightly longer than with a so-called
884 conventional membrane model. It is therefore now proposed to develop new
885 numerical strategy in future studies in order to reduce the computational
886 time requirements of the model, especially when a complex behavioural law
887 is used

888 **CRedit author statement**

889 **H. Le Meitour:** Validation, Investigation, Formal analysis, Writing -
890 original draft. **G. Rio:** Conceptualization, Methodology, Investigation, Soft-
891 ware, Writing - review & editing, Supervision. **H. Laurent:** Investigation,
892 Writing - review & editing, Visualization, Resources, Funding acquisition,
893 Supervision. **A. S. Lectez:** Data Curation, Resources, Writing - review &
894 editing, Supervision. **P. Guigue:** Project administration, Funding acquisi-
895 tion, Supervision.

896 Acknowledgements

897 This research was supported by the CNES (team DSO/BL/VP),
898 the company CNIM AIR SPACE and the Brittany Region
899 (MITOFORM:0461/ARE11219/00030953) under contract N° 2840-
900 2841/2017-00721. The authors would like to thank Julien Troufflard
901 (a freelance engineer) and Frank Petitjean from the company [RTIME](#) for
902 their useful suggestions and discussions.

903 Appendices

904 To clarify the following calculations of the tangent matrices, the following
905 notations have been introduced: "3D" for the general 3D behaviour, "PS"
906 for the specific 2D Plane Stress and "DPS" for the specific 1D Plane Stress
907 when wrinkles occur.

908 A. Calculation of the tangent matrix in the PS model

909 When modelling the membrane, the plane stress condition has to be al-
910 ways satisfied, that is: $\sigma_{PS}^{33}(\varepsilon_{33}) = 0$. The differential therefore also has to
911 be zero: $d\sigma_{PS}^{33}(\varepsilon_{33}) = 0$

Due to the method used to enforce the plane stress, the $\varepsilon_{33(t+\Delta t)}$ obtained
is in fact an implicit function of the in-plane deformations $\varepsilon_{\gamma\eta}$ where $\gamma, \eta =$
1 and 2 and we can write:

$$0 = \frac{\partial \sigma^{33}}{\partial \varepsilon_{\gamma\eta}}(PS) = \frac{\partial \sigma^{33}}{\partial \varepsilon_{\gamma\eta}}(3D) + \frac{\partial \sigma^{33}}{\partial \varepsilon_{33}}(3D) \frac{\partial \varepsilon_{33}}{\partial \varepsilon_{\gamma\eta}}$$

which leads to the relations:

$$\frac{\partial \varepsilon_{33}}{\partial \varepsilon_{\gamma\eta}} = - \left[\frac{\partial \sigma^{33}}{\partial \varepsilon_{33}}(3D) \right]^{-1} \frac{\partial \sigma^{33}}{\partial \varepsilon_{\gamma\eta}}(3D)$$

which are used to obtain the tangent matrix (where $\alpha, \beta = 1$ and 2):

$$\frac{\partial \sigma^{\alpha\beta}}{\partial \varepsilon_{\gamma\eta}}(PS) = \frac{\partial \sigma^{\alpha\beta}}{\partial \varepsilon_{\gamma\eta}}(3D) + \frac{\partial \sigma^{\alpha\beta}}{\partial \varepsilon_{33}}(3D) \frac{\partial \varepsilon_{33}}{\partial \varepsilon_{\gamma\eta}}$$

912 B. Calculation of the tangent matrix in the PS-DPS model

913 The general expression for the tangent matrix is:

$$\frac{\partial \sigma^{ef}}{\partial \varepsilon_{kl}}(DPS) = \frac{\partial \sigma^{ef}}{\partial \varepsilon_{kl}}(3D) + \frac{\partial \sigma^{ef}}{\partial \varepsilon_{gh}}(3D) \frac{\partial \varepsilon_{gh}}{\partial \varepsilon_{kl}} \quad (24)$$

where $e, f = 2$ and 3. The degrees of freedom of the DPS condition in the present case are ε_{ee} , where $e = 2$ and 3. In this context, the relevant unknowns in relation (24) are the values of $\frac{\partial \varepsilon_{ee}}{\partial \varepsilon_{11}}$. We use the conditions $\sigma^{ee} = 0$ that must always be satisfied in DPS to calculate these values :

$$\frac{\partial \sigma^{ee}}{\partial \varepsilon_{11}}(DPS) = 0 = \frac{\partial \sigma^{ee}}{\partial \varepsilon_{11}}(3D) + \frac{\partial \sigma^{ee}}{\partial \varepsilon_{ff}}(3D) \frac{\partial \varepsilon_{ff}}{\partial \varepsilon_{11}}$$

and hence:

$$\frac{\partial \varepsilon_{ff}}{\partial \varepsilon_{11}} = - \left[\frac{\partial \sigma^{ee}}{\partial \varepsilon_{ff}}(3D) \right]^{-1} \frac{\partial \sigma^{ee}}{\partial \varepsilon_{11}}(3D)$$

The final tangent operator can then be calculated as follows:

$$\frac{\partial \sigma^{11}}{\partial \varepsilon_{11}}(DPS) = \frac{\partial \sigma^{11}}{\partial \varepsilon_{11}}(3D) + \frac{\partial \sigma^{11}}{\partial \varepsilon_{ff}}(3D) \frac{\partial \varepsilon_{ff}}{\partial \varepsilon_{11}}$$

914

915 **References**

- 916 [1] C. H. Jenkins, Nonlinear Dynamic Response of Membranes: State of
917 the Art - Update, *Appl. Mech. Rev* 49 (10S) (1996) S41–S48. doi:
918 [10.1115/1.3101975](https://doi.org/10.1115/1.3101975).
- 919 [2] A. Adler, M. Mikulas, Application of a wrinkled membrane finite element
920 approach to advanced membrane structures, *American Institute of Aero-*
921 *navics and Astronautics*. (Aug. 2001). doi:[10.2514/6.2001-4646](https://doi.org/10.2514/6.2001-4646).
- 922 [3] W. Wong, S. Pellegrino, Wrinkled membranes III: numerical simulations,
923 *Journal of Mechanics of Materials and Structures* 1 (1) (2006) 63–95.
924 doi:[10.2140/jomms.2006.1.63](https://doi.org/10.2140/jomms.2006.1.63).
- 925 [4] A. Jarasjarungkiat, R. Wüchner, K. U. Bletzinger, A wrinkling model
926 based on material modification for isotropic and orthotropic membranes,
927 *Computer Methods in Applied Mechanics and Engineering* 197 (6)
928 (2008) 773–788. doi:[10.1016/j.cma.2007.09.005](https://doi.org/10.1016/j.cma.2007.09.005).
- 929 [5] S. Kumar, S. H. Upadhyay, A. C. Mathur, Wrinkling Simulation of
930 Membrane Structures under Tensile and Shear Loading, *Journal of Vi-*
931 *bration Analysis, Measurement, and Control* 3 (1) (2015) 17. doi:
932 [10.7726/jvamc.2015.1002](https://doi.org/10.7726/jvamc.2015.1002).
- 933 [6] X. F. Wang, Q. S. Yang, S.-s. Law, Wrinkled membrane element based
934 on the wrinkling potential, *International Journal of Solids and Struc-*
935 *tures* 51 (21) (2014) 3532–3548. doi:[10.1016/j.ijsolstr.2014.06.](https://doi.org/10.1016/j.ijsolstr.2014.06.004)
936 [004](https://doi.org/10.1016/j.ijsolstr.2014.06.004).
- 937 [7] Y. Miyazaki, Wrinkle/slack model and finite element dynamics of mem-
938 brane, *International Journal for Numerical Methods in Engineering*
939 66 (7) (2006) 1179–1209. doi:[10.1002/nme.1588](https://doi.org/10.1002/nme.1588).

- 940 [8] X. Wang, S.-s. Law, Q. Yang, N. Yang, Numerical study on the dynamic
941 properties of wrinkled membranes, *International Journal of Solids and*
942 *Structures* 143 (2018) 125–143. doi:10.1016/j.ijsolstr.2018.03.
943 001.
- 944 [9] X. Deng, Y. Xu, C. Clarke, Wrinkling modelling of space membranes
945 subject to solar radiation pressure, *Composites Part B: Engineering*.
946 (Aug. 2018). doi:10.1016/j.compositesb.2018.08.088.
- 947 [10] H. Wagner, *Flat sheet metal girders with very thin metal web. Part I :*
948 *: general theories and assumptions*, National Advisory Committee for
949 Aeronautics, 1931, oCLC: 919168471.
950 URL [http://app.knovel.com/hotlink/toc/id:kpFSMGVT11/](http://app.knovel.com/hotlink/toc/id:kpFSMGVT11/flat-sheet-metal)
951 [flat-sheet-metal](http://app.knovel.com/hotlink/toc/id:kpFSMGVT11/flat-sheet-metal)
- 952 [11] E.-S. Lee, S.-K. Youn, Finite element analysis of wrinkling membrane
953 structures with large deformations, *Finite Elements in Analysis and De-*
954 *sign* 42 (8-9) (2006) 780–791. doi:10.1016/j.finel.2006.01.004.
- 955 [12] D. G. Roddeman, Finite-element analysis of wrinkling membranes,
956 *Communications in Applied Numerical Methods* 7 (4) (1991) 299–307.
957 doi:10.1002/cnm.1630070408.
- 958 [13] C. H. Wu, T. R. Canfield, Wrinkling in finite plane-stress theory, *Quar-*
959 *terly of Applied Mathematics* 39 (2) (1981) 179–199. doi:10.1090/qam/
960 625468.
- 961 [14] A. C. Pipkin, The Relaxed Energy Density for Isotropic Elastic Mem-
962 branes, *IMA Journal of Applied Mathematics* 36 (1) (1986) 85–99.
963 doi:10.1093/imamat/36.1.85.

- 964 [15] E. M. Haseganu, D. J. Steigmann, Analysis of partly wrinkled mem-
965 branes by the method of dynamic relaxation, *Computational Mechanics*
966 14 (6) (1994) 596–614. [doi:10.1007/BF00350839](https://doi.org/10.1007/BF00350839).
- 967 [16] D. J. Steigmann, A. C. Pipkin, Finite deformations of wrinkled mem-
968 branes, *The Quarterly Journal of Mechanics and Applied Mathematics*
969 42 (3) (1989) 427–440. [doi:10.1093/qjmam/42.3.427](https://doi.org/10.1093/qjmam/42.3.427).
- 970 [17] T. Raible, K. Tegeler, S. Löhnert, P. Wriggers, Development of a wrin-
971 kling algorithm for orthotropic membrane materials, *Computer Meth-
972 ods in Applied Mechanics and Engineering* 194 (21) (2005) 2550–2568.
973 [doi:10.1016/j.cma.2004.07.045](https://doi.org/10.1016/j.cma.2004.07.045).
- 974 [18] M. Epstein, M. A. Forcinito, Anisotropic membrane wrinkling: the-
975 ory and analysis, *International Journal of Solids and Structures* 38 (30)
976 (2001) 5253–5272. [doi:10.1016/S0020-7683\(00\)00346-2](https://doi.org/10.1016/S0020-7683(00)00346-2).
- 977 [19] A. Jarasjarungkiat, R. Wüchner, K.-U. Bletzinger, Efficient sub-grid
978 scale modeling of membrane wrinkling by a projection method, *Com-
979 puter Methods in Applied Mechanics and Engineering* 198 (9-12) (2009)
980 1097–1116. [doi:10.1016/j.cma.2008.11.014](https://doi.org/10.1016/j.cma.2008.11.014).
- 981 [20] S. Kang, S. Im, Finite Element Analysis of Wrinkling Membranes, *Jour-
982 nal of Applied Mechanics* 64 (2) (1997) 263. [doi:10.1115/1.2787302](https://doi.org/10.1115/1.2787302).
- 983 [21] X. Liu, C. H. Jenkins, W. W. Schur, Large deflection analysis of pneu-
984 matic envelopes using a penalty parameter modified material model,
985 *Finite Elements in Analysis and Design* 37 (3) (2001) 233–251. [doi:
986 10.1016/S0168-874X\(00\)00040-8](https://doi.org/10.1016/S0168-874X(00)00040-8).
- 987 [22] K. Woo, H. Igawa, C. H. Jenkins, Analysis of Wrinkling Behavior of

- 988 Anisotropic Membrane, CMES: Computer Modeling in Engineering &
989 Sciences 6 (4) (2004) 397–408. [doi:10.3970/cmes.2004.006.397](https://doi.org/10.3970/cmes.2004.006.397).
- 990 [23] R. K. Miller, J. M. Hedgepeth, An algorithm for finite element analysis
991 of partly wrinkled membranes, AIAA Journal 20 (12) (1982) 1761–1763.
992 [doi:10.2514/3.8018](https://doi.org/10.2514/3.8018).
- 993 [24] R. K. Miller, J. M. Hedgepeth, V. I. Weingarten, P. Das, S. Kahyai, Fi-
994 nite element analysis of partly wrinkled membranes, Computers & Struc-
995 tures 20 (1) (1985) 631–639. [doi:10.1016/0045-7949\(85\)90111-7](https://doi.org/10.1016/0045-7949(85)90111-7).
- 996 [25] A. Adler, M. Mikulas, J. Hedgepeth, Static and dynamic analysis of
997 partially wrinkled membrane structures, in: 41st Structures, Structural
998 Dynamics, and Materials Conference and Exhibit, American Institute of
999 Aeronautics and Astronautics, Atlanta,GA,U.S.A., 2000. [doi:10.2514/
1000 6.2000-1810](https://doi.org/10.2514/6.2000-1810).
- 1001 [26] H. Ding, B. Yang, The modeling and numerical analysis of wrinkled
1002 membranes, International Journal for Numerical Methods in Engineer-
1003 ing 58 (12) (2003) 1785–1801. [doi:10.1002/nme.832](https://doi.org/10.1002/nme.832).
- 1004 [27] T. Akita, K. Nakashino, M. C. Natori, K. C. Park, A simple com-
1005 puter implementation of membrane wrinkle behaviour via a projection
1006 technique, International Journal for Numerical Methods in Engineering
1007 71 (10) (2007) 1231–1259. [doi:10.1002/nme.1990](https://doi.org/10.1002/nme.1990).
- 1008 [28] L. Zheng, [Wrinkling of dielectric elastomer membranes](#), Ph.D. thesis,
1009 California Institute of Technology, Pasadena, CA. (2009).
1010 URL [http://resolver.caltech.edu/CaltechETD:
1011 etd-09222008-161217](http://resolver.caltech.edu/CaltechETD:etd-09222008-161217)

- 1012 [29] E. Oñate, F. Zárata, Rotation-free triangular plate and shell elements,
1013 International Journal for Numerical Methods in Engineering 47 (1-3)
1014 (2000) 557–603. doi:10.1002/(SICI)1097-0207(20000110/30)47:1/
1015 3<557::AID-NME784>3.0.CO;2-9.
- 1016 [30] H. Laurent, G. Rio, Formulation of a thin shell finite element with conti-
1017 nuity C^0 and convected material frame notion, Computational Mechan-
1018 ics 27 (3) (2001) 218–232. doi:10.1007/s004660100243.
- 1019 [31] F. G. Flores, E. Oñate, Improvements in the membrane behaviour of
1020 the three node rotation-free BST shell triangle using an assumed strain
1021 approach, Computer Methods in Applied Mechanics and Engineering
1022 194 (6) (2005) 907–932. doi:10.1016/j.cma.2003.08.012.
- 1023 [32] Y. Lecieux, R. Bouzidi, Experimental analysis on membrane wrinkling
1024 under biaxial load - Comparison with bifurcation analysis, International
1025 Journal of Solids and Structures 47 (18) (2010) 2459–2475. doi:10.
1026 1016/j.ijsolstr.2010.05.005.
- 1027 [33] F. G. Flores, E. Oñate, Wrinkling and folding analysis of elastic mem-
1028 branes using an enhanced rotation-free thin shell triangular element,
1029 Finite Elements in Analysis and Design 47 (9) (2011) 982–990. doi:
1030 10.1016/j.finel.2011.03.014.
- 1031 [34] T. Iwasa, Approximate estimation of wrinkle wavelength and maximum
1032 amplitude using a tension-field solution, International Journal of Solids
1033 and Structures 121 (2017) 201 – 211. doi:10.1016/j.ijsolstr.2017.
1034 05.029.
- 1035 [35] P. Contri, B. A. Schrefler, A geometrically nonlinear finite element
1036 analysis of wrinkled membrane surfaces by a no-compression material

- 1037 model, *Communications in Applied Numerical Methods* 4 (1) (1988)
1038 5–15. doi:[10.1002/cnm.1630040103](https://doi.org/10.1002/cnm.1630040103).
- 1039 [36] T. Gerngross, S. Pellegrino, Anisotropic Viscoelasticity and Wrinkling of
1040 Superpressure Balloons: Simulation and Experimental Verification, in:
1041 AIAA Balloon Systems Conference, BLN-6: Materials and Structures
1042 II, 2009. doi:[10.2514/6.2009-2815](https://doi.org/10.2514/6.2009-2815).
- 1043 [37] T. Gerngross, Y. Xu, S. Pellegrino, Viscoelastic behaviour of pumpkin
1044 balloons, *Advances in Space Research* 42 (10) (2008) 1683–1690. doi:
1045 [10.1016/j.asr.2007.03.093](https://doi.org/10.1016/j.asr.2007.03.093).
- 1046 [38] X. Deng, S. Pellegrino, Wrinkling of orthotropic viscoelastic membranes,
1047 *AIAA Journal* 50 (3) (2012) 668–681. doi:[10.2514/1.J051255](https://doi.org/10.2514/1.J051255).
- 1048 [39] K. Kwok, S. Pellegrino, Large strain viscoelastic model for balloon film,
1049 in: AIAA (Ed.), 11th AIAA Aviation Technology, Integration, and Op-
1050 erations (ATIO) Conference, American Institute of Aeronautics and As-
1051 tronautics, 2011. doi:[10.2514/6.2011-6939](https://doi.org/10.2514/6.2011-6939).
- 1052 [40] D. Wakefield, A. Bown, Non-Linear Analysis of the NASA Super Pres-
1053 sure Balloons: Some Detailed Investigations of Recent Antarctic Flight
1054 Balloons, in: 11th AIAA Aviation Technology, Integration, and Opera-
1055 tions (ATIO) Conference, American Institute of Aeronautics and Astro-
1056 nautics, 2011. doi:[10.2514/6.2011-6829](https://doi.org/10.2514/6.2011-6829).
- 1057 [41] V. Nayyar, K. Ravi-Chandar, R. Huang, Stretch-induced stress patterns
1058 and wrinkles in hyperelastic thin sheets, *International Journal of Solids
1059 and Structures* 48 (25) (2011) 3471–3483. doi:[10.1016/j.ijsolstr.
1060 2011.09.004](https://doi.org/10.1016/j.ijsolstr.2011.09.004).

- 1061 [42] C. Fu, T. Wang, F. Xu, Y. Huo, M. Potier-Ferry, A modeling and reso-
1062 lution framework for wrinkling in hyperelastic sheets at finite membrane
1063 strain, *Journal of the Mechanics and Physics of Solids* 124 (2019) 446–
1064 470. [doi:10.1016/j.jmps.2018.11.005](https://doi.org/10.1016/j.jmps.2018.11.005).
- 1065 [43] R. Ziegler, W. Wagner, K.-U. Bletzinger, A Finite Element Model
1066 for the Analysis of Wrinkled Membrane Structures, *International*
1067 *Journal of Space Structures* 18 (1) (2003) 1–14. [doi:10.1260/](https://doi.org/10.1260/026635103769016591)
1068 [026635103769016591](https://doi.org/10.1260/026635103769016591).
- 1069 [44] M. R. Barnes, Form Finding and Analysis of Tension Structures by
1070 Dynamic Relaxation, *International Journal of Space Structures* 14 (2)
1071 (1999) 89–104. [doi:10.1260/0266351991494722](https://doi.org/10.1260/0266351991494722).
- 1072 [45] P. Underwood, Dynamic Relaxation, in *Computational methods for*
1073 *transient analysis*. Eds T. Belytschko, T. J.R. Hugues. Elsevier Sci-
1074 *ence Publishers Amsterdam : North-Holland.*, 1983, Ch. 5, pp. 245–265.
1075 [doi:10.1002/zamm.19860660905](https://doi.org/10.1002/zamm.19860660905).
- 1076 [46] G. Rio (Ed.), Herezh++: FEM software for large transformations in
1077 solids, Université de Bretagne Sud, dépôt APP (Agence pour la Protec-
1078 tion des Programmes) - Certification IDDN-FR-010-0106078-000-R-P-
1079 2006-035-20600, 2006.
- 1080 [47] H. Laurent, G. Rio, A. Vandenbroucke, N. Aït Hocine, Experimental
1081 and numerical study on the temperature-dependent behavior of a fluoro-
1082 elastomer, *Mechanics of Time-Dependent Materials* 18 (4) (2014) 721–
1083 742. [doi:10.1007/s11043-014-9247-3](https://doi.org/10.1007/s11043-014-9247-3).
- 1084 [48] J. Troufflard, H. Laurent, G. Rio, B. Omnès, S. Javanaud, Temperature-
1085 dependent modelling of a HNBR O-ring seal above and below the glass

- 1086 transition temperature, *Materials & Design* 156 (2018) 1–15. doi:10.
1087 1016/j.matdes.2018.06.016.
- 1088 [49] Abaqus, ABAQUS/Standard User’s Manual, Version 6.14 (2014).
- 1089 [50] P. Y. Manach, G. Rio, Analysis of orthotropic behavior in convected
1090 coordinate frames, *Computational Mechanics* 23 (5) (1999) 510–518.
1091 doi:10.1007/s004660050430.
- 1092 [51] D. G. Roddeman, J. Drukker, C. W. J. Oomens, J. D. Janssen, The
1093 Wrinkling of Thin Membranes: Part I—Theory, *J. Appl. Mech* 54 (4)
1094 (1987) 884–887. doi:10.1115/1.3173133.
- 1095 [52] J. Troufflard, *Étude numérique et expérimentale des structures gon-*
1096 *flables : applications aux gilets de sauvetage gonflables*, Phd thesis,
1097 Lorient (Jan. 2011).
1098 URL <http://www.theses.fr/2011LORIS223>
- 1099 [53] D. Wakefield, Numerical Modelling of Pumpkin Balloon Instability, in:
1100 AIAA 5th ATIO and 16th Lighter-Than-Air Sys Tech. and Balloon Sys-
1101 tems Conferences, American Institute of Aeronautics and Astronautics,
1102 2005. doi:10.2514/6.2005-7445.
- 1103 [54] D. Wakefield, Numerical Investigations of Pumpkin Balloon Deployment
1104 Stability, in: AIAA Balloon Systems Conference, American Institute of
1105 Aeronautics and Astronautics, 2007. doi:10.2514/6.2007-2604.
- 1106 [55] D. Wakefield, Non-Linear Viscoelastic Analysis and the Design of Super
1107 Pressure Balloons: Stress, Strain and Stability, in: AIAA Balloon Sys-
1108 tems Conference, American Institute of Aeronautics and Astronautics,
1109 2009. doi:10.2514/6.2009-2813.

- 1110 [56] D. Wakefield, A. Bown, Non-Linear Analysis of the NASA Super Pres-
1111 sure Balloons: Whole Flight Simulations, in: AIAA Balloon Systems
1112 Conference, American Institute of Aeronautics and Astronautics, 2017.
1113 [doi:10.2514/6.2017-3606](https://doi.org/10.2514/6.2017-3606).
- 1114 [57] J. R. Garcia, [Numerical study of dynamic relaxation methods and con-](#)
1115 [tribution to the modelling of inflatable lifejackets](#), Phd thesis, Université
1116 de Bretagne Sud (Dec. 2011).
1117 URL <https://tel.archives-ouvertes.fr/tel-00659669/document>
- 1118 [58] J. Rodriguez, G. Rio, J. M. Cadou, J. Troufflard, Numerical study of
1119 dynamic relaxation with kinetic damping applied to inflatable fabric
1120 structures with extensions for 3d solid element and non-linear behavior,
1121 Thin-Walled Structures 49 (11) (2011) 1468–1474. [doi:10.1016/j.tws.](https://doi.org/10.1016/j.tws.2011.07.011)
1122 [2011.07.011](https://doi.org/10.1016/j.tws.2011.07.011).
- 1123 [59] R. Courant, K. Friedrichs, H. Lewy, On the Partial Difference Equations
1124 of Mathematical Physics, IBM Journal of Research and Development
1125 11 (2) (1967) 215–234. [doi:10.1147/rd.112.0215](https://doi.org/10.1147/rd.112.0215).
- 1126 [60] Mansfield Eric Harold, Pugsley Alfred Grenville, Load transfer via a
1127 wrinkled membrane, Proceedings of the Royal Society of London. A.
1128 Mathematical and Physical Sciences 316 (1525) (1970) 269–289. [doi:](https://doi.org/10.1098/rspa.1970.0079)
1129 [10.1098/rspa.1970.0079](https://doi.org/10.1098/rspa.1970.0079).
- 1130 [61] J. Leifer, W. Belvin, Prediction of Wrinkle Amplitudes in Thin
1131 Film Membranes Using Finite Element Modeling, in: 44th
1132 AIAA/ASME/ASCE/AHS/ASC Structures, Structural Dynamics, and
1133 Materials Conference, Structures, Structural Dynamics, and Materials

- 1134 and Co-located Conferences, American Institute of Aeronautics and As-
1135 tronautics, 2003. doi:10.2514/6.2003-1983.
- 1136 [62] W. Wong, S. Pellegrino, Wrinkled membranes I: experiments, Journal
1137 of Mechanics of Materials and Structures 1 (1) (2006) 3–25. doi:10.
1138 2140/jomms.2006.1.3.
- 1139 [63] W. Wong, S. Pellegrino, Wrinkled membranes II: analytical models.,
1140 Journal of Mechanics of Materials and Structures 1 (1) (2006) 27–61.
1141 doi:10.2140/jomms.2006.1.27.
- 1142 [64] M. M. Mikulas, Behavior of a flat stretched membrane wrinkled by the
1143 rotation of an attached hub, no. 30 p. in NASA TN D-2456, National
1144 Aeronautics and Space Administration. Langley Research Center, Wash-
1145 ington, D.C., 1964.
1146 URL //catalog.hathitrust.org/Record/011433642
- 1147 [65] K. Lu, M. Accorsi, J. Leonard, Finite element analysis of membrane
1148 wrinkling, International Journal for Numerical Methods in Engineer-
1149 ing 50 (5) (2001) 1017–1038. doi:10.1002/1097-0207(20010220)50:
1150 5<1017::AID-NME47>3.0.CO;2-2.
- 1151 [66] E. Reissner, On Tension Field Theory, in: Fifth International Congress
1152 on Applied Mechanics, 1938, pp. 88–92.
1153 URL https://books.google.fr/books?id=LURNXwAACAAJ
- 1154 [67] M. Stein, J. M. Hedgepeth, Analysis of partly wrinkled membranes,
1155 Washington, D.C. : National Aeronautics and Space Administration :
1156 [For sale by the Office of Technical Services, Dept. of Commerce], 1961.
1157 URL https://trove.nla.gov.au/version/179471700

- 1158 [68] X. Wang, J. Ma, S.-s. Law, Q. Yang, Numerical analysis of wrinkle-
1159 influencing factors of thin membranes, *International Journal of Solids*
1160 *and Structures* 97-98 (2016) 458–474. doi:10.1016/j.ijsolstr.2016.
1161 07.004.
- 1162 [69] D. Favier, P. Guélin, P. Pegon, Thermomechanics of Hysteresis Effects
1163 in Shape Memory Alloys, *MSF* 56-58 (1991) 559–564. doi:10.4028/
1164 www.scientific.net/MSF.56-58.559.
- 1165 [70] M. Zrida, H. Laurent, G. Rio, S. Pimbert, V. Grolleau, N. Masmoudi,
1166 C. Bradai, Experimental and numerical study of polypropylene behavior
1167 using an hyper-visco-hysteresis constitutive law, *Computational Materi-*
1168 *als Science* 45 (2) (2009) 516 – 527. doi:10.1016/j.commatsci.2008.
1169 11.017.
- 1170 [71] C. Galliot, R. H. Luchsinger, Uniaxial and biaxial mechanical properties
1171 of ETFE foils, *Polymer Testing* 30 (4) (2011) 356–365. doi:10.1016/
1172 j.polymertesting.2011.02.004.
- 1173 [72] CNES, last accessed May 2020. [link].
1174 URL <https://phototheque.cnes.fr>
- 1175 [73] F. Petitjean, G. Rio, A. Hamdani, X. Soors, [Simulation du comporte-](#)
1176 [ment de ballons stratosphériques ouverts](#), in: *CSMA 2015 - 12ème*
1177 *Colloque National en Calcul des Structures*, Giens, France, 2015.
1178 URL [https://hal.archives-ouvertes.fr/hal-01502302/file/](https://hal.archives-ouvertes.fr/hal-01502302/file/csma2015_FP_GR.pdf)
1179 [csma2015_FP_GR.pdf](#)
- 1180 [74] W. W. Schur, J. M. Simpson, [Finite element solution for the structural](#)
1181 [behavior of a scientific balloon](#), *Advances in Space Research* 13 (2)
1182 (1993) 45–48. doi:10.1016/0273-1177(93)90273-E.

1183 URL [http://www.sciencedirect.com/science/article/pii/](http://www.sciencedirect.com/science/article/pii/027311779390273E)
1184 [027311779390273E](http://www.sciencedirect.com/science/article/pii/027311779390273E)

1185 [75] W. W. Schur, [Structural response of a zero-pressure balloon with an](#)
1186 [axial load tendon](#), in: International Balloon Technology Conference,
1187 Balloon Systems Conferences, American Institute of Aeronautics and
1188 Astronautics, 1997. doi:10.2514/6.1997-1475.

1189 URL <https://arc.aiaa.org/doi/10.2514/6.1997-1475>