



HAL
open science

Robust Crone design for a variable-ratio planetary gearing in a variable speed wind turbine

Benjamin Feytout, Patrick Lanusse, Jocelyn Sabatier, Serge Gracia

► To cite this version:

Benjamin Feytout, Patrick Lanusse, Jocelyn Sabatier, Serge Gracia. Robust Crone design for a variable-ratio planetary gearing in a variable speed wind turbine. ASME/IEEE International Conference on Mechatronic and Embedded Systems and Applications (MESA11), Aug 2011, Washington, United States. pp.285-291, 10.1115/DETC2011-47842 . hal-04649346

HAL Id: hal-04649346

<https://hal.science/hal-04649346v1>

Submitted on 26 Jan 2025

HAL is a multi-disciplinary open access archive for the deposit and dissemination of scientific research documents, whether they are published or not. The documents may come from teaching and research institutions in France or abroad, or from public or private research centers.

L'archive ouverte pluridisciplinaire **HAL**, est destinée au dépôt et à la diffusion de documents scientifiques de niveau recherche, publiés ou non, émanant des établissements d'enseignement et de recherche français ou étrangers, des laboratoires publics ou privés.

Robust CRONE Design for a Variable Ratio Planetary Gearing in a Variable Speed Wind Turbine

Benjamin Feytout

Université de Bordeaux, IMS UMR5218 CNRS
Talence, France

Valeol
Bègles, France

Jocelyn Sabatier

Université de Bordeaux, IMS UMR5218 CNRS
Talence, France

Patrick Lanusse

Université de Bordeaux, IMS UMR5218 CNRS
Talence, France

Serge Gracia

Valeol
Bègles, France

ABSTRACT

Most wind turbines installed have traditional architectures: double-fed asynchronous machine or direct drive with full conversion, both containing several levels of control composed of PI controllers. In our application, a robust 3rd-generation-CRONE controller is used to manage a planetary gearing ratio upstream of a synchronous generator directly connected to the grid. Thus, the speed of the low shaft is controlled and unlike other architectures, no system of power electronics is required for conversion. This CRONE approach is a robust control methodology based on fractional order differentiation.

INTRODUCTION

An asynchronous machine ran at constant speed in first wind turbines and was directly connected to the grid (Camblong, 2003). Technology evolved toward variable speed with the variation of number of poles which allowed two different operating speeds (Dubois, 2009). Nowadays, power electronics systems associated to a double fed induction generator let it runs around $\pm 30\%$ of the synchronous speed (Akhmatov, 2002) imposed by the grid.

Variable speed increases global efficiency hence the need to control the low shaft speed to get maximum power from the wind. For synchronous as for asynchronous architectures propose variable speed solution and power control with power electronics converters (Pena et al., 1996).

In this paper, a wind turbine with a synchronous generator is considered. Compared to a double fed induction generator, a synchronous generator permits (CPNV, 2005):

- high efficiency,
- large speed variation,
- controllable reactive power.

The architecture proposed introduces speed control for maximum power thanks to a variable ratio planetary gearing, located between a gearbox and a synchronous generator. Such architecture allows a direct connection of the generator to the grid without any transformation of the electrical signal. Thus no full scale IGBT converter is needed.

Moreover, speed control is carried out here with a robust CRONE controller. On other wind turbines, speed control is ensured by PI controllers (Burton et al., 2001, Pena et al., 1996). But as shown in this paper, a robust controller has better efficiency than PI controller for low wind speed under rated power (4m/s to 11 m/s) because of the nonlinear behaviour of the wind turbine. Moreover, among existing robust control design methodologies, CRONE control has proved his efficiency several times on different systems and requires the tuning of only 4 parameters, no much more than a PI controller.

SYSTEM DESCRIPTION

The efficiency of wind turbines mainly relies on variable speed. Maximum Power Point Tracking (MPPT)(Fig. 1) method is based on the control of the low shaft speed, linked to the blades. The purpose is to be on the optimal operating point to take maximum power from wind (Bouscayrol, 2006). Therefore, an optimal rotational speed is reached for any wind speed.

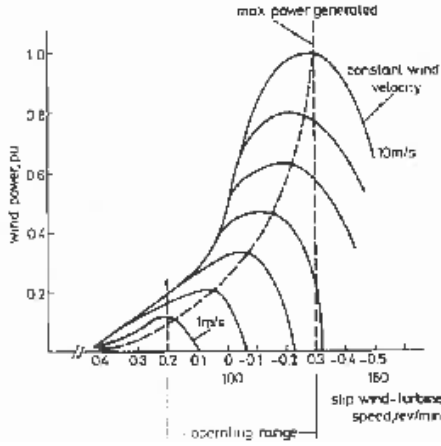

Figure 1. MPPT theory illustration (Holmes et al., 1984)

Power and low shaft speed control are commonly achieved with power electronics systems. In this paper, a planetary gearing ensures a mechanical control. Synchronous generator, running at constant speed of 1500 rpm is connected to ring gear (Fig. 2) and the low shaft is connected to carrier, whose speed can be controlled by a torque on sun gear via an electric motor. As synchronous generator is directly connected to the grid, its speed is imposed and thus constant. Consequently, the speed variation caused by the sun gear is transmitted to the carrier linked to the low shaft (Fig. 3).

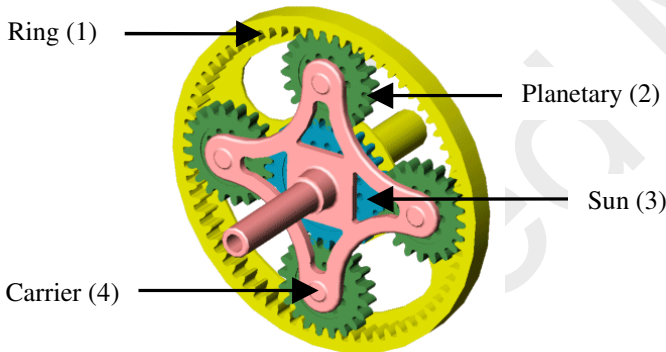

Figure 2. Planetary gearing (The Mathworks, 2010)

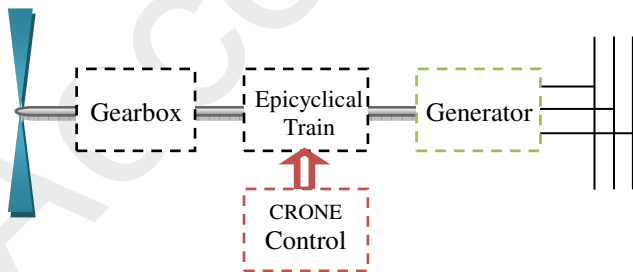

Figure 3. Architecture of the wind turbine

Variable ratio is ensured by the planetary gearing associated with the fixed-ratio gearbox. Global efficiency of dynamic chain is approximately of 0.93.

CONTROL STRATEGY

As above mentioned, under rated power, the controller main objective is to maximize the energy captured by the blades from the wind. Many design methodologies are used in the literature as Linear Quadratic Optimal Output Feedback control (Bongers *et al.*, 1989), state estimation (Bossanyi 1989, Ekelund 1994), RST control (Poitiers, 2003), sliding mode control (Beltran *et al.*, 2010) instead of traditional PI or PID controllers in real wind turbines. In this paper, as wind input is constantly changing, we propose a robust CRONE controller that ensures small time response and good accuracy for all wind speeds within the range 4m/s to 11 m/s.

Section 2 presents SISO CRONE control design methodology. The system identification and the control design are detailed in Section 3. In the last part of the paper, controller implementation and results are shown on our calibrated simulation model.

SISO CRONE CONTROL DESIGN METHODOLOGY

The CRONE control-system design methodology is a frequency-domain approach developed since the Eighties (Oustaloup *et al.*, 1983, 1991, 1995; Lanusse, 1994; Åström, 1999). It is based on the common unity-feedback configuration. The principle of the third generation CRONE control methodology is to optimize the parameter of a nominal open-loop transfer function $\beta_0(s)$ that includes a band-limited complex fractional order integration:

$$\beta_0(s) = \beta_l(s)\beta_m(s)\beta_h(s), \quad (1)$$

- where $\beta_m(s)$ is a set of band-limited generalized templates:

$$\beta_m(s) = \prod_{k=-N^-}^{N^+} \beta_{m_k}(s), \quad (2)$$

with:

$$\beta_{m_k}(s) = C_k^{\text{sign}(b_k)} \left(\alpha_k \frac{1+s/\omega_{k+1}}{1+s/\omega_k} \right)^{a_k} \left(\Re e_{\beta_k} \left\{ \left(\alpha_k \frac{1+s/\omega_{k+1}}{1+s/\omega_k} \right)^{ib_k} \right\} \right)^{-q_k \text{sign}(b_k)}$$

$$\alpha_k = (\omega_{k+1}/\omega_k)^{1/2} \quad \text{for } k \neq 0$$

$$\text{and } \alpha_0 = \left(1 + \left(\frac{\omega_r}{\omega_0} \right)^2 \right) / \left(1 + \left(\frac{\omega_r}{\omega_1} \right)^2 \right)^{1/2}$$

(3)

- where $\beta_l(s)$ is an integer order n_l proportional integrator and where $\beta_h(s)$ is a low-pass filter of integer order n_h :

$$\beta_l(s) = C_l \left(\frac{\omega_{-N^-}}{s} + 1 \right)^{n_l}, \quad \beta_h(s) = C_h \left(\frac{s}{\omega_{N^+}} + 1 \right)^{-n_h}. \quad (4)$$

Gains C_x (C_k , C_l and C_h) are such that ω_k is the closed-loop resonant frequency. Order n_l has to be set to manage the accuracy provided by the control-system. Order n_h has to be set to obtain a proper or bi-proper control. When it is useful, N^- and N^+ are different from 0 to increase the number of tuning parameters.

The open loop parameters are optimized in order to reduce the variation of the resonant peak M_T of the complementary sensitivity function $T(s)$. The following robustness cost function can be minimized:

$$J = \left(M_{T0} - \inf_G |M_T| \right)^2 + \left(\sup_G |M_T| - M_{T0} \right)^2, \quad (5)$$

where M_{T0} is a required value of the nominal closed loop resonant peak (for the nominal plant G_0), while respecting the following set of inequality constraints for all plants G and for $\omega \in \mathbb{R}^+$:

$$\inf_G |T(j\omega)| \geq T_1(\omega), \quad \sup_G |T(j\omega)| \leq T_u(\omega), \quad \sup_G |S(j\omega)| \leq S_u(\omega) \\ \sup_G |KS(j\omega)| \leq KS_u(\omega) \quad \text{and} \quad \sup_G |GS(j\omega)| \leq GS_u(\omega), \quad (6)$$

$$\text{with} \quad \begin{cases} T(s) = \frac{G(s)K(s)}{1+G(s)K(s)} & S(s) = \frac{1}{1+G(s)K(s)} \\ KS(s) = \frac{K(s)}{1+G(s)K(s)} & GS(s) = \frac{G(s)}{1+G(s)K(s)} \end{cases}. \quad (7)$$

It is easy to show that the multiplicative uncertainty $\Delta_m \beta(s)$ of the open-loop frequency response, which defines the frequency-domain uncertainty in the Nichols chart, is invariant and equal to that of the plant:

$$\beta(s) = G(s)K(s) = G_0(s)\Delta_m G(s)C(s) = \beta_0(s)\Delta_m G(s) \quad (8)$$

where $G_0(s)$ and $\beta_0(s)$ are the nominal plant and open-loop transfer functions and where $\Delta_m G(s)$ (or $\Delta_m \beta(s)$) is a multiplicative uncertainty model. Thus, the uncertainty frequency-domains related to the Nichols locus of $\beta_0(j\omega)$ are defined by all the possible values of the ordered pair $(\arg \Delta_m G(j\omega), |\Delta_m G(j\omega)|_{dB})$. By minimizing J (5), the optimal parameters position the uncertainty frequency domains so that they overlap as little as possible the low stability margin areas of the Nichols chart. As the uncertainties are taken into account by the least conservative method, only a nonlinear optimization method can be used.

For $N^- = N^+ = 0$, only four independent open-loop parameters have to be optimized. The parameterization of the open-loop transfer function by complex fractional orders, then simplifies the optimization considerably. During optimization a complex order has the same function as a whole set of parameters found in common rational controllers. Finally, the fractional controller $K_F(s)$ is defined by its frequency response:

$$K_F(j\omega) = \frac{\beta_0(j\omega)}{G_0(j\omega)}. \quad (9)$$

The parameters of a rational (i.e. with integer orders) transfer function $K_R(s)$ with a predefined low-order structure are tuned to fit the ideal frequency response $K_F(j\omega)$. Any frequency-domain system-identification technique can be used.

An advantage of this design method is that low values of the controller order (usually around 6) can be used, no matter the control problem complexity.

The coupling elements of plants are interpreted as an additional uncertainty on the plant diagonal elements.

A fully MIMO design approach may sometimes be necessary, for instance when the plant diagonal dominance degree is weak. The design of multi-SISO and MIMO CRONE control relies on complementary approaches: the multi-SISO design is easy to use for MIMO plants, but is still a diagonal design; the MIMO design could be more efficient, but also more difficult to use. One or the other has to be chosen, depending on the multivariable degree of the plant, to optimize the ease-of-use/performance trade-off.

APPLICATION SYSTEM MODELING

A wind turbine is a multi-physical system in which two transformations of power take place: aerodynamical to mechanical and mechanical to electrical. Mechanical and electrical domains mainly used rotating shafts and generators, converters and grid connection.

A Matlab/Simulink model of the wind turbine has been created (Fig. 4). It uses mainly two toolboxes: SimDriveline and SimPowerSystems.

Power provided by blades is modelled by:

$$P_{wind} = \frac{1}{2} C_p \rho S V_{wind}^3 \quad (10)$$

where C_p = power coefficient,
 ρ = air density (kg/m³),
 S = area swept by blades (m²),
 V_{wind} = wind speed (m/s).

C_p coefficient is obtained by a look-up table estimated from experimental data: C_p coefficient depends on tip speed ratio λ , defined by:

$$\lambda = \frac{\Omega R}{V_{hub}} \quad (11)$$

with Ω = rotational velocity of blades (rad/s),
 R = blade length (m),
 V_{hub} = wind speed at hub level (m/s).

From P_{wind} value, torque is calculated and used as input for mechanical part of wind turbine model, composed of simple gear and planetary gearing blocks. Then, a connection is established with the generator which is linked to the grid.

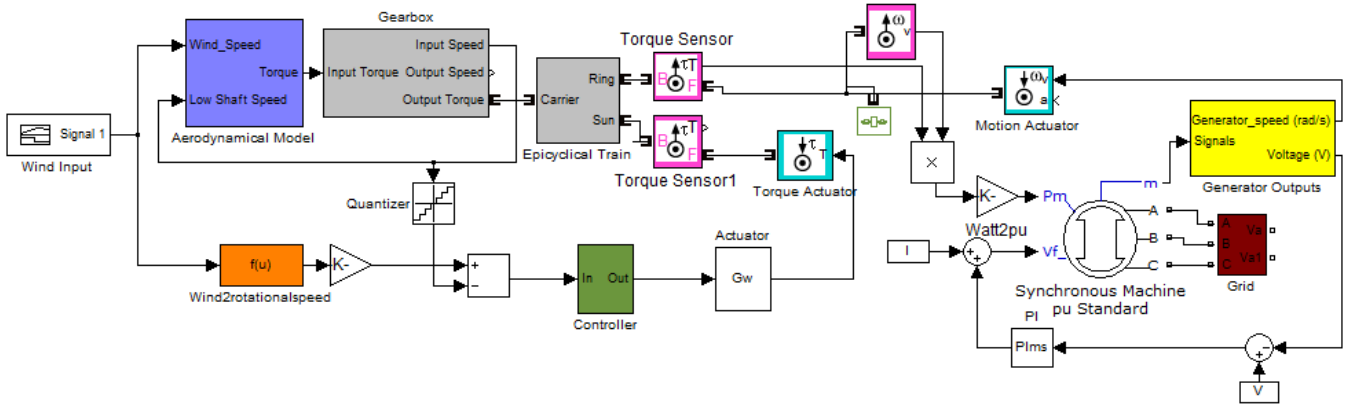

Figure 4. Closed-loop Simulink Model of the wind turbine

SYSTEM IDENTIFICATION

Wind turbine production changes according to wind speed, hence the existence of different operating areas. First, between 0 and 4 m/s (cut-in wind speed), there is not enough wind to produce electricity. The second area is defined between 4 m/s and 12 m/s by a nonlinear increase of production until rated power level, defined by Fig. 1. Production is imposed constant at nominal value by structural constraints of the generator and falls down to zero after cut-out wind speed value, 24 m/s (Fig. 5).

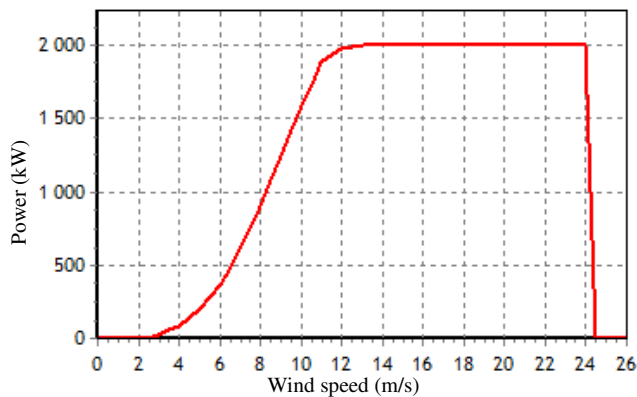

Figure 5. Wind turbine power curve

Our model is supposed running from 4 to 11 m/s wind speed range as we do not take in account pitch control, active from 11 m/s to 24 m/s. After being tuned, the wind turbine model provides a power curve very close to its theoretical value (Fig. 6).

For a CRONE controller design, a family of models has to be created. They are obtained by identifying the nonlinear model of the wind turbine to an equivalent linear model for a set of operating points 4, 6, 8 and 10 m/s.

This open-loop system identification step is achieved by a multi-sine (i.e. a sum of sinusoids at different frequencies) study because the *linmod* Matlab function is not supported by several blocks used in our model. Furthermore, the same system identification method could be used on a real wind turbine.

The sun torque input of the block defined by Gw (Fig.4) has been used to identify the system from sun gear torque to low shaft speed.

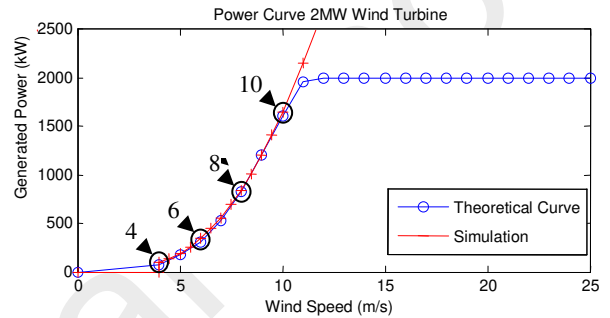

Figure 6. Operating points for the family of models

As the idea is to determine a frequency domain behaviour, the excitation frequency ranges from 0.1 Hz to 20 Hz according to the system dynamic with a sampling frequency of 100 Hz. The advantage of the multi-sine is that only a set of selected frequencies is included in the excitation signal:

$$u(t) = u_0 + \sum_{k=1}^F A \cos(2\pi f_k t + \theta_k) \quad (15)$$

where the Schroeder phases are $\theta_k = -k(k-1)\pi/F$ and f_k is $l_k f_0$ with $l_k \in \mathbb{N}$ and F is the number of cosine functions.

The average value u_0 is chosen with respect to the desired operating point, then the amplitude A is chosen with respect to nonlinear constraints (i.e. saturation level) and results in a compromise between small signal hypothesis and noise level. The low shaft speed response is measured.

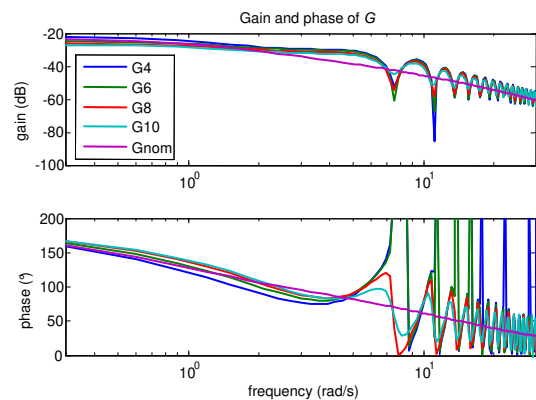

Figure 7. Bode diagrams of the set of SISO system that links the sun gear torque to the low shaft speed

Finally, Fast Fourier Transform is performed to compute the Bode diagram of the real system (Fig. 7). $G(j\omega)$ SISO frequency response links the sun gear torque (N.m) to the low shaft speed (rad/s).

The variation in frequency responses is the result of the nonlinear behaviour of the plant. These nonlinearities will be taken into account in the controller design by the set of possible frequency responses plant.

SPECIFICATIONS

The CRONE controller must limit the overshoot to 20% and have to reject disturbances. Thus, it must contain an integrator to ensure steady state accuracy. The required nominal resonant peak is 1.74 dB.

The value of the sensitivity function bandwidth should be greater than 3 rad/s (response time ≤ 1 s) for speed output.

An electrical motor is used to produce torque on sun gear. Its maximum input variation is defined at 100%. As a 0.0106 rad/s measurement noise needs to produce a noise on the control effort lower than 3%, the KS control effort sensitivity function needs to be bounded by 49 dB.

The sensitivity function constraints are presented on Fig. 9.

CONTROL SYSTEM DESIGN

Using the SISO approach, the nominal open-loop transfer function $\beta(s) = G_0(s)K(s)$ is designed by taking into account a nominal model of $G(s)$. As FFT analysis produces discontinuous frequency responses, such a nominal model would make it more difficult to synthesize the rational controller with frequency response defined by $\beta_0(j\omega)/G_0(j\omega)$. Thus, a nominal plant $G_0(s)$ is defined by an arbitrary 2nd order transfer function represented in purple in Fig. 7. This nominal plant makes simpler the design of the rational controller $K_R(s)$ obtained from (9). Nevertheless, all the frequency responses obtained from the FFT analysis are used to model the plant perturbation.

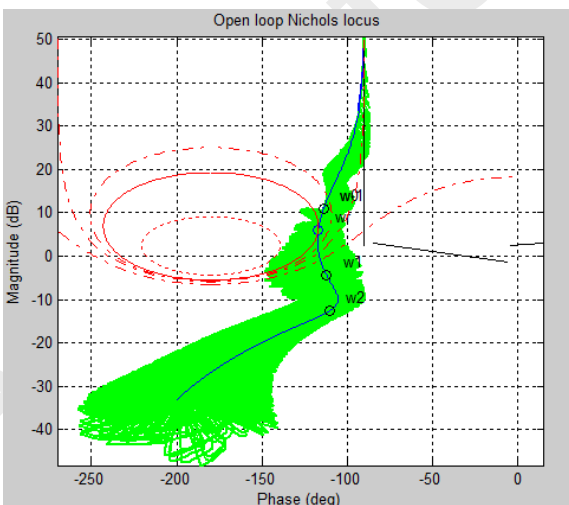

Figure 8. Optimized open loop $\beta(s)$ for all the operating points

The CRONE controller must be strictly proper for a decreasing gain at high frequencies. Thus, n_l and n_h of (4) are set respectively to 1 and 3. Constraints defined in previous

paragraph are used in the CRONE toolbox (<http://cronetoolbox.ims-bordeaux.fr>) that permits an easy design of the CRONE controller (Lanusse *et.al.* 2001). Fig. 8 presents the optimized and perturbed open loop frequency responses. The greatest resonant peak is 3.53 dB. The lowest modulus margin is 0.56 dB. The peak value of $KS(j\omega)$ is 48.2 dB.

The open loop optimal parameters are:

- $K = 1.3244$,
- $\omega_0 = 2$ rad/s, $\omega_1 = 7$ rad/s and $\omega_2 = 20$ rad/s,
- $a_0 = -0.06$, $b_0 = 0.81$ and $q_0 = 1$,
- $a_1 = 0.5$, $b_1 = 1.86$ and $q_1 = 2$,
- $\omega_r = 3$ rad/s.

Then, an approximation of the desired frequency response $K(j\omega)$ is achieved by an order five rational controller :

$$K(s) = \frac{-2.827e4 s^4 - 9.274e5 s^3 - 1.018e7 s^2 - 4.004e7 s - 2.974e7}{s^5 + 148.1 s^4 + 7133 s^3 + 1.156e5 s^2 + 2.282e5 s} \quad (16)$$

Fig. 9 presents the four sensitivity functions.

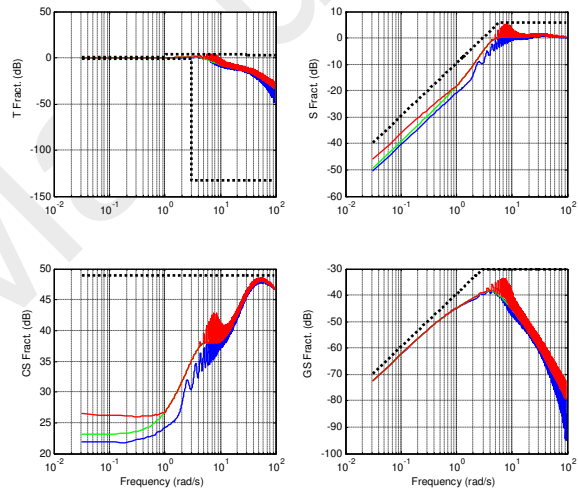

Figure 9. Closed-loop sensitivity functions (T, S, KS, GS)

Another controller is used to control the voltage at generator terminals: the rotor current is regulated by a simple PI controller to maintain constant voltage. It is a condition to allow the connection to the grid but it is not the subject of this paper.

SIMULATION RESULTS

We consider now the model presented before and implemented with Simulink (Fig. 4). The wind input is composed of eight steps as illustrated on Fig. 10. The aim is to check the robustness and the performance (rapidity and accuracy) of our controller. Two cases are presented using or not a low-pass filter on the desired value of the low shaft speed. This low pass filter is designed to compensate the 3dB resonance peak of the complementary sensitivity function:

$$F(s) = \frac{\omega_{f0} + s/\sqrt{2}}{\omega_{f0} + \sqrt{2}s} \quad (17)$$

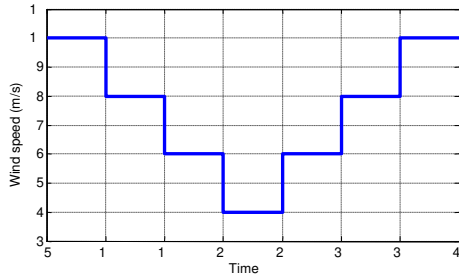

Figure 10. Wind speed

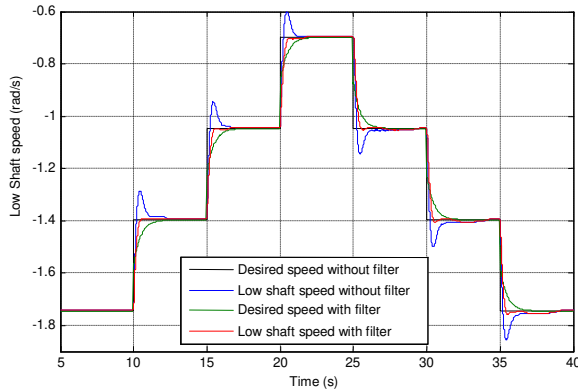

Figure 11. Low shaft speed with or without filter

With the CRONE controller, the best performance is obtained for a filter F tuned with $\omega_{f0} = 3$ rad/s. We observe that desired speed is reached in 0.5s. The control effort is presented on Fig. 12.

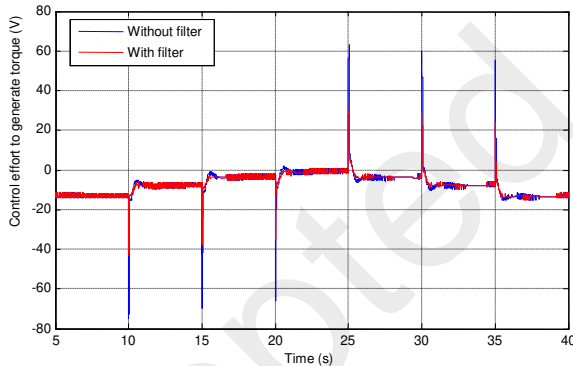

Figure 12. Control effort applied on sun gear

Figure 11 shows that the steady state error tends to zero and that the transient response is well damped for all operating points. The transient performance is an important property in this study as the wind is supposed to always vary. Figure 12 shows that the noise of the control effort is about 3% as required.

Figure 13 presents the generated voltage controlled by the PI controller. It shows that the PI controller ensures the control of this voltage.

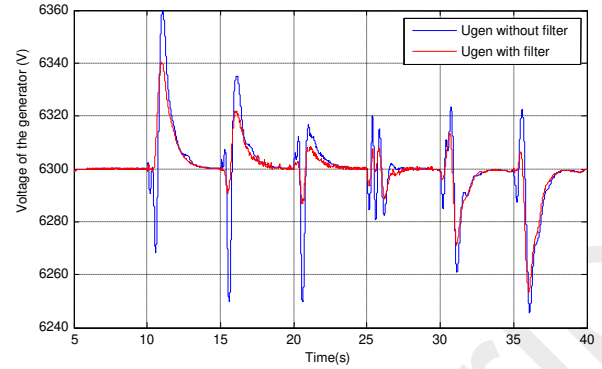

Figure 13. Generated voltage

The power before generator is compared to the power provided by the wind on Fig. 14: the observed difference is due to many friction phenomenons, inserted in the simulation model. Final power values before the generator are very close to static and theoretical values provided by wind turbine manufacturer.

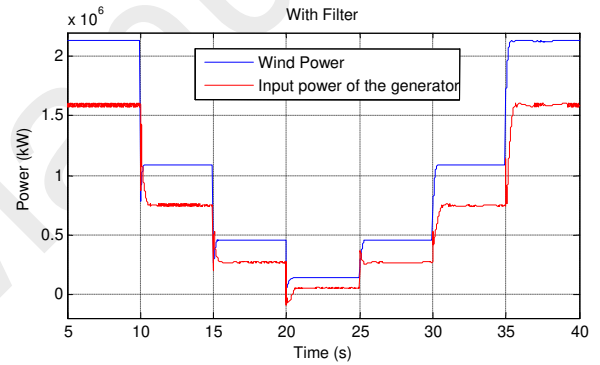

Figure 14. Comparison between wind power and power at the input of the generator

CONCLUSION

In this paper, the design of a robust controller for the control of the low shaft speed of a simple wind turbine model is presented. A mechanical element (planetary gear) is used to achieve a variable gear ratio. Thus, that methodology could be applied to many other types of systems whose operating range is known.

Our controller ensures good and robust performances. Its dynamic performance is really necessary for varying wind conditions as it could ensure a better efficiency. This model could be extended for wind speed from 11 m/s to 25 m/s where a pitch control has to be implemented. Only simulation results are shown. This study could be used to improve wind turbines installed in 2008.

REFERENCES

- Akhmatov V. 2002, "Variable-Speed Wind Turbines with Doubly-Fed Induction Generators – Part I: Modelling in Dynamic Simulation Tools", *Wind Energy Vol. 26, N°2, pp 85-108, 2002*
- Åström, K.J. 1999, "Model uncertainty and robust control design", *Cosy Workshop - ESF Course, Valencia, Spain.*
- Beltran B., Benbouzid M., Ahmed-Ali T., Benzineb O. 2010, "Commande par modes glissants d'ordre supérieur et

- observateur grand gain de la génératrice asynchrone double alimentation d'une éolienne", *Conférence Internationale Francophone d'Automatique Nancy, France, 2-4 juin 2010*
- Bongers, P., van Engelen, T., Dijkstra, S., Kock, Z.-J., 1989, "Optimal control of a wind turbine in full load-a case study," *Proceedings, European Wind Energy Conference and Exhibition, Peter Peregrinus, London, United Kingdom, Vol. xxx+1063, pp. 345-349.*
- Bossanyi, E.A., 1989, "Practical results with adaptive control of the MS2 wind turbine," *European Wind Energy Conference and Exhibition, Peter Peregrinus, London, United Kingdom, Vol. xxx+1063, pp. 331-335.*
- Bouscayrol A., Guillaud X., Teodorescu R., Delarue P. 2005, "Validation of MPPT strategy for a wind energy conversion system using a hardware-in-the-loop simulation", *Proceedings of the 10th International Conference on Optimization of Electrical and Electronic Equipment, Brasov, Romania.*
- Burton T., Sharpe D., Jenkins N. and Bossanyi E. 2001, *Wind Energy Handbook*, Wiley.
- Camblong, H. 2003, "Minimisation de l'impact des perturbations d'origine éolienne dans la génération d'électricité par des aérogénérateurs à vitesse variable". PhDThesis, Ecole Nationale des Arts et Métiers, France.
- CPNV, 2005, "Comparaison entre les moteurs synchrones et asynchrones", *Centre Professionnel du Nord Vaudois, Suisse.* <http://www.electrons.ch/fichiers/Comparaison%20synchrone%20asynchrone.pdf>
- Dubois, C. 2009. *L'éolien, techniques et pratiques.* Eyrolles Editor.
- Ekelund, T., 1994, "Speed control of wind turbines in the stall region." *Proceedings, IEEE International Conference on Control and Applications, IEEE, New York, NY, USA, Vol. xlii+1952, pp. 227-232.*
- Holmes P.G., Elsonbaty N.A. 1984, "Cycloconverter-Excited Divided-Winding Doubly-Fed Machine as a Wind Power Converter", *IEE Proceedings, Electrical Power Applications, Vol. 131, Part B, N° 2, pp. 61-69, March 1984.*
- Lanusse P., Melchior P., Dancla F., Cois O. 2001, *The Toolbox CRONE* <http://cronetoolbox.ims-bordeaux.fr>
http://extranet.ims-bordeaux.fr/LAPS/wlap/events/AT-sdne/Actes/3&4Octobre2001/CRONE_Toolbox.pdf
- Lanusse, P. 1994, "De la commande CRONE de première génération à la commande CRONE de troisième génération". PhDThesis, Bordeaux I University, France.
- Oustaloup, A. 1983, "Systèmes asservis linéaires d'ordre fractionnaire", Masson, Paris.
- Oustaloup, A. 1991. "La commande CRONE". Hermes Editor, Paris.
- Oustaloup, A., B. Mathieu, P. Lanusse 1995, "The CRONE control of resonant plants: application to a flexible transmission", *European Journal of Control, Vol. 1, n°2, pp. 113-121.*
- Pena R.S., Clare J.C., ASHER G.M. 1996, "Doubly Fed Induction Generator Using Back-to-Back PWM Converters and its Applications to Variable-Speed Wind-Energy Generation", *IEE Proceedings, Electrical Power Applications, Vol. 143, N°3, pp. 231-241 May 1996.*
- Poitiers, F. 2003, "Étude et commande de génératrices asynchrones pour l'utilisation de l'énergie éolienne". PhDThesis, Nantes University, France.
- The Mathworks 2010, <http://www.mathworks.com/help/toolbox/physmod/drive/planetarygear.html>