



HAL
open science

About the Foundations of the Black Holes Theory

Hicham Zejli, Florent Margnat, Jean-Pierre Petit

► **To cite this version:**

Hicham Zejli, Florent Margnat, Jean-Pierre Petit. About the Foundations of the Black Holes Theory. 2024. <hal-04637824>

HAL Id: hal-04637824

<https://hal.science/hal-04637824v1>

Preprint submitted on 7 Jul 2024

HAL is a multi-disciplinary open access archive for the deposit and dissemination of scientific research documents, whether they are published or not. The documents may come from teaching and research institutions in France or abroad, or from public or private research centers.

L'archive ouverte pluridisciplinaire **HAL**, est destinée au dépôt et à la diffusion de documents scientifiques de niveau recherche, publiés ou non, émanant des établissements d'enseignement et de recherche français ou étrangers, des laboratoires publics ou privés.



HAL Authorization

About the Foundations of the Black Holes Theory.

H.Zejli¹, F.Margnat², J.P.Petit³

Key words : black hole, Schwarzschild metric, proper time, space bridge, throat sphere, Flamm surface, time factor, two-folds cover, bimetric, Birkhoff theorem, unicity, free fall time, staticity, physical criticality, geometrical criticality, signature, imaginary proper time, crossed term

Abstract : In a broad overview, we discuss the two interpretations that have been given of the outer Schwarzschild solution, depending on whether one opts for uniqueness, in which case the geometric object has a single layer, a structure of a variety with an edge, or non-uniqueness of the solution, i.e. for a configuration in which there are two metrics, each referring to one of the layers of a covering structure with two sheets, joined by a groove sphere. In these two interpretations, the object is non-contractile. The black hole model, as described in Chandrasekhar's 1992 book entitled "Mathematics of Black Holes", is based on the central hypothesis of including in the real world particles whose geodesic trajectories are traversed with pure imaginary proper time, which goes hand in hand with the hypothesis of contractibility of the geometric object, which is then equipped with a central singularity.

1 - Introduction

In 2011, C. Corda published an article [1] entitled "A clarification on the debate on the 'original Schwarzschild solution'" in the form of a simple preprint posted online on the arXiv platform, to which specialists refer anyone wishing to question the physical and mathematical consistency of the black hole model. We propose to return to this question. Recent observations ([2],[3]) of supermassive objects located at the centre of the M87 and Milky Way galaxies, which were immediately described as "Giant Black Holes", are far from being consistent with what characterises black holes in principle, i.e. that their central part is absolutely black. Even if no value is placed on the temperature values displayed, the ratio of maximum temperature to minimum temperature constitutes usable observational data.

¹ Hicham.zejli@manaty.et

² Florent.margnat@univ-poitiers.fr

³ Jean-Pierre.petit@manaty.net

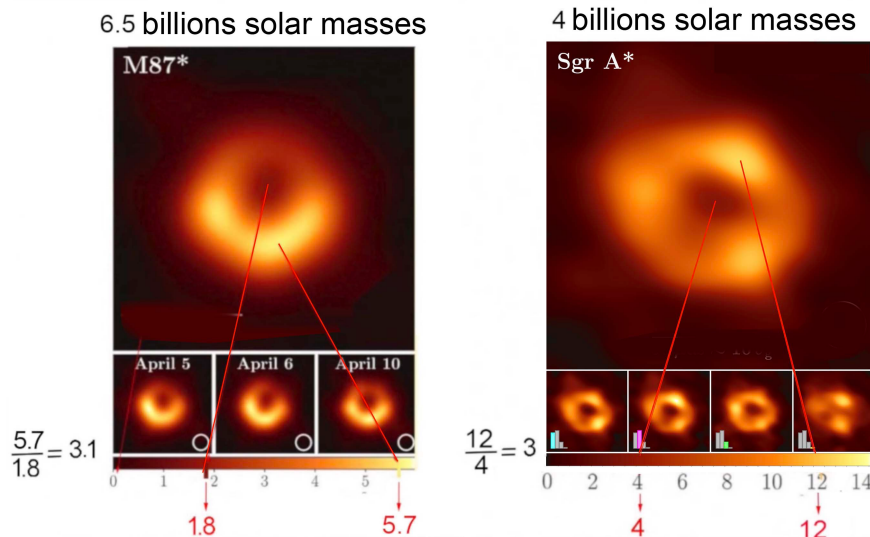

Fig.1 : Images of hypermassive objects M87 and Srg A*

Although the masses and temperatures of these two objects are very dissimilar, the ratios of maximum temperature to minimum temperature are surprisingly close to 3. This closeness can hardly be attributed to chance and, at the end of the article, we will examine the possible significance of this value. Let's take a look back at what is known as the "Original Schwarzschild Solution".

2 - The original Schwarzschild solution.

It corresponds to the two articles published by the author in January 1916 [4] and February 1916 [5], shortly before his death on 11 May 1916. The English translations were not available until very late, the first article in 1975 [6] and the second in 1999 [7], **twenty-four and eighty-three years after their publication in German**. The approach is very clear. The author starts with the field equation as Einstein had just published it two months earlier [8]. In what follows, our equations are sometimes numbered twice. In this case, as below, on the left will appear the numbering of the article and on the right, in italics, the numbering in the article from which this equation is extracted. to cause. Thus, in [5] it is equation (5) :

$$(1) \quad G_{\mu\nu} = -\kappa \left(T_{\mu\nu} - \frac{1}{2} g_{\mu\nu} T \right) \quad (5)$$

where κ is the Einstein constant and T is the Laue scalar. Schwarzschild clearly indicates his course of action, specifying that the calculation of geodesics will be based on the optimisation of the length s . These are equations (1) from [4], which we reproduce exactly as they appear below:

$$(2) \quad \left\{ \begin{array}{l} \delta \int ds = 0 \\ \text{where} \\ ds = \sqrt{\sum g_{\mu\nu} dx_{\mu} dx_{\nu}} \end{array} \right. \quad (1)$$

At the same time, the author constructs stationary solutions of the field equation, with and without a second member. In this approach, which is remarkable for its clarity and physical, geometric and mathematical coherence, he endeavours to ensure the continuity of the solution at the surface of the star. On page 2 of [5] he writes, and we quote:

If one calls t the time, x, y, z , the rectangular coordinates, the most general line element that satisfies the conditions 1-3 is clearly the following :

$$(3) \quad ds^2 = F dt^2 - G(dx^2 + dy^2 + dz^2) - H(xdx + ydy + zdz)^2$$

where F, G, H are functions of $r = \sqrt{x^2 + y^2 + z^2}$

This means that its variable r , which is perfectly defined, can only be positive or zero.

Let's start by analysing the calculation that gives his interior metric, which describes the geometry inside a sphere filled with incompressible matter of constant density ρ_0 . As in all his calculations he used $c = 1$, we will reconstruct the equations by reintroducing this letter where it belongs. The schemes for the two calculations are similar, in terms of the choice of coordinates and the calculation of the components of the tensor of the first member, which is common to both solutions. The interior metric is given in equation (35) of [5]:

$$(4) \quad ds^2 = \left(\frac{3\cos\chi_a - \cos\chi}{2} \right)^2 dt^2 - \frac{3}{\kappa\rho_0} [d\chi^2 + \sin^2\chi d\theta^2 + \sin^2\chi \sin^2\theta d\varphi^2] \quad (35)$$

That we will write:

$$(5) \quad ds^2 = \left(\frac{3\cos\chi_a - \cos\chi}{2} \right)^2 c^2 dt^2 - \frac{3c^2}{8\pi G\rho_0} [d\chi^2 + \sin^2\chi d\theta^2 + \sin^2\chi \sin^2\theta d\varphi^2]$$

Schwarzschild clearly understood that in Einstein's theory the mass content determined the curvature. Since his mass density ρ_0 is assumed to be constant, he relies on a geometry within the mass that is that of a 3D hypersphere, where the constant radius of curvature is:

$$(6) \quad \hat{R} = \sqrt{\frac{3c^2}{8\pi G\rho_0}}$$

whose points are identified by the three angles χ, θ, φ . This hypersphere is then fully described for the values :

$$(7) \quad \chi : (0 \rightarrow \pi/2) \quad \theta : (0 \rightarrow \pi) \quad \varphi : (0 \rightarrow 2\pi)$$

The area of the sphere containing the mass corresponding to $\chi = \chi_a < \pi/2$. The spatial part of the metric is :

$$(8) \quad d\sigma^2 = \frac{3c^2}{8\pi G \rho_0} \left[d\chi^2 + \sin^2 \chi d\theta^2 + \sin^2 \chi \sin^2 \theta d\varphi^2 \right]$$

This is the metric of a sphere S^3 of constant radius of curvature \hat{R} . The determinant of this metric is :

$$(9) \quad g_\sigma = g_{\chi\chi} g_{\theta\theta} g_{\varphi\varphi} = \left(\frac{3c}{8\pi G \rho_0} \right)^3 \sin^4 \chi \sin^2 \theta = \hat{R}^6 \sin^4 \chi \sin^2 \theta$$

Consider a sphere centred on the origin, corresponding to a fixed value χ . Its area is :

$$(10) \quad A = \iint \sqrt{g_{\theta\theta} g_{\varphi\varphi}} d\theta d\varphi = 4\pi \hat{R}^2 \sin^2 \chi$$

So the area of a sphere surrounding the origin can be taken to be zero.

This 3D object is contractile .

We now turn to its exterior metric [4]. After switching to polar coordinates, it introduces a new set of spatial coordinates for computational convenience:

$$(11) \quad \{ x, y, z \} \rightarrow \{ r, \theta, \varphi \} \rightarrow \{ x_1, x_2, x_3 \}$$

According to (equation (7) of [4]):

$$(12) \quad x_1 = \frac{r^3}{3} \quad x_2 = -\cos\theta \quad x_3 = \varphi \quad (7)$$

His variable x_4 is the time variable t (in equation (7) of [4]). Its metric is then written (equation (9) of [4]):

$$(13) \quad ds^2 = f_4 dx_4^2 - f_1 dx_1^2 - f_2 \frac{dx_2^2}{1-x_2^2} - f_3 dx_3^2 (1-x_2^2) \quad (9)$$

First, there is an integration constant α (the future "Schwarzschild radius" R_s). He introduced a second integration constant ρ which was quickly identified with α^3 (equation (13) of [4]). This means that his result is expressed according to equations (10), (11) and (12) of [4], which we rename :

$$(14) \quad f_2 = f_3 = (3x_1 + \nu)^{2/3} = (r^3 + \alpha^3)^{2/3} \quad (10)$$

$$(15) \quad f_4 = 1 - \alpha(3x_1 + \rho)^{-1/3} = 1 - \frac{\alpha}{(r^3 + \alpha^3)^{1/3}} \quad (11)$$

$$(16) \quad f_1 = \frac{(3x_1 + \rho)^{-4/3}}{1 - \alpha(3x_1 + \rho)^{-1/3}} = \frac{(r^3 + \alpha^3)^{-4/3}}{1 - \frac{\alpha}{(r^3 + \alpha^3)^{1/3}}} \quad (12)$$

This would enable him to write his external metric:

$$(17) \quad ds^2 = \frac{(r^3 + \alpha^3)^{1/3} - \alpha}{(r^3 + \alpha^3)^{1/3}} c^2 dt^2 - \frac{r^4}{(r^3 + \alpha^3)[(r^3 + \alpha^3)^{1/3} - \alpha]} dr^2 - (r^3 + \alpha^3)^{2/3} (d\theta^2 + \sin^2\theta d\phi^2)$$

n example of this would be the "Original Schwarzschild Solution". What are its properties? Its determinant is:

$$(18) \quad g = -r^4 (r^3 + \alpha^3)^{1/3}$$

This tends towards zero with r. Let's isolate its spatial part:

$$(19) \quad d\sigma_{(3d)}^2 = \frac{r^4}{(r^3 + \alpha^3)[(r^3 + \alpha^3)^{1/3} - \alpha]} dr^2 + (r^3 + \alpha^3)^{2/3} (d\theta^2 + \sin^2\theta d\phi^2)$$

A limited expansion shows that $g_{rr} \simeq 3r / \alpha \rightarrow 0$ tends towards in the vicinity of $r = 0$. But, apart from the nullity of its determinant at $r = 0$, this metric is by no means singular. Schwarzschild was then faced with the problem of identifying its two solutions (14) and (4). He began by making the change of variable in [4] :

$$(20) \quad \{ \chi, \theta, \phi \} \rightarrow \{ R, \theta, \phi \}$$

with :

$$(21) \quad R = \sqrt{\frac{3c^2}{8\pi G \rho_o}} \sin \chi = \hat{R} \sin \chi$$

His line element becomes :

$$(22) \quad ds^2 = \left(\frac{3}{2} \sqrt{1 - \frac{R_a^2}{\hat{R}^2}} - \frac{1}{2} \sqrt{1 - \frac{R^2}{\hat{R}^2}} \right)^2 c^2 dt^2 - \frac{dR^2}{1 - \frac{R^2}{\hat{R}^2}} - R^2 [d\theta^2 + \sin^2\theta d\phi^2]$$

On the surface of the star $R = R_a$. It comes :

$$(23) \quad ds^2 = \left(1 - \frac{R_a^2}{\hat{R}^2} \right) c^2 dt^2 - \frac{dR^2}{1 - \frac{R_a^2}{\hat{R}^2}} - R_a^2 [d\theta^2 + \sin^2\theta d\phi^2]$$

But:

$$(24) \quad \frac{1}{\hat{R}^2} = \frac{8\pi G \rho_o}{3c^2} = \frac{2GM}{c^2 R_a^3} = \frac{\alpha}{R_a^3}$$

So the internal metric on the star wall becomes:

$$(25) \quad ds^2 = \left(1 - \frac{\alpha}{R_a}\right) c^2 dt^2 - \frac{dR^2}{1 - \frac{\alpha}{R_a}} - R_a^2 [d\theta^2 + \sin^2 \theta d\phi^2]$$

Schwarzschild thus discovered a simple way of identifying the two metrics at the surface of the star. All he had to do in the external metric was to change the variable:

$$(26) \quad R = (r^3 + \alpha^3)^{1/3}$$

roducing what he calls an "intermediate quantity" (Hilfsgröße) which automatically implies that and this metric then becomes:

$$(27) \quad ds^2 = \left(1 - \frac{\alpha}{R}\right) c^2 dt^2 - \frac{dR^2}{1 - \frac{\alpha}{R}} - R^2 [d\theta^2 + \sin^2 \theta d\phi^2]$$

$$R = (r^3 + \alpha^3)^{1/3} \geq \alpha$$

We have therefore simply discovered an initial reason why Schwarzschild chose to present the external metric in this form. At this stage he is trying to find Einstein's result concerning the advance of Mercury's perihelion [9]. By carrying out the limited expansion, which is explicitly mentioned in his article on page 7

$$(28) \quad R = (r^3 + \alpha^3)^{1/3} = r \left(1 + \frac{\alpha^3}{3r^3}\right) \approx r$$

But it never occurred to him to think that this external metric, considered in isolation, could refer to a physical object..

3 - The construction of Ludwig Flamm' meridian [10] .

In the months that followed, the young mathematician Ludwig Flamm, who was 31 at the time Schwarzschild's article appeared, became interested in this solution, in the form of pairs of connected metrics. He also applied it [10] to evaluate the deviation of light rays grazing the surface of the Sun and obtained the value 1.75", in good agreement with Einstein's result. What is interesting is the precise analysis he gives from the geometric angle. This article remains little known because it was only available in an English translation when it was republished in this form in 2015 [11]. This geometry of Einstein's equation, invariant by time translation, is equivalent to the displacement along this time coordinate of a 3-surface, whose metric is given by the spatial parts of the two solutions. For the interior metric it is :

$$(29) \quad d\sigma_{(3d)}^2 = \frac{dR^2}{1 - \frac{\alpha}{R}} - R^2 [d\theta^2 + \sin^2 \theta d\phi^2] \quad \text{with} \quad R \leq R_a$$

For the external metric, its 3D space part is :

$$(30) \quad d\sigma_{(3d)}^2 = \frac{dR^2}{1 - \frac{\alpha}{R}} - R^2 [d\theta^2 + \sin^2 \theta d\phi^2] \quad \text{with } R \geq \alpha$$

By making flat cuts, corresponding to $\theta = \pi/2$ and then to $\phi = \text{cst}$, we obtain 2-surfaces.
For the inner part :

$$(31) \quad d\sigma_{(2d)}^2 = \frac{dR^2}{1 - \frac{\alpha}{\hat{R}^2}} - R^2 d\phi^2 \quad \text{with } R \leq R_a$$

For the external part :

$$(32) \quad d\sigma_{(2d)}^2 = \frac{dR^2}{1 - \frac{\alpha}{R}} - R^2 d\phi^2 \quad \text{with } R \geq \alpha$$

The two 2-surfaces can be immersed, which means that in both cases, if we do $\phi = \text{cst}$ we can write that $d\sigma^2 = dR^2 + dz^2$. We then obtain two differential equations giving the two portions of the meridian. For the inner part, equation :

$$(33) \quad R^2 + z^2 = \hat{R}^2$$

In other words, a portion of a circle with radius \hat{R} .

For the external part, the equation is:

$$(34) \quad R = \alpha + \frac{z^2}{4\alpha}$$

In other words, a portion of a lying parabola. Hence the figure taken from L.Flamm's article:

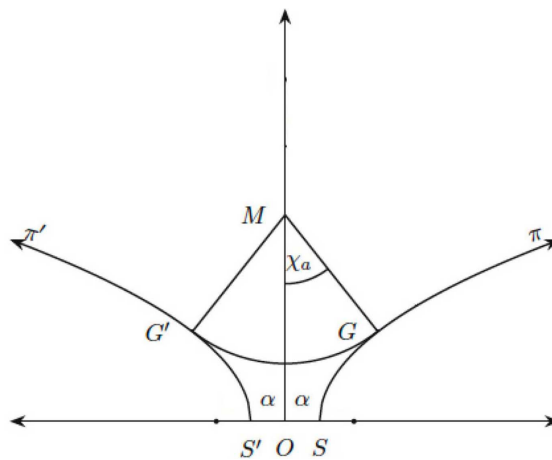

Fig.2 : L.Flamm' meridian curve [10].

At this stage, neither Schwarzschild nor Flamm envisaged treating the Schwarzschild exterior metric, considered in isolation, as a physical object.

4 – Attempts to model a mass by H.Weyl, Einstein and Rosen.

When Schwarzschild's article was published, Weyl was the same age as Flamm. He then envisaged using the external metric to describe a mass as the source of a gravitational field. At a distance, geodesics of non-zero length can be likened to the trajectories of planets, when they are quasi-elliptical, or for certain non-periodic comets, quasi-hyperbolic or quasi-parabolic. The further away we are from the source of this field, the more they tend towards Keplerian conics. **On the other hand, if we move closer, we have to discover what strange geometric structure is responsible for creating the gravitational field that we can then, at a distance, believe to have been created by a point mass. To this end, Weyl had to give the Schwarzschild solution, considered in isolation, the character of a physical object.** He uses the equation published by Einstein in November 2015 [8], which shows the Laue scalar T, instead of the Ricci scalar R in the standard form that is now traditionally used.:

$$(35) \quad R_{ik} - \frac{1}{2} g_{ik} R = - T_{ik}$$

He also constructed geodesic trajectories of zero length ($ds = 0$) corresponding to the paths of light rays. For the material particles affected by the field, he unambiguously states:

$$(36) \quad ds^2 = g_{ik} dx_i dx_k > 0$$

Geodesics, which can be deduced from the variation:

$$(37) \quad \delta \int \sqrt{F} ds = 0$$

Then considering the case of solutions invariant by time translation, he, like all his contemporaries, materialised a type signature (+---) by writing the metric in the form:

$$(38) \quad ds^2 = f dx_4^2 - d\sigma^2 = f dt^2 - h dr^2 - \mu (d\theta^2 + \sin^2 \theta d\varphi^2)$$

Like Flamm, he isolates the temporal part from the spatial part. And, like Flamm, he constructs the equation of the meridian in the form of a recumbent parabola:

$$(39) \quad R = \sqrt{8a(R - 2a)}$$

He designates the Schwarzschild radius by the quantity $2a$. He therefore has three unknown functions f, h, μ of r to determine: . Like Hilbert [13] and Droste [14] he chooses to reduce his calculation to just two unknown functions by posing , which will have the advantage of immediately evoking the identification with the Lorentz metric at infinity, and arrives at the result :

$$(40) \quad ds^2 = \left(1 - \frac{\alpha}{R}\right) dt^2 - \frac{dr^2}{1 - \frac{\alpha}{R}} - R^2 (d\theta^2 + \sin^2 \theta d\varphi^2)$$

We have deliberately used the letter R instead of r to show that this is Schwarzschild's "intermediate coordinate" (Hilfsgröße), which is limited to $R \geq \alpha$, in contrast to his coordinate $r = \sqrt{x^2 + y^2 + z^2}$, which can take on any value. In so doing, Droste limited himself to describing the trajectories of planets and comets. **Weyl considers that this geometric structure is made up of two folds, connected by a sphere**, an aspect to which we shall return in detail later. Moreover, he was not the only one to envisage this sort of topological modelling, since Einstein and Rosen [15] did the same, 18 years later, starting from the expression (33) and noting that their transformation :

$$(41) \quad u^2 = R - 2m \geq 0$$

The imperative $ds^2 \geq 0$, opted for by Flamm, Droste and Weyl, implies denying all reality to portions of the object such as $R < 2m = \alpha$, corresponding to the interior of the gorge sphere, whose existence is explicitly mentioned in [15], we quote:

The writers investigate the possibility of an atomistic theory of matter and electricity, while excluding the singularities of the field, with a mathematical representation of physical space of two identical sheets, a « particle » being represented by a « bridge » connecting these sheets.

Like H. Weyl, Einstein and Rosen were the first to suggest a structure of universes constituting a two-sheet covering of the variety composed of points associated with coordinates $\{ t, R, \theta, \varphi \}$ which thus split into pairs of adjacent points:

$$(42) \quad \left\{ u = +\sqrt{R - 2m}, \theta, \varphi \right\} \quad \text{and} \quad \left\{ u = -\sqrt{R - 2m}, \theta, \varphi \right\}$$

There is therefore no uniqueness of the stationary solution with $SO(3)$ symmetry. But the Einstein and Rosen model is not Lorentzian at infinity.

It is possible to opt for another set of coordinates:

$$(43) \quad \{ t, R, \theta, \varphi \} \rightarrow \{ t, \rho, \theta, \varphi \}$$

Using the change of variable [16]:

$$(44) \quad R = \alpha (1 + L_n \operatorname{ch} \rho)$$

Cette métrique extérieure devient :

$$(45) \quad ds^2 = \frac{\operatorname{Log} \operatorname{ch} \rho}{1 + \operatorname{Log} \operatorname{ch} \rho} c^2 dt^2 - \frac{2 + \operatorname{Log} \operatorname{ch} \rho}{1 + \operatorname{Log} \operatorname{ch} \rho} \alpha^2 \operatorname{th}^2 \rho d\rho^2 - \alpha^2 (1 + \operatorname{Log} \operatorname{ch} \rho)^2 (d\theta^2 + \sin^2 \theta d\varphi^2)$$

ρ is not "a new radial variable". It's the expression "radial variable" that doesn't make sense. And the same applies to the letters r or R. Coordinates are simply ways of

identifying points in the manifold. The only relevant quantity is the length s , which must then be identified with the proper time τ by posing $s = c\tau$. The geometric object then explicitly has two folds. The first is traversed giving ρ values from minus infinity to 0, the second from 0 to plus infinity. The two layers are joined along a sphere with a throat of area $4\pi\alpha^2$ (minimal, in the case of the family of $SO(3)$ -invariant spheres). This is the fundamental property of the geometric object that is the solution to Einstein's equation: it is **non-contractile**. And this time, unlike the Einstein-Rosen bridge, this structure creates a link between two Lorentzian spaces. It is a 3D object that undergoes translation in the direction of time. Cutting it at constant gives a 2D object, the Flamm surface:

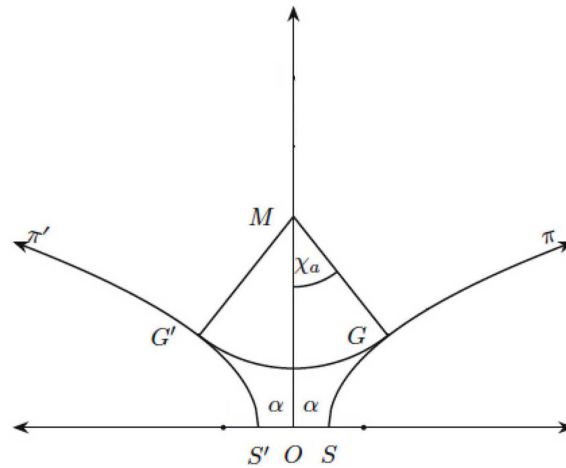

Fig.3 : Flamm's surface meridian curve.

5 – Describing an unsteady phenomenon using a stationary metric.

The most general form of a time-independent $SO(3)$ -invariant solution is ([1], [17]):

$$(46) \quad ds^2 = h(r)dr^2 + k(r)(d\theta^2 + \sin^2\theta d\phi^2) + l(r)dt^2 + a(r)dr dt$$

Such a solution is not invariant to changing t to $-t$. So, for the same coordinate $\{t, r, \theta, \phi\}$ point, we might expect to have not one solution, but two. Now, in physics, when theorists are looking for a solution to a differential equation, or to a system of differential equations, they first give themselves boundary conditions, and then try to construct a solution that is unique. In the case of the search for a stationary solution to the Einstein equation, these boundary conditions consist of imposing that the solution be Lorentzian at infinity. If we focus on the requirement of uniqueness, we obtain G.D.Birkhoff's theorem [18]. This then rules out the presence of a cross term in $dr dt$. **Such a solution is then invariant by time inversion, which is not based on any physical constraint.** It is then qualified as **static**, as opposed to stationary, which expresses invariance by temporal translation. But, for example in [10], [12], [15], [16], there are interpretations of the stationary solution with spherical symmetry that reveal a different topology, with two sheets connected by a throat sphere, described as a bridge by Einstein and Rosen. **So the non-uniqueness of the solution is not simply permitted, but necessary, in order to differentiate between what refers to one of the slicks and what refers to the other.** We can therefore see that Birkhoff's theorem implies an additional, implicit hypothesis of a topological nature. If we consider the two-folds structure, which is also non-contractile, then the presence of the cross term

in $dr dt$ is necessary. Its implications have been studied by the mathematician P. Koiran[19]. These two solutions implement the change of coordinates initially proposed by Eddington [20], in order to eliminate the coordinate singularity in $R = \alpha$:

$$(47) \quad t' = t + \frac{\alpha}{c} L_n \left(\frac{R}{\alpha} - 1 \right)$$

To make it clear that the scalar R (Schwarzschild's "intermediate quantity") is just a coordinate, a simple way of locating points in the hypersurface, let's replace these coordinates t and R by the Greek letters ζ and ξ . Then we have :

$$(48) \quad ds^2 = \left(1 - \frac{\alpha}{\xi} \right) d\zeta^2 - \frac{d\xi^2}{1 - \frac{\alpha}{\xi}} - \xi^2 (d\theta^2 + \sin^2 \theta d\varphi^2)$$

At this point we should remember that is α an simple integration constant, whose value can be negative. Thus, if Newtonian imperatives, in the component where the observations are made, dictate that :

$$(49) \quad \alpha = \frac{2GM}{c^2} > 0$$

The line element :

$$(50) \quad ds^2 = \left(1 + \frac{\alpha}{\xi} \right) d\zeta^2 - \frac{d\xi^2}{1 + \frac{\alpha}{\xi}} - \xi^2 (d\theta^2 + \sin^2 \theta d\varphi^2)$$

is also a stationary and spherically symmetric solution of the field equation, with zero second member. Its geodesics therefore suggest **repulsion**. Remember that only the quantity s is relevant and has a physical meaning. We will apply the change of variable to equation (48):

$$(52) \quad \{ \zeta, \xi, \theta, \varphi \} \rightarrow \{ \zeta', \xi, \theta, \varphi \}$$

With (Eddington's change of variable [20]): (53)

$$\zeta = \zeta' + \alpha L_n \left(\frac{\xi}{\alpha} - 1 \right)$$

The equation (48) becomes :

$$(54) \quad ds^2 = \left(1 - \frac{\alpha}{\xi} \right) d\zeta'^2 - \left(1 + \frac{\alpha}{\xi} \right) d\xi^2 - \xi^2 (d\theta^2 + \sin^2 \theta d\varphi^2) - \frac{2\alpha d\xi d\zeta'}{\xi}$$

P. Koiran [19] has shown that, in this form, with this cross term, this Schwarzschild solution goes hand in hand with a finite free-fall time and an infinite escape time.

We can now just as easily apply the change of variable to equation (50):

$$(55) \quad \zeta = \zeta' - \alpha L_n \left(\frac{\xi}{\alpha} - 1 \right)$$

This line element becomes :

$$(56) \quad d\bar{s}^2 = \left(1 + \frac{\alpha}{\xi} \right) d\bar{\zeta}'^2 - \left(1 - \frac{\alpha}{\xi} \right) d\xi^2 - \xi^2 (d\theta^2 + \sin^2 \theta d\varphi^2) + \frac{2\alpha d\xi d\bar{\zeta}'}{\xi}$$

Always with :

$$(57) \quad \alpha = \frac{2GM}{c^2} > 0$$

This representation (56) of the Schwarzschild solution goes hand in hand with a finite escape time and an infinite free-fall time. With this pair of solutions, this bimetric representation of the stationary solution with spherical symmetry, we obtain a two-folds, non-contractile structure, equipped with a throat sphere, representing a passage linking two Minkowski spaces, whose geodesics can, in a short finite time, only be traversed in one direction. **It's a one way membrane.**

Thus, the fact of considering a non-uniqueness, a bimetric solution, which then authorises the presence of a cross term by combining space and time variables, makes it impossible to use the stationary solution to describe the implosion of a star.

Tu sum up :

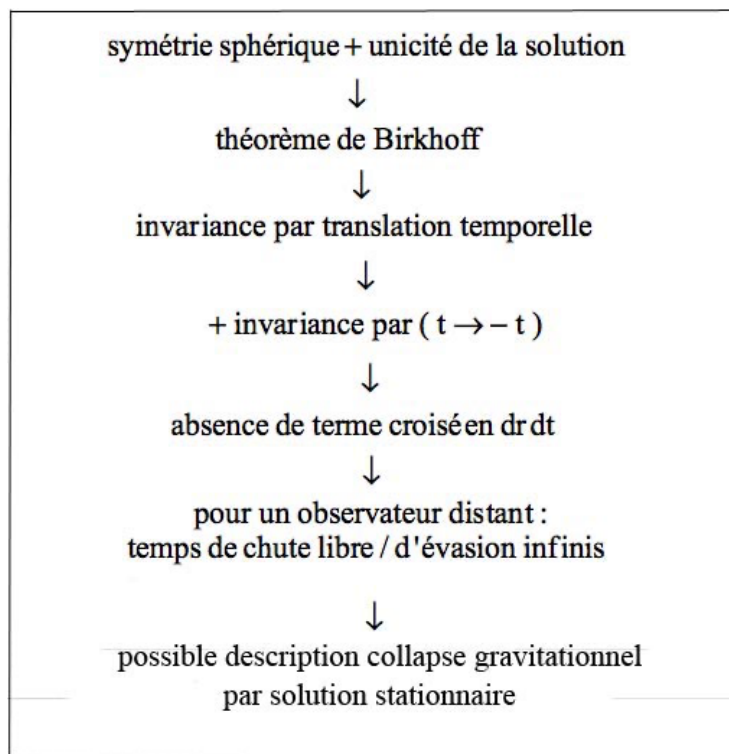

Fig.4 : Assuming uniqueness of solution

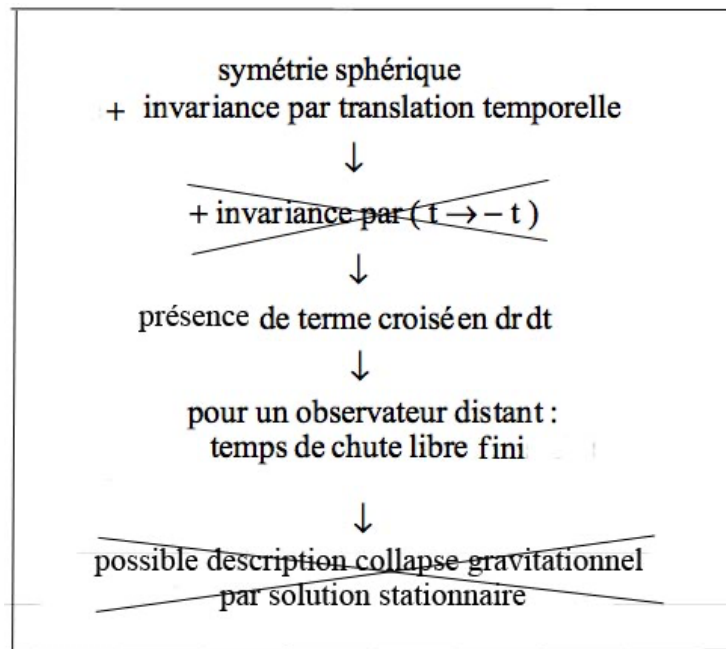

Fig.5 : Bimetric solution.

We can see that the article by Oppenheimer and Snyder [21], the founder of the black hole model, is based on an assumption of the uniqueness of the solution, devoid of any physical justification.

6 - The debate and C. Corda's "clarification" [1].

It is therefore this article that we should now concentrate on because, quoted by all the specialists, it is supposed to shed light on this question of the "Schwarzschild metric in an 'original' or 'standard' form". It presents different presentations of the solution, with different qualifiers. He acknowledges that the "standard" form found in the literature is not the "original" form constructed by Schwarzschild on the basis of his hypotheses.

In what follows we shall reproduce extracts from C. Corda's publication, which includes numbered equations and reference calls. As we have done above, so that the reader can tell the difference, the numbering of the equations, as it appears in Corda's article, will be placed to the right of the equations and in italics. As before, we will add our own numbering of these same equations, to the left of them. His own references will also be in italics.

In equation (1) he presents "the standard form of the Schwarzschild solution".

$$(58) \quad ds^2 = \left(1 - \frac{r_g}{r}\right) dt^2 - r^2 (d\theta^2 + \sin^2\theta d\varphi^2) - \frac{dr^2}{1 - \frac{r_g}{r}} \quad (1)$$

On several occasions he refers to a work by L. Landau and R. Lifschit [22]. At the beginning of section 2, he writes:

« *The more general line-element which respects central symmetry is* » :

$$(59) \quad ds^2 = h(r,t)dr^2 + k(r,t)(\sin^2\theta d\varphi^2 + d\theta^2) + l(r,t)dt^2 + a(r,t)dr dt \quad (2)$$

Where :

$$(60) \quad r \geq 0, \quad 0 \leq \theta \leq \pi, \quad 0 \leq \varphi \leq 2\pi \quad (3)$$

It is important to reproduce his words exactly. So he writes:

At this point, if one wants « the standard solution », i.e. the elements (1) r and t have to be chosen in a way that $a(r,t) = 0$ and $k(r,t) = -r^2$. in particular, the second condition implies that the standard Schwarzschild radius is determined in a way which guaranties the the lenght of the circumference centred in the origin is $2\pi r$ [42].

In our approach, we will suppose again that $a(r,t) = 0$, but, differently from the standard analysis, we will assume that the lenght of the circumference centered in the origin is not $2\pi r$. We release an apparent different physical assumption, i.e. the arches of circumférence are deformed by the presence of the mass of the central body M . Note that this different physical hypothesis permit to circumnavigate the Birhoff theorem [4] (our reference [18]) In fact, the demonstration of the Birkhoff Theorem starts from a line element in which $k(r,t) = -r^2$ has been chosen.

Then, we proceed assuming $k = -mr^2$, where m is a generic function to be determined in order to obtain that the length of circumferences centred in the origin of the coordinate system are not $2\pi r$. In other words, m represents a measure of the deviation from $2\pi r$ of circumferences centred in the origin of the coordinate system.

The line element (2) becomes :

$$(61) \quad ds^2 = hdr^2 - mr^2(\sin^2\theta d\varphi^2 + d\theta^2) + ldt^2. \quad (5)$$

One puts

$$(62) \quad \begin{aligned} X &\equiv \frac{1}{3}r^3 \\ Y &\equiv -\cos\theta \\ Z &\equiv \varphi \end{aligned} \quad (6)$$

He writes, which is correct, that if we want to obtain the "standard solution", i.e. our equation (58) (or hiss equation (1)), we must remove the cross term and ensure that the coefficient of $(d\theta^2 + \sin^2\theta d\varphi^2)$ is r^2 . He then presents Schwarzschild's calculation as an agreed deviation from this second hypothesis, which seems obvious to him, namely that **the perimeter of a closed curve, lying in**

a plane, is $2\pi r$, for which there is no physical justification. This "deviation" from this "standard solution", the only relevant one according to him, results in the replacement of r^2 by a function m . What follows is the identical calculation made by Schwarzschild [4]. He then explains the result in equation (28):

$$(63) \quad ds^2 = \left[1 - \frac{a}{(r^3 + a^3)^{1/3}} \right] dt^2 - (r^3 + a^3)^{2/3} (\sin^2 \theta d\varphi^2 + d\theta^2) - \frac{d(r^3 + a^3)^{2/3}}{1 - \frac{a}{(r^3 + a^3)^{1/3}}} \quad (28)$$

where he replaces the integration constant a with the Schwarzschild radius r_g :

$$(64) \quad ds^2 = \left[1 - \frac{r_g}{(r^3 + r_g^3)^{1/3}} \right] dt^2 - (r^3 + r_g^3)^{2/3} (\sin^2 \theta d\varphi^2 + d\theta^2) - \frac{d(r^3 + r_g^3)^{2/3}}{1 - \frac{r_g}{(r^3 + r_g^3)^{1/3}}} \quad (30)$$

He gives this final expression of the external metric, by Schwarzschild, without making it fully explicit. We are going to do it and he comes:

(65)

$$ds^2 = \frac{(r^3 + r_g^3)^{1/3} - r_g^3}{(r^3 + r_g^3)^{1/3}} c^2 dt^2 - (r^3 + r_g^3)^{2/3} (d\theta^2 + \sin^2 \theta d\varphi^2) - \frac{r^4}{(r^3 + r_g^3) \left[(r^3 + r_g^3)^{1/3} - r_g^3 \right]} dr^2$$

This is identical to equation (17) in this article. The constant a is none other than the characteristic length r_g , is the "Schwarzschild radius", designated by α . This result means that his function m is, which he specifies in equation (29):

$$(66) \quad m = \frac{(r^3 + a^3)^{2/3}}{r^2} \quad (29)$$

The behaviour of the "original Schwarzschild metric", corresponding to equation (17), was examined above. With these coordinates the variable r can take any non-negative value, given its definition by Schwarzschild. The geometric object is **non-contractile**. The point $r = 0$ can be described as the "origin of the coordinates". Corda then introduces the change of variable (his equation (31)):

$$(63) \quad \hat{r} = (r^3 + r_g^3)^{1/3} \quad (31)$$

As a result, he obtains (his equation (32)):

$$(64) \quad ds^2 = \left(1 - \frac{r_g}{\hat{r}}\right) dt^2 - \hat{r}^2 (d\theta^2 + \sin^2\theta d\phi^2) - \frac{d\hat{r}^2}{1 - \frac{r_g}{\hat{r}}} \quad (32)$$

It then becomes important to reproduce his own words, in the knowledge that all black hole specialists invoke this article, simply positioned on the arXiv database, and not published in a peer-reviewed journal, as soon as someone questions the relevance of the "standard interpretation" of the Schwarzschild outer solution, as the basis of the black hole model. We quote him:

Eq. (32) looks formally equal to the "standard Schwarzschild solution" (1). But one could think that the transformation (31) is forbidden for the following motivation. It transfers the origin of the coordinate system, $r = 0, \theta = 0, \phi = 0$, which is the surface of a sphere having radius r_g in the \hat{r}, θ, ϕ coordinates, in a non-dimensional material point $\hat{r} = 0, \theta = 0, \phi = 0$ in the \hat{r}, θ, ϕ coordinates. Such a non-dimensional material point corresponds to the point $r = -r_g, \theta = 0, \phi = 0$ in the original r, θ, ϕ coordinates. Thus, the transformation (31) could not be a suitable coordinate transformation because it transfers a spherical surface, i.e. a bi-dimensional manifold, in a non-dimensional material point. We will see in the following that this interpretation is not correct.

On the other hand, we are searching solution for the external geometry, thus we assumed $r \geq 0$ in Eq.(3) and from Eq. (31) it is always $\hat{r} \geq r_g$ in Eq. (30). In this way there are not physical singularity in Eq. (32). In fact $r = 0$ in Eq. (30) implies $\hat{r} = r_g$ in Eq. (32) which corresponds to the mathematical singularity at $X = 0$. This singularity is not physical but is due to the particular coordinates t, X, Y, Z defined defined by the transformation (6).

Again, we emphasize the apparent different assumption of our analysis. As it is carefully explained in [42], the "standard Schwarzschild solution" (1), arises from the hypothesis that the coordinates r and t of the two functions (4) are chosen in order to guarantee that the length of the circumference centred in the origin of the coordinate system is $2\pi r$. Indeed, in the above derivation of "the original Schwarzschild solution" (30), r and t are chosen in order to guarantee that the length of the circumference centred in the origin of the coordinate system is not $2\pi r$. In particular, choosing to put the mathematical singularity of the

function A at $X = 0$ is equivalent to the physical condition that the length of the circumference centred in the origin of the coordinate system is $2\pi(r^3 + r_g^3)^{1/3}$. Then, one could think that by forcing the transformation (31) for $r \leq 0$, one returns to the standard Schwarzschild solution (1), but a bi-dimensional spherical surface, that is the surface of the Schwarzschild sphere, is forced to become a non-dimensional material point and we force a non-Euclidean geometry for circumferences to become Euclidean. In that case, such a mathematical forcing could be the cause of the singularity in the core of the black-hole. Thus, this singularity could be only mathematical and not physical. But in the following, by matching with the internal geometry, we will see that this interpretation is not correct and that the singularity in the core of the BH remains a physical singularity also in the case of the "original Schwarzschild solution" given by Eq. (30).

Notice that at large distances, i.e. where $r_g \ll r$, the solution (30) well approximates the standard Schwarzschild solution (1), thus, both of the weak field approximation and the analysis of astrophysical situations remain the same.

We have underlined in red the geometric object described by C. Corda as a '*non-dimensional material point*'. We have not been able to find a definition of such an object in mathematics or geometry, **and it seems to exist only in the imagination of its author.**

He then describes the portion of space corresponding to the value $\hat{r} = r_g$ of the coordinate singularity, i.e. in the system $\{t, \hat{r}, \theta, \varphi\}$, which is correct, but he errs in saying that this coordinate singularity is also present in $r = 0$, i.e. in the Schwarzschild coordinate system $\{t, r, \theta, \varphi\}$. In this system the form of the metric corresponds to equation (55). In $r = 0$ the potentials of this metric are not singular at all. It is significant that C. Corda did not fully explain the metric in this form, which suggests that he analysed Schwarzschild's original calculation only very briefly.

Let us summarise the scheme of the calculation as Schwarzschild led it

- It starts with Cartesian coordinates $\{t, x, y, z\}$
- Then he shifts to polar coordinates $\{t, r, \theta, \varphi\}$ with $r = \sqrt{x^2 + y^2 + z^2} \geq 0$
- He uses a third system, for computational convenience (equation (7) from [4]) :

$$(55) \quad x_4 = t \quad , \quad x_1 = \frac{r^3}{3} \quad , \quad x_2 = -\cos\theta \quad , \quad x_3 = \varphi \quad (7)$$

- He gets his metric potentials expressed in $\{x_3, x_1, x_2, x_3\}$

$$(56) \quad f_4 = 1 - \frac{\alpha}{(3x_1 + \alpha^3)^{1/3}} \quad (10)$$

$$(57) \quad f_1 = \frac{(3x_1 + \alpha^3)^{1/3}}{1 - \frac{\alpha}{(3x_1 + \alpha^3)^{1/3}}} \quad (11)$$

$$(58) \quad f_2 = f_3 = (3x_1 + \alpha^3)^{2/3} \quad (12)$$

- He did not publish his result, which he would have done if he had gone back to coordinates $\{t, r, \theta, \varphi\}$, because he realised, after having no doubt explained it, that he would have difficulty making the junction with his internal metric, first expressed in spherical coordinates $\{t, \chi, \theta, \varphi\}$, then expressed in polar coordinates using :

$$(69) \quad R = \sqrt{\frac{3c^2}{8\pi G \rho_0}} \sin \chi = \hat{R} \sin \chi$$

- To negotiate this connection between the two metrics, it then makes a final change of variable in its external metric, passing from its r coordinate to an intermediate quantity (HilfsgöÙe) R according to :

$$R = (r^3 + \alpha^3)^{1/3}$$

variable designated by the character \hat{r} in Corda's article.

In his articles Corda uses coordinates X, Y, Z , which are the coordinates x_1, x_2, x_3 . He is right that in the coordinates $\{x_4, x_1, x_2, x_3\}$ the non-regularity of the term introduces this coordinate singularity. But it disappears in the system $\{t, r, \theta, \varphi\}$ because when r tends towards zero, , see equation (16), g_{rr} tends towards $3r/\alpha$, i.e. towards zero, and not towards infinity.

One thing is clear. The "standard form" of the solution results entirely from a transformation of the form envisaged by Schwarzschild (equation (6) in [4]):

$$(70) \quad \begin{aligned} ds^2 &= Fdt^2 - G(dr^2 + r^2d\theta^2 + r^2 \sin^2 \theta d\varphi^2) - Hr^2 dr^2 \\ &= Fdt^2 - (G+H)dr^2 - G(r^2d\theta^2 + r^2 \sin^2 \theta d\varphi^2) \end{aligned} \quad (6)$$

The first person to modify this expression was David Hilbert, on 23 December 1916 [23]. In Schwarzschild's presentation, three functions of $r : F, G, H$ are to be determined. Hilbert wrote:

According to Schwarzschild the most general metric conforming to these assumptions is represented in polar coordinates

$$(71) \quad \begin{aligned} w_1 &= r \cos \theta \\ w_2 &= r \sin \theta \cos \varphi \\ w_3 &= r \sin \theta \sin \varphi \\ w_4 &= l \end{aligned}$$

by the expression

$$(72) \quad F(r)dr^2 + G(r)(d\theta^2 + \sin^2 \theta d\varphi^2) + H(r)dl^2 \quad (42)$$

where $F(r), G(r), H(r)$, are still arbitrary functions of r . If we put

$$(73) \quad r^* = \sqrt{G(r)}$$

Then we are equally justified in interpreting r^, θ, φ as spatial polar coordinates. If we introduce r^* in (42) instead of r and eliminate the sign $*$, the result is the expression*

$$(74) \quad M(r)dr^2 + d\theta^2 + \sin^2 \theta d\varphi^2 + W(r)dl^2 \quad (43)$$

Don't look to Hilbert for high-geometry justifications. He simply sees this as a way of having to determine only two functions, instead of three.

Corde cites Droste's construction of the solution in 1917[14] as leading to "the standard form of Schwarzschild's solution". Droste presents his solution in the form:

$$(75) \quad ds^2 = w^2 dt^2 - dr^2 - v^2 (d\theta^2 + \sin^2 \theta d\varphi^2) \quad (4)$$

Droste, too, realised that the construction of the solution could be reduced to that of two unknown functions, in this case w and v . He made two successive changes of variable :

$$(76) \quad \{ t, r, \theta, \varphi \} \rightarrow \{ t, x, \theta, \varphi \} \rightarrow \{ t, \xi, \theta, \varphi \}$$

Which gives :

$$(77) \quad ds^2 = (1 - \xi)dt^2 - \frac{4\alpha^2}{(1 - \xi)\xi^4}d\xi^2 - \frac{\alpha^2}{\xi^2}(d\theta^2 + \sin^2 \theta d\varphi^2)$$

He then faced the problem of boundary conditions: How to choose a new space variable such that, as it tends towards infinity, the metric tends towards the Lorentz metric. The solution was quickly found :

$$(78) \quad \xi = \frac{\alpha}{r}$$

The result is what Corda calls "the standard form of the Schwarzschild solution" .:

$$(79) \quad ds^2 = \left(1 - \frac{\alpha}{r}\right) dt^2 - \frac{dr^2}{1 - \frac{\alpha}{r}} - r^2 (d\theta^2 + \sin^2 \theta d\varphi^2) \quad (7)$$

In fact, the only constraint is that when the value of a spatial coordinate tends towards infinity, the metric has a Lorentzian form. Otherwise, all coordinate forms are possible and refer only to different representation systems. In fact, these choices are simply different ways of representing the same object, where the only intrinsic quantity that is invariant to changes in coordinates is the length s . The scientist is therefore like a blind man who has only one measure of length, using his hands, to assess the shape of an object..

Flamm [10] immediately understood that we could concentrate on the spatial part of a time translation invariant solution. This can be taken into account in the physical solution presented by Schwarzschild in the form of two regular, connecting metrics, without any singular aspect appearing in space. **This 3D geometric object, which we might call the Schwarzschild-Flamm hypersurface, is then contractible.** It turns out that it can be plunged into . And plane cuts can be made in such an object, for example at constant. The plane section of a 3D object is a 2D object. Here is this section, taken from [24]..

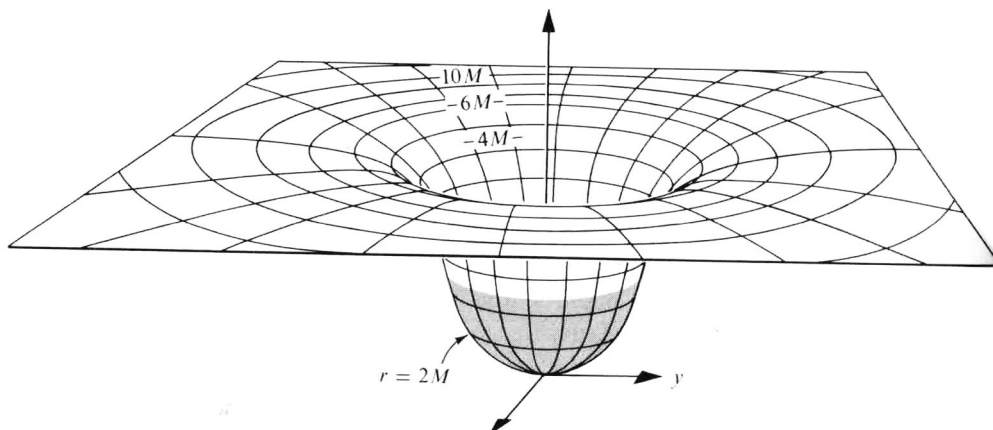

Fig.6 : Schwarzschild-Flamm hypersurface [24].

Pour obtenir l'objet 3D il faut opérer des rotations. Ce faisant il est clair que l'ensemble de l'espace 3D sera balayé et il n'existera aucun de ces points qui n'appartiennent pas à l'hypersurface.

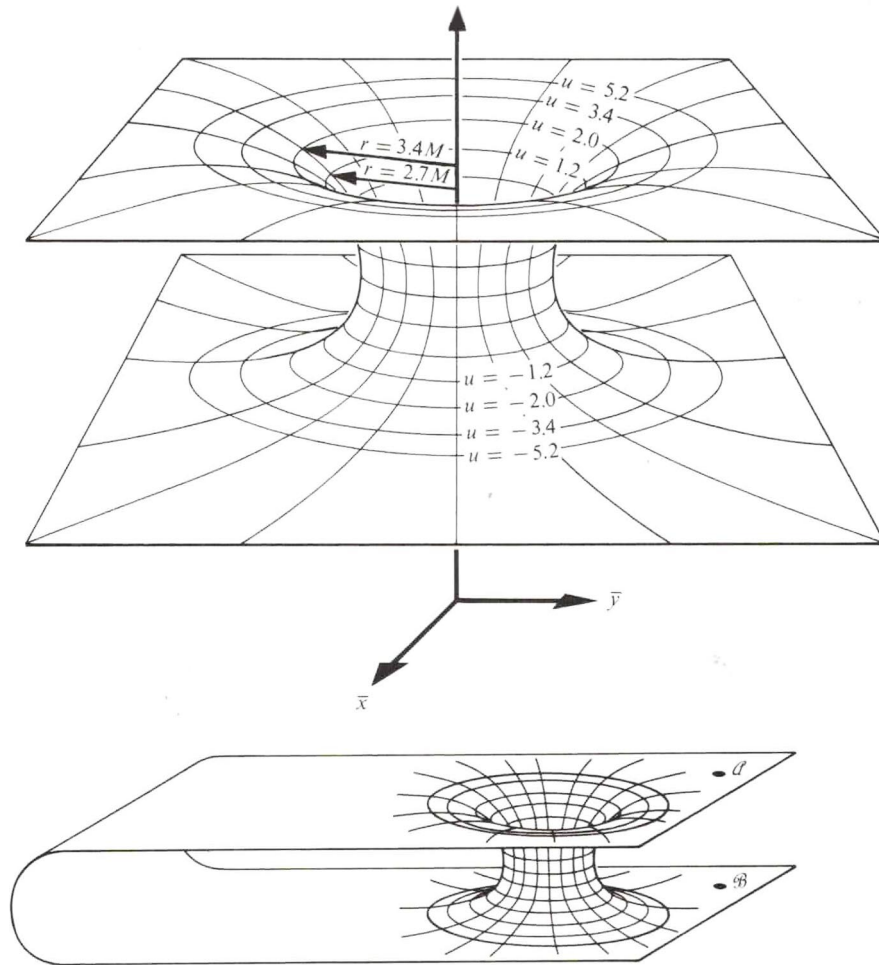

Fig.7 : Flamm's surface [24].

When only the external metric is considered, the 4D hypersurface connects two Minkowski spaces. The cross-section at constant t of a Minkowski space is a 3D Euclidean space. If we make plane cuts of these 3D Euclidean spaces, we obtain planes. It is therefore perfectly relevant to say that the plane cut of the 3D hypersurface gives an object that is a bridge connecting two planes. The object has a throat circle. Now, if we want to generate the 3D object, we need to consider rotations in the 3D plunge space. By doing this, the throat circle will envelop a sphere, the throat sphere. **Only points in the imbedding 3D space outside this sphere will belong to the 3D hypersurface.** A l'intérieur de la sphère les points donneront un $ds^2 < 0$. Le fait de considérer qu'ils appartiennent ou non à la physique dépend des choix retenus.

Figure 6 corresponds to a representation space associated with the coordinates $\{t, R, \theta, \varphi\}$ or $\{t, \hat{r}, \theta, \varphi\}$. What about the 3D space associated with Schwarzschild's initial choice? Once again, this would correspond to a structure linking two Euclidean 3D spaces. The junction would not be made by a sphere of throat, but through a point, which could be likened to "a very small sphere of throat". But this vision is misleading. In fact, this time the 3D object is no longer "plungable".

There is no one representation space that is better than another. It's all a question of knowing what game you want to play. If this approach consists of imposing that $ds^2 \geq 0$, then the solution to the equation delivers the same message, in different forms depending on the geometric context chosen. If we impose the uniqueness of the solution, then there will only be one layer and one metric.

With the space-time associated with the coordinates $\{t, r, \theta, \varphi\}$ or $\{t, R, \theta, \varphi\}$ the 3D hypersurface will have an edge with the topology of a sphere S^2 . In the second case, the sphere will be made up of points with coordinates and the area of this sphere will be . In the first case, the edge sphere will have the same area, but its points will correspond to $\{r = 0, \theta, \varphi\}$. This situation will come as no shock to a geometric mathematician. Similarly, who can create a mental representation of Minkowski space, where the square of the hypotenuse is equal to the difference between two adjacent sides? Who has a mental diagram in which the phenomena of quantum mechanics become clear?

If we consider the possibility of non-uniqueness, of a bimetric solution, the edge sphere becomes a throat sphere.

This being the case, when C.Corda says :

Such a non-dimensional material point corresponds to the point $r = -r_g, \theta = 0, \phi = 0$ in the original r, θ, ϕ coordinates.

this sentence reveals his lack of mastery of the subject, because, given the very definition of these coordinates : $\{t, r, \theta, \varphi\}$ on a $r = \sqrt{x^2 + y^2 + z^2} \geq 0$

Still commenting on the second part of C. Corda's article, we would say that for decades, when black hole specialists have been talking about the foundations of the model, they have always referred to earlier work that would have enabled them to analyse them definitively. We were present in 2017 at the "Schwarzschild Annual Colloquium" held in his home town. Juan Maldacena, a pioneer in black hole physics, was the guest speaker. He began his talk by saying:

- - *Schwarzschild's solution baffled theorists in the early days. But today it has been elucidated and this solution is now well understood. (...)*

Corda is no exception to this rule, writing:

- *In particular, the second condition implies that the standard Schwarzschild radius is determined in a way which guarantees that the length of the circumference centred in the origin of the coordinate system is $2 \pi r$.*
- *Again, we emphasize the apparent different assumption of our analysis. As it is carefully explained in [52] (our reference [25]), the « standard*

Schwarzschild solution » (1) (notre équation(54) , arises from the hypothesis that the coordinates r and t of the two functions are chosen in order to guarantee that the length of the circumference centre in the origin of the coordinate is $2\pi r$.

But no physical or mathematical consideration justifies this hypothesis..

The second part of his article is an attempt to model the implosion of a destabilised star. Before this happens, due to the lack of energy from fusion, the star will tend to collapse in on itself. If it is a neutron star, criticality may be due to an influx of matter from a companion star. In both cases, the collapse of the massive star or the increase in diameter of the neutron star will be accompanied by a rise in temperature and pressure within these objects. Since 1916, we have known about the violent increase in pressure within a sphere filled with an incompressible material of constant density. [5]. Even if we refuse to give credence to this calculation, which suggests a rise in pressure to an infinite value, it is still reasonable to imagine that before this collapse occurs the pressure has already reached a very high value..

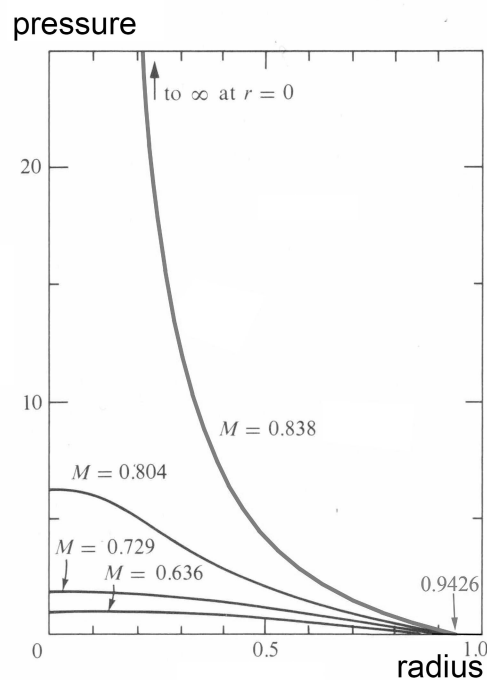

Fig.8 : Evolution of the pressure within a sphere filled with an incompressible material as a function of radius [24].

The collapse model proposed by C. Corda at zero pressure therefore makes no physical sense..

7 – The foundations of black holes theory.

Before the Second World War, all publications in mathematics or theoretical physics journals were based on the following points.

The metric was written as ([4],[9],[6],[10],[12],[14]) :

$$(80) \quad ds^2 = \sum_{ij} g_{ij} dx_i dx_j \geq 0$$

Geodesics were defined as curves minimising a length s . As C.Corda refers to Droste's paper as the first construction of the "standard Schwarzschild solution", we will quote the Lagrangian expression given by Droste [14] in his equation (9):

$$(81) \quad L = \frac{ds}{dt} = \sqrt{1 - \frac{\alpha}{r} - \frac{\dot{r}^2}{1 - \frac{\alpha}{r}} - r^2 \dot{\theta}^2 - r^2 \sin^2 \theta \dot{\phi}^2} \quad (9)$$

At that time, the concept of a signature was not yet used, but it was in fact everywhere in the form $(+ - - -)$. In his presentation, C. Corda discusses the history of this stationary solution to Einstein's spherically symmetric equation. He writes

- A few months after Schwarzschild, J. Droste, a student of H.Lorentz, gave an apparently different solution for the point mass and wrote more extensively about its properties [20] (our reference [14]) . In such a work Droste also claimed that his solution was physically equivalent to the one by Schwarzschild. In the same year, 1917, H.Weyl reobtained the same solution by Droste [21] (our reference [12]). This solution had a peculiar behaviour and what is now called the Schwarzschild radius, where it becomes singular, , meaning that the sum of the terms in the Einstein equation became infinite. The nature of this surface was not quite understood at the time, but Hilbert [22] (our reference [13]) claimed that the forma by Droste and Weyl was preferable in [3] (our reference [6]) and even since the phrase « Schwarzschild solution » has been taken to mean the line element in [20,21]. rather than the original solution in [2] (our reference [26]).

There is only one "Schwarzschild solution", which is presented and interpreted in different coordinate systems. In 1917 [12], H. Weyl analysed the solution of Einstein's equation in vacuum, taken in isolation, in an attempt to geometrize mass, as Einstein and Rosen did in 1935 [15]. He wrote his action (his equation (2) from [12]):

$$(82) \quad \int \left\{ dm \int \sqrt{g_{ik} dx_i dx_k} \right\} \quad (2)$$

He then separates the two elements of the metric according to:

$$(83) \quad f dt^2 - d\sigma^2$$

He specifies the hypothesis concerning the length element:

$$(84) \quad ds^2 = g_{ik} dx_i dx_k > 0$$

And the nature of his r coordinate:

$$(85) \quad r = \sqrt{x_1^2 + x_2^2 + x_3^2}$$

He obtains the expression for his function f :

$$(86) \quad f = 1 - \frac{2a}{r}$$

where $2a$ is the Schwarzschild radius. As L.Flamm did in 1916 [10], he makes a plane section of the 3D object passing through the origin and also gives the equation of the meridian :

$$(87) \quad z = \sqrt{8a(r - 2a)}$$

This is the very first time that this solution has been considered as a two-layer coating, which is worth mentioning.

Let's mention Weyl [12]:

- If the paraboloid is projected orthogonally on the $z=0$ plane with the polar coordinates r, θ the projection covers the exterior of the circle $r \geq 2a$ twice, but does not cover the interior at all.

In other words, this projection is the 2D two-folds covering of a non-contractile variety with a circular edge, perimeter $2\pi r$. He then introduced a second, isotropic coordinate system, where the metric of this "gravitational space" becomes conformal to a Euclidean space, according to the factor :

$$(88) \quad \left(1 + \frac{a}{2r}\right)^2$$

This (now classic) change of variable is:

$$(89) \quad x_1' = \frac{r'}{r} x_1, \quad x_2' = \frac{r'}{r} x_2, \quad x_3' = \frac{r'}{r} x_3, \quad r = \left(r' + \frac{a}{2}\right) \cdot \frac{1}{r'}$$

$$(90) \quad d\sigma^2 = \left(1 + \frac{a}{2r}\right)^4 (dx_1^2 + dx_2^2 + dx_3^2), \quad f = \left(\frac{r - a/2}{r + a/2}\right)^2$$

However, in so doing, Weyl expresses the metric with this new coordinate which he designates by the letter r , but which is no longer the R coordinate of Schwarzschild or \hat{r} from Corda. For ease of reading, we will keep r' and write :

$$(91) \quad d\sigma^2 = \left(1 + \frac{a}{2r'}\right)^4 (dx_1^2 + dx_2^2 + dx_3^2), \quad f = \left(\frac{r' - a/2}{r' + a/2}\right)^2$$

and, repeating Weyl's text, we write:

$d\sigma^2$ is regular for all values $r > 0$, f is always positive and becomes zero only for

$$r' = \frac{a}{2}$$

The circumference of the circle $x_1^2 + x_2^2$ is

$$2\pi r' \left(1 + \frac{a}{2r'} \right)^2$$

if we allow r' to run over its range of values beginning with $+\infty$, then this function decreases monotonocally until it reaches the value $4\pi a$ for

$$r' = \frac{a}{2}$$

after which it begins to increase again as r' is decreased further toward zero, and grows finally without bound.

What is interesting is that H. Weyl has introduced a parameter r' which, varying from $+\infty$ to zero, makes it possible to describe the two layers, with the throat sphere corresponding to the value $a/2$. Of course, he intends to use this geometry to describe a mass, which he therefore imagines to have an exterior, for $r' > a/2$, and an interior, for $r' < a/2$. The most important thing is that he envisages the values of \sqrt{f} , which will be called the "time factor", since it represents the coefficient of dt . And he writes

$$(92) \quad ds = \sqrt{f} dt = \frac{r' - a/2}{r' + a/2} dt$$

Coefficient which would therefore become negative beyond the throat sphere. s is the length, measured along the geodesics and cannot be negative. **The negativity of the time factor would imply, if Schwarzschild's geometry leads to another sheet of space-time, that the time coordinate reverses at the passage of the throat, but not the proper time, in other words that the two sheets are T-symmetrical.** End of this digression regarding the interpretation of Weyl's solution. However, contrary to what Corda writes, Weyl does not find the same solution as Droste and Schwarzschild. To his credit, the English translation of Weyl's text only became available in 2012, after his article had been published.

It is now necessary to return to the article published on 23 December 1916 [13]. Before 1915, Einstein had convinced the great mathematician David Hilbert that the use of modern geometry, which was in the process of being born, would shed a new and powerful light on physics. It should also be remembered that in 1915 :

- We only know two forces, the force of gravity and the electromagnetic force. The electron has just been discovered.

- We have no idea that the universe can evolve over time.

- The deviation from Euclidean geometry and Newtonian and Maxwellian physics, when trains run on steam, is just a tiny phenomenon, part of the philosophy of science, with no immediate physical application.

In 1915 Hilbert, who had just discovered that the high mathematics he championed had some application in physics, applied the principle of least action to electromagnetism and gravitation. In an article entitled "The Foundations of Physics" [27], which dealt jointly with gravitation and electromagnetism, he published what we would today call a "Theory of Everything". In it, he set out his own understanding of special relativity: what did he mean by the presence of a minus sign in the metric? His own answer: **time is simply imaginary, when squared, the minus sign appears**. Whereas Einstein strove to show that this temporal dimension is of the same nature as the other three, and that it must be measured in metres and, incidentally, converted into seconds by dividing by a constant: c . So, for Hilbert, space, with its three coordinates x_1, x_2, x_3 , is 'prime'. Time is just another dimension, grafted onto a quasi-Euclidean space. The relativistic effects do not appear until the very end of the calculation, which is carried out with dimensions w_1, w_2, w_3, w_4 , and it is only in the last line that a time coordinate appears, according to $w_4 = it$. The two articles, from 1915 and 1916, have the same title: "The Foundations of Physics". This is Hilbert's aim: to discover the ultimate workings of the universe, which is governed by what, for him, takes the place of Nature and God: logic. Everything is governed by mathematics, which reveals its facets one by one to enable man to understand the universe. The key words are completeness, consistency and decidability. Hence the motto of an absolute intellectual optimist, which will be engraved on his tombstone in Göttingen

Wir müssen wissen, wir werden wissen

We need to know, and we will know.

For him, the production of measurable quantities, in this case time itself, is the work of the engineer. What counts is the matrix that gives birth to these quantities. And this matrix is a bilinear form, extraordinarily compact and elegant.:

$$(93) \quad G(X_s) = \sum_{\mu\nu}^{1,2,3} g_{\mu\nu} X_\mu X_\nu + i^2 X_4^2 \quad (32)$$

For Hilbert, the metric is just a tiny variation on the Euclidean metric, associated with the Kronecker tensor $\delta_{\mu\nu}$. Curvature is a very small perturbation :

$$(94) \quad g_{\mu\nu} = \delta_{\mu\nu} + \varepsilon h_{\mu\nu} + \dots \quad (37)$$

On 20 November 1915, Hilbert published his first version [27] of his "Fundamentals of Physics", which also contained the field equation, to the great displeasure of Einstein, who published the same equation five days later [8], in the same journal. After a brief moment of hesitation between these geniuses who had become friends, Hilbert decided that

Einstein alone would retain the paternity of what would serve as the basis for general relativity. But in early 1916 Schwarzschild published the first exact solution to this equation [4]. Hilbert then decided to publish a second version of his article, with the same title [13], which incorporated Schwarzschild's result. But he focused his attention only on the exterior metric [4], completely neglecting the February paper on the interior metric [5]. Moving on to polar coordinates, he denoted these new coordinates by $\{ r, \theta, \varphi, l \}$. It is important to quote this key passage in which he presents his bilinear form :

$$(95) \quad F(r)dr^2 + G(r)(d\theta^2 + \sin^2 \theta d\varphi^2) + H(r)dl^2 \quad (42)$$

l is the time coordinate, which becomes it a little further on. The ds^2 has disappeared. At this stage the "signature" is Euclidean: $(++++)$. At this stage Hilbert has three functions of r to determine. With what follows, he reduces this number to two :

where $F(r), G(r), H(r)$ are still arbitrary functions of r . If we put

$$(96) \quad r^* = \sqrt{G(r)}$$

then we are equally justified in interpreting r^*, θ, φ as spatial polar coordinates. If we introduce r^* in (42) instead of r and then eliminate the sign $*$, the result is the expression

$$(97) \quad M(r)dr^2 + r^2 d\theta^2 + r^2 \sin^2 \theta d\varphi^2 + W(r)dl^2 \quad (43)$$

This approach was described as an error by L.S. Abrams [29] and later commented on by S. Antoci [30]. This is not an error, but a simple change in Schwarzschild's notation from the polar co-ordinate system $\{ r, \theta, \varphi \}$ to the system $\{ R, \theta, \varphi \}$ with $R = (r^3 + \alpha^3)^{1/3}$. It remains for Hilbert to provide the result of his calculation

$$(98) \quad G(dr, d\theta, \varphi, dl) = \frac{r}{r-\alpha} dr^2 + r^2 d\theta^2 + r^2 \sin^2 \theta d\varphi^2 + \frac{r-\alpha}{r} dl^2 \quad (45)$$

So we have four + signs, one signature $(++++)$. Then, with $l = it$

$$(99) \quad G(dr, d\theta, \varphi, dt) = \frac{r}{r-\alpha} dr^2 + r^2 d\theta^2 + r^2 \sin^2 \theta d\varphi^2 - \frac{r-\alpha}{r} dt^2 \quad (45bis)$$

You can find the origin of the signature change here:

$$(100) \quad (+----) \rightarrow (-++++)$$

which, in the post-war period, was generalized to the whole of theoretical physics, without it being possible to mention an article in which this transformation was justified. Previously, for example, the Lorentz line element was written as:

$$(101) \quad ds^2 = c^2 dt^2 - dx^2 - dy^2 - dz^2$$

To express the fact that matter moves at a speed slower than the speed of light, it was sufficient to state that $ds^2 \geq 0$. The length s was identified with the proper time τ

according to $s = c\tau$. With Hilbert, attention is now focused on the bilinear form, which we will write as :

$$(102) \quad G \equiv dx^2 + dy^2 + dz^2 - c^2 dt^2$$

How, in these conditions, can a real clean time appear? It's as simple as asking:

$$(103) \quad \tau = \frac{1}{c} \sqrt{-G}$$

This is exactly what Hilbert does in his 1915 article [13], where he writes:

A piece of curve for which

$$(104) \quad G\left(\frac{dx_s}{do}\right) > 0$$

Shal be called a segment and the integral piece of the curve

$$(105) \quad \lambda = \int \sqrt{G\left(\frac{dx_s}{do}\right)} dp$$

Shall be called the length of the segment. A piece of the curve for wich

$$(106) \quad G\left(\frac{dx_s}{do}\right) < 0$$

will be called a time line, and the integral

$$(107) \quad \tau = \int \sqrt{-G\left(\frac{dx_s}{do}\right)} dp$$

evaluated along this piece of curve shall be the proper time of the time line. Finally a piece of curve along which

$$(108) \quad G\left(\frac{dx_s}{do}\right) = 0$$

shall be called a null line.

To calculate geodesics, he uses the variational calculation method, as follows:

$$(109) \quad \delta \int \left(\frac{r}{r-\alpha} \left(\frac{dr}{dp} \right)^2 + r^2 \left(\frac{d\theta}{dp} \right)^2 + r^2 \sin^2 \theta \left(\frac{d\varphi}{dp} \right)^2 - \frac{r-\alpha}{r} \left(\frac{dt}{dp} \right)^2 \right) dp = 0$$

Everything was in place for the birth of the black hole model in the post-war period. In 1992, the future Nobel laureate S. Chandrasekhar [31], who published a book entitled "Mathematical Theory of Black Holes", took up this same Lagrangian:

$$(110) \quad L = \frac{1}{2} \left[\left(1 - \frac{2M}{r} \right) \dot{t}^2 - \frac{\dot{r}^2}{1 - 2M/r} - r^2 \dot{\theta}^2 - (r^2 \sin^2 \theta) \dot{\phi}^2 \right] \quad (80)$$

Let's return to the Droste action, i.e. equation (70). Its Lagrangian is:

$$(111) \quad L = \sqrt{\left(1 - \frac{2M}{r} \right) \dot{t}^2 - \frac{\dot{r}^2}{1 - 2M/r} - r^2 \dot{\theta}^2 - (r^2 \sin^2 \theta) \dot{\phi}^2}$$

Lagrangians (97) and (98) lead to the same Lagrange equations, and therefore to the same geodesic curves. Simply, in the pre-war mathematical context of Einstein, Schwarzschild, Droste, etc , curves such as $ds^2 < 0$ are considered not to belong to the hypersurface, whereas those who now opt for (97) will consider that curves "spiralling towards a central singularity" are "inside the black hole". Chandrasekhar writes;

$$(112) \quad ds^2 = \left(1 - \frac{2M}{r} \right) dt^2 - \frac{dr^2}{1 - 2M/r} - r^2 (d\theta^2 + \sin^2 \theta d\phi^2) \quad (60)$$

on page 96, we quote:

For time-like geodesics, τ may be identified with the proper time s , of the particle describing tge geodesic.

So the particles travelling along the portion of its curve "inside the Schwarzschild sphere" evolve with an imaginary pure time of their own..

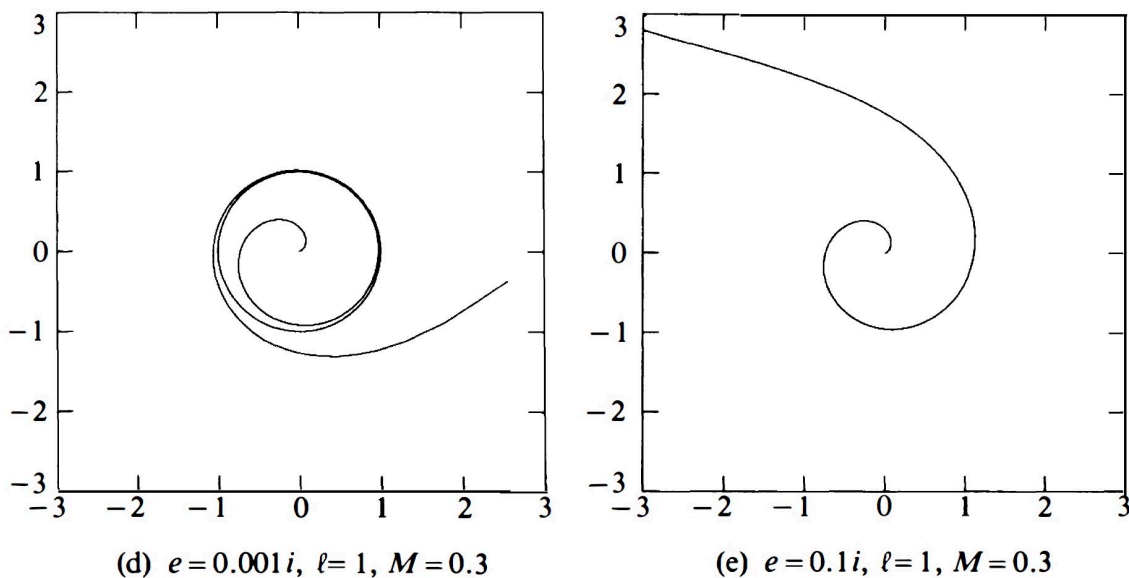

FIG. 7b. Various classes of time-like geodesics described by a test particle with $E^2 > 1$: (a), (b), (c): orbits of the first and the second kind with eccentricity $e = 3/2$ and latera recta, 4.5, 2.5, and 1.94 respectively ($M = 3/14$ in the scale along the coordinate axes); (d), (e): unbound orbits with $l = 1$ and with imaginary eccentricities $e = 0.001i$ and $0.1i$ ($M = 0.3$ in the scale along the coordinate axes).

8 – Conclusion

In this article we have tried to explain the ins and outs of black hole theory. What can we say about the only two data available ([2], [3])? These images do not fit in with the very large number of computer-generated images available. We can try to account for the strong darkening of the central parts, which evokes, for both images, an increase in wavelength by gravitational redshift corresponding to $\lambda'/\lambda=3$. Referring to Schwarzschild's solution for the interior metric [5], we obtain ;

$$(113) \quad \frac{\lambda'}{\lambda} = \frac{1}{\sqrt{1-\frac{8}{9}}} = \frac{1}{\sqrt{1-\frac{2GM}{c^2 R_s}}}$$

in other words, a subcritical object whose mass would be equal to $\sqrt{8/9}$ its Schwarzschild radius, and where the force of gravity would therefore be balanced by the very strong rise in pressure at its centre. What remains to be done is to construct the scenario that would allow the formation of such objects, which would not be giant black holes.

References :

[1] C.Corda : A clarification on the debate on « the original Schwarzschild solution » (2011) 62-82. arxiv :1010 :6031v5 (gr-qc) 25 mar 2011.

[2] First M87 Event Horizon Telescope Results. I. The Shadow of the Supermassive Black Hole. K. Akiyama, A.Alberdi,W.Alef,K.Asada, R.Azulay, A.K.Bcako, D.Ball,M. Balakovic, J. Barrett. Astrophysical Journal, vo. 875, n°1,2019

[3]First Sagittarius A* Event Horizon Telescope Results. I. The Shadow of the Supermassive Black Hole in the Center of the Milky Way. K. Akiyama, A.Alberdi, W. Alef, J.C.Algaba, E. Anantua, K. Asada, R. Azulay, U. Bach, A.K.Backo. The Astrophysical Journal Letters, vol. 930, number 2. 2022. DOI 10.3847/2041-8213/ac6674

[4] K. Schwarzschild : Über das Gravitationsfeld Messenpunktes nach der Einsteinschen Theorie. Sit. Deut. Akad. Wiss. 1916

[5] K. Schwarzschild : Über das Gravitionalsfeld einer Kugel Aus incompressibler Flüssigkeit nach der Einsteinschen Theorie. Sitzung der phys. Math. Klasse v.23 märz 1916

[6] K.Schwarzschild. On the gravitational field of a mass point according to Einstein theory. English translation by S.Antoci and A.Loinger. arXiv :physics/9912033v1 [physics.hist-ph] 16 dec 1999.

[7] English translation, by S.Antoci. On the gravitational field of a sphere of incompressible fluide according to Einstein theory. arXiv :physics/9905030v1

[physics.hist-ph] 12 may 1999.

[8] A. Einstein : Die Feldgleichungen des Gravitation (The Field Equation of Gravitation). Sitzungsber. XLIV , 8 , 778 and XLVI s. 799 (25 nov 1915)

[9] A.Einstein : Erklärung der Perihelbewegung des Merkur aus allgemeinen Relarivitätstheorie. Königlich Preubische Akademie der Wissenschaften (Berlin) Sitzungberichet (25 nov. 1915) p. 831-838

[10] Ludwig Flamm. Beiträge zur Einsteinschen Gravitationstheorie, Physikalische Zestschrift XVII (1916) pp. 448-454.

[11] Ludwig Flamm :Republication of :Contribution to Einstein's Theory of Gravitation. General Relativity and Gravitation. Vol.47 nb 72, (2015)

[12] H.Weyl : Zu Gravitationstherie. Annalen der physik, Vol.35 n° 18 (aug. 1917) <https://onlinelibrary.wiley.com/doi/epdf/10.1002/andp.19173591804> : 49 \$
On the Theory of Gravitation. Reprinted in Gen. Relat. And Gravit. Vol. 44 pp 779-810 (2012). English translation from C.Nutto and S.J.Crothers :<https://www.sjcrothers.plasmaresources.com/Weyl-2.pdf>

[13] D.Hilbert. Die Grundlagen der Physik (Esrte Mitteilung). Nachrochten von der Gesellschaft der Wissenschaften zu Göttingen. Mathematisch-physikalische Klasse. (1916)

[14] J.Droste – The field of a single centre in Einstein's theory of gravitation and the motion of a particle in that field. Ned. Acad. Wer. . SA 1917 lutecium.fr. KNAW, Proceedings 19 I , 1917, Amsterdam, pp. 197-215

[15] A.Einstein and N.Rosen : The particle problem in general theory of relativity. Physical Review 110 (4) : 73-77. 1935

[16] J.P.Petit & G.D'Agostini : Cancellation of the singularity of the Schwarzschild solution with natural mass inversion process. Mod. Phys. Lett. A vol. 30 n°9 2015. arXiv (gr-qc) : 2103.12845v1 23 march 2021.

[17] R.C.Tolman : Relativity, thermodynamics and cosmology. Oxford Clarendon Press. 1935, page 239, equation (94.1) and Static Solutions of Einstein's field equation for a sphere of fluid. Phys. Rev. 1939 nol.55 (15feb. 1939)

[18] G.D. Birkhoff : Relativitiy and modern physics. Cambridge Harvard University Press, 1923

[19] P.Koiran : Infall Time in the Eddington-Finkelstein Metric, with Application do Eddigton-Rosen Bridges. Inter. Jr. of Mod. Phys. D, 14 aug. 2021, to be published. <https://arxiv.org/abs/2110.05938>

[20] A.Eddington : The mathematical Theory of Relativity. Cambridge University Press. 1924.

[21] J.R.Oppenheimer and H.Snyder : On Continued Gravitational Contraction. Phys. Rev. Vol. 56 pp 455-459 sept 1939

- [22] L.Landau et E. Lifshiz : Classical Theory of Fields (3rd ed.) London, Pergamon. Vol. 2 of the Course of Theoretical Physics (1971)
- [24] Gravitation. C.W.Misner, K.S.Thorne, J.A.Wheeler. Pinceton University Press. 2017.
- [25] L.Landau, E. Lifschitz – Classical Theory of Fields (3rd e.) London : Pergamon. ISBN 0-08-016019-0 Vol.2 of the Course of Theoretical Physics (1971)
- [26] P.C.Davis. Rep. Prog.Phys. 41, 1313-1355 (1978)
- [27] D.Hilbert. Die Grundlagen der Physik (Erste Mitteilung). Nachrichten von der Gesellschaft der Wissenschaften zu Göttingen. Mathematisch-Physikalische Klasse. (1915) 395-407.
- [29] L.S. Abrams, Phys. Rev. D20, 2774 (1979) alors in arXiv : gr-qc/0202044.
- [30] S.Antoci, D.E.Liebscher, Gen. Relat. Grav. 35,5,945-950 (2003)
- [31] S.Chandrasekhar :The Mathematical Theory of Black Holes. Okford University Press 1992