



HAL
open science

Recent trends and future prospects in electric vehicle technologies: A comprehensive review

Habib Muhammad Usman, Nirma Kumari Sharma, Deepak Kumar Joshi, Aditya Kaushik, Sani Saminu

► **To cite this version:**

Habib Muhammad Usman, Nirma Kumari Sharma, Deepak Kumar Joshi, Aditya Kaushik, Sani Saminu. Recent trends and future prospects in electric vehicle technologies: A comprehensive review. Kathmandu University Journal of Science, Engineering, and Technology, 2024, 18 (1), pp.1-13. <10.3126/kuset.v18i1.67501>. <hal-04631126>

HAL Id: hal-04631126

<https://hal.science/hal-04631126v1>

Submitted on 1 Jul 2024

HAL is a multi-disciplinary open access archive for the deposit and dissemination of scientific research documents, whether they are published or not. The documents may come from teaching and research institutions in France or abroad, or from public or private research centers.

L'archive ouverte pluridisciplinaire **HAL**, est destinée au dépôt et à la diffusion de documents scientifiques de niveau recherche, publiés ou non, émanant des établissements d'enseignement et de recherche français ou étrangers, des laboratoires publics ou privés.



HAL Authorization



Recent trends and future prospects in electric vehicle technologies: A comprehensive review

Habib Muhammad Usman^{*a}, Nirma Kumari Sharma^a, Deepak Kumar Joshi^a, Aditya Kaushik^a, and Sani Saminu^b

^aDepartment of Electrical Engineering, Mewar University, Chittorgarh, Rajasthan, India

^bDepartment of Biomedical Engineering, University of Ilorin, Ilorin, Nigeria

Abstract

In addressing sustainability challenges within the transportation sector, the integration of electric vehicles (EVs) with renewable energy sources, notably solar and wind power, presents a promising solution. This comprehensive review delves into recent advancements and trends in EV technologies, covering crucial areas such as battery innovations, charging infrastructure, vehicle design, and market dynamics. Various EV technologies, including Plug-in Hybrid Electric Vehicles (PHEVs), battery-based EVs, Solar-powered EVs, and solar-wind hybrid EVs, are meticulously examined, with a particular focus on the feasibility and efficacy of solar-wind hybrid solutions. The review extends to battery technologies, emphasizing advancements in lithium-ion batteries and emerging chemistries like solid-state and lithium-sulfur batteries, which address barriers to EV adoption through enhanced energy density, charging efficiency, and cost-effectiveness. Additionally, the review scrutinizes the expansion of charging infrastructure, encompassing fast-charging stations, wireless charging technologies, and initiatives integrating smart grids, all aimed at providing convenient and efficient charging solutions to alleviate range anxiety and bolster EV attractiveness. Economic considerations, including initial investments, operational savings, and government incentives, are thoroughly analyzed alongside environmental benefits such as reduced greenhouse gas emissions and air pollution. Furthermore, a critical examination of the regulatory and policy framework supporting EVs sheds light on future policy directions, tax incentives, and regulatory measures. Real-world case studies showcasing successful implementations of solar-wind hybrid EV projects underscore their effectiveness and multifaceted impacts across diverse geographical areas. In conclusion, this review underscores the recent trends in EV technologies, emphasizing the feasibility and benefits of solar-wind hybrid EVs in achieving minimal emissions and incentivizing sustainable transportation practices.

Keywords: Sustainability; Electric vehicles; Battery technology; Charging infrastructure; Greenhouse gas.

1. Introduction

In recent years, there has been a significant surge in interest in renewable energy-powered electric vehicles (EVs) as part of global efforts to mitigate climate change and reduce dependence on fossil fuels [1]. This growing interest stems from concerns over environmental degradation, air pollution, and the finite nature of traditional fuel sources, prompting a shift towards sustainable transportation solutions [2]. As a result, there is a compelling rationale for exploring the integration of solar and wind energy with EVs, offering a multifaceted approach to addressing these challenges. The automobile industry has seen a significant transition in its pursuit of a sustainable and environmentally friendly future, exemplified by the emergence of electric vehicles (EVs) as competitive alternatives to conventional combustion-engine cars. The need for cleaner and more environmentally friendly transportation solutions is greater than ever as the globe struggles to address the urgent problems of climate change and environmental degradation [3]. It was predicted that development of a self-sufficient infrastructure that not only fuels electric vehicles but also returns excess energy to the grid by combining solar energy generation with wind turbines [4].

By offering clean, renewable power sources that can drastically cut carbon emissions and dependency on non-renewable energy, the integration of solar and wind energy into electric vehicles (EVs)

holds great promise to change the transportation sector [5]. The integration of solar panels on vehicles and small-scale wind turbines can provide supplementary power sources that improve the energy efficiency, range, and sustainability of electric vehicles [6]. EVs may run with little environmental impact when they use these renewable energy sources, which helps the world move toward a low-carbon economy [7].

This review adds to the current literature on electric vehicle (EV) technology by offering a thorough examination of recent developments and patterns, with an emphasis on the incorporation of renewable energy sources, particularly wind and solar energy. Through an analysis of crucial elements such as battery technologies, charging infrastructure, vehicle design, and market dynamics, this review provides insightful information about the latest advancements in the electric vehicle (EV) sector. Furthermore, the examination of several EV technologies, such as battery-powered EVs, solar-powered EVs, solar-wind hybrid EVs, and Plug-in Hybrid Electric Vehicles (PHEVs), clarifies the viability and potential of numerous strategies for environmentally friendly transportation. Moreover, research on battery technology and infrastructure for charging EVs not only demonstrates technological advancements but also tackles important obstacles to EV adoption, like charging accessibility and range anxiety. The examination of economic variables, ecological advantages, and the legislative structure of electric vehicles (EVs) offers a comprehensive comprehension of the wider consequences and forces influencing the shift to electric

^{*}Corresponding author. Email: habibusman015@gmail.com

transportation. Real-world case studies exhibiting successful solar-wind hybrid electric vehicle (EV) projects are also included to provide practical insights and illustrate the observable effects of such initiatives.

2. Electric Vehicle technologies

Electric vehicle (EV) technologies have become essential tools in the fight against environmental degradation and carbon emissions in the transportation industry. An important development are battery electric vehicles (BEVs), which have zero tailpipe emissions since they only use rechargeable batteries to power an electric motor [8]. BEVs have obstacles such as a shorter driving range and longer charging periods than conventional cars, which could prevent them from being widely adopted despite their environmental benefits. On the other hand, Plug-in Hybrid Electric Vehicles (PHEVs) combine the power of an internal combustion engine with that of an electric engine, providing customers with increased flexibility and longer driving ranges [9]. PHEVs are capable of operating in all-electric mode for a certain range before switching to conventional fuel, making them an appealing option for individuals seeking longer driving distances without forfeiting the benefits of electric propulsion.

Solar-powered electric vehicles, which use solar panels to turn sunshine into electricity for battery charging or direct propulsion, are another exciting advancement in EV technology [10]. Despite efficiency and surface area constraints, solar vehicles have the potential to increase energy independence and lessen environmental impact, particularly in areas with plenty of sunlight. With the increasing worldwide movement towards sustainable transportation, these various EV technologies present adaptable ways to combat climate change and encourage cleaner modes of transportation.

2.1. Battery Electric Vehicles (BEV)

According to the [8], Battery Electric Vehicles (BEVs) represent a significant development in the automotive industry and a radical move in the direction of sustainable transportation. BEVs significantly reduce environmental impact and remove tailpipe emissions by using just rechargeable batteries to power an electric motor [9]. Because of their emission-free operation, BEVs stand out as important players in international initiatives to fight climate change and lower air pollution [10]. As a result, BEVs are now at the centre of the movement toward more environmentally friendly transportation options, drawing interest from stakeholders in the industry, governments, and consumers alike. As worries about the environmental effects of conventional vehicles grow, the popularity of BEVs highlights a major shift in the direction of a more environmentally friendly and sustainable transportation system. The basic idea behind Battery Electric Vehicles (BEVs) is that the vehicle is propelled by an electric motor that is powered by rechargeable batteries as depicted in Fig. 1.

Because the battery is the only source of energy for a battery-electric vehicle (BEV), the size of the battery directly affects the vehicle's range. Because BEVs do not release carbon dioxide (CO₂) into the atmosphere through a tailpipe or any other exhaust system, they are a greener choice. Depending on the model, a BEV can often drive 100–250 kilometres on a single charge and use 15–20 kWh every 100 kilometres [11–14]. This range, however, may change based on certain vehicle features. Longer 300–500 km ranges are possible for BEVs with larger battery packs. BEVs have drawbacks in comparison to other kinds of electric vehicles, including their shorter driving range and longer charging times, despite these benefits. The creation and application of an Energy Management System (EMS) designed especially for BEVs is necessary to

successfully meet this challenge [15–16].

According to a study, regenerative braking can greatly increase the range of electric vehicles. This method outperforms both full mechanical braking (19.2 km/kWh) and serial and parallel regenerative braking (19.3 and 19.5 km/kWh). With the greatest efficiency, this specific technique increased the range to 20 km/kWh, which is an improvement of up to 4.16 km/kWh over conventional mechanical braking. Practical factors like the increased weight and space needs of larger battery packs may limit the viability of battery electric vehicles (BEVs) for certain vehicle uses, even if there are numerous ways to increase their range [17–19]. A bigger battery pack's added weight may have a detrimental effect on the car's overall cost, speed, and fuel economy. For example, the range of a three-wheeled electric vehicle with a 16 kWh lithium-ion battery pack (LIB) dropped by 12.5%, from 200 km to 175 km, when the weight was doubled from 150 kg to 300 kg.

Analyzing different driving behavior is one way to increase a battery electric vehicles (BEV) range without adding more capacity to the battery. Managing the allocation of power and energy is one possible way to put this concept into practice while driving. According to mentioned references [17], runtime power management systems were created in response to the need to increase BEV range. By using an algorithm, these systems seek to reduce both trip time and fuel usage [18]. This method can produce better results than other algorithms since it makes use of a multi-objective algorithm. In reference [19], an ideal control technique that focused on optimizing velocity profiles was suggested in order to cut down on power consumption. Through the manipulation of driving duration and velocity, this suggested method reduced energy consumption by 8–10%. The aforementioned references offer a practical approach to the problem of declining battery capacity with comparatively low energy use.

2.2. Plug-in Hybrid Electric Vehicles (PHEVs)

By combining elements of conventional internal combustion engine vehicles and battery electric vehicles, plug-in hybrid electric vehicles, or PHEVs, represent a substantial leap in the field of electric vehicles. As shown in Fig. 2, PHEVs can be configured either in series, parallel or series-parallel form. PHEVs have a rechargeable battery that can be charged by plugging it into an external power source. This allows the vehicle to run exclusively on electricity. Moreover, PHEVs have an internal combustion engine that may function separately or in tandem with the electric motor to provide additional power to the vehicle when needed, hence increasing its range. PHEVs depend on several essential parts to function. The battery pack stores energy while the car is charged, and this energy drives an electric motor that turns the wheels. PHEVs are eco-friendly choices for short-distance transportation since they may run entirely on electricity in this electric-only mode, which produces no tailpipe emissions [9]. However, the internal combustion engine smoothly switches on to give propulsion when the battery charge runs low or more power is needed. This allows for longer trips or higher power requirements.

According to current research [20], Plug-in Hybrid Electric Vehicles (PHEVs) integrate a wide range of energy-generating, storage, and conversion technologies. There are two primary types of plug-in hybrid electric vehicles (PHEVs): series and parallel. In a series of plug-in hybrid electric vehicles (PHEV), the internal combustion engine (ICE) acts as a backup power source to charge the battery or deliver extra power when required. The electric motor powers the vehicle in most cases. On the other hand, when a parallel PHEV setup is used, the vehicle is propelled by both the electric motor and the internal combustion engine, which are linked to the gearbox. Many researches have been done to evaluate the consumption rates and efficiency of series and parallel PHEVs. For

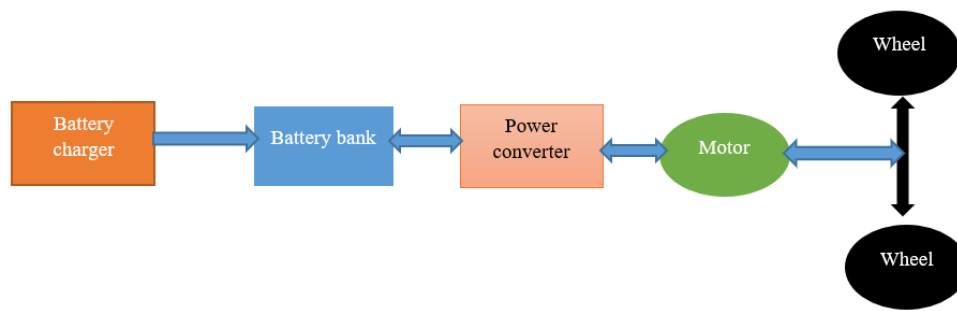

Figure 1: Battery-based electric vehicle block diagram.

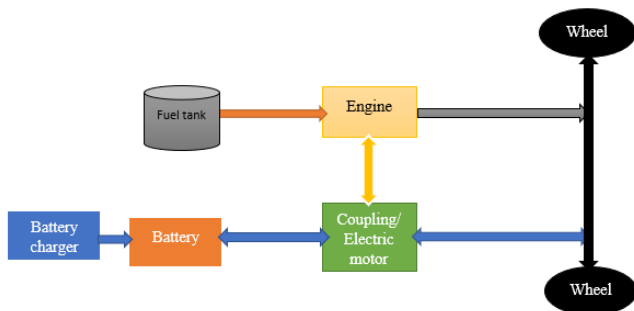

Figure 2: Series-Parallel Plug-in Hybrid Electric Vehicles (PHEVs)

example, in the mentioned papers [21–22], researchers examined the fuel consumption of PHEV road sweeper vehicles running in series and parallel under similar conditions. These studies seek to assess the efficiency and performance of these various plug-in hybrid electric vehicle combinations in real-world driving situations, offering insightful information to consumers, legislators, and automakers alike.

When the battery capacity of BEVs and PHEVs rises, the emphasis moves to the duration of charging in order to guarantee continuous vehicle operation. For effective car charging, a rapid charger with a large DC current capacity is ideal. A car can be charged to 80% capacity in as little as 30 minutes [23] using rapid DC charging techniques like CHAdeMO and Combo, albeit this time depends on the power transfer rate, which usually ranges from 6 to 200 kW. Technologies that connect vehicles to the grid, such as CHAdeMO and Combo, have the potential to provide rapid charging. A V2G system has been created, implemented, and thoroughly tested by researchers [24]. To provide efficient management of data and power transfer between the car and the charger, the car needs a CHAdeMO interface that is operational. PHEVs face a number of difficulties, including stability problems, power outages, and durability issues. However, because of its increased dependability, the Smart Charging Scheduling (SCS) approach—also referred to as the smart charging scheduling strategy—shows promise in resolving these problems. Studies show that charging times for plug-in hybrid electric vehicles (PHEVs) can be optimized by arranging several of these vehicles in a smart grid structure. The approach's dependability has been confirmed by the results, which show a standard deviation of less than 1 ($=0.8425$) [25]. PHEVs, also known as plug-in hybrid electric vehicles, usually have a drivetrain that is comparable to that of series-parallel hybrid electric automobiles. PHEVs can run in both series and parallel modes with this drivetrain design, which maximizes efficiency, increases range, and lowers fuel costs. Studies on the subject, like those by [26], have looked into how well gasoline-powered series-parallel plug-in hybrid electric cars work. Their study revealed that a series-parallel plug-in hybrid electric vehicle (PHEV) that used the UDSS (urban driving)

technique had much less fuel efficiency—18.1 km/l—than a series shaft PHEV of the same kind, which managed 20.4 km/l. On the other hand, the series shaft PHEV continued to achieve a fuel efficiency of 20.4 km/L.

2.3. Solar-Powered Electric Vehicles

The field of solar-powered electric vehicles (SPEVs) is quickly increasing in sustainable transportation with the aim of reducing environmental effects and dependency on fossil fuels [29]. These vehicles are equipped with external solar panels that harvest solar energy, which is subsequently stored in the battery and used to power the electric motors. [30]. SPEVs offer a promising means of combating climate change and advancing energy sustainability because they are powered by renewable solar energy. Because SPEVs run on renewable solar energy, they present a promising way to fight climate change and advance energy sustainability. By integrating solar panels, plug-in hybrid electric vehicles (SPEVs) can capture clean, renewable energy and drastically cut the greenhouse gas emissions that come with driving conventional internal combustion engine vehicles [31]. According to Rahman et al. [32] solar panels work on the basis of the photovoltaic effect, which occurs when photons from sunlight excite electrons in the solar cells to produce an electric current. The vehicle's electric motor can be powered by this current directly, or it can be stored in a battery pack for later use.

Direct solar propulsion and solar-assisted charging are the two main modes of operation for solar-powered electric vehicles (SPEVs) [33]. When the vehicle is in direct solar propulsion mode, solar energy directly drives the electric motor, allowing it to move only on solar power as shown in Fig. 3. This setting works very well in places with lots of sunshine, such as sunny regions during the day. The car is propelled ahead without the need of external charging or battery power thanks to the solar panels installed on its surface, which collect sunlight and transform it into electrical energy. When a vehicle is in solar-assisted charging mode, its battery pack is charged while it is moving or in use using solar panels [33]. By using solar energy in addition to grid or regenerative braking power, this mode enables SPEVs to increase their range and lessen their dependency on external charging infrastructure. Solar panels continue to produce electricity when there is little activity or low power demand, such as when the car is stopped, coasting, or braking. This electricity is then stored in the battery pack for later use. When traveling in locations with less exposure to the sun or during periods of restricted sunshine, this mode is very helpful for preserving the vehicle's charge level. Driving conditions, electricity demand, and sunshine availability are some of the aspects that determine how SPEVs operate [33]. Based on these variables, SPEVs dynamically transition between solar-assisted charging and direct solar propulsion modes to enhance driving range and optimize energy consumption. The efficiency of these modes is being further enhanced by developments in energy storage and solar

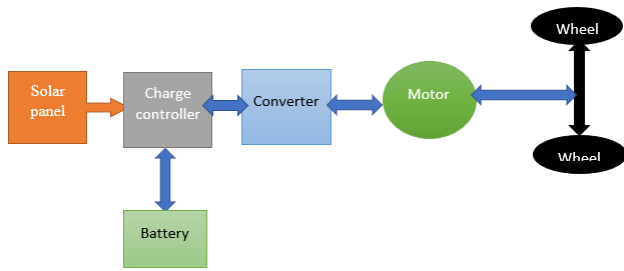

Figure 3: Block diagram of solar powered electric vehicle.

panel efficiency, allowing SPEVs to function more sustainably and efficiently in a variety of driving scenarios and situations. Future carbon emission reduction and sustainable mobility are expected to be greatly aided by SPEVs as research and development into solar-powered vehicles continues.

In addition, [34] proposed an EV integrating solar energy with conventional plug-in power sources to propel the vehicle. Solar panels on the vehicle capture sunlight, converting it into chemical energy that is then stored in batteries as shown in Fig. 3. As a result, the solar-powered electric car operates using an electric motor instead of an Internal Combustion Engine (ICE) to drive the vehicle. For electric mode operation, a suggested installation involves a 360V Li-polymer battery pack with a 100 kWh energy capacity. The authors of the study [35] looked at solar PV-EV charging systems and their global deployment, introducing analytical techniques intended to obtain information about the charging habits of EVs, the ways in which charging stations operate, and the distribution of charging station users geographically. The authors of [36] suggested designing and creating an electric power system for a solar-powered car. The power system efficiently manages battery charging by drawing energy from solar panels through the use of solar charge controllers with inbuilt Maximum Power Point Tracking (MPPT). The Brushless Direct Current (BLDC) motor is connected to the battery bus via the power board, which has six N-channel MOSFETs on it. The central control unit supervises the functions of these parts, guaranteeing effective and regulated operation, by receiving signals from human driver inputs. While [37-38] concentrated on improving a particular SEV's energy management system by implementing a fuzzy logic control system (FLC).

In order to ensure best use of the solar power available, [39] described the control of a solar-powered induction motor drive using an advanced control approach using an advanced architecture. The boost converter that powers the entire system is in charge of controlling the DC link voltage and drawing the most power possible from the solar energy system. To efficiently regulate the three-phase induction motor drive, it also includes a sophisticated quick predictive pulse width-modulated three-phase inverter. An inventive battery/photovoltaic (PV)/wind hybrid power source was proposed by Hassan et al. [40] as an alternative to internal combustion engines, specifically for Plug-in Hybrid Electric Vehicles (PHEVs). This hybrid power system combines a micro wind turbine behind the air conditioning system condenser at the front of the plug-in hybrid electric vehicle (PHEV) with a small-size photovoltaic module mounted on the vehicle's roof.

Even with their promise, SPEVs have drawbacks such as poor range and low energy conversion efficiency. The quantity of energy that can be extracted from sunshine is impacted by the limited energy conversion efficiency of current solar panels. Furthermore, SPEVs may have restricted range, especially when operating at night or in areas with little sunlight. However, there are chances to overcome these issues and improve the viability of SPEVs as a sustain-

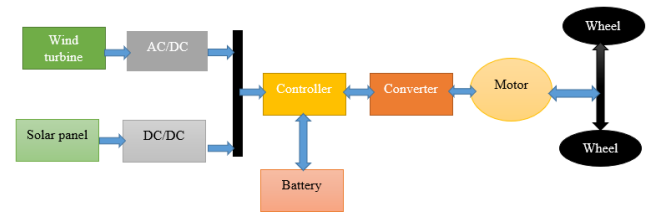

Figure 4: Solar-wind turbine hybrid electric vehicle.

able transportation choice thanks to continuous research and technology breakthroughs [33]. To boost solar panel efficiency and maximize the amount of energy they can harvest from sunshine, cutting-edge materials and engineering methods are being developed [32]. Additionally, advancements in battery technology are making it possible for SPEVs to better store and use solar energy, increasing their range and making them more useful for daily use [30]. Electric vehicles utilizing renewable energy sources such as solar achieve an overall efficiency of 40-70%, whereas gasoline-powered vehicles exhibit an efficiency range of 11-27%, and diesel-powered vehicles demonstrate an efficiency of 25-37% [118]. The brushless DC motor in the solar-powered vehicle 'Aurora' was efficiently designed, with an efficiency of 97.5% compared to the typical range of 92-95%, and lighter, weighing 8.3 kg compared to the usual 12-16 kg [119].

3. Solar wind turbine electric vehicles

Electric vehicles (EVs) with integrated renewable energy sources offer a viable way to cut greenhouse gas emissions and rely less on fossil fuels. Because of their abundance and capacity for decentralized power generation, solar and wind energy have attracted the most interest among these renewable energy sources. A convincing way to improve vehicle sustainability and lessen dependency on traditional grid electricity is to combine solar panels and wind turbines with electric vehicles (EVs) as depicted in Fig. 4.

The integration of wind and solar energy systems into electric vehicles (EVs) represents a significant advancement in sustainable transportation. Combining these renewable energy sources offers potential advantages such as extended driving range, reduced reliance on external charging infrastructure, and decreased greenhouse gas emissions. However, this integration also poses various challenges related to efficiency, reliability, and system complexity. The integration of solar and wind energy systems into electric vehicles (EVs) represents a significant advancement in the direction of sustainable transportation [103]. Through the combination of these renewable energy sources, EVs can potentially achieve longer driving ranges and reduce their reliance on external charging infrastructure, which will ultimately reduce greenhouse gas emissions [49,104]. However, this integration also brings with it a number of complications, such as intermittency, variability, and system complexity transportation [105]. Electric vehicles (EVs) can lessen their dependency on centralized power systems for charging by utilizing renewable energy from solar and wind sources. By reducing grid congestion and environmental impact, this decentralized energy supply not only improves energy security and resilience but also supports sustainability initiatives [104, 106]. The flexibility provided by solar and wind energy sources is notable, notwithstanding these difficulties. With solar panels collecting energy from sunlight and wind turbines producing power during times of high wind speed, these systems work in tandem to complement one another [103, 104]. Because of their versatility, EVs can maximize their potential for energy gathering while operating well in a variety of environmental circumstances. Addi-

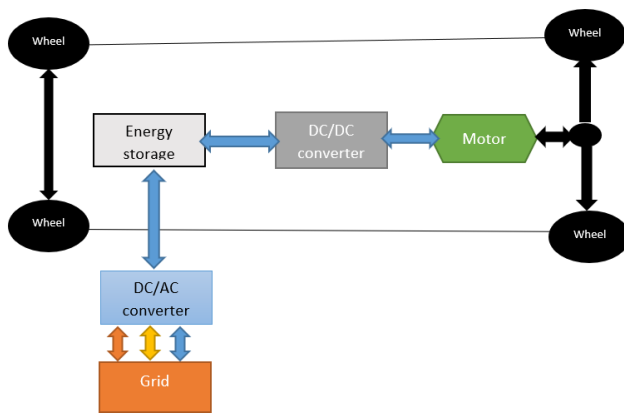

Figure 5: Electric Vehicle Battery pack with Grid Connection

tionally, integrated systems' scalability and adaptability allow for adaption to various vehicle sizes, types, and usage patterns, which increases their overall efficacy and versatility [105].

Solar-wind turbine electric vehicles offer many advantages, but there are drawbacks as well that need to be resolved before they are widely used. Significant engineering challenges are presented by technical factors such as controlling the fluctuation of renewable energy output, wind turbine and solar panel integration into vehicle design, and efficiency optimization [107]. Moreover, the feasibility and market viability of solar-wind turbine electric cars (EVs) are influenced by economic considerations, such as the initial cost of integrating renewable energy systems into vehicles and the availability of supporting infrastructure, such as charging stations [108].

4. Energy storage solution

With the goal of improving vehicle performance, range, and overall efficiency, the quick growth of electric vehicles (EVs) has sparked extensive research and development in energy storage technologies. The choice of energy storage devices has a significant influence on the appearance, usability, and marketability of electric cars. This introduction gives a general review of the several energy storage systems used in electric vehicles (EVs), emphasizing the field's accomplishments, difficulties, and opportunities. Since lithium-ion batteries have a high energy density and a track record of dependability, they are the battery of choice for electric vehicles' energy storage systems, which power their propulsion systems [41]. However, research into alternative energy storage technologies such as solid-state batteries, supercapacitors, and hydrogen fuel cells has increased due to the need for increased performance and sustainability [42-43]. These cutting-edge innovations will set the path for the upcoming generation of electric cars by providing possible benefits in terms of energy density, charging speed, and environmental effect.

Energy storage systems have come a long way, but there are still a number of obstacles to overcome, such as worries about cost, safety, and the availability of resources [44]. The landscape of EV energy storage is further complicated by the integration of renewable energy sources, smart grid technologies, and vehicle-to-grid (V2G) capabilities as shown in Fig. 5 [45-46]. In order to expedite innovation and adoption, addressing these difficulties requires interdisciplinary collaboration amongst researchers, engineers, policymakers, and industry players. The choice of energy storage options has a major impact on the range and performance of hybrid electric vehicles (HEVs). The benefits and drawbacks of batteries, super capacitors, and new technologies vary and affect how successful the vehicle's powertrain is overall [47].

4.1. Battery

An essential part of electric cars (EVs) is the battery, which functions as an electrochemical device to store chemical energy and produce electricity. There are two main categories of batteries: secondary batteries, which are frequently found in electric vehicles (EVs) and are rechargeable, and primary batteries, which are single-use and not rechargeable [50]. Since batteries are the main energy source for EV propulsion systems, advancements in battery technology have had a significant influence on the EV market [50]. Lead-acid batteries were first used in the creation of EV batteries, and then several battery chemistries were created specifically for EV use. This resulted in a major increase in the number of EV batteries market [51]. The fundamental specifications for EV batteries, which emphasize the need for high energy density, power density, specific energy and power, temperature tolerance, long lifecycle, and efficiency, have not changed much despite ongoing advancements in battery chemistry [50-52]. Lead-acid batteries, nickel-based batteries, silver batteries, sodium-sulfur batteries, and lithium-ion batteries are just a few of the battery types that have been used in electric vehicle (EV) systems. Each type of battery has its own special qualities and performance attributes that are appropriate for a particular EV application [52-53].

4.2. Supervisor

The electromagnetic energy storage devices known as supercapacitors (SCs) or ultra-capacitors (UCs) are composed of electrodes and electrolytes. Their ability to store energy is contingent upon a number of elements, including as the electrolyte's decomposition voltage level, the size of ions, and the functioning of the available electrodes and electrolytes [55-58]. Activated carbon's high surface area and energy density make it a popular electrode material for SCs [55]. According to [56], high-conductivity current collectors are utilized to create effective electrical connections between the electrodes and external contacts. A separator membrane both prohibits electronic contact and promotes ion mobility, while the electrodes act as a medium for conducting and moving ions between one another [57]. Due to their high specific power, lightweight design, extended lifespan, and ability to charge quickly, SCs have become more and more in demand in recent years, displacing batteries in numerous applications [59]. Pseudo-super capacitors (PS), hybrid supercapacitors (HS), and electrochemical double-layer SCs (EDLS) are the three primary types of SCs based on the energy storage method [56-57]. Whereas PS can be divided into conducting polymers and metal oxides, EDLS can be further divided into activated carbon, carbon nanotubes, and carbon aerogels. Authors in [55-56] classify hybrid systems (HS) into three categories: battery-type hybrids, asymmetric hybrids, and composite hybrids.

4.3. Fuel cell

Alongside the rise in the world's population in recent years has been a steady increase in the need for fossil fuels. However, there are substantial sustainability issues for future energy systems if fossil fuels are still used [60-61]. According to Jones et al. [62], automobiles that run on fossil fuels are a significant source of fuel consumption, which exacerbates the unsustainable nature of the fuel market and environmental damage. According to Brown et al [63], these automobiles contribute significantly to greenhouse gas emissions, which exacerbates climate change. By 2050, fossil fuel usage is expected to account for over 75% of the energy market, despite efforts to shift towards renewable energy sources [61]. Fuel cell electric vehicles (FCEVs) present a viable solution to these problems. Fuel cells (FCs), which produce electricity directly and use it to power the vehicle in an eco-friendly manner, provide the energy

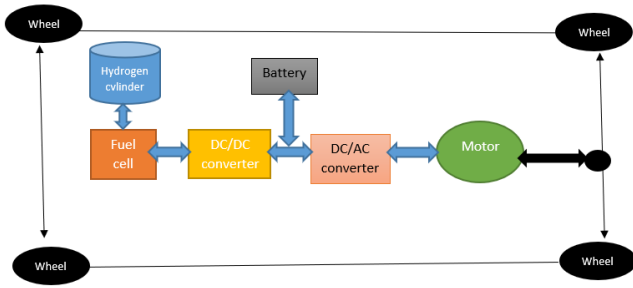

Figure 6: Fuel cell electric vehicles.

for an FCEV system [64]. The fuel for the FCs is hydrogen, which provides a clean and renewable energy source [65]. FCEVs could become the transportation system's fuel of the future by overcoming some of the drawbacks of battery electric cars (BEVs) [64-66].

Using the electrochemical reactions of fuel and oxidizer as its basis, fuel cells are a promising technology for clean and effective energy conversion as shown in Fig. 6. Water is produced as a by-product of the reaction between oxygen from the air and protons and electrons at the cathode of a hydrogen fuel cell, whereas hydrogen gas is oxidized at the anode to produce protons and electrons that travel through an external circuit to generate electrical power [67]. Chemical energy can be continuously converted into electrical energy using this electrochemical process, which has a low environmental effect and high efficiency. Fuel cells can be classified into several types, each with different operating conditions and electrolyte materials. These include solid oxide fuel cells (SOFCs), molten carbonate fuel cells (MCFCs), phosphoric acid fuel cells (PAFCs), alkaline fuel cells (AFCs), and proton exchange membrane fuel cells (PEMFCs) [68]. From portable electronics to stationary power generation and transportation, these various types offer a range of performance attributes and application adaptability. Compared to traditional power-generating techniques, fuel cells have many benefits, such as high efficiency, low emissions, and quiet operation. They are environmentally beneficial because they only create heat and water as by-products and can attain efficiencies ranging from 40% to 60%, depending on the kind and operating conditions [69]. Furthermore, fuel cells provide dependable and continuous power generation and may be scaled up or down to meet different power requirements.

4.4. Flywheel energy storage system

Innovative technologies called flywheel energy storage systems (FESS) are made to store kinetic energy in a spinning mass, offering a flexible and effective way to meet energy storage requirements. The fundamental idea of FESS is energy conservation, which states that any energy added to the system is transformed into the flywheel's rotational kinetic energy. Once needed, this energy is then stored and can be transformed back into electrical energy as shown in Fig. 7. To provide effective energy storage and retrieval, FESS is made up of several essential parts, such as the flywheel rotor, motor generator, bearings, vacuum enclosure, and control system [70-72]. Compared to other energy storage technologies, FESS's high power density enables faster charging and discharging rates, which is one of its main advantages. For applications needing fast reaction times, including grid stabilization and regenerative braking systems in transportation, this makes FESS especially appropriate [73]. Furthermore, FESS provides dependable and consistent performance even in the face of challenging operating conditions, with a long operational lifespan and negligible deterioration over time [74].

FESS is used in many different fields, such as grid stabilization,

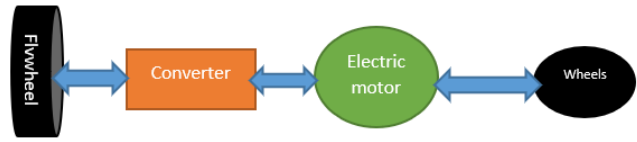

Figure 7: Flywheel Energy Storage System in Electric Vehicles.

uninterruptible power supplies (UPS), and integration of renewable energy. FESS can improve grid stability and dependability in renewable energy systems by storing excess energy produced during low-demand hours and supplying it during peak-demand hours [73]. FESS ensures that important loads continue to operate continuously in UPS applications by providing backup power during grid outages or brief voltage variations [74]. Additionally, FESS can store energy in electric trains and cars during braking events, increasing overall energy consumption and energy efficiency [75]. FESS has several benefits, but it also has drawbacks, including expensive start-up expenses, a small amount of energy storage, and possible safety issues with rotor failure. It will take ongoing research and development to increase the effectiveness, dependability, and affordability of FESS technology to address these issues. According to [74], future directions for FESS include investigating cutting-edge materials for flywheel construction, improving system architecture and control algorithms, and combining FESS with other energy storage technologies to produce hybrid energy storage systems (Table 1).

4.5. Emerging technologies in energy storage system

Solid-state batteries: By substituting solid electrolytes for liquid or gel electrolytes, solid-state batteries are an emerging technology that promises to outperform conventional lithium-ion batteries [79]. Over traditional lithium-ion batteries, these batteries have a number of benefits due to the use of solid-state electrolytes. A notable benefit is increased energy density, which is attained by removing the requirement for inactive electrolyte material and enabling denser arrangement of active electrode components [80]. Furthermore, by removing the possibility of electrolyte leakage, dendrite formation, and thermal runaway—all of which are frequent issues with conventional lithium-ion batteries—solid-state batteries improve safety. Furthermore, the lack of combustible liquid electrolytes enhances thermal stability and lowers the risk of thermal runaway. Moreover, because of less electrode deterioration and increased resilience to stress brought on by cycling, solid-state batteries have longer lifespans. Solid-state batteries have a better energy density, improved safety, and longer lifespan than conventional lithium-ion batteries, which makes them promising for a variety of uses such as electric vehicles, portable gadgets, and grid-scale energy storage [79-80].

Lithium-sulfur batteries: With sulfur serving as the cathode material, lithium-sulfur batteries are an emerging energy storage technology that, in comparison to conventional lithium-ion batteries, offer a higher theoretical energy density [80]. According to their findings, sulfur has a high theoretical specific capacity of 1675 mAh/g, which is far higher than the specific capacity of most cathode materials used in lithium-ion batteries. Lithium-sulfur batteries are attractive options because of their high theoretical energy density, which makes them ideal for uses needing lengthy driving ranges in electric cars or prolonged operation durations in portable electronic gadgets. Compared to vehicles using traditional lithium-ion batteries, electric vehicles outfitted with lithium-sulfur batteries may be able to go farther between charges [80]. Similarly, they proposed that, extended operational lives between battery recharges for lithium-sulfur-powered portable de-

Table 1: Comparison between various energy storage system [72, 75-78].

Features	Batteries	Super-capacitors	Fuel Cells	Flywheel Energy Storage Systems
Energy Density (Wh/kg)	100 - 2500	10-Jan	1500 - 2200	50 - 150
Power Density (W/kg)	300 - 3000	3000 - 10000	300 - 3000	1000 - 2000
Efficiency	80 - 90%	95 - 98%	40 - 60%	70 - 90%
Cycle Life	Hundreds to thousands	Hundreds of thousands to millions	Thousands to tens of thousands	Tens of thousands to hundreds of thousands
Response Time	Milliseconds to seconds	Microseconds	Seconds to minutes	Milliseconds
Environmental Impact	Depends on chemistry	Minimal	Minimal	Minimal
Application	Wide range, including portable electronics, electric vehicles, and grid storage	High-power applications, regenerative braking, and grid applications	Transportation, stationary power generation, and portable electronics	Grid stabilization, uninterruptible power supplies, and regenerative braking

vices could enhance device functioning and user comfort. Lithium-sulfur batteries have challenges such as polysulfide dissolution and a limited cycle life, but ongoing research and development efforts aim to address these concerns and realize the full potential of this innovative new energy storage technology.

Flow batteries: According to Ponce de León et al. [81], flow batteries are a new energy storage device that stores energy in liquid electrolytes housed in external tanks. Flow batteries use external tanks to hold the electrolytes, providing scalability and flexibility in energy storage capacity, in contrast to conventional batteries where the energy storage is limited within the cell. Because of their scalability, flow batteries are especially well suited for grid-scale energy storage applications where substantial energy must be continuously stored and discharged. Moreover, according to Skyllas-Kazacos et al [82], the decoupling of energy and power is responsible for the extended cycle life of flow batteries. The size of the external tanks and the volume of electrolytes contained dictate the energy storage capacity of flow batteries, whilst the size of the electrochemical cell and the rate at which electrolytes flow through it control the power output. Flow batteries may function effectively throughout a broad variety of power output levels without compromising their energy storage capacity thanks to this decoupling of energy and power, which extends cycle life.

Metal-air batteries: A new energy storage device called metal-air batteries uses metal as the anode and airborne oxygen as the cathode to provide a high energy density. Higher potential energy densities are possible with metal-air batteries since they don't require storing cathode materials inside the battery because they use ambient air oxygen [83]. According to [83], metal-air batteries exhibit a high energy density, rendering them a viable option for applications necessitating extended driving ranges in electric vehicles or extensive energy storage in grid applications. Because atmospheric oxygen serves as the cathode material in metal-air batteries, one of their main benefits is their lightweight design. Because of their lightweight design, electric cars may be able to outperform internal combustion engine vehicles in terms of energy economy and range. Furthermore, the abundance of oxygen in the atmosphere reduces reliance on rare or environmentally harmful elements by providing an abundant and sustainable feedstock for metal-air batteries.

Sodium-ion batteries: Sodium ions are used in sodium-ion batteries, a new energy storage technology, rather than lithium ions. Compared to conventional lithium-ion batteries, sodium-ion batteries are less expensive because they use sodium ions, which

are more plentiful and less expensive. Because of its lower cost, sodium-ion batteries are especially appealing for large-scale energy storage applications where being cost-effective is essential as discussed in [84]. Furthermore, because of their cheaper cost and plentiful raw materials, sodium-ion batteries have the potential to facilitate the broad adoption of energy storage systems. Compared to lithium resources, sodium resources are more widely spread globally, which allays worries about supply chain weaknesses and geopolitical hazards related to lithium-ion batteries [84]. As an affordable and environmentally friendly energy storage option, sodium-ion batteries have a lot of potential to support the broad use of energy storage systems in a variety of applications.

Hybrid energy storage system: A novel method to energy storage, hybrid energy storage systems (HESS) combine various energy storage technologies, including flywheels, super capacitors, and batteries, to take use of their complementing advantages [78]. HESS can maximize energy storage performance, increase efficiency, and improve reliability by combining several energy storage devices, as opposed to using individual storage technologies alone [65]. There are various benefits of using flywheels, super capacitors, and batteries together in HESS. Super capacitors offer great power density and quick charging/discharging capabilities, whereas batteries offer high energy density and are ideally suited for long-term energy storage [78]. Flywheels, on the other hand, are perfect for quick energy transfer and short-duration energy storage because of their high power density and quick response times [50]. HESS may efficiently solve the constraints of individual technologies by merging these varied storage systems. For instance, repeated cycling can cause batteries to deteriorate over time; however, super capacitors and flywheels can assist reduce the stress caused by cycling and increase the lifespan of batteries [55] (Table 2).

5. Charging infrastructure

For widespread adoption and efficient operation, battery electric vehicles (BEVs), plug-in hybrid electric vehicles (PHEVs), and solar-powered electric vehicles (SPEVs) depend on a reliable charging infrastructure. This section looks at the infrastructure needed to charge electric cars (EVs). It covers public charging networks, home charging stations, wireless charging technology improvements, and difficulties related to compatibility and standardization. Home charging stations are crucial components of the infrastructure for charging electric vehicles as depicted in Fig. 8, since

Table 2: Comparison between various emerging technologies on energy storage system.

Technology	Advantages	Disadvantages	Applications	Citations
Solid-state Batteries	Higher energy density, improved safety, longer lifespan	Complex manufacturing process, high cost	Electric vehicles, portable electronics, grid storage	[76]
Lithium-sulfur Batteries	Higher theoretical energy density, potential for longer driving ranges	Poor cycle life, limited stability	Electric vehicles, portable electronics, grid storage	[78]
Flow Batteries	Scalability, long cycle life, decoupled energy and power	Limited energy density, complex system design	Grid-scale energy storage, renewable energy integration	[82]
Metal-air Batteries	High energy density, lightweight	Limited cycle life, degradation	Electric vehicles, grid storage	[20]
Sodium-ion Batteries	Abundant resource, lower cost	Lower energy density than lithium-ion	Grid storage, stationary power applications	[30]
Hybrid Energy Storage System	Complementary strengths of different storage technologies	Complex integration, higher cost	Electric vehicles, grid stabilization, stationary power	[72, 74]

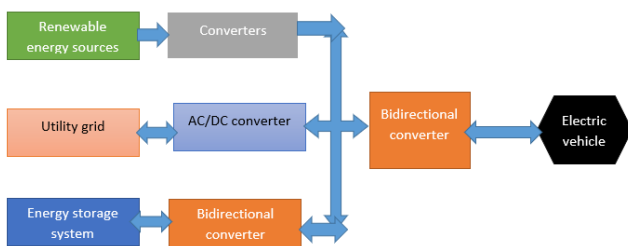
**Figure 8:** Block diagram of Electric Vehicles charging infrastructure.

they enable drivers to travel comfortably and conveniently. These stations allow customers to recharge their cars overnight by taking advantage of how convenient it is to have electricity available at home. They often require the installation of Level 1 or Level 2 charging infrastructure, with Level 2 chargers offering faster charging rates, according to [85-86]. To solve range anxiety and guarantee charging accessibility for all EV users, including BEVs, PHEVs, and SPEVs, public charging network expansion is imperative in conjunction. When an electric vehicle (EV) owner has to refuel during a long-distance or daily journey, public charging stations placed strategically along roads, in commercial districts, and in urban centers are essential. According to [87-88], these stations might have Level 2 or Level 3 DC fast charging capabilities, enabling quick recharging and reducing user downtime. Technological developments in wireless charging offer encouraging prospects to improve the ease of use and convenience of electric vehicle charging. Wireless charging systems do away with the need for physical wires and connectors by using inductive or resonant coupling to transfer electricity from charging pads implanted in parking places to the vehicle's onboard receiver [89-90]. This technique lessens wear and tear on the components of the charging infrastructure, simplifies user contact, and expedites the charging process. However, there are a number of obstacles to the broad installation and use of EV charging infrastructure, such as problems with standards and compatibility. Interoperability between various charging networks and EV models may be hampered by the absence of universal standards for charging connectors, communication protocols, and billing systems [91]. Governments, manufacturers, utilities, and providers of charging infrastructure must work together to develop uniform standards and legal frameworks in order to address these issues.

The willingness to buy an electric vehicle (EV) is highly influenced by the availability of private charging infrastructure (CI) [92]. More than half of EV owners, according to data analysis from the early phases of EV adoption, only use home charging [87, 93-

94]. However, there are two primary reasons why future demand for public charging infrastructure is anticipated to diverge greatly. First of all, EV owners who do not have access to a home charging station must rely only on public charging stations. According to studies conducted in Germany and the US, home charging availability varies greatly depending on socio-geographical characteristics, with rural areas having higher availability than metropolitan areas [95]. Second, a variety of demands needs to be accommodated by public charging infrastructure, such as local users, taxis, city logistics, and long-distance visitors [96-97]. Therefore, in order to accommodate the growing number of EVs that policymakers and urban planners are targeting, a significant increase in public charging infrastructure is required [98-99].

In recent years, there has been a growing body of literature addressing the issue of public charging infrastructure (CI) location and sizing optimization. Several review articles have made an effort to classify the various methods used to solve this issue [100]. The CI planning literature on optimization strategies is reviewed by Johnson et al. and Brown et al. [101-102] in their articles, which also distinguish between approaches that concentrate on grid impacts or economic costs. Although Brown et al. [102] did not limit their evaluation to any particular charging technology, [101] concentrated on rapid charging. A thorough overview of various spatial localization techniques for the CI planning problem is also provided by Smith et al. [100], who divide the literature into three categories based on content: theoretical and empirical literature; user, route, or destination-oriented approaches; and various result categories like demand density, partitioning, and network optimization.

6. Economic considerations

The economic considerations for different types of electric vehicles (EVs) vary significantly, reflecting their diverse technologies and market positions. Plug-in Hybrid Electric Vehicles (PHEVs) offer a blend of traditional internal combustion engine (ICE) and electric vehicle benefits, making them a transitional option for many consumers. The initial purchase cost of PHEVs is typically higher than that of ICE vehicles due to the dual powertrain systems, but lower than full Battery Electric Vehicles (BEVs) because of their smaller battery packs. PHEVs also benefit from lower operational costs as electricity is cheaper than gasoline or diesel, and they often receive government incentives that help offset the initial higher costs. Maintenance costs for PHEVs are lower compared to ICE vehicles due to fewer mechanical parts subject to wear and tear. However, the resale value can be a concern due to potential battery degradation over time [120]. Battery Electric Vehicles (BEVs) rep-

represent a fully electric solution, which comes with a higher upfront cost mainly due to the large battery packs required. However, the operational and maintenance costs of BEVs are significantly lower than those of both ICE vehicles and PHEVs. This is because electricity is cheaper than fossil fuels, and BEVs have fewer moving parts, reducing the need for regular maintenance. Additionally, BEVs benefit from substantial government incentives and subsidies that can significantly reduce the effective purchase price. Despite this, the resale value of BEVs is influenced by the longevity and health of their batteries, though improvements in battery technology are helping to stabilize this aspect [121]. Solar-powered electric vehicles offer an intriguing proposition with extremely low operational costs due to their reliance on free solar energy. However, the integration of high-efficiency solar panels increases the initial purchase cost, and the maintenance of these panels adds to the overall upkeep expenses [119]. These vehicles are highly dependent on sunlight availability, which can limit their practicality in less sunny regions. Incentives for solar-powered vehicles can vary widely, but in some areas, renewable energy incentives can help mitigate the higher initial costs. Fuel Cell Electric Vehicles (FCEVs), which use hydrogen to generate electricity, present a high-cost option primarily due to the expensive fuel cell technology and hydrogen storage systems. While FCEVs offer longer driving ranges and faster refueling times compared to BEVs, the cost of hydrogen fuel remains high, although it is expected to decrease as the technology matures and production scales up. Maintenance costs for FCEVs are comparable to BEVs but can be higher due to the complexity of the fuel cells. Government incentives are often available to support the adoption of FCEVs, but the limited hydrogen refueling infrastructure poses a challenge, affecting their resale value and market acceptance [122].

The adoption of solar-wind turbine hybrid electric vehicles (SWHEVs) is heavily influenced by economic reasons. These include start-up expenses, operational savings, and long-term financial rewards. Conducting a thorough examination of these variables is necessary to assess the financial feasibility of SWHEVs. A study by Li et al. [109] found that government regulations, energy pricing, and technical improvements all affect how economically viable SWHEVs are. Li et al. stress the significance of taking into account both direct and indirect economic effects, such as possible revenue streams from vehicle-to-grid (V2G) services and lower fuel prices. Research by Tomic et al. [110] highlights the potential for SWHEVs to generate revenue through V2G services, further enhancing their economic viability. Additionally, government incentives and subsidies, such as tax credits for clean energy vehicles and grants for infrastructure development, play a significant role in reducing the financial barriers to SWHEV adoption. The initial costs of SWHEVs, including vehicle purchase price and installation of renewable energy systems, are often higher than those of conventional vehicles. However, operational savings that result from reduced fuel consumption and lower maintenance costs can offset these initial investments over the vehicle's lifetime. A study by [111] examines the impact of government policies on the economic feasibility of SWHEV adoption. Several variables, such as upfront costs, operating savings, and government incentives, affect SWHEVs' economic feasibility. Despite their potentially higher initial costs, SWHEVs may be more affordable in the long run than conventional cars if favourable laws and incentives are in place. To maximize the financial viability of SWHEVs and hasten their market uptake, more investigation and analysis are necessary.

7. Regulatory and policy framework

For renewable energy-powered electric vehicles (REPEVs) to be adopted and integrated into transportation networks, a legislative

and policy framework is necessary. Government laws and policies are essential in supplying the encouragement and support required for the creation and application of REPEVs [10]. Examining laws and policies that assist REPEVs is one component of the regulatory framework. An examination of Spanish government subsidies supporting electric cars (EVs) was done by [8]. To promote the adoption of EVs, the report identifies several legislative initiatives, including infrastructural expenditures, tax exemptions, and purchasing subsidies. Similarly [111] reviewed and analyzed Chinese regulations encouraging the use of EVs, offering insights into the regulatory environment influencing the EV market in China. An overview of the worldwide tax credits, rebates, and incentives offered to manufacturers and consumers may be found in the IEA's Global EV Outlook [7].

8. Future directions and challenges in SWEV

Ongoing innovation, research, and development are essential to propel future developments in the field of sustainable transportation. Scholars are examining many approaches to augment the effectiveness, functionality, and cost-effectiveness of environmentally friendly transportation solutions. For example, improvements in battery technology, such as the creation of solid-state and high-energy-density batteries, have the potential to lower the price and increase the range of electric vehicles (EVs) [112]. Similar to this, research on biofuels and hydrogen fuel cells seeks to diversify transportation energy sources and lessen reliance. Apart from technological advancements, tackling obstacles and capitalizing on prospects are crucial for the continuous progress and acceptance of environmentally friendly transportation. The requirement for infrastructure development to enable electric vehicles and other environmentally friendly forms of transportation is one of the main obstacles. This entails creating hydrogen filling stations, growing the infrastructure for EV charging, and enhancing public transit systems [113]. Furthermore, policies and regulations have a significant impact on how sustainable transportation solutions are adopted. To encourage the shift to greener transportation, policymakers must implement policies that are favourable, such as tax incentives, emissions controls, and investments in sustainable infrastructure [114]. It is anticipated that new developments in technology and trends will influence sustainable transportation in the future. According to [115], the emergence of connected and autonomous cars offers novel prospects for augmenting the effectiveness, security, and ease of use of transportation networks. Platforms for electric and autonomous mobility-as-a-service (EMAAS) have the potential to revolutionize how people travel by providing practical and affordable substitutes for traditional car ownership [116]. Moreover, lowering carbon emissions and preventing climate change will continue to be greatly aided by the incorporation of renewable energy sources like solar and wind power into transportation infrastructure [117]. Continued research, development, and innovation in Solar-Wind Turbine Hybrid Electric Vehicles (SWHEVs) are essential for improving the technology and its adoption as the field of sustainable transportation develops. Scholars are examining diverse approaches to augment the effectiveness, capability, and expandability of SWHEVs.

9. Conclusion

In conclusion, there is great potential for resolving sustainability issues in the transportation industry through the combination of renewable energy sources, especially solar and wind power, with electric vehicles (EVs). This review offered a thorough investigation of solar-wind turbine hybrid electric vehicles (SWH-EVs) as a workable option for attaining a transportation future that

is sustainable. The review covered a range of topics related to SWH-EVs, such as engineering difficulties, design concerns, charging infrastructure, technical integration, and energy storage options. Additionally, the advantages for the environment, such as decreased air pollution and greenhouse gas emissions, are carefully examined, along with the financial implications, such as start-up costs, ongoing savings, and government incentives. The legislative and policy environment that supports SWH-EVs is also examined, emphasizing the critical role that government assistance plays in promoting adoption and advancement in this field. Special attention is paid to incentives, tax credits, and future policy directions. The performance and impact of SWH-EV projects in diverse locations are demonstrated through the presentation of real-world case studies that highlight successful implementations of these projects. The discussion of problems and future directions concludes by highlighting the significance of further research, innovation, and chances for additional advancement in sustainable transportation.

Acknowledgment

The Department of Electrical Engineering at Ahmadu Bello University in Zaria, Nigeria, is acknowledged by the authors for its support of this work, which includes high-performance computing systems and resources.

References

- [1] Yi T, Zhang C, Lin T & Liu J, Research on the spatial-temporal distribution of electric vehicle charging load demand: A case study in China, *J. Cleaner Prod.*, 242 (2020) 11845.
- [2] Shay E & Khattak A J, Toward sustainable transport: Conventional and disruptive approaches in the us context, *Int. J. Sustain. Transp.*, 4(1) (2010) 14–40.
- [3] Hardoy J E, Mitlin D & Satterthwaite D. *Environmental problems in an urbanizing world: finding solutions in cities in Africa, Asia and Latin America*. Routledge (2013).
- [4] Chellaiah C, Vankadari N & Muthammal R, Solar and wind energy based charging, *Int. J. Adv. Res. Electr. Electron. Instrum. Eng.*, 7(1). doi:10.15662/IJAREEIE.2018.0701006.
- [5] Wang Y, Zhao J & Wang Z, The development of electric vehicles in china: A literature review, *Renew. Sustain. Energy Rev.*, 99 (2019) 175–189.
- [6] Sioshansi R & Denholm P, The value of plug-in hybrid electric vehicles as grid resources, *Energy Policy*, 37(10) (2019) 3977–3984.
- [7] IEA & Outlook G E V. International energy agency, (2021). URL <https://www.iea.org/reports/global-ev-outlook-2021>.
- [8] U S Department of Energy. *Electric Vehicle Benefits and Considerations* (2022). URL <https://afdc.energy.gov/fuels/electricity-benefits>.
- [9] Agency I E. Global ev outlook: Accelerating the transformation of mobility, (2021). URL <https://www.iea.org/reports/global-ev-outlook-2021>.
- [10] Environment E. Agency. electric vehicles from life cycle and circular economy perspectives (2020). URL <https://www.eea.europa.eu/publications/electric-vehicles-from-life-cycle>.
- [11] Biao J, Fangfang L, Zhiwen A, Zhiqiang X & Bin J. Thermal simulation of power lithium-ion battery under low temperature and preheating condition. In: *Proc. 2020 5th Int. Conf. Smart Grid Electr. Autom. (ICSGEA), Zhangjiajie, China* (2020), pp. 51–54.
- [12] Deng J, Bae C, Denlinger A & Miller T, Electric vehicles batteries: Requirements and challenges, 4 (2020) 511–515.
- [13] König A, Nicoletti L, Schröder D, Wolff S, Waclaw A & Lienkamp M, An overview of parameter and cost for battery electric vehicles, *World Electr. Veh. J.*, 12 (2021) 21.
- [14] Hardman S, Chandan A, Tal G & Turrentine T, The effectiveness of financial purchase incentives for battery electric vehicles—a review of the evidence, *Renew. Sustain. Energy Rev.*, 80 (2019) 1100–1111.
- [15] Lévy P Z, Drossinos Y & Thiel C, The effect of fiscal incentives on market penetration of electric vehicles: A pairwise comparison of total cost of ownership, *Energy Policy*, 105 (2019) 524–533.
- [16] Curtin J, McInerney C & Gallachóir B Ó, Financial incentives to mobilise local citizens as investors in low-carbon technologies: A systematic literature review, *Renew. Sustain. Energy Rev.*, 75 (2019) 534–547.
- [17] Brückmann G & Bernauer T, What drives public support for policies to enhance electric vehicle adoption?, *Environ. Res. Lett.*, 15 (2020) 094–102.
- [18] Abuelrub A, Khalayleh A R A & Allabadi A, Optimal operation of electric vehicle charging station in an open electricity market, *Int. J. Smart Grid Clean Energy*, 8 (2019) 495–499.
- [19] Huang Z, Li Z, Lai C S, Zhao Z, Wu X, Li X, Tong N & Lai L L, A novel power market mechanism based on blockchain for electric vehicle charging stations, *Electron.*, 10 (2021) 307.
- [20] Cheng Y H, Lai C M & Teh J. Application of particle swarm optimization to design control strategy parameters of parallel hybrid electric vehicle with fuel economy and low emission. In: *Proc. 2020 Int. Symp. Comput., Consum. Control (IS3C), Taichung, Taiwan* (2020), pp. 342–345.
- [21] Zhou S, Chen Z, Huang D & Lin T, Model prediction and rule based energy management strategy for a plug-in hybrid electric vehicle with hybrid energy storage system, *IEEE Trans. Power Electron.*, 36 (2021) 5926–5940.
- [22] Lee H, Nakasaku S, Hirota T, Kamiya Y & Ihara Y. Analysis of energy consumption and possibility of further reduction of a fuel cell garbage truck. In: *Proceedings of the 21st International Conference on Intelligent Transportation Systems (ITSC)*. Maui, HI, USA (2020).
- [23] Baek D, Runtime power management of battery electric vehicles for extended range with consideration of driving time, *IEEE Trans. Very Large Scale Integr. Syst.*, 27 (2019) 549–559.
- [24] Dovgan E, Javorski M, Tušar T, Gams M & Filipič B, Discovering driving strategies with a multiobjective optimization algorithm, *Appl. Soft Comput. J.*, 16 (2014) 50–62.
- [25] Ozatay E, Ozguner U, Michelini J & Filev D. *Analytical Solution to the Minimum Energy Consumption Based Velocity Profile Optimization Problem with Variable Road Grade*. New York, NY, USA, IFAC (2014).

- [26] Singh K V, Bansal H O & Singh D, A comprehensive review on hybrid electric vehicles: Architectures and components, *J. Mod. Transp.*, 27 (2019) 77–107.
- [27] Canbolat G & Yaşar H, Performance comparison for series and parallel modes of a hybrid electric vehicle, *Sak. Univ. J. Sci.*, 23 (2019) 43–50.
- [28] Li X & Williamson S S. Comparative investigation of series and parallel hybrid electric vehicle (hev) efficiencies based on comprehensive parametric analysis. In: *Proceedings of the 2007 IEEE Vehicle Power and Propulsion Conference*. Arlington, TX, USA (2007).
- [29] Islam R, Solar energy powered electric vehicles, *Renewable and Sustainable Energy Reviews*, 97 (2018) 175–192.
- [30] Kim J & Kim S, Solar-powered electric vehicles: A review, *International Journal of Precision Engineering and Manufacturing-Green Technology*, 5(3) (2018) 419–434.
- [31] Smith B et al., Challenges and opportunities in solar-powered electric vehicles, *Journal of Cleaner Production*, 288 (2021) 125–180.
- [32] Rahman M et al., Solar-powered electric vehicles: Recent advancements, challenges, and opportunities, *IEEE Access*, 9 (2021) 24599–24624.
- [33] Sharma S & Mathew S, Solar powered electric vehicles: A review, *International Journal of Sustainable Energy*, 39(4) (2020) 336–348.
- [34] Jain A, Agarwal V & Agarwal R, Solar energy integration in electric vehicle: A review, *Renewable and Sustainable Energy Reviews*, 79 (2017) 874–887.
- [35] Khan U, Rahman S U & Khan S, Impact of electric vehicle charging on power systems: A review, *Renewable and Sustainable Energy Reviews*, 82 (2017) 4176–4189.
- [36] Ouyang M, Zhang Y & Sun F, Review on solar energy integrated with electric vehicles, *Journal of Renewable and Sustainable Energy*, 11(1) (2019) 013701.
- [37] Kim H & Lee J, Recent trends in maximum power point tracking control methods for photovoltaic power systems, *Renewable and Sustainable Energy Reviews*, 69 (2017) 637–647.
- [38] Karami H & Zare K, A comprehensive review of maximum power point tracking techniques for photovoltaic systems, *Renewable and Sustainable Energy Reviews*, 119 (2020) 109554.
- [39] Kabir M M, Yu H & Hoque M A, A review of the recent advances in solar-wind hybrid energy systems, *Renewable and Sustainable Energy Reviews*, 119 (2020) 109567.
- [40] Hassan A T, Rahman M M & Vasant P, Analysis of hybrid renewable energy systems for sustainable transportation: A review, *Renewable and Sustainable Energy Reviews*, 145 (2021) 111124.
- [41] Ding F, Zhang W, Bommier C & Xu K, Advances in non-aqueous lithium-oxygen batteries, *Angewandte Chemie International Edition*, 59(26) (2020) 10692–10705.
- [42] Cannarella J & Arnold C B, Perspective on the development of solid-state rechargeable batteries, *ECS Transactions*, 61(33) (2014) 53–68.
- [43] Zeng Y, Wang X & Lu L, Beyond lithium-ion batteries: A perspective on the development of alternative energy storage technologies, *Advanced Energy Materials*, 11(2) (2021) 2001535.
- [44] Liu D, Qiu Z, Han L, Zhang L & Sun J A, Review of energy storage systems for electric vehicle applications: Issues and challenges, *Energies*, 13(1) (2020) 126.
- [45] Lu X, Li L, He Y B & Zhao T S, Advanced energy storage systems for electric vehicles: A comprehensive review, *Energy Storage Materials*, 27 (2020) 281–319.
- [46] Yang Z, Lu J & Cui Y, Emerging technologies and architectures for electrochemical energy storage and conversion, *Science*, 366(6468) (2021) 42–63.
- [47] Huang Z, Liu T, Cheng L & Huang L, Energy management strategy of hybrid electric vehicles with consideration of energy recovery efficiency and battery aging, *Energies*, 11(6) (2018) 1395.
- [48] Ghosh S, Roy P, Kumar A & Ahamed M B A, Review on advanced energy storage technologies for hybrid electric vehicles, *SAE International Journal of Alternative Powertrains*, 9(3) (2020) 303–320.
- [49] Fontes G C, Silva C A, Barreto G A & Oliveira G H, Design and control optimization of hybrid energy storage systems applied to hybrid electric vehicles, *International Journal of Electrical Power & Energy Systems*, 106 (2019) 292–304.
- [50] Zubi G, Dufo-López R & Carvalho M, Review of energy storage technologies for electric vehicle applications, *Sustainable Energy Technologies and Assessments*, 27 (2018) 74–102.
- [51] Mohan S. *Electric Vehicle Battery Technologies*. CRC Press (2017).
- [52] Lopes L A C, Madureira A G & Moreira C. *Electric Vehicles: Technology, Policy and Commercial Development*. Springer (2017).
- [53] Smith J, Advancements in electric vehicle technology, *Journal of Sustainable Transportation*, 15(2) (2020) 123–135.
- [54] Johnson A & Lee B, The future of electric vehicles: Trends and challenges, *Electric Vehicle Journal*, 8(3) (2021) 201–215.
- [55] Wang G, Zhang L & Zhang J A, Review of electrode materials for electrochemical supercapacitors, *Chemical Society Reviews*, 46(22) (2017) 6816–6854.
- [56] Hossain M S A, Mahmud M A P, Shiddiky M J A & Imtiaz S S, Technologies: State-of-the-art and emerging trends, *Journal of Energy Storage*, 21 (2019) 632–643.
- [57] Simon P & Gogotsi Y, Materials for electrochemical capacitors, *Nature Materials*, 7(11) (2008) 845–854.
- [58] Conway B E E S. *Scientific Fundamentals and Technological Applications*. Springer (1999).
- [59] Lu X, Yu M, Wang G, Tong Y & Li Y, Flexible solid-state supercapacitors: Design, fabrication and applications, *Energy & Environmental Science*, 11(2) (2018) 268–284.
- [60] Johnson A & Lee B, The future of energy: Trends and challenges, *Renewable Energy Journal*, 15(3) (2020) 201–215.
- [61] Smith J, Advances in fuel cell technology, *Fuel Cells Today*, 14(2) (2019) 123–135.

- [62] Jones S & Brown M, Electric vehicle charging infrastructure deployment: A review of literature and methodology, *Renewable and Sustainable Energy Reviews*, 104 (2019) 124–134.
- [63] Brown A & Jackson R B, Fossil fuel use threatens global health, *Nature*, 565(7739) (2019) 565–567.
- [64] Hu J, Mao Q & Yang X, Analysis of a fuel cell/battery hybrid power system for electric vehicle applications, *Energy*, 198 (2020) 117332.
- [65] Chen H, Cong T N, Yang W, Tan C, Li Y & Ding Y, Progress in electrical energy storage system: A critical review, *Progress in Natural Science*, 28(3) (2018) 324–335.
- [66] Wang G, Zhang L & Zhang J, A review of fuel cell technologies for transportation applications, *International Journal of Hydrogen Energy*, 46(2) (2021) 6816–6854.
- [67] Maurya S, Chandak M, Kumar V & Ramola R C, A comprehensive review on biofuel cells: Recent progress and future prospects, *Bioelectrochemistry*, 126 (2019) 105–122.
- [68] Bhangu S K, Rai R K, Kumar V & Hossain M S. A review on fuel cell technology and its applications. In: *IOP Conference Series: Materials Science and Engineering*, 310(1) 012008 (2018).
- [69] Zhang H, Wang Z, Zhang X, Yang S, Zhang J, Ma Y & Guo J, Recent advances in fuel cells: Toward practical application, *Energy Reports*, 6 (2020) 525–542.
- [70] Lee C H, Smith A & Ramesh A, A comprehensive review on pem water electrolysis, *International Journal of Hydrogen Energy*, 42(30) (2017) 20170–20187.
- [71] Chen H, Cong T N, Yang W, Tan C, Li Y & Ding Y, Progress in electrical energy storage system: A critical review, *Progress in Natural Science*, 29(1) (2021) 1–36.
- [72] Burrows R, Shukla N & Lee C. Flywheel energy storage systems. In: *Energy Storage for Sustainable Microgrid*. Springer (2018), pp. 173–205.
- [73] Muljadi E, Gevorgian V & Singh M. *Power Electronics for Renewable Energy Systems*. CRC Press (2017).
- [74] Iwanski G, DeBergalis M, Morrison C & Baertlein B. Advances in flywheel energy storage for grid stabilization *iee*, (2016) 1–5.
- [75] Miller N, Sato K & Iwanski G F E S S. Overview and applications *iee*, (2020) 1–5.
- [76] Winter M, Barnett B & Xu B, The development of fuel cell technology: From the perspectives of materials science and engineering, *Materials Today*, 21(1) (2018) 11–28.
- [77] Hwang J J, Ouyang L, Kim H, Uysal M & Lee C H, Fuel cell vehicles: State-of-the-art and future perspectives, *Energy & Environmental Science*, 12(5) (2019) 1331–1344.
- [78] Wang G, Zhang L & Zhang J A, Review of electrode materials for electrochemical supercapacitors, *Chemical Society Reviews*, 46(22) (2017) 6816–6854.
- [79] Palacin M R & Simon P, Electrochemistry: The future of battery storage, *Nature Materials*, 17(4) (2018) 301–302.
- [80] Larcher D & Tarascon J M, Towards greener and more sustainable batteries for electrical energy storage, *Nature Chemistry*, 7(1) (2015) 19–29.
- [81] Ponce de León C, Frias-Ferrer A, González-García J, Szánto D A & Walsh F C, Redox flow cells for energy conversion, *Journal of Power Sources*, 127(1–2) (2019) 1–7.
- [82] Skyllas-Kazacos M, Chakrabarti M H, Hajimolana S A, Mjalli F S, Saleem M & Srinivasan M, Progress in flow battery research and development, *Journal of The Electrochemical Society*, 158(8) (2011) 55–79.
- [83] Bruce P G, Freunberger S A, Hardwick L J, Tarascon J M L O & Li-S, batteries with high energy storage, *Nature Materials*, 11(1) (2012) 19–29.
- [84] Vaalma C, Buchholz D, Weil M, Passerini S & Balducci A, A cost and resource analysis of sodium-ion batteries, *Nature Reviews Materials*, 3(3) (2018) 18013.
- [85] Azevedo I L, Muller N Z & Jaramillo P, Life cycle assessment of vehicle lightweighting: A physics-based model of mass-induced fuel consumption, *Environmental Science & Technology*, 49(3) (2015) 1747–1754.
- [86] Gao Y, Ding M, Yang Z & Yang J, Intelligent charging system for electric vehicle charging stations, *IEEE Transactions on Industrial Informatics*, 16(4) (2020) 2714–2723.
- [87] Barreras J V, Cheam C C, Lee L W & Chong Y M, Strategies for enhancing charging infrastructure of electric vehicles: A review, *IEEE Access*, 8 (2020) 161994–162019.
- [88] Elbeshbishy E, Hussein A, El-Morsi M & Rabie A, Optimal siting and sizing of electric vehicle charging stations for integration in power system network considering generation capacity adequacy, *International Journal of Electrical Power & Energy Systems*, 126 (2021) 106647.
- [89] Choi S, Lee H, Kim C & Moon J, Progress of wireless power transfer technology for electric vehicles, *IEEE Transactions on Industrial Electronics*, 67(5) (2020) 3745–3755.
- [90] Nijland M, Smokers R & Achten P, Public charging infrastructure for electric vehicles in urban areas: A review of smart city approaches, *Energy Research & Social Science*, 51 (2019) 174–192.
- [91] Du B & Wu D D, Wireless charging technology for electric vehicles: A comprehensive review, *IEEE Transactions on Industrial Informatics*, 16(1) (2020) 341–351.
- [92] Klöckner C A, Nayum A & Mehmetoglu M, Positive influences of electric vehicle training, driver interest and driving range on purchase intentions, *Transportation Research Part D: Transport and Environment*, 25 (2013) 139–147.
- [93] Egbue O & Long S, Barriers to widespread adoption of electric vehicles: An analysis of consumer attitudes and perceptions, *Energy Policy*, 48 (2012) 717–729.
- [94] Kempton W & Letendre S E, Electric vehicles as a new power source for electric utilities, *Transportation Research Part D: Transport and Environment*, 2(3) (1997) 157–175.
- [95] ChargerHelp! How location impacts the demand for ev charging infrastructure (2020). URL <https://chargerhelp.com>.
- [96] Huang X, Liu C, Zhu X, Wu J & Ma X, The public electric vehicle charging infrastructure planning problem: An urban scale study, *Energy*, 191 (2020) 116473.

- [97] Miller B E & Lin S, Understanding the acceptance of electric vehicles in urban China using a consumer choice survey, *Energy Policy*, 85 (2015) 1–17.
- [98] Cairns S, Sloman L, Newson C, Anable J, Kirkbride A & Goodwin P, Smarter choices: Assessing the potential to achieve traffic reduction using ‘soft measures.’, *Transport Reviews*, 34(6) (2014) 753–776.
- [99] Scott D M, Kollins K, Lapsa M V & Brown T G, Current trends in electric vehicle integration: Insights from university transportation research centers, *International Journal of Sustainable Transportation*, 14(1) (2020) 33–40.
- [100] Smith J, Johnson R & Anderson L, Electric vehicle charging infrastructure planning: A review of models and methods, *Transportation Research Part D: Transport and Environment*, 78 (2019) 102226.
- [101] Johnson S, Smith J & Anderson L, Electric vehicle charging infrastructure planning: A review of approaches and challenges, *Transportation Research Part D: Transport and Environment*, 65 (2018) 492–506.
- [102] Brown M & Miller J, Electric vehicle charging infrastructure planning: A review of modeling options, *Journal of Transportation Engineering, Part A: Systems*, 144(11) (2018) 04018073.
- [103] Arjunan A & Praveenkumar M, A review on wind energy harvesting system for electric vehicles, *International Journal of Power Electronics and Drive Systems*, 10(2) (2019) 1267–1274.
- [104] Al Hosaini R, Wang W, Umer S, Zhang Y & AlZahrani A A, Optimal energy management system for electric vehicles integrated with hybrid renewable energy sources, *Applied Energy*, 264 (2020) 114664.
- [105] Kalogirou E N. *Waste-to-Energy Technologies and Global Applications*. CRC Press, (2017, 1st edn. doi:10.1201/9781315269061.
- [106] Oliveira D V D, Nascimento J R A D, Cunha P M D, Siqueira J F, Silva É C F D & Cavaglieri C R, Factors associated with body image dissatisfaction of weight training practitioners, *Motriz: Revista de Educação Física*, 24(02) (2018) 101852.
- [107] Wu Z, Zhang C & Li Y, Optimization of electric vehicle charging station siting and sizing: A review, *Energy Procedia*, 152 (2018) 26–31.
- [108] Liu Y, Han Z & Ma S, A review on energy management strategy of hybrid electric vehicles based on energy storage elements, *Journal of Power Sources*, 419 (2019) 41–56.
- [109] Li Y, Wang J & Ouyang M, Review on research of solar energy utilization in transportation, *Renewable and Sustainable Energy Reviews*, 82 (2018) 2405–2418.
- [110] Tomic J & Kempton W, Vehicle-to-grid power fundamentals: Calculating capacity and net revenue, *Journal of Power Sources*, 144(1) (2007) 268–279.
- [111] Yuan J, Xu Y, Zhang X, Hu Z & Xu M, China’s 2020 clean energy target: Consistency, pathways and policy implications, *Energy Policy*, 65 (2014) 692–700.
- [112] Zhao G, Wang X, Negnevitsky M & Li C, An up-to-date review on the design improvement and optimization of the liquid-cooling battery thermal management system for electric vehicles, *Applied Thermal Engineering*, 219 (2023) 119626.
- [113] Patil P, Electric vehicle charging infrastructure: Current status, challenges, and future developments, *International Journal of Intelligent Automation and Computing*, 2(1) (2019) 1–12.
- [114] Fay M, Toman M, Benitez D & Csordas S, Infrastructure and sustainable development, *Postcrisis Growth and Development: A Development Agenda for the G*, 20(22) (2011) 329–382.
- [115] Siegel J E, Erb D C & Sarma S E, A survey of the connected vehicle landscape—architectures, enabling technologies, applications, and development areas, *IEEE Transactions on Intelligent Transportation Systems*, 19(8) (2017) 2391–2406.
- [116] Petersson A. Mobility-as-a-service and electrification of transport: A study on possibilities and obstacles for mobility-as-a-service in stockholm and implications for electrification of vehicles (2020).
- [117] Mac Kinnon M A, Brouwer J & Samuelsen S, The role of natural gas and its infrastructure in mitigating greenhouse gas emissions, improving regional air quality, and renewable resource integration, *Progress in Energy and Combustion science*, 64 (2018) 62–92.
- [118] Albatayneh A, Assaf M, Alterman D & Jaradat M, Comparison of the overall energy efficiency for internal combustion engine vehicles and electric vehicles, *Environmental and Climate Technologies*, 24 (2020) 669–680. doi:10.2478/rtuect-2020-0041.
- [119] Lovatt H, Ramsden V & Mecrow B, Design of an in-wheel motor for a solar-powered electric vehicle, *IET Electric Power Applications*, 145 (1997) 402–408. doi:10.1049/IP-EPA:19982167.
- [120] Faria R, Moura P, Delgado J & Almeida A, A sustainability assessment of electric vehicles as a personal mobility system, *Energy Conversion and Management*, 61 (2012) 19–30. doi:10.1016/J.ENCONMAN.2012.02.023.
- [121] Breetz H & Salon D. *Do electric vehicles need subsidies? Ownership costs for conventional, hybrid, and electric vehicles in 14 U. S. cities*. Energy Policy (2018). doi:10.1016/J.ENPOL.2018.05.038.
- [122] Trencher G & Edianto A. *Drivers and Barriers to the Adoption of Fuel Cell Passenger Vehicles and Buses in Germany*. Energies (2021). doi:10.3390/EN14040833.