



**HAL**  
open science

# ACPS: Adaptive Cyber-Physical Systems in Industry 4.0

Sebastien Ducos, Ernesto Exposito

► **To cite this version:**

Sebastien Ducos, Ernesto Exposito. ACPS: Adaptive Cyber-Physical Systems in Industry 4.0. IC-SOFT 2023: 18th International Conference on Software Technologies, Jul 2023, Rome, Italy. hal-04630592

**HAL Id: hal-04630592**



**<https://hal.science/hal-04630592v1>**

Submitted on 1 Jul 2024

**HAL** is a multi-disciplinary open access archive for the deposit and dissemination of scientific research documents, whether they are published or not. The documents may come from teaching and research institutions in France or abroad, or from public or private research centers.

L'archive ouverte pluridisciplinaire **HAL**, est destinée au dépôt et à la diffusion de documents scientifiques de niveau recherche, publiés ou non, émanant des établissements d'enseignement et de recherche français ou étrangers, des laboratoires publics ou privés.

# ACPS: Adaptive Cyber-Physical Systems in Industry 4.0

Sebastien DUCOS<sup>1</sup><sup>a</sup> and Ernesto Exposito<sup>2</sup><sup>b</sup>

<sup>1</sup>LIUPPA, University of Pau et des Pays de l'Adour, E2S UPPA, Anglet, France

<sup>2</sup>LIUPPA, University of Pau et des Pays de l'Adour, E2S UPPA, Anglet, France  
{sebastien.ducos, ernesto.exposito}@univ-pau.fr

**Keywords:** Industry 4.0, Cyber-Physical Systems, Decision Support Systems, Autonomic Computing, Reconfigurable Systems.

**Abstract:** Nowadays, with the rapid growth of connected objects and produced data involved in industrial processes, it is increasingly difficult to design and implement efficient cyber-physical systems (CPS) meeting business needs. As a consequence, architectures of CPS have to be able to integrate different heterogeneous actors (people, objects, data, services) coordinated by autonomous and self-adaptive processes capable of implementing the different business missions of a company. Moreover, with the emergence of Industry 4.0, interest in elastic services provided by cloud architectures is booming. Indeed, these architectures allow the smooth and scalable interconnection of interdependent systems in order to provide efficient solutions to facilitate the management of industrial processes. In this paper, we propose a generic architecture for Integration Platforms as a Service (iPaaS). This architecture offers key functionalities, namely integration and interoperability, but also self-decision support. One implementation based on open-source solutions and illustrating the benefits of this proposal in the area of the Agriculture 4.0 domain is proposed.

## 1 INTRODUCTION

In their dynamic of continuous improvement and digitalization, organizations are seeking to integrate advanced and innovative technologies to ensure their transition to Industry 4.0. Indeed, the emergence of Industry 4.0 brings a technological and philosophical revolution in companies, forcing them to question their business models. The term "Industry 4.0" encompasses a set of technologies and concepts related to the re-organization of the value chain (Hermann et al., 2015). This term is related to the accelerated advances enabled and promoted by information and communication technologies (ICT). It relies on the communication of real-time information to monitor and act on physical systems, thus exploiting a new paradigm: the cyber-physical systems (CPSs). Different systems communicate and cooperate with each other, but also with humans, to decentralize decision-making. Its deployment requires the integration of different digital technology know-how (Danjou et al., 2017). The fourth industrial revolution do not only concern production processes,

but also aim to revolutionize new horizons such as new generation smart products and services (Godreui et al., 2016). It requires the design and implementation of smart cyber-physical systems following an appropriate methodology and based on a concrete architecture that meet the challenges of integrating IoE actors and their intelligent coordination (agile, adaptable, reconfigurable and flexible). They should autonomously provide information about themselves and exchange information with other CPSs that are part of the industrial networks. They should be able to be adaptive to respond to multi-domain challenges involving different paradigms. We are talking about cyber-physical systems of systems (CPSoS).

This article is structured as follows: the next section presents related works proposing smart solutions for CPS. The third section describes our proposal aimed at creating a flexible platform to manage cognitive processes in CPS able to integrate compliant data science approaches for decision-making in the area of the Agriculture 4.0, followed by some first results. Finally, the conclusions and perspectives of this work are presented.

---

<sup>a</sup> <https://orcid.org/0000-0001-7990-5547>

<sup>b</sup> <https://orcid.org/0000-0002-3543-2909>

## 2 REFERENCE ARCHITECTURES FOR CPS

In order to guide organizations in their transition to the 4th industrial revolution and to create an environment conducive to innovation and to the creation of CPS adapted to efficiently meet the new needs, several initiatives have been launched around the world and several architectures have been proposed.

The most significant initiatives have been accompanied by government agencies and private organizations from countries in the most developed economies (Wang et al., 2017) (Zhong et al., 2017). Reference architectures provide a framework for developing solutions for Industry 4.0 in a structured way that allows all participants to be involved in a uniform manner. In this sense, standards can be identified and optimized. Among these architectures, we will find well known ones like the Reference Architectural Model Industrie 4.0 (RAMI4.0) and the Industrial Internet Reference Architecture (IIRA).

Other different but interesting work has been carried out with so-called cognitive architectures because they allow the integration of self-management capabilities (Kephart et al., 2003). Among these, we find the Adaptive Control of Thought - Rational (ACT-R) architecture or the Soar architecture.

### 2.1 Industry 4.0 Architectures

As mentioned above, the RAMI 4.0 and IIRA reference architectures aim to facilitate the Industry 4.0 knowledge sharing paradigm, guide organizational transitions, and specifically advise on leveraging ICT advances. Both initiatives seek to build a more efficient industrial world particularly through complex, connected and intelligent systems. A notable difference is that RAMI 4.0 extends this vision to the entire value chain and product life cycle, while IIRA maintains a more concrete vision of the ICT world.

#### 2.1.1 Reference Architecture Model Industrie 4.0 (RAMI4.0)

The RAMI4.0 architecture is based on three dimensions, as we can see in Figure 1 below, namely: the layers (properties and system structures), the hierarchy levels (from the product to the connected world) and the life cycle and value stream (product lifecycle).

The first vertical axis proposes 6 layers (asset, integration, communication, information, functional and business) allowing to break down the properties of a machine on different levels. Thanks to this, even the most complex systems can be divided and managed more easily.

Regarding the second right horizontal axis, the hierarchy levels, from IEC 62264, represents the different functionalities of organizations. This dimension characterizes the Industry 4.0 revolution with the introduction of "Products" as well as the "Connected World" with the emergence of the connection of things and services (IoT).

Finally, the left horizontal third axis targets the products and facilities lifecycle, based on IEC 62890. We can identify 2 phases: types and instances. The type phase is characterized by the design and prototyping of a product. When this phase is completed and the product is manufactured, the type phase is transferred to the instance phase (ISA).

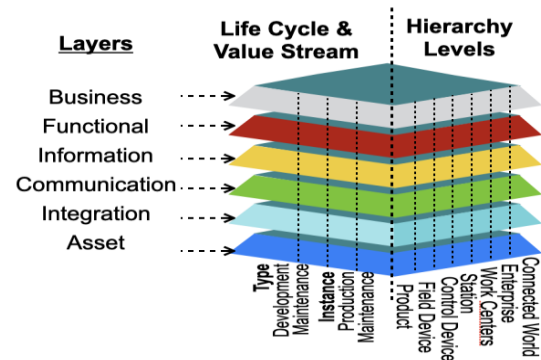

Figure 1: Reference Architectural Model Industrie 4.0 (RAMI4.0)

#### 2.1.2 Industrial Internet Reference Architecture (IIRA)

The Industrial Internet Reference Architecture was introduced, in 2015, by the Industrial Internet Consortium (IIC) and updated in 2017 to become an open standards-based architecture for the Industrial Internet of Things (IIoT). The architecture proposes 3 dimensions, as we can see in Figure 2, comparable to the Reference Architectural Model Industrie 4.0 (RAMI4.0), namely: the Viewpoints (Business, Usage, Functional and Implementation), the Process Lifecycle (IIoT system conception, design and implementation) and the Industrial Sectors.

A major goal of IIoT is to connect larger, complex systems and implement hierarchies for machines. This architecture is also based on IIoT systems for the functional part with a decomposition in 5 interconnected domains, namely: control (control and

actuation), operations (management and maintenance), information (data collection and analysis), application (use-case application) and business (business goals) (Expósito, 2019).

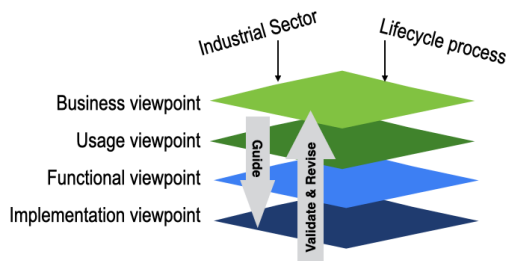

Figure 2: Industrial Internet Reference Architecture (IIRA)

## 2.2 Architectures Evaluation

Reference architectures such as RAMI4.0 and IIRA support integration, interoperability and scalability needs but do not explicitly consider decision part. While both IIRA and RAMI 4.0 provide valuable reference architectures for the design and implementation of industrial internet systems and smart factories, they also have some limitations:

- **Complexity:** both architectures are complex and can be difficult to implement, especially for smaller organizations with limited resources and expertise.
- **Standardization:** for both architectures, there is a lack of universal standards in some areas, such as communication protocols and data formats.
- **Cost:** Implementing the architectures can require significant investment in hardware, software, and personnel.

Overall, while both IIRA and RAMI 4.0 provide valuable guidance for the design and implementation of industrial internet systems and smart factories, organizations must carefully evaluate the specific needs and resources before embarking on implementation.

Based on this analysis, our work proposes an alternative referential architecture intended to cope with the criteria and generic enough to be adapted to different application domains of the Industry 4.0.

## 3 ADAPTIVE CYBER-PHYSICAL SYSTEMS

This chapter presents our architecture proposal which consists in designing a generic architecture for

building cyber-physical systems capable of deploying autonomous processes, composed of Monitoring, Analysis, Planning and Execution (MAPE) phases and including knowledge bases, built using information provided by experts, to guide automated decision-making. The solution must consider the need to make these knowledge bases evolve to deal with new contexts, new objectives and constraints of industrial processes.

### 3.1 5C layered referential architecture for CPS

In order to facilitate and assist in the design, implementation and management of cyber-physical systems for Industry 4.0, a referential architecture in 5C layers will be presented in this section. This referential architecture is intended to build and coordinate CPS and to allow cooperation and collaboration of CPSoS. This architecture is well suited for CPS involved in Industry 4.0 manufacturing processes, as well as for the elaboration of smart products and the provision of smart services.

This proposal promotes a generic and concrete architectural framework, based on a 5C layered architecture and resulting from an improvement of the previously presented reference architectures and the integration of the Internet of Everything (IoE) concept.

#### 3.1.1 5C Layers

The 5C Layered architecture follows an incremental approach that allows the assembly of components of a CPS and also goes as far as its composition to create systems of systems (Sanchez, 2020).

The two lowest layers (C1..C2) are intended to cope with the integrability (connectivity) and interoperability (communication) challenges of the heterogeneous actors involved in CPS (people, things, data, services, etc.). The three highest layers (C3..C5) are intended to incrementally integrate monitoring, analysis, planning and management capabilities required to allow coordination of CPS as well as cooperation and collaboration of Cyber-Physical Systems of Systems (CPSoS).

The Table 1 presents each layer and describe the architectural functionalities offered to the involved entities.

Table 1: Architecture layers and functionalities

Layer	Description	Architectural functionality
C1: Connection	entities share a common medium or channel	Network Connectivity
C2: Communication	two or more entities are able to understand each other by exchanging messages via a common medium or channel	Integrability
		Interoperability
		Interaction modes
C3: Coordination	two or more entities working together following the orders or the instructions of a coordinator	Intra-system orchestration (CPS)
C4: Cooperation	two or more entities work together to achieve individual goals	Inter-systems orchestration (CPSoS)
C5: Collaboration	two or more entities work together to achieve a common global goal	Inter-systems choreography (CPSoS)

### 3.1.2 Autonomic Management dimension

In addition to the 5 levels previously presented representing a structural dimension for the design of CPS and CPSoS, our architecture must also integrate a behavioral dimension allowing the intelligent management of the structural elements involved.

This behavioral dimension must offer a generic and scalable approach, allowing to offer self-adaptation capabilities to the context in order to enable the achievement of the goals established for the CPS.

We believe that the architecture proposed by autonomic computing (AC) offers the framework required to integrate this behavioral dimension for self-management.

This architecture offers several structural and behavioral recommendations to implement self-management capabilities and thus build an autonomic system. Adaptive actions are implemented by adaptive algorithms operating within a closed-loop control system. These algorithms can be generically described as a process that includes monitoring, analysis, planning and execution (MAPE) activities that share a common knowledge base.

With regard to our 5-levels structure, the autonomic behavior would develop progressively, starting from the lowest levels thanks to the implementation of the required functionalities at the level of connection and communication to retrieve observations and execute adaptation actions on the CPS actors. At the coordination level, the autonomic

MAPE process will allow to self-manage the actors involved in order to achieve the objectives set for the CPS. At the cooperation and collaboration levels, the CPS will function as actors that can be monitored and who can carry out adaptation actions in order to achieve the individual or shared objectives of the CPSoS.

Having now the structural and behavioral dimensions of our architecture in place, a suitable methodology is still required to guide the process of building CPS based on our reference architecture.

To achieve effective orchestration in an autonomic system, it is necessary to have a high degree of automation, real-time monitoring and analysis, and the ability to adapt to changing conditions.

The following section will introduce a well-suited system engineering methodology that could be followed to build CPS based on the Autonomic 5C layered architecture.

### 3.1.3 System engineering methodology

In order to help innovation and development project managers in their transition to a more connected industry adapted to tomorrow's needs, we propose a methodological approach to determine and define precisely the different phases allowing designing and integrating complex systems related to Industry 4.0.

In the area of software engineering and systems engineering, several methodologies and modeling frameworks have been proposed for the development of complex systems.

A recent methodology successfully used at the industrial level for system engineering and based on this standard is the ARCADIA methodology (Capella). This methodology is an example of an MBSC methodology that also includes a language (Roques, 2016). We cannot directly compare UML or SysML with ARCADIA because ARCADIA is both a language and a method.

Arcadia has been influenced by systems engineering and in particular the distinction between requirements and solutions (Roques, 2016). This method also promotes a viewpoint approach. The central viewpoint in Arcadia is a functional viewpoint. Functions are used to describe what the system needs to do, and then functions to describe what the logical or physical components do and how, what they do, will contribute to the system. In addition, other points of view such as performance or security must be satisfied and conform to the context of the specific project. This allows the same system

to be seen from many different points of view depending on the system to be designed.

This methodology proposes 5 incremental phases to identify the functional and non-functional requirements of the system (operational and functional analysis phases) and to design the system architecture (logical and physical architectures and EPBS). Moreover, the method has its own language mainly due to the lack of the concept of functions with languages like UML or SysML.

Our methodology is based on an extension of the Arcadia methodology, in order to integrate additional viewpoints and views, capable of incorporating the structural and behavioral levels of our referential architecture for Industry 4.0 CPS.

### 3.2 Agriculture 4.0 domain

As this work was carried out in collaboration with the Maisadour agricultural cooperative, it was logical to deploy and evaluate this approach on agricultural processes, mainly on the cereal drying process.

As presented above, the ARCADIA method was therefore chosen and followed in order to model an integration Platform as a Service (iPaaS) type approach because it allows to design its architecture while defining, evaluating and exploiting the collaboration of the systems (Capella). With this method, our architecture could be divided into 4 parts: Operational Architecture, System Architecture, Logical Architecture and Physical Architecture.

The logical architecture, presented in Figure 3, highlight the different functionalities of the system

and show the collaboration and communication of the latter by detailing the different sub-functions.

The iPaaS platform is composed of 3 modules or features: the integration module, the process manager and the prediction module. The logical actors and entities, on the left, represent the data sources and collectors, which can be also interpreted as the workspace or environment. The integration module allows the exchange of information between all the systems and actors involved in the process. In addition, it will play the role of translator because it will transform and standardize the data in order to make all the actors collaborate. Next, we find the process manager who ensures that the process runs smoothly step by step. It provides an overview of the various business processes and their interactions. Finally, the prediction module, composed of various decision models, allows the processing, analysis and prediction of data thanks to knowledge bases designed from heterogeneous sources (humans, IS, sensors, PLCs, ...). For this last module, it is essential to build decision models capable of integrating expert knowledge while ensuring a suitable accuracy of the decisions taken.

For the decisional part, i.e. recommendations or automated decision making, 2 models were initially integrated and tested in order to evaluate the global approach. After that, we thought of developing a more concrete and complete decisioning module, namely, a generic Data-Driven Decision Support System (DDDSS) that could meet a wide range of needs in an adapted and precise manner.

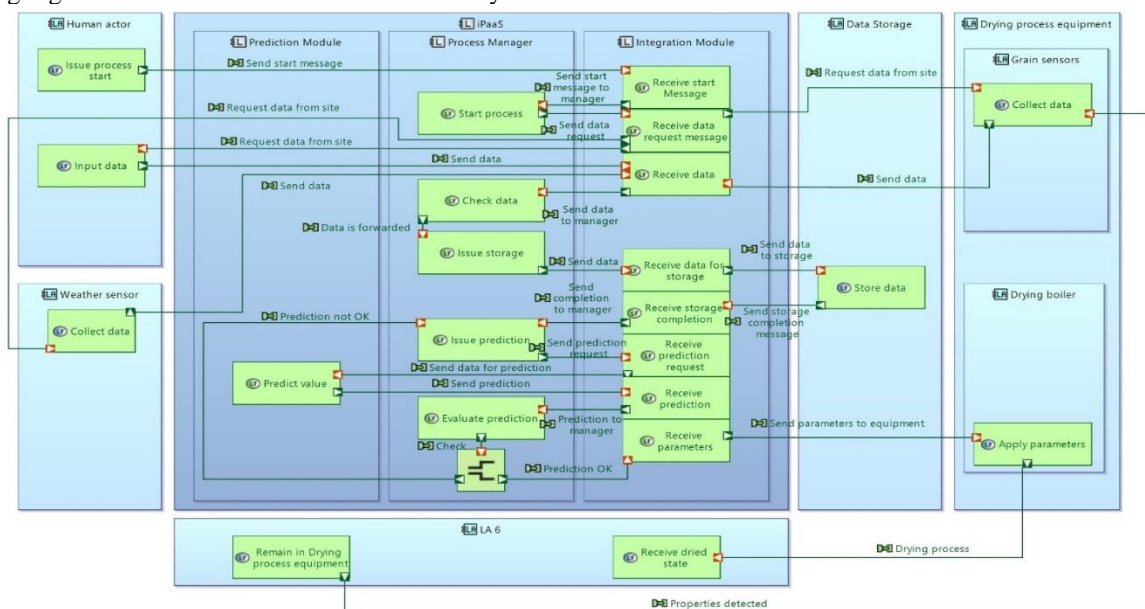

Figure 3: Logical Architecture



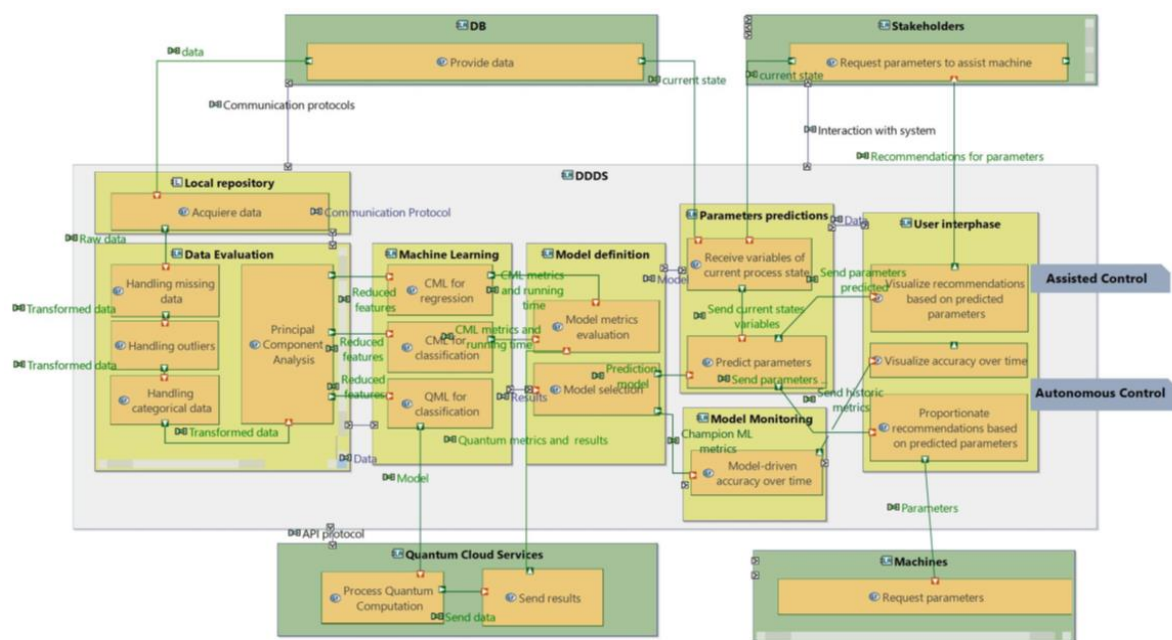

Figure 4. Data-Driven Decision Support System Architecture

The architecture platform, Figure 4, is conformed of six internal elements: local repository, data evaluation, machine learning, model definition, predictions of parameters, model monitoring and user interphase.

Each of the elements is defined based on its specific functionalities that receive and process data.

In addition, the DDDSS, as an open system, is interconnected to external components databases, stakeholders, quantum cloud services, machines to exchange resources and information.

Our solution therefore meets the various key elements defined above concerning the functionalities or services of integration, interoperability, decision model inclusion, adaptability, auditability and finally scalability.

## 4 DEVELOPMENT AND EXPERIMENTATIONS

In order to develop and evaluate this approach, an iPaaS prototype has been implemented on several agricultural processes, including drying, with the aim of optimizing machine parameters and reducing energy consumption (gas + electricity) and therefore also CO2 emissions.

This prototype uses only open-source solutions to prove its efficiency at low cost. For the integration module, the Apache Camel framework has been chosen as the main integrator. For the Process

Manager part, the adopted solution is Camunda BPM. Moreover, we find other solutions like Apache Kafka, which is a complementary integrator (Cestari et al., 2020).

### 4.1 Implementation

The different solutions used were adopted following a thorough state of the art on the subject. We identified the characteristics and functionalities necessary for the proper functioning of the system in order to list and compare the solutions that best corresponded to our needs.

Apache Camel ensures interoperability between the various systems thanks to a multitude of connectors (easily developed in case of absence) and the simple integration of new services or tools. Apache Kafka, on the other hand, will be useful for communications with a need for real-time data, as it is much better adapted than Camel for this part.

Camunda BPM, as process manager, can be considered as the brain of the system. It will ensure that the process runs smoothly via BPMN diagrams, compatible with other editors, which are executed by integrated engines.

To meet the scalability and elasticity needs of the iPaaS platform, Docker and Kubernetes were selected, among several technologies, as the main components to best manage them.

The chosen use case, designed with Camunda, aims at reducing energy consumption during the grain drying process by optimizing the dryer parameters to

obtain the best settings (number of burners, burner temperatures, extraction interval, ...) and set points (humidity, objectives) for the proper functioning of the drying process with lower consumption.

The learning models aim to define the optimal parameters with the lowest energy consumption based on 4 inputs: input humidity, desired output humidity, outside temperature and extraction weight. The predicted parameters then become the input data for estimating the energy consumption required for the process.

## 4.2 Results

This section will detail the results obtained from the models employed according to the methods mentioned throughout the work. First, we will see the results obtained for a complex regression problem, namely the parameterization of the dryers (T° burners, extraction intervals). Then, we will see the results obtained for a non-complex classification problem (number of burners).

### 4.2.1 Results for regression problems

After deploying different machine learning models to forecast energy consumption and optimize production parameters, we conclude that the deep learning branch and ANN artificial neural networks model provides the best performance overall. We divided the data into training and test set. Seventy per cent of the data was used as a training set and the remainder as the test set. The ANN was trained over 700 epochs with a batch size equal to 20 and a learning rate equal to 0.01. The metrics are in the following Table 2.

Table 2: Model performance for parameter optimization.

Approach	MAE	R <sup>2</sup>
ANN	0.206	0.86

As a result, we obtained an acceptable and reliable MAE loss metric to predict the parameters. The prediction error can be improved by implementing other more robust outlier elimination techniques since the most significant errors are obtained when the fundamental variables are extreme points.

When the DDDSS Time Efficiency and Energy Efficiency parameters are set to the ultra-mode, the theoretical result is an average saving in the production plants of 17.5%.

### 4.2.2 Results for classification problems

Three evaluation tests were carried out to evaluate the feasibility of applying the quantum support vector machines QSVM model to solve binary classification problems to predict the number of burners. This same problem was addressed using Support Vector Machine in its classical approach, and the performance of these two methods was compared. The results obtained are shown in Table 3.

Table 3: QML and CML test definition.

Tests	Feature Reduction (PCA)	Number of features	Number of Instances	Training	Testing dataset
Test 1	Yes	3	100	0.7	0.3
Test 2	Yes	3	3000	0.7	0.3
Test 3	Yes	7	3000	0.7	0.3

After deploying the QSVM model, the result obtained is not only promising for deploying quantum infrastructure solutions, but it is already a reality, as we can see in Table 4.

Table 4: QML and CML accuracy and running time results.

Approach	Test 1		Test 2		Test 3	
	Accuracy	Time (s)	Accuracy	Time (s)	Accuracy	Time (s)
QSVM	0.98	48.00	-	-	-	-
CSVM	0.73	0.001	0.77	0.08	0.99	0.1

We obtained extraordinary results, as in the first test, training the model only with a tiny part of the dataset; we were able to obtain an accuracy of one hundred per cent after being evaluated while its counterpart provides less efficient performance. The classical model must be trained with the complete dataset to provide similar results as the quantum model. It can be concluded that the quantum properties speed up pattern recognition on little data and are highly efficient compared to their traditional counterpart.

However, when it came to testing two and three, with more extensive input variables, the quantum computing provided by IBM did not process it, due to the resource limit offered to users. It is known that today, leading companies continue to develop quantum infrastructure with larger processing units.

The statement above positions the classical method as the primary solution to address binary and non-binary problems within an Industry 4.0 framework. However, the latter will be a prosperous



approach when quantum computers reach "quantum supremacy" in the coming years.

## 5 CONCLUSIONS AND PERSPECTIVES

In this paper, we have proposed a generic iPaaS architecture fully composed of open-source solutions. This shows that this solution can work at very low cost even if some tasks will be a bit heavier to manage. All technologies used could, of course, be replaced by proprietary solutions. We could see that the architecture allows to satisfy the requirements of integrability, interoperability and extensibility.

To optimize the complex regression case results, it's essential to increase the data preprocessing methods to achieve formidable performance for diverse problems. Therefore, some robust techniques will be introduced to the system for this purpose, e.g., data imputation using linear regression. Second, it will be fundamental to optimize the hyperparameters of the algorithms to obtain desired results, this last will be possible by implementing the Grid-Search technique.

Moreover, this work presents an alternative to the existing options reviewed throughout state of the art, including machine learning methods in its quantum version to address binary classification tasks. The latter approach was possible to deploy by using IBM quantum resources. Moreover, the properties of entanglement and superposition provided a speedup to determine the number of burners needed to dry a production batch, with exceptional accuracy and minimal training.

This architecture allows for a simple integration of the DDDSS which makes it adaptive and that will clean and standardize the data and define the most suitable decision models. The models will be able to be evaluated, adjusted and used simultaneously to support the decision-making process or to make it directly while providing auditable results. The objective is to acquire as much knowledge as possible to compensate for the retirement of experts who are not necessarily replaced and are becoming increasingly rare, particularly in certain fields such as grain drying and agriculture in general. The collaboration of these models will bring a strong adaptability and robustness to future CPS. The integration of quantum decision models is also not to be excluded in the coming years. Finally, in the future, an evaluation of the scalability and elasticity

of the solution will be performed in a multi-tenant scenarios context.

## ACKNOWLEDGEMENT

We thank Pierre Lestage, Olivier Sourbets and the silo managers for sharing their expertise in the field of agriculture and more specifically in the drying process. More generally, we also thank MAÏSADOUR and UPPA for their financial and institutional support in this research project.

## REFERENCES

- M. Hermann, T. Pentek et Otto B Design principles for industrie 4.0 scenarios [Online]. Technische Universität Dortmund, 2015.
- DANJOU Christophe, RIVEST Louis et PELLERIN Robert Industrie 4.0 : des pistes pour aborder l'ère du numérique et de la connectivité [Online]. CEFRIO, 2017,
- GODREUI Benjamin et SAUDEAU Emmanuelle Les technologies de l'usine du futur au service de la maintenance industrielle [Online]. F.F.E., 2016.
- Wang, Yübo, Thilo Towara, and Reiner Anderl. "Topological Approach for mapping technologies in reference architectural model Industrie 4.0 (RAMI 4.0)." *Proceedings of the World Congress on Engineering and Computer Science*. Vol. 2. 2017.
- Zhong, R. Y., Xu, X., Klotz, E., & Newman, S. T. (2017). Intelligent manufacturing in the context of industry 4.0: a review. *Engineering*, 3(5), 616-630.
- J. O. Kephart and D. M. Chess, "The vision of autonomic computing," *Computer*, vol. 36, no. 1, pp. 41-50, Jan. 2003, doi: 10.1109/MC.2003.1160055.
- "RAMI 4.0 - ISA," isa.org.
- Ernesto Expósito. *Semantic-Driven Architecture for Autonomic Management of Cyber-Physical Systems (CPS) for Industry 4.0*. MEDI 2019 International Workshops, DETECT, DSSGA, TRIDENT, Toulouse, France, October 28-31, 2019, *Proceedings*, Oct 2019, Toulouse, France. pp.5-17, ff10.1007/978-3-030-32213-7\_1ff.fhal-02432944f.
- M. Sanchez, "Autonomic process management for Integration in Industry 4.0," *These de doctorat*, Pau, 2020. [Online]. Available: <https://www.theses.fr/2020PAUU3006>.
- "Capella MBSE Tool - Arcadia." <https://www.eclipse.org/capella/arcadia.html>.
- Roques, Pascal. "MBSE with the ARCADIA Method and the Capella Tool." 2016. "Arcadia (engineering)".
- R. H. Cestari, S. Ducos, and E. Exposito, "iPaaS in Agriculture 4.0: An Industrial Case," Sep. 2020, pp. 48-53, doi: 10.1109/WETICE49692.2020.00018.