



HAL
open science

Methods to Measure the Electrical Resistances of a Gas Diffusion Layer Under Mechanical Compression

Khadidja Bouziane, El Mahdi Khetabi, Rémy Lachat, Denis Candusso, Yann Meyer

► **To cite this version:**

Khadidja Bouziane, El Mahdi Khetabi, Rémy Lachat, Denis Candusso, Yann Meyer. Methods to Measure the Electrical Resistances of a Gas Diffusion Layer Under Mechanical Compression. Fuel Cells, 2024, 24 (3), pp.e202200102. 10.1002/fuce.202200102 . hal-04629747

HAL Id: hal-04629747

<https://hal.science/hal-04629747>

Submitted on 9 Jul 2024

HAL is a multi-disciplinary open access archive for the deposit and dissemination of scientific research documents, whether they are published or not. The documents may come from teaching and research institutions in France or abroad, or from public or private research centers.

L'archive ouverte pluridisciplinaire **HAL**, est destinée au dépôt et à la diffusion de documents scientifiques de niveau recherche, publiés ou non, émanant des établissements d'enseignement et de recherche français ou étrangers, des laboratoires publics ou privés.



Distributed under a Creative Commons Attribution - NonCommercial - NoDerivatives 4.0 International License

RESEARCH ARTICLE OPEN ACCESS

Methods to Measure the Electrical Resistances of a Gas Diffusion Layer Under Mechanical Compression

Khadija Bouziane^{1,2} | E. M. Khetabi^{1,2} | R. Lachat³ | D. Candusso^{1,2} | Y. Meyer⁴ 

¹Université Paris-Saclay, ENS Paris-Saclay, Université Gustave Eiffel, SATIE, Versailles Satory, France | ²FCLAB, Plateforme Hydrogène Energie, UTBM bât. F, Rue Thierry Mieg, Belfort, France | ³ICB, CNRS, Univ. Bourgogne Franche-Comté, UTBM, Belfort, France | ⁴Université Savoie Mont Blanc, SYMME, Annecy, France

Correspondence: Y. Meyer (yann.meyer@univ-smb.fr)

Received: 26 February 2024 | **Revised:** 4 June 2024 | **Accepted:** 8 June 2024

Funding: The Khadija Bouziane's PhD thesis (Contrat doctoral Univ. Paris Sud n° 2017-225) was funded by The French Ministère de l'Enseignement supérieur, de la Recherche et de l'Innovation.

Keywords: clamping pressure | electrical characterization | fuel cells | gas diffusion layer | mechanical compression | mechanical properties | proton exchange membrane fuel cell

ABSTRACT

In a proton exchange membrane fuel cell (FC), the gas diffusion layer (GDL) is identified as the component that is most affected by mechanical compression. In this article, a particular focus is provided on the methods to measure the three main electrical parameters—contact resistance, through-plane resistance, and in-plane resistance—of the GDL under compression. A nonlinear decrease of these resistances under compression is typically observed. In particular, an important decrease is observed from 0 to 2 MPa, then a lower one above 2 MPa. The smallest contact and in-plane resistances are measured for the graphitized straight carbon papers analyzing GDL resistances under compression gives a first approach to explaining ohmic losses in FCs as a large part of these losses is related to the GDL. This review would be helpful for researchers in better understanding ohmic losses and establishing a database of main GDL electrical resistances and their variations according to several operating parameters. These data could be used in design models to optimize GDL properties.

1 | Introduction

In proton exchange membrane fuel cell (PEMFC), the mechanical compression applied on the cell assembly plays an essential role in ensuring effective gas tightness and optimized electrical conductivities. However, excessive compressive stress can degrade the performance of the fuel cell (FC) by reducing the porosity and the transport capacity of its components, particularly the gas diffusion layer (GDL) [1]. This porous composite medium, with a thickness of 100–500 μm , acts as an interface between the bipolar plate (BPP) and the catalyst layer (CL) adjoining the membrane [2]. The GDL serves several important functions: distribution of the reactants evenly across the surface of the CL, removal of water

and heat from the cell, conduction of electrons, and structural support by maintaining the mechanical integrity of the cell. GDLs are typically made of carbon-based materials, such as carbon paper or carbon cloth [3–5], with high electrical conductivity, porosity, gas permeability, and corrosion resistance. Carbon paper can be made either of straight fibers randomly distributed in the plane (2D structure) or of curved carbon fibers (3D structure). GDLs are treated with a hydrophobic agent, typically PTFE [5, 6]. A microporous layer (MPL) [7], a smooth, porous structure made of black carbon mixed with PTFE, is commonly added to the GDL substrate on the CL side. This sublayer improves the contact with the catalyst coated membrane, the water management, and it also protects the membrane electrode assembly from

This is an open access article under the terms of the [Creative Commons Attribution-NonCommercial-NoDerivs](https://creativecommons.org/licenses/by-nc-nd/4.0/) License, which permits use and distribution in any medium, provided the original work is properly cited, the use is non-commercial and no modifications or adaptations are made.

© 2024 The Author(s). *Fuel Cells* published by Wiley-VCH GmbH.

fiber penetration [8]. Extensive work has been done on GDL materials and structural designs, on their degradation mechanisms, using experimental methods and modeling [9–12], in particular to improve water management [13–19]. Detailed information on the structure and fabrication process of GDLs can be found in refs. [8, 20–22].

Due to its high porosity and its low stiffness, the GDL is the component of the PEMFC that is most affected by mechanical stress [23, 24]. In the last few years, intensive research studies have therefore focused on GDLs because of the strong relation of their compressibility with PEMFC performance [25, 26]. The effects of mechanical pressure on the electrical properties of GDL structures need to be determined experimentally [27], according to the FC-operating conditions (cyclic compression, temperature, and humidity), with a view to possibly determining and calibrating design models. In compression, GDL exhibits a nonlinear mechanical behavior with a strain hysteresis [28]. Hence, studying the impact of cell compression on the electrical parameters of GDLs depends on the GDL's structure [29] and requires the use of cyclic loads to take into account part of the actual operating conditions of a PEMFC [30].

Mechanical constraints influence ohmic losses in the GDL itself (depicted by bulk resistances) but also at the interfaces with adjacent cell elements (contact resistances) [31, 32]. The *contact resistance* (R_c) is reduced by better contact, which can be ensured by an adequate level of compression and a smoother surface. R_c is responsible for an important amount of ohmic losses and can represent more than 50% of the total electronic losses in a cell [33, 34]. In particular, the compression can affect R_c at the GDL/BPP interface to a greater or lesser extent depending on the component materials, structure, and design. In some cases, the R_c between GDL and BPP represents 8%–10% of total ohmic losses and is the major cause of electronic losses [34]. A few articles examine the ex situ and in situ characterization techniques to determine the effective transport and mechanical GDL properties [32, 35, 36]. However, the specific ex situ methods to measure the electrical (bulk and contact) resistances related to the effects of mechanical compression in PEMFC on the physical properties of GDL have rarely been described in systematic reviews. Therefore, this article aims to present a background on the experimental methods used to measure the different electrical resistances of GDLs. Some examples of resistance measurements will be presented for several commercial GDL references. Future prospects and recommendations on research opportunities will also be provided.

2 | Experimental Methods

The assessment of ohmic resistance in a GDL involves the measurement of its R_c with neighboring components, its bulk resistivity, its through-plane resistivity (which is in series with the R_c), and its in-plane resistivity, which is the main conductor beneath the channels of the BPP. Figure 1 illustrates the representation of these three types of resistance in the GDL/BPP assembly. Measuring these parameters presents challenges, primarily stemming from the variations in GDL dimensions due to compression. Deconvoluting the R_c from the through-plane resistance presents a significant difficulty in this context. In GDLs

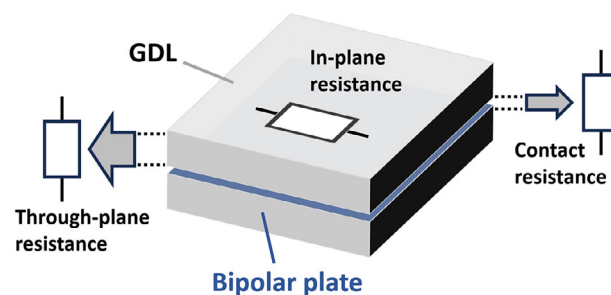

FIGURE 1 | Representation of R_c , through-plane resistance (R_p), and in-plane resistance (R_i) in the GDL/BPP assembly. BPP, bipolar plate; R_c , contact resistance.

integrated into a conventional FC, the total resistance along the through-plane direction is a sum of the bulk and interfacial resistances. Traditional measurement techniques (e.g., global high frequency measurement with an impedance meter) cannot distinguish between these two types of resistances.

However, to optimize FC operation, particularly by minimizing ohmic losses, it is essential to separate the contributions of bulk and R_c in the GDL. Knowledge of the ratio between these two resistances will guide research efforts. For example, if bulk resistance is more significant, the focus should be on optimizing the GDL structure. Conversely, if R_c is dominant, improving surface roughness becomes crucial [37, 38].

2.1 | Measurement Methods for Contact Resistance

Three main methods are used to determine R_c . Figure 2 exhibits these different measurement methods of R_c [34, 39, 40].

A subtraction method [20, 41, 42] can be used by measuring the electrical resistance of two assemblies in such a way that the difference between the assemblies' resistances gives the desired R_c . However, most studies that used this method neglect either the bulk resistance or its variation with compression. To manage this issue, Laedre et al. [32] proposed a subtraction method based on four measuring combinations with an original setup: two different paths of the biasing electrical current and two different combinations of the voltage pick-up contacts positions. The principle of this measurement approach is depicted in Figure 2a. Another problem is the difficulty of using this method with GDLs having nonidentical sides, such as one side MPL-coated GDLs. Better results can be obtained if the bulk resistivity is measured using special pins or micro-probes that exclude R_c with electrodes [37, 41, 43].

In a second method, R_c is determined by a numerical or experimental estimation that can be achieved using the results of the subtraction method. For instance, Mason et al. [44] estimated this R_c by inserting a GDL between two compressed BPPs and measuring the resistance under compression. The entire resistance is attributed to the R_c . An estimation process can also be used to determine the variation of the through-plane resistance of the GDL with compression from its porosity, such as in the work of Ismail et al. [45]. A numerical model can also be set to

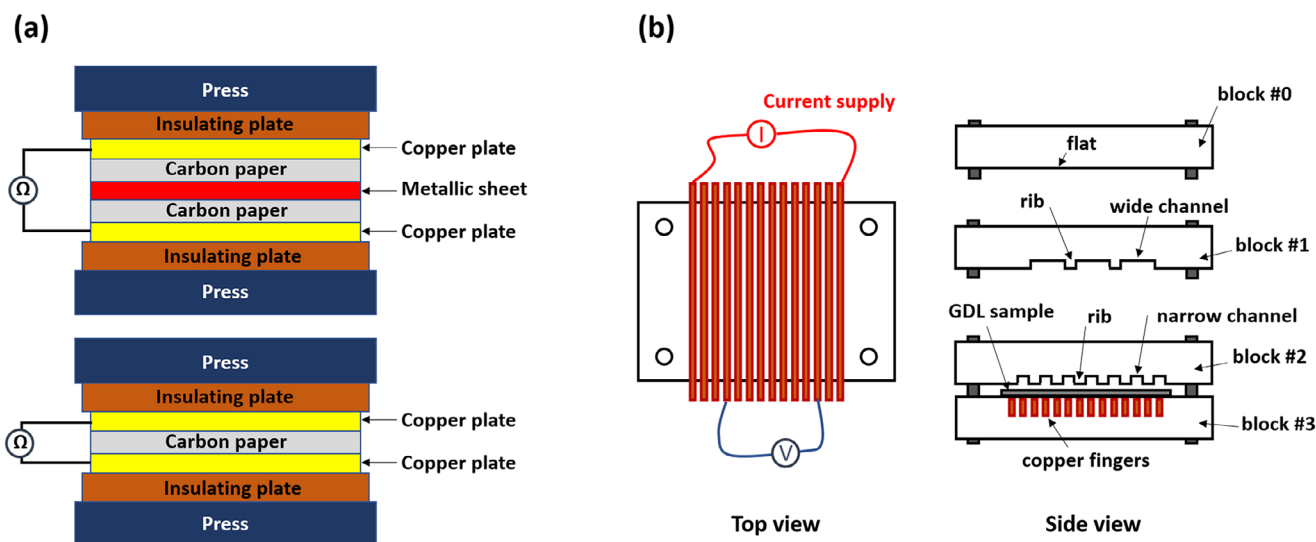

FIGURE 2 | Resistance contact measurement methods: (a) example of subtraction method, (b) example of transmission line method. Source: Schemes redrawn from Zhou et al. [47] and Ye et al. [34].

obtain a global R_c using experimental results, for instance, with a flat graphite plate [46–48].

A third method consists in using the transmission line method (TLM) [34, 49]. The TLM is based on the measure of the total electrical resistance between two identical metallic indentors and the GDL. The value of this resistance is the sum of two identical contact resistances and one in-plane resistance depending on the distance between the two indentors. Measuring the resistance as a function of the distance allows a direct experimental determination of the R_c between the GDL and the metallic indenter. The y-intercept of the regression line is the R_c that will not vary with the distance between both indentors [40, 50]. To obtain representative results for the FC, the indentors are designed to have a representative dimension of the flow field contacts (ribs), and they can also be coated to better mimic the contact characteristics of a BPP. This type of device allows for the application of various mechanical loadings, closely simulating the operational conditions of an FC [49].

2.2 | Measurement Methods for Through-Plane Resistance

The determination of through-plane resistivity is subject to R_c with electrodes. It is difficult to distinguish through-plane resistivity from the measured R_c . The contacts can be minimized using a four-probe measurement method to avoid the resistance of wires and electrodes. Gold-coated electrodes can be used to decrease R_c with electrodes. Aydin et al. [43, 51] presented the advantages and drawbacks of the three methods of through-plane resistivity measurements that are depicted in Figure 3 [43] using the four-probe measurement method: gold electrode, gold flat contact pin, and golden micro-wire probe.

The first procedure involves an R_c (even small) between the electrodes and GDL, which impacts the accuracy of the measurement [27]. However, this method is very rapid to implement [52].

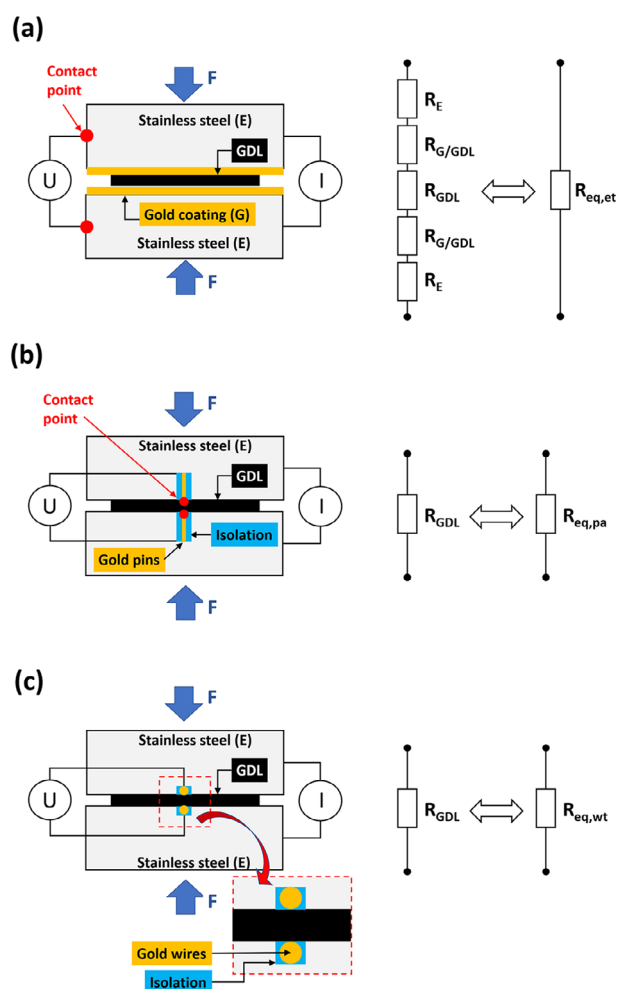

FIGURE 3 | Schematic diagram of the three methods used in this study: (a) gold-coated electrodes; (b) pins; (c) micro-wire probes. Source: Schemes redrawn from Qiu et al. [39].

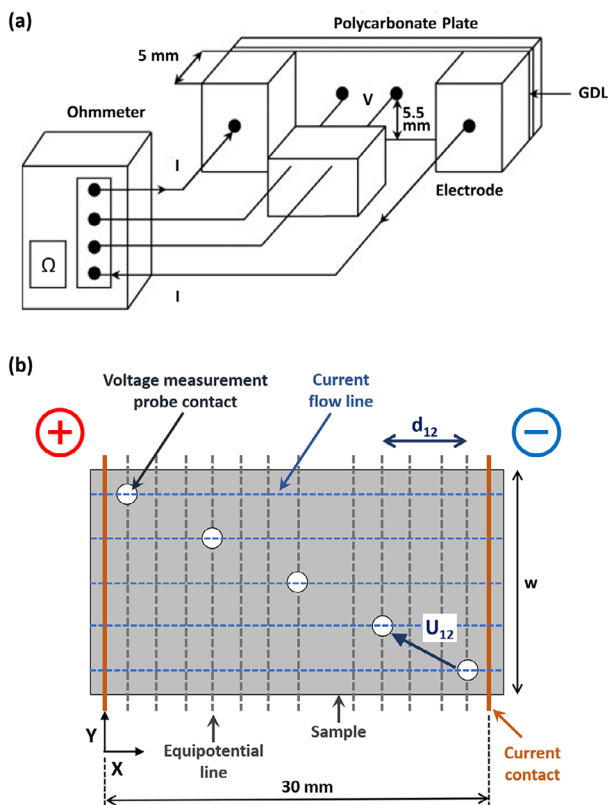

FIGURE 4 | (a) Four-probe in-plane resistivity measurement device. (b) In-plane resistivity measurement device. *Source:* (a) Scheme adapted from Aydin et al. [51].

In the second method, the contact area is small (a 60 μm diameter contact pin); consequently, R_c is neglected. But the high isolation area distorts the equipotential lines. This phenomenon leads to the measurement of small inaccurate resistivities, which are not representative of the resistivity of the other zones far from the electrodes. This phenomenon is particularly important for high in-plane resistivity and thin materials such as GDLs. However, this method is accurate for thick materials such as BPP graphite materials.

The last method, using golden microwire probes, is considered the most accurate, but rather difficult to implement. The micro-electrodes are quite fragile materials that must be handled with great care. Contact problems may appear for small pressures, and other materials may stick on the surface of the wires. Microwires/probes are also used in refs. [37, 41].

2.3 | Measurement Methods for In-Plane Resistance

In-plane resistivity is generally measured using a four-probe method. A current is applied between two points in the surface of a GDL, and the voltage is measured between two other points of the surface along that line. Ismail et al. [53] presented such a measurement apparatus, shown in Figure 4a [53]. Miyazawa et al. [41] measured in-plane resistivity in two principal plane directions using a four-probe method by varying the distance between the probes. Aydin et al. [43, 51] determined in-plane

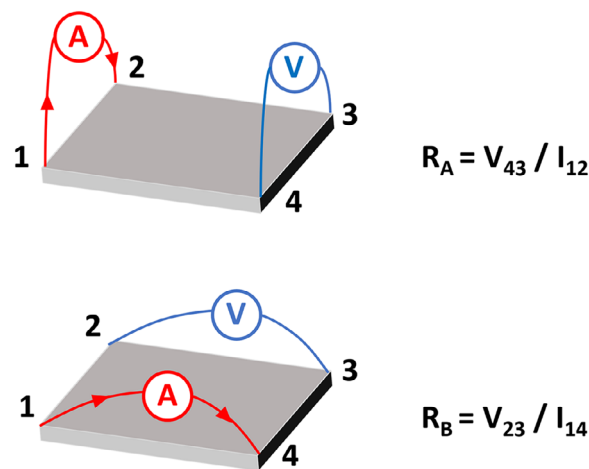

FIGURE 5 | Van Der Pauw method.

resistivity using a four-point measurement method with small gold pins to avoid additional R_c . To account for the GDL structure's inhomogeneity, several points of measurement were used in diagonal, non-perpendicular to the equipotential lines, as shown in Figure 4b [43].

Another method that can be used to measure in-plane resistivity is called the Van Der Pauw method. As depicted in Figure 5, a four-point measurement method is developed to measure the in-plane resistivity of an isotropic sample. The measurement points with a small contact area are generally equidistant and placed at the edges of the sample. The current is provided by two points (1, 2), and the voltage is measured between the two others (3, 4). Then the current is applied between 1 and 4, and measured between 2 and 3, as in Figure 5 [54]. The sample undergoes the final application of a geometric correction factor [55].

Todd et al. [56, 57] measured through-plane and in-plane resistivities along the fiber and cross-fiber direction using a square four-point-probe arrangement. The in-plane resistivity is measured at several angles to consider the material's anisotropy (machine and cross-machine direction). Finally, in-plane resistivity can be deduced from the TLM described in Figure 2b as in the work of Ye et al. [34]. The authors extracted the bulk resistivity from the slope of this curve using GDL thickness, representing the in-plane resistivity.

3 | Typical Results and Development Prospects

Various commercial GDLs with different structures, carbonized straight fiber (SGL 24AA, SGL 24BA, SGL24BC, SGL 38 BC), graphitized straight fiber (Toray H120, Toray H90), and felt fiber (SGL 10BA, Freudenberg H14C9, Freudenberg H2315I5), were analyzed. Typical measures of R_c versus compression show a nonlinear decrease, as in Figure 6 [40]. These results were obtained by using the TLM on six commercial GDLs. Regardless of compression level, the electric R_c is in the [3–74 $\text{m}\Omega \text{ cm}^2$] range. The smallest *contact resistances* were measured for the graphitized straight carbon papers from Toray. The felt fiber structures exhibit R_c values between those of SGL with straight fiber structure. A nonlinear decrease of through-plane resistance

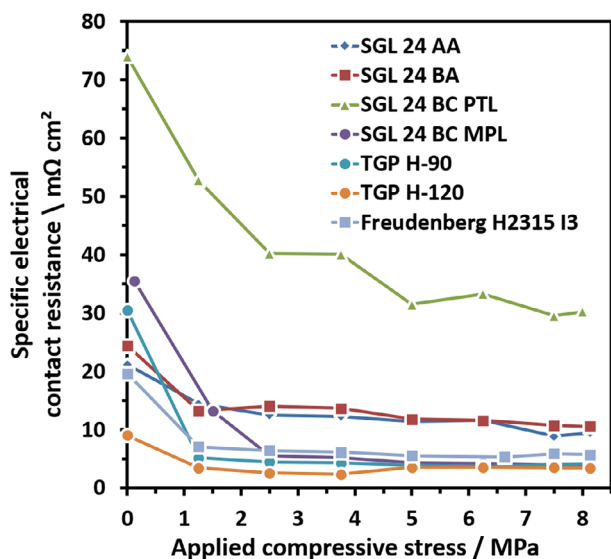

FIGURE 6 | Typical electrical contact resistance as a function of the applied stress for several commercial GDLs. Source: Redrawn from Bouziane et al. [40].

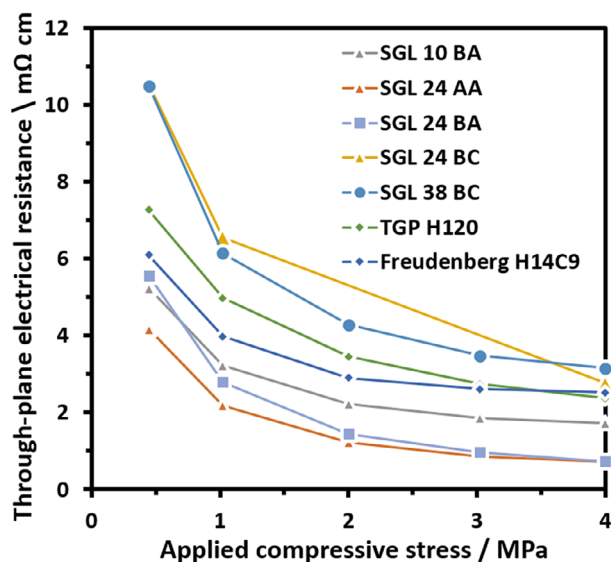

FIGURE 7 | Typical through-plane resistance versus applied compression pressure for the first cycle of compression and several commercial GDLs [50].

with compression is also observed in Figure 7 [52]. For these results, the gold electrode method was applied on seven commercial GDLs. An important decrease is typically observed from 0 to 2 MPa, then a lower one above 2 MPa. Concerning the through-plane resistance values ($[1\text{--}11 \text{ m}\Omega \text{ cm}^2]$), the variation as a function of structure seems unclear. As expected, there is also a nonlinear decrease in in-plane electrical resistivity with an increased pressure, as presented in Figure 8 [52]. Due to the manufacturing process and their structure, the GDLs have orthotropic properties within the plane, along both the machine and transverse directions, and perpendicular to the plane [58]. This is the reason why six commercial GDL references

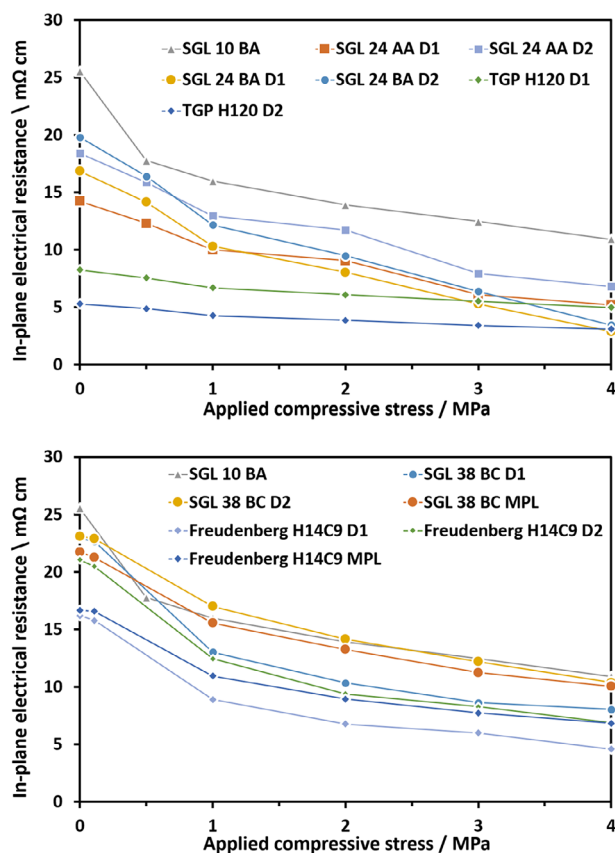

FIGURE 8 | Typical in-plane resistance as a function of applied compression pressure for the first cycle of compression and several commercial GDLs [50]. MPL, microporous layer.

were tested with a four-point measurement method according to two perpendicular directions D1 and D2, and also on MPL side if present. The electric in-plane resistance is in the 3–26 $\text{m}\Omega \text{ cm}$ range. The graphitized straight fiber structures have the smallest in-plane resistance. The felt fiber structures exhibit lower resistances than the straight fiber structures. Despite many ex situ studies relating clamping pressure to GDL resistivity, very few works deal with real cell operating conditions, such as variable compression loads or temperature/humidity constraints, and their contribution to ohmic losses. There is obviously a lack of knowledge and analysis concerning the effect of different cycles of compression on the GDL resistances. Most resistivities are measured under static compression and a few times on pre-conditioned GDLs. PEMFCs operate at temperatures ranging from room temperature to 90°C , and under different humidity/saturated water conditions. However, most ex situ measurements of GDL mechanical and electrical properties are done under room temperature and dry conditions. The experimental work to be carried out involves duplicating FC operating conditions (cyclic compression, temperature, and humidity) in a laboratory, which can be quite complex. Knowledge of the effects of temperature and humidity, in conjunction with mechanical loading, on the electrical resistances can obviously contribute to a better understanding of the shape of the PEMFC polarization curve [52]. Future work can therefore be motivated by the need for data concerning GDL electrical properties under actual PEMFC operating conditions.

These GDL characterizations and identifications of ohmic losses usually raise another issue, that of the lack of relationship between the different resistivities measured (R_c , bulk resistance). The ability to estimate the corresponding measurement uncertainties [40] and to deconvolve their values is one of the most interesting challenges for identifying the sources of losses and potentially their in-operando trends. The need for appropriate protocols such as subtraction techniques or digital twins is obvious.

All these gaps in information relating to GDL resistivity limit the accuracy and scope of theoretical and numerical models of PEMFC performance that require experimental data for validation. Further data could help stack designers make early choices on GDL structure, composition, and thickness. These features need to be considered and related to the technical requirements for various FC end-products (e.g., the use of GDLs that are less sensitive to cycles of compression in mobility applications). Additional input data would be useful for the development of more complex FC performance models. Databases could also contribute to design new GDLs based on innovative architectures and materials [59].

4 | Conclusion and Outlook

The performance of PEMFCs is strongly linked to the influence of mechanical stress, with the GDL being the cell component most sensitive to compression. This constraint leads to electronic losses of various origins that need to be identified and quantified. Reducing these ohmic resistances can in fact contribute to higher FC efficiency. A 1%–3% increase in efficiency would result in lower fuel consumption and even more compact, cheaper FC systems. This article therefore focuses on the ex situ typical characterization methods used to measure the three key electrical parameters of the GDL under compressive stress, R_c with BPP, through-plane resistance, and in-plane resistance. A series of experimental results, obtained for several types and structures of GDL, have also been presented to illustrate the application of these methods and to show the typical trends of the three electrical resistances as a function of mechanical stress.

A number of technical and scientific challenges remain to determine the electrical resistances of GDLs under compression, and they provide new insights for future research. For instance, beyond the ex situ characterization of GDLs, there is a need for in situ and/or in operando analysis to assess the behavior of GDLs in cells or stacks under compressive stress. Again, this requires the development of specific testbenches to be able to obtain data. The challenging objective is then to link the operating conditions and their influences on the component properties to the overall PEMFC performance [60, 61].

Acknowledgments

The “Conseil Région de Bourgogne-Franche-Comté” is gratefully acknowledged for its support through the ELICOP Project (Refs. 2015C-4944 and 2015e4948). The French “Ministère de l’Enseignement supérieur, de la Recherche et de l’Innovation” is gratefully acknowledged

for the funding of Khadidja Bouziane’s PhD Thesis (Contrat doctoral Univ. Paris Sud n° 2017-225).

Data Availability Statement

Data are available on request from the authors.

References

1. S. R. Dhanushkodi, F. Capitanio, T. Biggs, and W. Merida, “Understanding Flexural, Mechanical and Physico-Chemical Properties of Gas Diffusion Layers for Polymer Membrane Fuel Cell and Electrolyzer Systems,” *International Journal Hydrogen Energy* 40 (2015): 16846–16859.
2. B. Blunier and A. Miraoui, *Piles À Combustible: Principes, Modélisation, Applications Avec Exercices et Problèmes Corrigés* (London: ELLIPSES, 2007).
3. S. Park, J.-W. Lee, and B. N. Popov, “A Review of Gas Diffusion Layer in PEM Fuel Cells: Materials and Designs,” *International Journal Hydrogen Energy* 37 (2012): 5850–5865.
4. V. Mishra, F. Yang, and R. Pitchumani, “Measurement and Prediction of Electrical Contact Resistance Between Gas Diffusion Layers and Bipolar Plate for Applications to PEM Fuel Cells,” *Journal of Fuel Cell Science and Technology* 1 (2004): 2–9.
5. S. Park and B. N. Popov, “Effect of a GDL Based on Carbon Paper or Carbon Cloth on PEM Fuel Cell Performance,” *Fuel* 90 (2011): 436–440.
6. S. Chevalier, N. Lavielle, B. D. Hatton, and A. Bazylak, “Novel Electrospun Gas Diffusion Layers for Polymer Electrolyte Membrane Fuel Cells: Part I. Fabrication, Morphological Characterization, and In Situ Performance,” *Journal of Power Sources* 352 (2017): 272–280.
7. X. Xie, R. Wang, K. Jiao, G. Zhang, J. Zhou, and Q. Du, “Investigation of the Effect of Micro-Porous Layer on PEM Fuel Cell Cold Start Operation,” *Renewable Energy* 117 (2018): 125–134.
8. R. Schweiss, C. Meiser, T. Damjanovic, I. Galbiati, and N. Haak, *SGL Carbon—Powering up Fuel Cells—Our Gas Diffusion Layer [White Paper], Can be Found Under* (Wisebaden: SGL Carbon, 2024), www.sglcarbon.com/en/markets-solutions/material/sigracet-fuel-cell-components.
9. F. Lapique, M. Belhadj, C. Bonnet, J. Pauchet, and Y. Thomas, “A Critical Review on Gas Diffusion Micro and Macroporous Layers Degradations for Improved Membrane Fuel Cell Durability,” *Journal of Power Sources* 336 (2016): 40–53.
10. Y. Pan, H. Wang, and N. P. Brandon, “Gas Diffusion Layer Degradation in Proton Exchange Membrane Fuel Cells: Mechanisms, Characterization Techniques and Modelling Approaches,” *Journal of Power Sources* 513 (2021): 230560.
11. Y. Yang, X. Zhou, B. Li, and C. Zhang, “Recent Progress of the Gas Diffusion Layer in Proton Exchange Membrane Fuel Cells: Material and Structure Designs of Microporous Layer,” *International Journal Hydrogen Energy* 46 (2021): 4259.
12. R. Omrani and B. Shabani, “Gas Diffusion Layer Modifications and Treatments for Improving the Performance of Proton Exchange Membrane Fuel Cells and Electrolysers: A Review,” *International Journal Hydrogen Energy* 42 (2017): 28515–28536.
13. A. Forner-Cuenca, J. Biesdorf, L. Gubler, P. M. Kristiansen, T. J. Schmidt, and P. Boillat, “Engineered Water Highways in Fuel Cells: Radiation Grafting of Gas Diffusion Layers,” *Advanced Materials* 27 (2015): 6317–6322.
14. D. Gerteisen and C. Sadeler, “Stability and Performance Improvement of a Polymer Electrolyte Membrane Fuel Cell Stack by Laser Perforation of Gas Diffusion Layers,” *Journal of Power Sources* 195 (2010): 5252–5257.
15. D. Gerteisen, T. Heilmann, and C. Ziegler, “Enhancing Liquid Water Transport by Laser Perforation of a GDL in a PEM Fuel Cell,” *Journal of Power Sources* 177 (2008): 348–354.

16. J. H. Chun, D. H. Jo, S. G. Kim, et al., "Development of a Porosity-Graded Micro Porous Layer Using Thermal Expandable Graphite for Proton Exchange Membrane Fuel Cells," *Renewable Energy* 58 (2013): 28–33.
17. I. M. Kong, J. W. Choi, S. I. Kim, E. S. Lee, and M. S. Kim, "Experimental Study on the Self-Humidification Effect in Proton Exchange Membrane Fuel Cells Containing Double Gas Diffusion Backing Layer," *Applied Energy* 145 (2015): 345–353.
18. I. M. Kong, A. Jung, and M. S. Kim, "Investigations on the Double Gas Diffusion Backing Layer for Performance Improvement of Self-Humidified Proton Exchange Membrane Fuel Cells," *Applied Energy* 176 (2016): 149–156.
19. E. E. Kahveci and I. Taymaz, "Experimental Study on Performance Evaluation of PEM Fuel Cell by Coating Bipolar Plate With Materials Having Different Contact Angle," *Fuel* 253 (2019): 1274–1281.
20. A. El-Kharouf, T. J. Mason, D. J. Brett, and B. G. Pollet, "Ex-Situ Characterization of Gas Diffusion Layers for Proton Exchange Membrane Fuel Cells," *Journal of Power Sources* 218 (2012): 393–404.
21. M. F. Mathias, J. Roth, J. Fleming, and W. Lehnert, "Diffusion Media Materials and Characterization," in *Handbook of Fuel Cells: Fundamentals Technology and Applications*, eds. W. Vielstich, A. Lamm, and H. A. Gasteiger (New York: John Wiley & Sons, 2003), Vol. 3, 517–537.
22. R. B. Mathur, P. H. Maheshwari, T. L. Dhami, and R. P. Tandon, "Characteristics of the Carbon Paper Heat-Treated to Different Temperatures and its Influence on the Performance of PEM Fuel Cell," *Electrochimica Acta* 52 (2007): 4809–4817.
23. A. El-kharouf and R. Steinberger-Wilckens, "The Effect of Clamping Pressure on Gas Diffusion Layer Performance in Polymer Electrolyte Fuel Cells," *Fuel Cells* 15 (2015): 802–812.
24. Y. Leng, H. Yao, D. Yang, B. Li, P. Ming, and C. Zhang, "The Influences of Gas Diffusion Layer Material Models and Parameters on Mechanical Analysis of Proton Exchange Membrane Fuel Cell," *Fuel Cells* 21 (2021): 373–389.
25. J. Millichamp, T. J. Mason, T. P. Neville, et al., "Mechanisms and Effects of Mechanical Compression and Dimensional Change in Polymer Electrolyte Fuel Cells—A Review," *Journal of Power Sources* 284 (2015): 305–320.
26. A. C. Bhosale and R. Rengaswamy, "Interfacial Contact Resistance in Polymer Electrolyte Membrane Fuel Cells: Recent Developments and Challenges," *Renewable Sustainable Energy Reviews* 115 (2019): 109351.
27. X. Z. Yuan, E. Gu, R. Bredin, et al., "Development of a 3-in-1 Device to Simultaneously Measure Properties of Gas Diffusion Layer for the Quality Control of Proton Exchange Membrane Fuel Cell Components," *Journal of Power Sources* 477 (2020): 229009.
28. Y. Faydi, R. Lachat, P. Lesage, and Y. Meyer, "Experimental Characterization Method of the Gas Diffusion Layers Compression Modulus for High Compressive Loads and Based on a Dynamic Mechanical Analysis," *Journal of Fuel Cell Science and Technology* 12 (2015): 054501.
29. L. Xiao, L. Zhu, C. Clökler, et al., "Experimental Validation of Pore-Scale Models for Gas Diffusion Layers," *Journal of Power Sources* 536 (2022): 231515.
30. P. A. Gigos, Y. Faydi, and Y. Meyer, "Mechanical Characterization and Analytical Modeling of Gas Diffusion Layers Under Cyclic Compression," *International Journal Hydrogen Energy* 40 (2015): 5958–5965.
31. M. Taş and G. Elden, "An Experimental Investigation of the Effects of Operating Conditions on Anisotropic Electrical Conductivity in a PEM Fuel Cell," *Fuel Cells* 20 (2020): 531–539.
32. S. Lædre, C. M. Craciunescu, T. Khoza, et al., "Issues Regarding Bipolar Plate-Gas Diffusion Layer Interfacial Contact Resistance Determination," *Journal of Power Sources* 530 (2022): 231275.
33. C. J. Netwall, B. D. Gould, J. A. Rodgers, N. J. Nasello, and K. E. Swider-Lyons, "Decreasing Contact Resistance in Proton-Exchange Membrane Fuel Cells With Metal Bipolar Plates," *Journal of Power Sources* 227 (2013): 137–144.
34. D. Ye, E. Gauthier, J. B. Benziger, and M. Pan, "Bulk and Contact Resistances of Gas Diffusion Layers in Proton Exchange Membrane Fuel Cells," *Journal of Power Sources* 256 (2014): 449–456.
35. A. Ozden, S. Shahgaldi, X. Li, and F. Hamdullahpur, "A Review of Gas Diffusion Layers for Proton Exchange Membrane Fuel Cells—With a Focus on Characteristics, Characterization Techniques, Materials and Designs," *Progress in Energy and Combustion Science* 74 (2019): 50–102.
36. A. Arvay, E. Yli-Rantala, C.-H. Liu, et al., "Characterization Techniques for Gas Diffusion Layers for Proton Exchange Membrane Fuel Cells—A Review," *Journal of Power Sources* 213 (2012): 317–337.
37. P. K. Sow, S. Prass, P. Kalisvaart, and W. Mérida, "Deconvolution of Electrical Contact and Bulk Resistance of Gas Diffusion Layers for Fuel Cell Applications," *International Journal Hydrogen Energy* 40 (2015): 2850–2861.
38. H. Sadeghifar, "In-Plane and Through-Plane Electrical Conductivities and Contact Resistances of a Mercedes-Benz Catalyst-Coated Membrane, Gas Diffusion and Micro-Porous Layers and a Ballard Graphite Bipolar Plate: Impact of Humidity, Compressive Load and Polytetrafluoroethylene," *Energy Conversion and Management* 154 (2017): 191–202.
39. D. Qiu, L. Peng, P. Yi, and X. Lai, "A Micro Contact Model for Electrical Contact Resistance Prediction Between Roughness Surface and Carbon Fiber Paper," *International Journal of Mechanical Sciences* 124 (2017): 37–47.
40. K. Bouziane, R. Lachat, N. Zamel, Y. Meyer, and D. Candusso, "Impact of Cyclic Mechanical Compression on the Electrical Contact Resistance Between the Gas Diffusion Layer and the Bipolar Plate of a Polymer Electrolyte Membrane Fuel Cell," *Renewable Energy* 153 (2020): 349–361.
41. A. Miyazawa, T. Himeno, and A. Nishikata, "Electrical Properties of Bipolar Plate and Gas Diffusion Layer in PEFC," *Journal of Power Sources* 220 (2012): 199–204.
42. A. Vikram, P. R. Chowdhury, R. K. Phillips, and M. Hoorfar, "Measurement of Effective Bulk and Contact Resistance of Gas Diffusion Layer Under Inhomogeneous Compression—Part I: Electrical Conductivity," *Journal of Power Sources* 320 (2016): 274–285.
43. Ö. Aydin, M. Zedda, and N. Zamel, "Challenges Associated With Measuring the Intrinsic Electrical Conductivity of Carbon Paper Diffusion Media," *Fuel Cells* 15 (2015): 537–544.
44. T. J. Mason, J. Millichamp, T. P. Neville, A. El-Kharouf, B. G. Pollet, and D. J. Brett, "Effect of Clamping Pressure on Ohmic Resistance and Compression of Gas Diffusion Layers for Polymer Electrolyte Fuel Cells," *Journal of Power Sources* 219 (2012): 52–59.
45. M. S. Ismail, D. B. Ingham, L. Ma, and M. Pourkashanian, "The Contact Resistance Between Gas Diffusion Layers and Bipolar Plates as They are Assembled in Proton Exchange Membrane Fuel Cells," *Renewable Energy* 52 (2013): 40–45.
46. L. Zhang, Y. Liu, H. Song, S. Wang, Y. Zhou, and S. J. Hu, "Estimation of Contact Resistance in Proton Exchange Membrane Fuel Cells," *Journal of Power Sources* 162 (2006): 1165–1171.
47. P. Zhou, P. Lin, C. W. Wu, and Z. Li, "Effect of Nonuniformity of the Contact Pressure Distribution on the Electrical Contact Resistance in Proton Exchange Membrane Fuel Cells," *International Journal Hydrogen Energy* 36 (2011): 6039–6044.
48. X. Lai, L. Peng, and J. Ni, "A Mechanical-Electrical Finite Element Method Model for Predicting Contact Resistance Between Bipolar Plate and Gas Diffusion Layer in PEM Fuel Cells," *Journal of Power Sources* 182 (2008): 153–159.
49. S. El Oualid, R. Lachat, D. Candusso, and Y. Meyer, "Characterization Process to Measure the Electrical Contact Resistance of Gas Diffusion Layers Under Mechanical Static Compressive Loads," *International Journal Hydrogen Energy* 42 (2017): 23920–23931.

50. H. H. Berger, "Contact Resistance and Contact Resistivity," *Journal of the Electrochemical Society* 119 (1972): 507.
51. Ö. Aydin, M. Zedda, N. Zamel, U. Groos, and C. Hebling, *Proc. 20th World Hydrogen Energy Conf* (Gwangju, South Korea: WHEC, 2014), Vol. 1.
52. K. Bouziane, Ph.D. Thesis, Université Paris-Saclay, France (2021).
53. M. S. Ismail, T. Damjanovic, D. B. Ingham, M. Pourkashanian, and A. Westwood, "Effect of Polytetrafluoroethylene-Treatment and Microporous Layer-Coating on the Electrical Conductivity of Gas Diffusion Layers Used in Proton Exchange Membrane Fuel Cells," *Journal of Power Sources* 195 (2010): 2700–2708.
54. H. Czichos, T. Saito, and L. Smith, *Springer Handbook of Materials Measurement Methods* (Berlin, Germany: Springer, 2006).
55. M. Hamour, J. P. Garnier, J. C. Grandidier, A. Ouibrahim, and S. Martemianov, "Thermal-Conductivity Characterization of Gas Diffusion Layer in Proton Exchange Membrane Fuel Cells and Electrolyzers Under Mechanical Loading," *International Journal of Thermophysics* 32 (2011): 1025–1037.
56. D. Todd, S. Bennett, and W. Mérida, "Anisotropic Electrical Resistance of Proton Exchange Membrane Fuel Cell Transport Layers as a Function of Cyclic Strain," *International Journal Hydrogen Energy* 41 (2016): 6029–6035.
57. D. Todd, M. Schwager, and W. Mérida, "Three-Dimensional Anisotropic Electrical Resistivity of PEM Fuel Cell Transport Layers as Functions of Compressive Strain," *Journal of the Electrochemical Society* 162 (2014): F265–F272.
58. M. Ouerghemmi, C. Carral, and P. Mele, "Determination of the Orthotropic Mechanical Elastic Properties of Gas Diffusion Layers for PEMFCs," *Journal of the Electrochemical Society* 170 (2023): 104508.
59. F. C. Lee, M. S. Ismail, D. B. Ingham, et al., "Alternative Architectures and Materials for PEMFC Gas Diffusion Layers: A Review and Outlook," *Renewable Sustainable Energy Reviews* 166 (2022): 112640.
60. K. J. Mrozewski, Ph.D. Thesis, Université de Toulouse, France (2019).
61. E. M. Khetabi, Ph.D. Thesis, Université Paris-Saclay, France (2021).