

# Introduction to inverse modelling of deformation data

Valérie Cayol, [valerie.cayol@uca.fr](mailto:valerie.cayol@uca.fr)

*Laboratoire Magmas et Volcans, CNRS, UCA, IRD, OPGC,  
F-63000 Clermont-Ferrand, France*



Creative Commons Attribution 4.0  
International (CC BY 4.0)



# Outline

## 1. Introduction

## 2. Modelling

Most famous simple models

More complex models

## 3. Inversions

Linear Inversions

Non-linear inversions

Discriminating complex models

## 4. Benchmarking, Validation, Verification

## 5. Examples of inversions using stress boundary conditions

5.1. Stress inversions as gauges for crustal stress

5.2. Stress inversions for flank failure mechanism

# Why do we model deformation ?

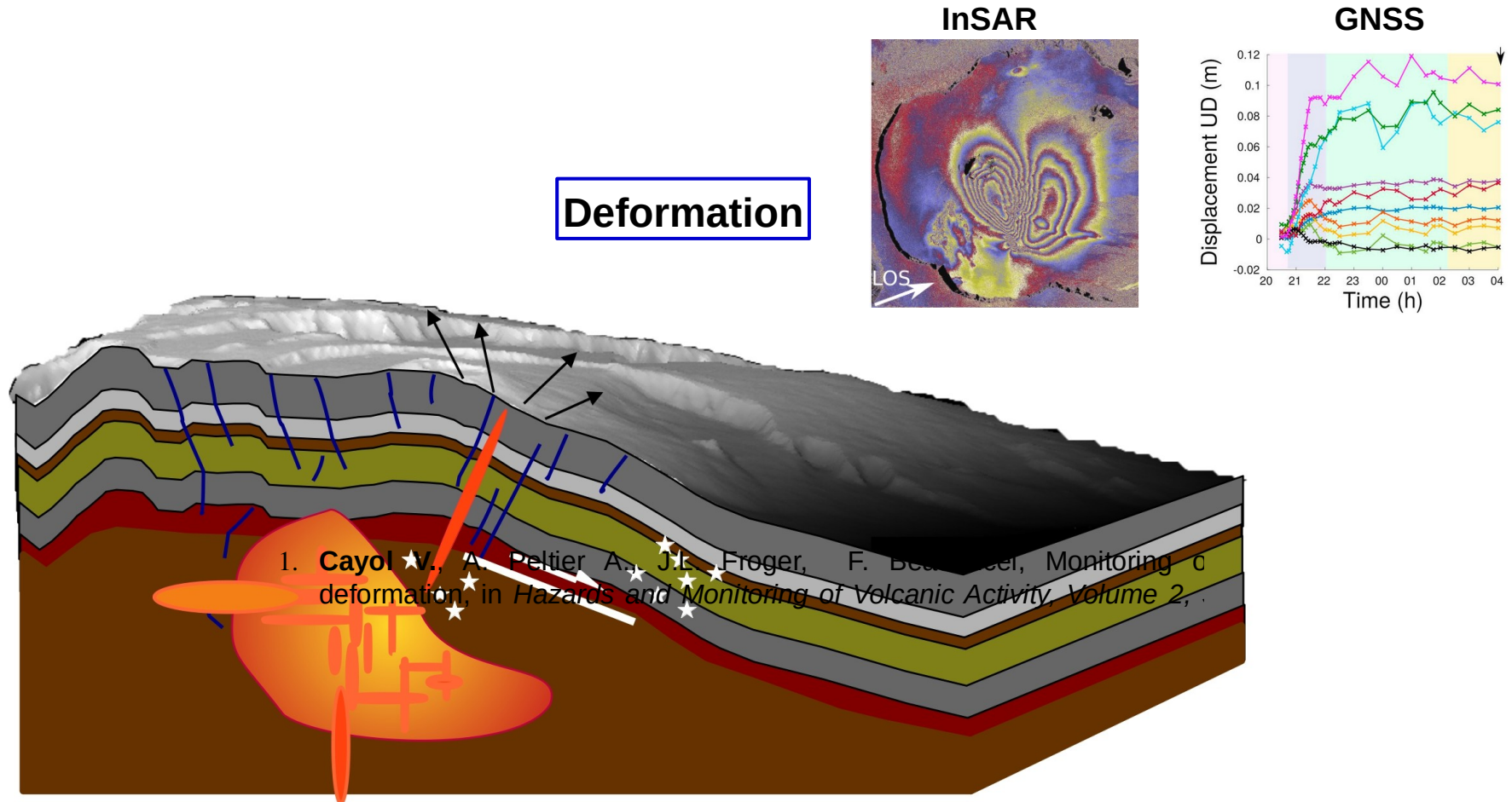

*From Cayol V., et al., ISTE Sci. Publ. LTD, 2022*

**Two objectives of deformation monitoring :**

- To monitor volcanic activity;
- To understand volcanic processes through modelling.

# Why do we model deformation ?

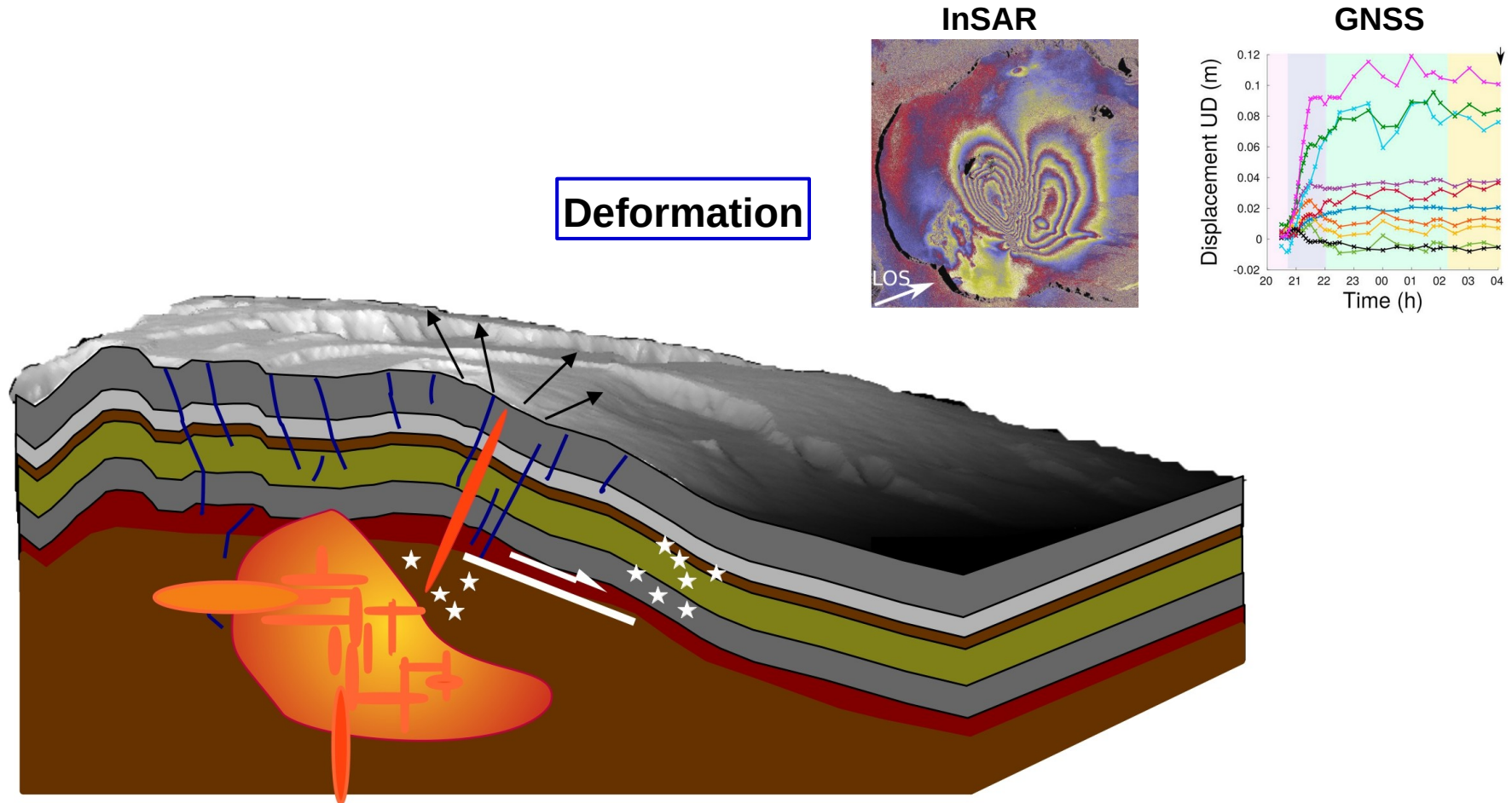

Main questions are

- Where is magma stored ?
- What are the physical and mechanical parameters controlling magma transfer ?
- How do edifices grow and collapse ?

# Forward versus inverse models

Direct problem :  $m \rightarrow u = G(m)$ ,  $m = \text{parameters}$   
(unique)  $u = \text{observations}$

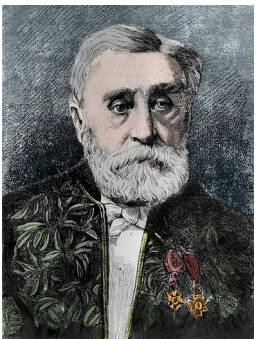
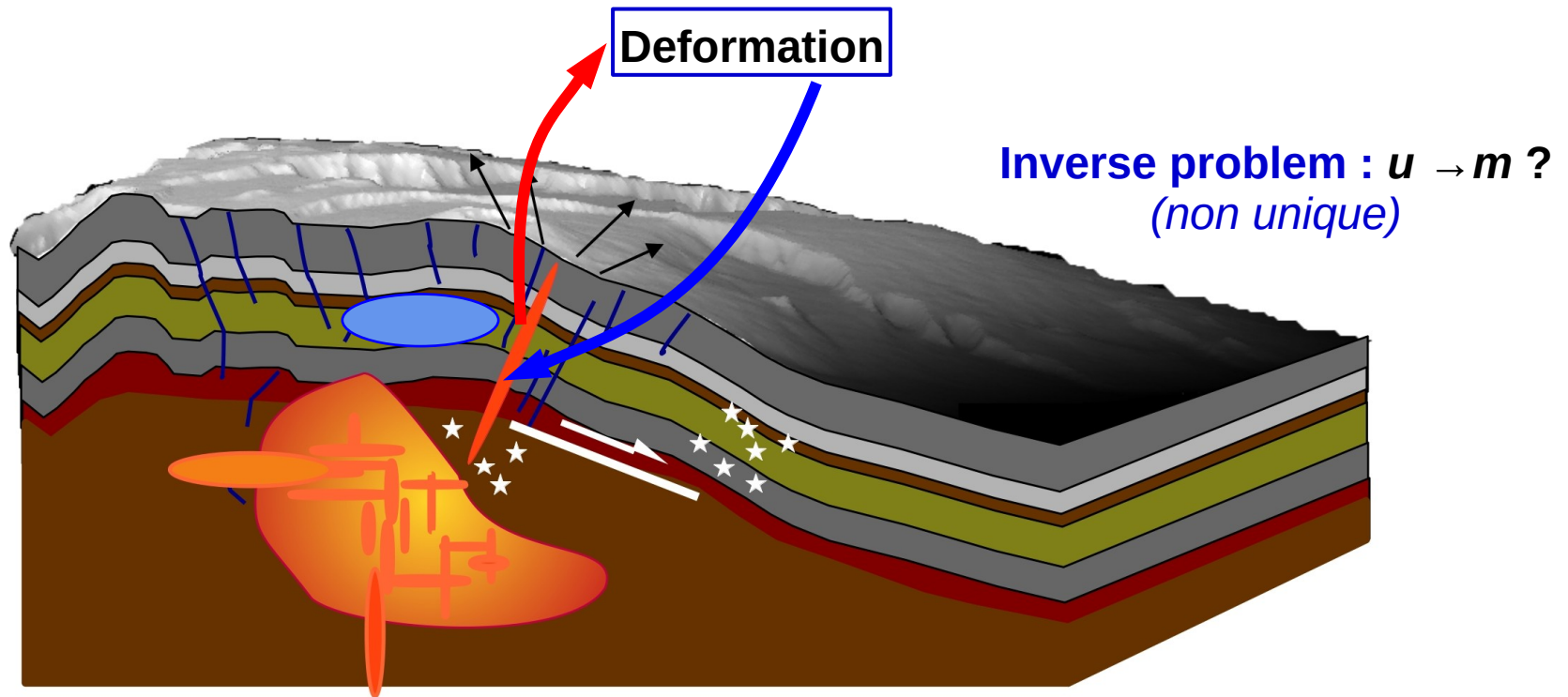

St Venant's principle (1855) "the difference between the effects of two different but statically equivalent loads becomes very small at sufficiently large distances from load »

Adhémar Barré de Saint Venant

## 2. Modelling

**Direct problem:**  $m \rightarrow u = G(m)$ ,  $m = \text{parameters}$   
(*unique*)  $u = \text{observations}$

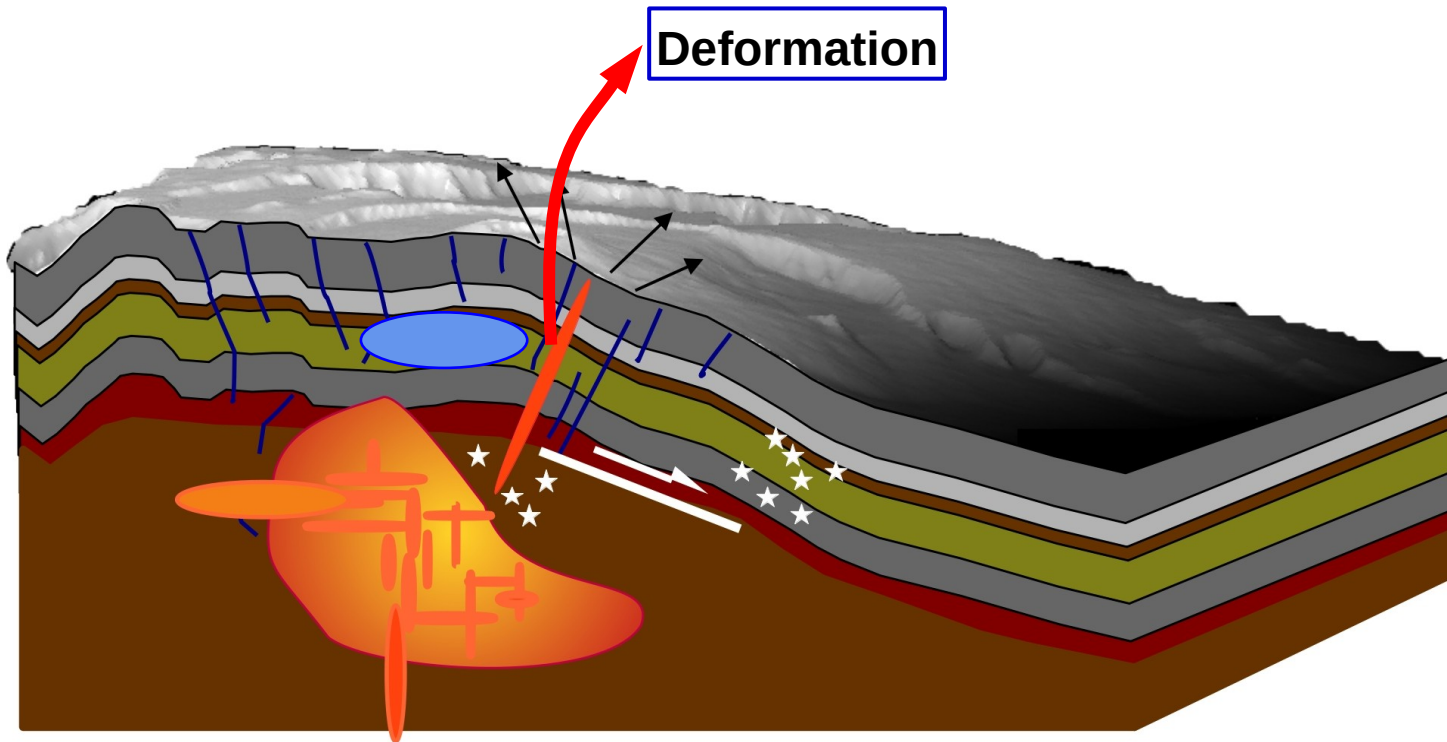

# Hypothesis: linear elasticity

## 1. Linear elasticity : stress is linearly relation to deformation

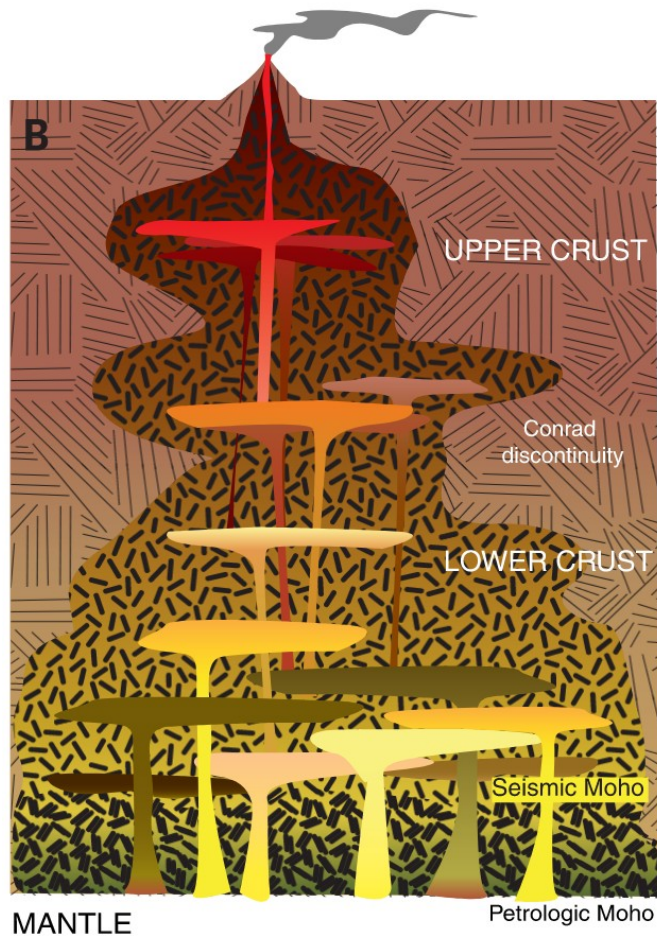

- However, from petrology studies, reservoirs are now considered as being mushes containing magma pockets. Rock behavior is most probably elasto-visco-plastic, or poro-visco elastic over a long time scale.
- St Venant's principle can be used

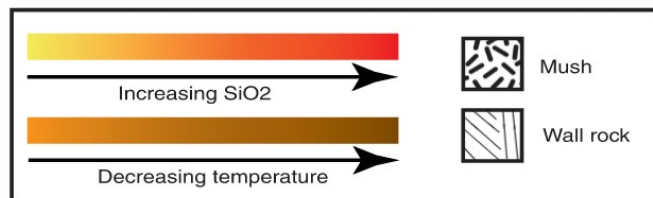

# Hypothesis: linear elasticity

## 1. Linear elasticity : stress is linearly relation to deformation

In situ studies, laboratory experiments and theoretical studies show that inelasticity occurs at the tip of dikes. This zone is small and can therefore be neglected (St Venant's Principle).

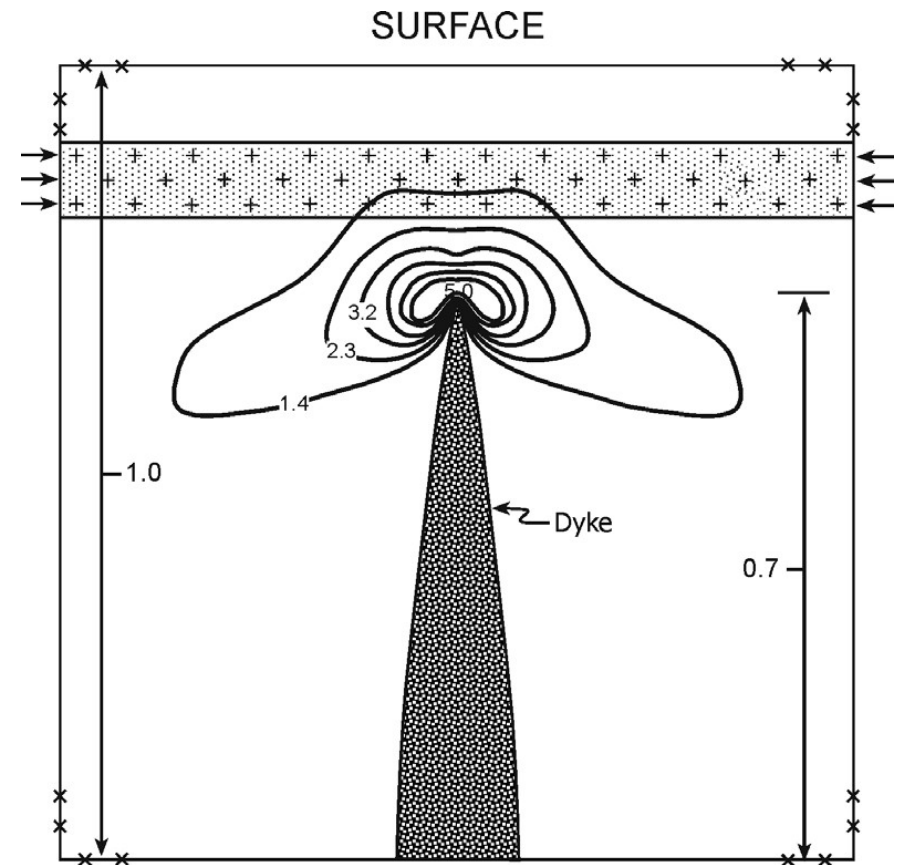



# Hypothesis: homogeneity

## 2. Homogeneity (same mechanical properties everywhere)

Tomography of Piton de la Fournaise (*Prôno et al., JVGR, 2009*) :

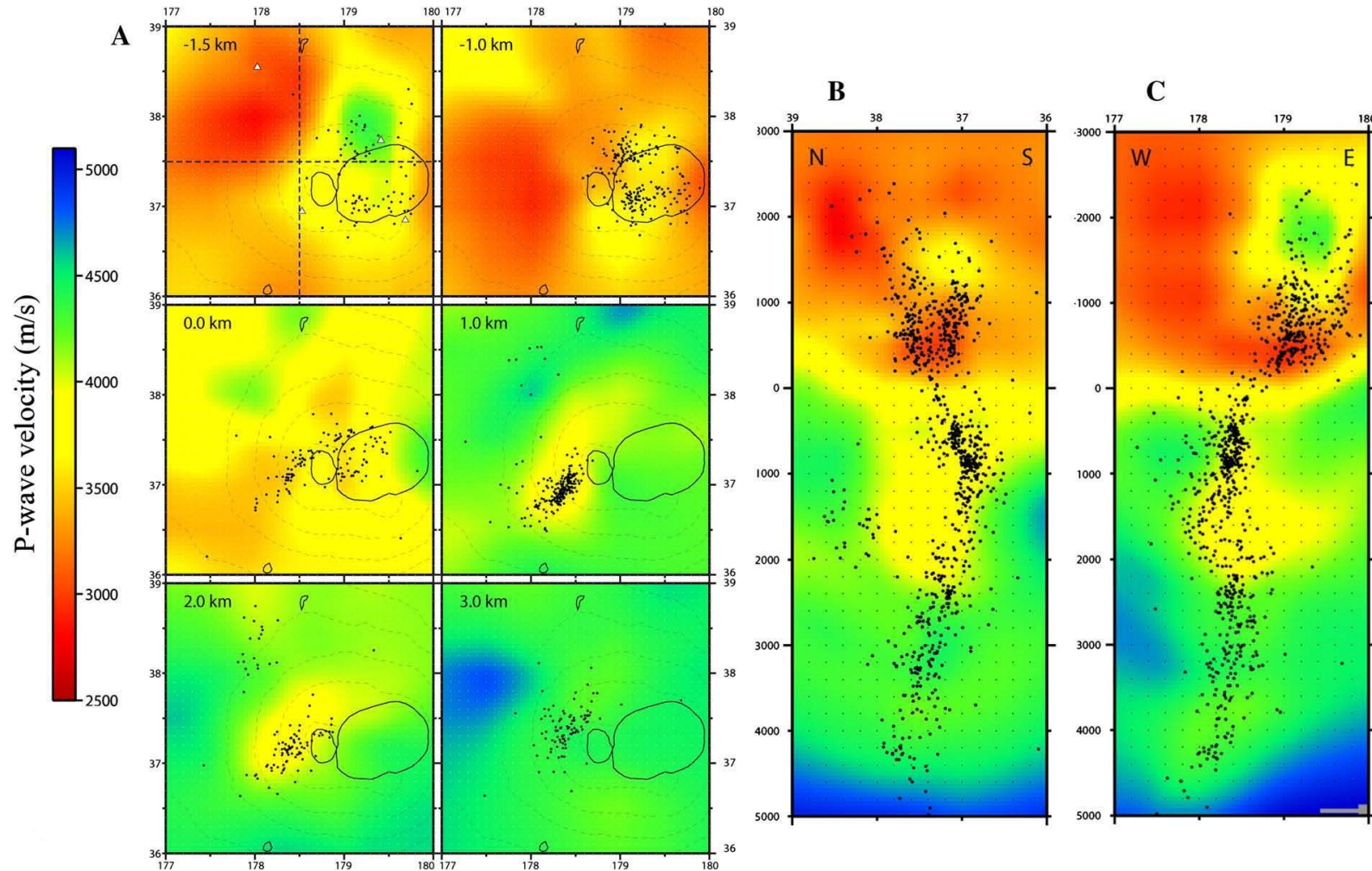

Volcanoes are not really homogeneous, but it is assumed that heterogeneity plays a second-order role.

# Most famous simple models

## 1. Mogi-Yamakawa Model (1958) (Analytic) :

Most widely used model for quantitative interpretation of volcano deformation,  
(google scholar > 2000 times)

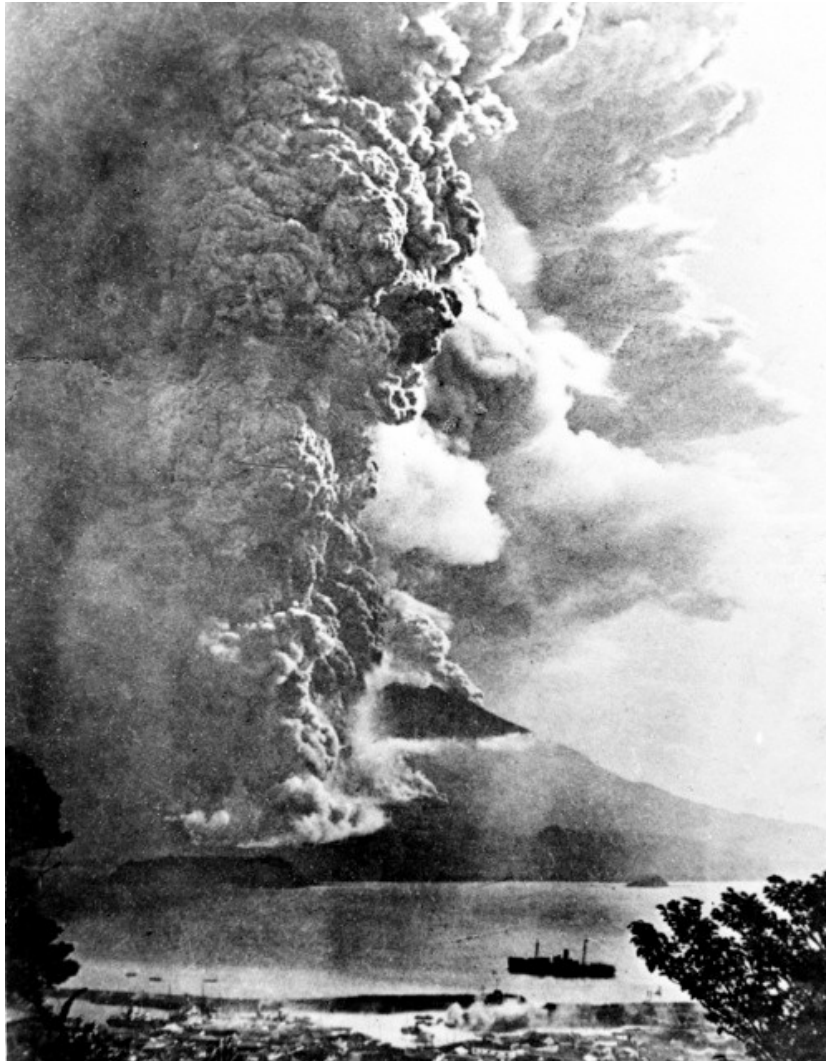

*Sakurajima's 1914 eruption*

# Most famous simple models

## 1. Mogi-Yamakawa Model (1958) (Analytic) :

Most widely used model for quantitative interpretation of volcano deformation, (google scholar > 2000 times)

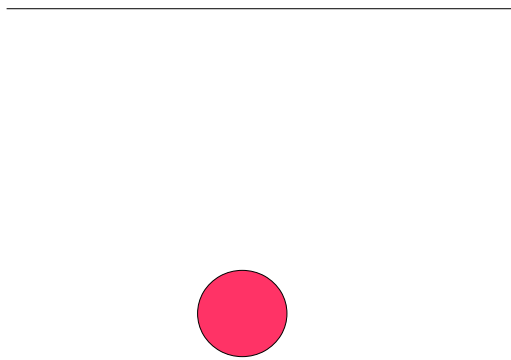

Spherical source in a semi-infinite medium

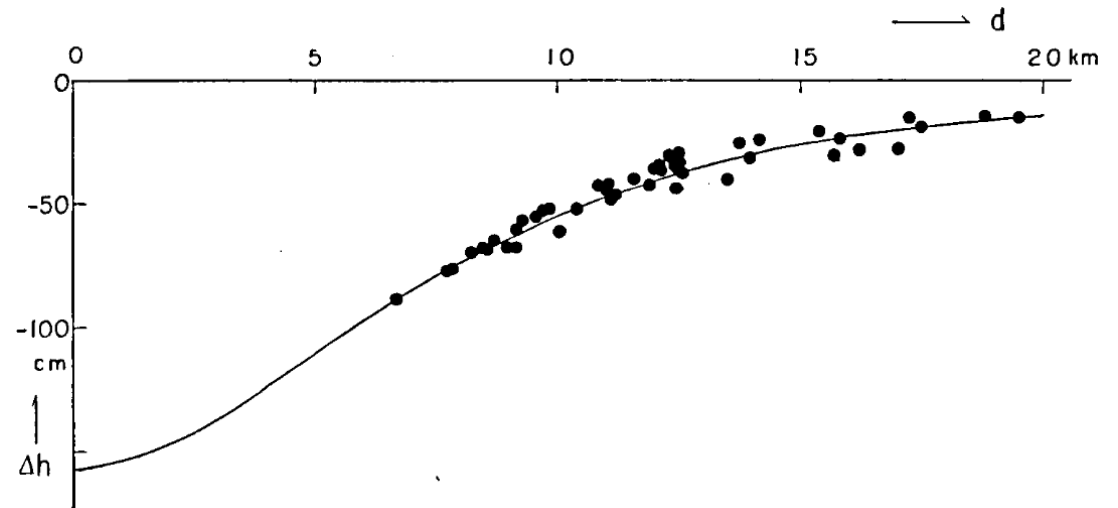

Relationship between vertical displacements ( $\Delta h$ ) and distance ( $d$ ) from the center of the Sakurajima depression during the 1914 eruption

# Most famous simple models

## 1. Mogi-Yamakawa Model (1958) (Analytic) :

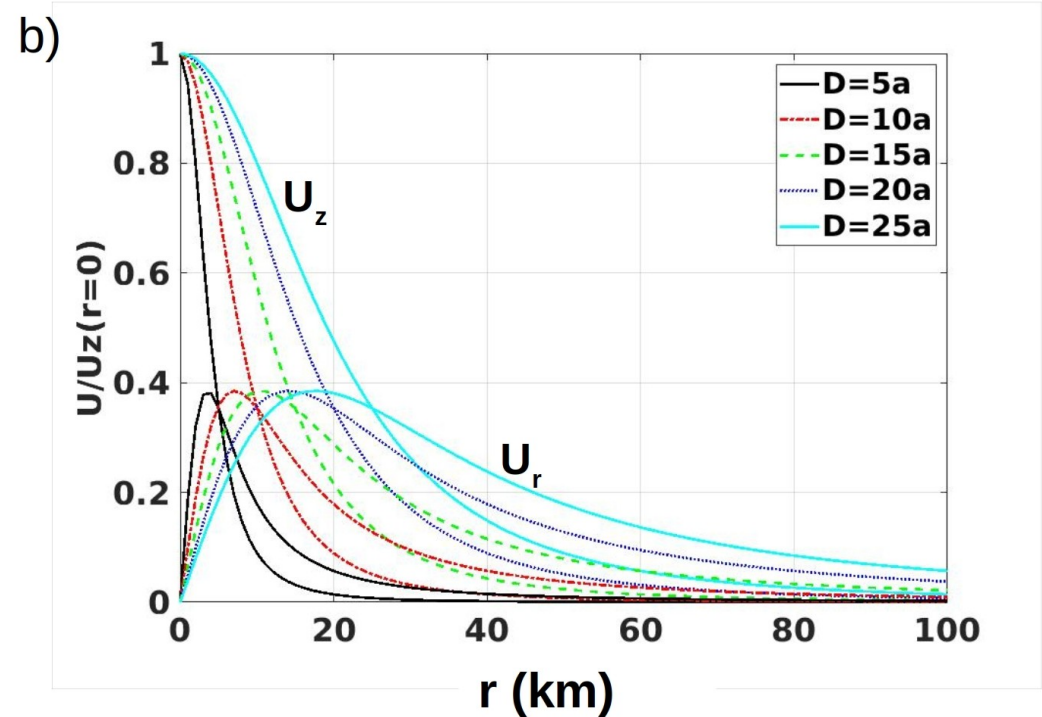
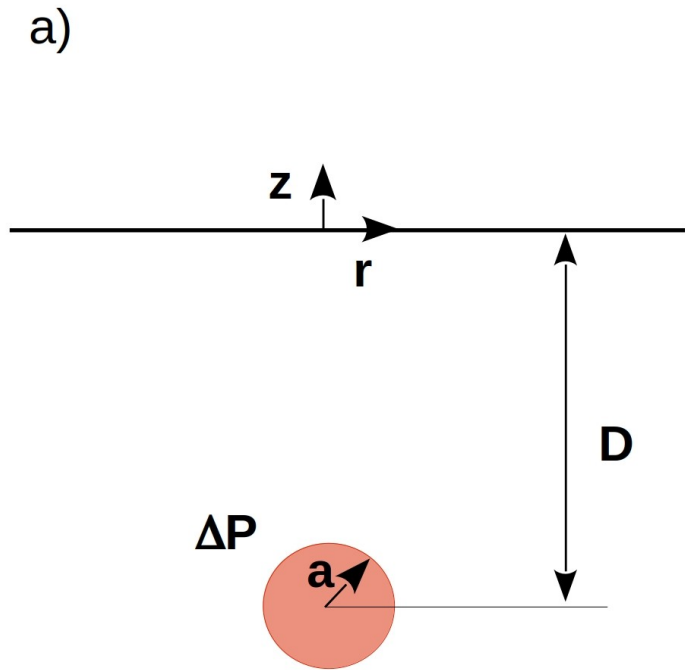

$$U_z(r) = -(1-\nu) \frac{\Delta V}{\pi} \frac{D}{(D^2 + r^2)^{3/2}}$$

$$U_r(r) = (1-\nu) \frac{\Delta V}{\pi} \frac{r}{(D^2 + r^2)^{3/2}}$$

Où  $\Delta V = \frac{\pi}{G} a^3 \Delta P$  et  $G = \frac{E}{2(1+\nu)}$  Shear modulus

➡ Can be used to determine a spherical reservoir location and volume change

# Most famous simple models

## 1. Mogi-Yamakawa Model (1958) (Analytique) $|D/a| \gg 5$

Darwin volcano, The Galapagos  
1992-1998

Data

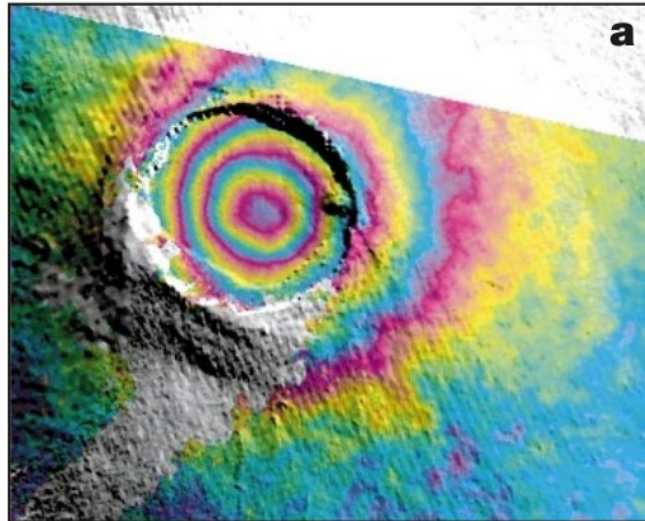

Model ( $D = 3 \text{ km}$ )

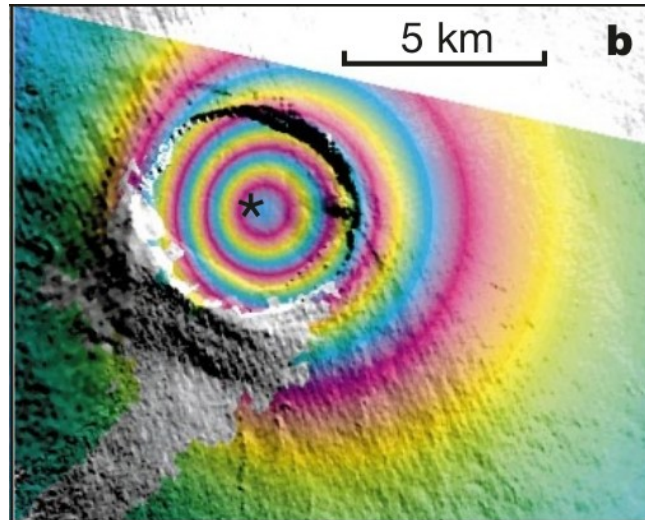

Amelung et al., Nature, 2000

Agung Volcano, Indonesia, Nov-Dec 2017

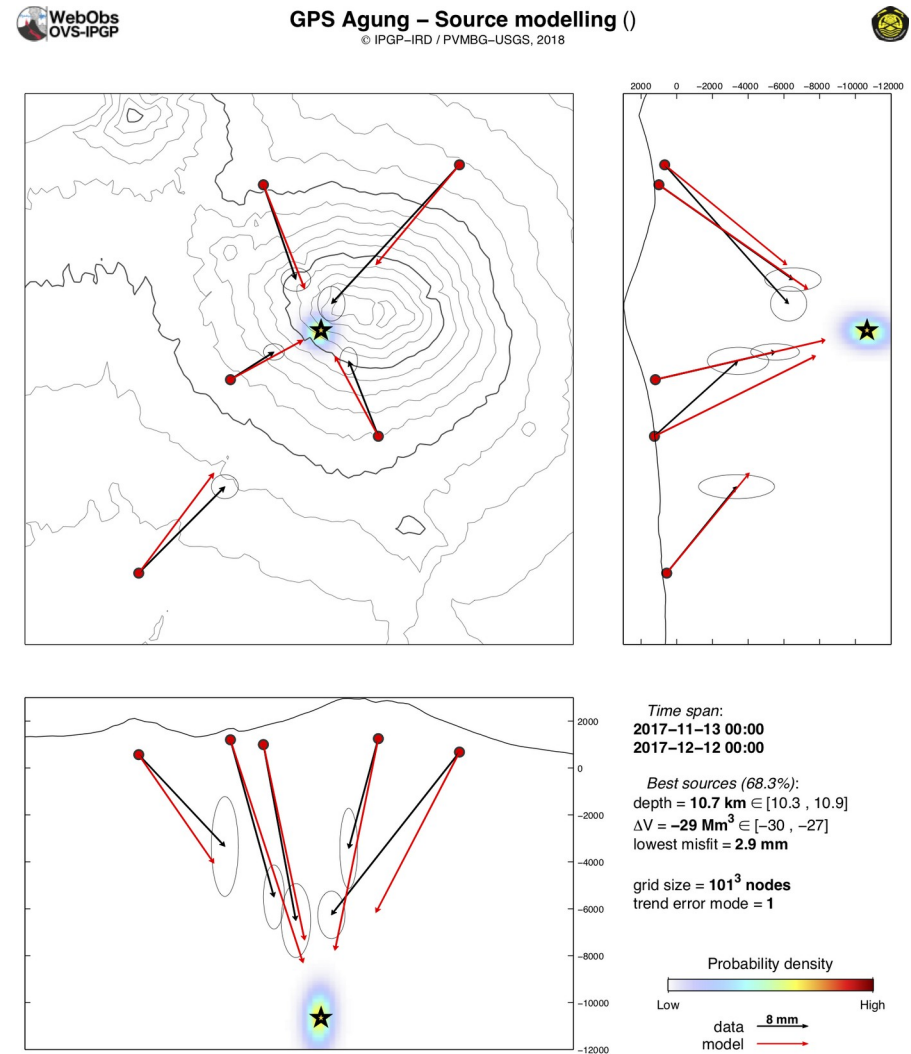

F. Beauducel, Webobs

# Most famous simple models

## 2. Dieterich and Decker's model (1975) (numerical) : Axisymmetrical sources

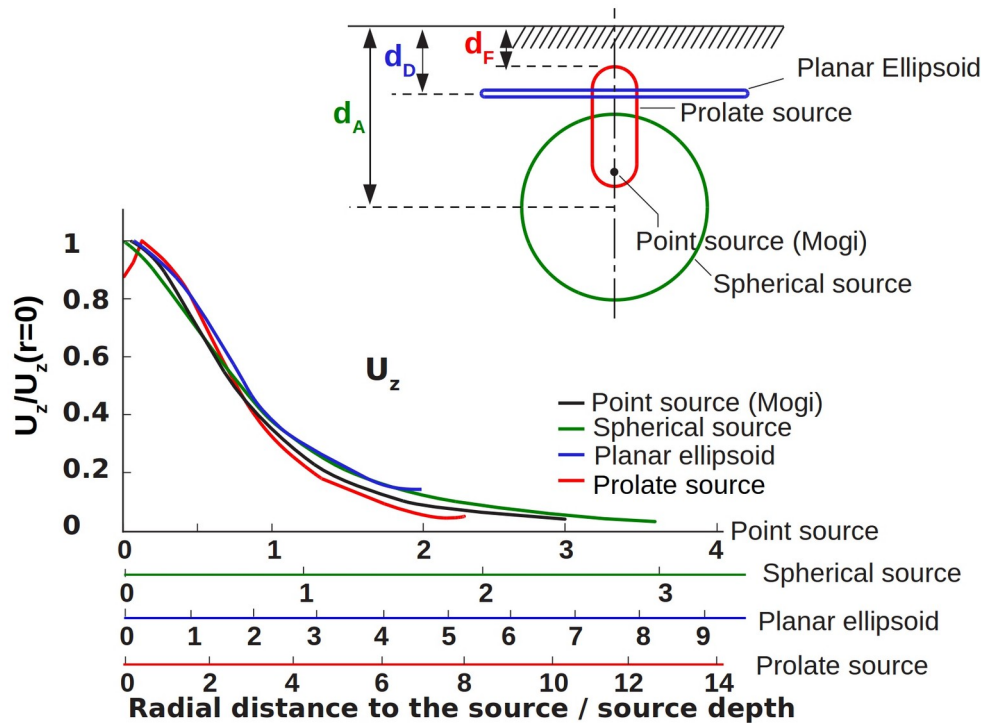

Source depths can be found, such that the shapes of the normalized displacement resemble each other

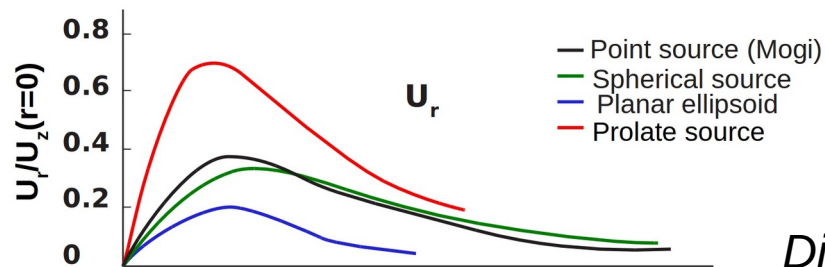

*Dieterich et Decker, JGR, 1975*



Horizontal and vertical displacements are required to determine the geometry, depth, volume change of a pressure source

# Most famous simple models

## 3. Okada's model (1985) (analytic): quoted > 6700 fois

Openings and slips are constant.

Computation of displacements and inclinations associated with rectangular fractures of any orientation. Ground displacements are a function of **10 parameters**

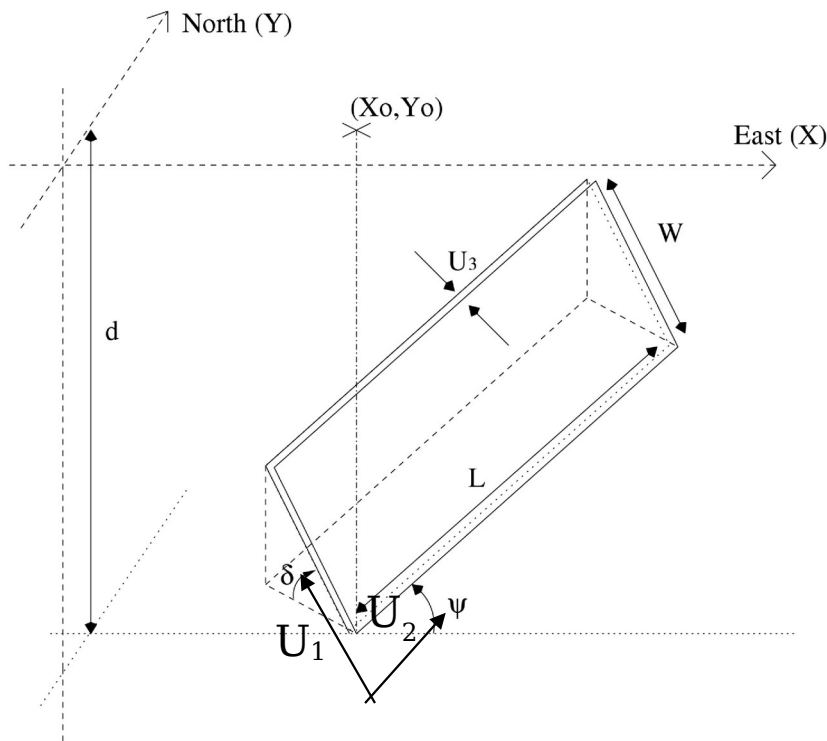

a) Influence of the ground surface proximity

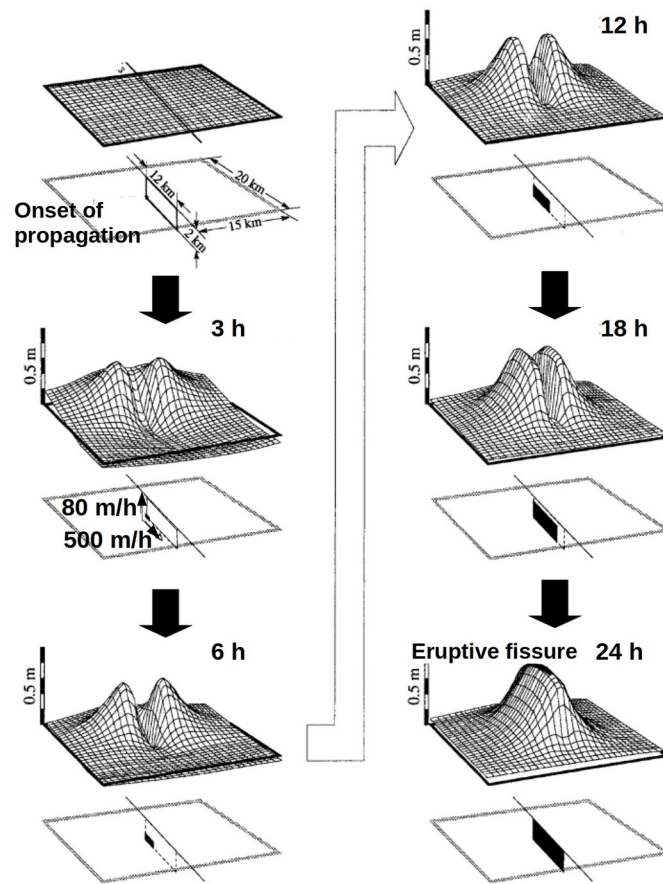

b) Dip influence

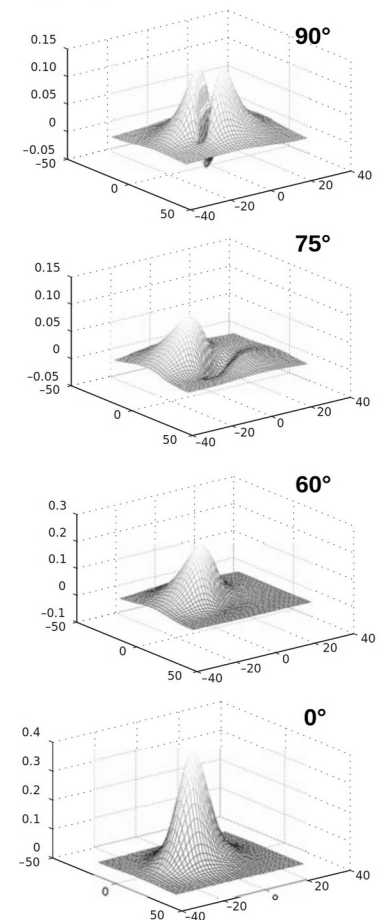

Vertical displacements associated with the propagation of a vertical dike at Kilauea (*Dvorak and Dzurisin, Reviews of Geophysics, 1997*).

# Most famous simple models

## 4. Pollard et al. model (1983) (analytic): pressurized fracture in an infinite medium

Displacement of the elastic medium around the crack under pressure

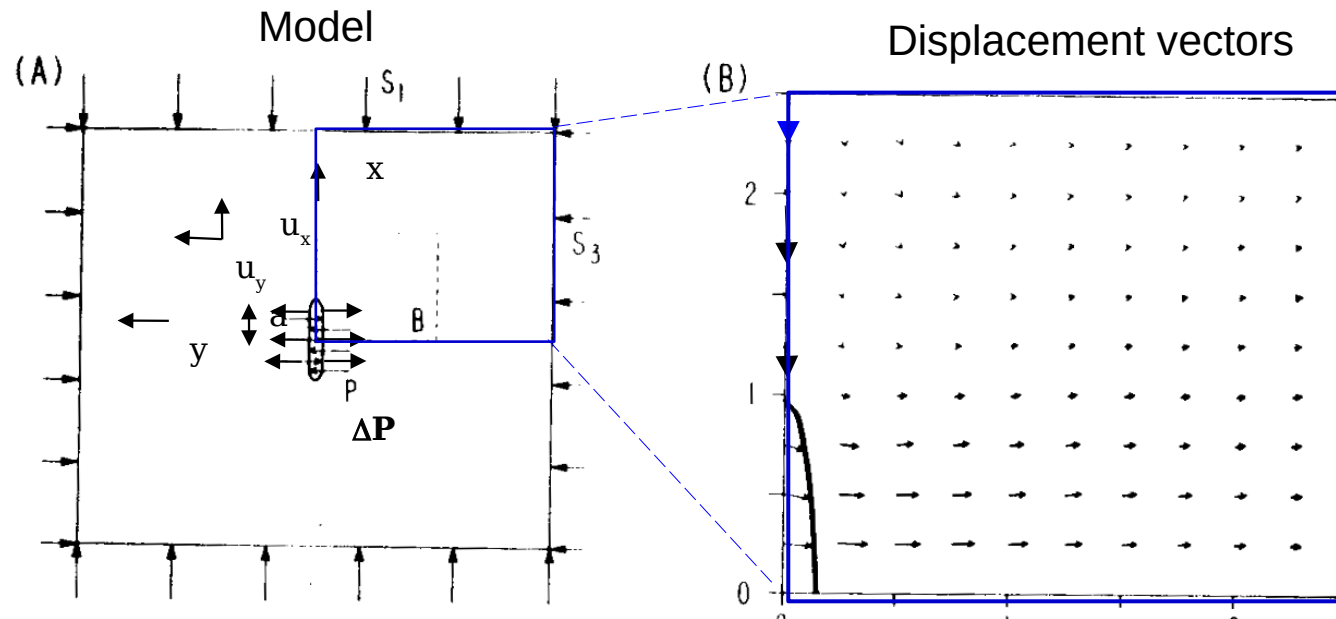

Displacement of each fracture surface

$$U_{x,y} = f(?)$$



# Most famous simple models

## 4. Pollard et al. model (1983) (analytic): pressurized fracture in an infinite medium

Displacement of the elastic medium around the crack under pressure

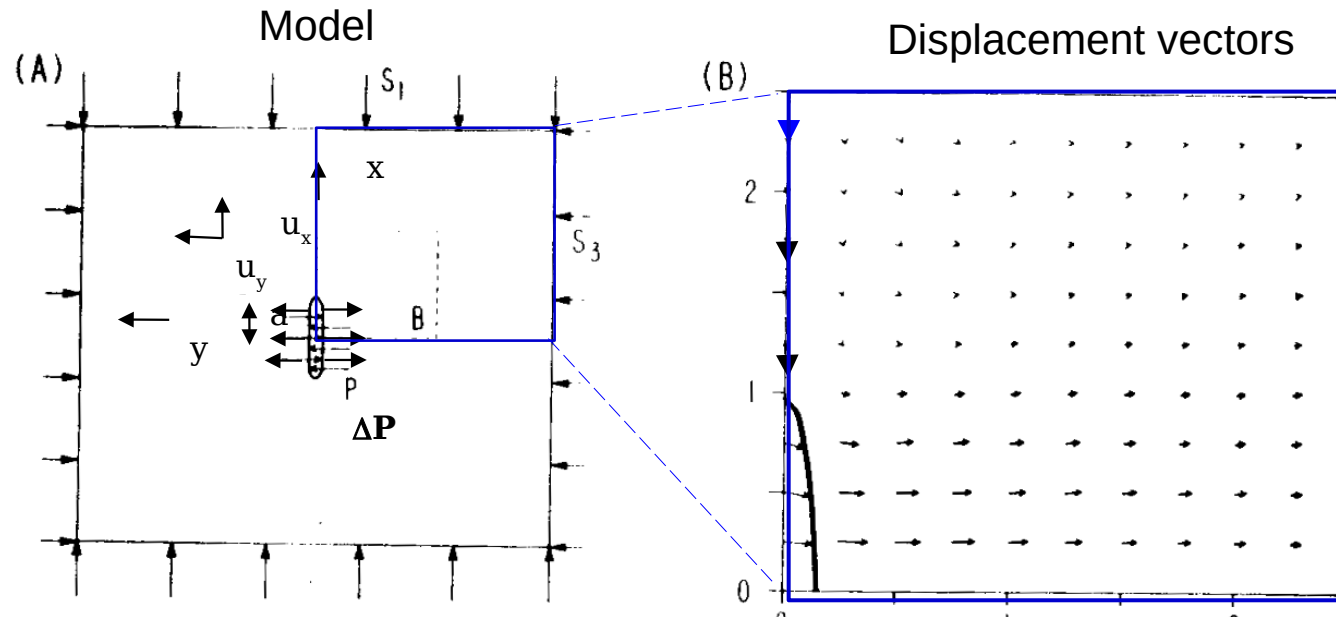

Displacement of each fracture surface :

$$u_x = -\frac{(1-2\nu)(1+\nu)}{2E} x \Delta P \quad u_y = \pm \frac{2(1-\nu^2)}{E} \Delta P a \left[1 - (x/a)^2\right]^{1/2}$$

where  $\nu$  et  $E$  are Poisson's ration and Young's modulus,  $a$  is the fracture half-length,  $P$  is the fluid pressure,  $S_1=S_3$  are stress in the host medium, and  $\Delta P = P - S_3$  is the overpressure.

# These simple models provide a poor fit of InSAR data

Reality

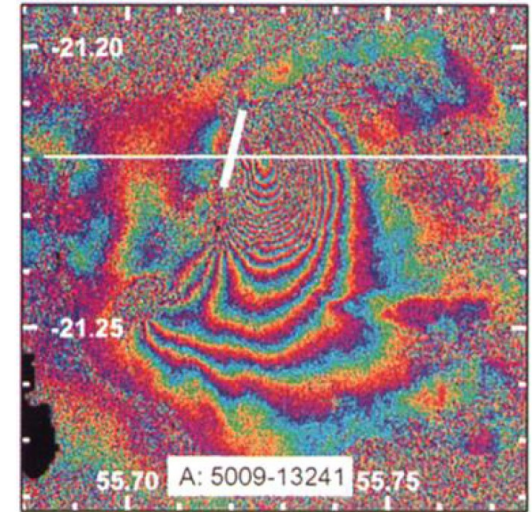
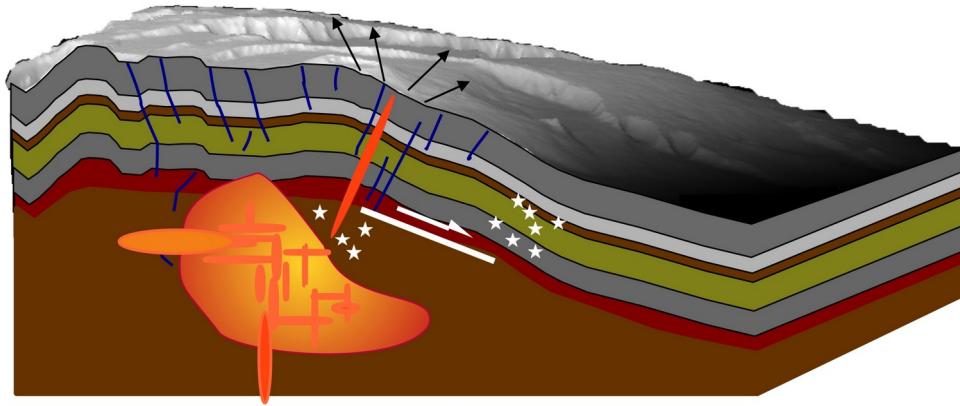

## Analytic Models

Models

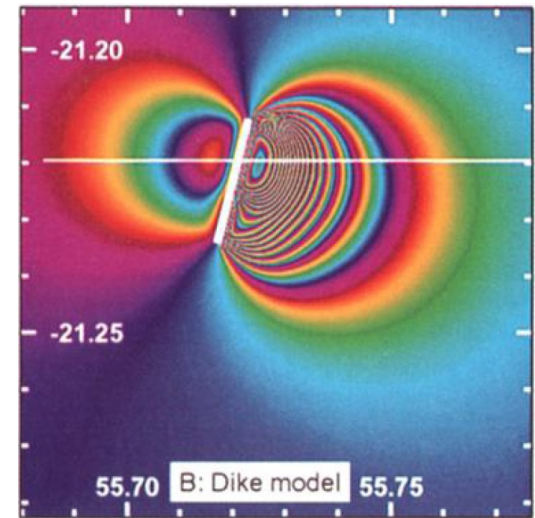
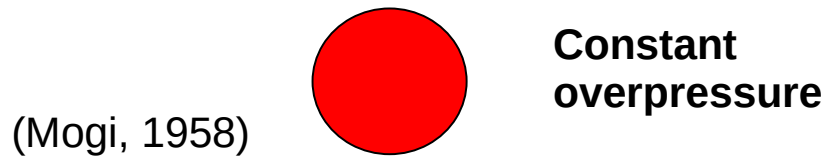
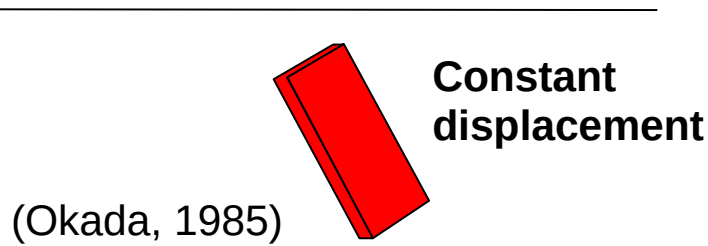

(Sigmundsson et al., GRL, 1999)

# Numerical models: Example of 3D Mixed Boundary Elements

Cayol et Cornet, Int. J. Rock Mech. Min. Sc., 1997;  
Cayol and Cornet, JGR, 1998; Cayol et al., JGR 2014

## 3D Numerical method:

- **Realistic topographies;**
- **Any number and geometry of fractures and pressure sources;**
- **Treats more than one source appropriately (interactions are taken into account);**

## Assumptions:

- intrusions, faults, reservoirs are submitted to **constant stress** changes;
- Fractures may be **curved**.

Example of sources

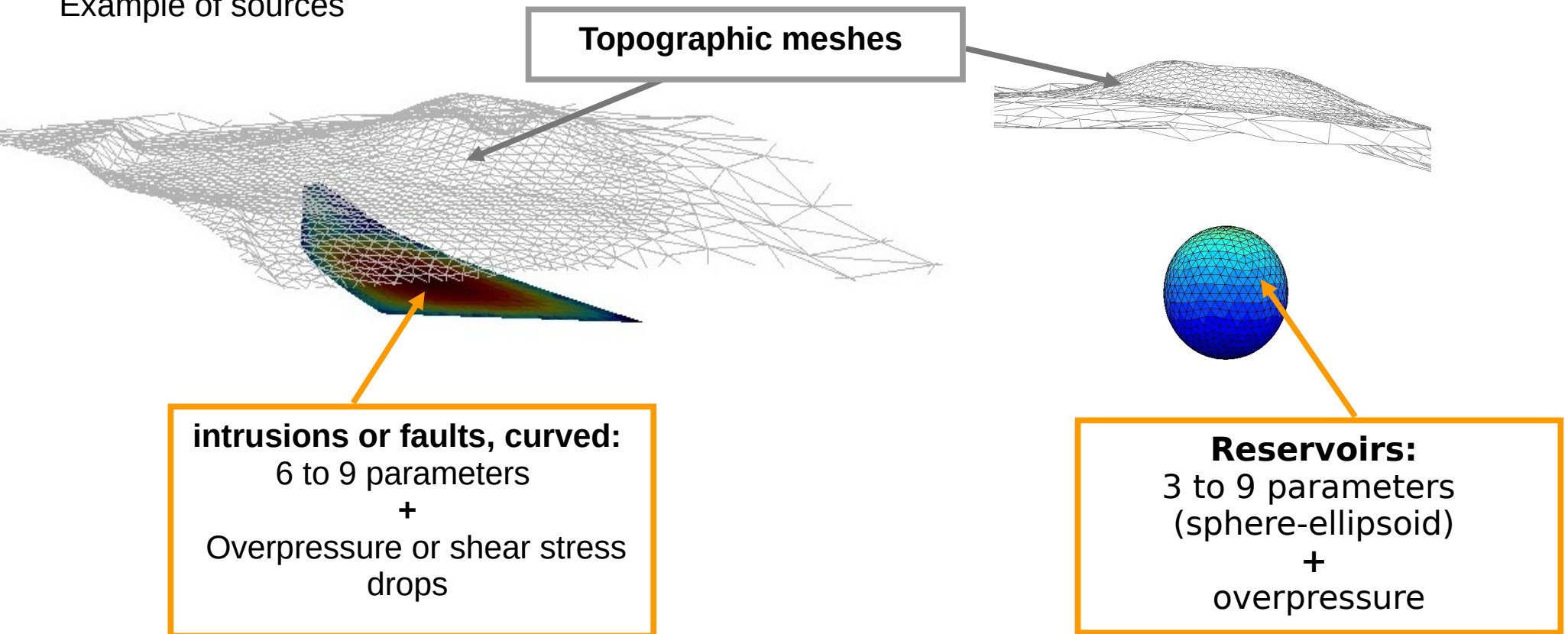

# Topography is taken into account

Topographies have an influence of computed displacements

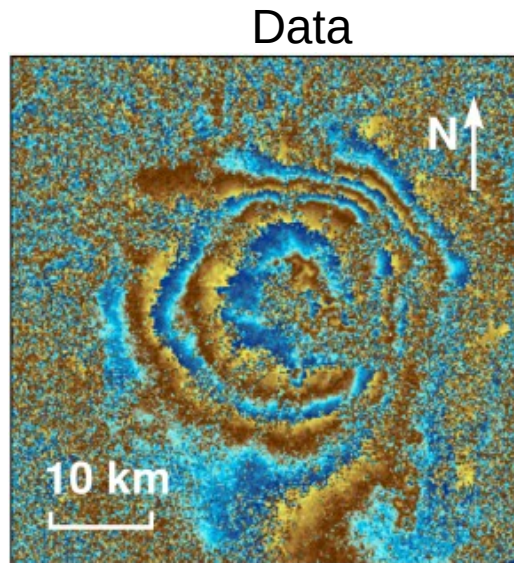

Etna, 1992-1993 eruption,  
*Massonnet et al., Nature, 1995*

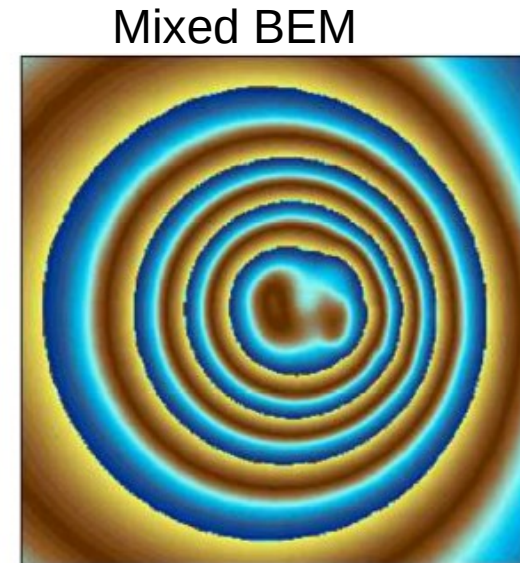
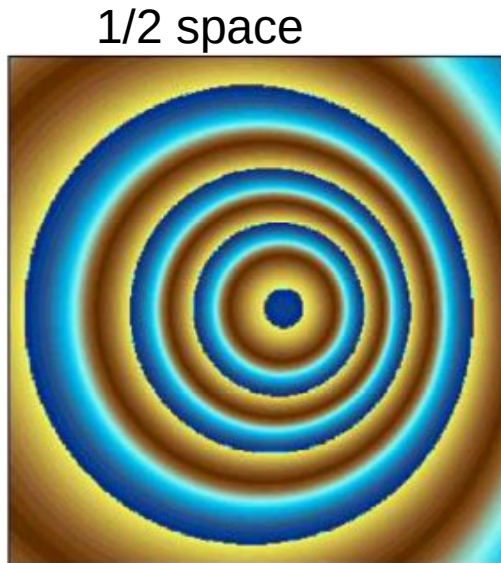

*Cayol and Cornet, GRL, 1998*

Neglecting topographies bias results : volume errors, depths errors

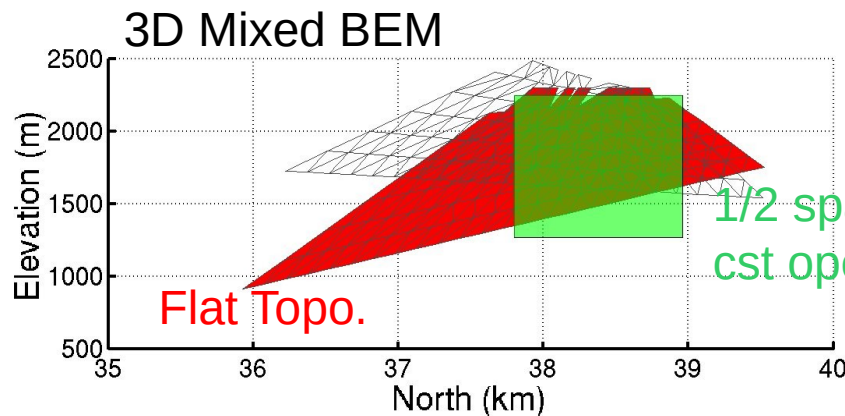

Volume with Okada (1985) : 80 % overestimation

Max depth with Okada : 40 % overestimation

*Fukushima et al., JGR, 2005*

# Source interactions are taken into account

When superposing analytic models, sources interactions are neglected

**But:** Sources interact when they are close

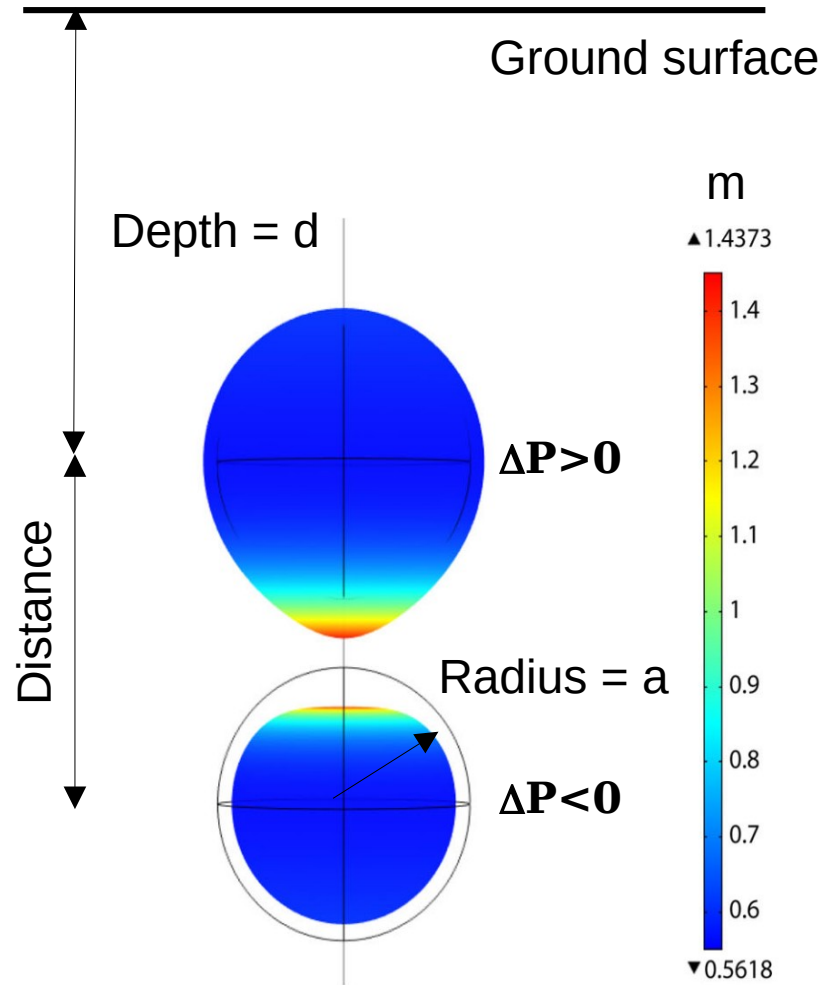

(b) Model A ( $\Delta P1 = -\Delta P2 = 20$  MPa)

Finite element computation

*Pascal et al., GJI, 2014*

Error when neglecting interactions

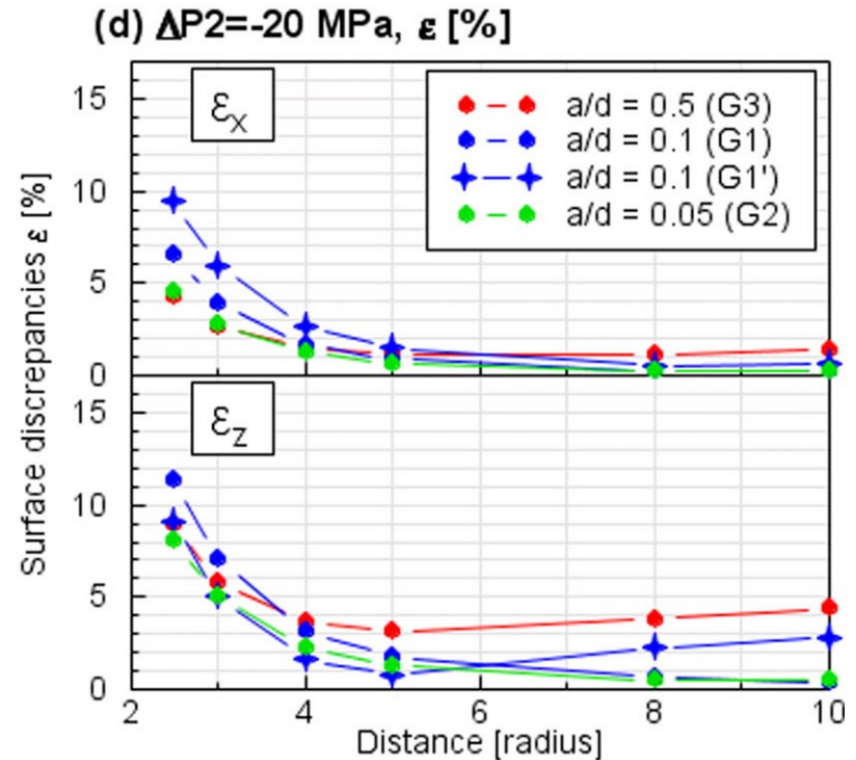

$$\text{with } \epsilon_i = \frac{\sum |U_i^{An} - U_i^{FE}|}{|U_i^{An}|}$$



**When sources are closer than 4\*radius, they should be taken into account**

# Models with stress boundary conditions are closer to the physics

## Field observation



## Models

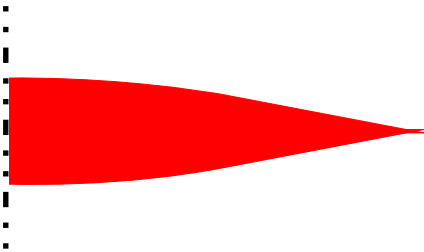

Pressure boundary condition

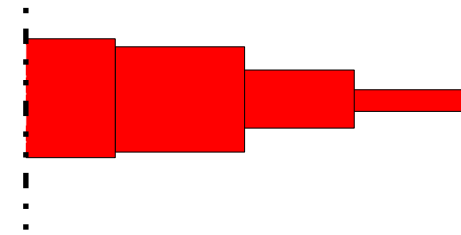

Displacement boundary condition : kinematic models

Less stress singularities

## Fracture stress

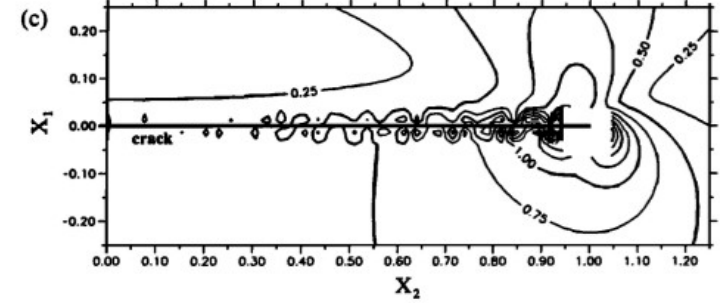
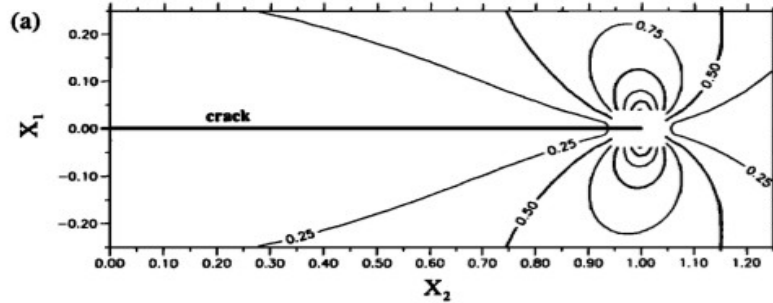

## Fracture shear displacement

Shear displacements are determined

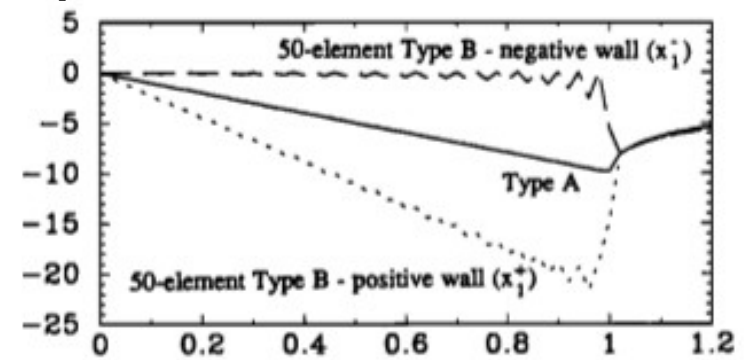
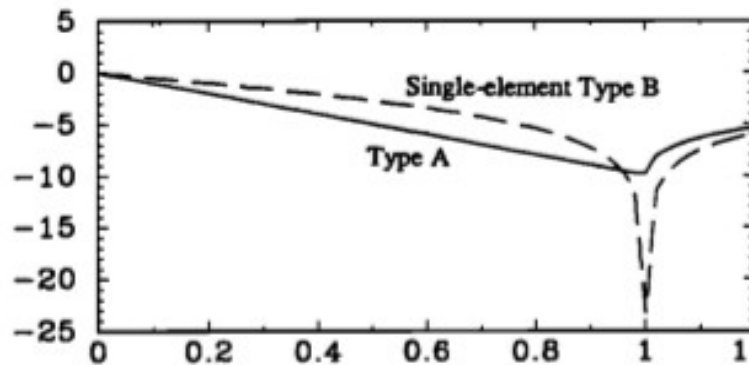

Zeller and Pollard, JGR, 1992

# Medium heterogeneities are also important in inversions

## Exemple of slow slip events at Kilauea (Hawaii)

Inversion of GNSS data

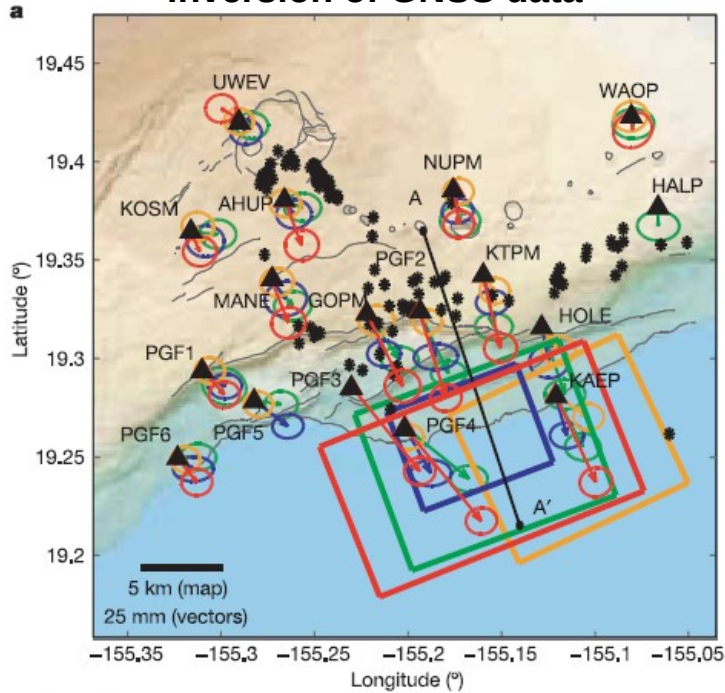

PPD

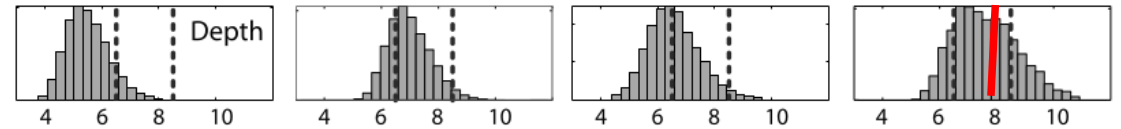

Model

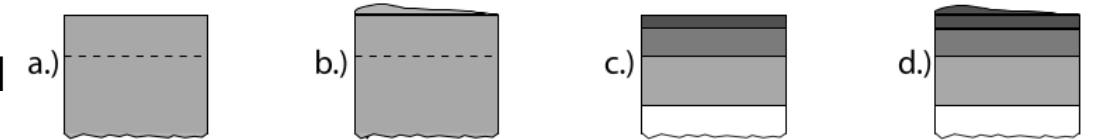

1/2 space Homogeneous      topography homogeneous      1/2 space heterogeneous      topography heterogeneous

(modified from Montgomery-Brown et al., JGR, 2009)

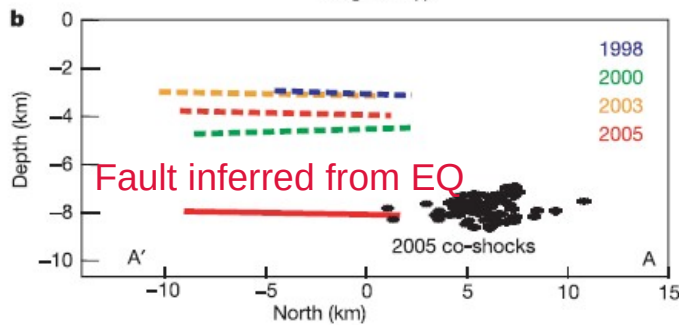

(Segall et al., Nature, 2006)

Only models that take into account topography and and heterogeneities reconcile displacement inversions and seismicity

➡ To take heterogenieties into account, finite elements are more suitable Than boundary elements

# Boundary Element Method versus Finite Element Method

## Boundary elements

(*DefVolc*, Cayol and Cornet, *IJRMMS*, 1997;  
Meade, *Comput. & Geosc.*, 2007  
Nikkhoo and Walter, *GJI*, 2015)

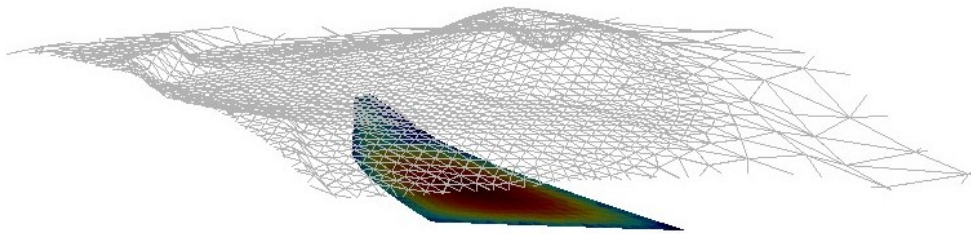

Smittarello et al., *JGR*, 2019

## Finite elements

(*Pylith*, Aagard et al., *JGR*, 2013;  
*GALES*, Garg. et al., 2021)

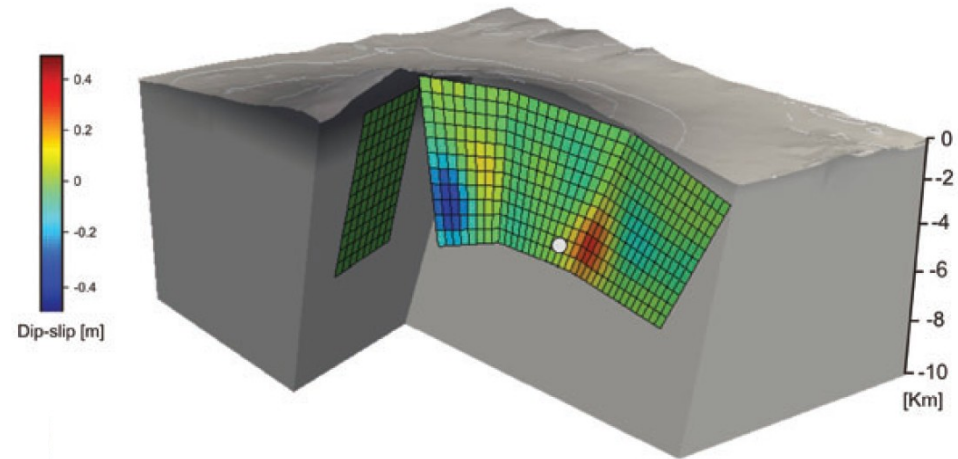

Currenti et al., *GJI*, 2010

## Pros and Cons

- Assembly & Solving on the boundaries
- **Homogeneous media**
- Small symmetric matrices ( $<10^4 \times 10^4$ )
- **Full matrices**
- Taking fractures into account is straightforward

- Assembly & solving in the whole domain
- Heterogeneous media
- **Large matrices ( $>10^6 \times 10^6$ )**
- Sparse & symmetric matrices
- **Taking fracture into account is not straightforward (Domain decomposition, etc.)**



# 3. Inversions

Direct problem :  $m \rightarrow u = G(m)$ ,  $m = \text{parameters}$   
(*unique*)  $u = \text{observations}$

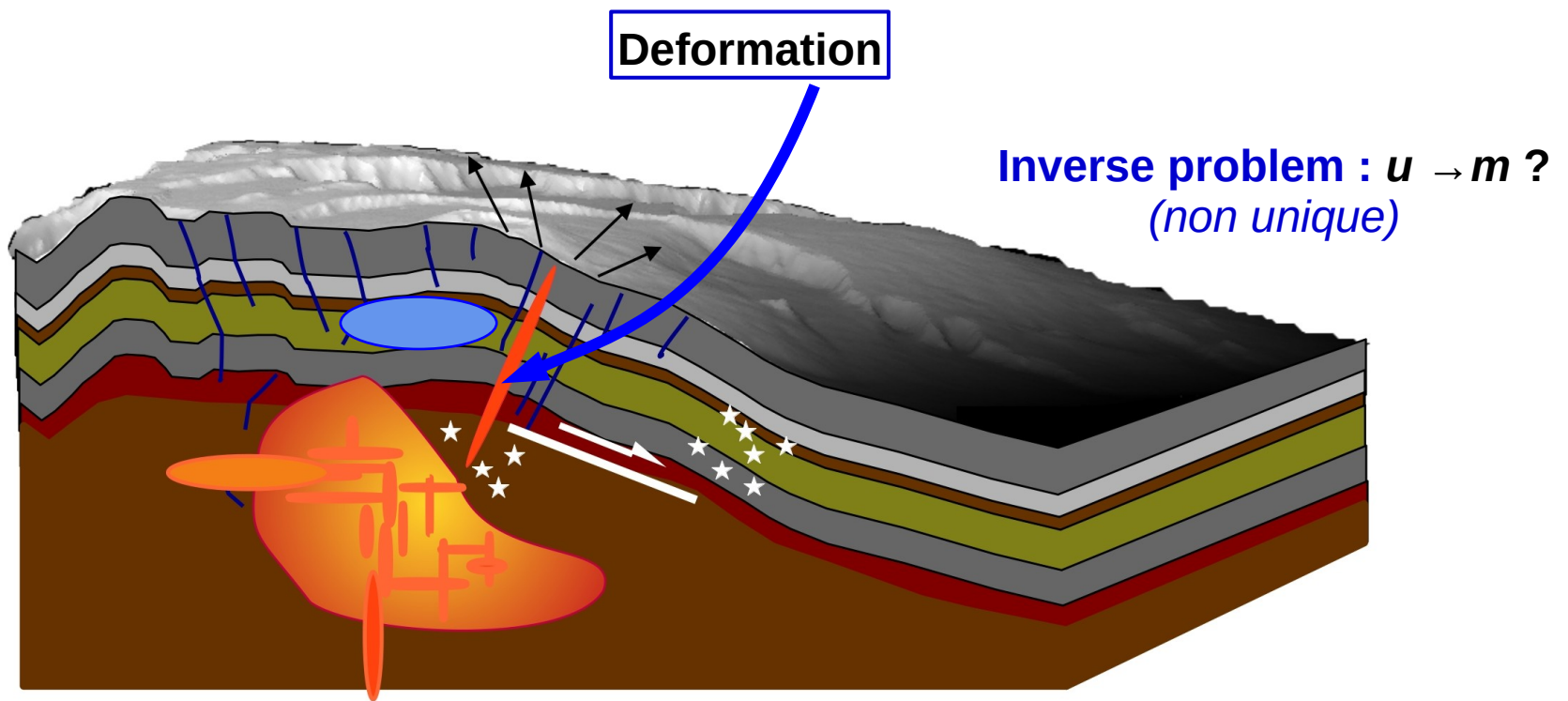

## Which a priori model ?

**When inverting displacements, which of the above model should be used ?  
We need to start with an a-priori model.**

To do this, we use :

1. **The context**: has there been an eruption, or have eruptive cracks been observed in the field?
2. **The observed displacement field**: are there any **discontinuities** in the displacement field ? is there any **axisymmetry**?

# Which a priori model ?

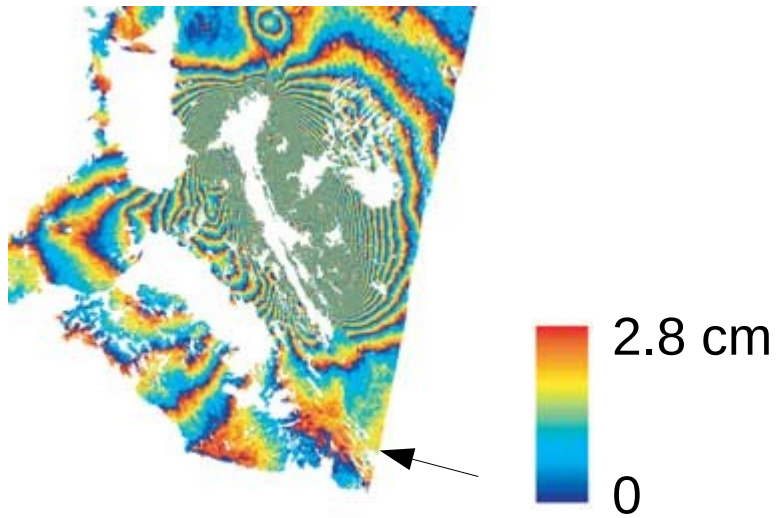

Dike ?  
Reservoir ?

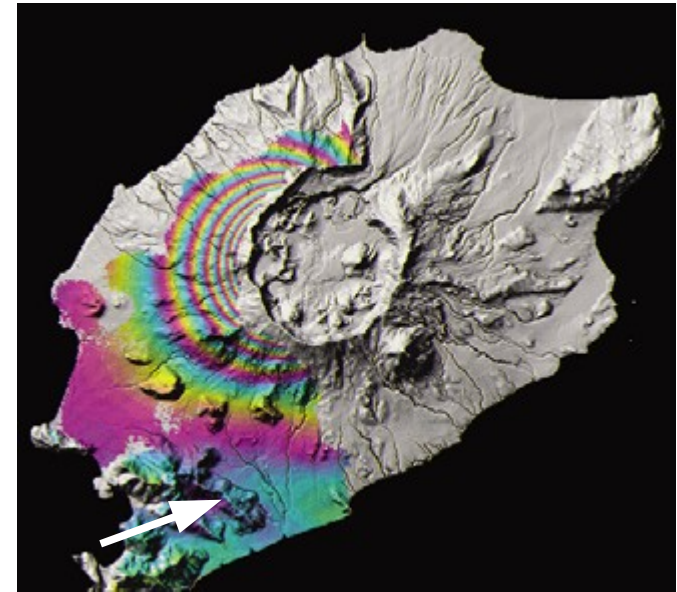

Dike ?  
Reservoir ?

## Which a priori model ?

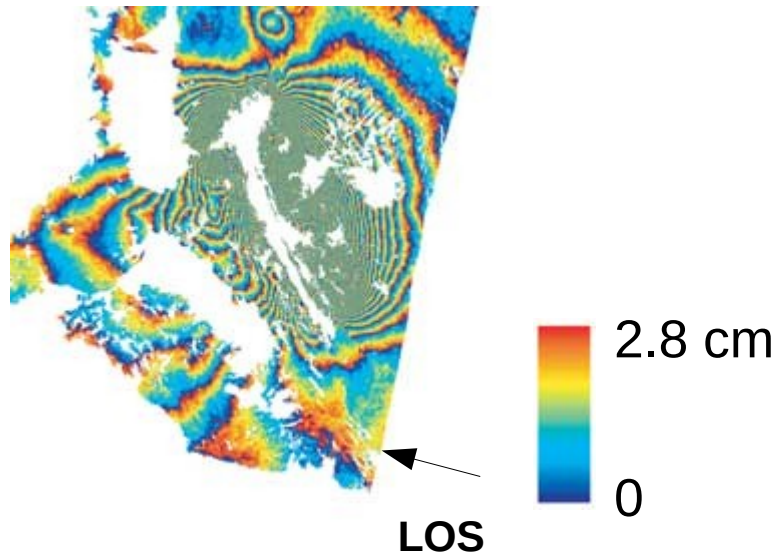

Opening of the Dabbahu rift in 2005  
(*Wright et al., Nature, 2006*)

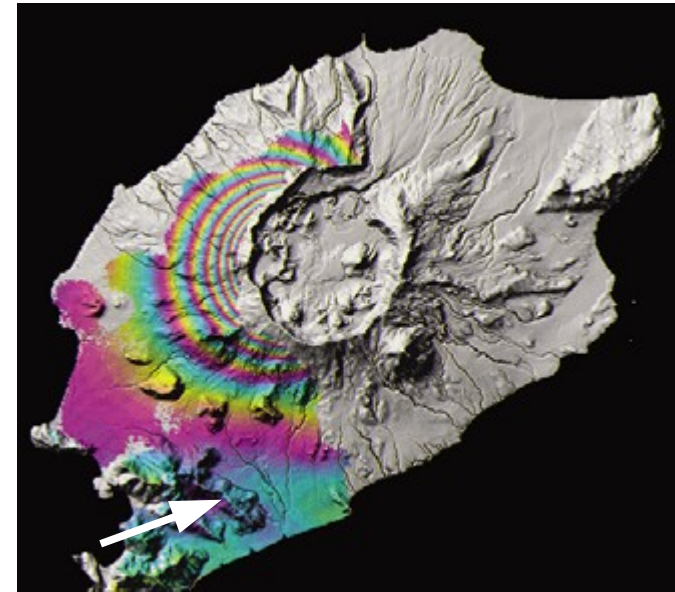

Reservoir deflation during the Okmok volcano eruption in 2008  
(*Lu and Dzurisin, JGR, 2010*)

## Analytic inversions of the Mogi model (Mogi; 1958) : Determination of D and $\Delta V$

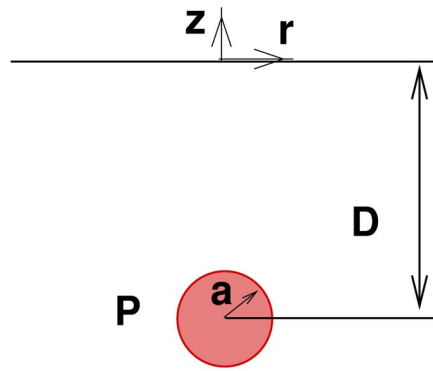

$$U_z(r) = -\frac{3\Delta V}{4\pi} \frac{D}{(D^2 + r^2)^{3/2}}$$

$$U_r(r) = \frac{3\Delta V}{4\pi} \frac{r}{(D^2 + r^2)^{3/2}}$$

$$\Delta V = \frac{\pi}{G} a^3 P$$

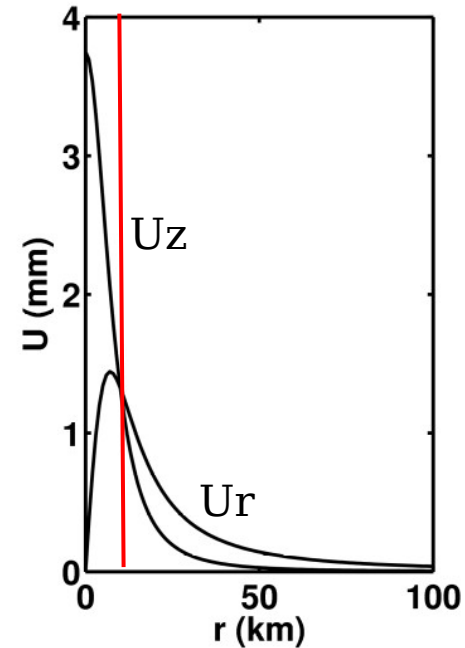

### Method using $U_r$ and $U_z$ :

- We determine the distance  $r$  such that  $U_z = U_r$ . This corresponds to  $r = D \rightarrow r = 10$  km
- Knowing the amplitude at  $r = 0$   $U_z(r=0) = U_{max}$ , we find  $\Delta V = \frac{4\pi}{3} D^2 U_{max}$

# Numerical inversions: Definition of a cost-function

- The simplest cost-function :

$$\chi^2 = \sum_{i=1}^N (u_o^i - u_m^i)^2 = \|\mathbf{u}_o - \mathbf{u}_m\|^2$$

where  $u_o^i$  is the  $i^{\text{th}}$  observed displacement  
 $u_m^i$  is the  $i^{\text{th}}$  modelled displacements

- Normalized cost function:

$$\chi^2 = \sum_{i=1}^N \frac{(u_o^i - u_m^i)^2}{\sigma_i^2}$$

$\sigma_i$  Standard deviation or error  
on the  $i^{\text{th}}$  data

- Taking the data correlation into account:

$$\chi^2 = (\mathbf{u}_o - \mathbf{u}_m)^T \mathbf{C}_d^{-1} (\mathbf{u}_o - \mathbf{u}_m)$$

where  $\mathbf{C}_d$  is a full covariance matrix

Data point undersampling  $\rightarrow \mathbf{u}_o$

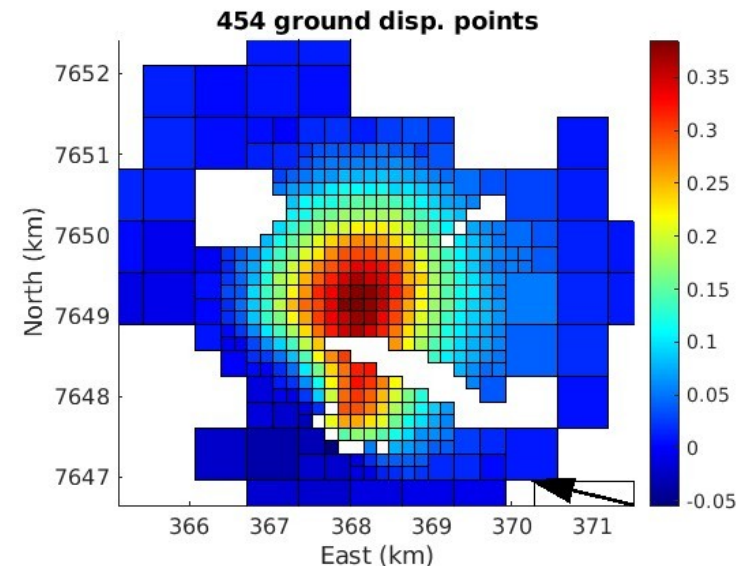
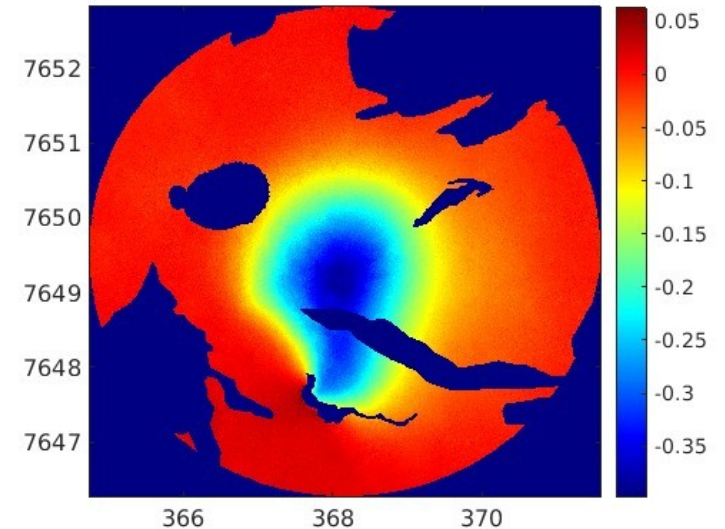

# Inversions: **linear** versus non-linear inversions

**Linear inversions:** there is a linear relation between the parameters  $\mathbf{m}$  and the observations,  $\mathbf{u}_m$

$$\mathbf{u}_m = \mathbf{G} \mathbf{m}$$

Example: Okada's Model (1985, 1992); Mogi's solution (1958) are linear models

Typically, the location of a source is known, and the amplitude of the source is searched for.

To minimize the cost function:  $\chi^2 = \|\mathbf{u}_o - \mathbf{u}_m\|^2 = \|\mathbf{u}_o - \mathbf{G} \mathbf{m}\|^2$

We seek  $\mathbf{m}$  such that :  $\frac{\partial \chi^2}{\partial \mathbf{m}} = 0$

Which leads to solving the linear system of equations:  $\mathbf{m} = (\mathbf{G}^T \mathbf{G})^{-1} \mathbf{G}^T \mathbf{u}_o$

**Pros:** fast method

**Cons:** the source location has to be known

# Example of a linear inversion: “kinematic” models

Uplift at Sierra Negra volcano in 1998-99 (Galapagos)

Minimization of  $\chi^2 = \|\mathbf{u}_o - \mathbf{G} \mathbf{m}\|^2 + \beta^2 \|\nabla \mathbf{m}\|^2$ , where  $\mathbf{m}$  is the opening vector

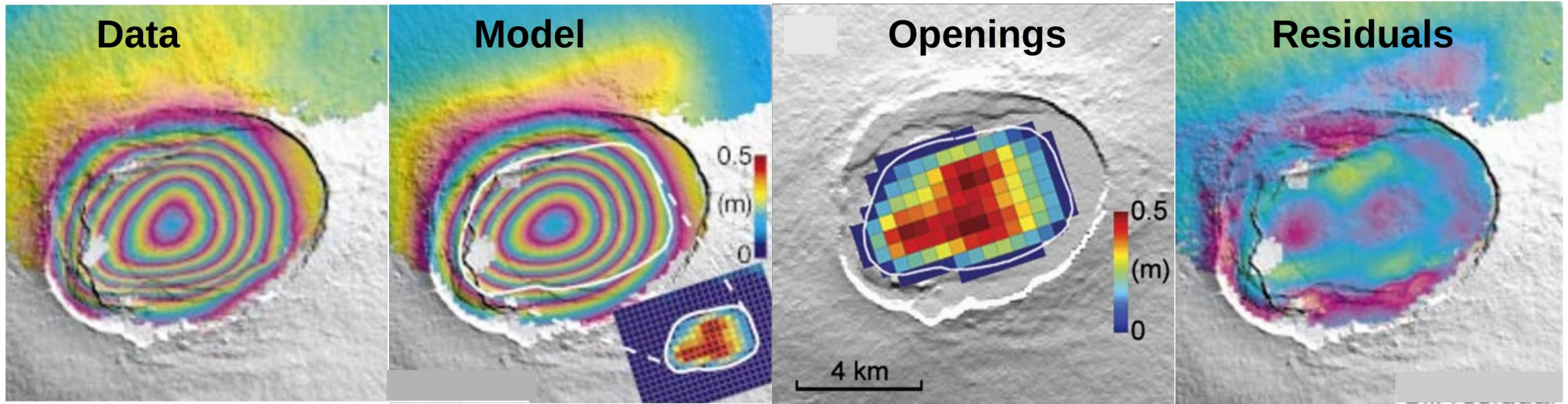

Amelung et al., Science, 2000

Science

Widely used



Cite as: Sigmundsson et al., Science  
10.1126/science.adn2838 (2024).

## Fracturing and tectonic stress drives ultramylonite flow into dikes

Freysteinn Sigmundsson<sup>1\*</sup>, Michelle Parks<sup>2</sup>, Halldór Geirsson<sup>1</sup>, Andrew Hooper<sup>3</sup>, Vincent Dru G. Ófeigsson<sup>2</sup>, Sonja H. M. Greiner<sup>1,4,5</sup>, Yilin Yang<sup>1</sup>, Chiara Lanzi<sup>1</sup>, Gregory P. De Pascale<sup>1</sup>, Krist Valentyn Tolpekin<sup>7</sup>, Hildur María Friðriksdóttir<sup>2</sup>, Páll Einarsson<sup>1</sup>, Sara Barsotti<sup>2</sup>

## JGR Solid Earth

RESEARCH ARTICLE  
10.1029/2019JB019117

- Key Points:
- Imaging multidisciplinary continuous deformation data to improve dike ascent modeling
  - Detailed temporal model of the 2018 intrusion at Etna volcano

## The 24 December 2018 Eruptive Intrusion at Etna Volcano as Revealed by Multidisciplinary Continuous Deformation Networks (CGPS, Borehole Strainmeters and Tiltmeters)

M. Aloisi<sup>1</sup>, A. Bonaccorso<sup>1</sup>, F. Cannavo<sup>1</sup>, G. Currenti<sup>1</sup>, and S. Gambino<sup>1</sup>





# Inversions: linear versus non-linear inversions

**Non-linear inversions:** there is a non-linear relation between the parameters  $\mathbf{m}$  and the observations,  $\mathbf{u}_m$

$$\mathbf{u}_m = \mathbf{G}(\mathbf{m})$$

The link between the source location, orientation parameters and the ground displacement is a non linear relation.

Example of a cost-function  $\chi^2 = \|\mathbf{u}_o - \mathbf{u}_m\|^2 = \|\mathbf{u}_o - \mathbf{G}(\mathbf{m})\|^2$ ,

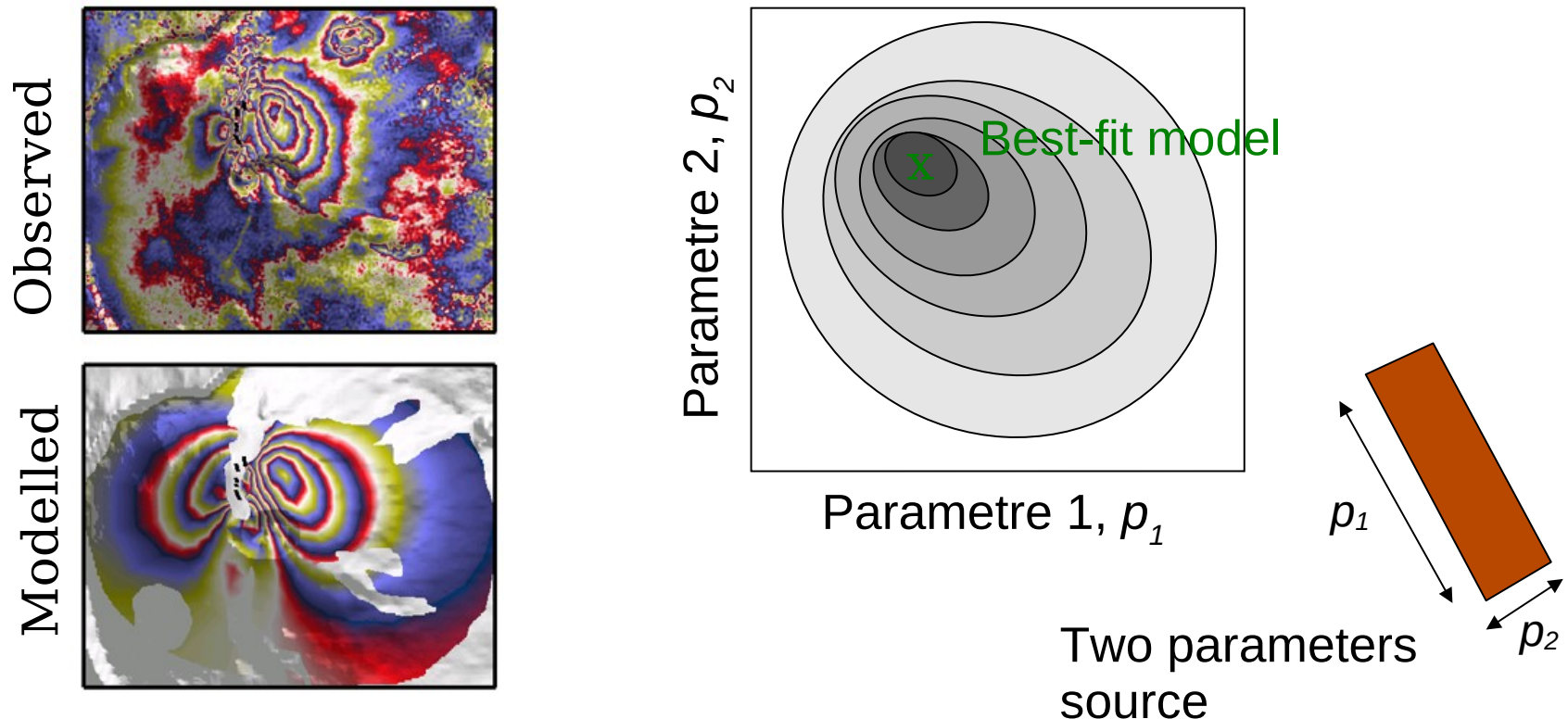

# Non linear inversions

$$\text{Example of a cost-function } \chi^2 = \|\mathbf{u}_o - \mathbf{u}_m\|^2 = \|\mathbf{u}_o - \mathbf{G}(\mathbf{m})\|^2,$$

Systematic exploration of the parameter space ([Grid search method](#))

Systematic exploration fixing one parameter after the other

Cost function

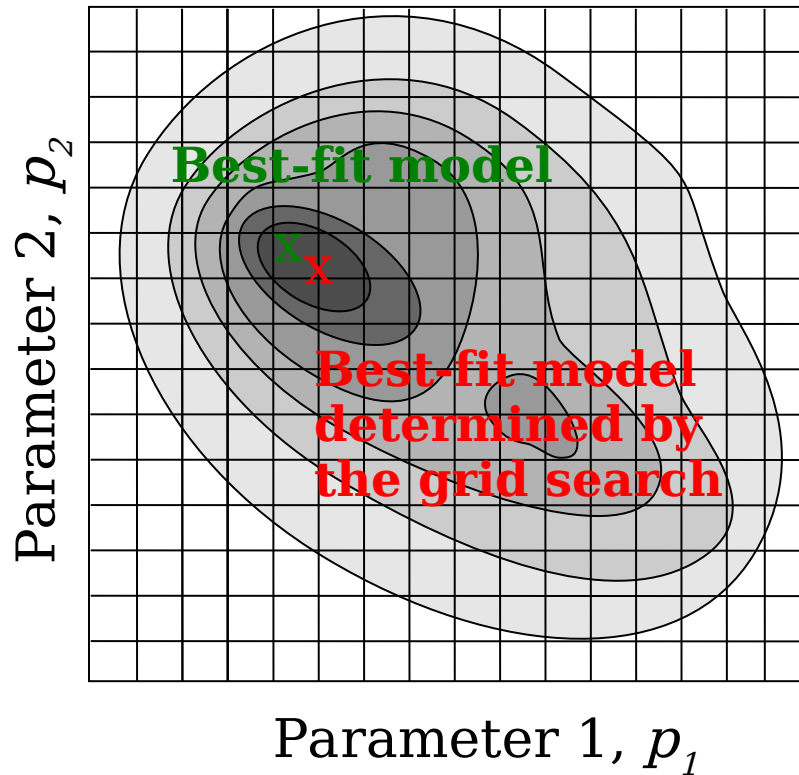

Cons : Numerically costly method

Cost function

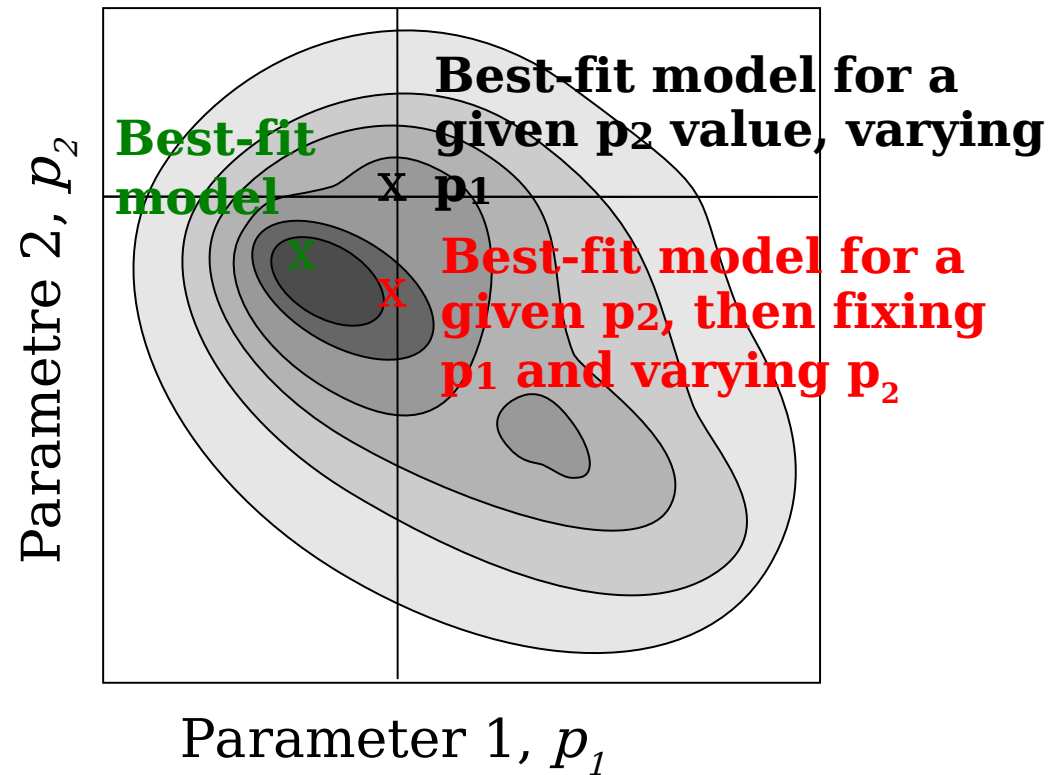

Unreliable method

# Non linear inversions

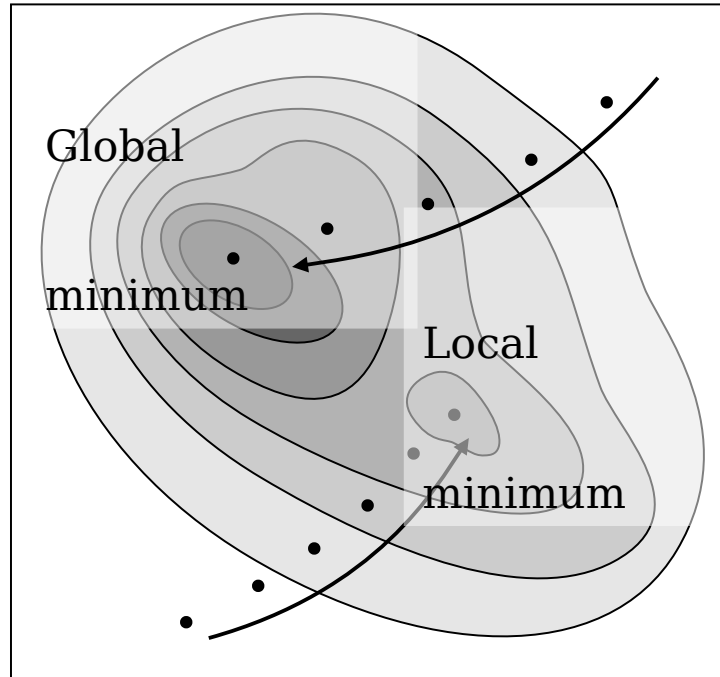

**Rapid method**

**Adapted for functions  
with one or two minima**

Monte Carlo method

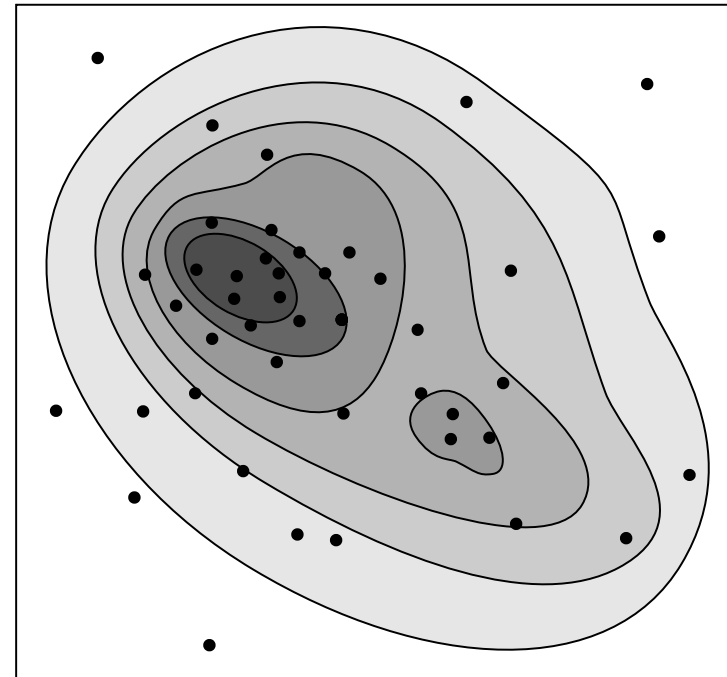

**Fairly slow method**

**Adapted for functions  
with multiple minima**

# Example of the neighborhood Method (Monte Carlo)

(Sambridge, GJI, 1999)

**Initial step: n initial point are drawn in the model space, their misfits are evaluated**

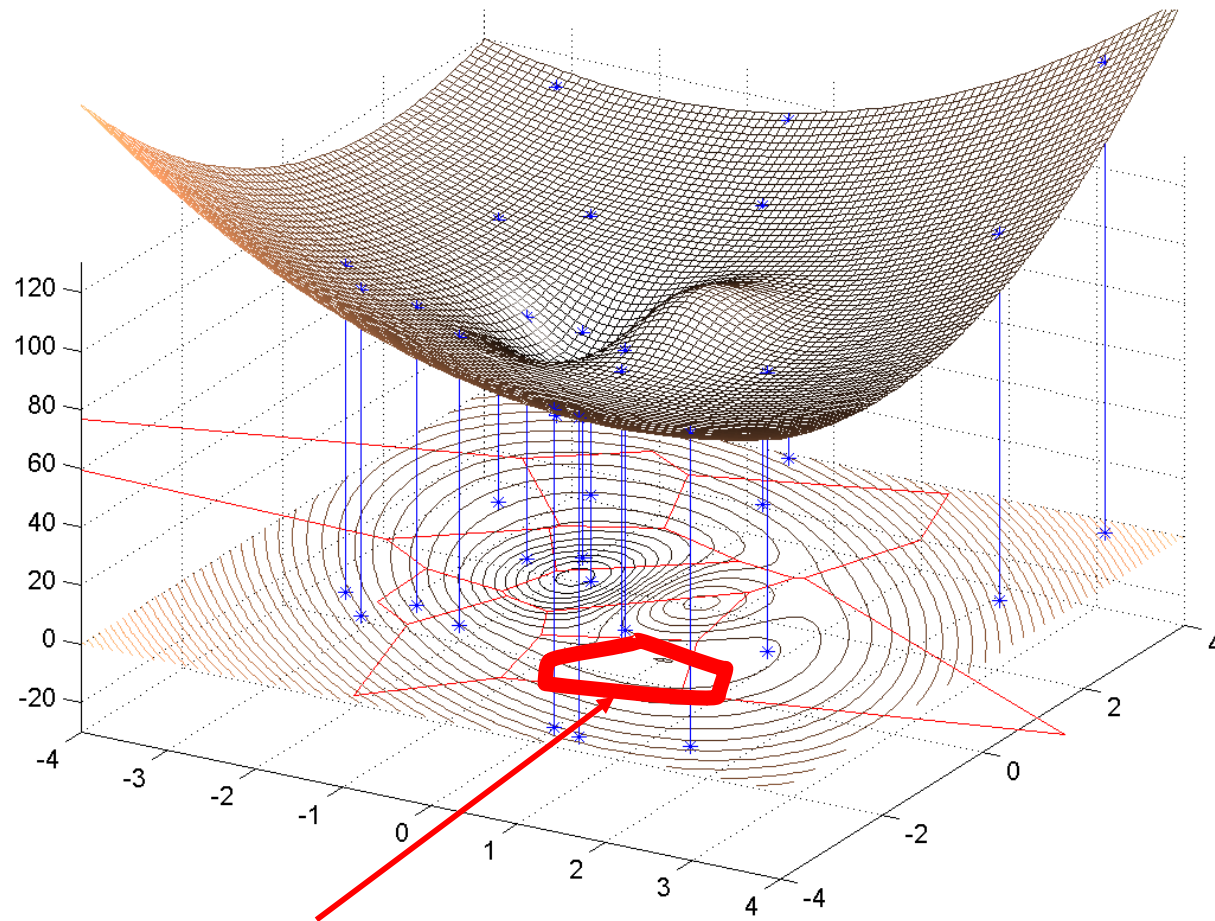

Misfit function in a two parameters space

Voronoi cell (= neighbourhood) : region closer to a point than any region.

# Example of the neighborhood Method (Monte Carlo)

*(Sambridge, GJI, 1999)*

**Initial step:  $n$  initial point are drawn in the model space, their misfits are evaluated**

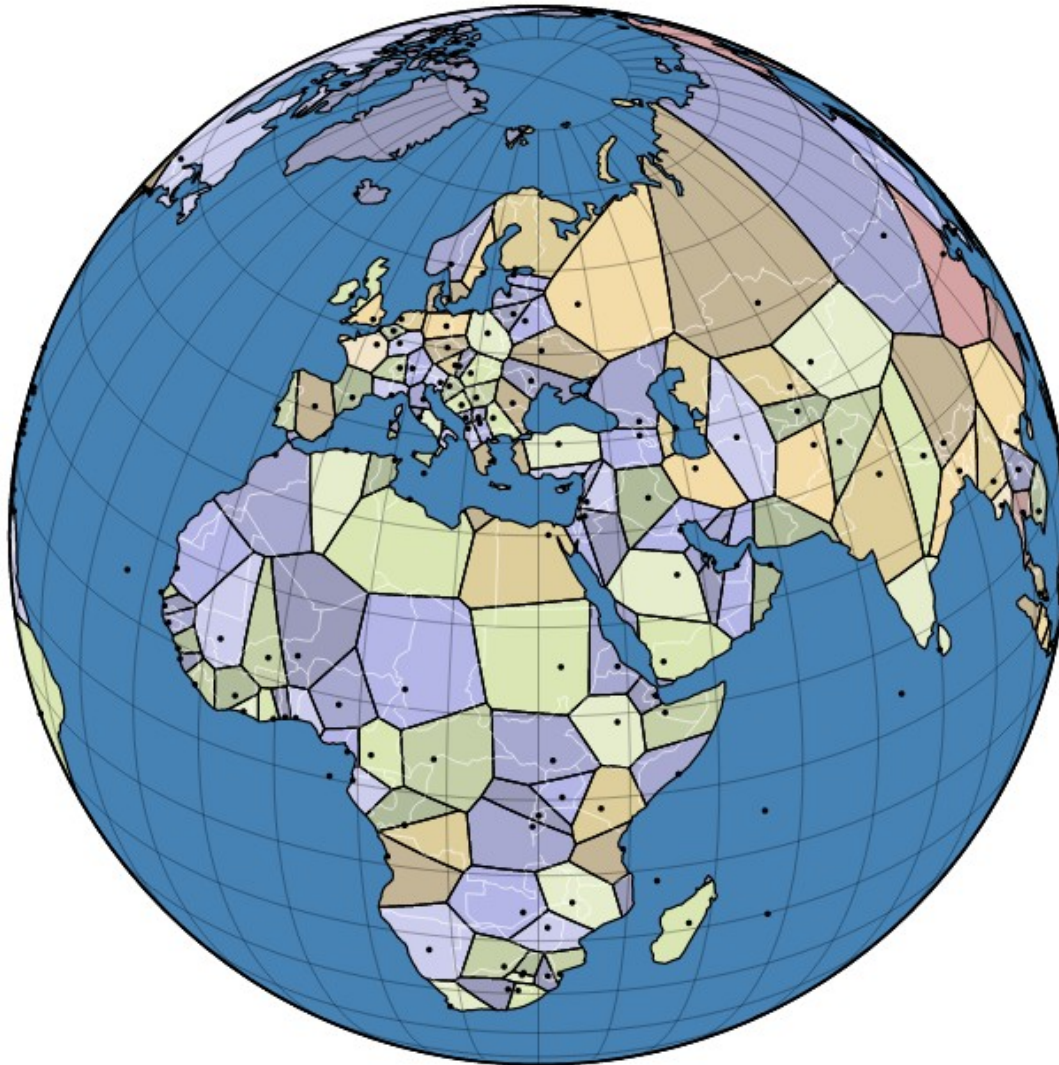

Voronoi cells around the world capitals

# Example of the neighborhood Method (Monte Carlo)

## Iterative search example: initial stage

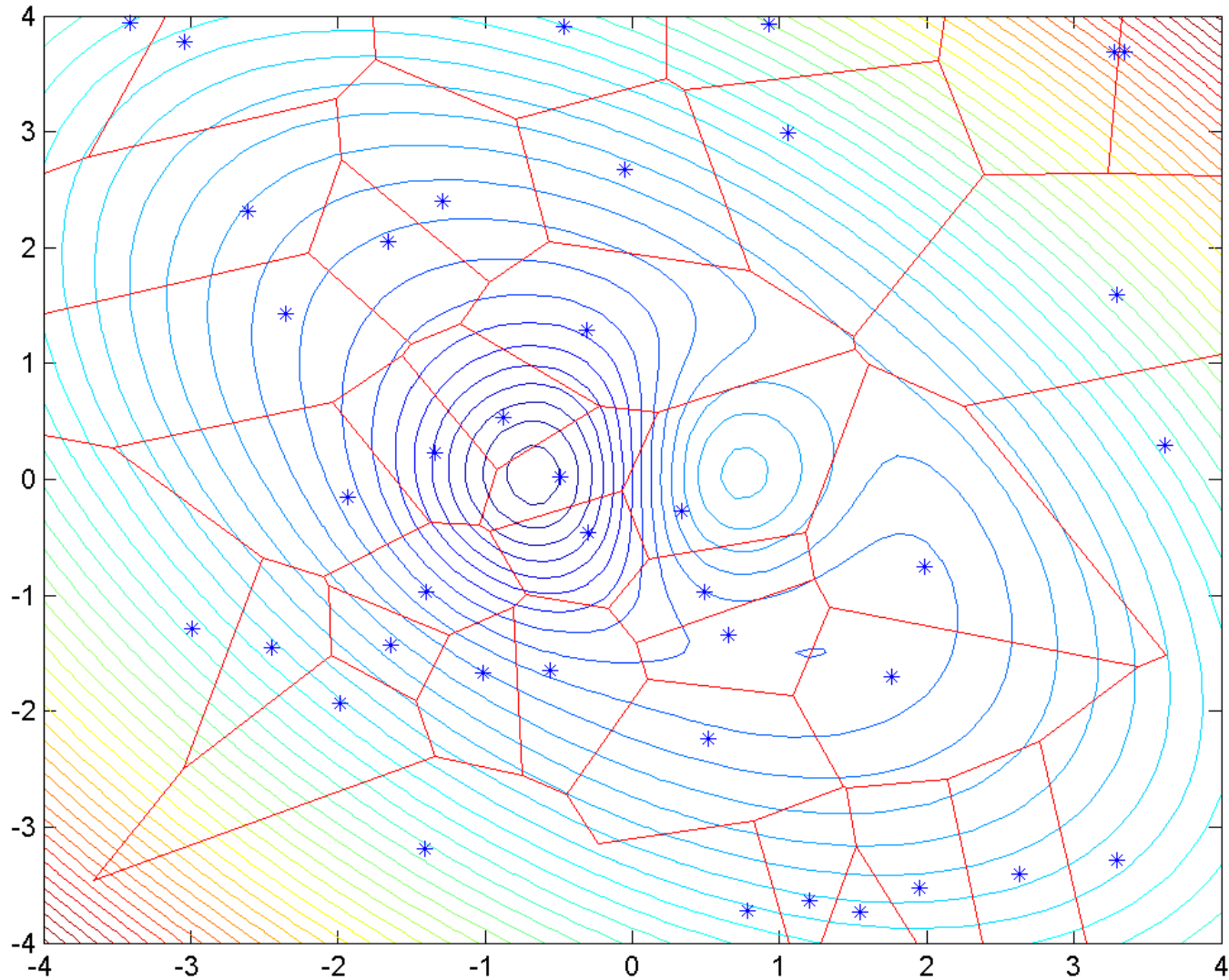

# Example of the neighborhood Method (Monte Carlo)

Iterative search example: 1<sup>st</sup> iteration

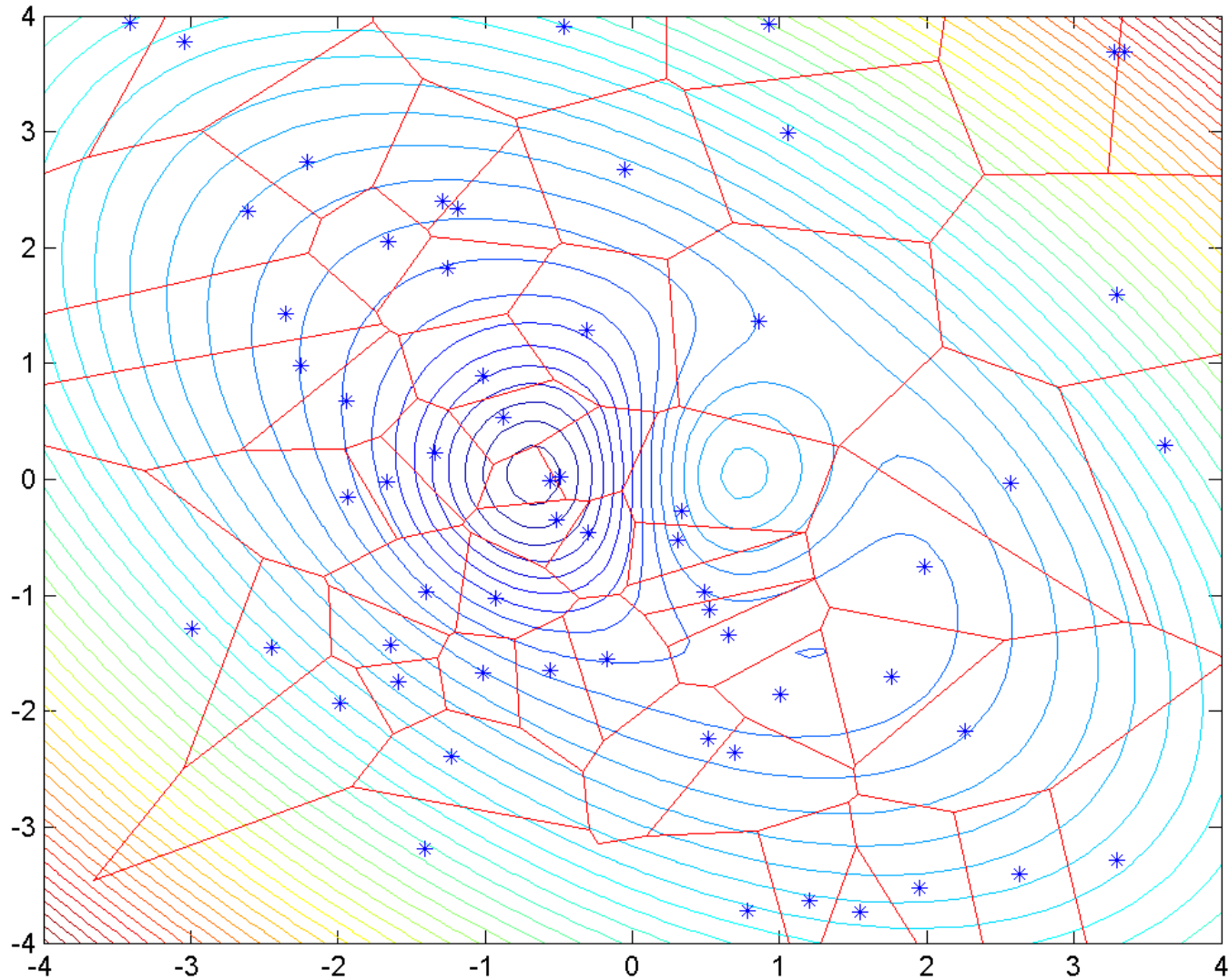

# Example of the neighborhood Method (Monte Carlo)

Iterative search example: 2<sup>nd</sup> iteration

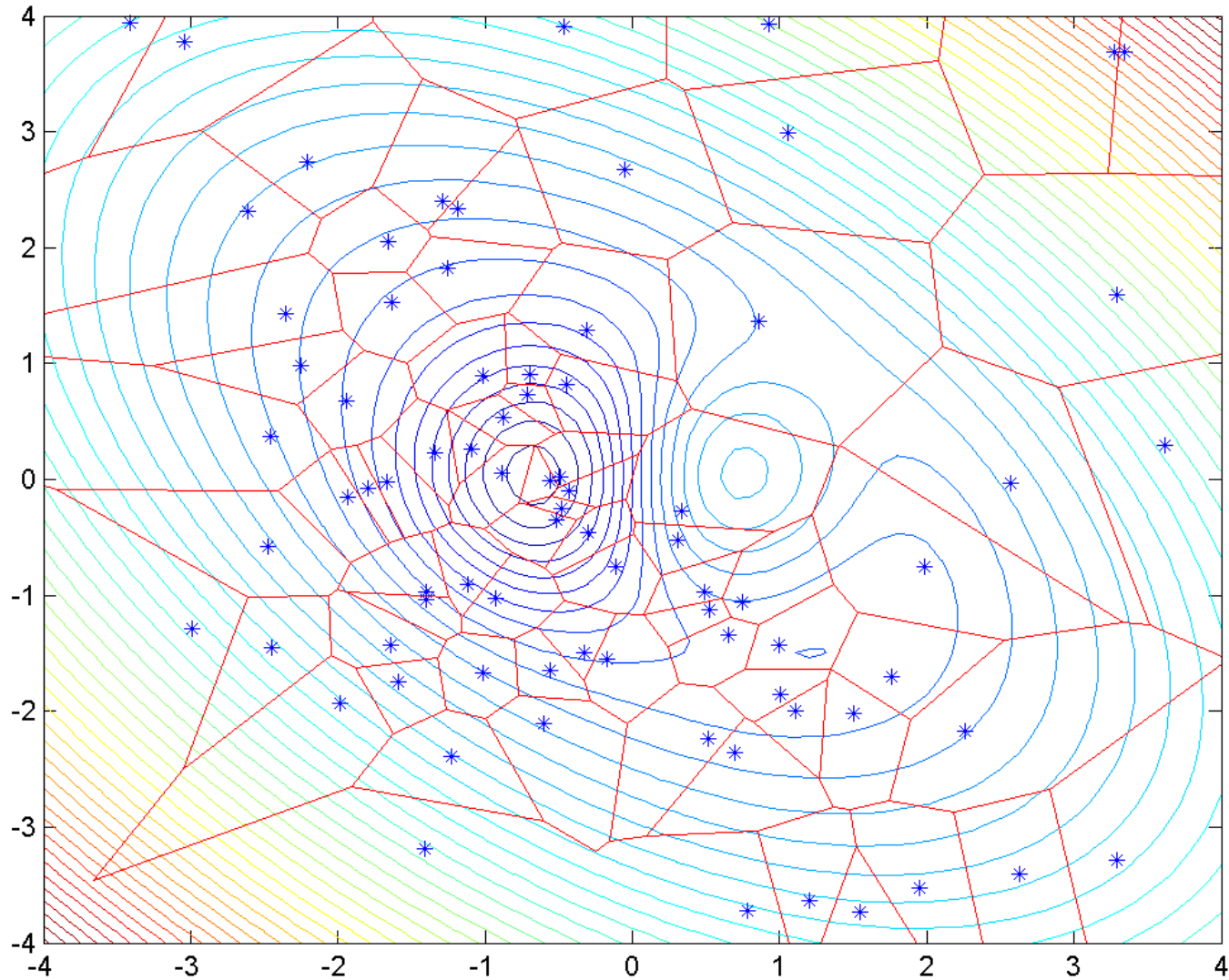



# Example of the neighborhood Method (Monte Carlo)

Iterative search example: 3<sup>rd</sup> iteration

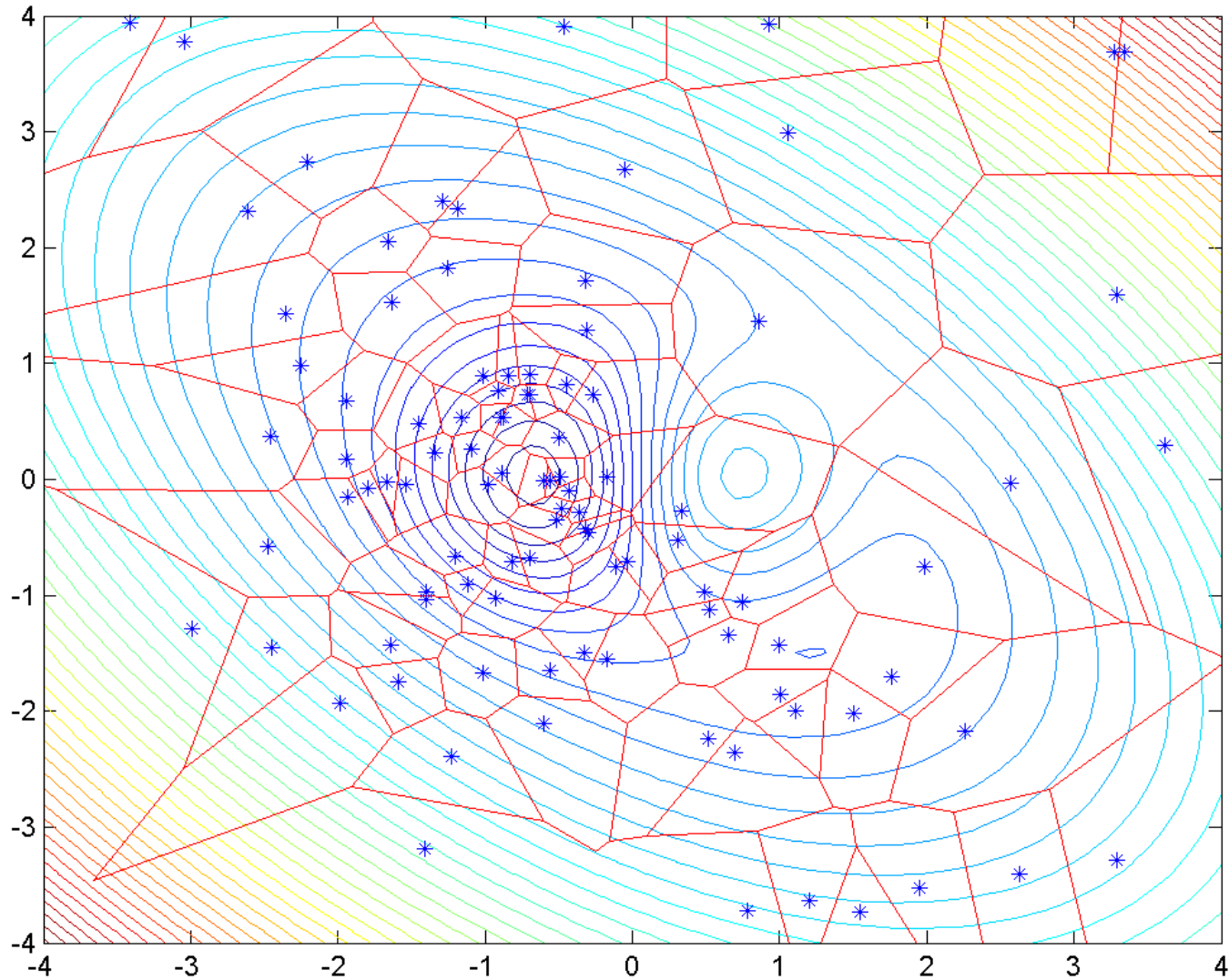

# Example of the neighborhood Method (Monte Carlo)

Iterative search example: 4<sup>th</sup> iteration

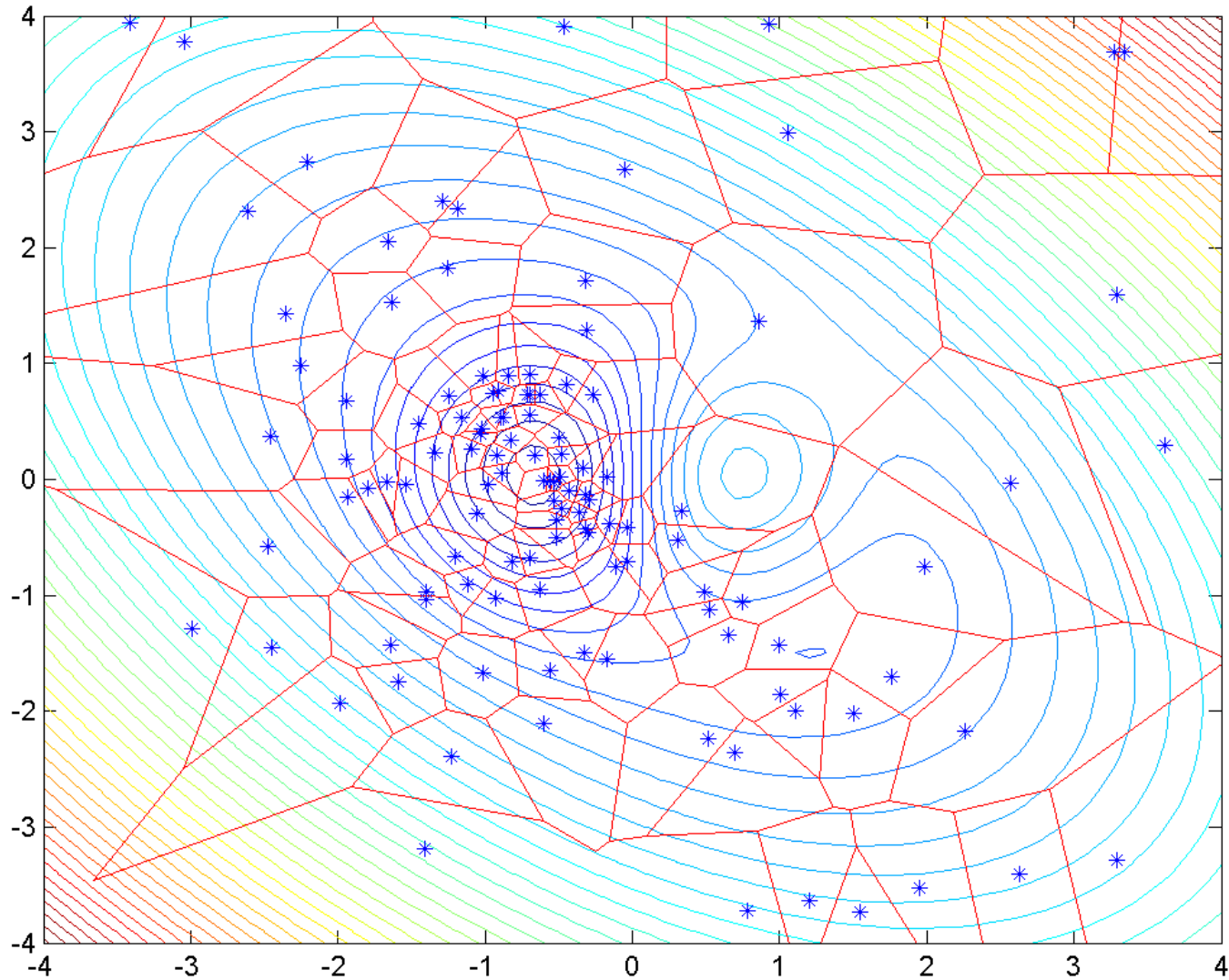

# Example of the neighborhood Method (Monte Carlo)

Iterative search example: 5<sup>th</sup> iteration

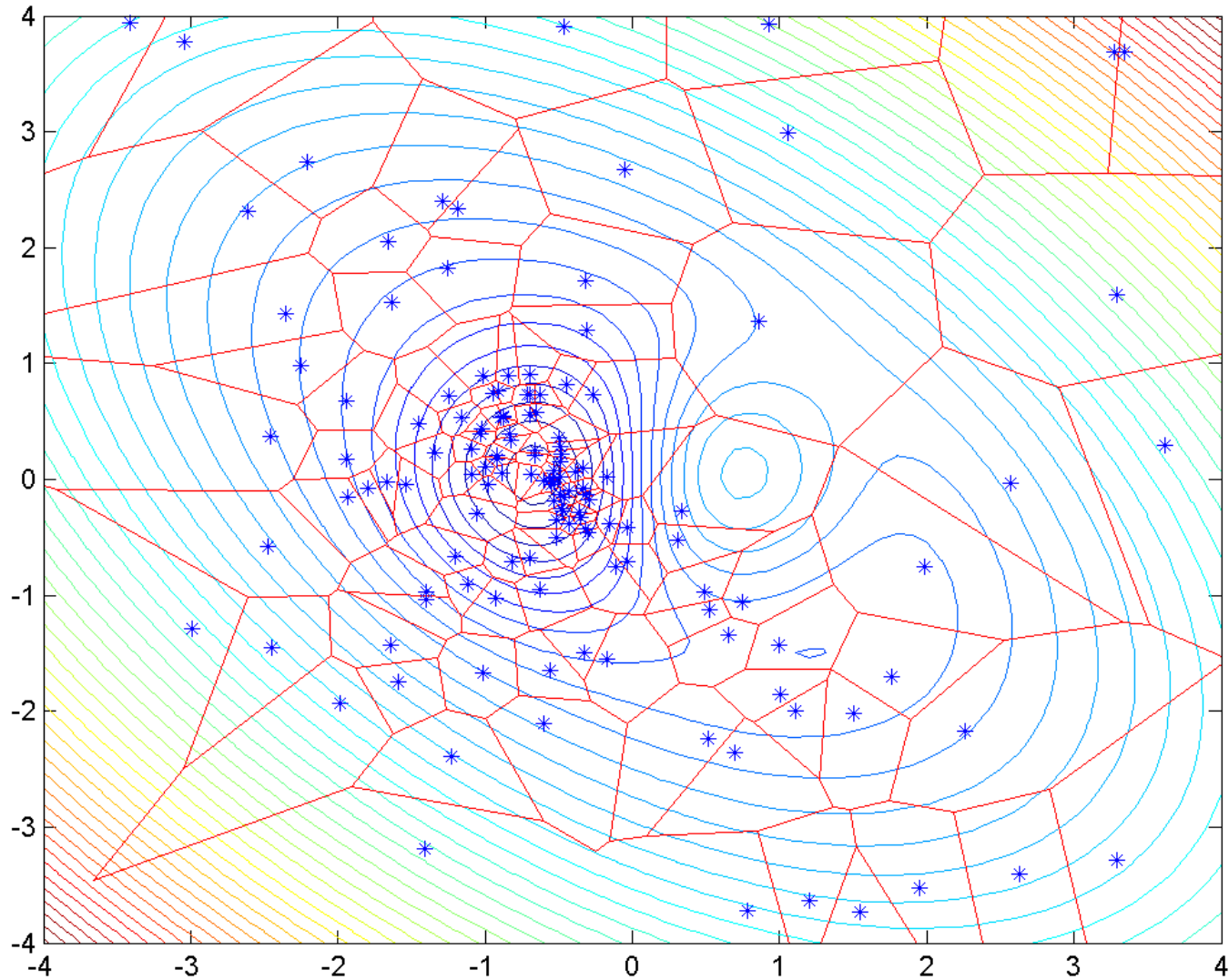

# Example of the neighborhood Method (Monte Carlo)

Iterative search example: 6<sup>th</sup> iteration

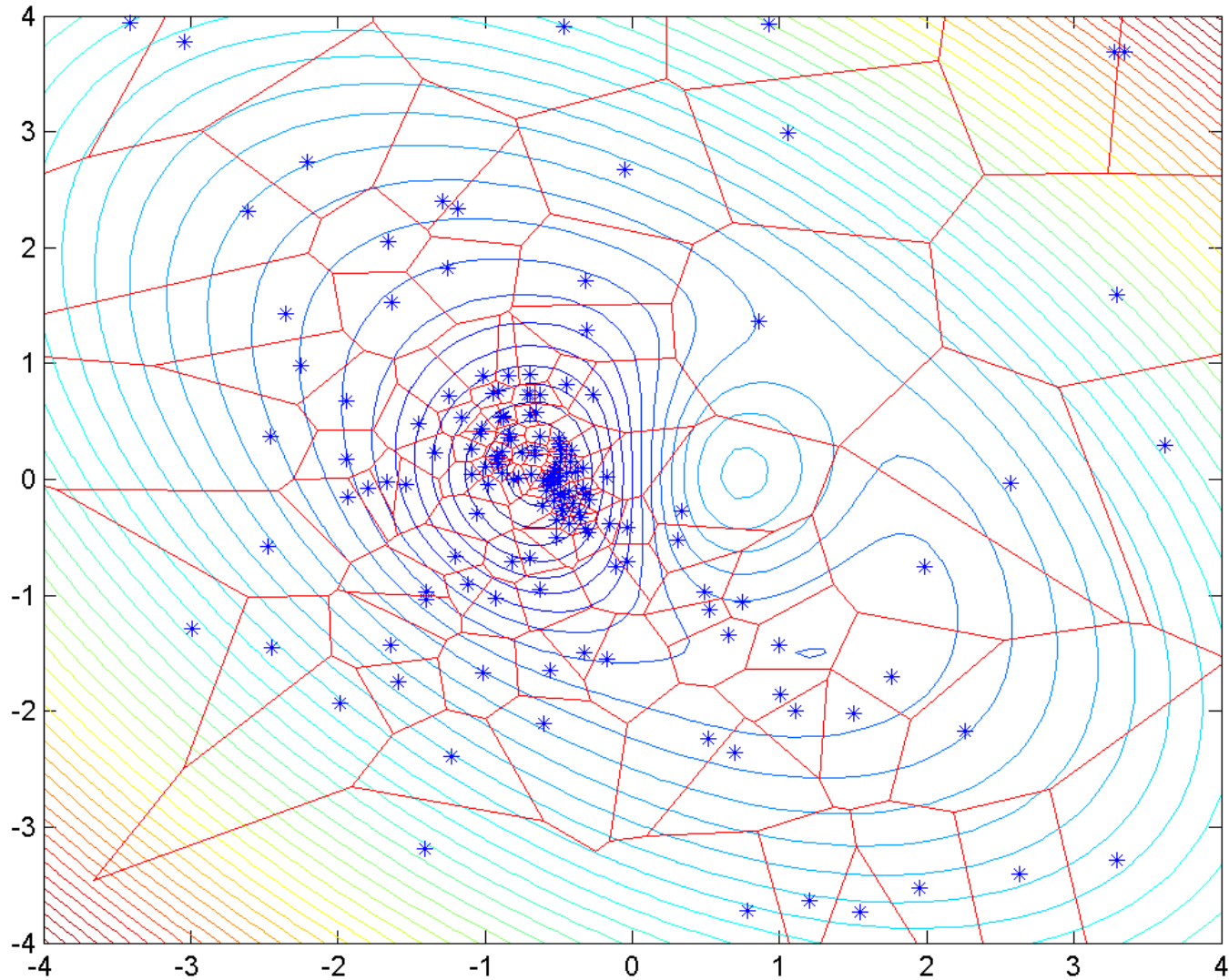

# Example of the neighborhood Method (Monte Carlo)

Iterative search example: 7<sup>th</sup> iteration

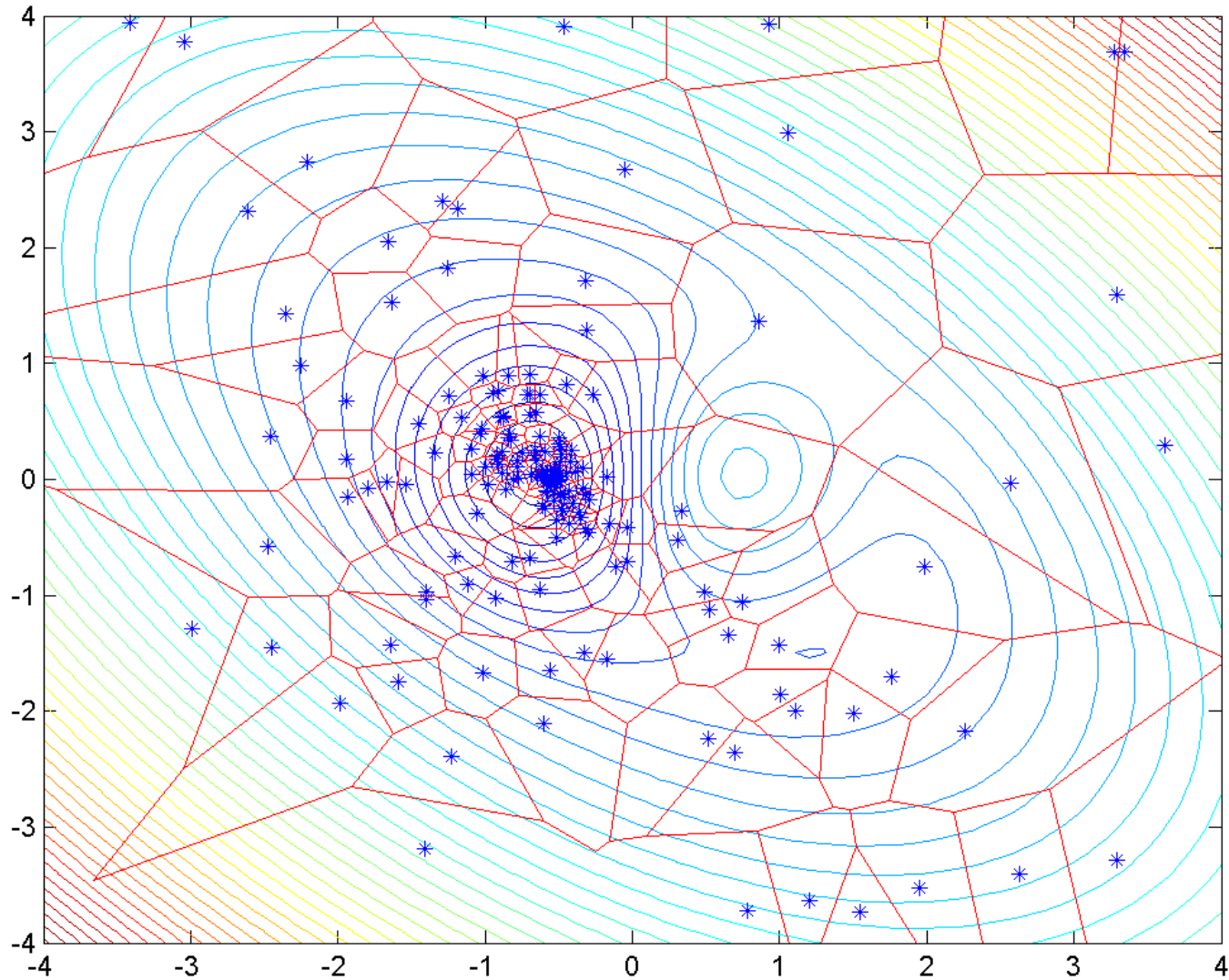

# Inverse models based on boundary elements

*Fukushima et al., JGR, 2005*  
*Tridon et al., JGR, 2016*

## Mixed Boundary Element Method

Buried, or not buried curved intrusions

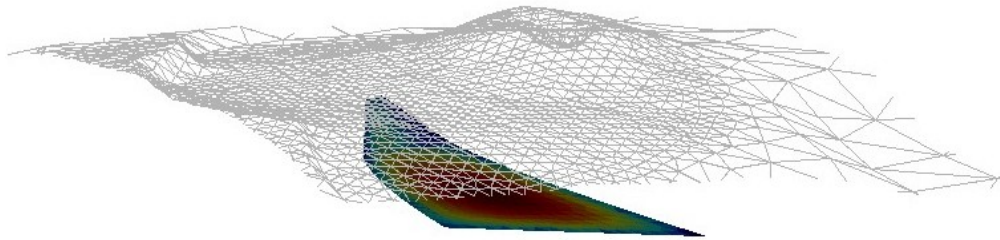

Prolate, oblate, inclined reservoirs

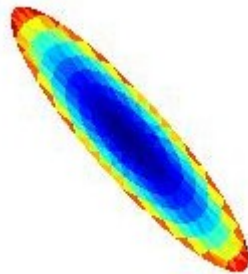
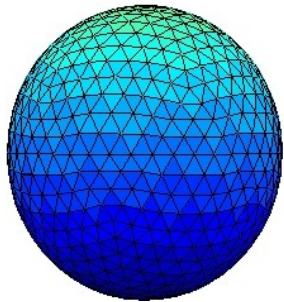

Planar ellipsoids

## Neighborhood inversions

Misfit function:

$$\chi^2 = (u_o - u_m)^T C_d^{-1} (u_o - u_m)$$

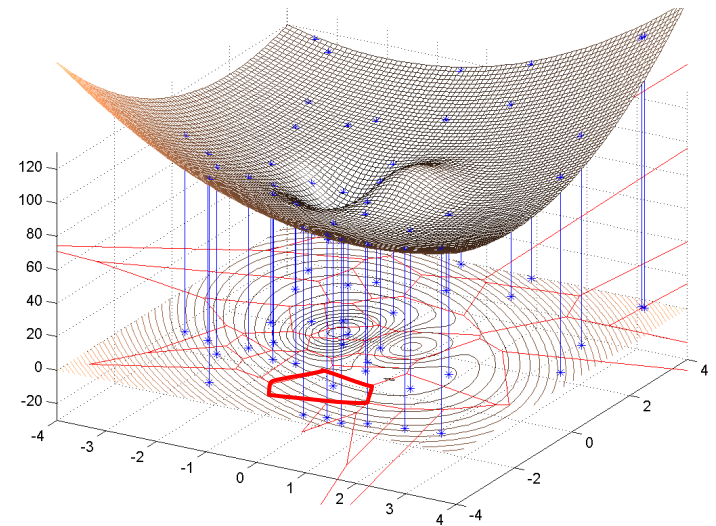

# Web service and interface for fast inversions of volcano deformation

Adapted from  
R. Grandin, HDR

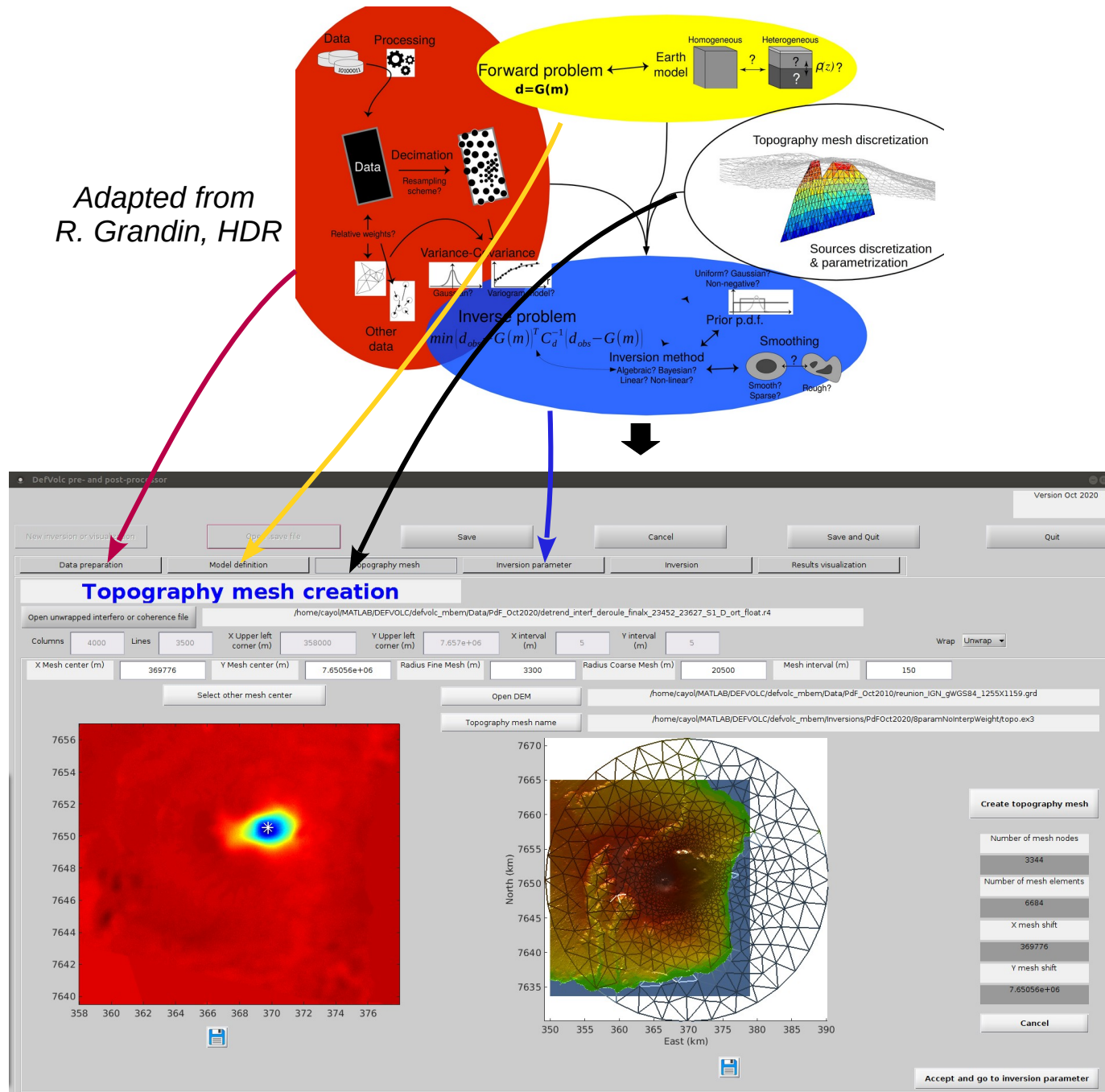

Accessible to registered users <http://www.opgc.fr/defvolc/>

# Non-linear inversion to capture source geometries

Using Okada's model and MCMC inversion

Radial intrusion in 2009 at Fernandina volcano (Galapagos)

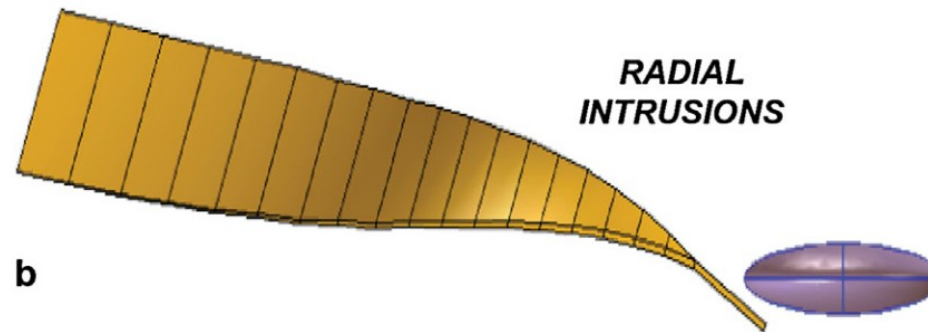
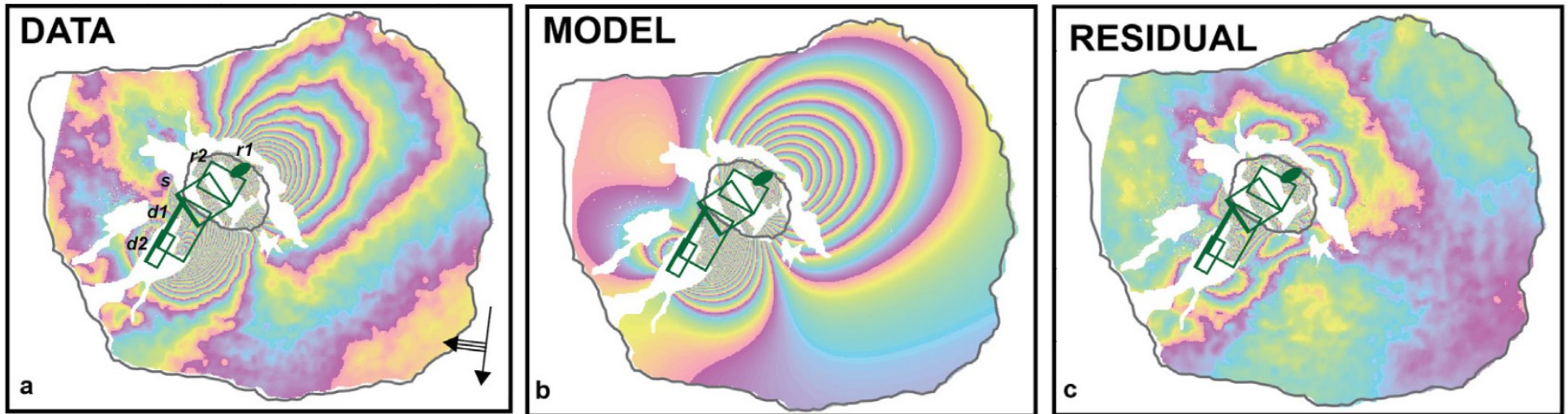

Bagnardi et al., EPSL, 2013



# What can be learnt from analytic and kinematic inverse models ?

## Intrusion pathways

*Bagnardi et al., EPSL, 2013*

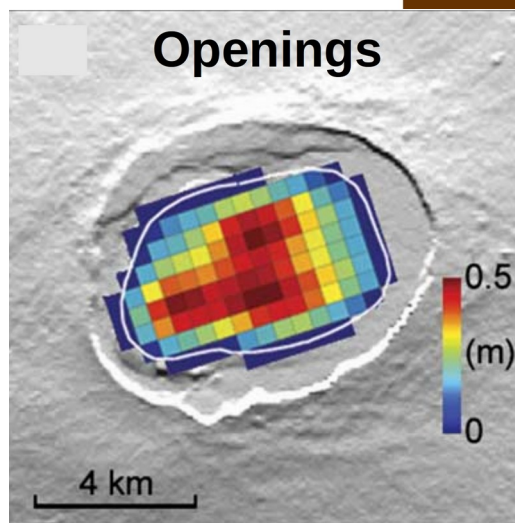
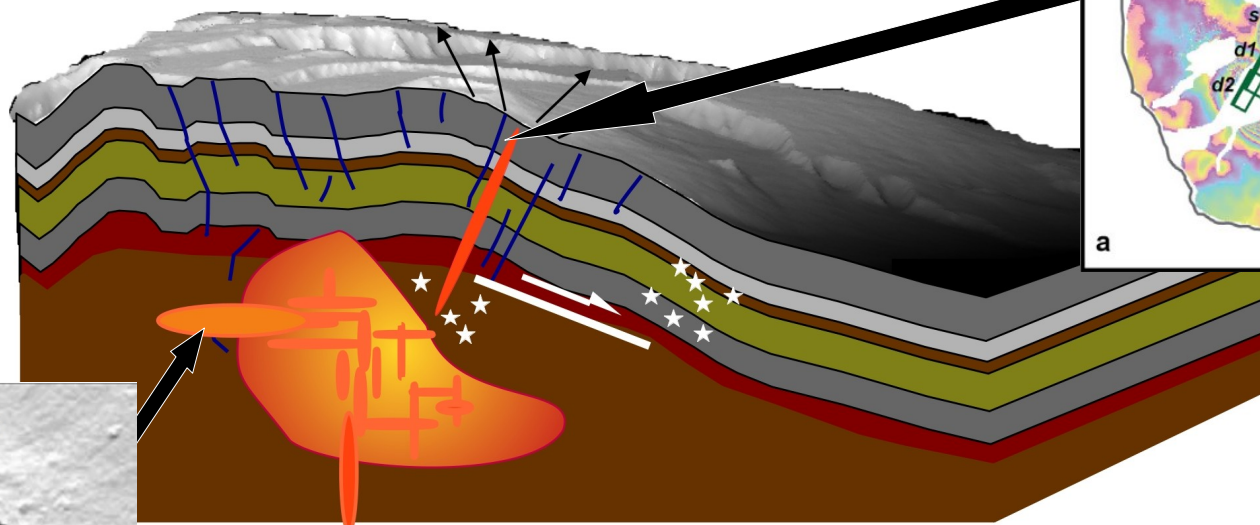
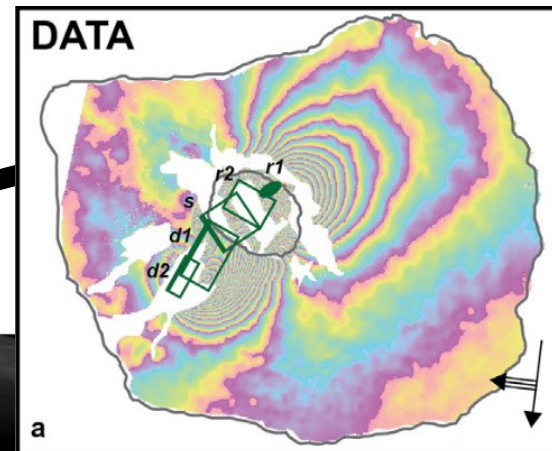

## Characteristics of reservoirs

*Amelung et al., Science, 2000*

# Simple analytic and kinematic models require many parameters

- To better capture openings: linear inversion of **77 parameters**

Uplift at Sierra Negra volcano in 1998-99 (Galapagos)

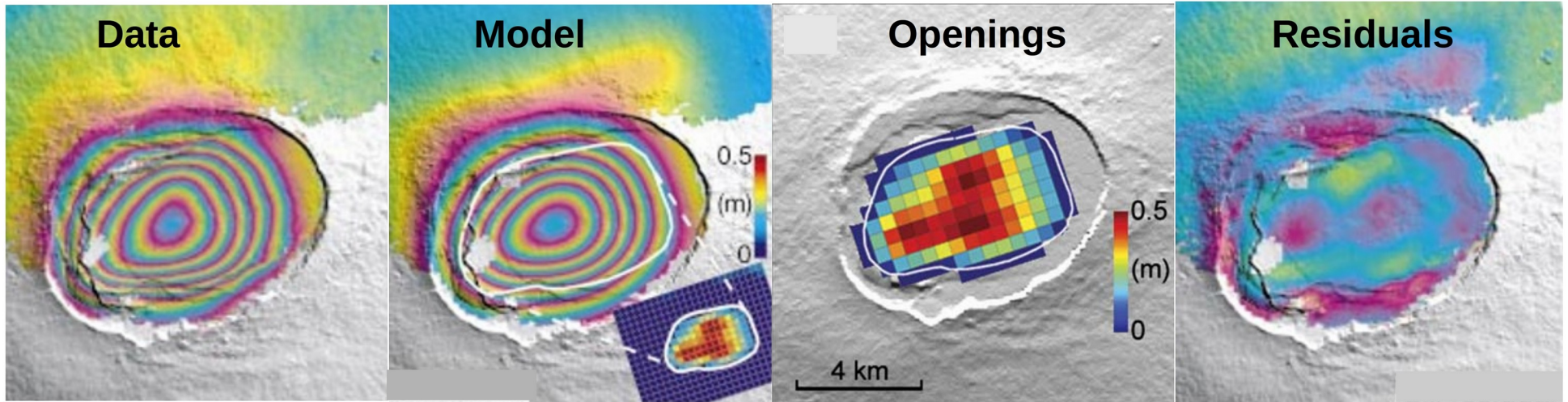

*Amelung et al., Nature, 2000*

- To better capture complex geometries: non linear inversion of **22 parameters**

Radial intrusion in 2009 at Fernandina volcano (Galapagos)

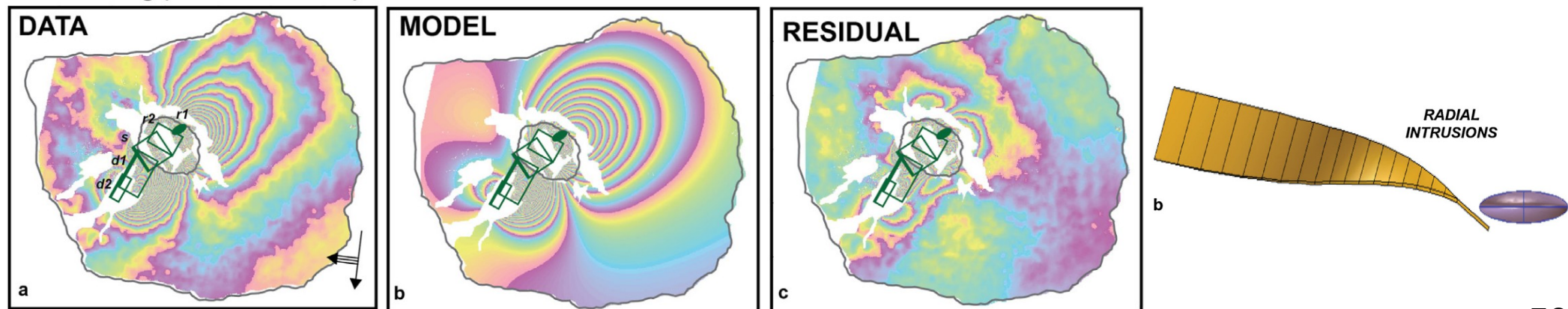

*Bagnardi et al., EPSL, 2013*

# Large numbers of parameters should be avoided

- The probability of finding the best-fit solution decreases with the dimension of the search space ;

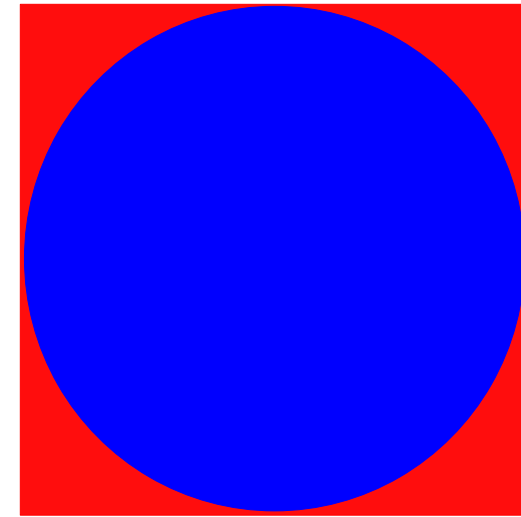
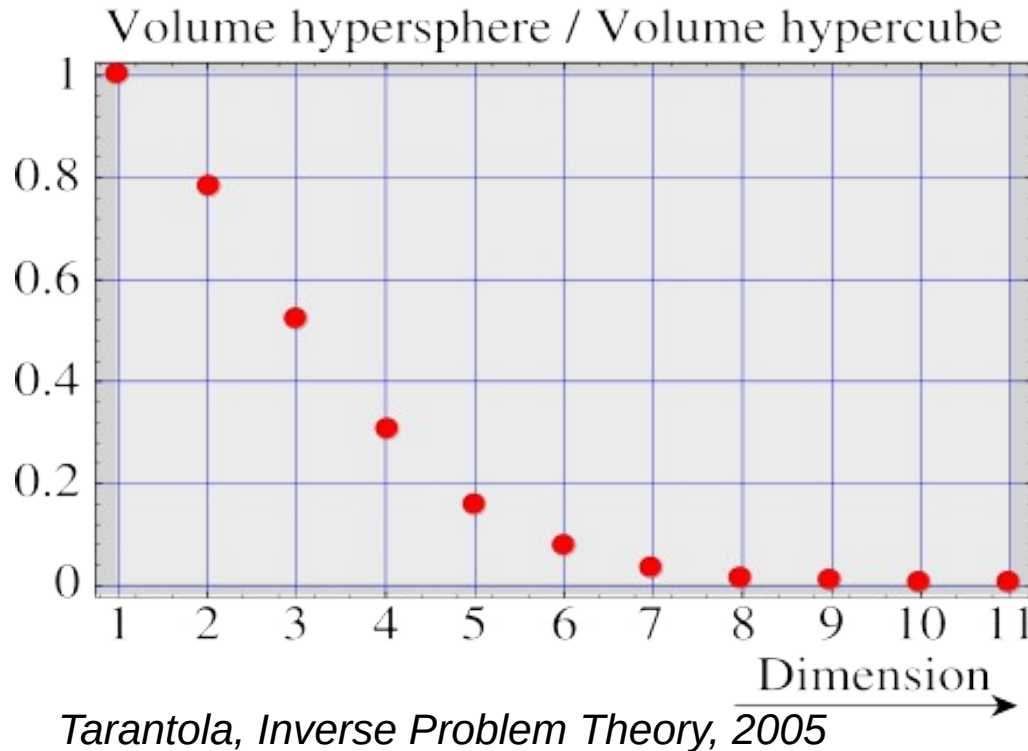

- With non linear inversions, the search time increases exponentially with the number of parameters ;
- There is a risk of overfitting the data.

➡ Use of Akaike Information Criteria

$$\text{AIC} = 2 \cdot k + \chi^2 + \text{cst}$$

with  $k$  = Nb parameters and  $\chi^2$  = cost-function,  
cst = a constant, which depends on the number of data

# Large numbers of parameters should be avoided

- The probability of finding the best-fit solution decreases with the dimension of the search space ;

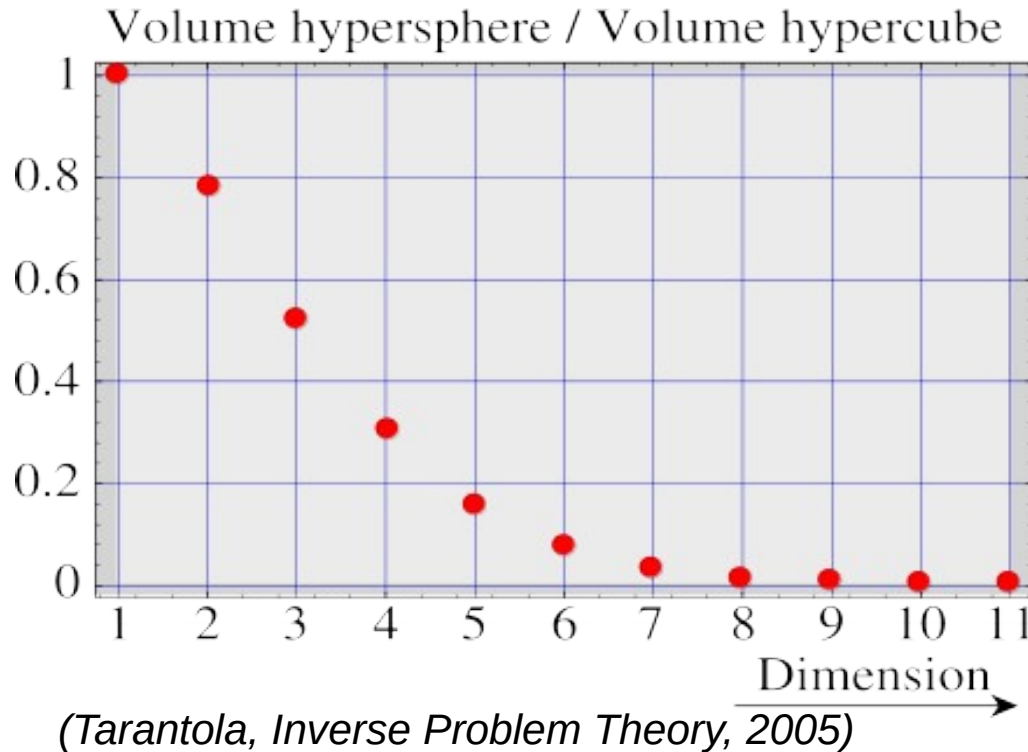

**n = 12**

- With non linear inversions, the search time increases exponentially with the number of parameters ;
- There is a risk of overfitting the data.

➡ Use of Akaike Information Criteria

$$\text{AIC} = 2 \cdot k + \chi^2 + \text{cst}$$

with  $k$  = Nb parameters and  $\chi^2$  = cost-function,  
cst = a constant, which depends on the number of data

# Non-linear inversion to capture source geometries

Using Mixed Boundary elements and neighborhood inversions

## Sill turning into a dike at Piton de la Fournaise Volcano (La Réunion, France)

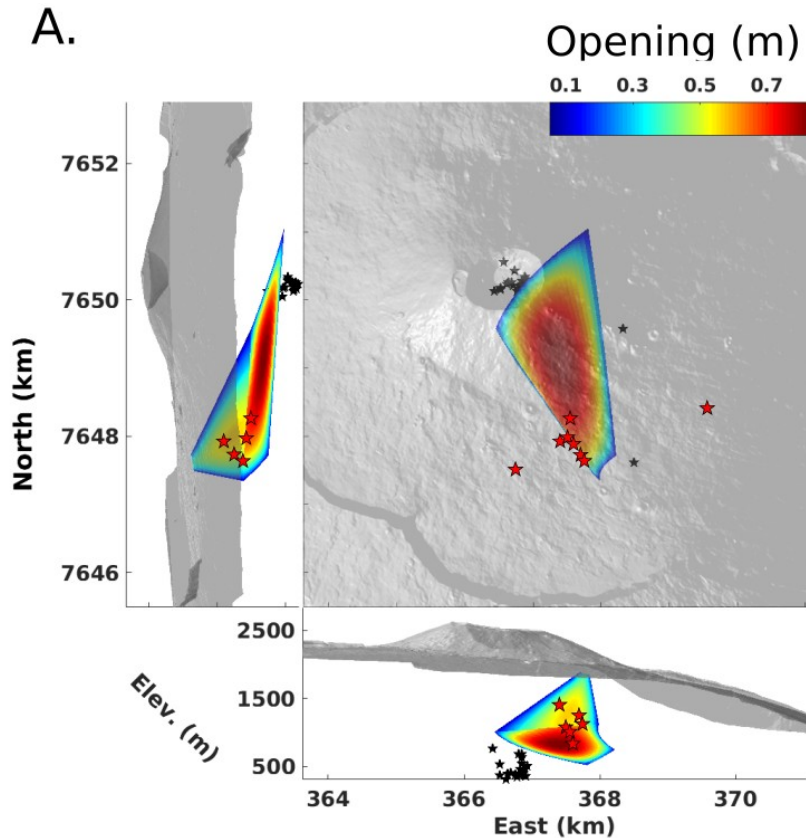

8 geometrical parameters

88% of the data explained

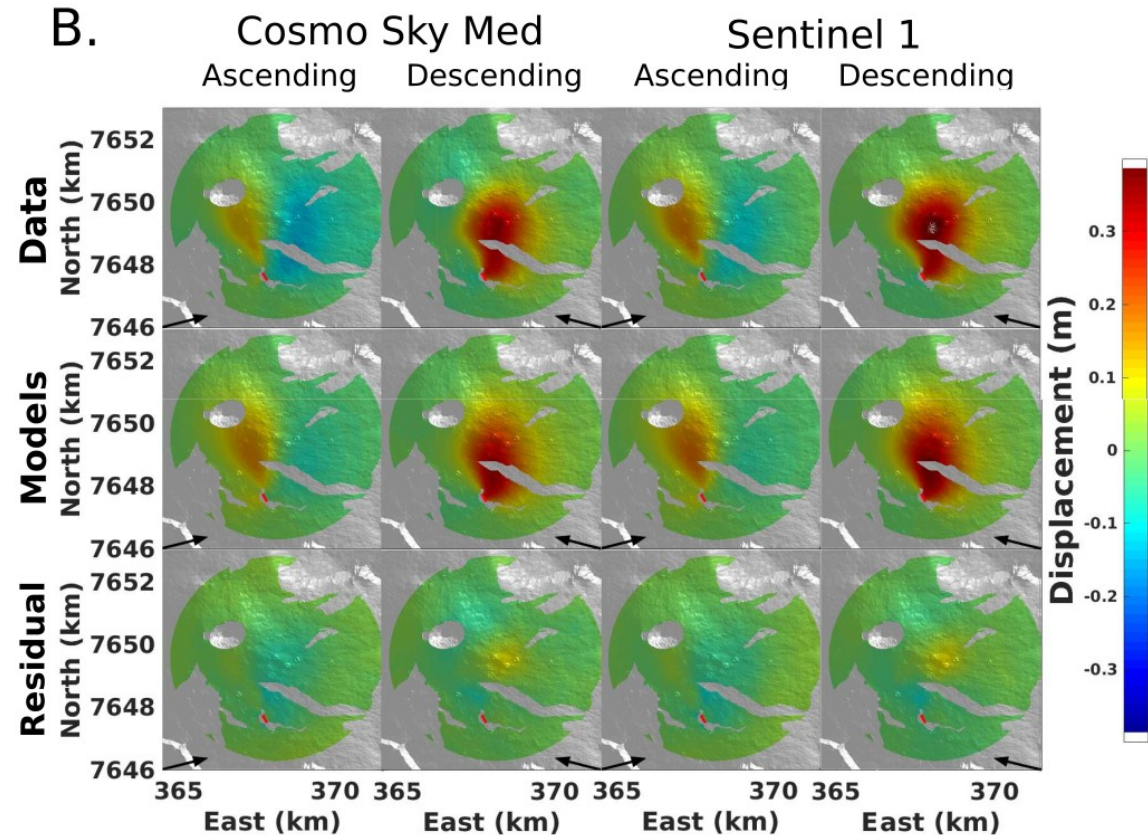

Smittarello et al., JGR, 2019

# Boundary conditions are homogeneous stress



Field observation

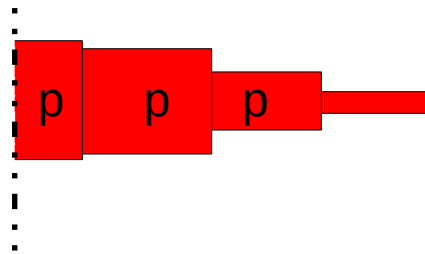

Pressure boundary condition

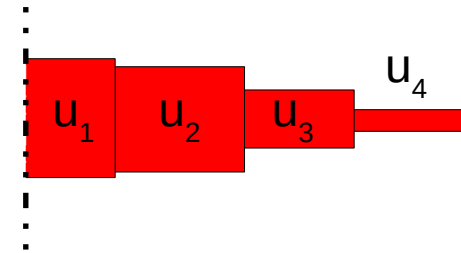

Displacement boundary condition : kinematic models

**Inverted openings**

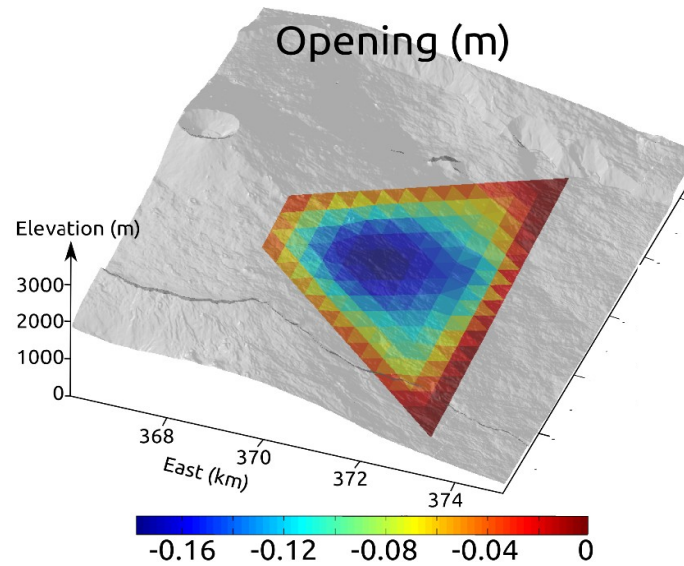

**One parameter**

**~ 5 % of inverse models**

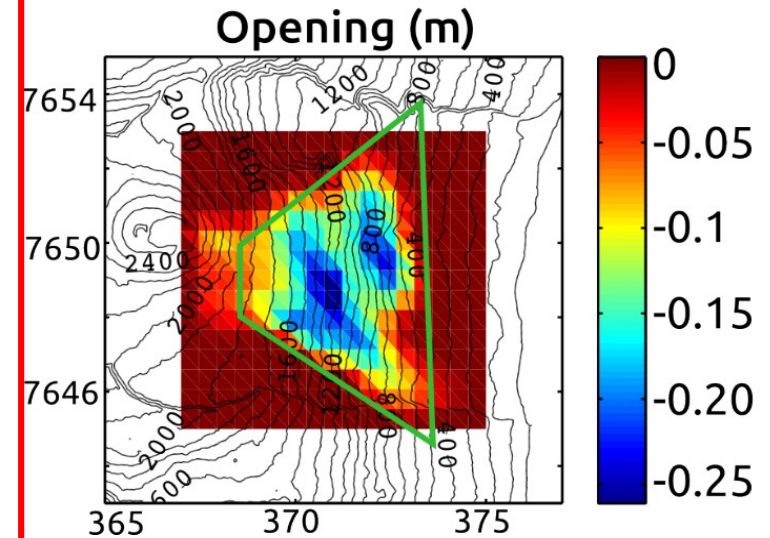

*Tridon et al., JGR, 2016*

**500 parameters**

**~ 95 % of inverse models**

# Stress boundary conditions lead to better models

$$\text{AIC} = 2 \cdot k + \chi^2 + \text{cst} \quad \text{with } k = \text{Nb parameters and } \chi^2 = (\mathbf{u}_o - \mathbf{u}_m)^T \mathbf{C}_d^{-1} (\mathbf{u}_o - \mathbf{u}_m)$$

Pressure boundary condition

Displacement boundary condition

Inverted openings

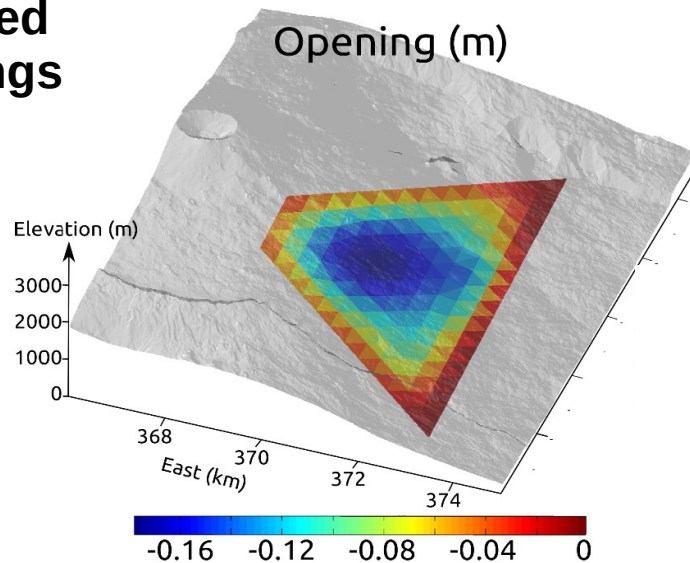

One parameter

$$\chi^2 \approx 2784$$

$$\text{AIC} \approx 2800$$

Opening (m)

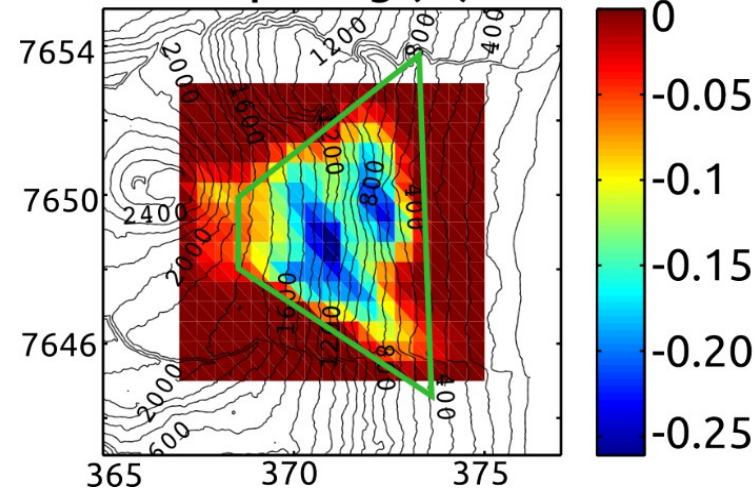

500 parameters

$$\chi^2 \approx 2300$$

$$\text{AIC} \approx 3300$$

*Tridon et al., JGR, 2016*

- ➡ Models with stress boundary conditions require less inversion parameters
- ➡ Inverting for stress leads to **better** models than inverting for dislocation amplitudes

## **4. Benchmarking, verification, validation**



# Modelling benchmarking and verification, inversion validation

Crozier et al., Bull. Volc., 2023

**Community exercise:** Partnership between

- the IAVCEI geodesy commission,
- Subduction Zones in four Dimensions,
- CONVERSE

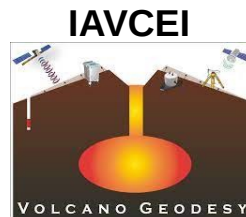

## Benchmarking

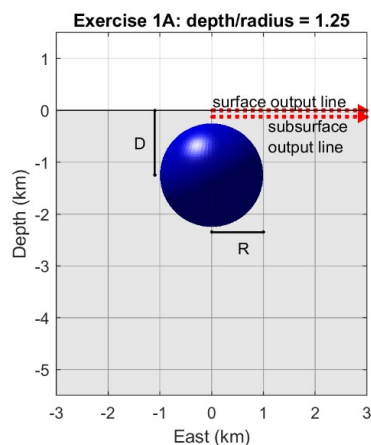

## Verification

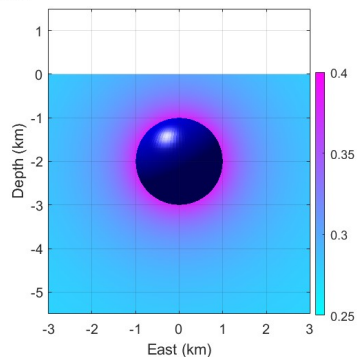
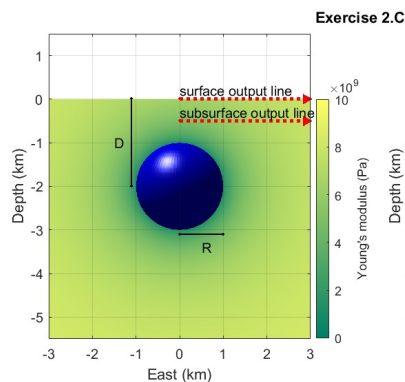
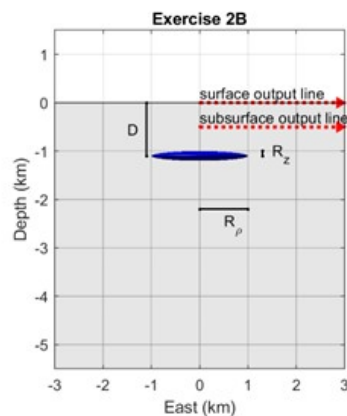
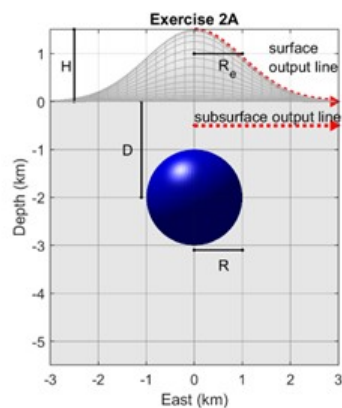

## Validation: inversion

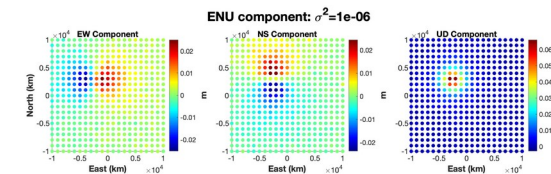
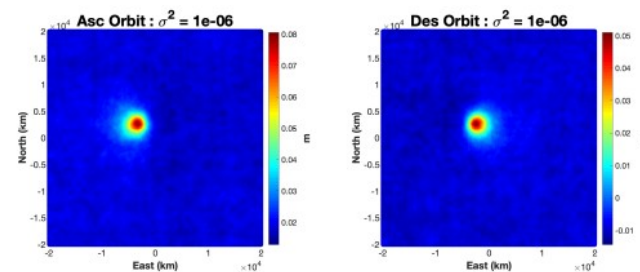

# Exercise goal

Inspired by a Southern California Earthquake Center exercises on simulations of fault rupture. Comparison between solutions for reservoirs in **elastic media**.

The collage features several scientific publications:

- nature geoscience**: Published online 9 September 2012. Article: "Evolution of Santorini Volcano dominated by episodic and rapid fluxes of melt from depth". Authors: Michelle M. Parks<sup>1</sup>, Juliet Biggs<sup>2</sup>, Philip England<sup>1</sup>, Tamsin A. Mather<sup>1</sup>, Paraskevi Nomiros<sup>1</sup>, Kirill Palamartchouk<sup>1,4</sup>, Xanthos Papanikolaou<sup>5</sup>, Demetris Paradissis<sup>5</sup>, Barry Parsons<sup>1</sup>, David M. Pyle<sup>1\*</sup>, Costas Raptakis<sup>5</sup> and Vangelis Zacharis<sup>5</sup>.
- Earth and Planetary Science Letters**: Earth and Planetary Science Letters 447 (2016) 161–171. Article: "Bayesian estimation of magma supply, storage, and eruption rates using a multiphysical volcano model: Kīlauea Volcano, 2000–2012". Authors: Kyle R. Anderson<sup>a,b,\*</sup>, Michael P. Poland<sup>c</sup>.
- AGU Publications**: "Mechanical Imaging of a Volcano Plumbing System From GNSS Unsupervised Modeling". Authors: François Beauducel<sup>1,2</sup>, Aline Peltier<sup>1,3</sup>, Antoinette... (partially obscured).
- Journal of Geophysical Research: Solid Earth**: "A two-magma chamber model as a source of deformation at Grímsvötn Volcano, Iceland". Authors: Thomas Reverso<sup>1,2</sup>, Jean Vandemeulebrouck<sup>1,2</sup>, François Jouanne<sup>1,2</sup>, Virginie Pinel<sup>1,2,3</sup>, Thierry Villemain<sup>4</sup>, Erik Sturkell<sup>5</sup>, and Pascale Bascou<sup>1,2</sup>.

Built in interface <http://www.driversofvolcanodeformation.org/>

- Registered users (~25 participants from 4 countries: students, faculty & observatories)
- Still accessible for benchmarking



# Benchmarking : sphere in a homogeneous $\frac{1}{2}$ space

Exact solution by *Zhong et al., GJI, 2019*

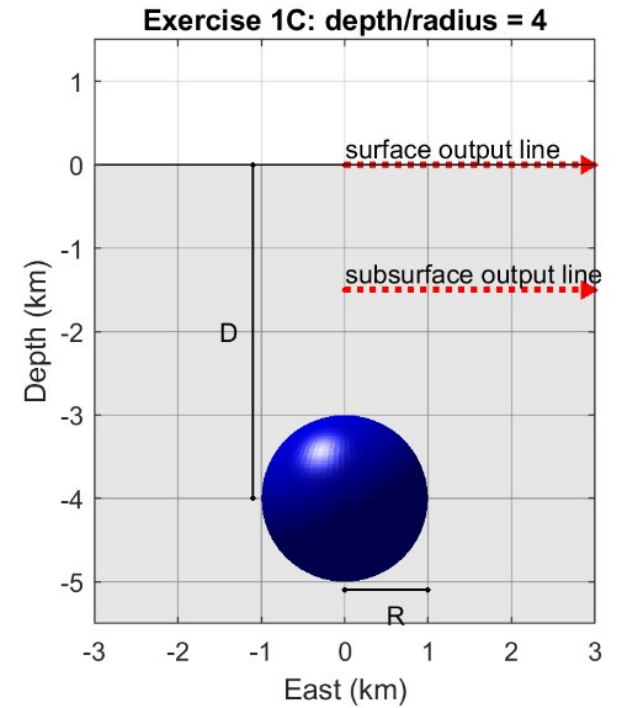
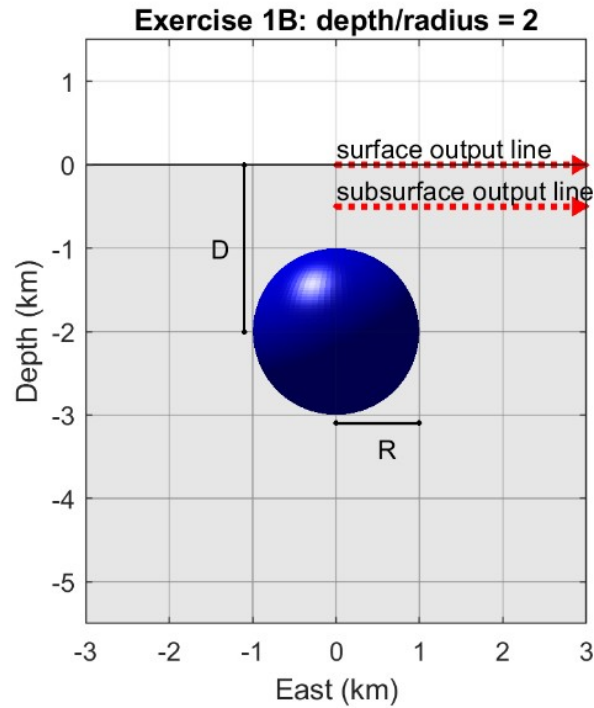
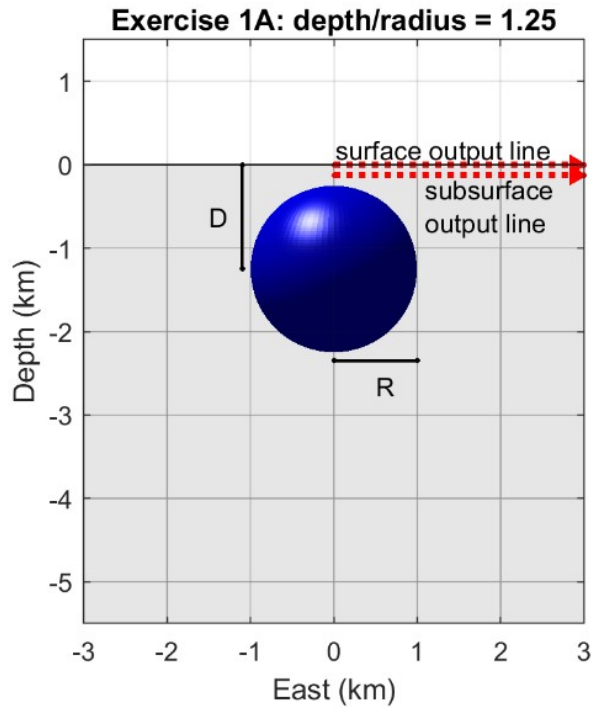

# Benchmarking: sphere in a homogeneous $\frac{1}{2}$ space

## Errors

17 solutions compared: Analytic McTigue, Analytic Mogi, BEM 3D dislocations, 3D mixed BEM, Comsol 2D FEM, FEM 2D NGSOLVE, FEM 3D Pylith, etc.

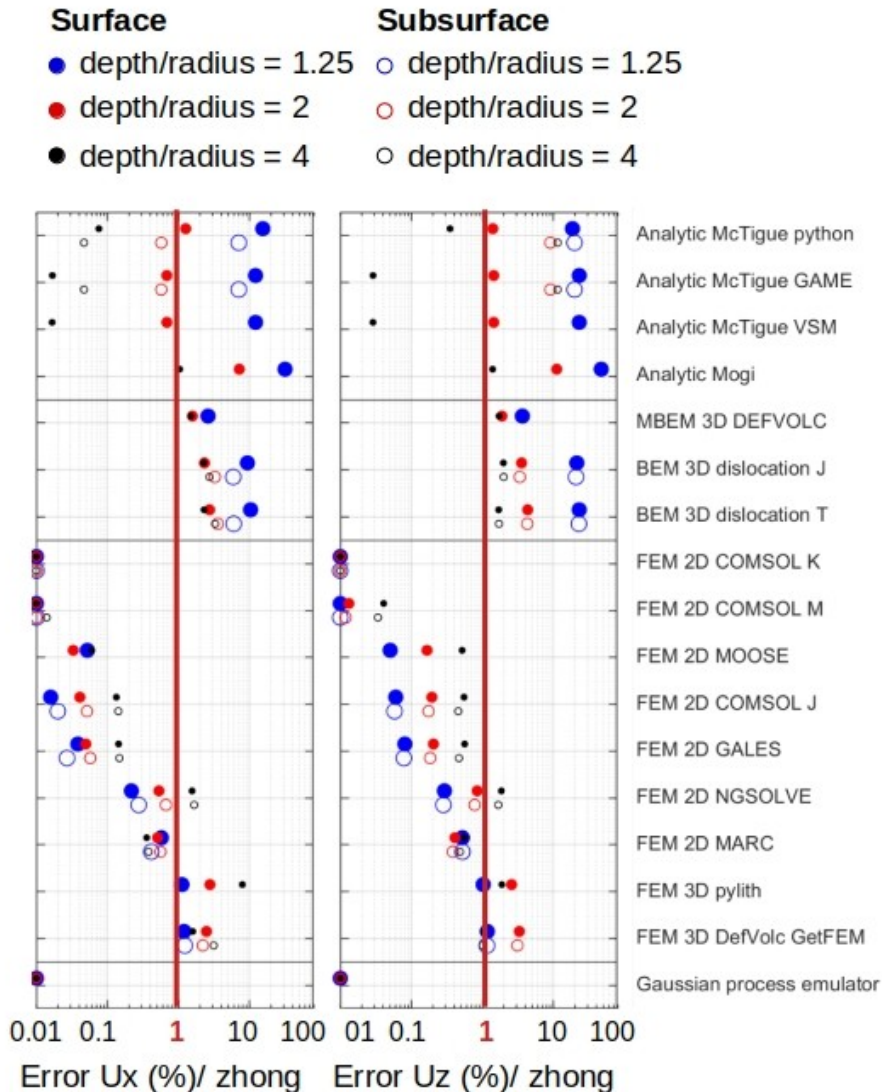

- For deep reservoirs ( $D/R=4$ ), all solutions are acceptable (1% error).
- For shallow reservoirs ( $D/R < 1.25$ ), Mogi and McTigue have large errors ( $> 10\%$ ).
- 2D Finite Element Model (FEM) solutions show the **lowest error** ( $< 1\%$ ).
- 3D solutions show **larger errors** ( $\sim 1-3\%$ ), particularly dislocations Boundary element Methods (BEM) (11%).
- **Several bugs** have been identified in analytic solutions.

# Benchmarking : sphere in a homogeneous $\frac{1}{2}$ space

## Convergence tests

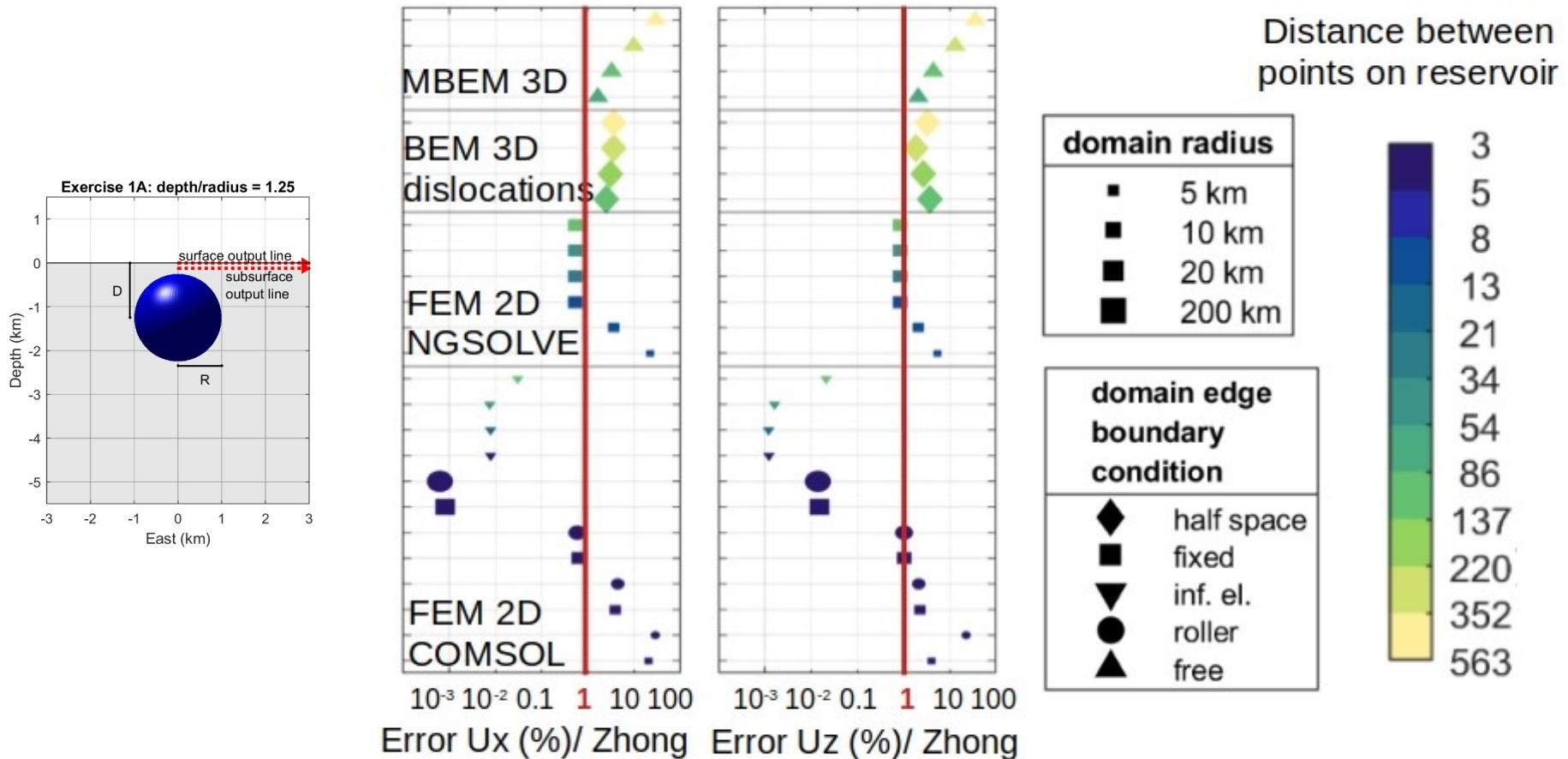

- The domain size must be at least **20 times the source size** (infinite elements are best)
- The **mesh density fine enough** to have solution convergence.
- No significant difference between types of boundary conditions

# Validations: adding topographies

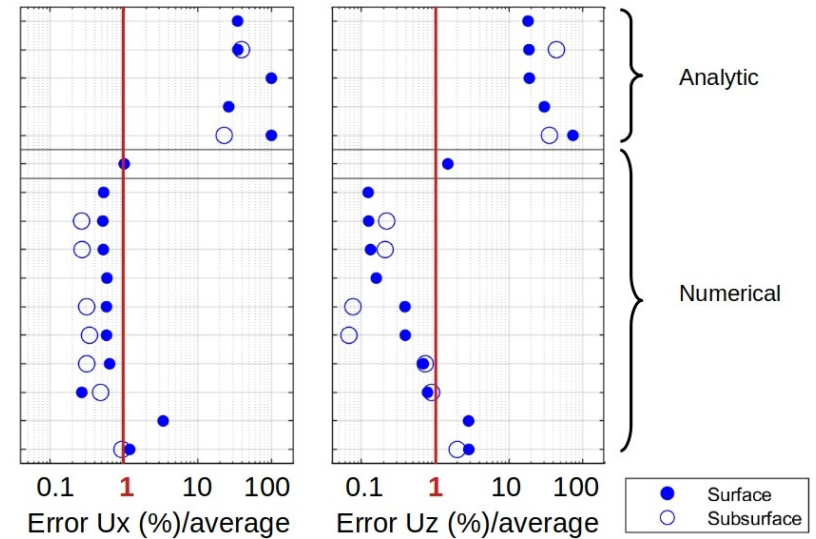
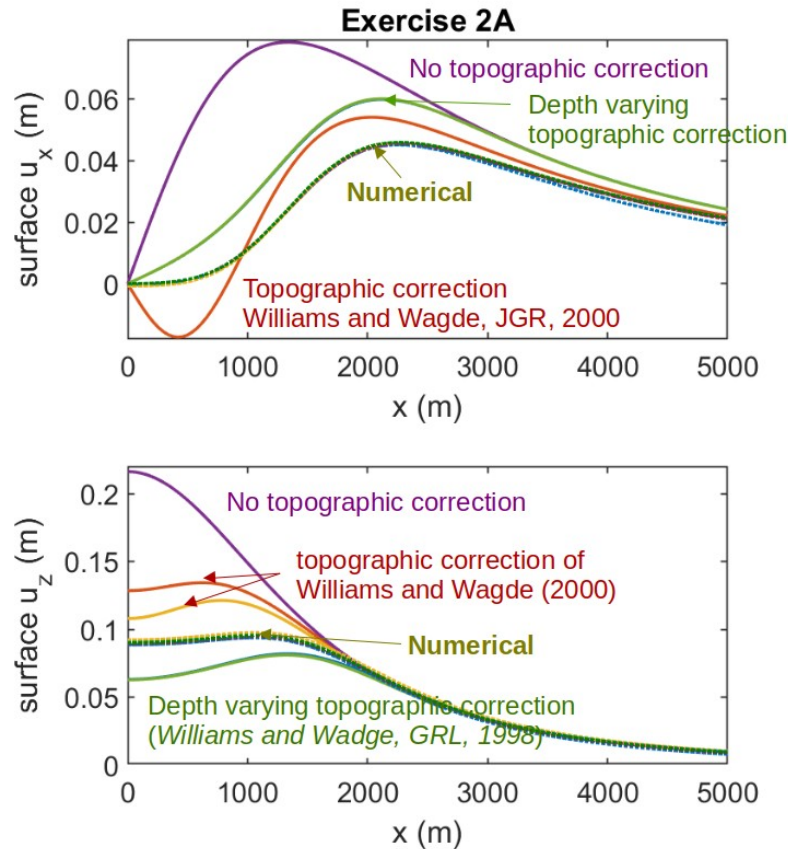
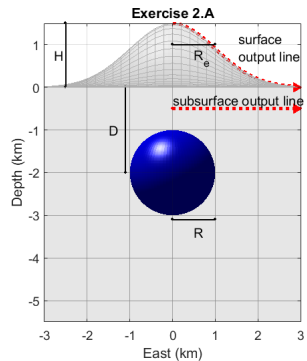

- **Analytic** solutions, with or without topographic corrections, are far from **numerical solutions** ( $U_z$  is 66 % larger for no topographic correction, and 30% smaller for depth varying correction)
- **Less than 1%** of difference between numerical solutions;

# Validations: heterogeneities in elastic properties resulting from temperatures

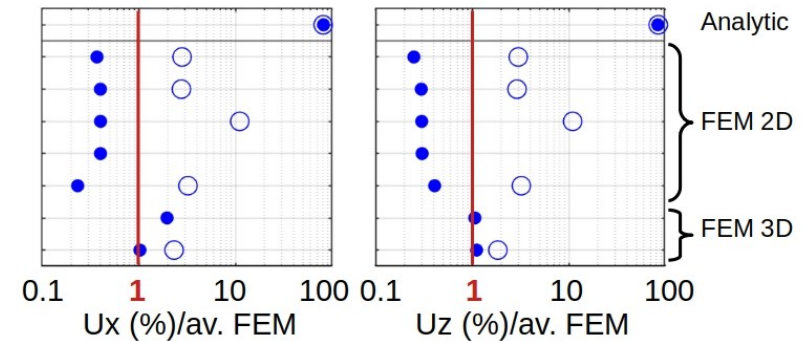
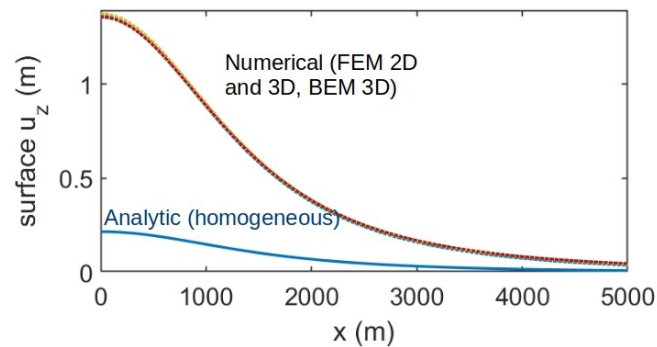
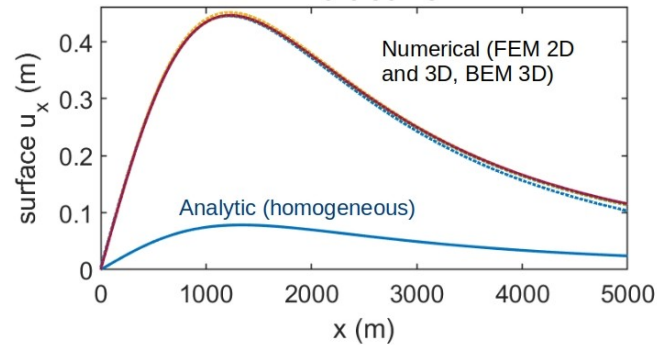
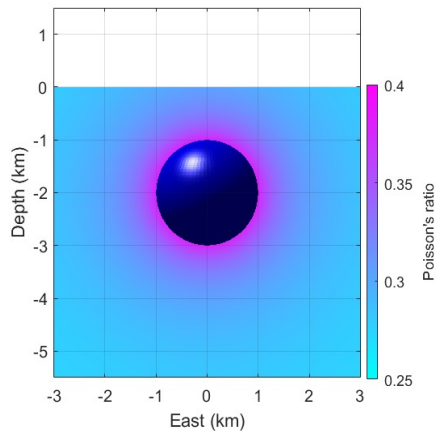
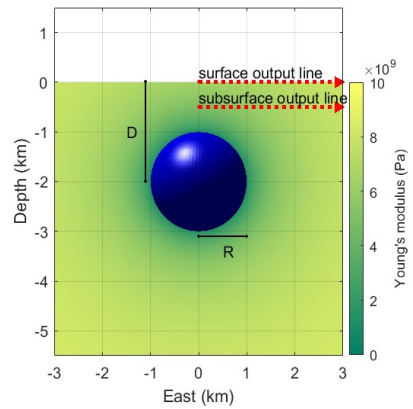

Following *Bakker et al., JGR, 2016*

- Analytic homogeneous solution is **wrong** ( $U_z$  is 85% less)
- **2D and 3D FEM** solutions are **close** ( $< 1\%$  variations)
- Using analytic solutions, the shape of the solution is right, but the amplitude too weak  $\rightarrow$  overpressures might be overestimated.
- However, these heterogeneities might be **second order** relative to **depths varying heterogeneities**

# Verification: inversion of InSAR and GNSS data

## Sphere in a half-space (*Zhong et al., GJI, 2019*)

Low Noise ( $\sigma^2 = 10^{-4} \text{ m}^2$ )

InSAR

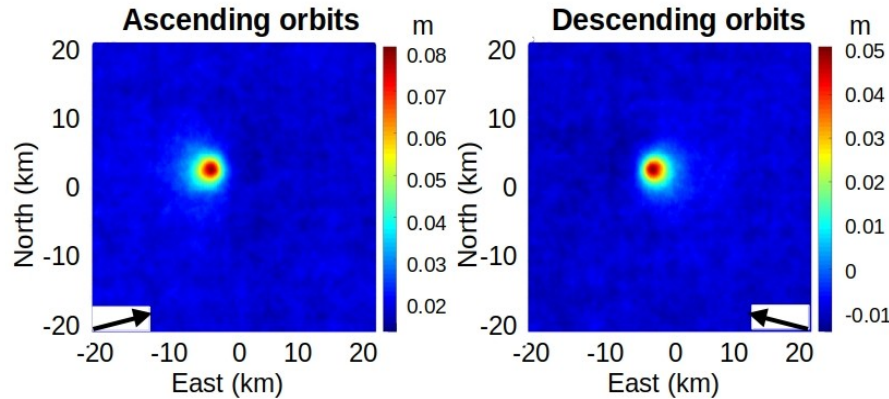

GNSS (400 points)

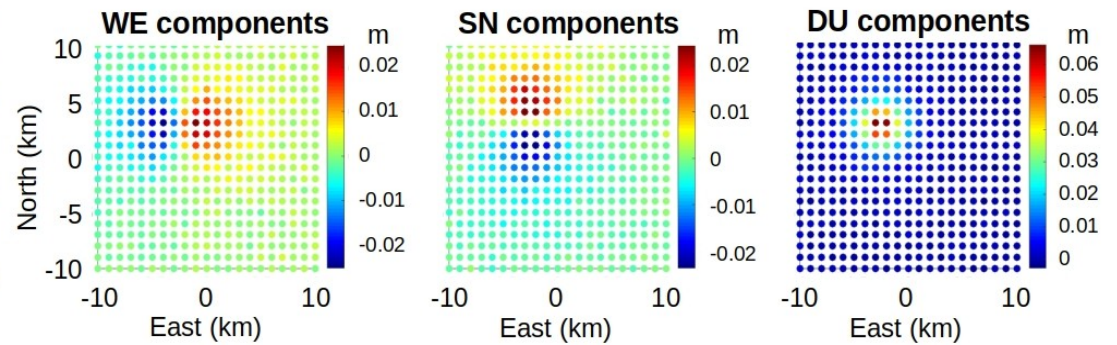

High Noise ( $\sigma^2 = 10^{-6} \text{ m}^2$ )

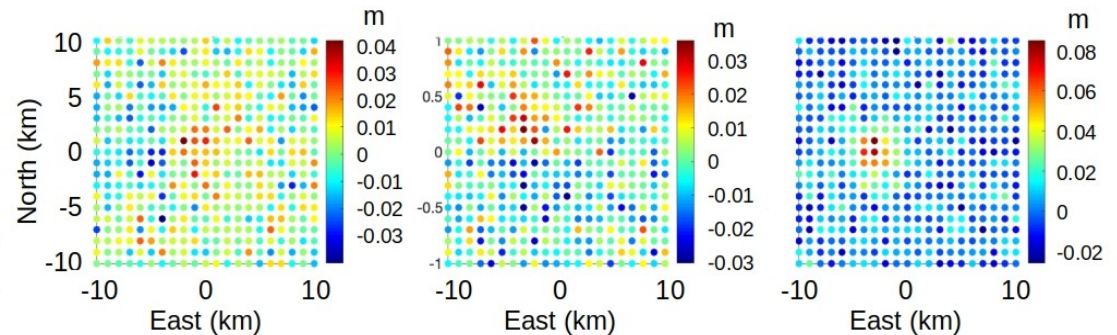
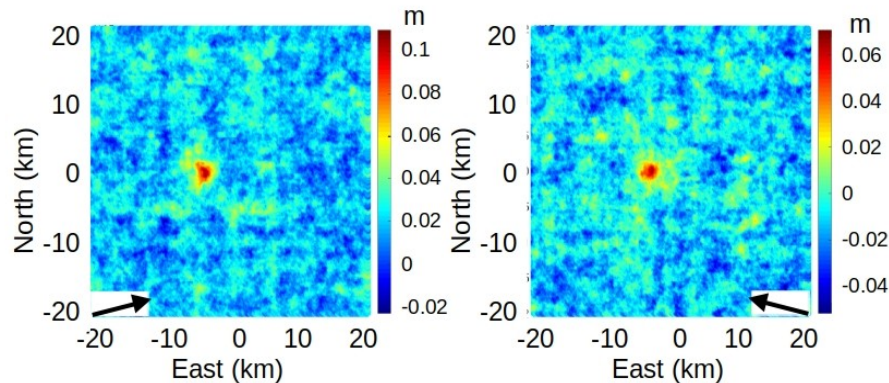



# Verification: inversion of InSAR and GNSS data

Results for low noise data (depth/radius = 2.3)

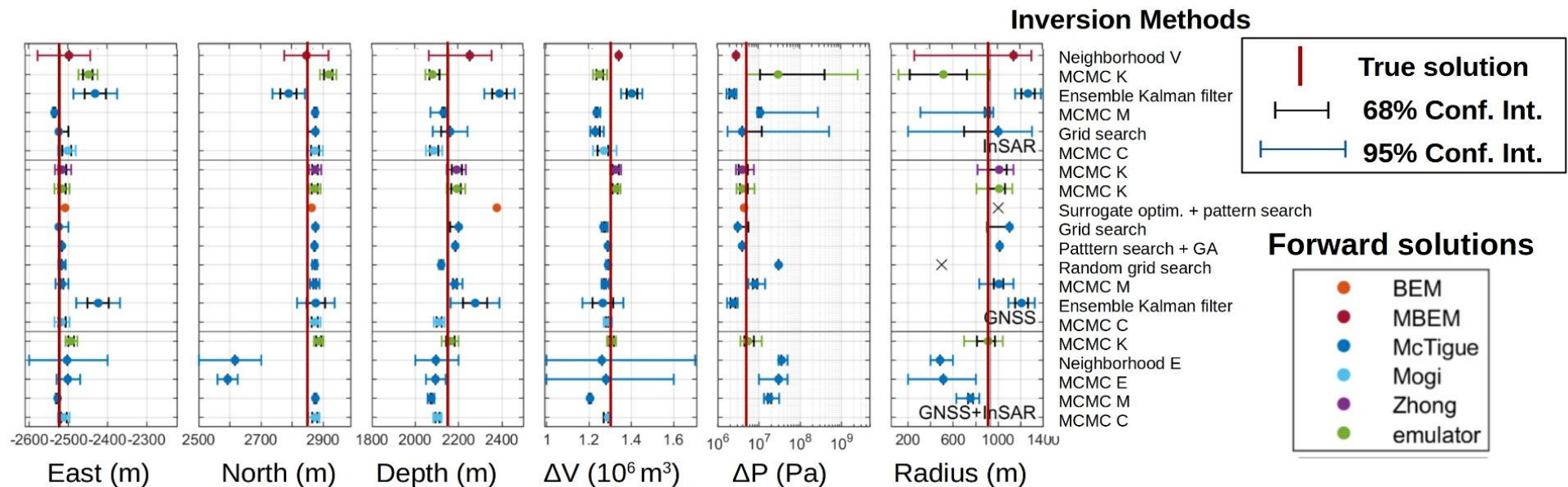

- Large range of forward modelling methods: BEM, FEM, Analytic, Emulator;
- Large range of inverse methods: Neighborhood, Markov Chain Monte Carlo (MCMC), Ensemble Kalman Filter, Genetic algorithm, surrogate search, grid search;
- Best determined parameters are: coordinates, depth (20% of range), and volume changes (30% range);
- As expected, poorly constrained pressure change and reservoir radius;
- Better accuracy for GNSS/InSAR in this exercise, but number of GNSS points is **unrealistic!**
- With high noise, the initial model is well retrieved with larger depth (35%) and larger volume change (50%) ranges than the low noise solution (20 and 30%, respectively);
- Many submissions failed to obtain the solution within **the obtained uncertainties**.
- **Larger variations** related to **inversion methods** rather than **forward model** choice

# Verification: inversion of InSAR and GNSS data

Misfit function  $\chi^2$  and Probability Densities Functions (PDF) low noise

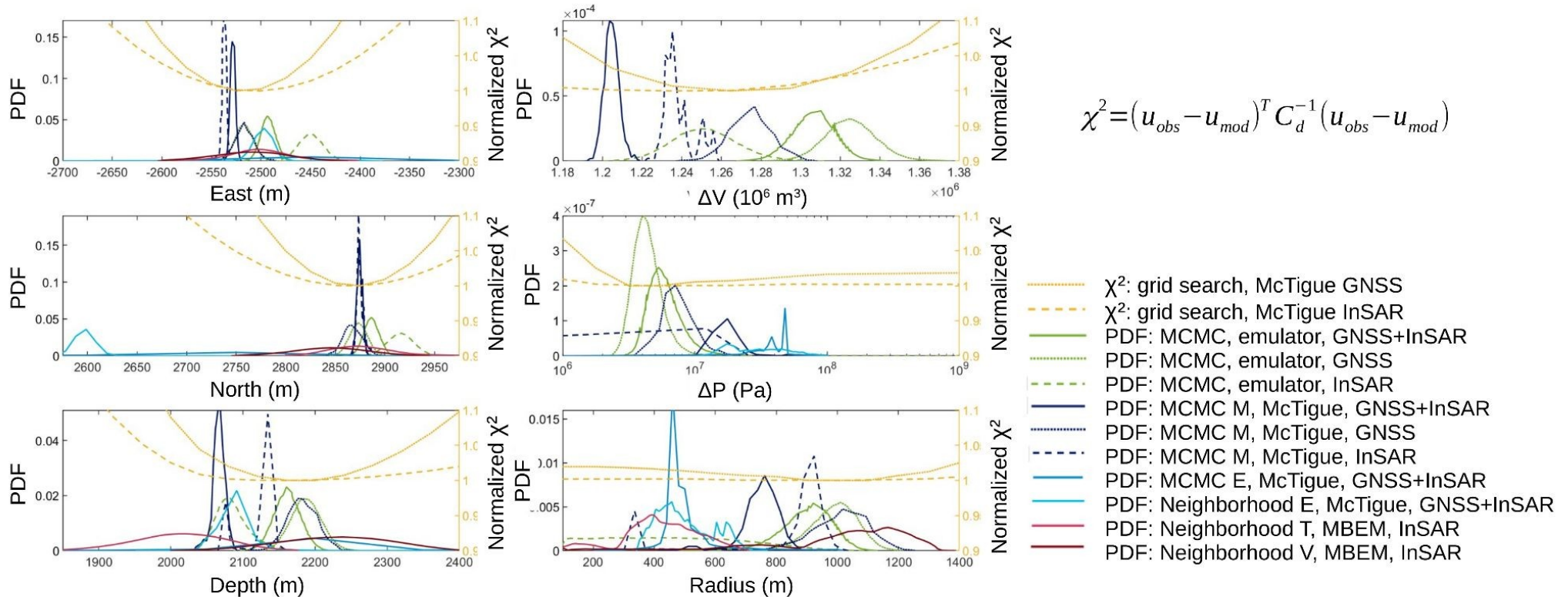

$$\chi^2 = (\mathbf{u}_{obs} - \mathbf{u}_{mod})^T \mathbf{C}_d^{-1} (\mathbf{u}_{obs} - \mathbf{u}_{mod})$$

- $\chi^2$  reflect poorly resolved parameters (pressure and radius);
- The sharpness of PDF reflect the number of forward models computed using the different inversion methods;
- Emulators used with inversions present interesting alternatives to numerical simulations.

## Best practice when analysing volcano deformations

- For deep spherical source (depth/radius $>2$ ) at flat volcanoes, Mogi and Mc Tigue solutions are **acceptable**
- For more complex cases, closer to real volcanoes, analytic solutions are **inaccurate**, and **3D numerical solutions** are needed.
- Importance to **benchmark** numerical solutions against exact analytic solutions;
- Importance to **test convergence** of numerical models;
- Because of the large variability related to **inverse methods**, it is important to test new implementations of inversions using **synthetic tests**;
- It is likely that solutions determined have inaccurate parameters and uncertainties estimations: need for **external constraints** on source characteristics, or for **joint inversions** of different parameters.
- For **inversions** with more complex volcanoes, **need for fast numerical methods**, such as Gaussian process emulators or Fictitious domains methods.

**5. Examples :**  
**5.1. Stress change inversion as gauges for crustal stress**

# What drives and accommodates rift extension in Kivu ?

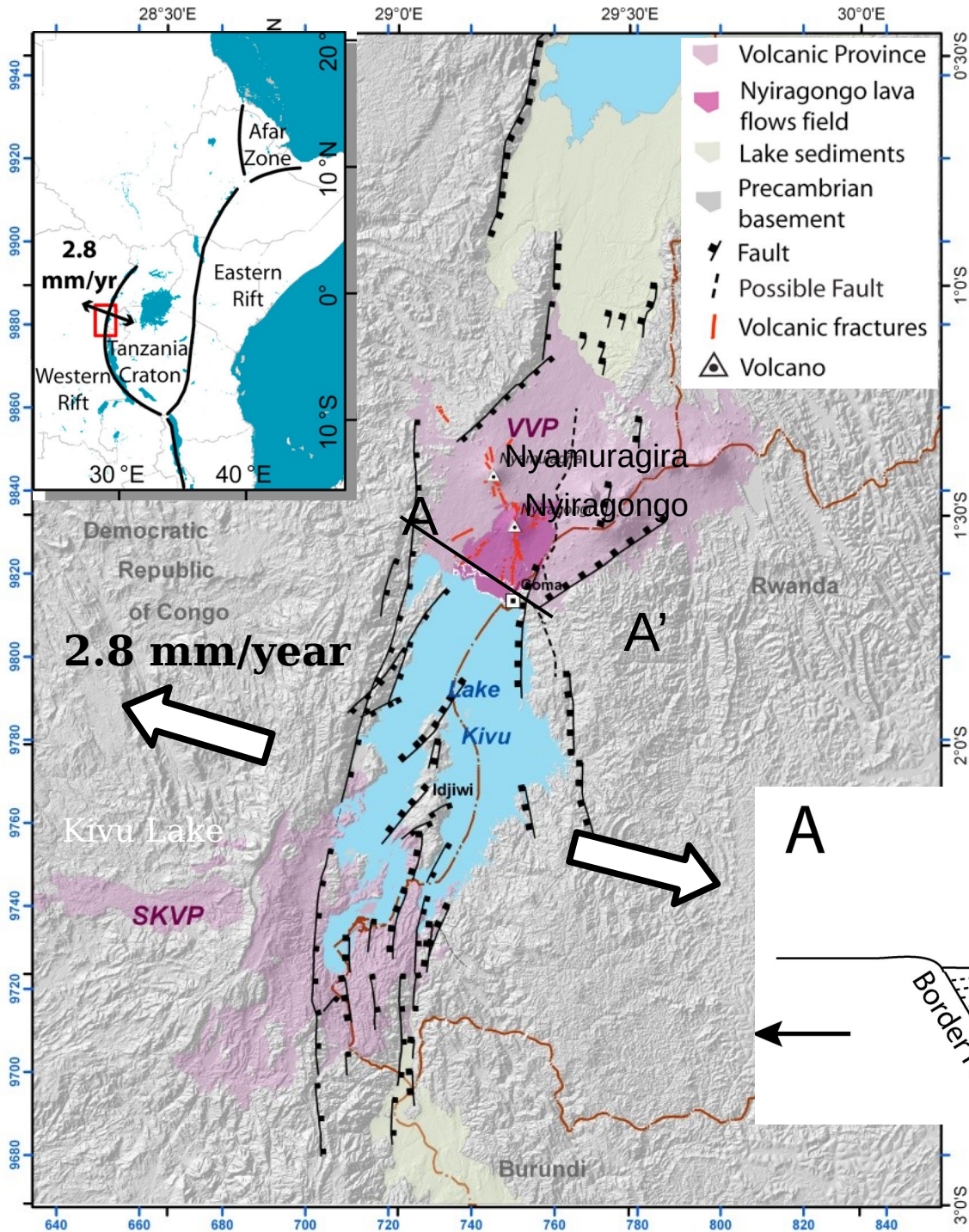

## The Virunga volcanic Province (VVP)



Nyiragongo, Goma and its suburb of 2,1 M inhabitants

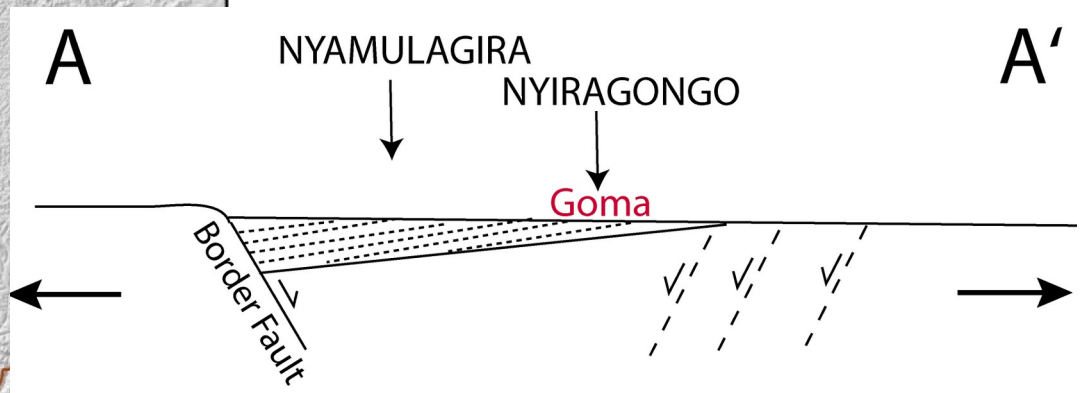

Wauthier et al., JGR, 2012

# What drives and accommodates rift extension in Kivu ?

Tectonic stresses and  
Faulting assisted extension ?

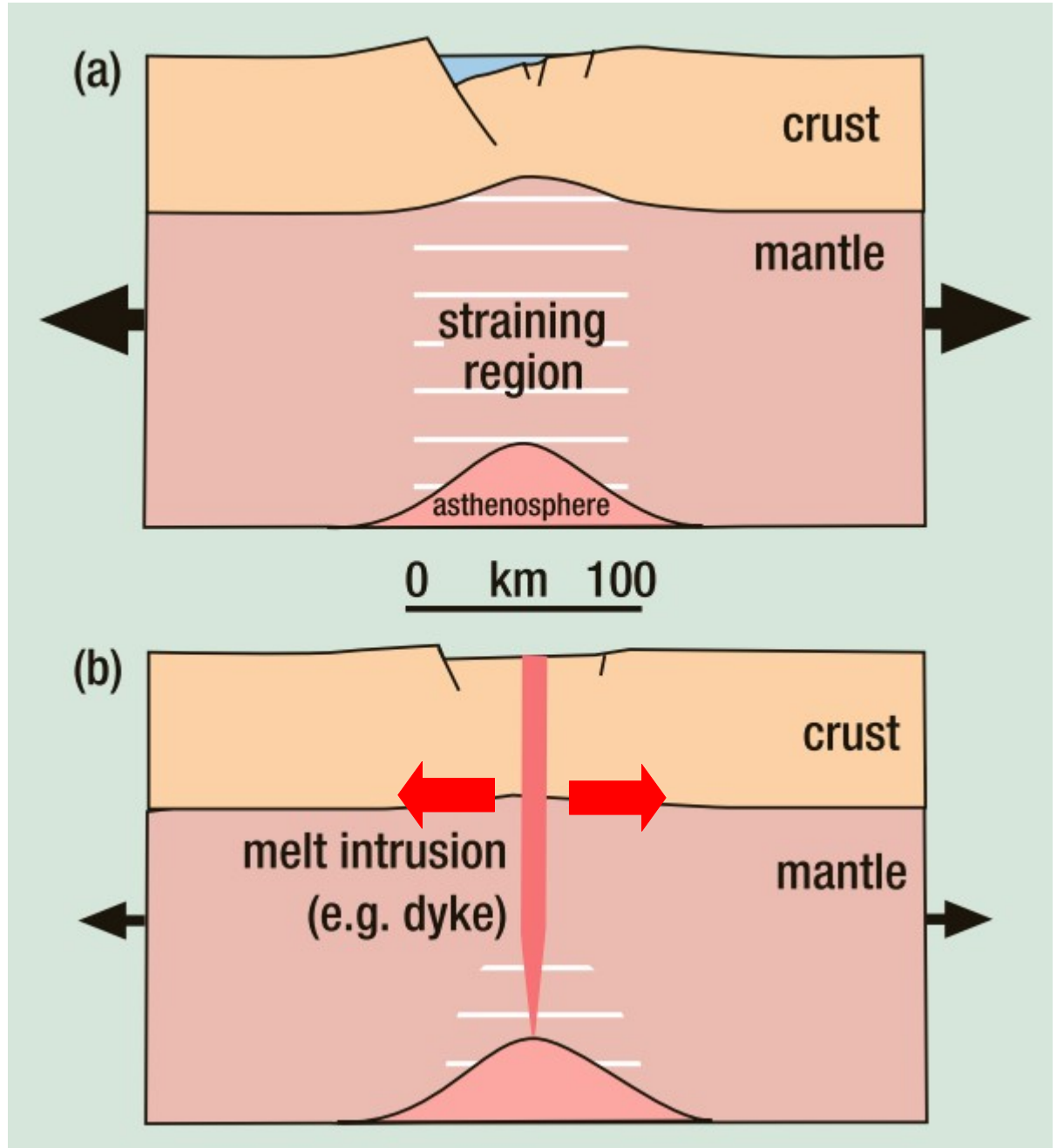

Magma assisted extension ?

# What drives and accommodates rift extension in Kivu ?

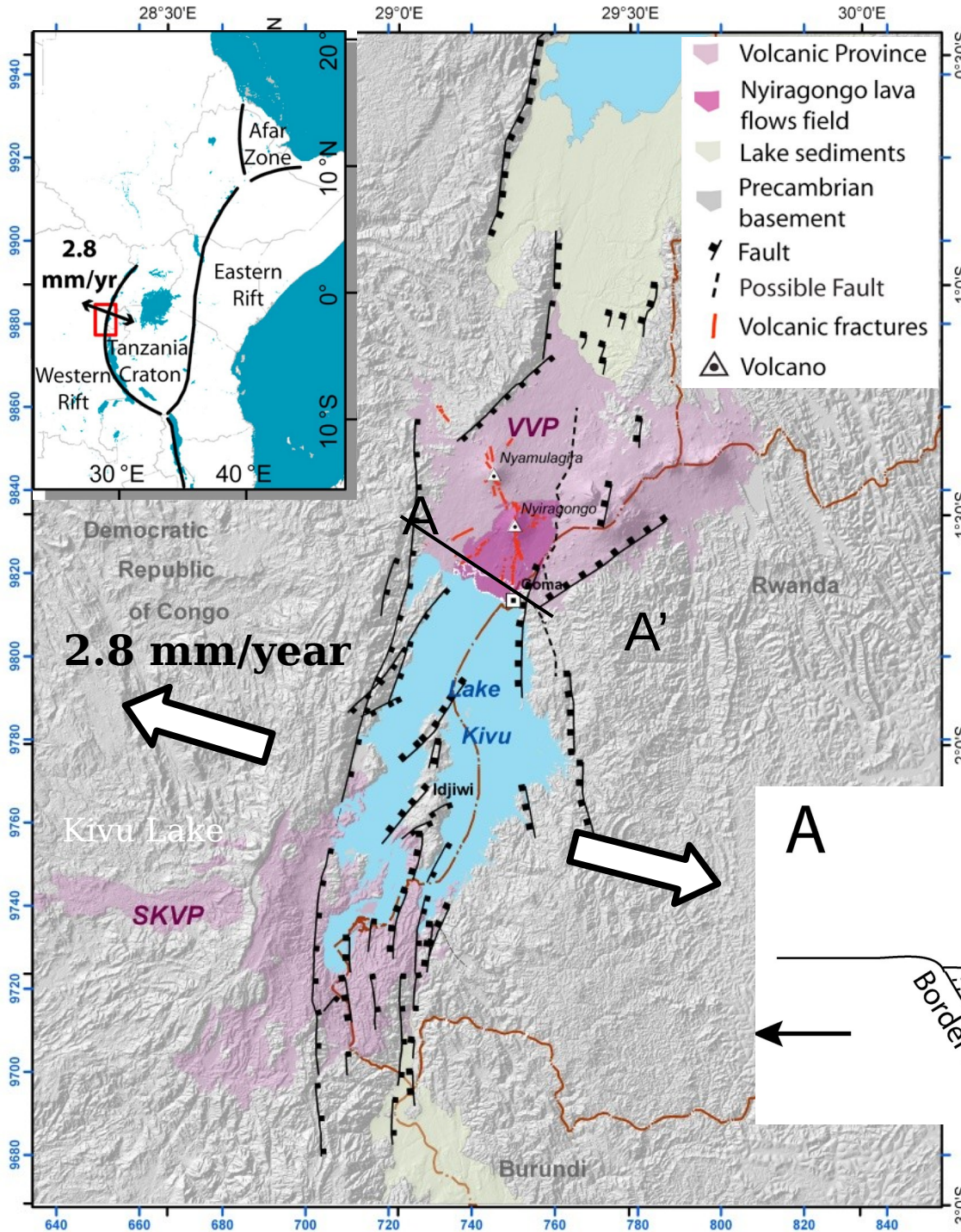

## In the Virunga Basin:

- Only 15% of crustal extension
- Extension is accommodated by western border detachment faults, Ebinger, Geol. Soc. Am. Bull, 1989

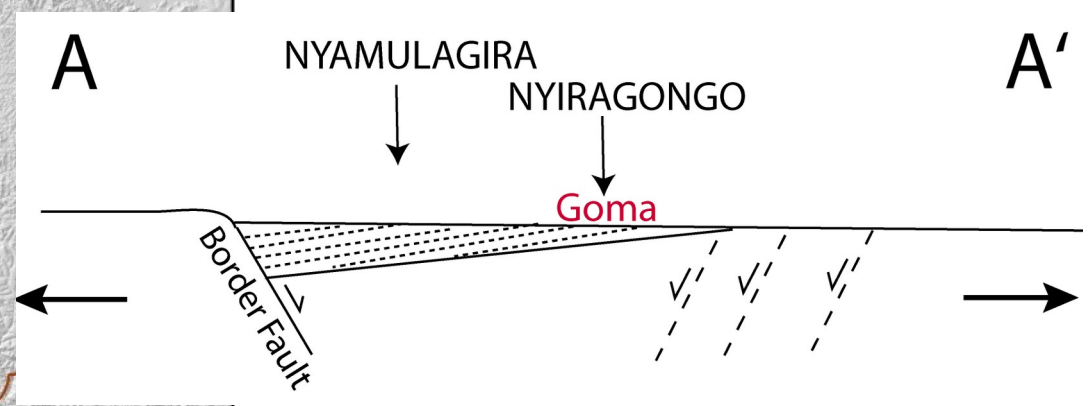

Wauthier et al., JGR, 2012

# What drives and accommodates rift extension in Kivu ?

Tectonic stresses ?

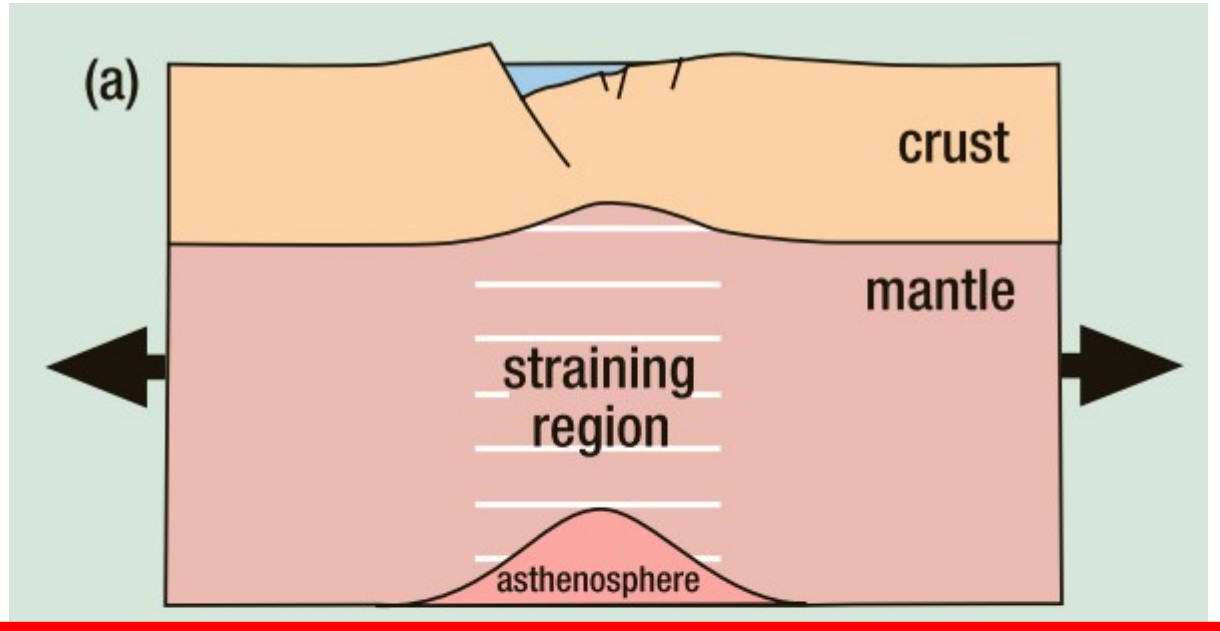

Magma assisted extension ?

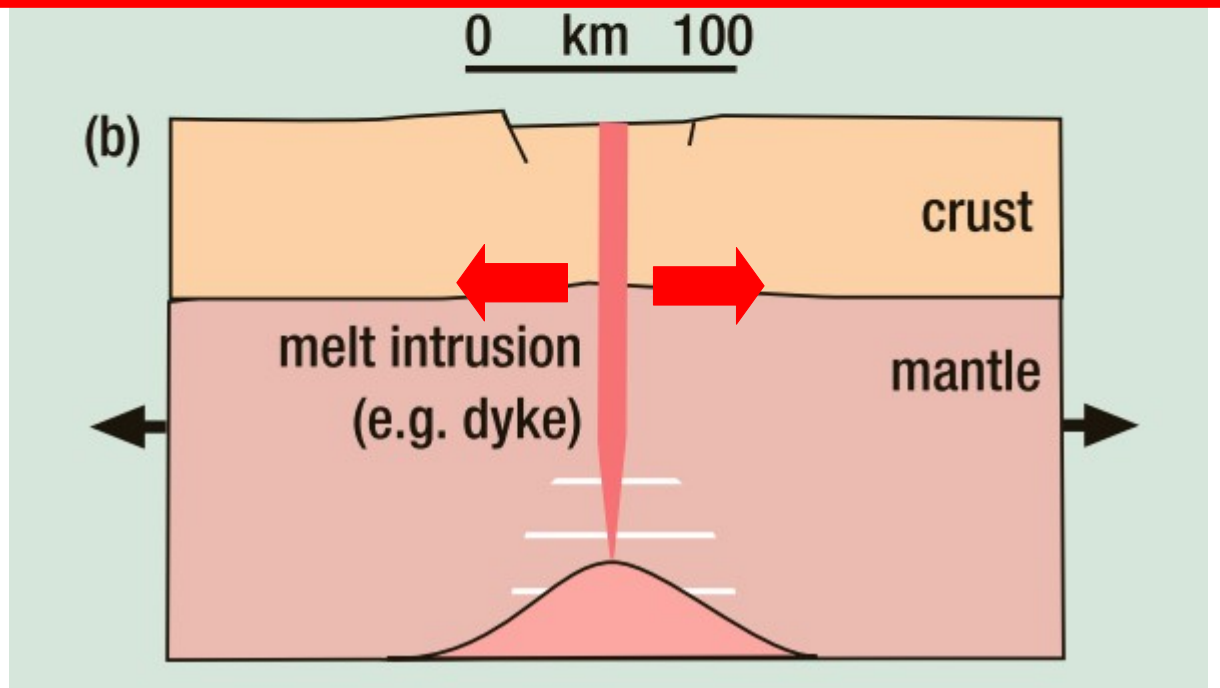

(Ebinger, *Astronomy and Geophysics*, 2005)



# Nyiragongo 2002 and 2021 eruption Democratic Republic of the Congo

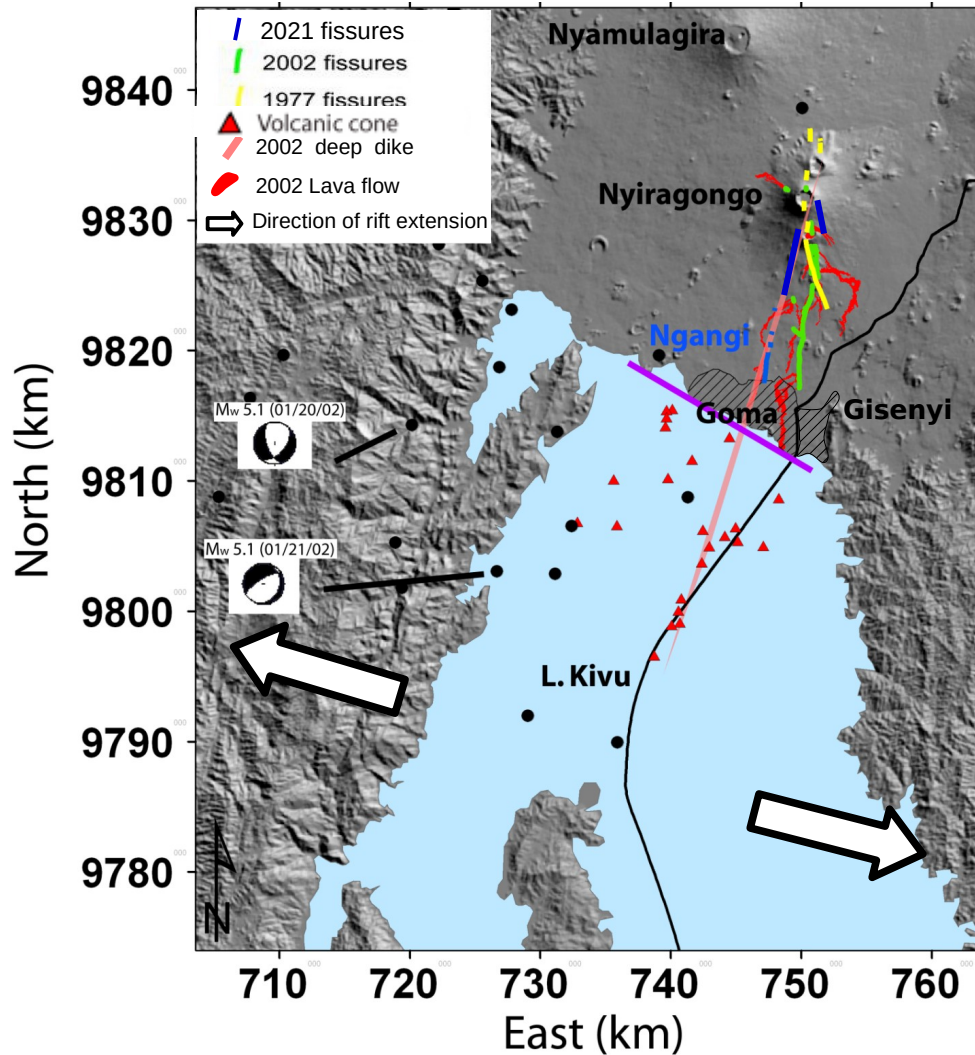

- A strato-volcano with a crater lava Lake



- Three historical eruptions in 1977, 2002 and 2021
- Associated fissures trend NS

# Model for Nyiragongo 2002 eruption

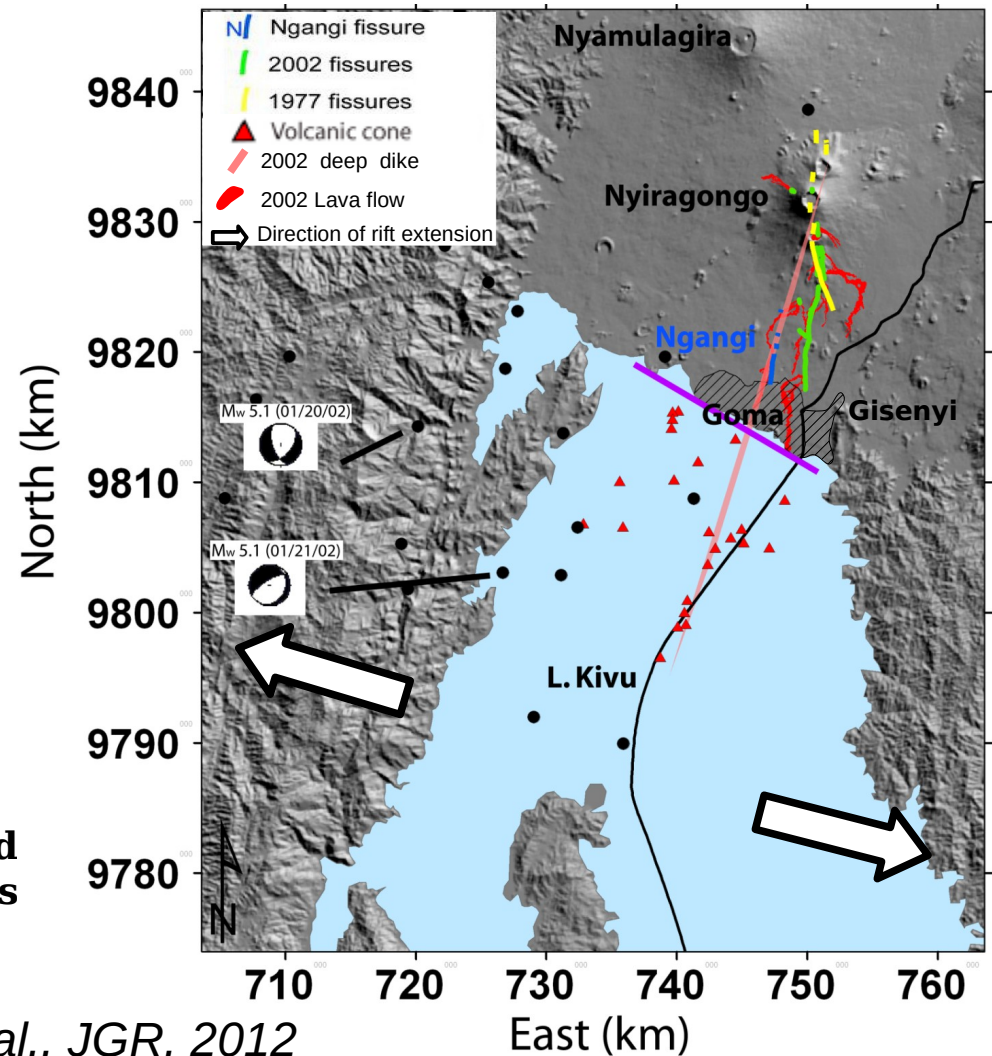
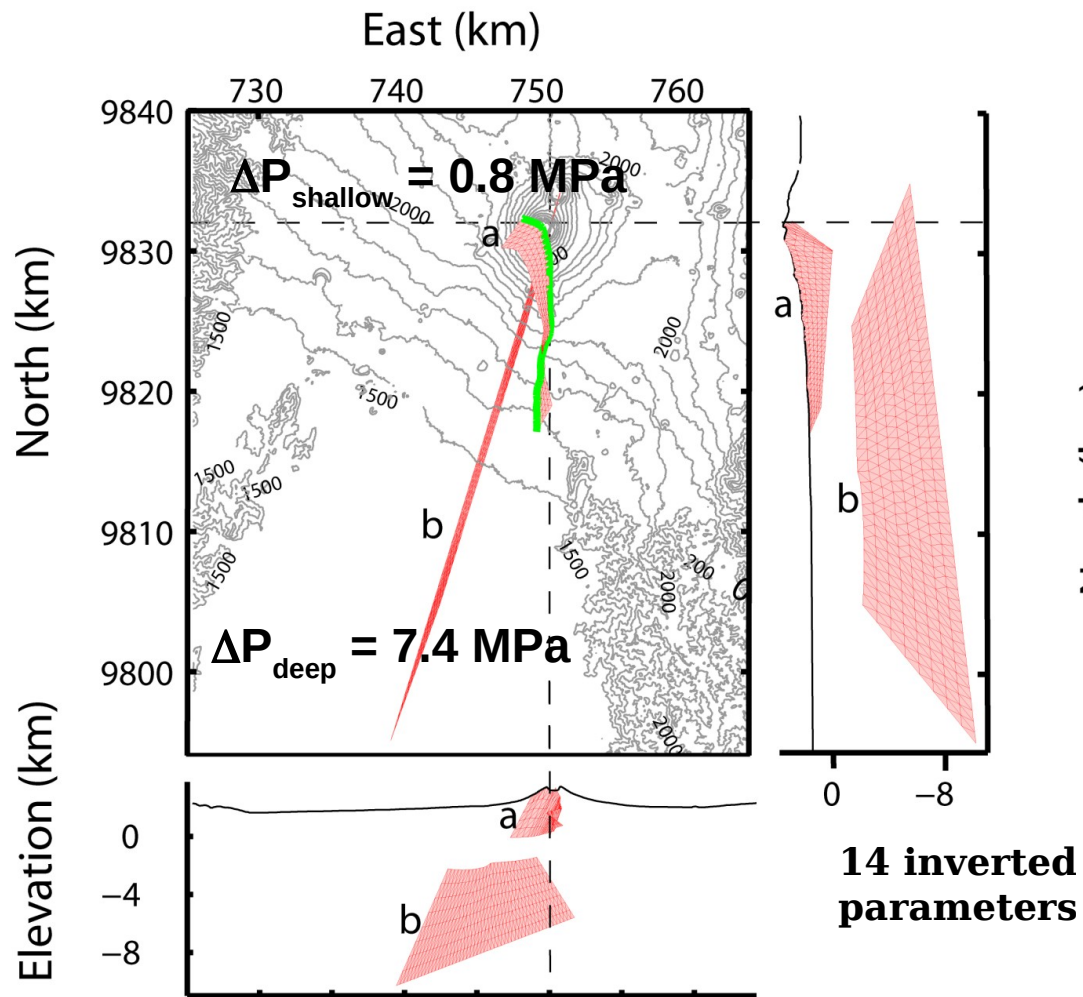

Wauthier et al., JGR, 2012

- The deep dike is perpendicular to the rift extension direction → Injection direction guided by the rift extension

# The may 2021 eruption confirms the small overpressure

InSAR data

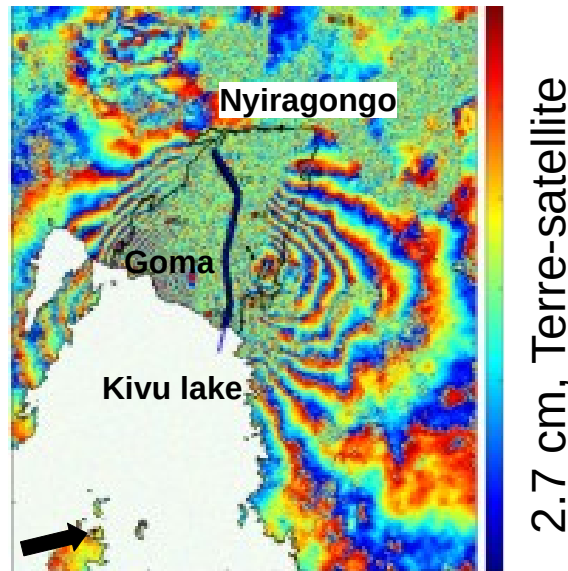

Model

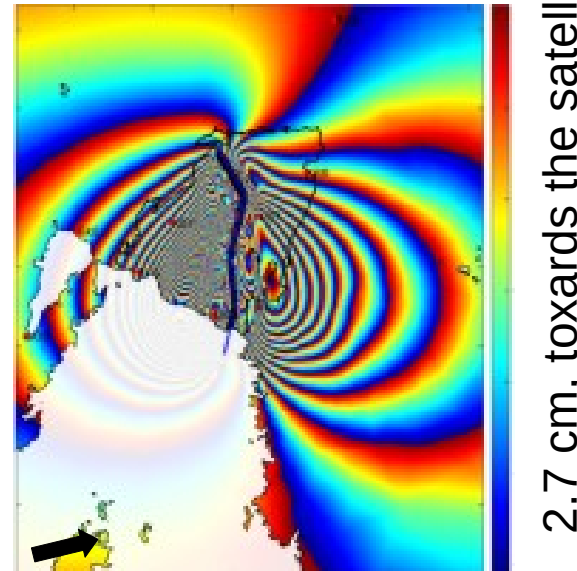

7 inverted parameters

$$\Delta P_{\text{shallow}} = 0.8 \text{ MPa}$$

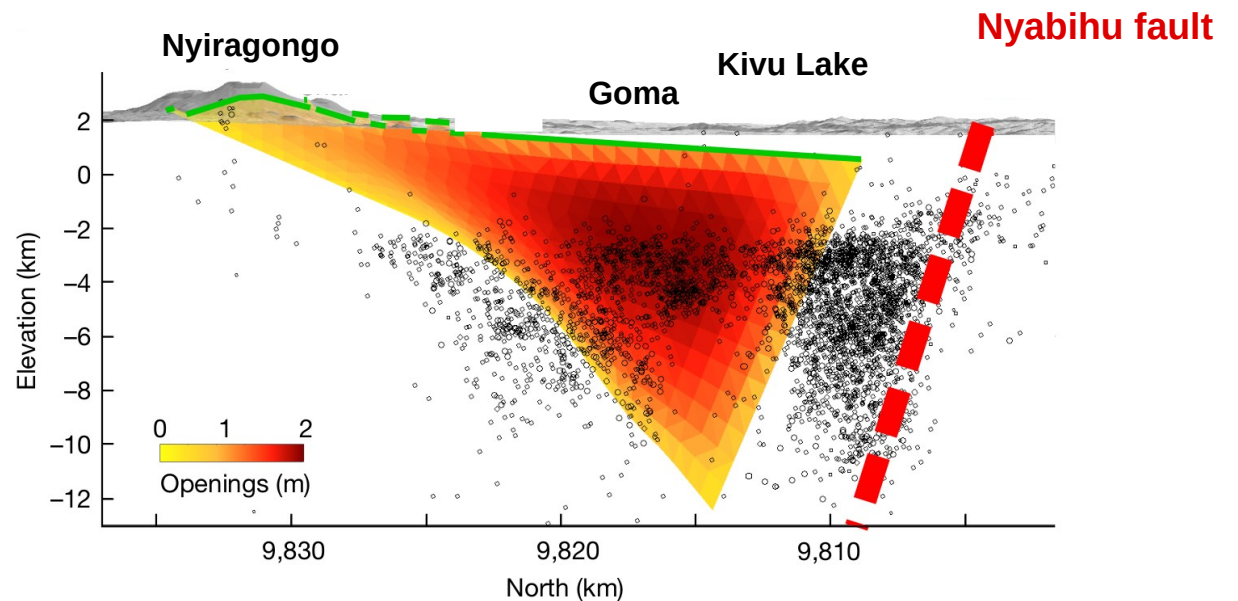

Smittarello et al., Nature, 2022

# A magma-assisted rift rextension

Overpressure from InSAR data inversion:

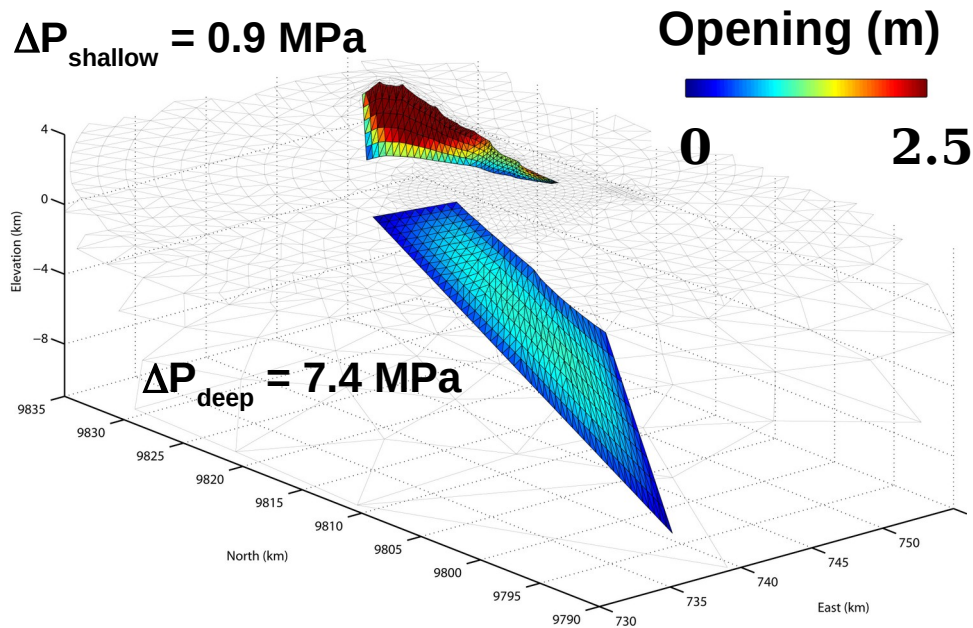

*Wauthier et al., JGR, 2012*

Overpressure theoretical model:

Assumption: crustal stresses are lithostatic ( $\sigma_h \sim \sigma_v \sim P_{\text{rock}}$ ),

$$\Delta P(z_{\text{dike}}) = P_{\text{magma}} - P_{\text{rock}} = \int (\rho_m - \rho_r(z)) g dz,$$

with:

we get  $\Delta P_{\text{Shallow}} \sim 1 \text{ MPa}$  and  $\Delta P_{\text{Deep}} = 4.5 \text{ MPa}$

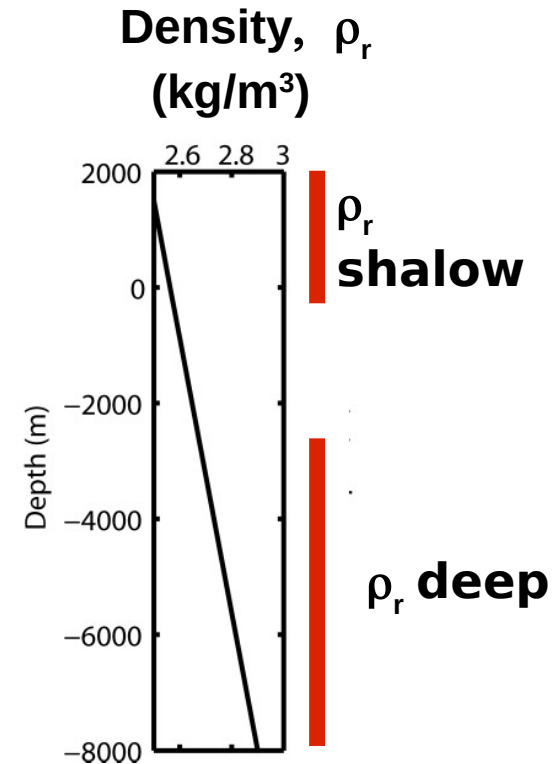

The crust is at a lithostatic stress state:  
Unconsistent with a rift extension driven by plate separation



The rift extension is driven by the magmatic activity

# What drives and accommodates rift extension in Kivu ?

Tectonic stresses ?

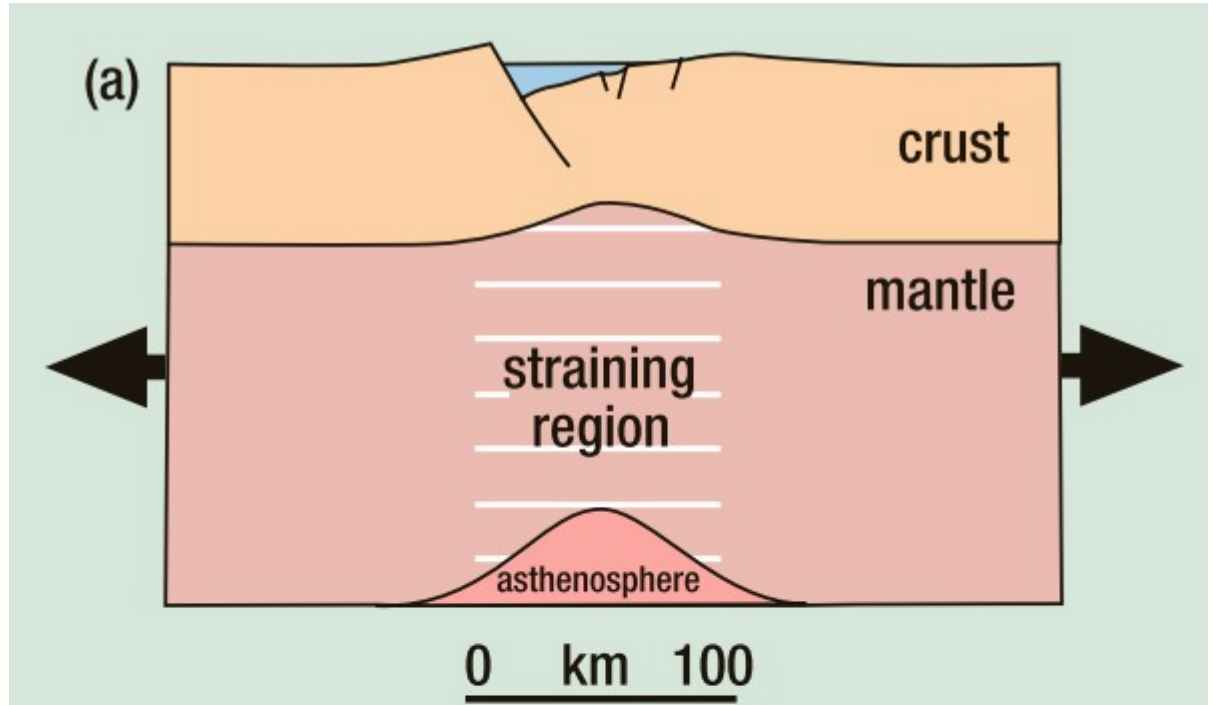

Magma assisted extension ?

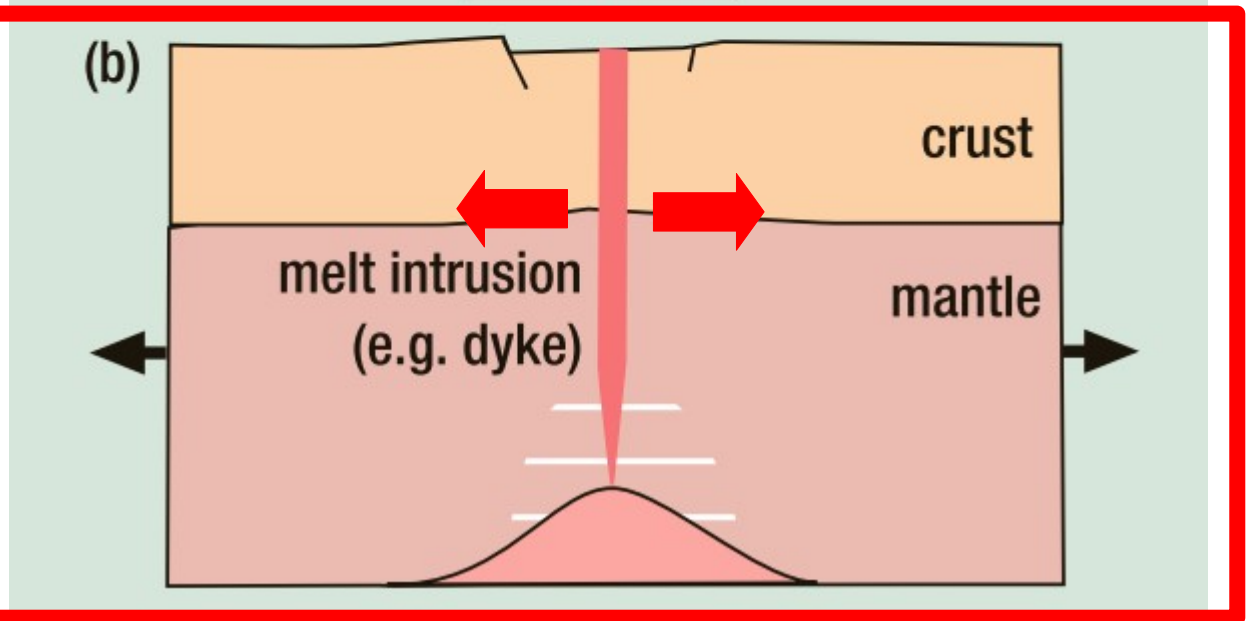

## **5. Examples**

### **5.2. Stress change inversion for flank failure mechanisms**

# Flank failures at Réunion Island

- Induce 24 % of volcano casualties world wide (tsunamis and large earthquakes)
- Ubiquitous at Réunion Island

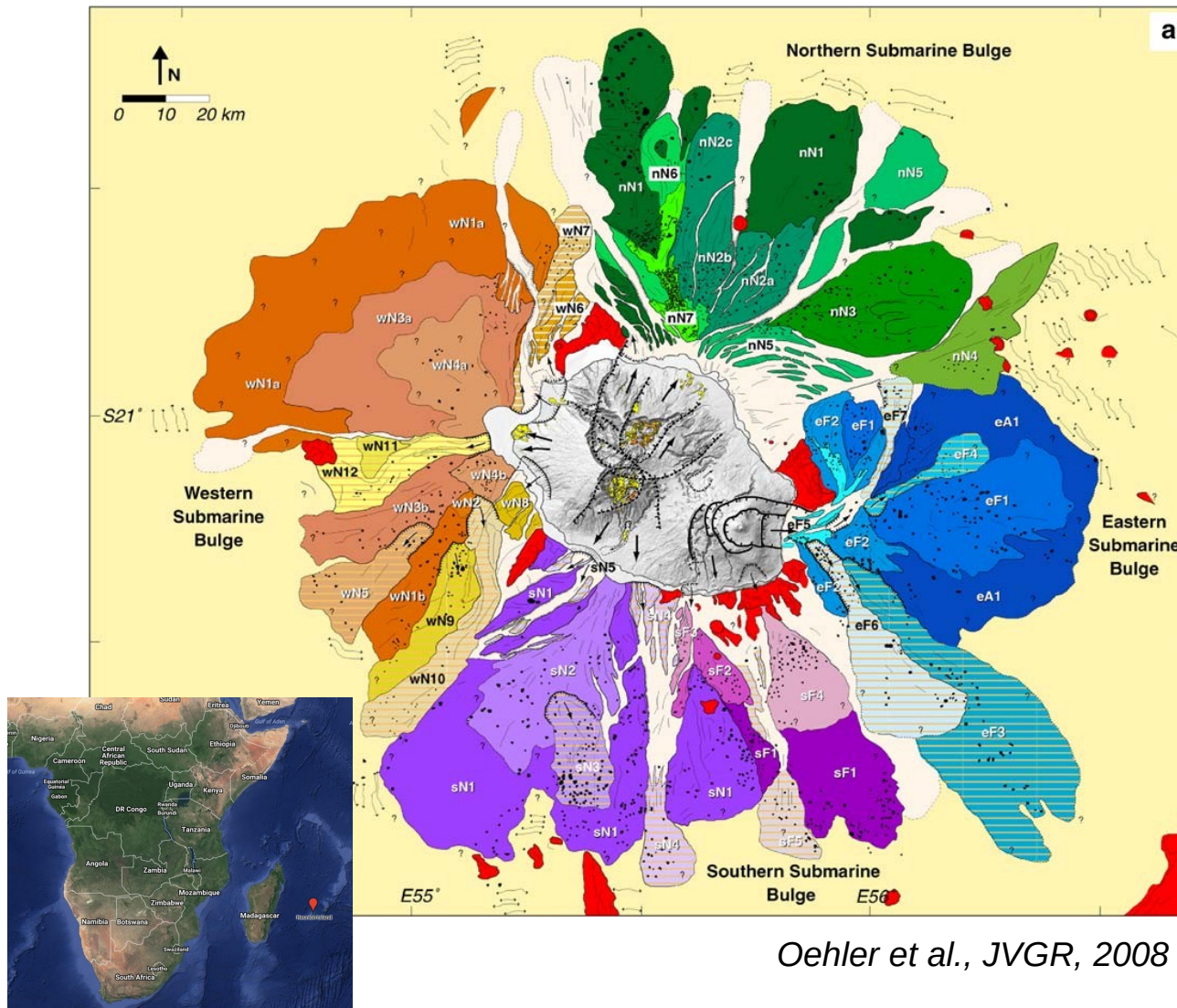

47 flank failure events  
Largest 100 km<sup>3</sup>  
Oldest 2 My

*Oehler et al., JVGR, 2008*

# Piton de la Fournaise is very active: 59 intrusions since 1998 (2.3/year)

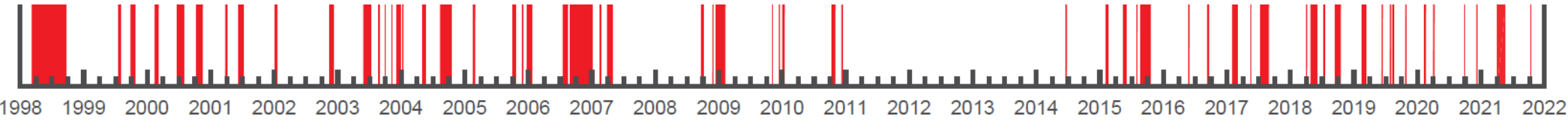

## Eruptive fissures : 1932 - 2020

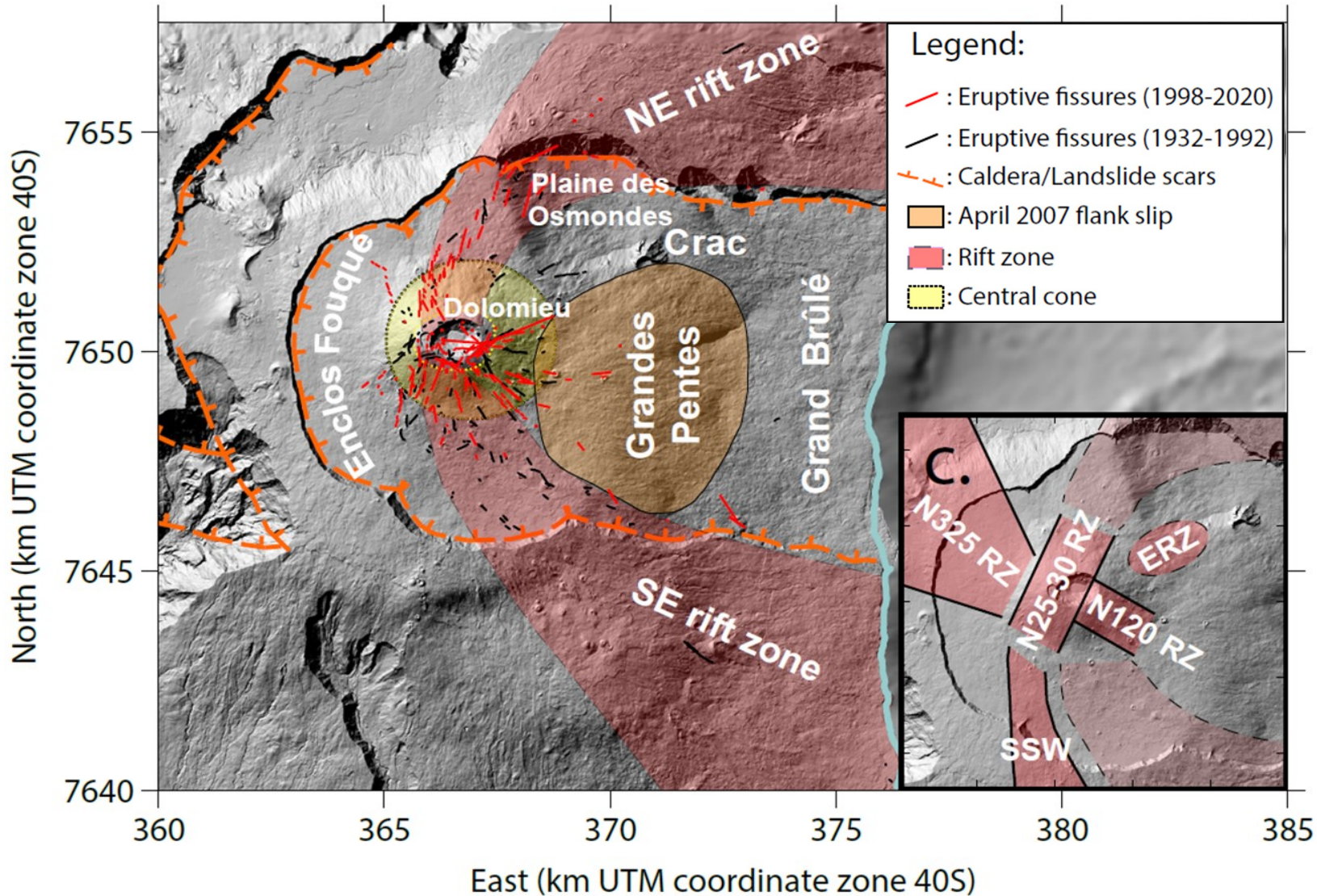



# Piton de la Fournaise is one of the best monitored volcanoes

- since 1998, 57/59 intrusions imaged by at least one InSAR data

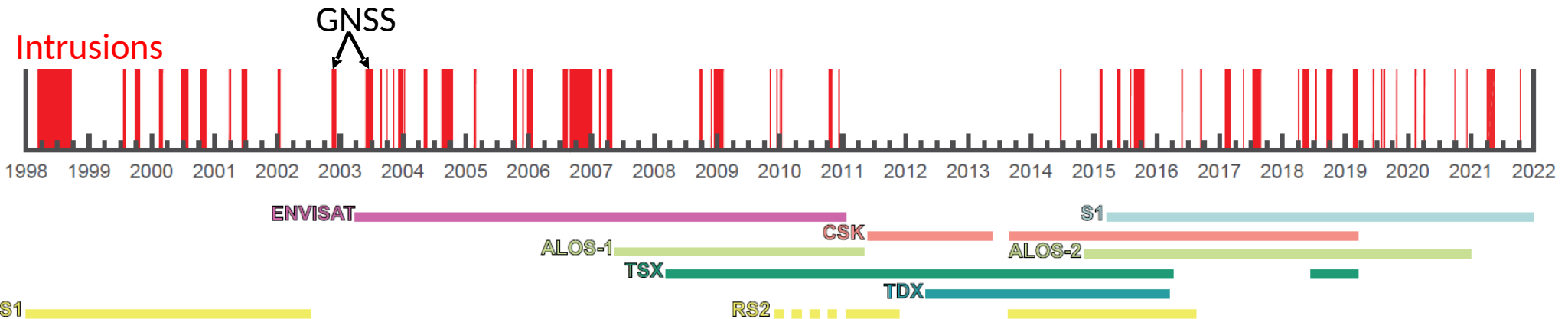

- GNSS campaign + continuous data can be used for non imaged eruptions

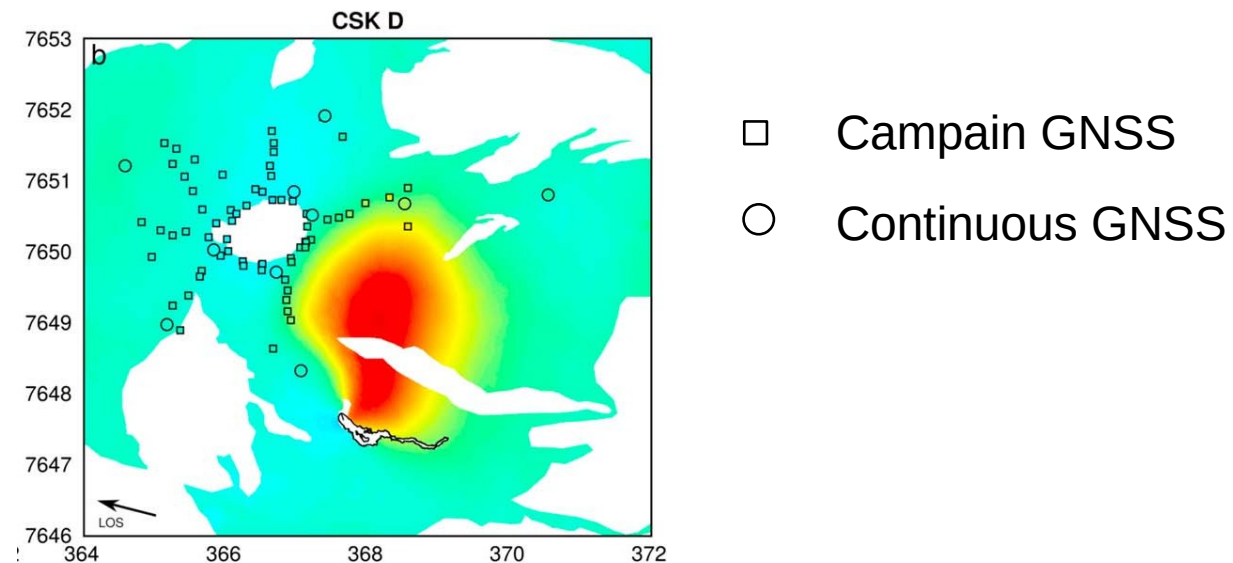

Smittarello et al., JGR, 2019

# An unusual flank displacement in 2007

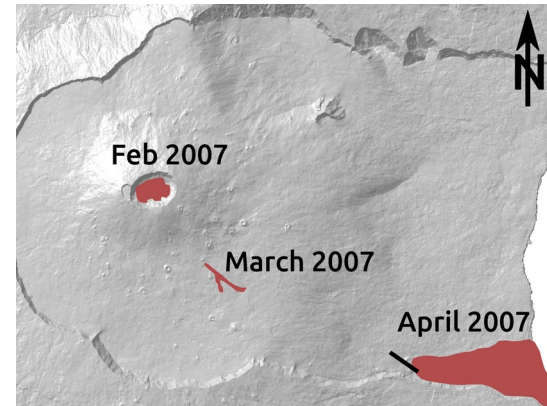
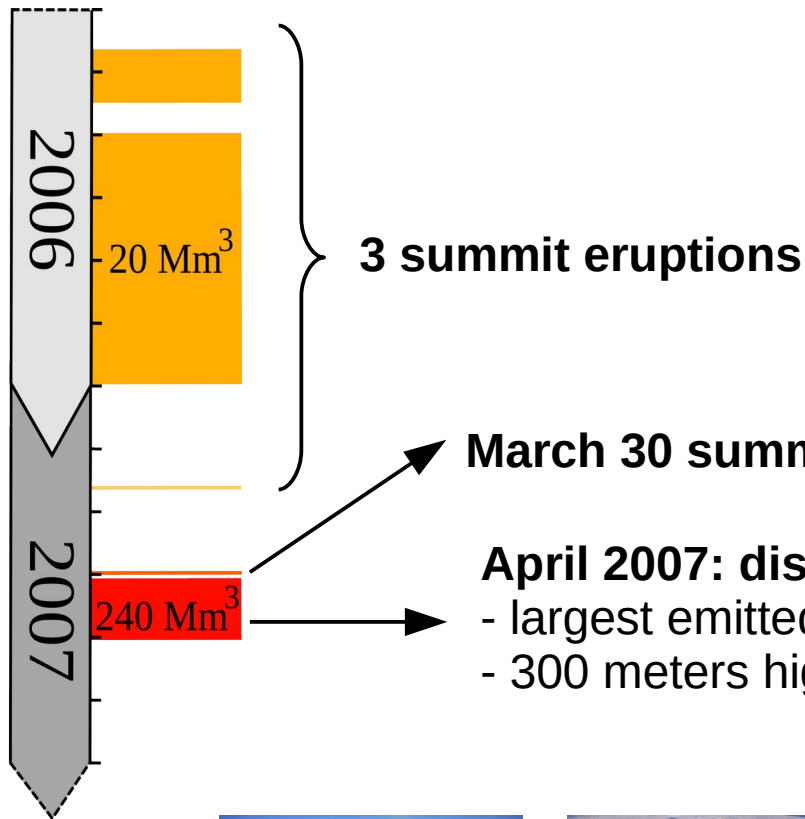

**March 30 summit eruption**

**April 2007: distal eruption**

- largest emitted volume of XX, XXI century = 240 Mm<sup>3</sup>
- 300 meters high caldera collapse on April 6



September 2006

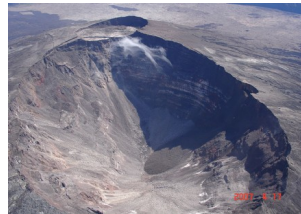

April 2007

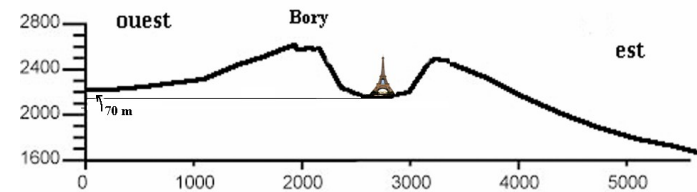

# An unusual flank displacement in 2007

## Co-eruptive displacement

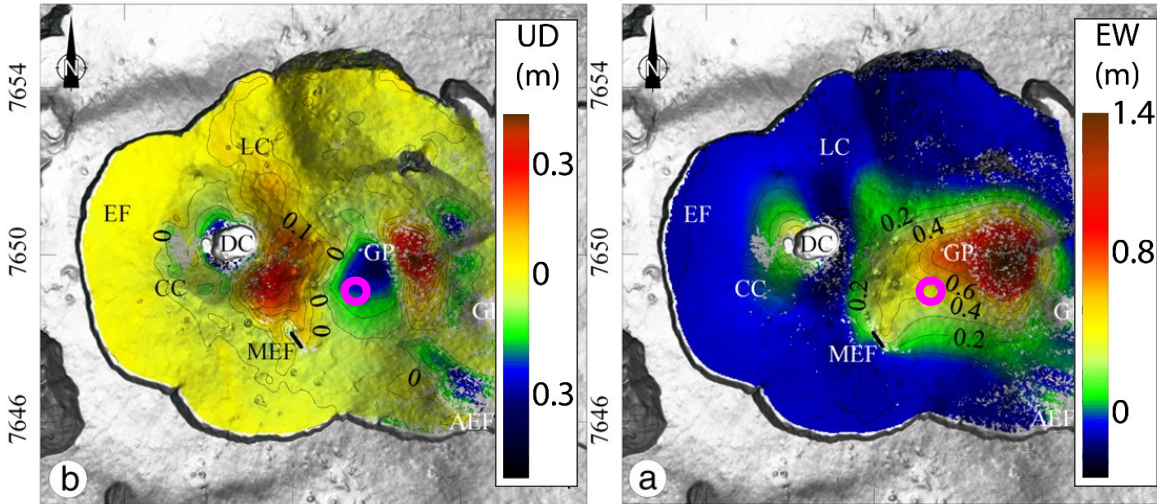

*Froger et al., JVGR, 2015*

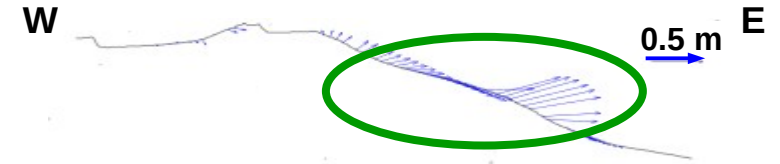

**1.4 m eastward / 0.37 m uplift**

## Long-term EW displacement

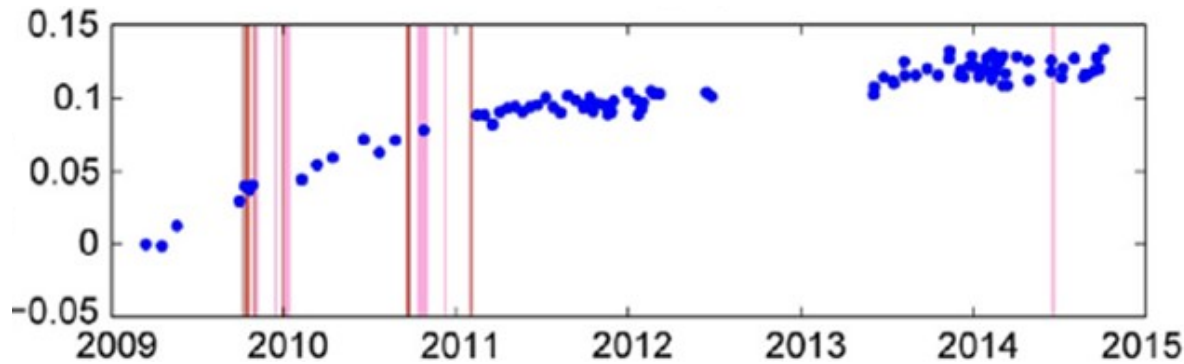

**1-2 cm/yr eastward and subsidence**

*Chen et al., Rem. Sens. Envir., 2017*

# Origin of the 2007 flank displacement

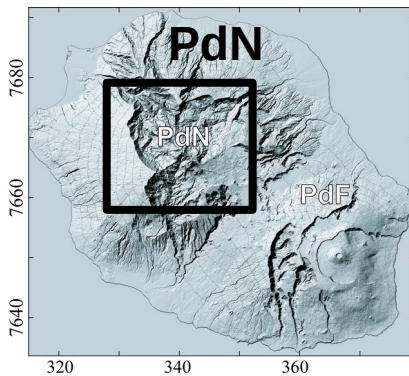
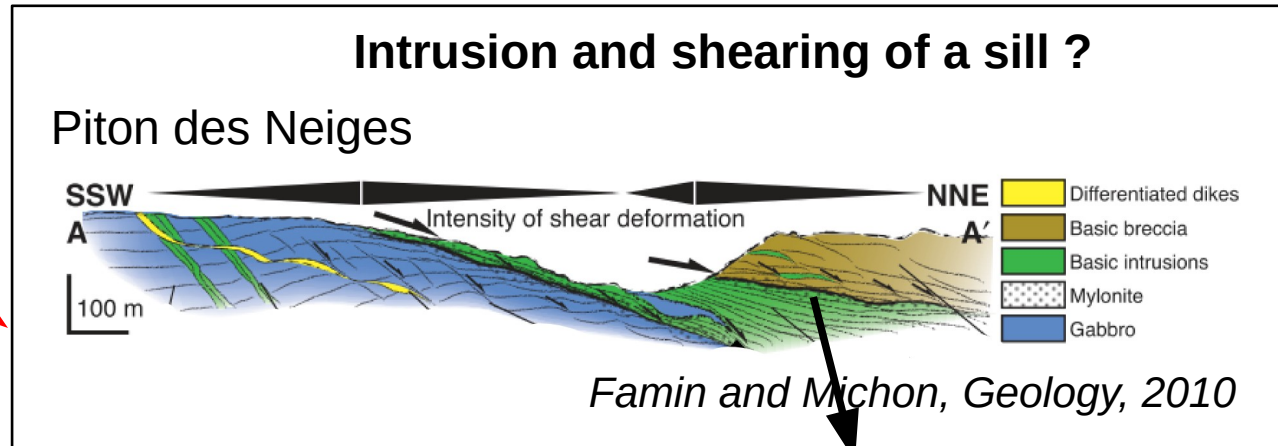
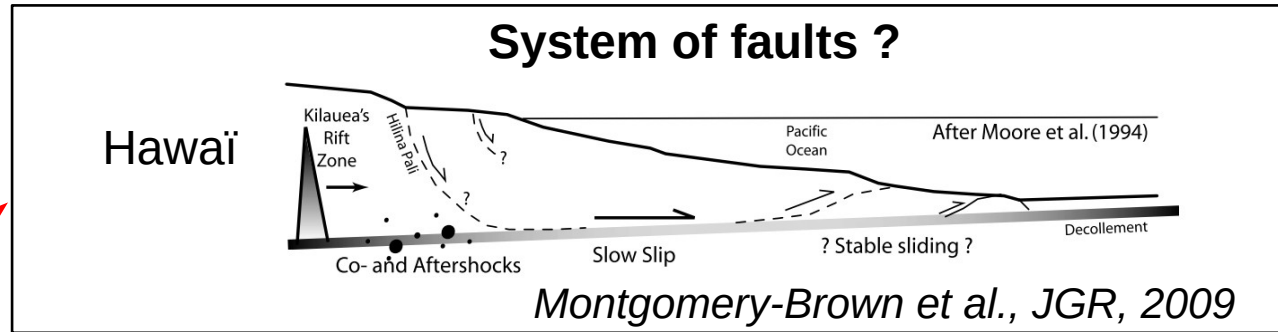
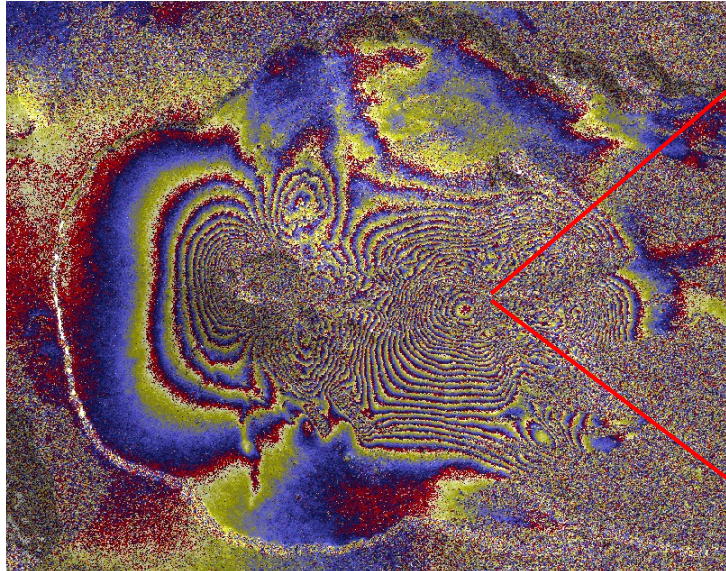

Evidence of shear ductile and brittle deformation



# Inverse modeling of 22 years of InSAR and GNSS data

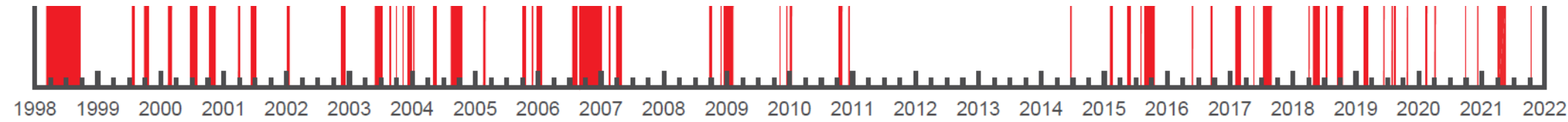

Best models

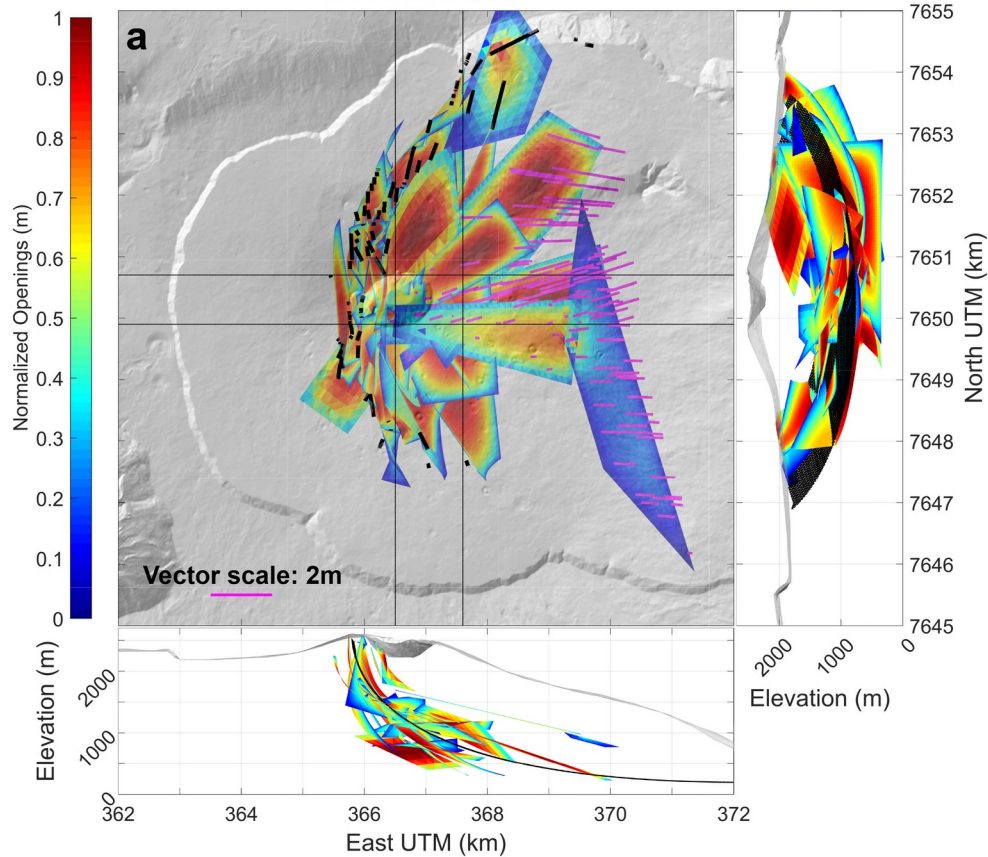

Models within 95% confidence interval

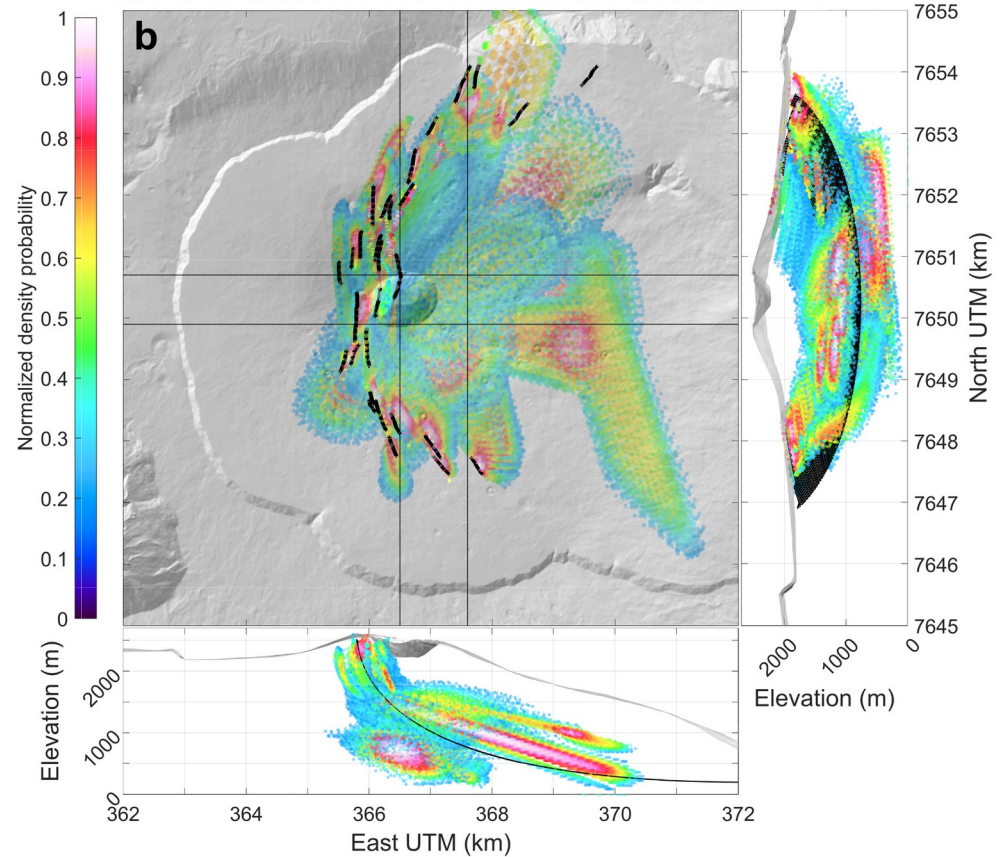

*Dumont et al., Nature Communication, 2023 ; EPSL, 2024*

➔ **80% of the magma intrudes in a spoon-shaped collapse structure**

# A major spoon-shaped collapse structure

*Dumont et al., Nature Communication, 2023 ; EPSL, 2024*

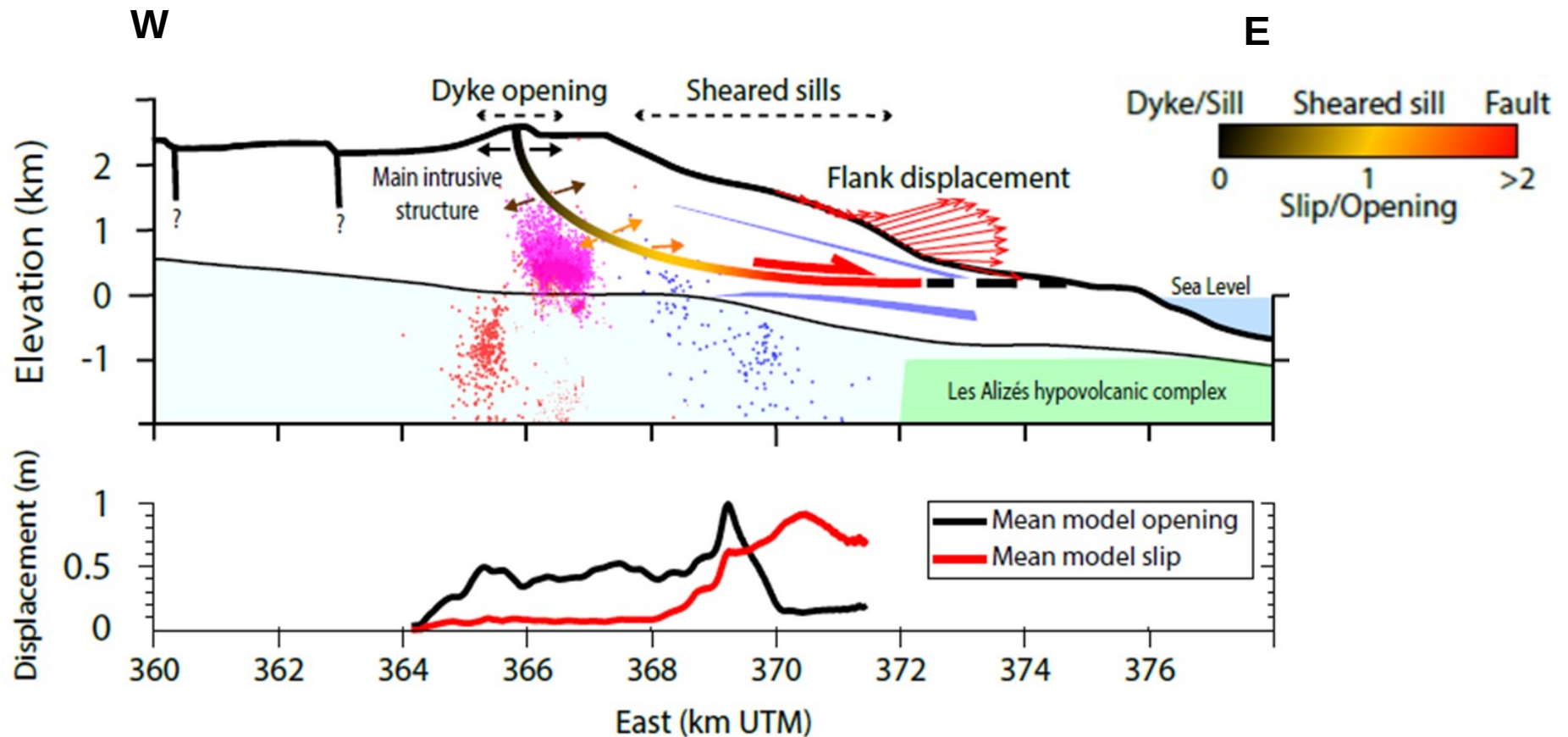

Continuum of displacements from west to east:

- **Pure opening** of subvertical curved dykes
- **Curved sheared sills**
- **Fault slip** in the easternmost part ( in 2007)

➡ Hybrid between previously assumed models;

➡ Could accommodate flank failure

# A similar structure may be active at Etna as evidence by the 2018 Christmas event

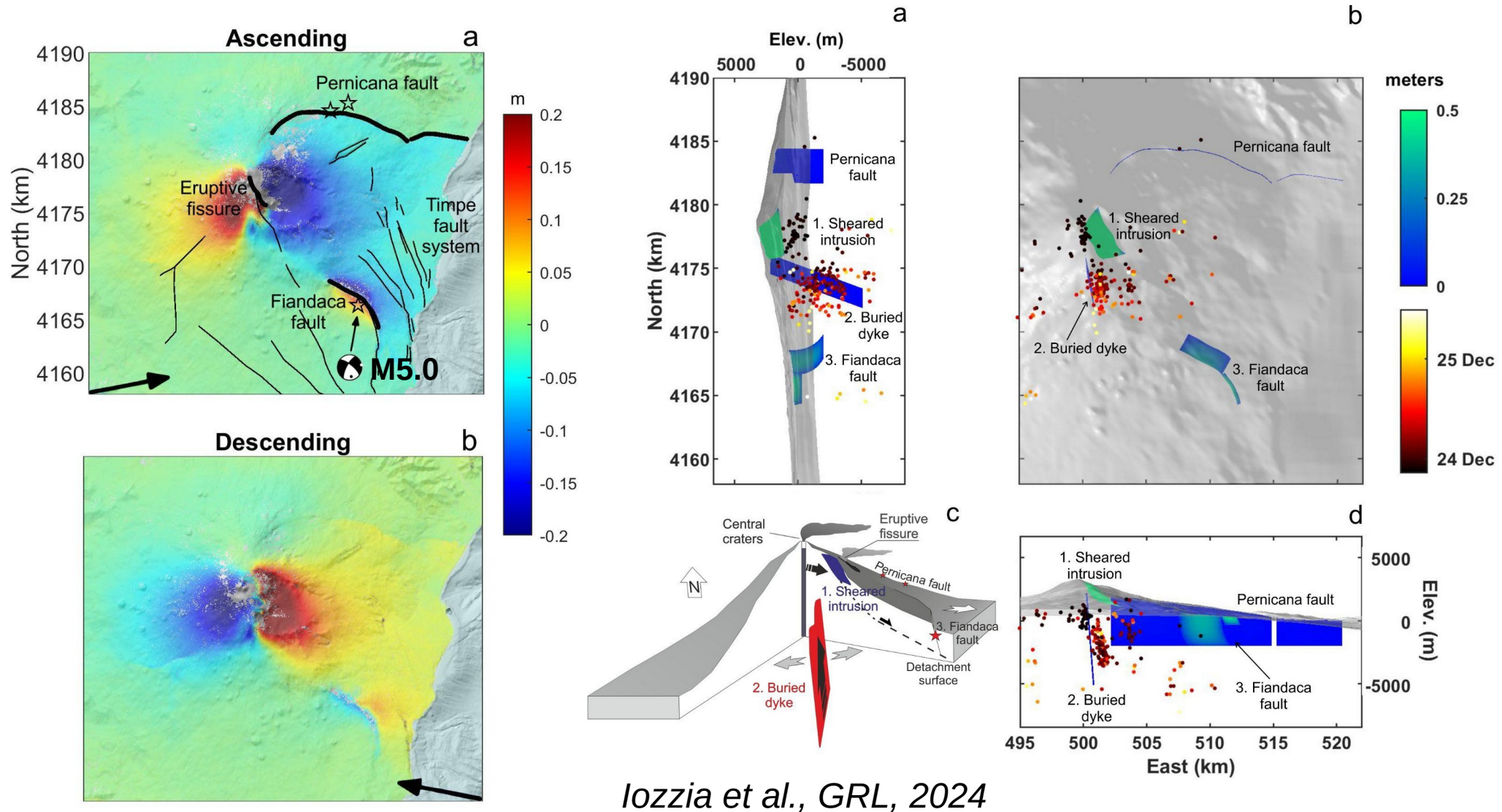

- A curved sheared intrusion and a buried dyke explain displacement close to the summit;
- Pernicana fault responded passively; Fiandaca fault released accumulated stress;

# What can be learnt from the Inverse modelling of InSAR data ?

## Rift extension drive

Wauthier et al., JGR, 2012

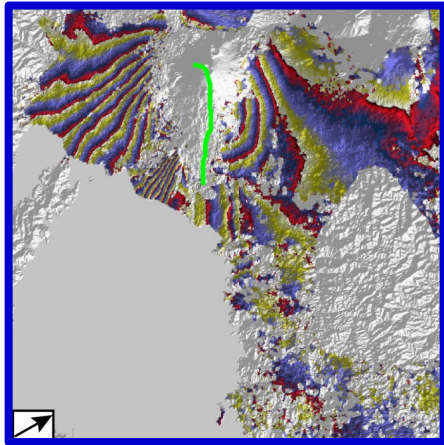

## Intrusion pathways

Bagnardi et al., EPSL, 2013

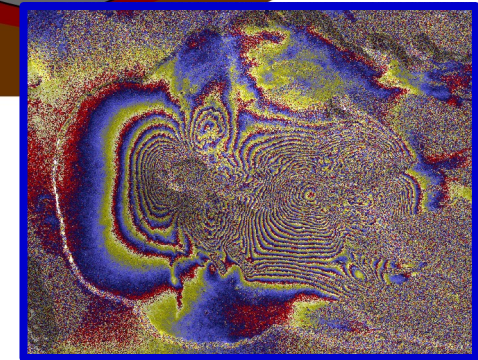
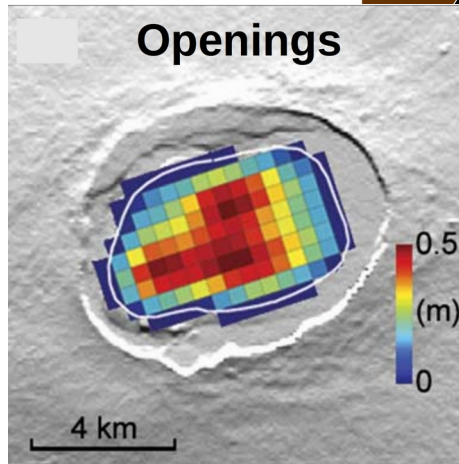
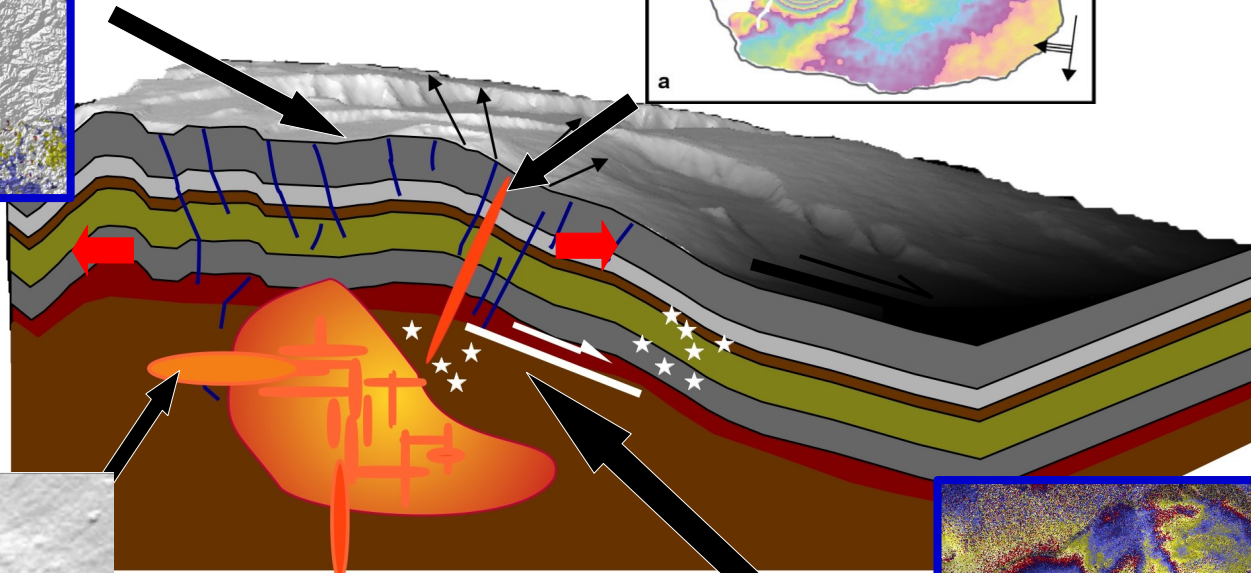
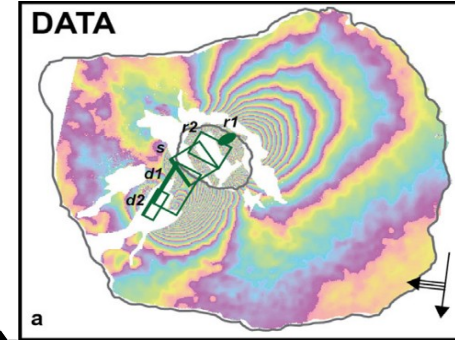

## Flank slip mechanism

Tridon et al., JGR, 2016;  
Dumont et al., Nat. comm., 2022.

## Characteristics of reservoirs

Amelung et al., Science, 2000



# Conclusions about inversions with stress boundary conditions

- Inverting for stress changes:
  - is more physical than kinematic inversions;
  - leads to more likely models;
  - is more informative.
- In the **Virunga Volcanic Province**, the **rift extension** is driven by **magmatic activity** rather than plate extension;
- At **Piton de la Fournaise**, we find a continuum of fracture displacement: **dike** intrusion -> **sheared intrusions** -> **fault slip** that accommodates magma intrusions;
- Sheared intrusions also seem to be active at **Etna**.
- Sheared intrusions should be searched at other shield volcanoes with evidence of flank slip

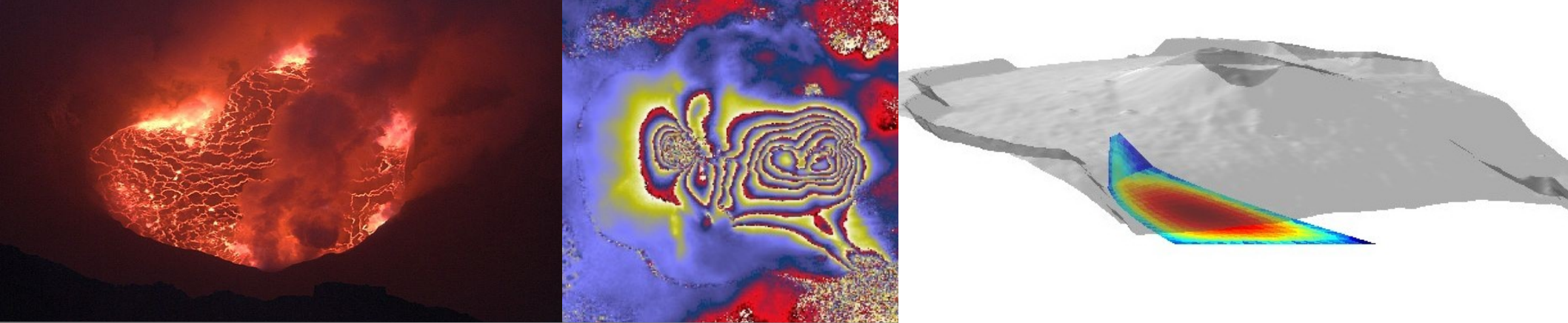

# Thank you for your attention !

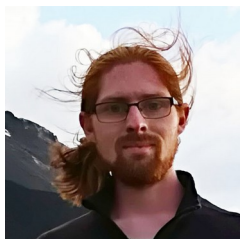

Quentin Dumont



Christelle Wauthier



Yo Fukushima



Gilda Currenti



Jean-Luc Froger



Adriana Iozzia



Marine Tridon



PennState  
College of Earth  
and Mineral Sciences

