



HAL
open science

Coupled non-destructive methods, Scanning Electron Microscopy, Kelvin Force Probe microscopy and μ -Raman to characterize doping in 4H-SiC power devices

Enora Vuillermet, Kuan-Ting Wu, Anaël Sédilot, Régis Deturche, Nicolas Bercu, Elise Usureau, Jérémie Béal, Mihai Lazar

► To cite this version:

Enora Vuillermet, Kuan-Ting Wu, Anaël Sédilot, Régis Deturche, Nicolas Bercu, et al.. Coupled non-destructive methods, Scanning Electron Microscopy, Kelvin Force Probe microscopy and μ -Raman to characterize doping in 4H-SiC power devices. 5e édition des French Photonics Days, Oct 2023, Strasbourg, France. hal-04618679

HAL Id: hal-04618679

<https://hal.science/hal-04618679>

Submitted on 20 Jun 2024

HAL is a multi-disciplinary open access archive for the deposit and dissemination of scientific research documents, whether they are published or not. The documents may come from teaching and research institutions in France or abroad, or from public or private research centers.

L'archive ouverte pluridisciplinaire **HAL**, est destinée au dépôt et à la diffusion de documents scientifiques de niveau recherche, publiés ou non, émanant des établissements d'enseignement et de recherche français ou étrangers, des laboratoires publics ou privés.

Coupled non-destructive methods, Scanning Electron Microscopy, Kelvin Force Probe microscopy and μ -Raman to characterize doping in 4H-SiC power devices

E. Vuillermet¹, K.T Wu¹, A. Sédilot¹, R. Deturche¹, N. Bercu², E. Usureau¹, J. Béal¹, M. Lazar¹

¹L2n, CNRS EMR 7004, University of Technology of Troyes, Troyes, France

²LRN, U.F.R Sciences exactes et naturelles, University of Reims Champagne-Ardenne, Reims, France

SiC and power devices

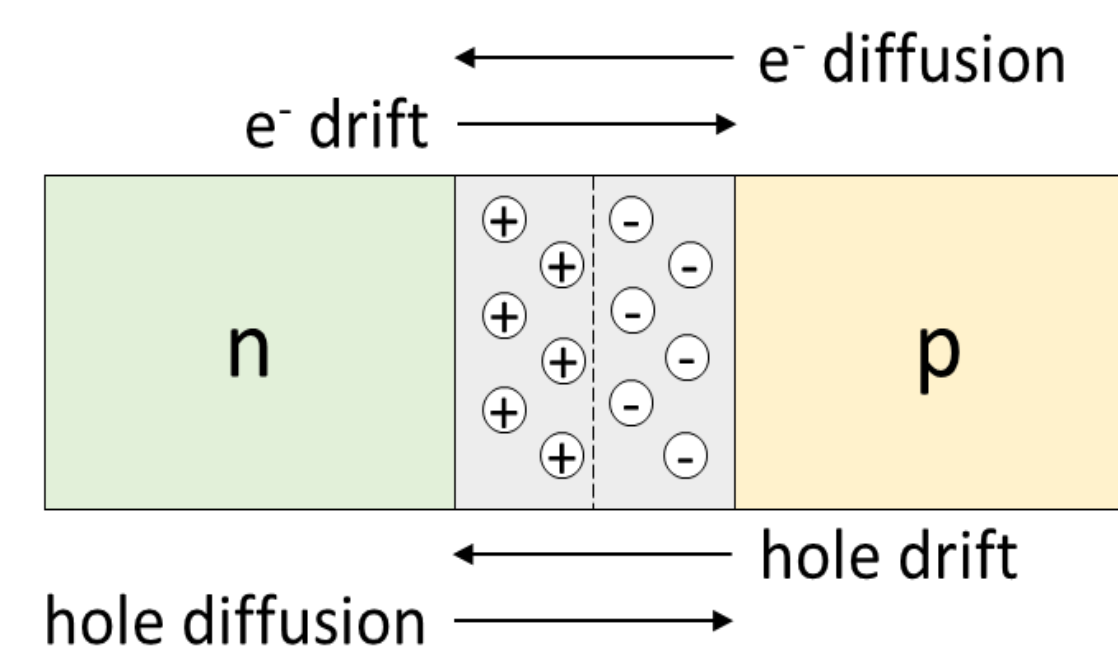
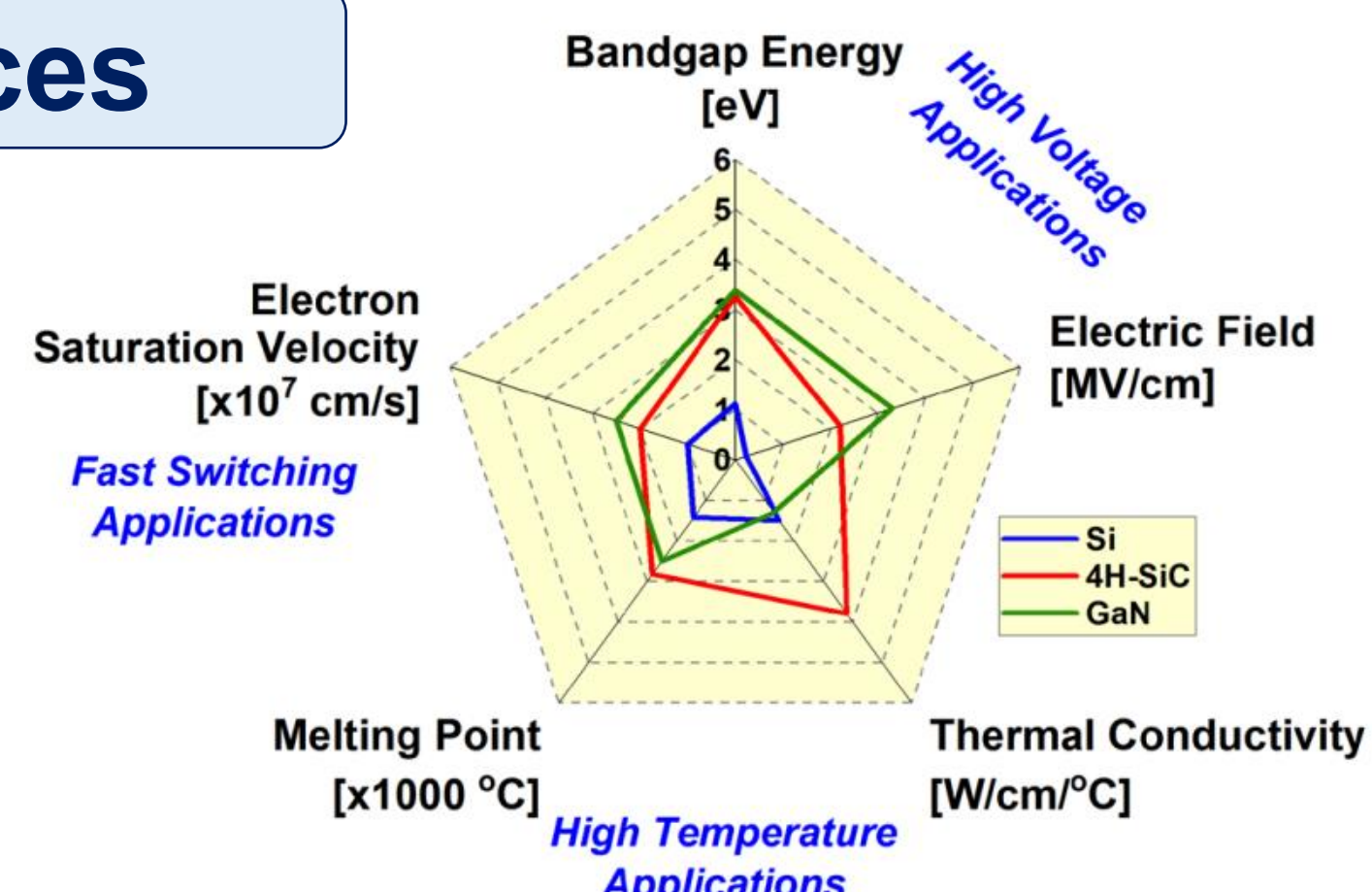
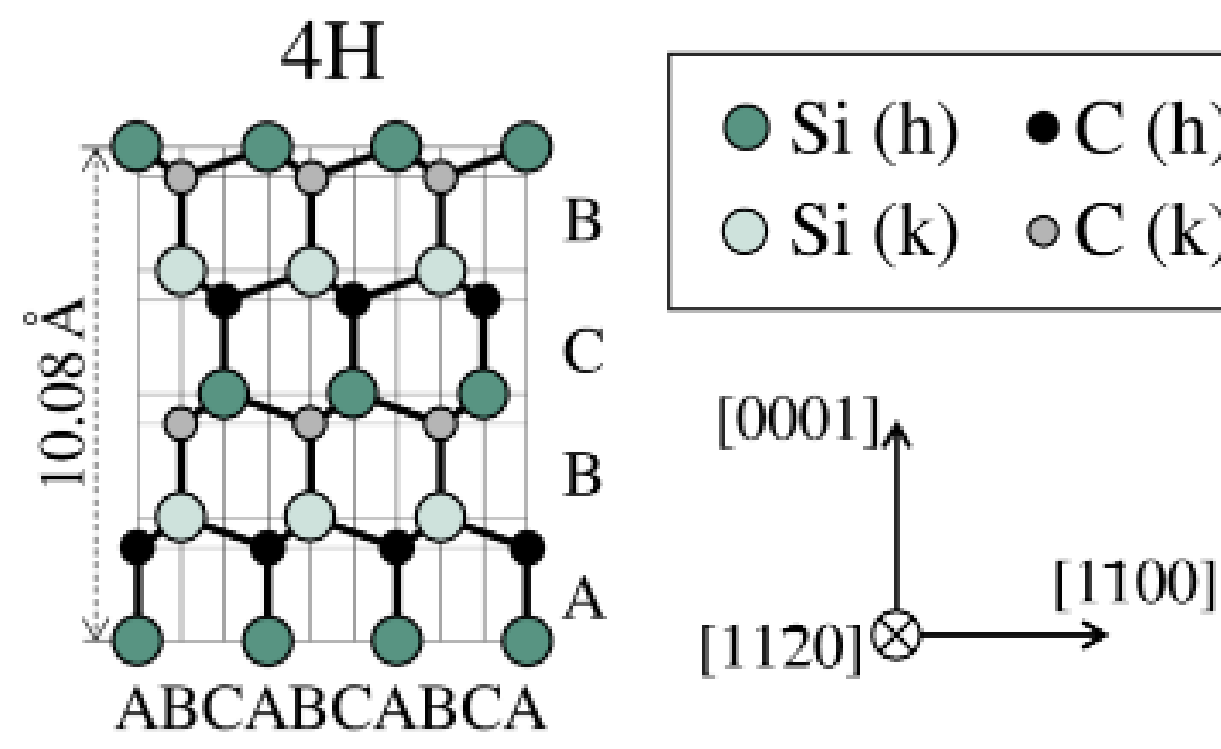

n and p-type doping possible with introduction of nitrogen or aluminum
Formation of p-n junction : power devices fabrication \rightarrow diodes, JFETs, MOSFETs...

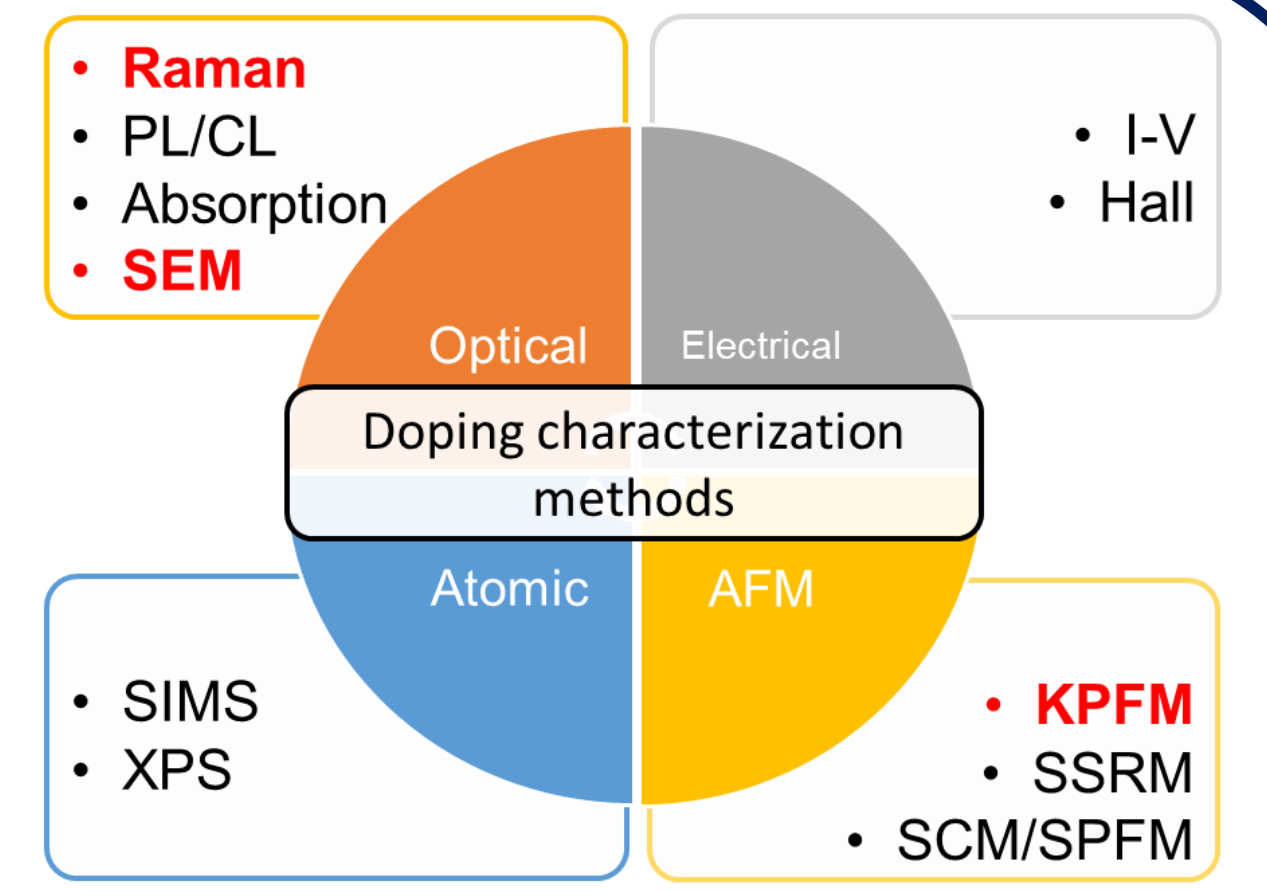

Local doping : manages the equipotential distribution in the surface [3], [4]

Objective : Non-destructive local characterization of doping by SEM, μ -Raman and KPFM

✓ Localization of doped areas

✓ Verification of surface potential distribution

Power devices fabrication

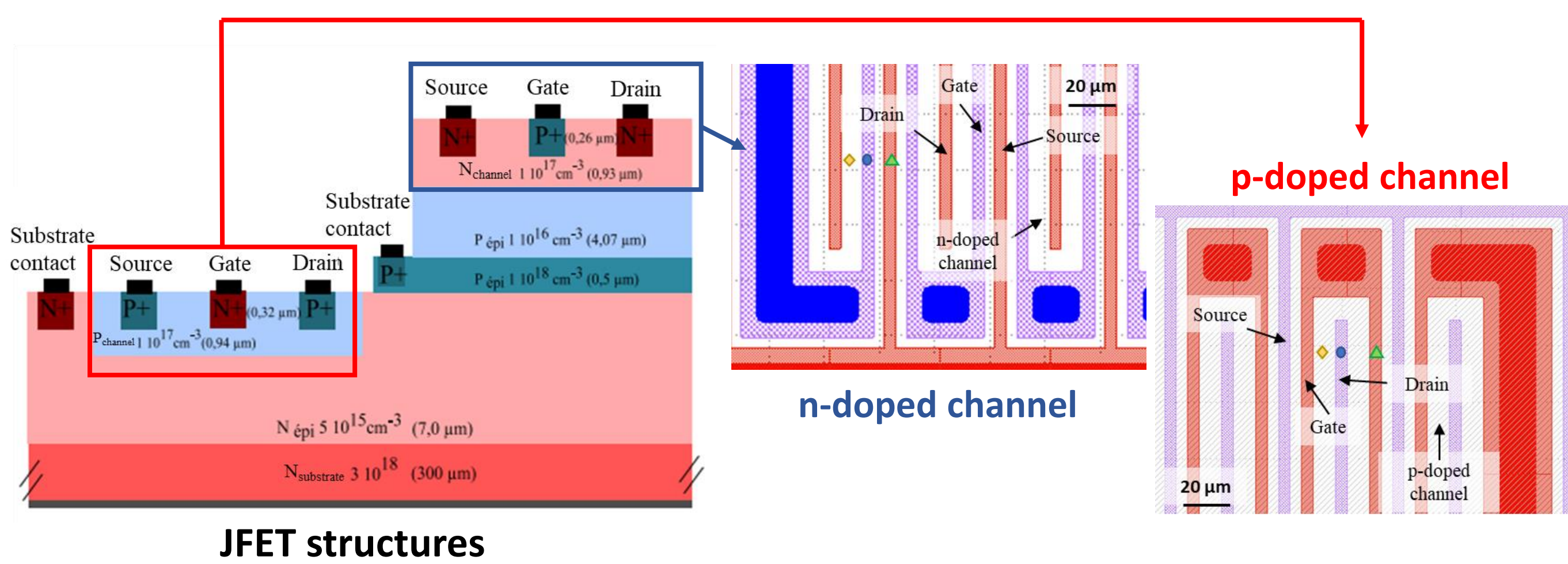

JFET structures

- **Junction Field Effect Transistors (JFETs)** : the bias applied between the gate and the substrate control the current flow between the source and the drain [5]
- Applications as buffer amplifiers, electronic switches or voltage variable resistors

Characterization methods

Hitachi SU-8030 FEG-SEM

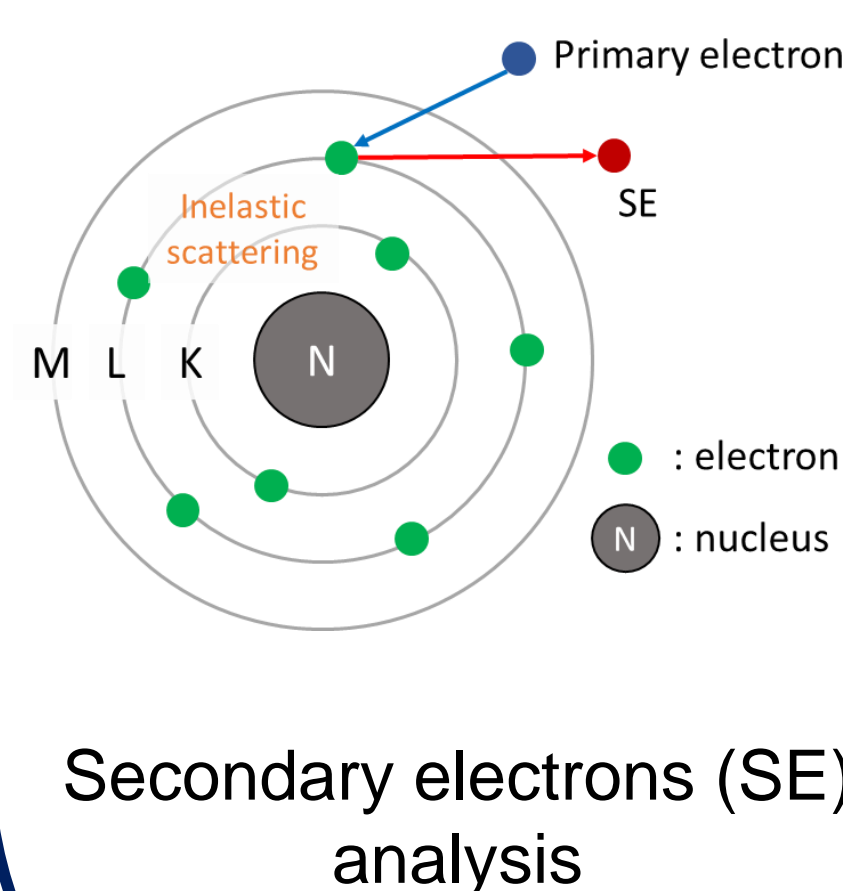
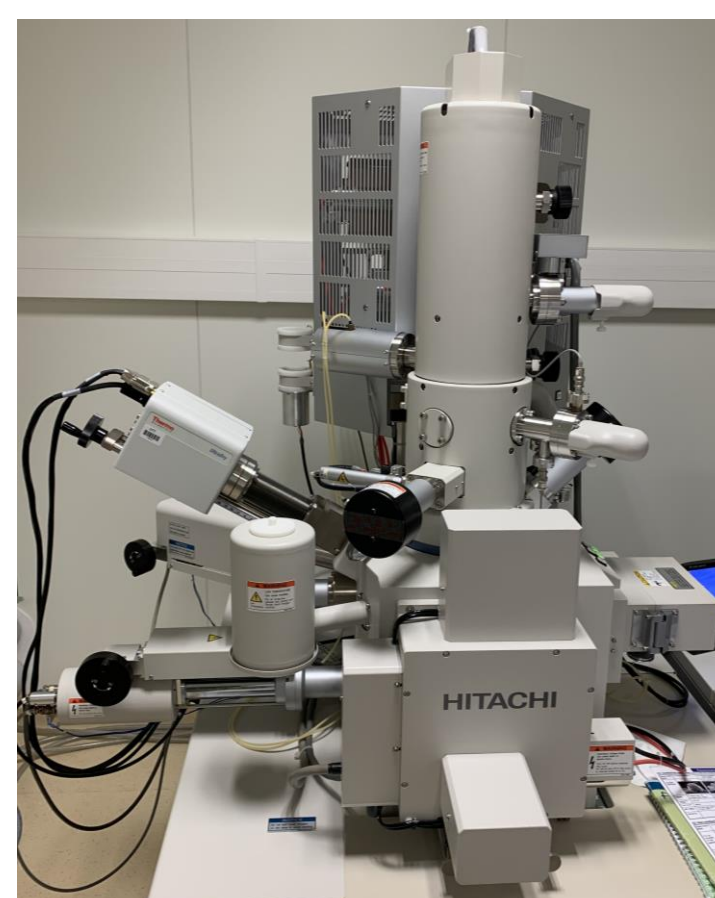

Secondary electrons (SE) analysis

Labram HR Evolution Raman microscope

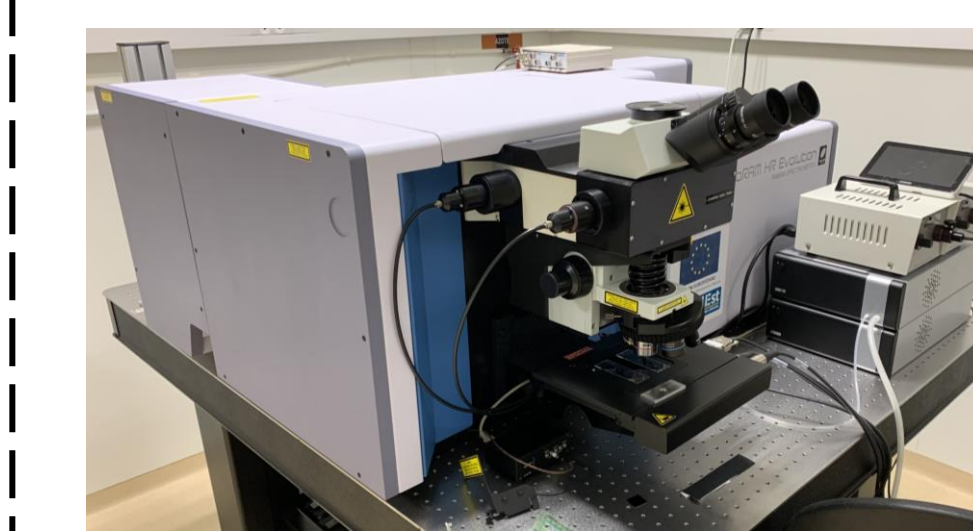

- Objective x40
- Grating 1800g/mm
- Laser 325nm

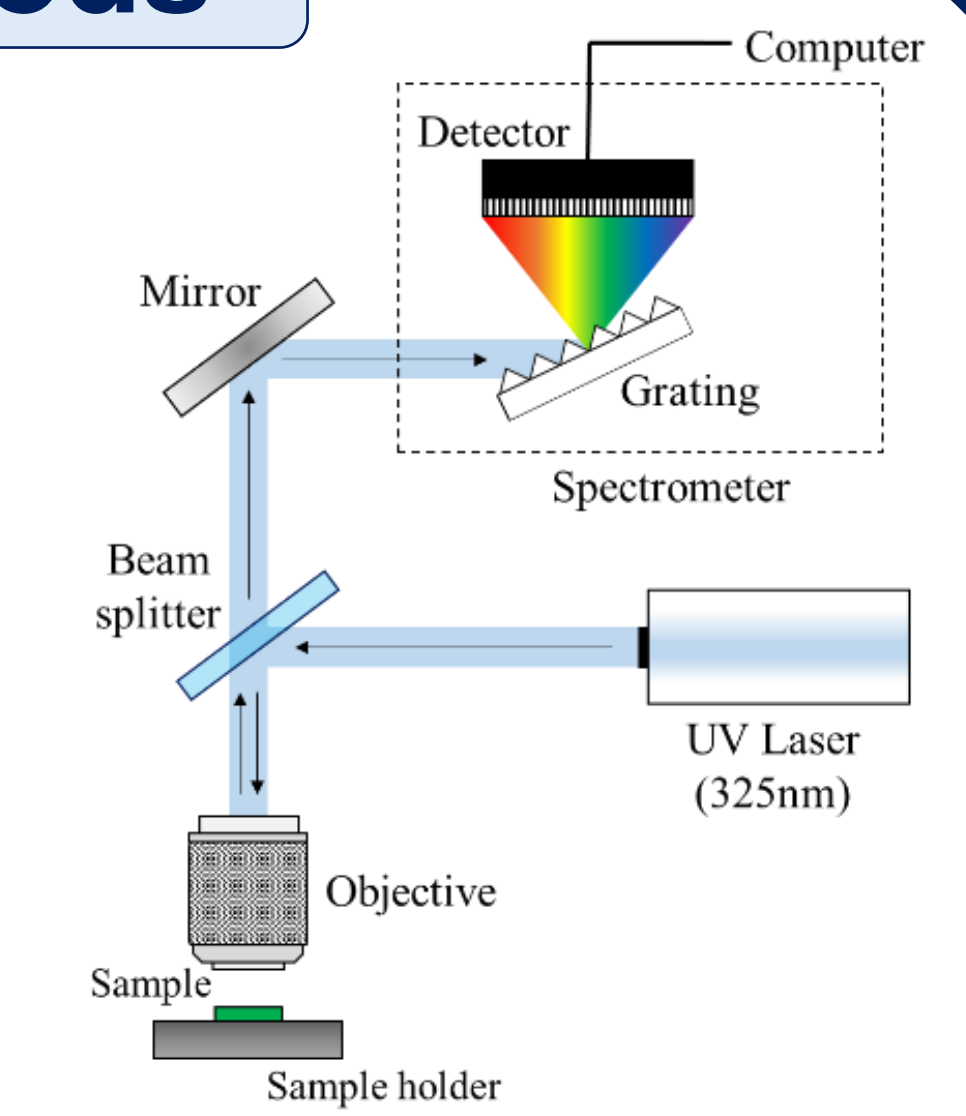

Dimension Icon AFM : FM-KPFM mode

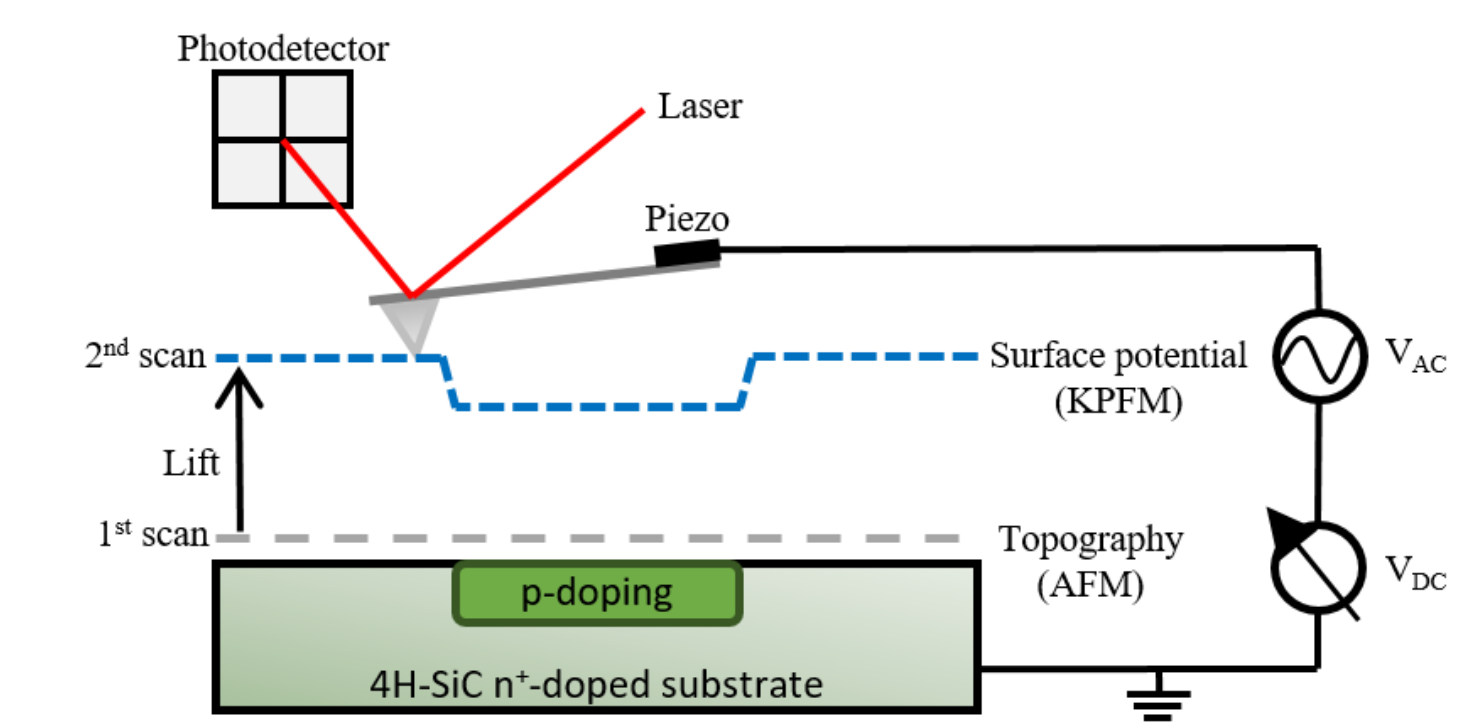

- Measures the **contact potential difference (CPD)** between the AFM tip and the sample's surface [7]
- Peak Force Tapping mode associated to FM-KPFM
- SCM-PIT-V2 tips
- Low-speed scanning < 0,1Hz

Raman spectra

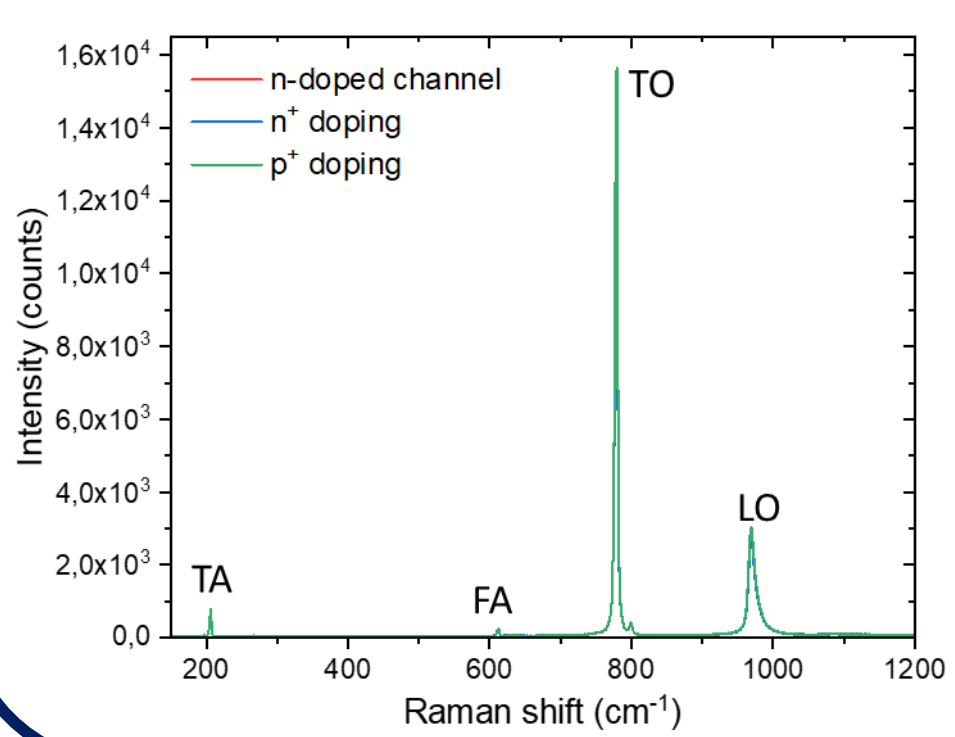

Doping influences the intensity and width of 4H-SiC LO peak [6]

We look at the height variation of the LO peak

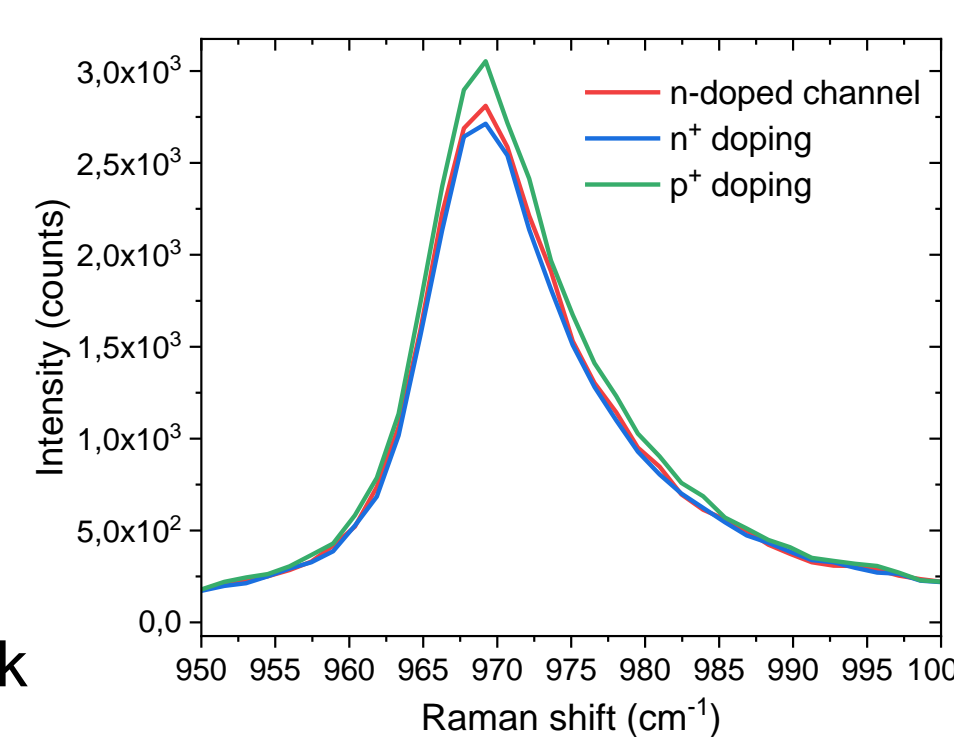

Secondary electrons (SE) analysis

Mappings

Optical microscope (x5)

n-type JFET

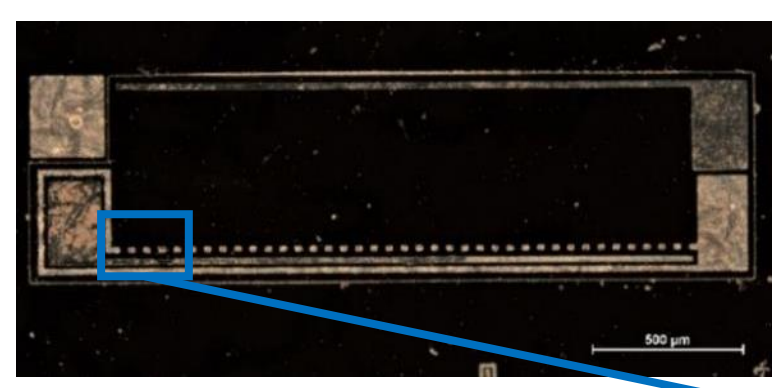

p-type JFET

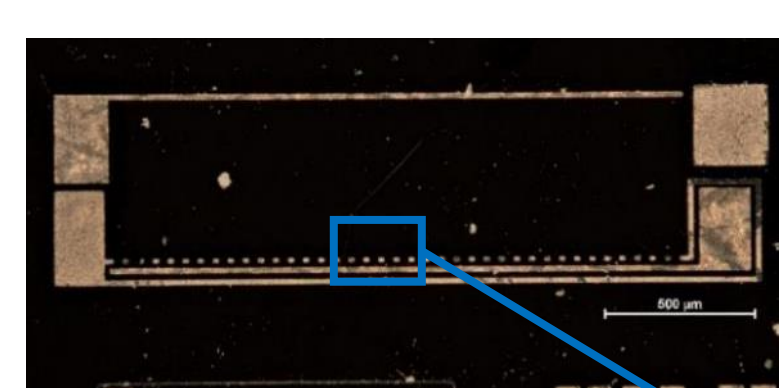

SEM images

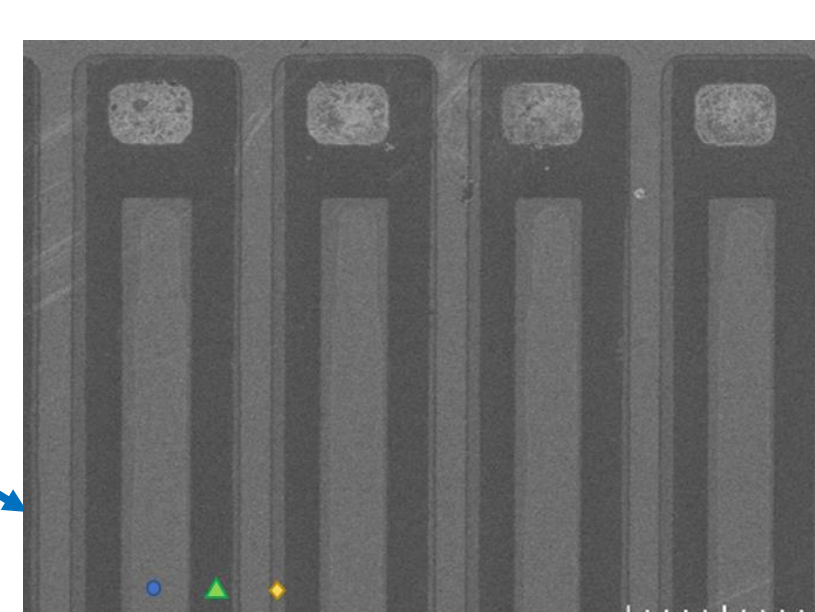
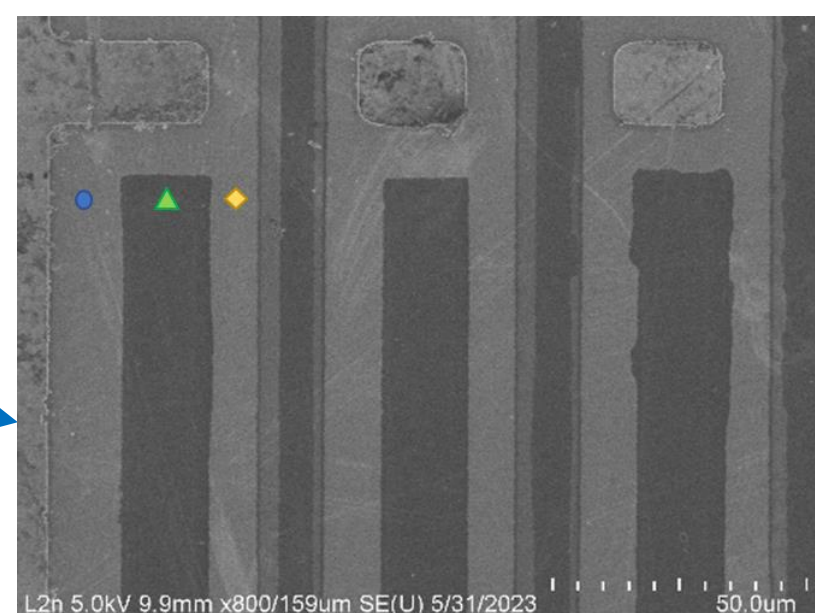

KPFM

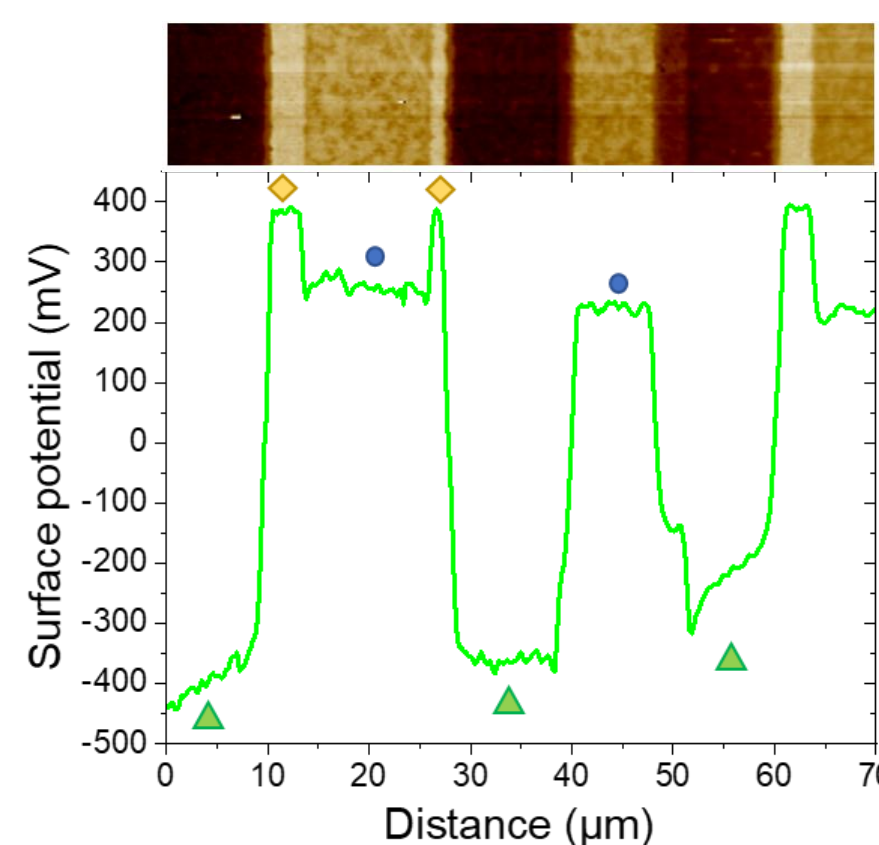
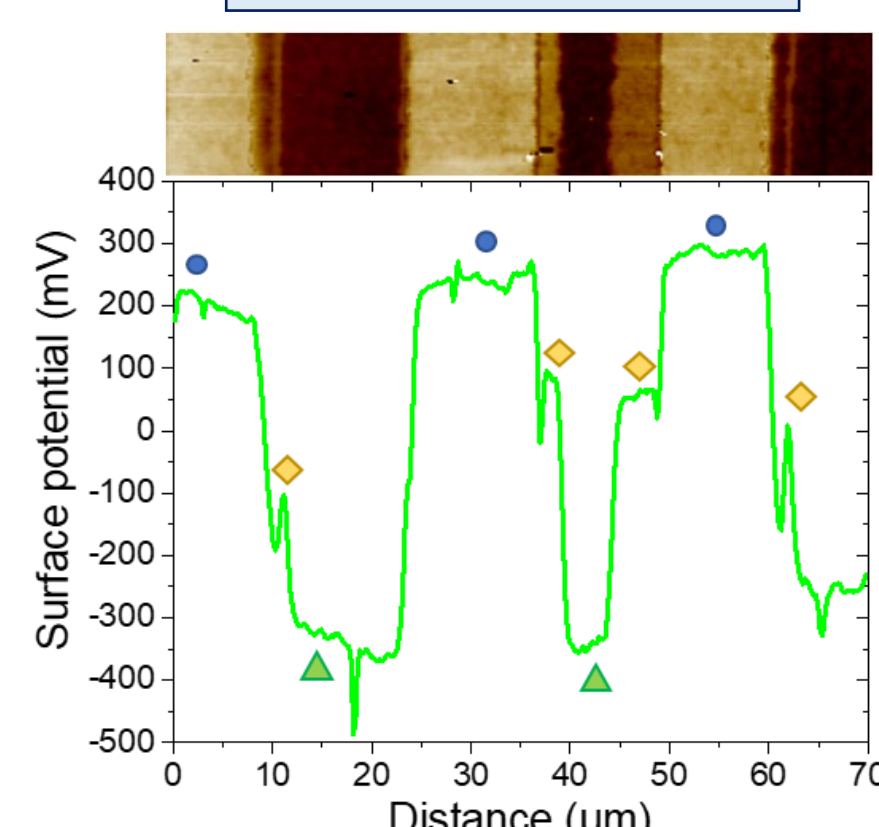

μ -Raman

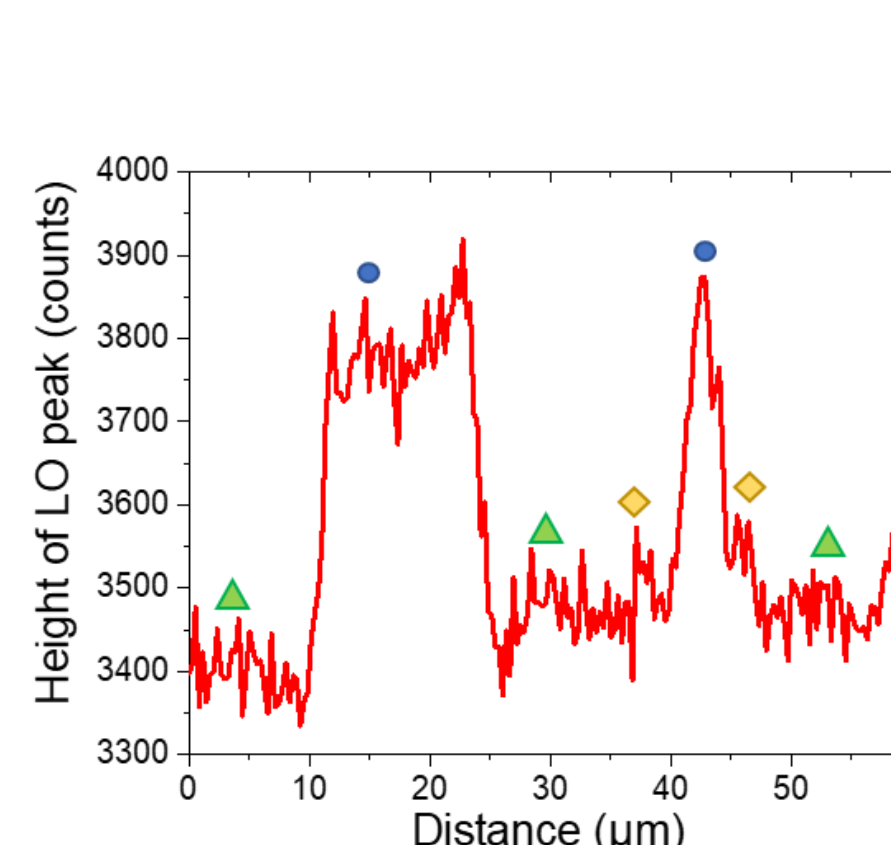
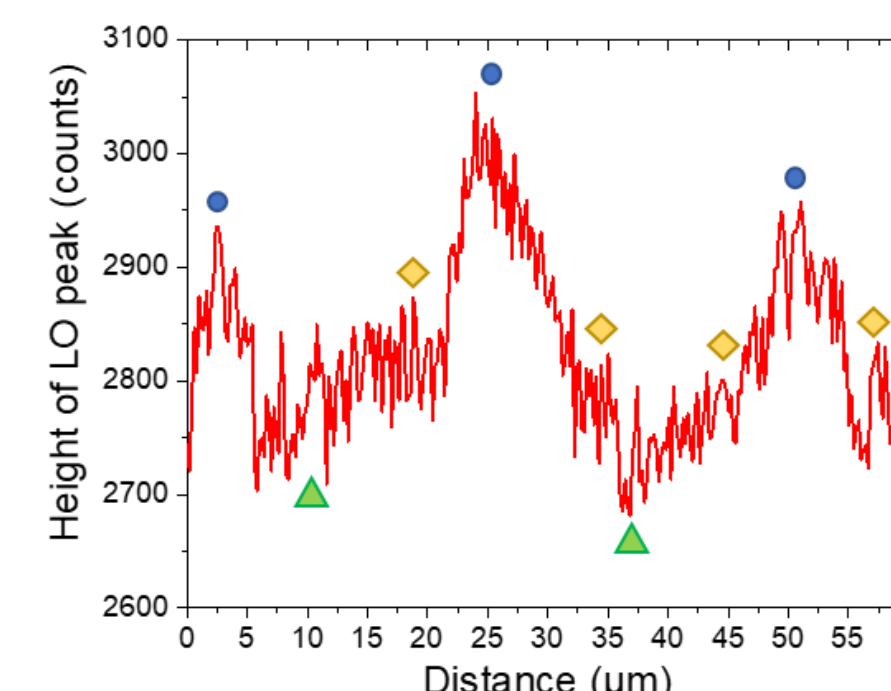

- ▲ n⁺-type doping
- p⁺-type doping
- ◆ n or p-doped channel

- SEM : electric field due to the p-n junctions \rightarrow electrons attracted to n-type doping and repelled from p-type doping [8]
- KPFM : n-type doping \nearrow the Fermi level of 4H-SiC and so its work function $\searrow \rightarrow$ defect states in the bandgap can change the work function of 4H-SiC [7]
- μ -Raman : when doping \searrow , intensity \nearrow and width of LO peak $\searrow \rightarrow$ n-type doping affects more the LO peak than p-type doping. Laser penetrates in 4H-SiC a few μ m deeper and beyond the implanted area \rightarrow signal of the epitaxial layer disturbs the measurements [6]

Conclusion

SEM, KPFM, and μ -Raman characterization as a way to identify doping in semiconductor devices

- ✓ **Non-destructive methods**
- ✓ **Localization** of the differently doped areas
- ✓ **Monitoring** of the presence of high electric fields at the surface.
- ✗ **KPFM** : impacted by surface defects and the charges present in the material.
- ✗ **μ -Raman** : also dependent on the defects inherent to the material or created during the ion implantation doping process. Laser depth is not adapted for the investigation of thin 4H-SiC layers

References

- [1] J. Berens, Carrier mobility and reliability of 4H-SiC trench MOSFETs (PhD Thesis), Institut für Mikroelektronik (2021)
- [2] J.-M. Lauenstein, IEEE Nuclear and Space Radiation Effects Conference, Santa Fe (2020)
- [3] H. Matsunami, Proc Jpn Acad Ser B Phys Biol Sci. 96, 235–254 (2020).
- [4] J. Camassel and S. Contreras, Electronique. (2012).
- [5] M. Lazar, F. Laariedh et al., Nucl.Instrum.Method Phys.Res. B 365, 256–259 (2015).
- [6] X.B Li, Z.Z Chen and E.W Shi, Physica B: Condensed Matter. 405, 2423-2426 (2010)
- [7] U. Gysin, E. Meyer et al., Microelectronic Engineering. 160, 18-21 (2016)
- [8] M. Buzzo, M. Ciappa et al., IEEE Transactions on Device and Materials Reliability. 6, 203-212 (2006)

Acknowledgments

The authors acknowledge the use of resources from the NanoPHOT graduate school and the Nanomat platform, part of the Renatech platform, supported by the Ministère de l'Enseignement supérieur et de la recherche, the Région Grand Est, FEDER funds from the European Community and French National ANR Agency.