



HAL
open science

Exposome et Alimentation : Définition et enjeux

Bruno Le Bizec

► **To cite this version:**

Bruno Le Bizec. Exposome et Alimentation : Définition et enjeux. Journée Thématique Exposition & Pollution, Académie 3 - Espace, Environnement, Risques et Résilience; Université Côte d'Azur, May 2024, Nice, France. hal-04618472

HAL Id: hal-04618472

<https://hal.science/hal-04618472v1>

Submitted on 20 Jun 2024

HAL is a multi-disciplinary open access archive for the deposit and dissemination of scientific research documents, whether they are published or not. The documents may come from teaching and research institutions in France or abroad, or from public or private research centers.

L'archive ouverte pluridisciplinaire **HAL**, est destinée au dépôt et à la diffusion de documents scientifiques de niveau recherche, publiés ou non, émanant des établissements d'enseignement et de recherche français ou étrangers, des laboratoires publics ou privés.

EXPOSOME & ALIMENTATION

Définition et enjeux

EXPOSITION & POLLUTION – NICE – 27.05.2024



UNIVERSITÉ CÔTE D'AZUR    Institut de Recherche pour le Développement FRANCE

JOURNÉE THÉMATIQUE
de l'Académie "Espace, Environnement, Risques et Résilience"

EXPOSITION & POLLUTION

Lundi 27 Mai 2024
Parc Phoenix, Nice



Bruno LE BIZEC, PROF

AVANT-PROPOS

L'influence de l'homme sur les écosystèmes, une planète en mutation ?

ANTHROPOCENE

Paul Josef Crutzen, Nobel Price Chemistry, 1995
Eugene Stoermer

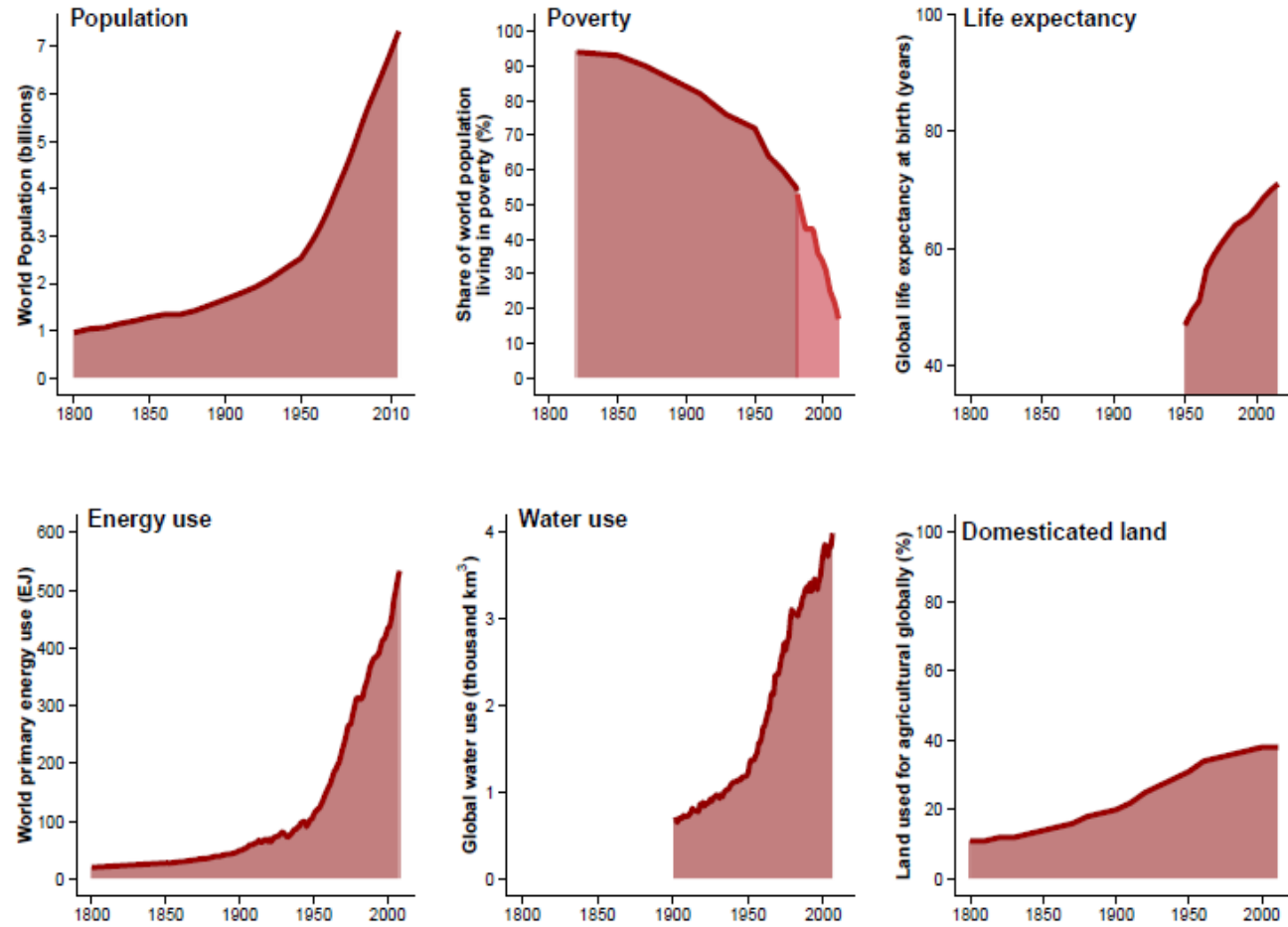

Proportion of deaths

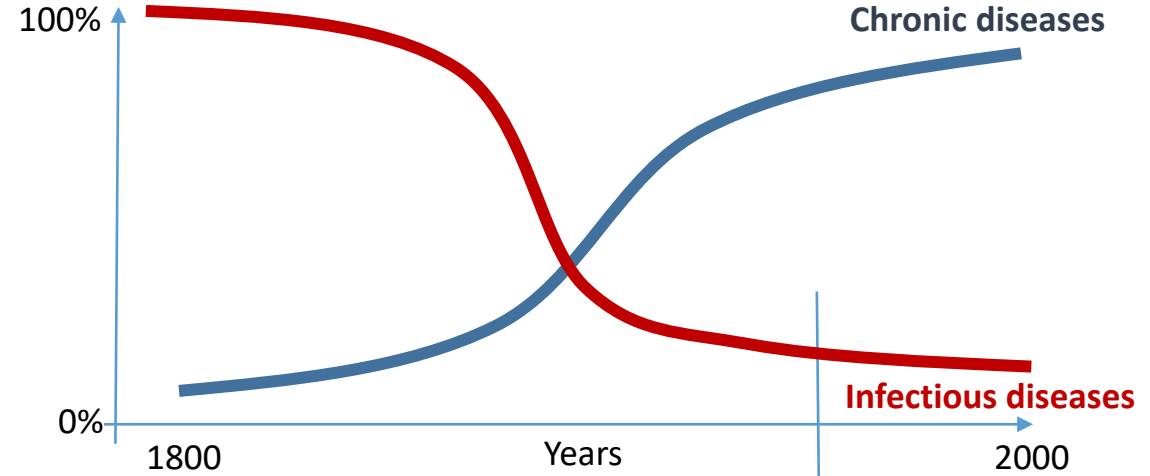

Global estimated deaths (10⁶)

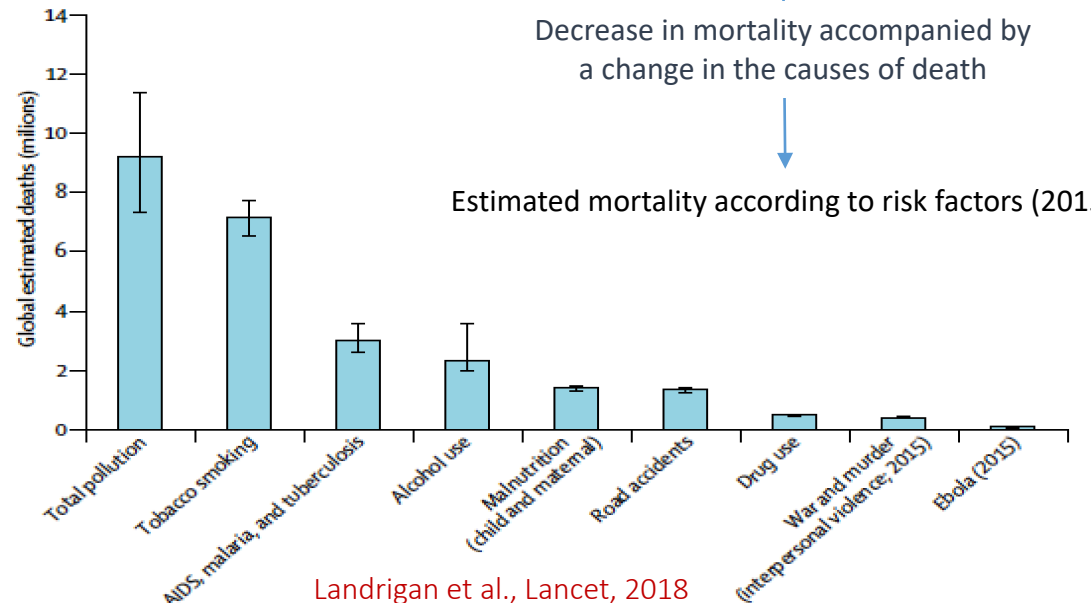

Decrease in mortality accompanied by a change in the causes of death

Estimated mortality according to risk factors (2015)

« *Safeguarding human health in the Anthropocene epoch* »

Report by the Rockefeller Foundation - Lancet Commission on Global Health. Whitmee et al. The Lancet 2015.

Landrigan et al., Lancet, 2018

L'EXPOSOME

Introduction et définition du concept

**Complementing the Genome with an "Exposome":
The Outstanding Challenge of Environmental
Exposure Measurement in Molecular Epidemiology**



Hippocrates

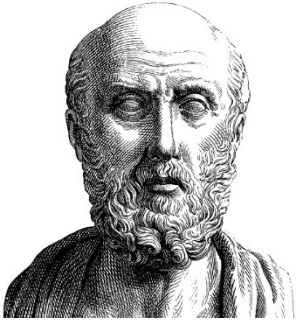

Pour accéder aux profondeurs de la médecine, il faut d'abord tenir compte des saisons, connaître la **qualité de l'eau** et des vents, étudier les différentes **conditions du sol** et le **mode de vie des habitants**
(500 BC, Treaty on "airs, waters and places")

EXPOSURE

In its complexity, it requires consideration of both the nature of those exposures and their changes over time

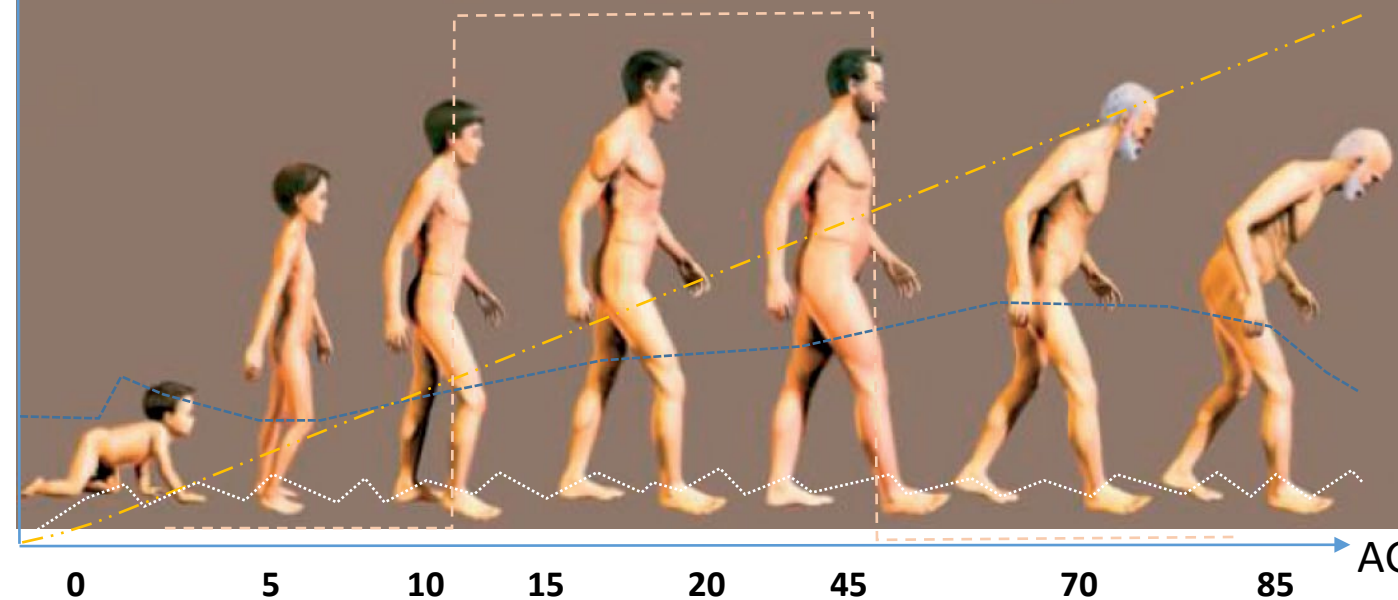

The exposome comprises every exposure to which an individual is subjected, from conception to death

[Wild, 2005].

L'EXPOSOME

Évolution de la définition et intégration dans le droit français



Stephen Rappaport



Garry Miller



Roel Vermeulen



Science, 2020;367(6476):392-396



- **Loi de modernisation du système de santé publique (loi 2016-41)**

Examiné par le Parlement en 2015 (loi Marisol Touraine), mise en œuvre en janvier 2016

- **Public Health Code (Chapter 1, Article 1, L1411-1)**

La surveillance et l'observation de l'état de santé de la population et l'identification de ses principaux déterminants, notamment ceux liés à l'éducation et aux conditions de vie et de travail. L'identification de ces déterminants s'appuie sur le concept **d'exposome**, entendu comme l'intégration sur la vie entière de l'ensemble des expositions qui peuvent influencer la santé humaine

- **Breakdown into actions**

Les politiques publiques ont intégré l'exposome dans les programmes d'actions menés en santé environnement :

- En France, 1^{ère} fois mobilisé en 2015 (PNSE3) pour permettre « *une nouvelle approche de la santé environnementale* ».
- Le PNSE4 intègre le concept dans l'un de ses quatre axes « *mieux connaître l'exposome* »
- Projet de stratégie nationale de santé 2023-2033

EXPOSITIONS EXTERNES TOUTES VOIES - VIE ENTIERE

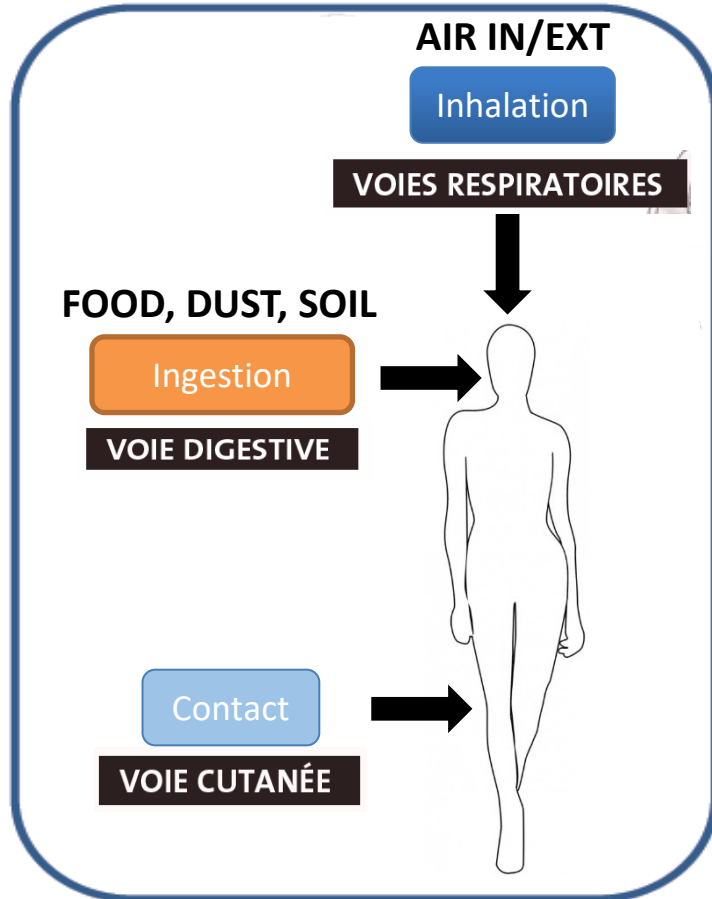

MARQUEURS
D'EXPOSITION EXTERNES

EXPOSITION INTERNE & EFFETS

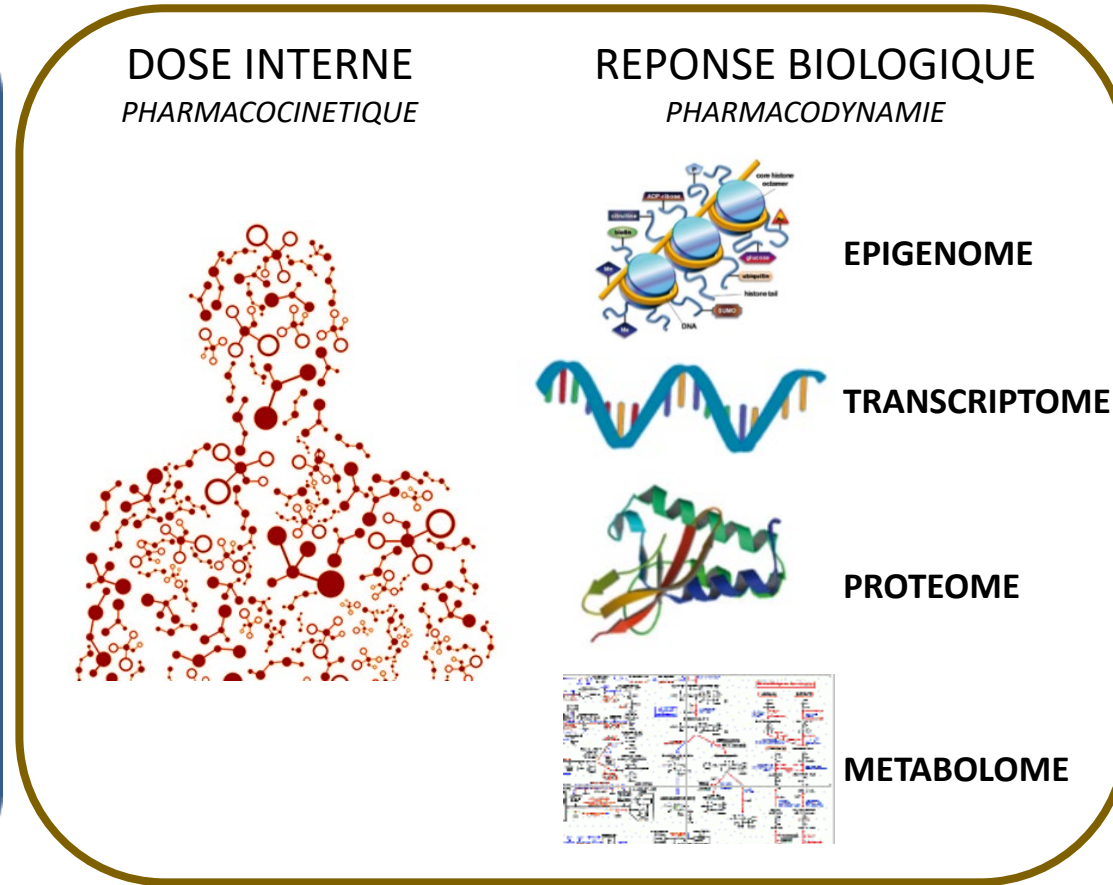

MARQUEURS
D'EXPOSITION INTERNES

&

MARQUEURS
D'EFFET INTERNES

SANTE

PUBERTE PRECOCE
ENDOMETRIOSE
CANCER
MOINDRE EFFICACITE VACCINALE
INFERTILITE

SEIN
PROSTATE
TESTICULE

Adapté de :

- Walker et al., 2016, Metabolic phenotyping in personalized and public healthcare
- Niedzwiecki MM et al. 2019, Annu. Rev. Pharmacol.Toxicol. 59:107-127
- Schulte PA (1999) Annals New York Academy Sciences, 895:101-111

EXPOSITIONS EXTERNES
TOUTES VOIES - VIE ENTIERE

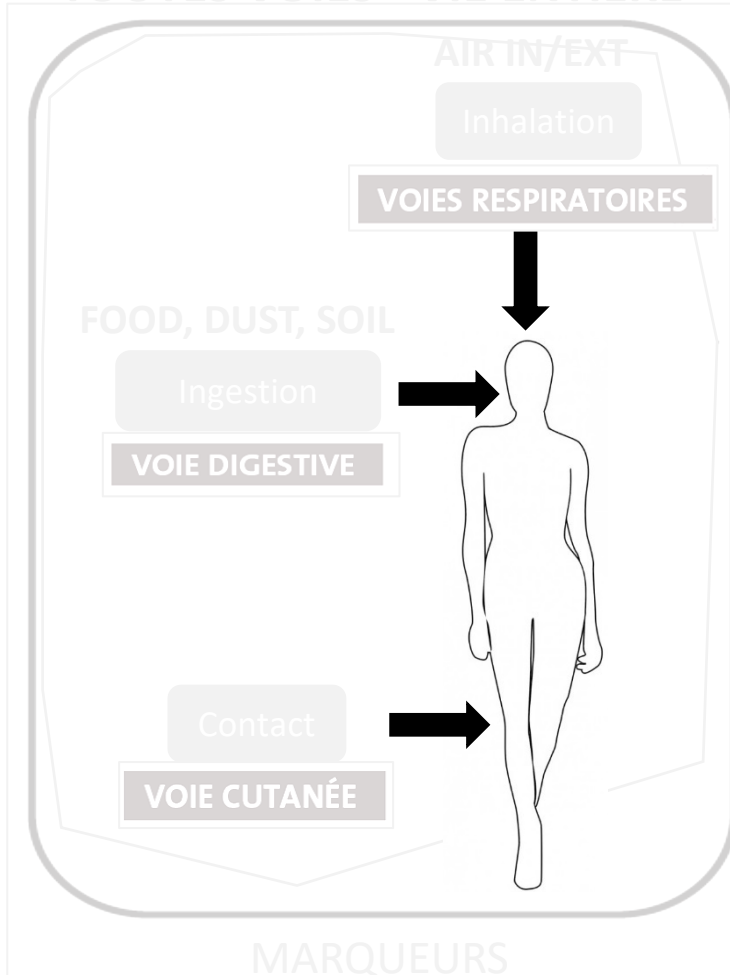

MARQUEURS
D'EXPOSITION EXTERNES

EXPOSITION INTERNE & EFFETS



MARQUEURS
D'EXPOSITION INTERNES

REPOSE BIOLOGIQUE
PHARMACODYNAMIE

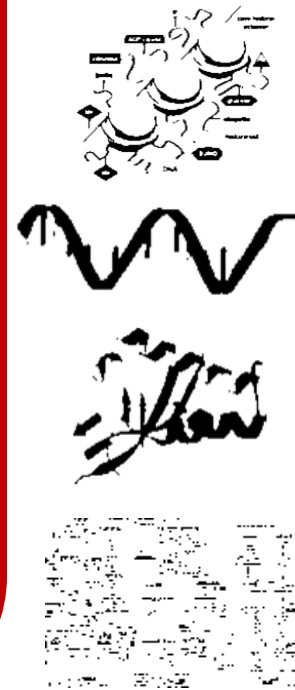

EPIGENOME

TRANSCRIPTOME

PROTEOME

METABOLOME

SANTE

PUBERTE PRECOCE

ENDOMETRIOSE

CANCER SEIN

EFFICACITE VACCINALE

INFERTILITE



&

MARQUEURS
D'EFFET INTERNES

INVESTIGUER LES DOSES INTERNES CHEZ L'HOMME

Une force de frappe puissante pour répondre aux besoins à grande échelle

	PCB	DIOXINES	PBDE	PBB	HBCD	PFAS	POCs	BPs	PHTAL.	PROD. PHYTO	ETM
BLOOD	●	●	●	●	●	●	●	●	●	○	●
URINE	✘	✘	✘	✘	✘	○	✘	●	●	●	●
MILK	●	●	●	●	●	●	●	●	●	○	●
HAIR	○	○	○	○	○	○	○	○	○	●	○
MECONIUM	●	●	●	●	●	●	●	●	●	○	○
ADIPOSE TISSUE	●	●	●	●	●	●	●	●	●	○	○
PLACENTA	●	●	●	●	●	●	●	●	●	○	●
SALIVA	○	○	○	○	○	○	○	○	○	○	○
TEETH	○	○	○	○	○	○	○	○	○	○	○

Annual production capacity



PCB	DIOXINES	PBDE	PBB	HBCD	PFAS	POCs	BPs
PHTAL.	PROD. PHYTO	ETM	MEDICAM HUMAIN	COSM.	TOXINES MYCO	DRUG of ABUSE	OPFRs

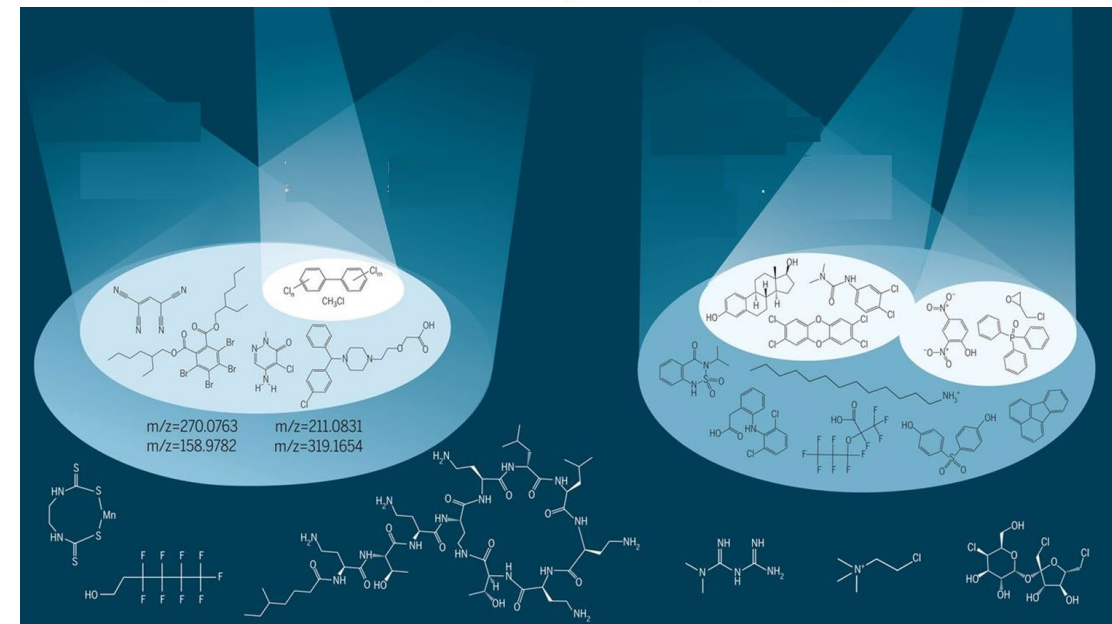

Adapted from Escher et al., 2020, Science • Vol 367, 388-392

Controlling just one biological compartment would not be enough to meet all the expectations of the various communities.

There is no single characterization approach that would profile the chemical exposome in all its dimensions in a single action.

Une INFRASTRUCTURE de RECHERCHE NATIONALE DEDIEE

Quels objectifs et quels partenaires ?

- Renforcer la capacité de caractérisation de l'exposition humaine à des mélanges chimiques complexes
- Fournir l'assistance nécessaire à l'interprétation des données (académie, agences sanitaires, privé)
- Contribuer à l'étude des associations entre biomarqueurs d'exposition et certains effets santé chez l'Homme

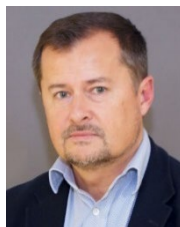

Michel SAMSON, DR Inserm, Dir. IRSET, UMR 1085 EHESP/INSERM/UR1



Bruno LE BIZEC, Prof. Oniris, Dir. LABERCA, UMR 1329 Oniris/INRAE

GENERATION OF EXPOSURE DATA

Exposure Assessment

Targeted Suspect screening (SS) Non-targeted screening (NTS)



DATA INTERPRETATION

Experimental Toxicokinetics & PBTK Modeling

Existing Data New Data

Predictive Toxicology

Adverse Outcome Pathway (AOP) Artificial Intelligence (AI)



IRSET / LERES

- > TARGETED APPROACHES (ORGA, INORGA)
- > SUSPECTED / NON-TARGETED SCREENING

ANAE AND TEAM - INERIS

- > SUSPECTED / NON-TARGETED SCREENING
- > TARGETED APPROACHES (ORGA, INORGA)
- > TOXICOKINETIC STUDIES
- > EXPOSURE BIOMARKERS INTERPRETATION

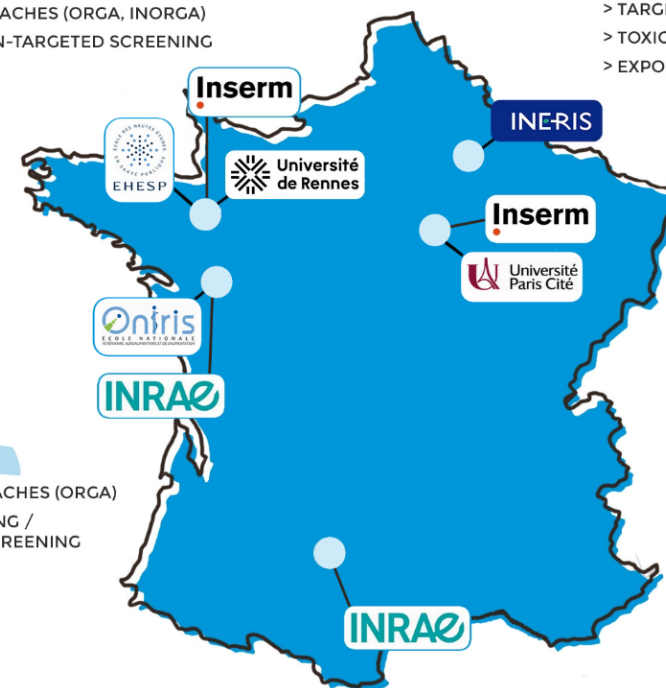

T3S

- > SYSTEMIC TOXICOLOGY - DATA INTEGRATION (OMICS)
- > SYSTEM BIOLOGY (AOP BUILDING) - LINKS CHEMICAL STRESSORS AND TOXICITY PATHWAY (AOP)

LABERCA

- > TARGETED APPROACHES (ORGA)
- > SUSPECT SCREENING / NON-TARGETED SCREENING
- > EFFECT MARKERS

TOXALIM

- > TARGETED APPROACHES (ORGA)
- > SUSPECT SCREENING / NON-TARGETED SCREENING
- > METABOLISM STUDIES (EXPO MARKERS)
- > EFFECT MARKERS

Une INFRASTRUCTURE de RECHERCHE NATIONALE DEDIEE *Des alliances au niveau européen ?*

EIRENE RI - The first EU infrastructure on human exposome

- Coordonné Université Masaryk (République tchèque)
- EIRENE = projet/feuille de route ESFRI 2021

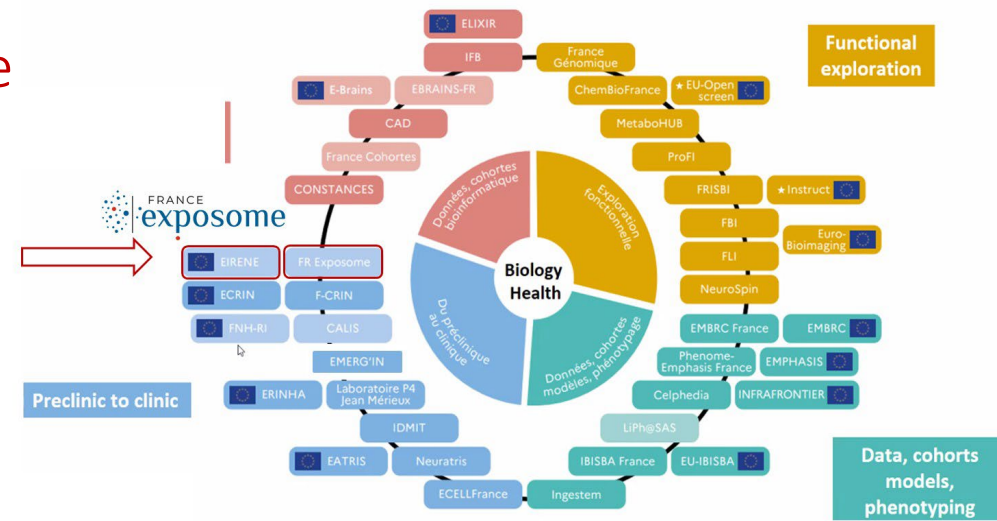
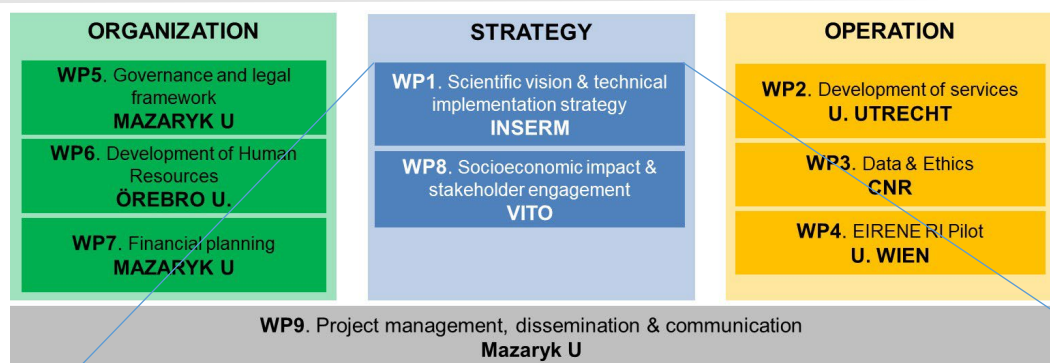

EIRENE RI

OBJECTIVE WP1

Développer concept scientifique d'EIRENE, identifier les piliers clés de l'architecture, hubs nationaux et installations centrales.

Expected results (R1):

- Vision stratégique & programme RI d'EIRENE basés sur l'analyse/interprétation des défis scientifiques et sociétaux + besoins PP



Une INFRASTRUCTURE de RECHERCHE NATIONALE DEDIEE

Pourquoi produire des données au niveau national ?

PFAS concentrations in serum in the population of adults living in France Esteban (2014–2016)

PFCs (µg/L serum)

	n	%>LOQ	GM (95%CI)	P25	P50	P75	P95 (95% CI)
PFBA	744	1.1	NC	<LOQ	<LOQ	<LOQ	<LOQ
PFPA	744	0.0	NC	<LOQ	<LOQ	<LOQ	<LOQ
PFHxA	744	0.0	NC	<LOQ	<LOQ	<LOQ	<LOQ
PFHpA	744	2.8	NC	<LOQ	<LOQ	<LOQ	<LOQ
PFOA	2	100.0	2.08 (1.97 ; 2.20)	1.46	2.12	3.02	5.26 (4.82 ; 5.67)
PFNA	4	99.5	0.80 (0.75 ; 0.85)	0.57	0.80	1.10	1.91 (1.66 ; 2.07)
5	5	89.2	0.34 (0.05 ; 0.06)	0.24	0.32	0.46	0.78 (0.74 ; 0.84)
7	7	99.5	0.17 (0.16 ; 0.19)	0.12	0.18	0.25	0.42 (0.39 ; 0.48)
PFDoA	744	22.3	NC	<LOQ	<LOQ	<LOQ	0.08 (0.08 ; 0.10)
PFBS	744	0.0	NC	<LOQ	<LOQ	<LOQ	<LOQ
PFHxS	3	99.6	1.37 (1.27 ; 1.48)	0.90	1.48	2.11	3.42 (3.07 ; 3.89)
6	6	53.4	0.18 (0.16 ; 0.19)	<LOQ	0.19	0.28	0.48 (0.43 ; 0.54)
PFOS	1	100.0	4.03 (4.03 ; 4.67)	2.78	4.23	6.62	13.54 (11.33 ; 15.59)
PFDS	744	0.0	NC	<LOQ	<LOQ	<LOQ	<LOQ
n-Et-PFOSA-AcOH	744	2.2	NC	<LOQ	<LOQ	<LOQ	<LOQ
n-Me-PFOSA-ACOH	744	24.6	NC	<LOQ	<LOQ	<LOQ	0.13 (0.12 ; 0.18)
PFOSA	744	0.4	NC	<LOQ	<LOQ	<LOQ	<LOQ

Une INFRASTRUCTURE de RECHERCHE NATIONALE DEDIEE

Possibilité de comparer ces données à l'échelle EU/Internationale ?



only percentiles >LOD/LOQ are displayed

Northern Europe

Distribution of PFOA (Perfluorooctanoic acid) et PFOS (Perfluorooctane sulfonic acid) concentration in Blood (µg/L)

sampling period	country	data collection name	Biomar...	No stratification	N
2000-2008	NO	MoBa	PFOA		4295
			PFOS		4295
2008-2009	BE	FLEHS 2 adults	PFOA		201
			PFOS		201
		FLEHS 2_Newborn	PFOA		220
			PFOS		220
2009-2010	ES	BIOAMBIENT.ES	PFOA		755
			PFOS		755



Western Europe

Southern Europe

LES DETERMINANTS ALIMENTAIRES DE L'EXPOSOME

De l'interne vers l'externe et vice versa



LES DETERMINANTS ALIMENTAIRES DE L'EXPOSOME

De l'interne vers l'externe, origines et nature des R&C

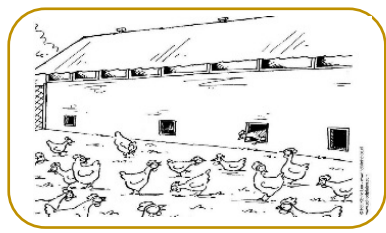

ELEVAGES



Pesticides
Méd Vét

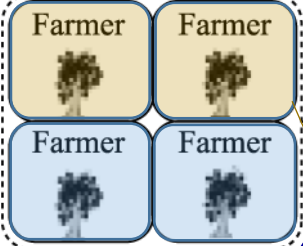

DIOX, PCB, PFAS
Cd, As, Pb, Hg
Phycotoxines
Mycotoxines

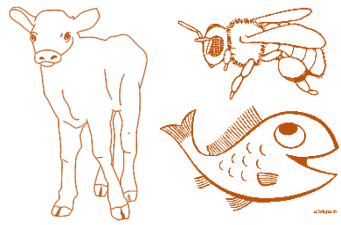

ENVIRONNEMENT

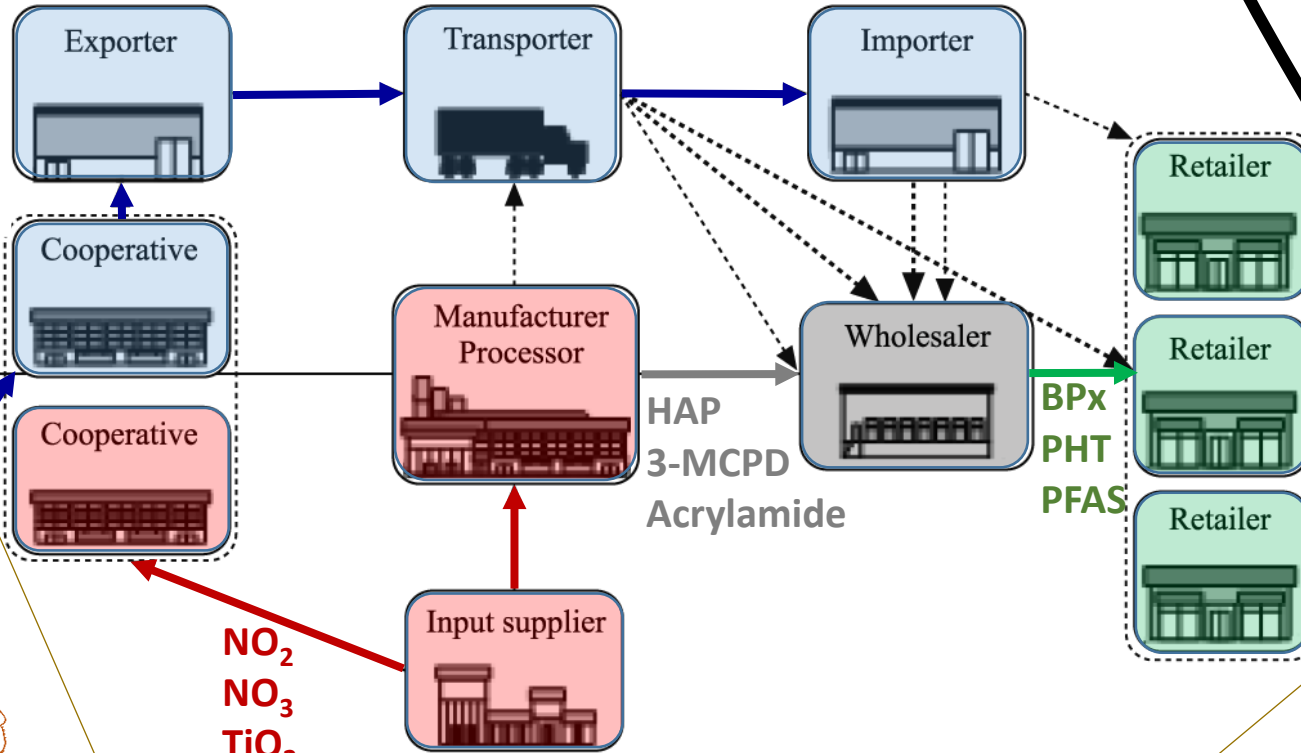

ASSIETTE

CONSUMMATEUR



EXTERNE



Follow your food from farm to fork.



LES DETERMINANTS ALIMENTAIRES DE L'EXPOSOME

Vision et définition de l'Anses ?

Totalité des expositions néfastes comme bénéfiques à des agents chimiques, biologiques, et physiques, en interaction avec l'état physiologique, le milieu de vie, le contexte psycho-social, que connaît un organisme vivant de sa conception à la fin de sa vie dans la perspective d'expliquer son état de santé.

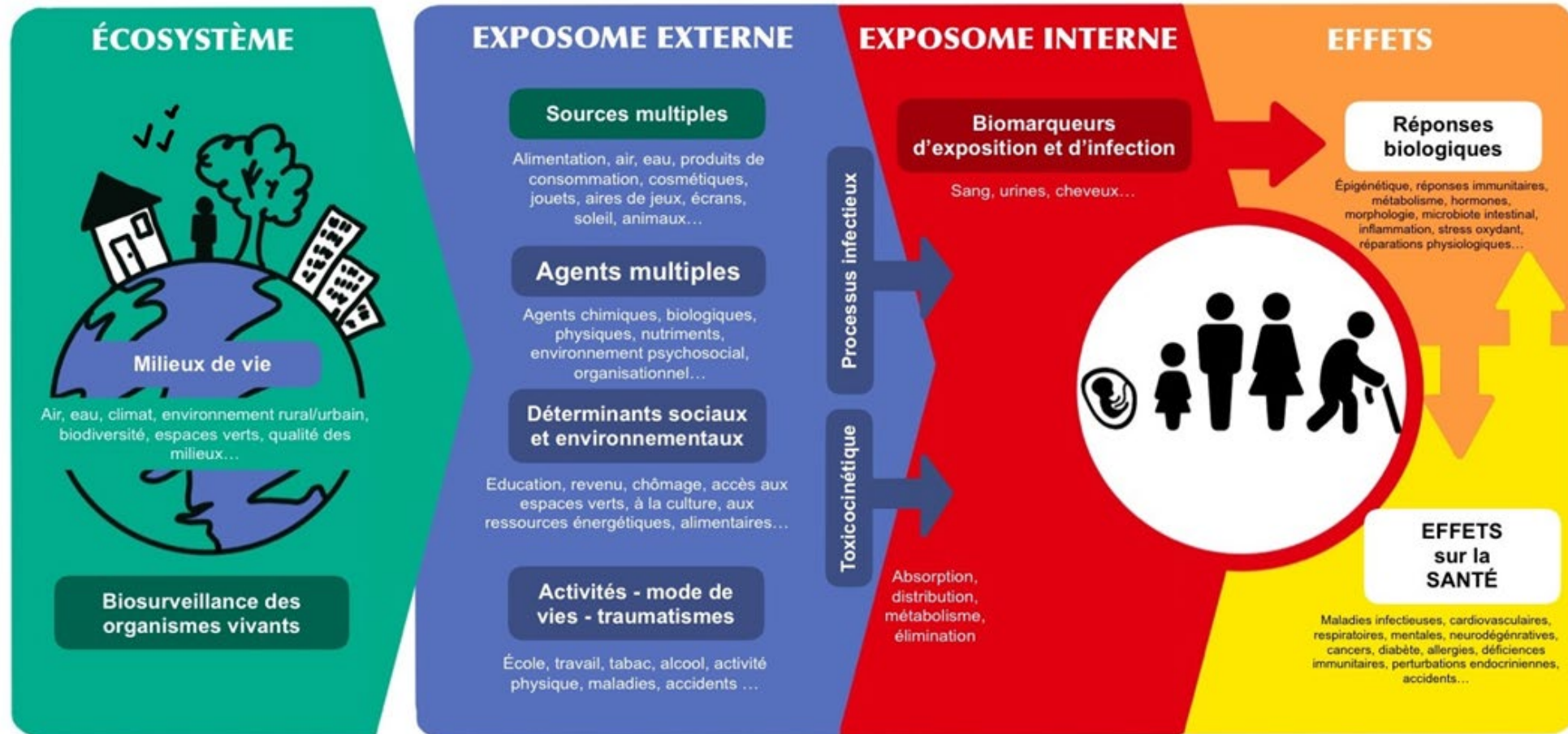

LES DETERMINANTS ALIMENTAIRES DE L'EXPOSOME

Largeur du spectre de l'exposome chimique investigué dans les EAT françaises ?

Table 1
Description of the 6 main chemical mixtures identified in the E3N cohort (N = 73,031).

Mixture 1		Mixture 2		Mixture 3		Mixture 4		Mixture 5		Mixture 6	
Minerals, inorganic contaminants, and furans		BFRs, dioxins, PCBs, and furan		Mycotoxins, pesticide, and PAHs		Pesticides (1)		Pesticides (2)		PFAS, BFRs, PCBs, Se, Hg, and furan	
N = 28 Sp = 0.86 %Ve = 27.96		N = 52 Sp = 0.74 %Ve = 29.75		N = 25 Sp = 0.87 %Ve = 5.60		N = 23 Sp = 0.88 %Ve = 4.58		N = 46 Sp = 0.77 %Ve = 10.07		N = 21 Sp = 0.89 %Ve = 3.37	
Substance	%contrib	Substance	%contrib	Substance	%contrib	Substance	%contrib	Substance	%contrib	Substance	%contrib
Cr	5.96 %	BDE99	2.72 %	DON	10.05 %	Iprodione	11.14 %	Azoxystrobin	3.75 %	PFTrDA	7.64 %
K	5.70 %	TCDD_2378	2.67 %	Pirimiphos methyl	9.95 %	Cyprodinyl	10.99 %	Mepanipyrim	3.56 %	PFUnA	7.55 %
Pb	5.21 %	PCB_126	2.65 %	BghiP	9.12 %	Lambda Cyhalothrin	10.93 %	Acrinathrin	3.52 %	BB52	7.50 %
Fe	5.01 %	PCB_28	2.62 %	OTA	9.11 %	Bifenthrin	10.22 %	Thiabendazole	3.43 %	BDE28	6.94 %
Cd	4.81 %	PCB_156	2.59 %	HT2	8.68 %	Fludioxonyl	10.00 %	Fenhexamid	3.30 %	PFOS	6.88 %
Ba	4.79 %	HCDF_123789	2.53 %	CPP	8.42 %	Sulfur	8.86 %	Tebuconazole	3.20 %	PCB_123	6.41 %
Zn	4.53 %	PCB_180	2.53 %	BjF	5.66 %	Cyproconazole	8.85 %	Chlorpyrifos ethyl	3.05 %	BB153	6.12 %
Mo	4.38 %	HCDD_123678	2.49 %	BbF	5.41 %	Procymidone	6.58 %	Myclobutanil	3.03 %	BB101	5.74 %
Ni	4.22 %	PCB_169	2.49 %	BkF	5.01 %	PFOA	4.07 %	Phosmet	3.03 %	BDE154	5.68 %
HCDF_1234789	3.92 %	BDE153	2.48 %	BaP	4.62 %	Secoisolariciresinol	3.34 %	Kresoxim methyl	2.94 %	Se	5.53 %
OCDF	3.88 %	PCB_189	2.46 %	Niv	4.39 %	Pyrimethanil	3.04 %	Endosulfan Sulfate	2.94 %	PCB_101	5.49 %
HCDF_1234678	3.87 %	PCB_118	2.43 %	BaA	3.55 %	Boscalid	2.11 %	Endosulfan Beta	2.94 %	Hg	5.29 %
HCDF_123478	3.83 %	HCDD_1234678	2.41 %	acrylamide	3.22 %	Daidzeine	2.04 %	Thiophanate methyl	2.94 %	TCDF_2378	5.16 %
Al	3.81 %	PCB_114	2.37 %	Chlorpropham	2.04 %	Metalaxyl	1.50 %	Bupirimate	2.94 %	BDE100	5.15 %
FA	3.80 %	HCDD_123478	2.35 %	IP	1.81 %	Genisteine	1.40 %	Triadimenol	2.92 %	BDE47	4.85 %
V	3.79 %	PCB_157	2.33 %	FB1	1.70 %	Coumestrol	1.25 %	Imazalil	2.90 %	PCDF_23478	3.81 %
Na	3.72 %	PCB_138	2.33 %	DbaiP	1.53 %	Vinclozolin	1.24 %	Diphenylamine	2.90 %	As	2.67 %
Mg	3.68 %	PCDD_12378	2.33 %	Li	1.50 %	Pyriproxyfen	0.82 %	Propargite	2.88 %	DbaiP	0.96 %
Sb	3.66 %	HCDD_123789	2.31 %	Se	1.26 %	Chlorothalonil	0.77 %	Carbendazim	2.84 %	PHE	0.40 %
HCDF_234678	3.37 %	PCB_81	2.30 %	PCDF_23478	0.87 %	Li	0.40 %	Metalaxyl	2.73 %	PFNA	0.17 %
Te	3.34 %	PCB_153	2.26 %	PFOA	0.76 %	Sr	0.35 %	Phosalone	2.56 %	Li	0.06 %
HCDF_123678	3.27 %	PCB_105	2.24 %	Sr	0.60 %	Diethofencarb	0.07 %	Captan	2.53 %		
Co	3.18 %	PCB_167	2.24 %	T2	0.37 %	Thiabendazole	0.01 %	Dimethoate	2.35 %		
PCDF_23478	1.66 %	PCDF_12378	2.15 %	PHE	0.33 %			Azinphos methyl	2.33 %		
PHE	1.13 %	OCDD	2.12 %	BDE47	0.03 %			Fenbuconazole	2.27 %		

$$E_{i,j} = \frac{\sum_{k=1}^n C_{i,k} \times T_{k,j}}{PC_i}$$

EAT1 (2001-2005), > 3 ans, INCA 1 (1999), 39 substances
EAT2 (2006-2011), > 3 ans, INCA 2 (2009), 445 substances
EATi (2010-2016), < 3 ans, Nutri-Bébé (2005), 670 substances
EAT3 (2019-2025), > 3 ans, INCA 3 (2017)

LES DETERMINANTS ALIMENTAIRES DE L'EXPOSOME

Comment utiliser des approches ciblées pour mesurer des traces de substances chimiques dans des matrices alimentaires complexes ?

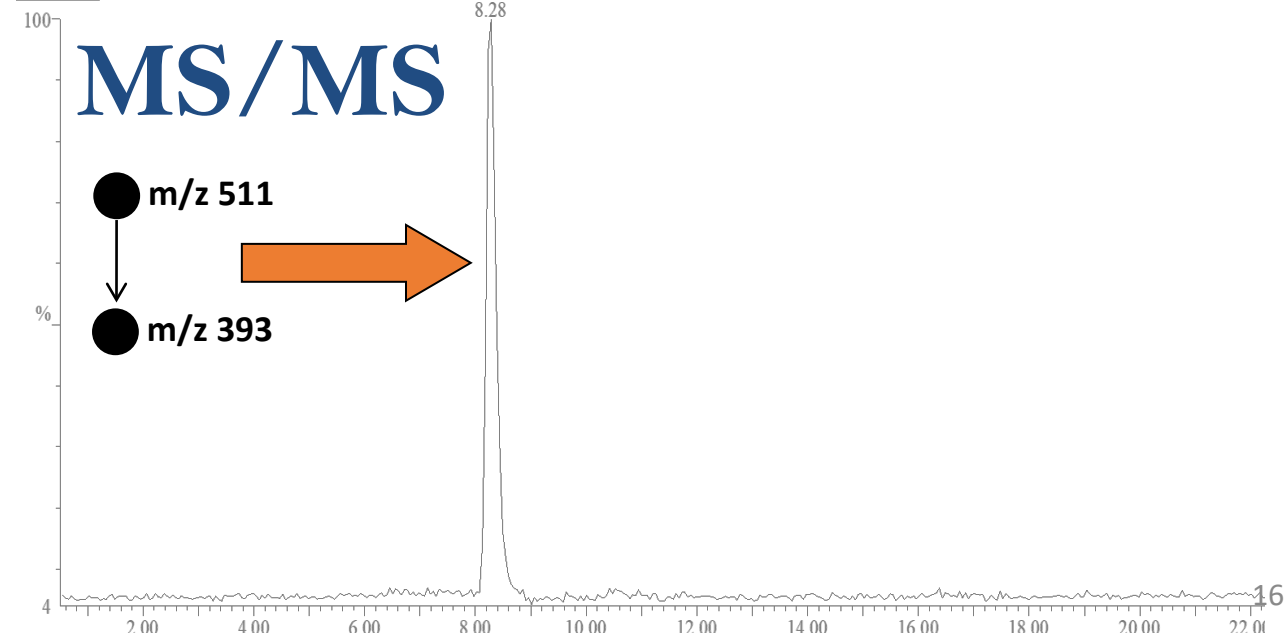
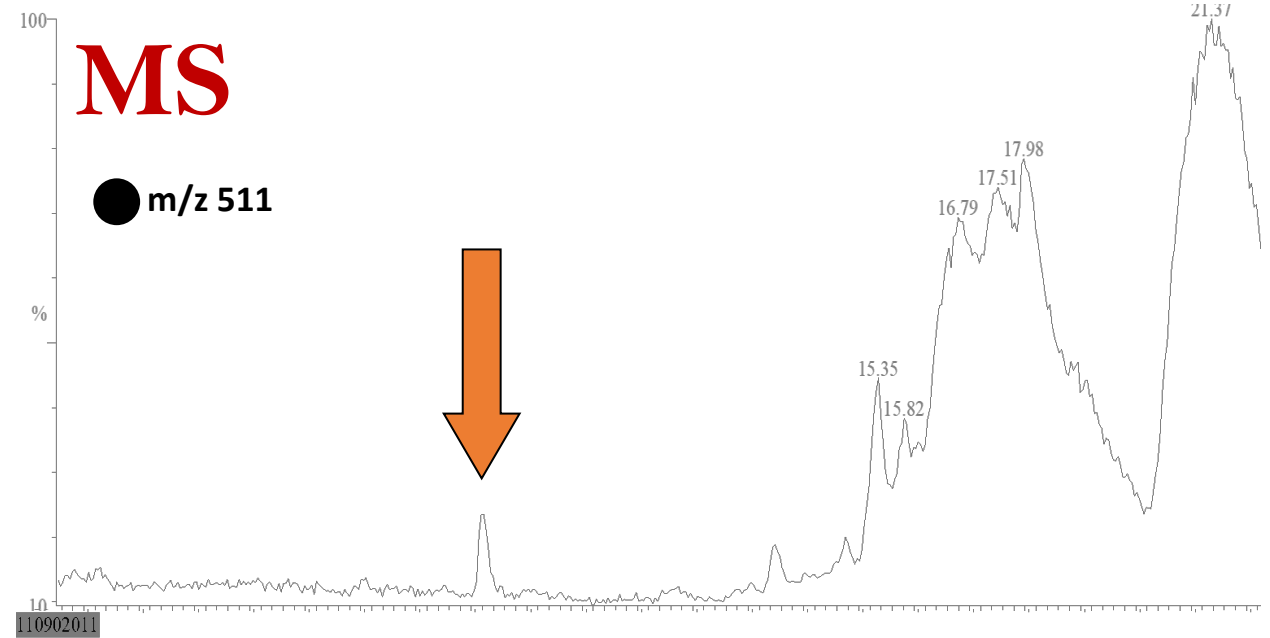
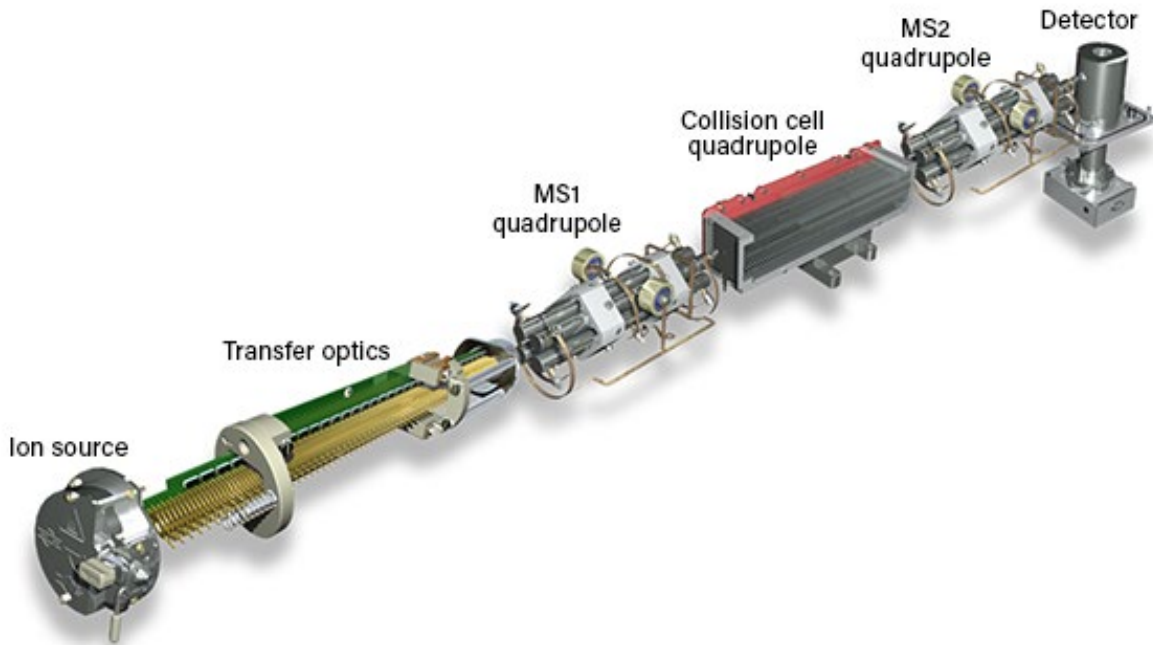

LES DETERMINANTS ALIMENTAIRES DE L'EXPOSOME

Comment utiliser des approches ciblées pour mesurer des traces de substances chimiques dans des matrices alimentaires complexes ?

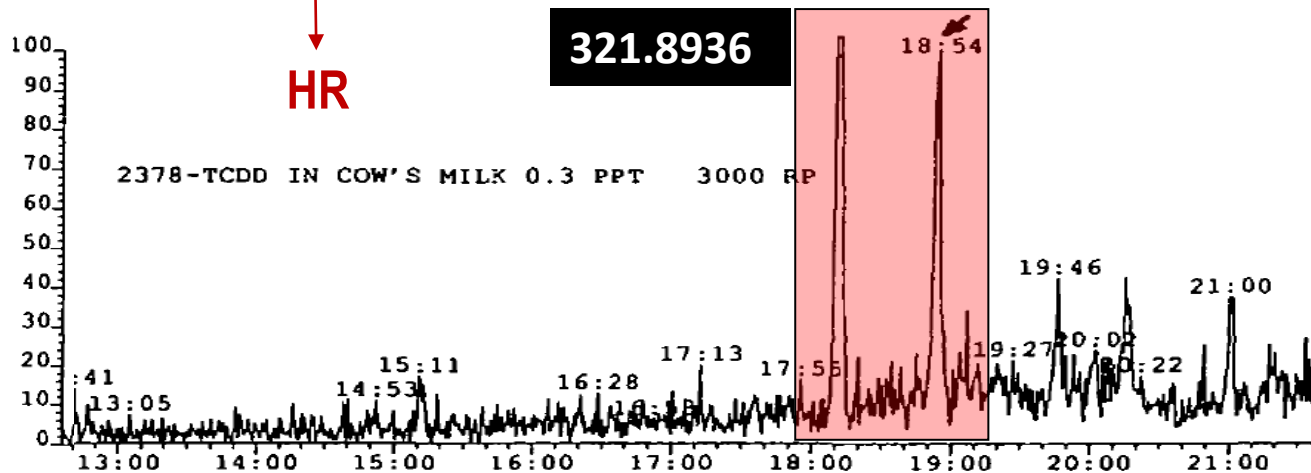
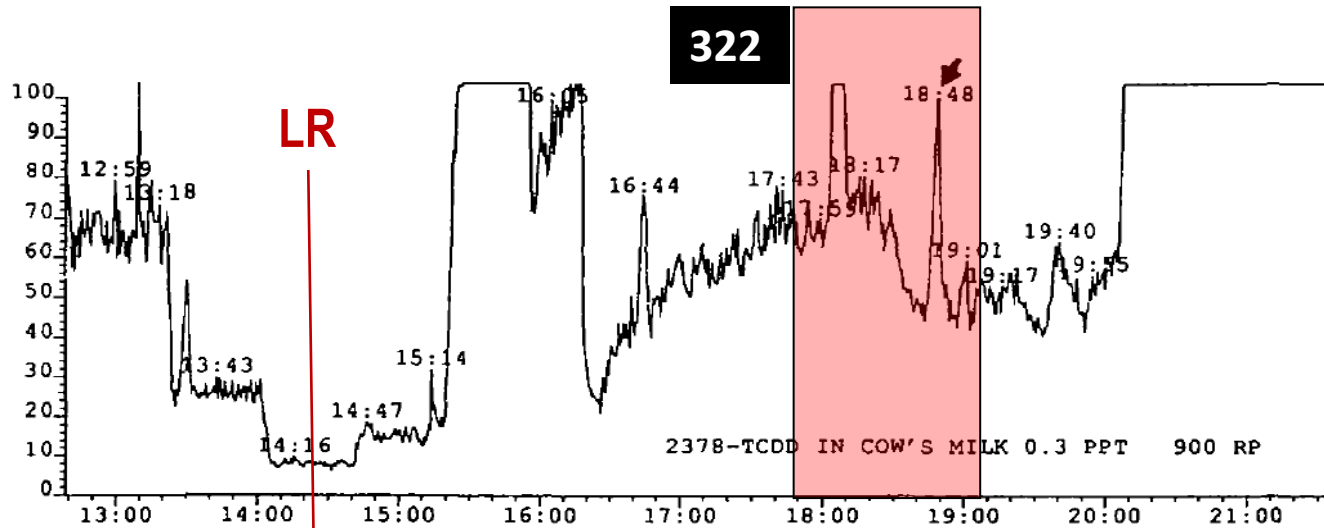

DQ Main View JEOL DioK V4.02 2016/11/22 15:32:33 Page 1
 DqData: 20160502-800-2-Diox c (EPA-1613, DB-SMS), Injection= 16.447.32 (UNK)
 Original: 20160502-800-2-diox-PCB002.mfl, InjectionNo= 33, Sample= 16.447.32, Date= <Date>

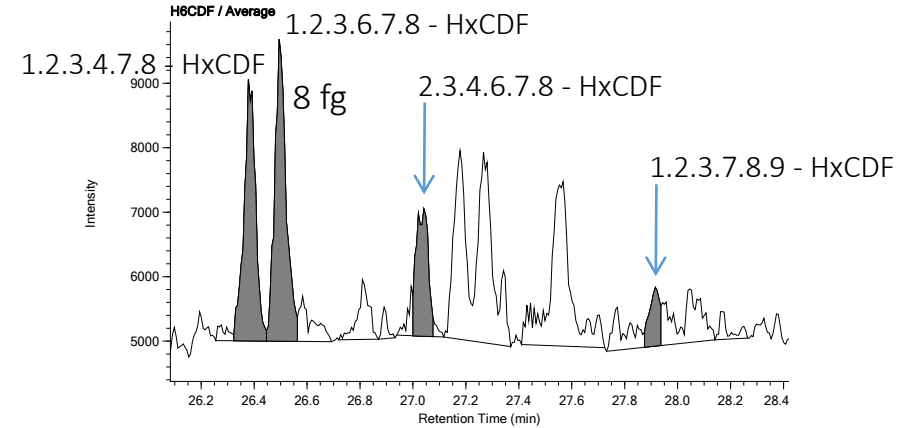

Calculated Retention Time

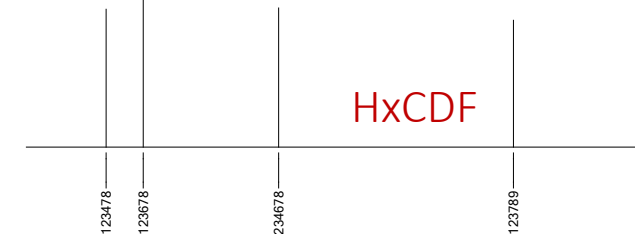

DILUTION ISOTOPIQUE

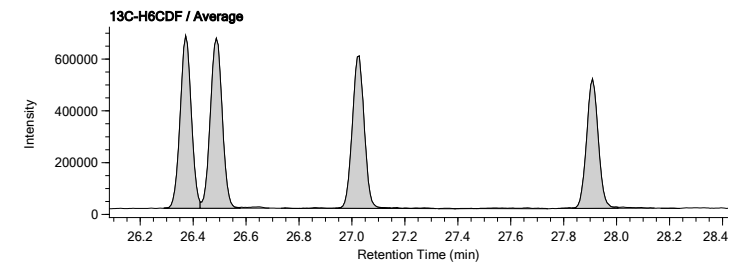

	1.2.3.4.7.8 - HxCDF	1.2.3.6.7.8 - HxCDF	1.2.3.7.8.9 - HxCDF	2.3.4.6.7.8 - HxCDF
Quant injectée (pg)	0.007	0.008	0.011	0.008
Conc pg/g de sérum	0.021	0.022	0.006	0.012

LES DETERMINANTS ALIMENTAIRES DE L'EXPOSOME

Part relative de l'alimentation dans l'exposition externe totale ?

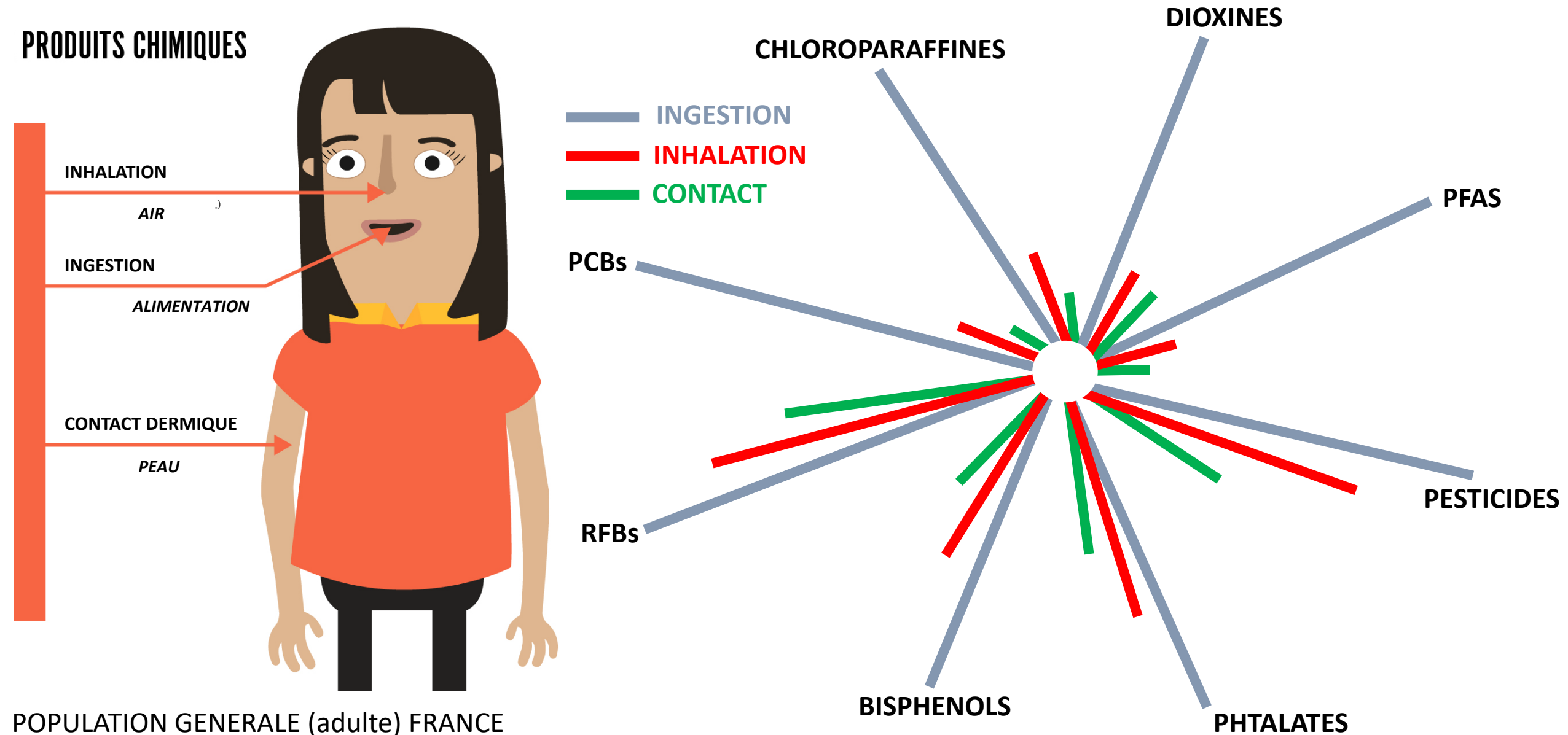

LES DETERMINANTS ALIMENTAIRES DE L'EXPOSOME

Part relative des aliments dans l'exposition aux dioxines et évolution temporelle ?

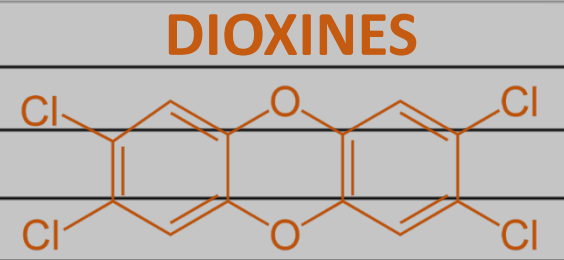
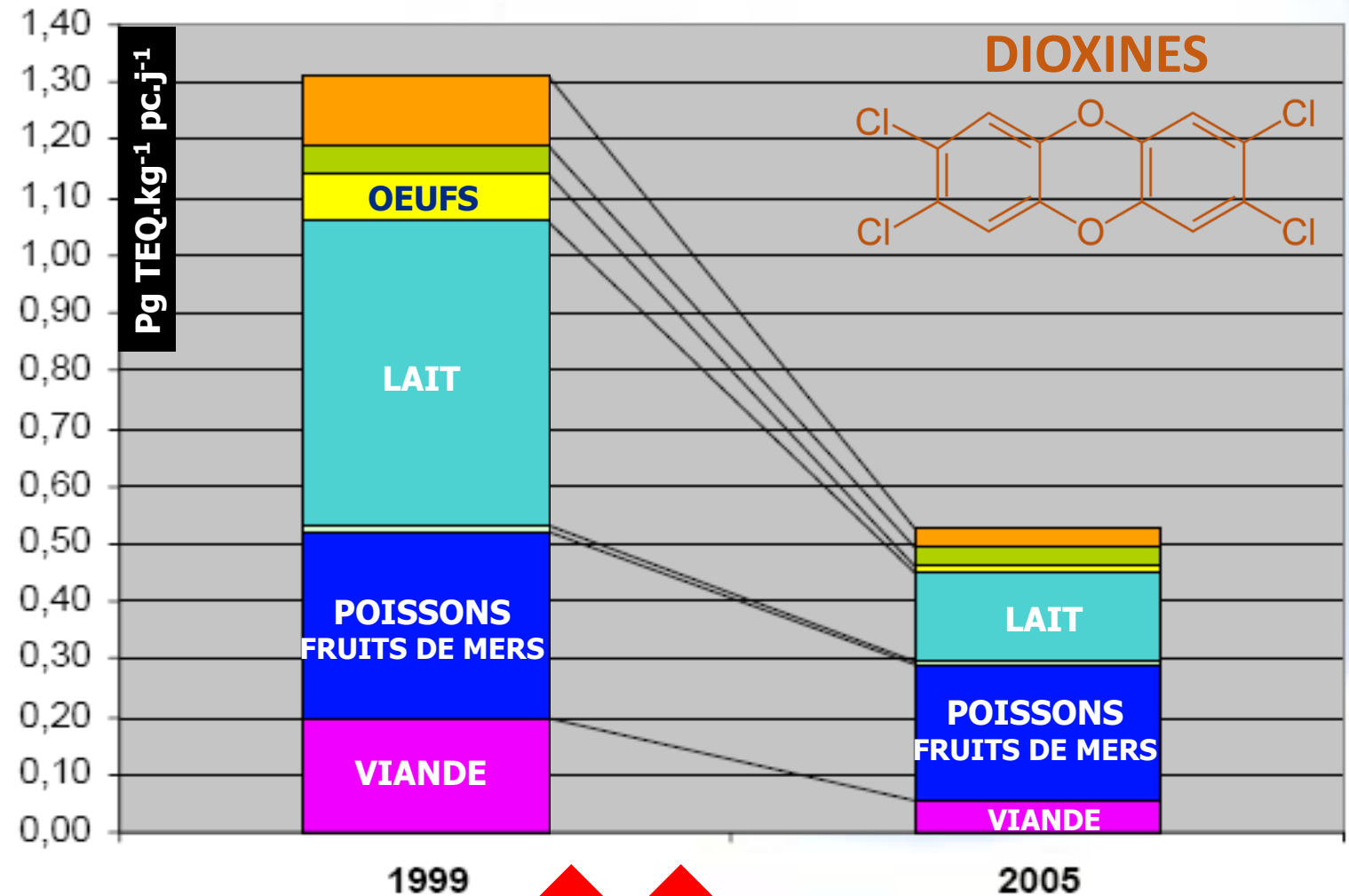
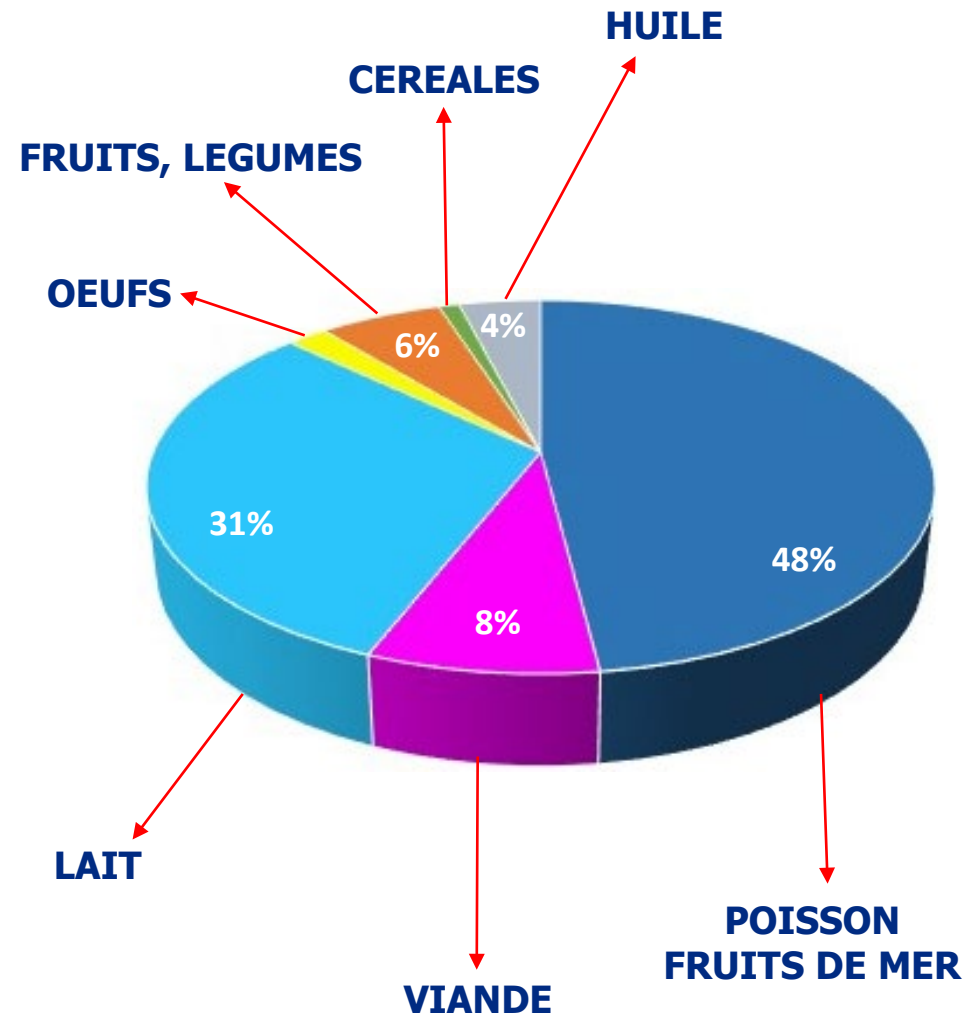

POPULATION GENERALE (adulte) FRANCE

REGULATION WIP
REGULATION on FEED (2002/32/CE)

LES DETERMINANTS ALIMENTAIRES DE L'EXPOSOME

L'exposome ou le devoir de la prise en compte d'une exposition dynamique

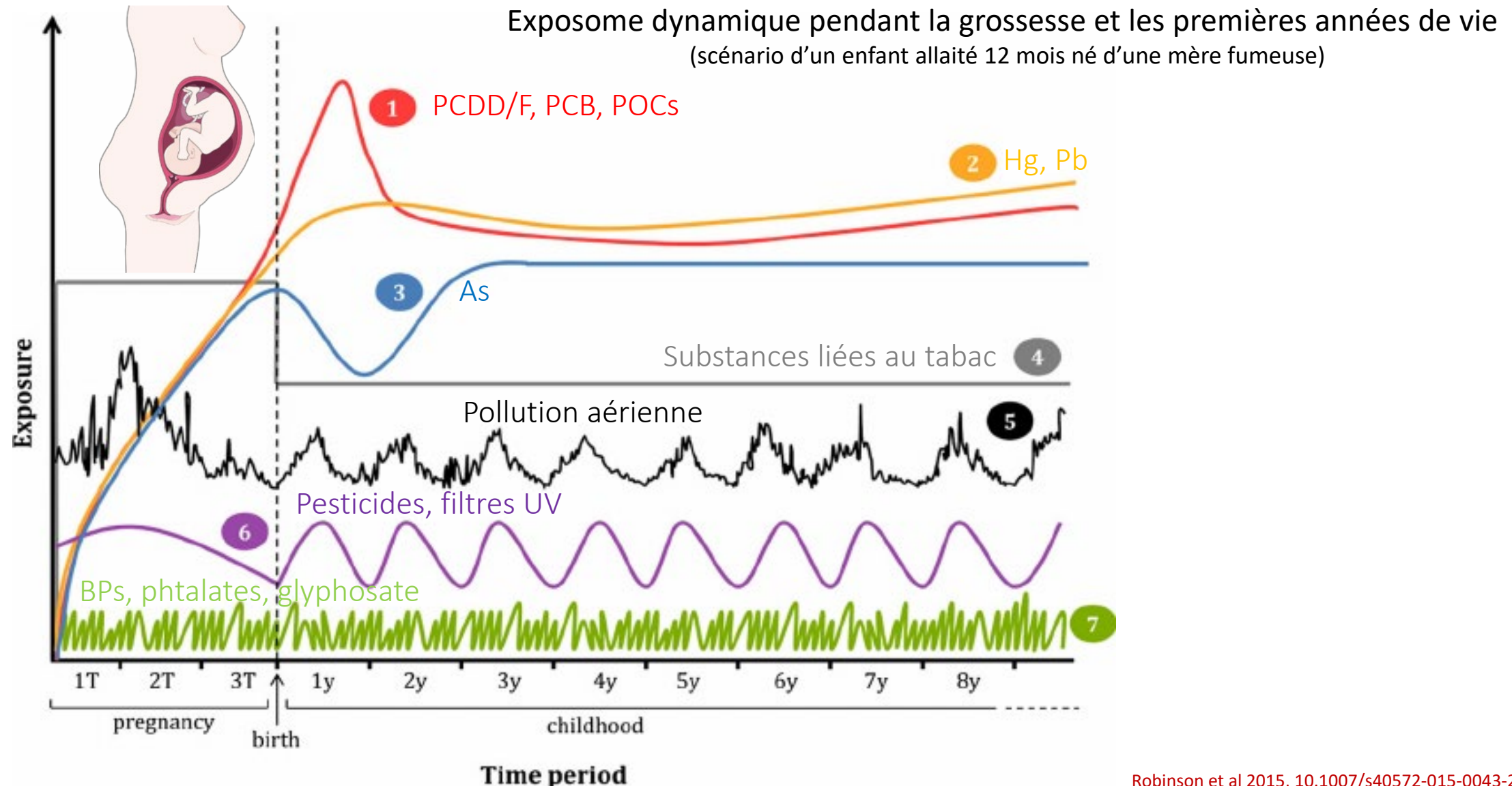

LES DETERMINANTS ALIMENTAIRES DE L'EXPOSOME

L'exposome ou le devoir de la prise en compte d'une exposition dynamique

POPs

IMPREGNATION



Scénario d'un enfant allaité 12 mois

Scénario d'un enfant non allaité

1T 2T 3T 1y 2y 3y 4y 5y 6y 7y 8y

pregnancy

birth

childhood

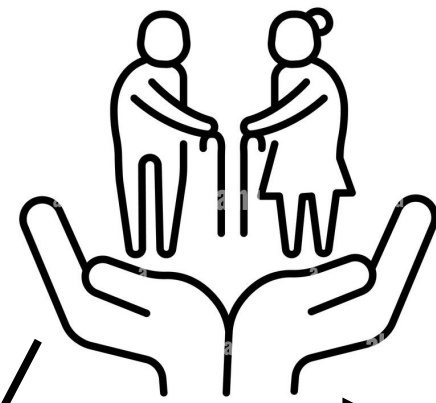

LES DETERMINANTS ALIMENTAIRES DE L'EXPOSOME

L'exposome ou le devoir de la prise en compte d'une exposition dynamique

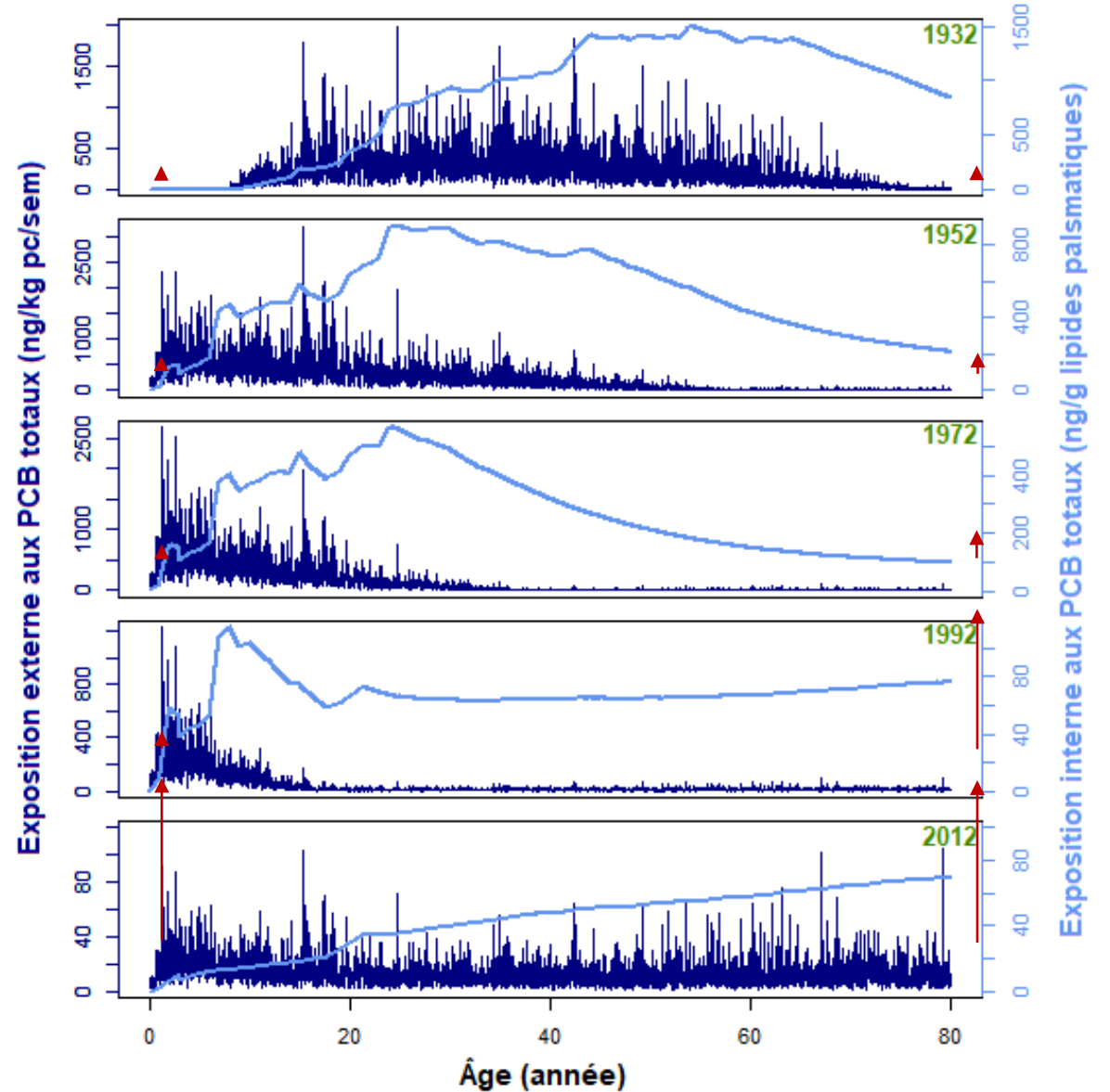
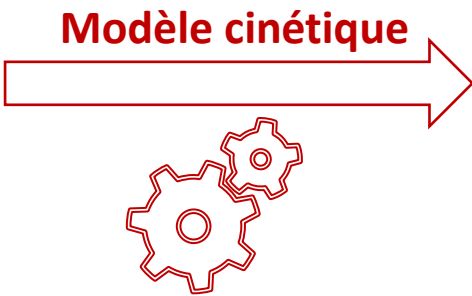
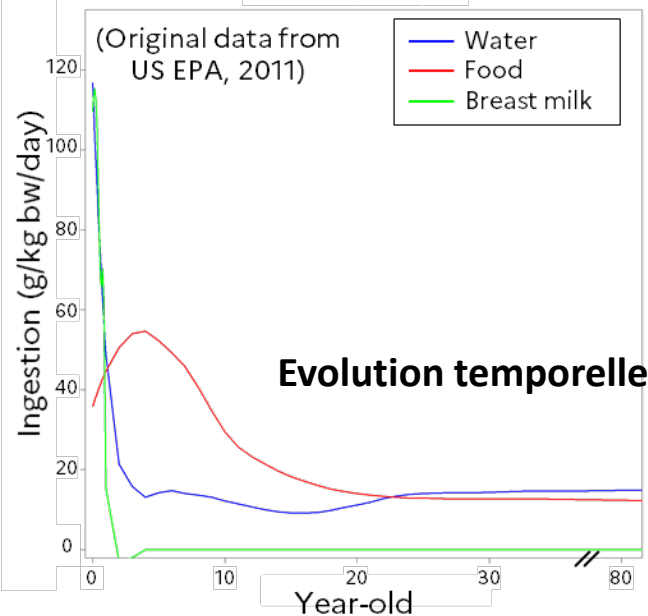
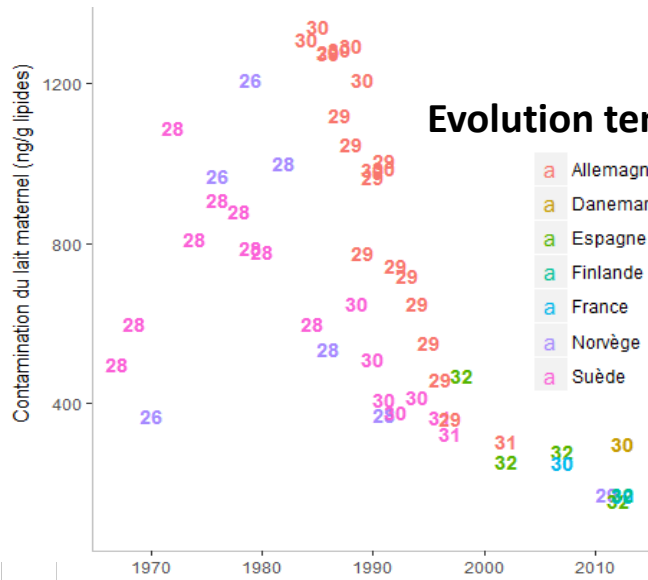

LES DETERMINANTS ALIMENTAIRES DE L'EXPOSOME

Interprétation de la trajectoire d'exposition vie entière vis-à-vis des dépassements de VTR ?

DOSE EXTERNE

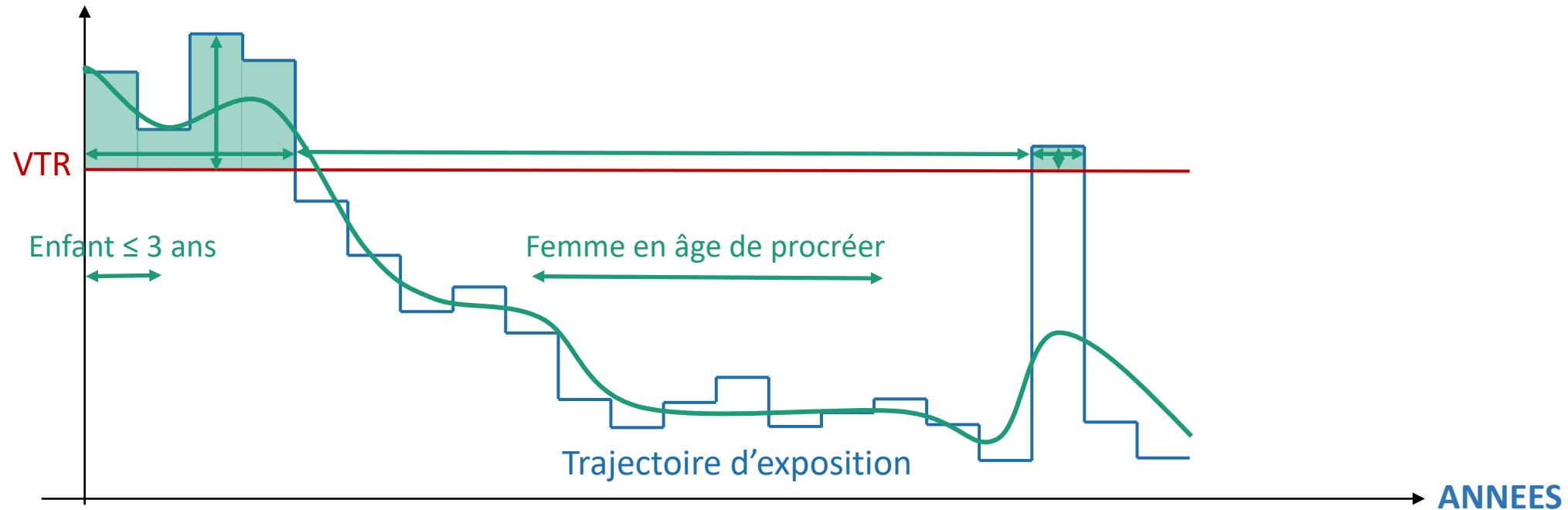

- Somme des durées de dépassement VTR vie entière ?
- Âge auquel le dépassement est le plus long ?
- Impact de la durée sous VTR entre deux dépassements ?
- Durée du dépassement à certaines périodes critiques de la vie ?
- Amplitude et durée du dépassement ?

LES DETERMINANTS ALIMENTAIRES DE L'EXPOSOME

Comment élargir la fenêtre de l'exposome alimentaire ?

ENVIRONMENTAL DATA



ECOTOXICOLOGICAL DATA



HUMAN CLINICAL DATA



BIOMONITORING DATA



DATA FROM AGENCIES
(e.g. REACH)

DATA FROM AGENCIES
(e.g. EFSA)







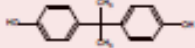
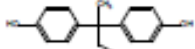

ARTICLES, PROCEEDINGS,
POSTERS

PRESS RELEASES

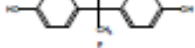

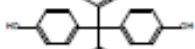
LES DETERMINANTS ALIMENTAIRES DE L'EXPOSOME

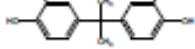
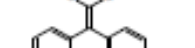
Extension des limites d'une famille de substances chimiques, par exemple du BPA aux BPs...

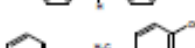
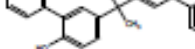
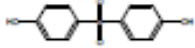
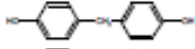
Molécule	Abbreviation	CAS Number	Structure	Monoisotopic mass (amu)
Bisphenol A 2,2-Bis(4-hydroxyphenyl)propane	BPA	80-05-7		228.2863
Bisphenol B 2,2-Bis(4-hydroxyphenyl)butane	BPB	77-40-7		242.3188
Bisphenol AP 1,1-Bis(4-hydroxyphenyl)-1-phenyl-ethane	BPAP	1571-75-1		290.3629
Bisphenol AF 2,2-Bis(4-hydroxyphenyl)hexafluoropropane	BPAF	1478-61-1		336.2343
Bisphenol BP Bis-(4-hydroxyphenyl)diphenylmethane	BPBP	1844-01-5		352.4341
Bisphenol C 2,2-Bis(3-methyl-4-hydroxyphenyl)propane	BPC	79-97-0		256.3458
Bisphenol Cl2 Bis(4-hydroxyphenyl)-2,2-dichloroethylene	BPCl2	14868-03-2		281.1384
Bisphenol E 1,1-Bis(4-hydroxyphenyl)ethane	BPE	2081-08-5		214.2648
Bisphenol PH 5,5'-(1-Methylethylidene)-bis[1,1'-(biphenyl)-2-yl]propane	BPPH	24038-68-4		380.4880
Bisphenol 3 Bis(4-hydroxyphenyl)sulfone	BPS	80-09-1		250.2714
Bisphenol F Bis(4-hydroxyphenyl)methane	BPF	1333-16-0		200.2332
DHDPE 4,4'-Dihydroxydiphenyl ether	DHDPE	1965-09-9		202.2060
Bisphenol FL 9,9'-Bis(4-hydroxyphenyl)fluorene	BPFL	3236-71-3		350.4181
Bisphenol Z 1,1-Bis(4-hydroxyphenyl)-cyclohexane	BPZ	843-55-0		268.3568
Biphenyl-4,4'-diol	BP4,4'	92-88-6		186.2066

Molécule	Transition 1	Collision energy T1 (eV)	Transition 2	Collision energy T2 (eV)	Retention time (min)
¹³ C ₁₂ -Bisphenol A (Internal Standard)	369.2>197.2	20	384.2>369.2	12	11.12
Biphenyl-2,2'-diol (External Standard)	330.2>315.2	12			7.79
Bisphenol A	357.2>191.2	20	372.2>357.2	12	11.12
Bisphenol B	386.2>357.2	10	371.3>221.3	12	11.53
Bisphenol AP	434.2>419.3	10	419.3>341.2	20	14.09
Bisphenol AF	480.3>411.2	15	465.3>315.1	12	9.06
Bisphenol BP	496.4>419.2	12	419.2>253.2	20	17.68
Bisphenol C	385.3>205.2	20	400.4>385.3	12	11.41
Bisphenol C2	426.2>261.1	25	424.2>409.1	15	12.59
Bisphenol E	343.2>193.2	12	358.3>343.2	15	11.05
Bisphenol PH	509.4>267.2	25	524.4>509.4	15	17.92
Bisphenol S	394.2>229.2	20	394.2>379.2	12	14.53
Bisphenol F	344.2>179.2	15	329.3>179.2	12	10.92
DHDPE	346.2>181.2	15	331.2>181.2	10	10.78
Bisphenol FL	494.4>329.2	25	494.4>313.1	25	21.32
Bisphenol Z	412.3>369.2	12	412.3>203.2	25	13.39
Biphenyl-4,4'-diol	330.2>315.2	12	330.2>299.2	25	10.92
Bisphenol M	490.4>475.4	15	475.4>445.3	30	14.83
Bisphenol P	490.4>475.4	15	475.4>445.3	30	16.83
Bis-(hydroxyphenyl)methane	344.2>329.2	10	344.2>241.2	12	9.41

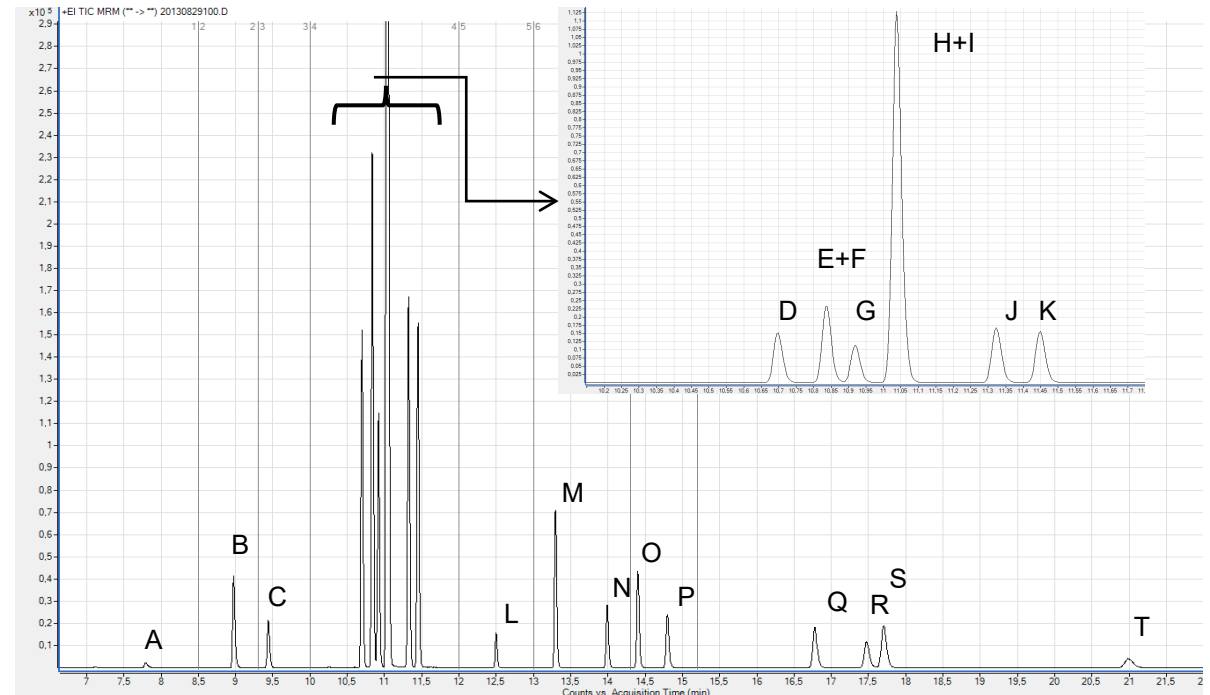

LES DETERMINANTS ALIMENTAIRES DE L'EXPOSOME

Au fil de l'eau agrégation de substances chimiques émergentes ou nouvelles, e.g. RFBs by EFSA



SCIENTIFIC OPINION

Scientific Opinion on Emerging and Novel Brominated Flame Retardants (BFRs) in Food¹

EFSA Journal 2012;10(10):2908

EMERGING

Chemicals, applied as flame retardants, that have been identified in any environmental compartment (air, soil, sediment, water or dust) and/or in wildlife, food or humans.

BFRs considered in the opinion



17 emerging BFRs

Emerging BFRs

BEH-TEBP	Bis(2-ethylhexyl) tetrabromophthalate
BTBPE	1,2-Bis(2,4,6-tribromophenoxy)ethane
DBDPE	Decabromodiphenyl ethane
DBE-DBCH	4-(1,2-Dibromoethyl)-1,2-dibromocyclohexane
DBHCTD	5,6-Dibromo-1,10,11,12,13,13-hexachloro-11-tricyclo[8.2.1.0 ^{2,9}]tridecene
EH-TBB	2-Ethylhexyl 2,3,4,5-tetrabromobenzoate
HBB	1,2,3,4,5,6-Hexabromobenzene
HCTBPH	1,2,3,4,7,7-Hexachloro-5-(2,3,4,5-tetra-bromophenyl)- bicyclo[2.2.1]hept-2-ene
OBTMPI	Octabromotrimethylphenyl indane
PBB-Acr	Pentabromobenzyl acrylate
PBEB	Pentabromoethylbenzene
PBT	Pentabromotoluene
TBNPA	Tribromoneopentyl alcohol
TDBP-TAZTO	1,3,5-Tris(2,3-dibromopropyl)-1,3,5-triazine-2,4,6-trione
TBCO	1,2,5,6-Tetrabromocyclooctane
TBX	1,2,4,5-Tetrabromo-3,6-dimethylbenzene
TDBPP	Tris(2,3-dibromopropyl) phosphate

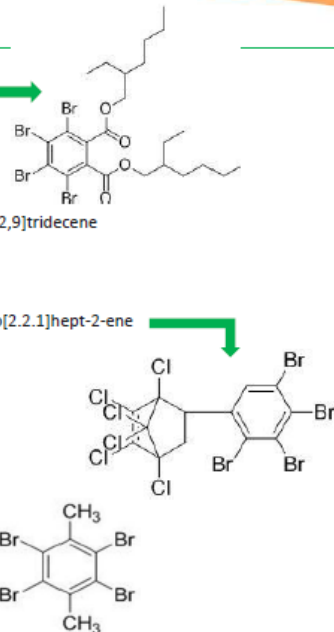

NOVELS

Chemicals for which there is evidence that they are applied as BFRs, and confirmed presence in materials and/or goods in concentrations above 0.1%.

BFRs considered in the opinion



10 Novel BFRs

Novel BFRs

BDBP-TAZTO	1,3-Bis(2,3-dibromopropyl)-5-allyl-1,3,5-triazine-2,4,6(1H,3H,5H)-trione
DBNPG	Dibromoneopentyl glycol
DBP-TAZTO	1-(2,3-Dibromopropyl)-3,5-diallyl-1,3,5-triazine-2,4,6(1H,3H,5H)-trione
DBS	Dibromostyrene
EBTEBPI	N,N'-Ethylenebis(tetrabromophthalimide)
HBCYD	Hexabromocyclodecane
HEEHP-TEBP	2-(2-Hydroxyethoxy)ethyl 2-hydroxypropyl 3,4,5,6-tetrabromophthalate
4'-PeBPO-BDE208	Tetradecabromo-1,4-diphenoxybenzene
TTBNPP	Tris(tribromoneopentyl) phosphate
TTBP-TAZ	Tris(2,4,6-tribromophenoxy)-s-triazine

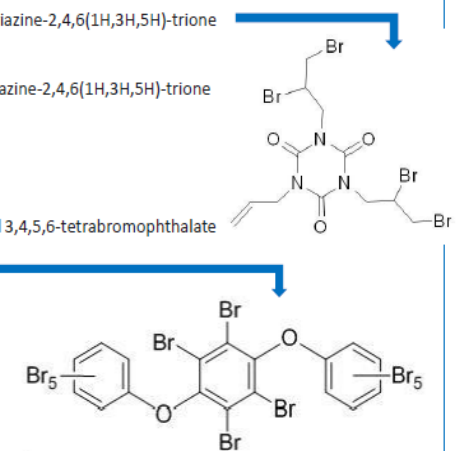

Abbreviations according to Bergman et al. (2012)

LES DETERMINANTS ALIMENTAIRES DE L'EXPOSOME

Au fil de l'eau agrégation de substances chimiques considérées comme potentiels risques émergents

Liste des 212 substances chimiques prioritaires identifiées comme présentant des risques émergents potentiels.

- (a) susceptibles d'être rejetées dans l'environnement et/ou d'être difficilement biodégradables,
- (b) présentant un potentiel de bioaccumulation dans la chaîne alimentaire,
- (c) présentant un risque toxicologique chronique (CMR ou toxicité à doses répétées).

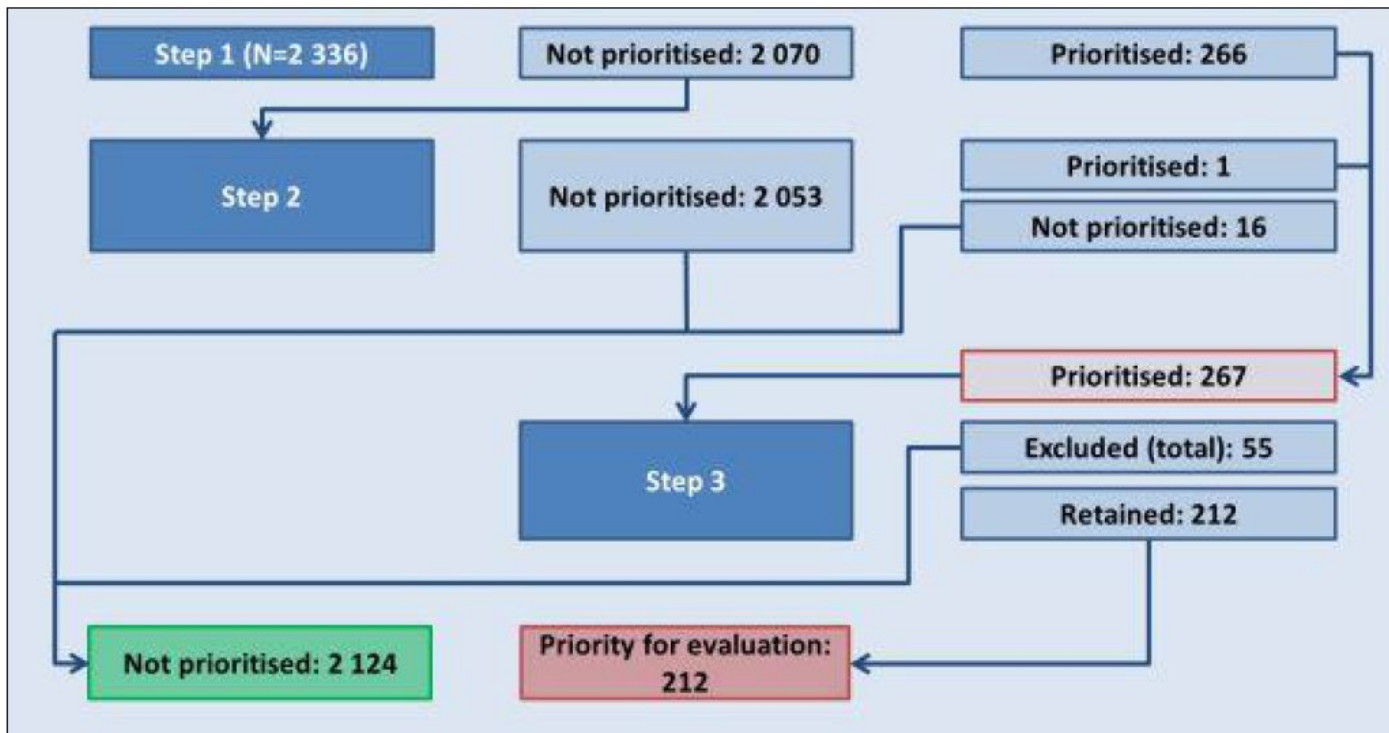

Oltmanns J. et al. Final Report: Applying a tested procedure for the identification of potential emerging chemical risks in the food chain to the substances registered under REACH – REACH 2 External scientific report. OC/EFSA/SCER/2016/01-CT1

Figure 41: Prioritisation workflow with number of prioritised substances. See section 3.4.4 for details on steps 1-3.

LES DETERMINANTS ALIMENTAIRES DE L'EXPOSOME

Quid des dangers chimiques qui ne sont pas encore connus ?

~ 4 700 chemicals with a use over 100 tonnes per year prioritised in hazard characterisation and evaluation

100,000 chemicals on the market

60 % du volume des produits chimiques dans l'UE classés dangereux pour la santé humaine et 35 % dangereux pour l'environnement

500 perfectly characterized chemicals: expo+tox

10,000 chemicals fairly well characterized

20,000 chemicals poorly characterized

70,000 uncharacterized chemical products

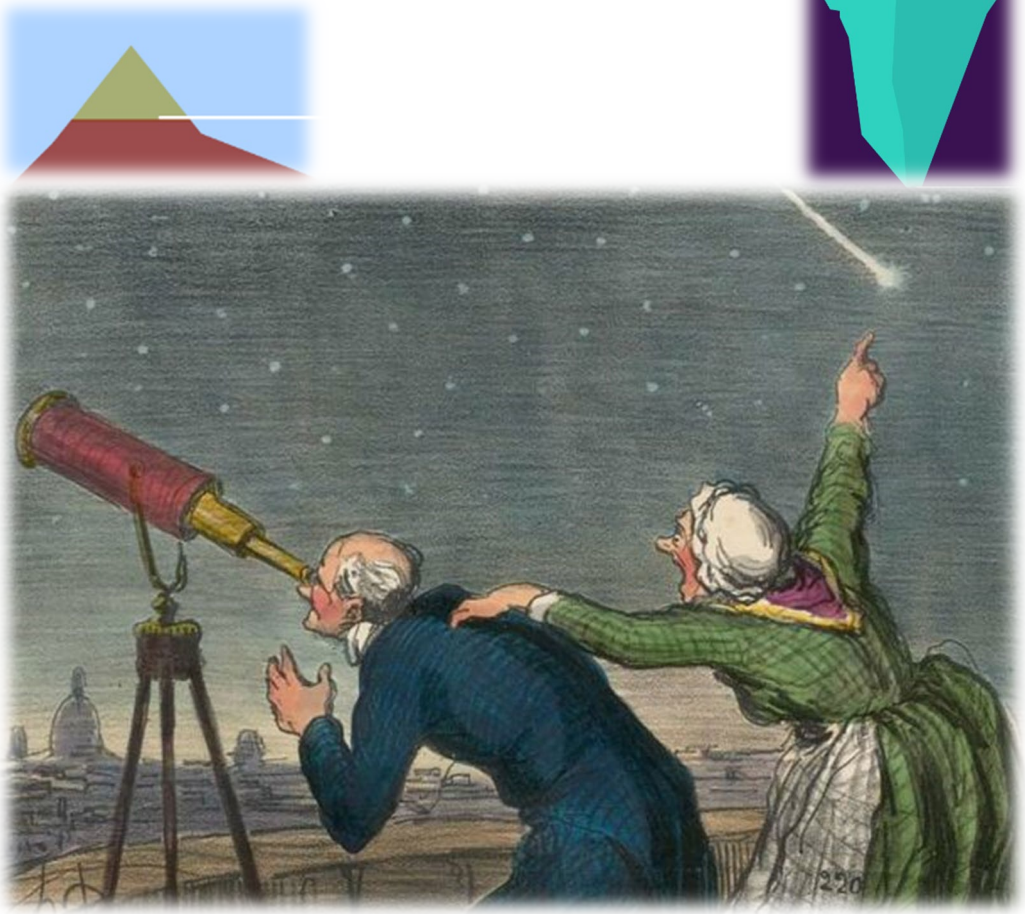

« Monsieur Babinet prévenu par sa portière de la visite de la comète ». Lithographie d'Honoré Daumier (1808-1879) publiée dans *Le Charivari* du 22 septembre 1858 (actualités n° 556).

The unknown territory of chemical risks, EEA

LES DETERMINANTS ALIMENTAIRES DE L'EXPOSOME

Quelles stratégies ?

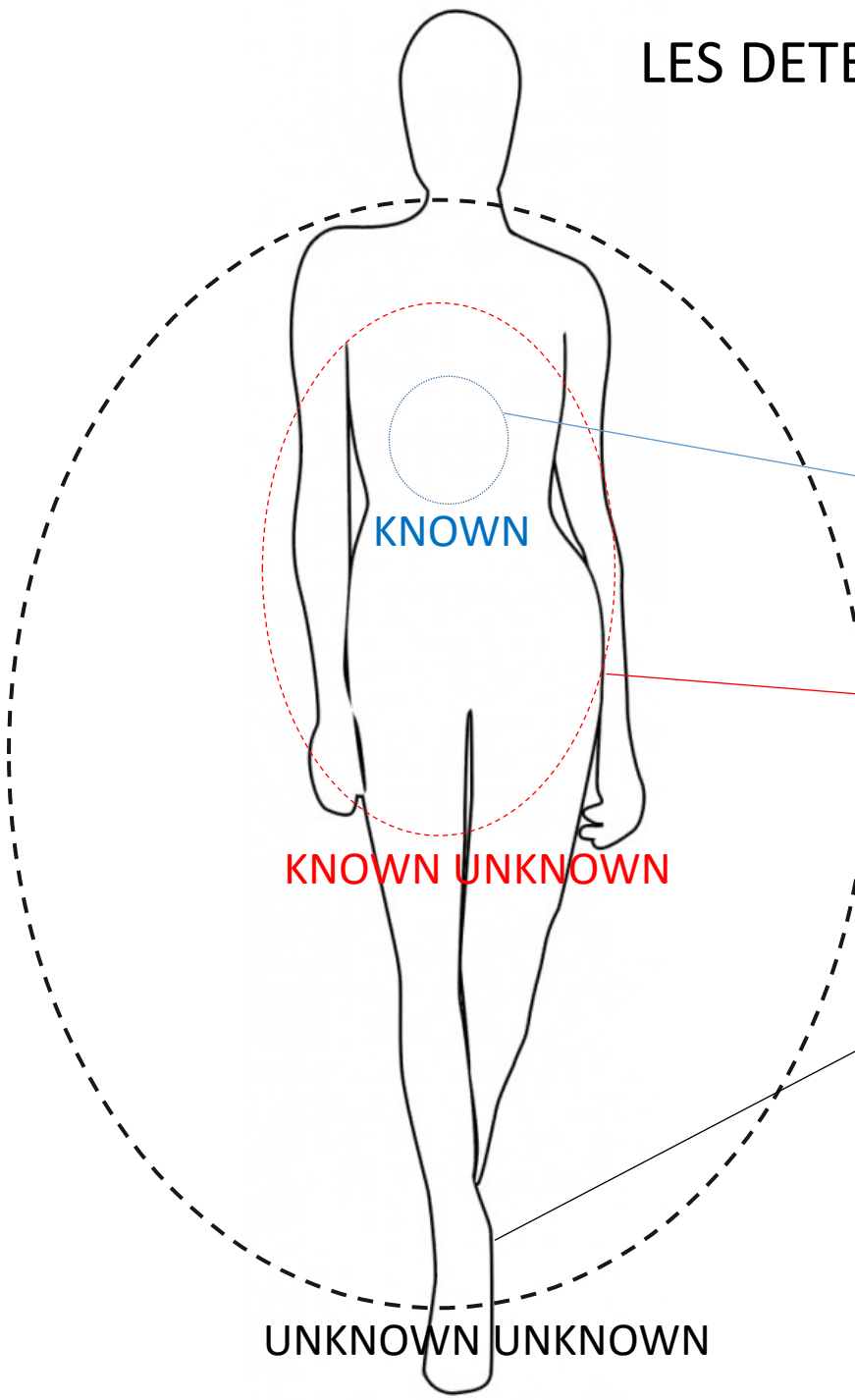

APPROCHES CIBLEES

Méthode ciblée et quantitative bien établie

CRIBLAGE SUSPECT

Structure connue mais pas encore de méthode quantitative établie

CRIBLAGE NON CIBLE

Marqueur d'exposition encore inconnu

Identification

Quantification

Marker coverage

+++

+++

+/-

++

+/-

++

+/-

-

+++

UNKNOWN UNKNOWN

LES DETERMINANTS ALIMENTAIRES DE L'EXPOSOME

Technologies de mesure et algorithmes de fouille en constante évolution... Impact sur la recherche d'émergences ?

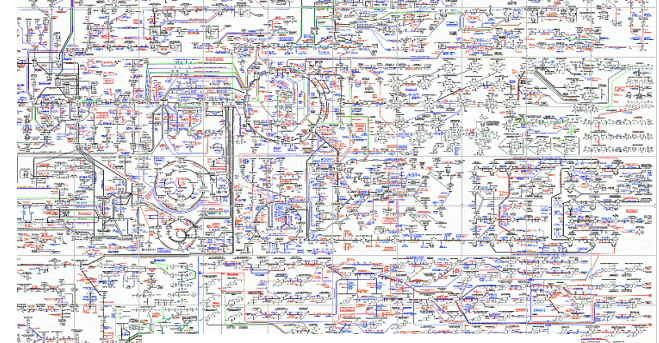
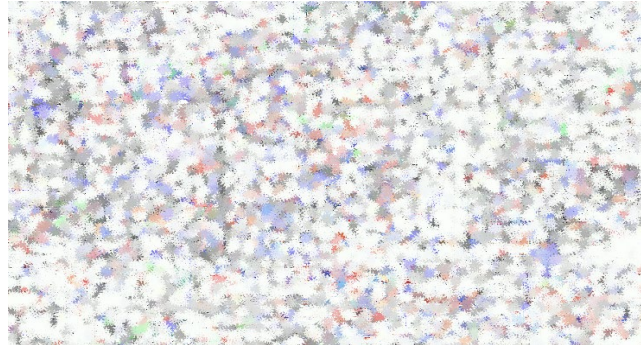

QUADRIPOLE

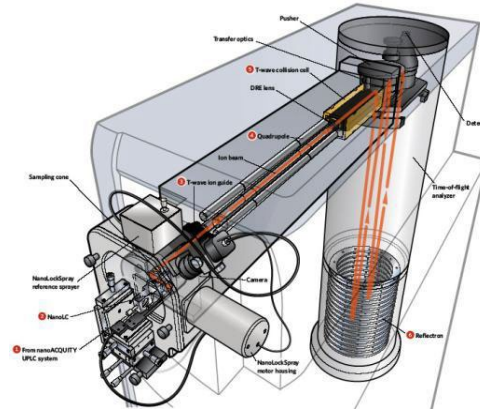

TOF

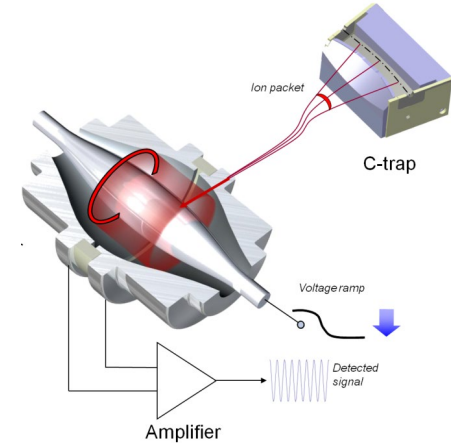

ORBITRAP



LES DETERMINANTS ALIMENTAIRES DE L'EXPOSOME

Principe des approches de suspect screening

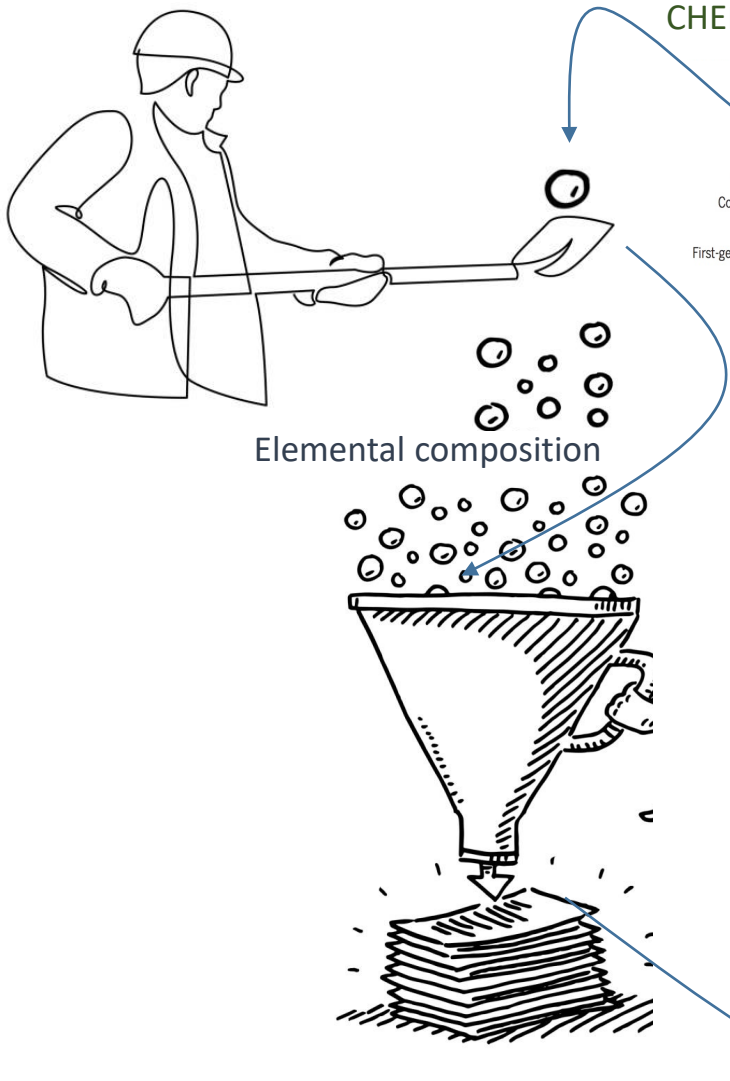
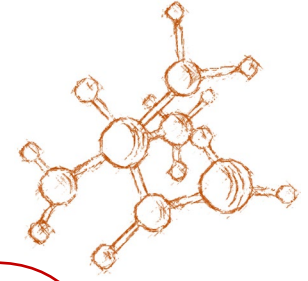

CHEMICAL DATA SOURCES

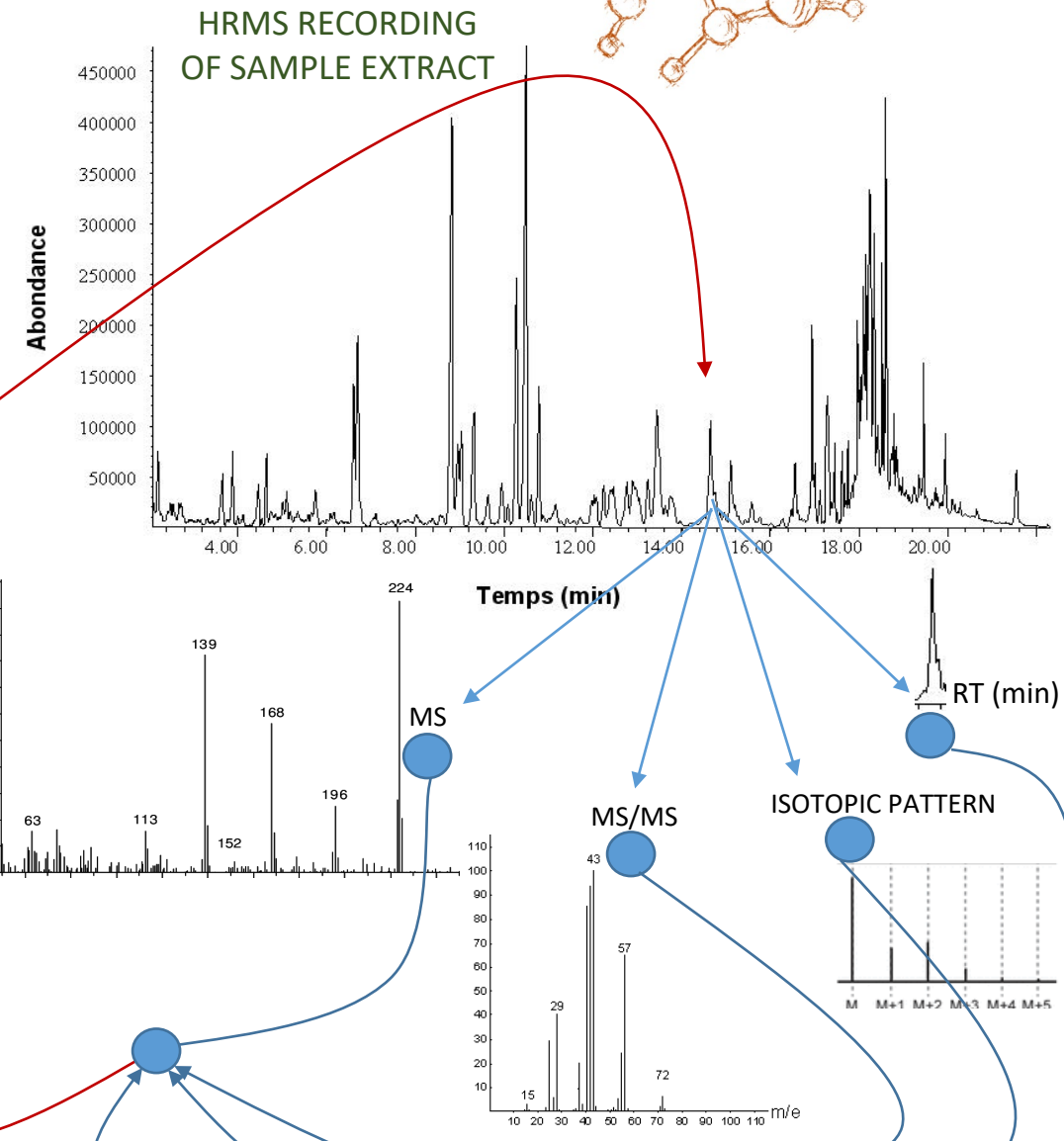
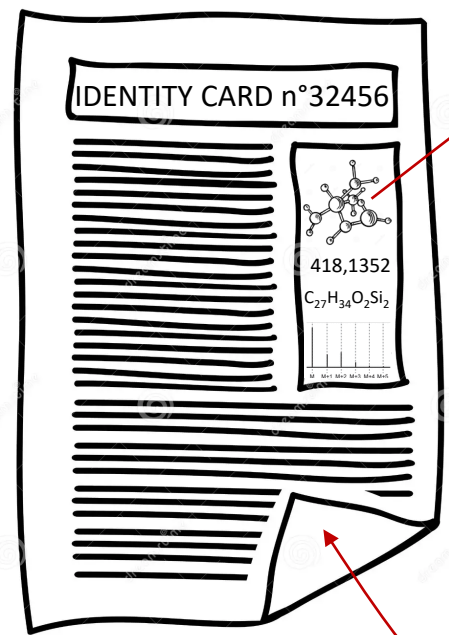
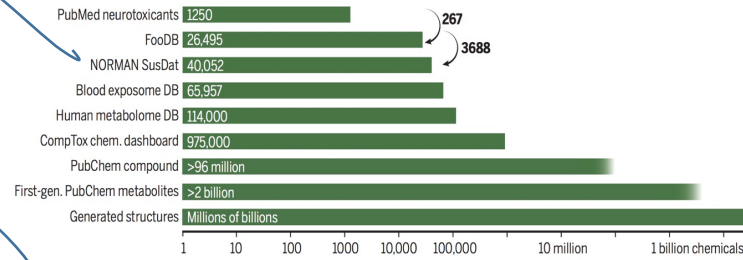

MATCHING FACTOR

- Calculation of theoretical accurate masses
- Simulation of isotopic pattern, potential adducts & MS/MS fragments
- Retention Times simulation

LES DETERMINANTS ALIMENTAIRES DE L'EXPOSOME

Recherche d'émergences potentielles dans les écosystèmes environnementaux

SENTINELLE

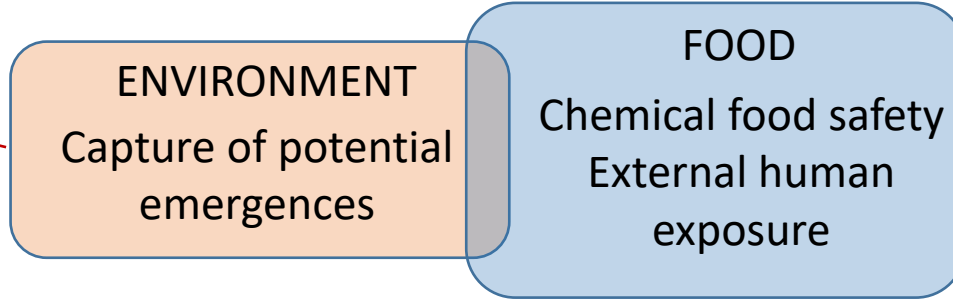

OBJECTIVATION

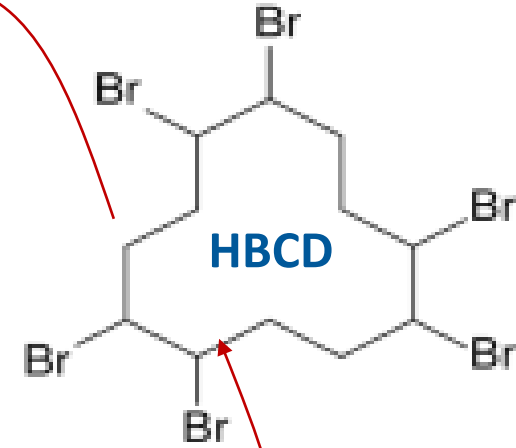

Oeuf de goéland

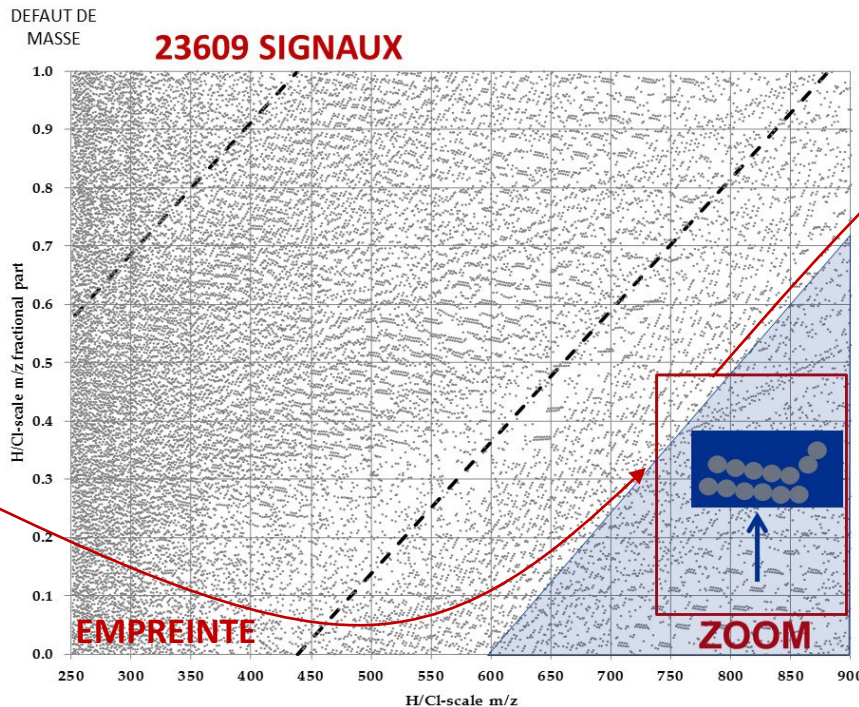

DECONVOLUTION

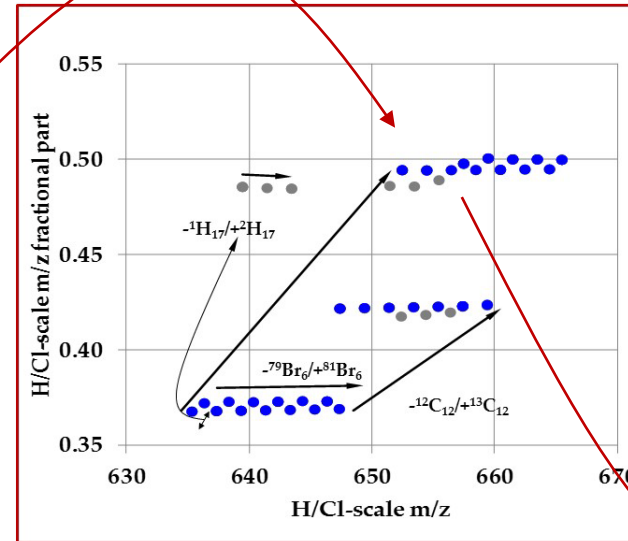

IDENTIFICATION

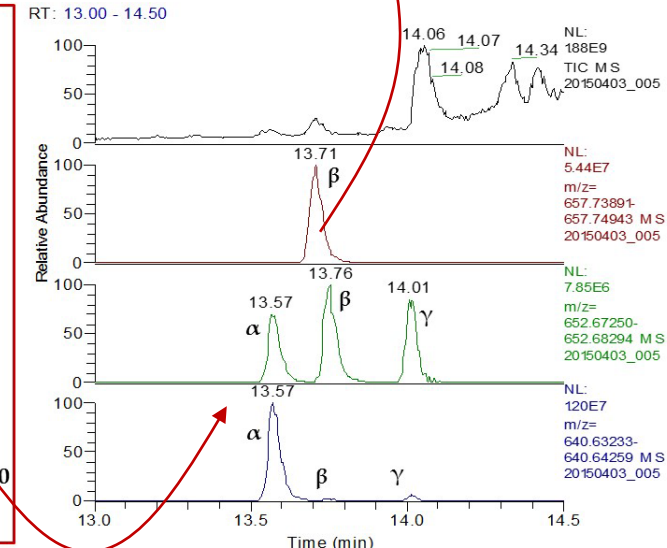

DETECTION

LES DETERMINANTS ALIMENTAIRES DE L'EXPOSOME

Nécessité de recourir à une approche inter/transdisciplinaires, quitter les approches en silo

ALIMENTATION

Continuum

ENV-ALIM-SANTE

SANTE HUMAINE

ENVIRONNEMENT



ARMAN (1928-2005)

INTERACTIVE TRYPHIQUE VASE, 2005

3 sections of a porcelain vase articulated, Sèvres blue and gold

Global Objective

Consolider et renforcer la capacité de R&I de l'UE en matière d'AR chimique afin de protéger la santé humaine et l'environnement et de contribuer à un environnement non toxique et à une économie circulaire.



OBJECTIVE
RESEARCH & INNOVATION
TOWARDS NEXT GENERATION
RISK ASSESSMENT

Composantes de l'exposome à introduire progressivement dans les futures ERS

ERS
demain

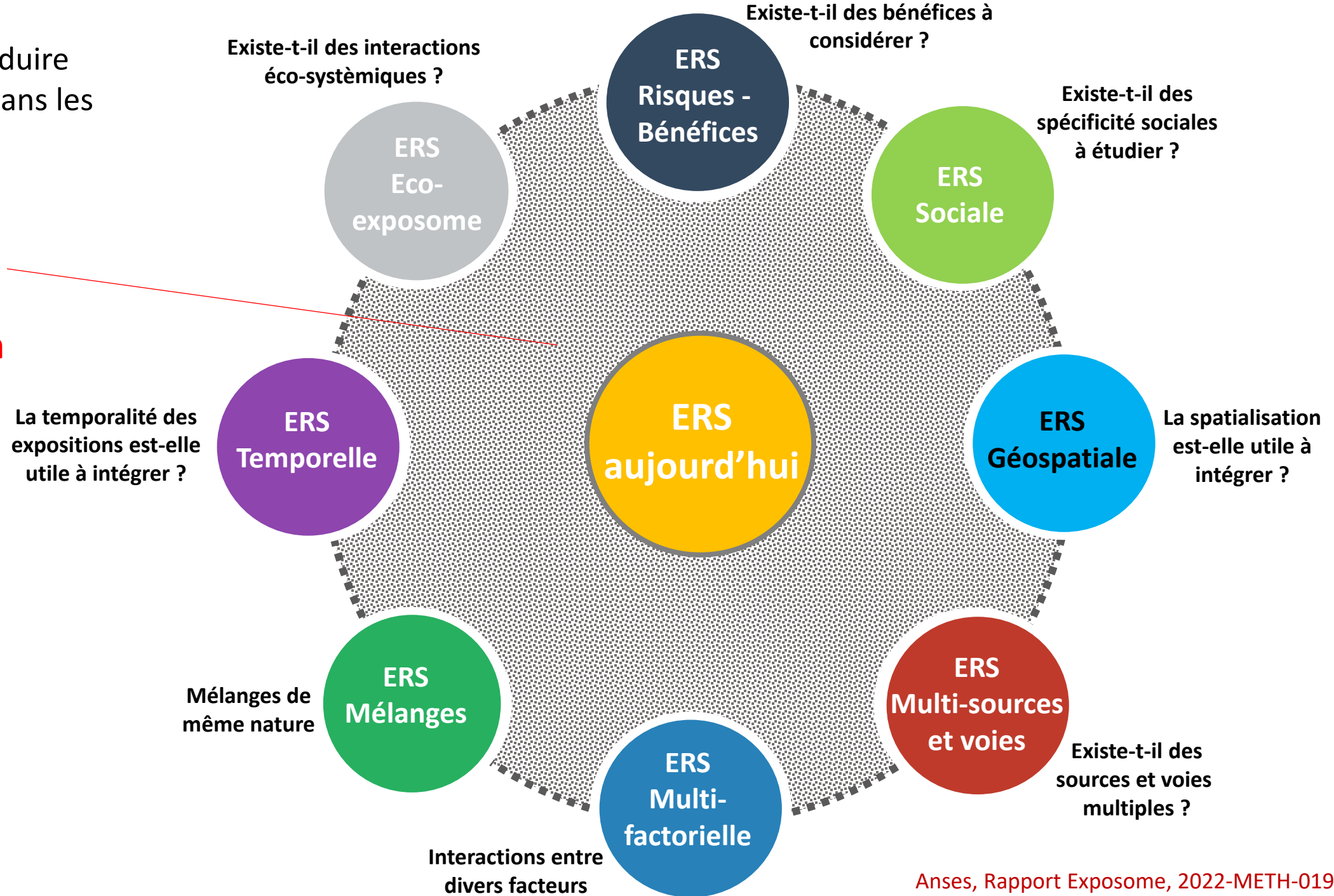

Approche modulaire pour une ERS Exposome

Niveau de complexité

- ↗ nombre de données, du temps & des ressources
- ↗ incertitudes liées à la combinaison de données & de modèles

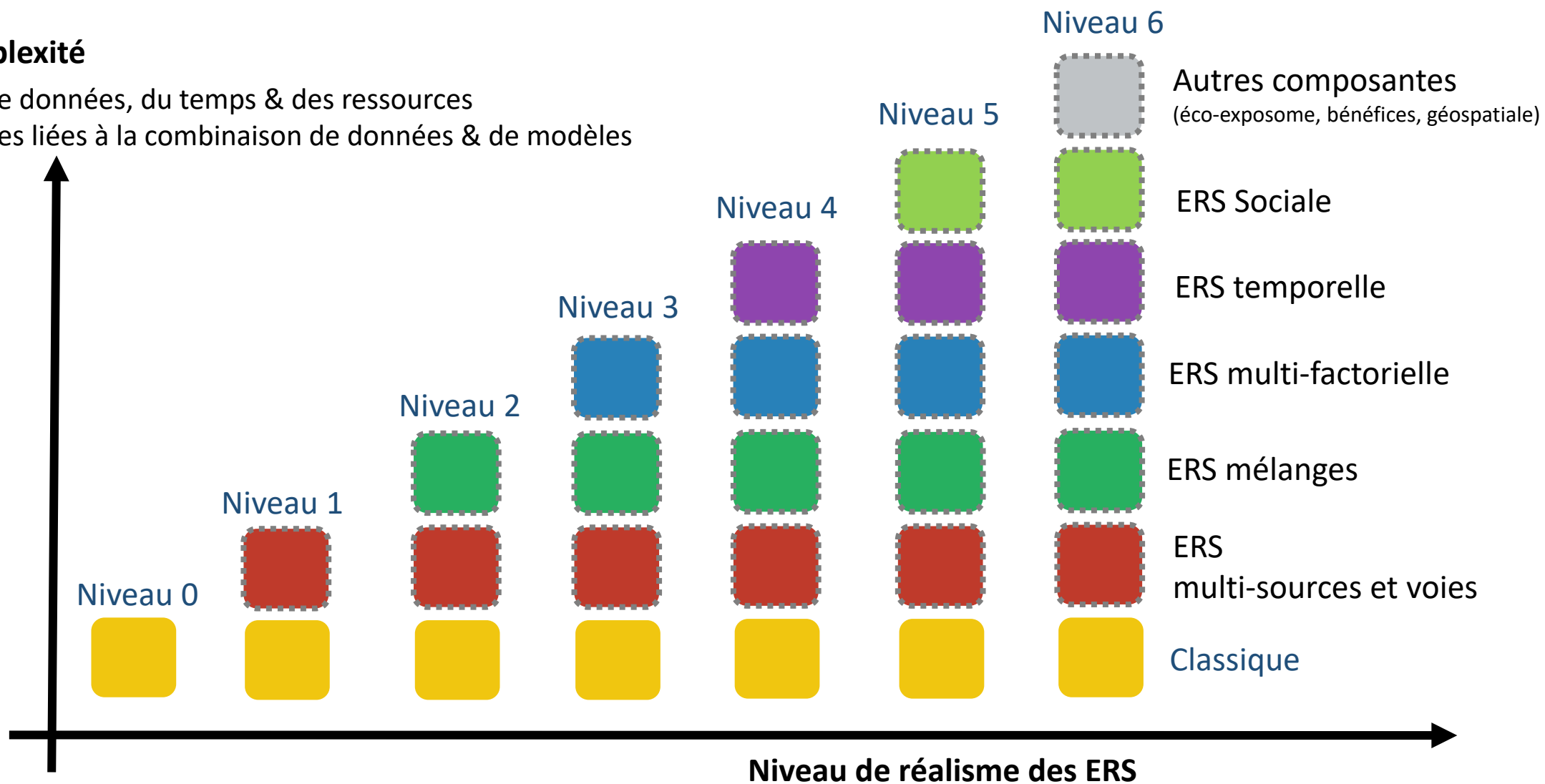

Niveau de réalisme des ERS

- Réduction des incertitudes autour de l'exposition réelle
- Augmentation de la connaissance de l'exposition totale
- Prise en compte du contexte global
- Médecine individualisée et prévention de précision

SYSTÈME D'ALERTE PRÉCOCE

ANALYSE DE L'HORIZON

LA CONNAISSANCE DE L'EXPOSITION EST AMÉLIORÉE PAR STRATÉGIES DE R&D type SS/NTS.

PRÈS DE 1 000 SUBSTANCES CHIMIQUES SONT ASSEZ BIEN CONNUES DANS L'EXPOSOME CHIMIQUE ALIMENTAIRE

LES MODÈLES TK PEUVENT ÊTRE UTILISÉS POUR DÉTERMINER LA NATURE DES SOURCES

LA RÉALITÉ DE L'EXPOSITION PEUT D'ABORD ÊTRE RÉVÉLÉE EN EXPLORANT LA COMPOSANTE INTERNE DE L'EXPOSITION HUMAINE.

MERCI POUR VOTRE ECOUTE



EXPOSOME & ALIMENTATION

Définition et enjeux

EXPOSITION & POLLUTION – NICE – 27.05.2024

UNIVERSITÉ CÔTE D'AZUR
Initiative d'Excellence

FRANCE 2030

cnrs

IRD Institut de Recherche pour le Développement FRANCE

JOURNÉE THÉMATIQUE
de l'Académie "Espace, Environnement, Risques et Résilience"

EXPOSITION & POLLUTION

Lundi 27 Mai 2024
Parc Phoenix, Nice



Bruno LE BIZEC, PROF