



**HAL**  
open science

## Trajectories for Sustainable Motorized Pilling in Sub-Saharan Africa: Advantages and Disadvantages

Wilfried Agbasse, Christelle Sandra Ayina Boko, Amagbégnon Edna Zimonse, Gontrand Comlan Bagan

### ► To cite this version:

Wilfried Agbasse, Christelle Sandra Ayina Boko, Amagbégnon Edna Zimonse, Gontrand Comlan Bagan. Trajectories for Sustainable Motorized Pilling in Sub-Saharan Africa: Advantages and Disadvantages: Machinery of plowing. *Journal of Experimental Agriculture International*, 2024, 46, pp.354 - 373. 10.9734/jeai/2024/v46i72591 . hal-04617316

**HAL Id: hal-04617316**

**<https://hal.science/hal-04617316>**

Submitted on 19 Jun 2024

**HAL** is a multi-disciplinary open access archive for the deposit and dissemination of scientific research documents, whether they are published or not. The documents may come from teaching and research institutions in France or abroad, or from public or private research centers.

L'archive ouverte pluridisciplinaire **HAL**, est destinée au dépôt et à la diffusion de documents scientifiques de niveau recherche, publiés ou non, émanant des établissements d'enseignement et de recherche français ou étrangers, des laboratoires publics ou privés.



# Trajectories for Sustainable Motorized Pilling in Sub-Saharan Africa: Advantages and Disadvantages

Wilfried Agbasse <sup>a\*</sup>, Christelle Sandra Ayina. Boko <sup>a</sup>,  
Amagbégnon Edna Zimonse <sup>a</sup>  
and Gontrand Comlan. Bagan <sup>a</sup>

<sup>a</sup> Rural Engineering Laboratory, National University of Agriculture, Benin.

## Authors' contributions

This work was carried out in collaboration among all authors. All authors read and approved the final manuscript.

## Article Information

DOI: <https://doi.org/10.9734/jeai/2024/v46i72591>

## Open Peer Review History:

This journal follows the Advanced Open Peer Review policy. Identity of the Reviewers, Editor(s) and additional Reviewers, peer review comments, different versions of the manuscript, comments of the editors, etc are available here: <https://www.sdiarticle5.com/review-history/117754>

Original Research Article

Received: 08/04/2024  
Accepted: 11/06/2024  
Published: 18/06/2024

## ABSTRACT

Four trajectories for motorized plowing were compared on sandy loamy soil in the Benin plateau in order to identify the most effective. We have: Flat plowing (LP), Backing board plowing (LPA), Splitting board plowing (LPR) and alternating superimposed plowing (LAS). A randomized complete block design with three repetitions was experimented with a 60 HP tractor coupled to a 1 m three-share plow at a speed of 6 km/h. Fifteen plots of 300 m<sup>2</sup> each divided into 3 blocks of 5 named plots (S0: control, S1: LP, S2: LPA, S3: LPR and S4: LAS) were used to execute the trajectories. The agroeconomic parameters considered are: soil texture, wheel slip, fuel consumption, effective-lost-total plowing time, time efficiency and field capacity. The results indicate that the LAS trajectory is advantageous in the case where plowing is carried out with a reversible plow or with a tiller because it has an average consumption of 5845.17 g/ha, an average plowing time of 284 s with an

\*Corresponding author: E-mail: [wagbasse21@gmail.com](mailto:wagbasse21@gmail.com);

efficiency average of 58.34%. With the simple plow, simultaneously the LPA trajectory (6246.04 g/ha, 270 s and 56.3%) is more economical than the LPR trajectory (6593.81 g/ha, 306 s and 54.17%). This work will help tractor operators and producers perform economical motorized plowing.

*Keywords: Soil work; route; economy; decision; yield.*

## 1. INTRODUCTION

Lplowing is a soil working operation carried out with a plow ; it consists of opening the earth to a certain depth, turning it over, before sowing or planting it Wikipedia [1]. It is made mechanized thanks to the advent of new technologies.

Some of the most important objectives of tillage models are to minimize the number of revolutions and dead spaces but also to maximize the length of tillage cycles. Optimal motorized plowing not only reduces the time spent on non-productive work but also the fuel consumption of the power unit. This optimization also depends on the choice of the plowing trajectory, that is to say choosing an appropriate trajectory that can make it possible to reduce as much as possible the time lost during plowing, fuel consumption but also to increase efficiency and the field capacity of the tractor. Lack of understanding of the advantages and disadvantages of trajectories for motorized plowing by tractor drivers results in difficulties in carrying out economical tillage operations. It is with this in mind to increase the efficiency and field capacity of the tractor that Zenebe and Chernet [2] comparatively evaluated five designs of alternative plowing models in a sugar estate in Metahara in Ethiopia. The results indicated thatThe model for plowing headlands from ridges offers better time efficiency and good effective capacity than the other models evaluated. Thus the selection of an economical trajectory for motorized plowing may be necessary not only to increase productivity but also to minimize the cost of production. Fuel consumption and tillage time can be minimized by applying an appropriate tillage pattern during the tillage operation [3]. Also, non-productive passes in the field not only cause excessive soil compaction due to repeated turning maneuvers [4] but also increase fuel consumption, labor demands and the workload of operators [5-18]. In order to enable tractor operators to carry out economical motorized plowing, we have chosen to carry out the study whose theme is "Trajectories for motorized plowing : advantages and disadvantages". The objective of this study is todistinguish the most economical trajectory

during motorized plowing. The general objective of this study is to distinguish the most economical trajectory during the execution of motorized plowing. The areas of work to achieve the general objective are to : specify the different trajectories for motorized plowing ; determine the agronomic and economic parameters on each plot ; and designate the best trajectory for motorized plowing.

## 2. MATERIALS AND METHODS

### 2.1 Presentation of the Study Site

The study site is located in Awai in the district of Kétou, commune of Kétou at the northern end of the Plateau department. The site has geographical coordinates : 7°41'30" North and 2°63'08" East. The commune of Kétou covers an area of 1775 km<sup>2</sup> [6], or 1.55% of the national territory and 54.38% of the Plateau department. It is limited to the north by the commune of Savè, to the south by the commune of Pobè, to the west by the communes of Zangnanado and Ouinhi and to the east by the Federal Republic of Nigeria [7]. The climate is tropical with a bimodal rainfall regime with two shades (middle Zou and the southeastern plateaus), a long rainy season: March to July, a short dry season: August, a short rainy season: September to October and a long dry season: November to February. The annual rainfall average is around 1073 mm in 65 days [8]. The two maxima of this regime are centered on June and September.The soils of the commune are essentially of the slightly desaturated ferralitic type and in places of the well-drained tropical ferruginous type.

### 2.2 Specification of Different Trajectories for Motorized Plowing

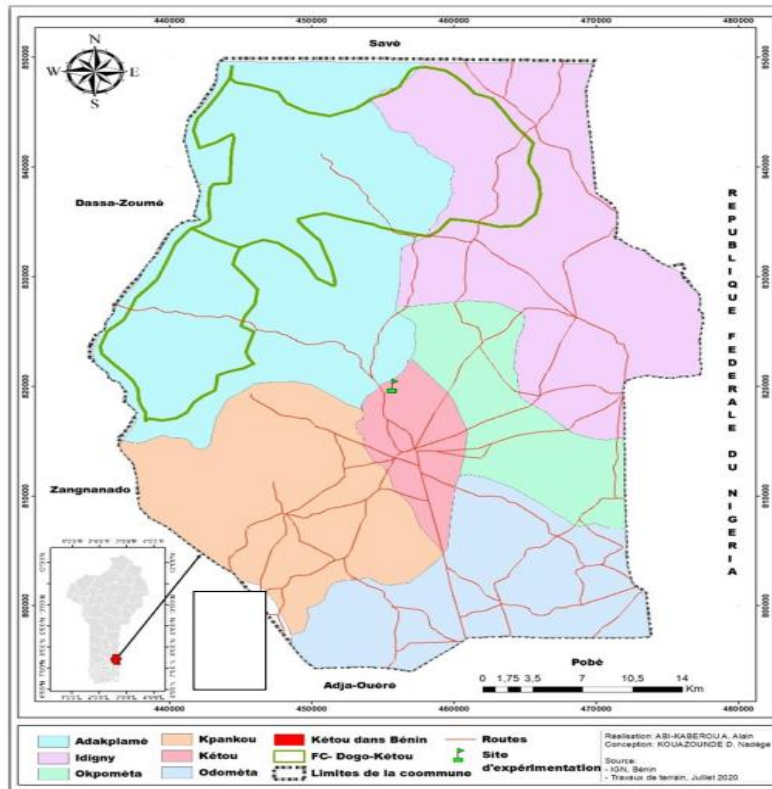
In this study, the trajectories for motorized plowing to be tested are as follows :

### 2.3 Description of the Experimental Protocol

The experiment consists of executing the four trajectories for motorized plowing mentioned

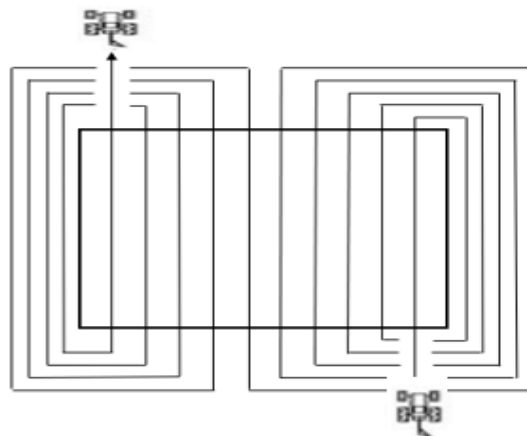
above at a speed of 6 km/h. These trajectories for motorized plowing are carried out successively on 15 plots of surface area 300 m<sup>2</sup> each divided into 3 blocks of 5 plots, separated by 5 m alleys to facilitate the passage of the tractor and delimited by stakes. The plots are designated S0, S1, S2, S3 and S4. The S0 plot served as a control and the others are characterized respectively by the LP, LPA, LPR

and LAS trajectories. The experimental plan adopted is a randomized complete block design with three (03) repetitions (Fig 6). For the experimentation of the different trajectories for plowing, we used a MAHINDRA 605 DI tractor with an engine speed of 1100 rpm with the second gear at the fast range 6km/h.



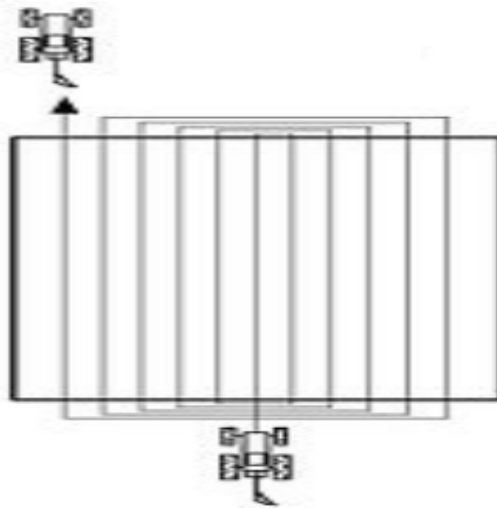
**Fig. 1. Geographic location of the study site**

Source: IGN 2023, (National Institute of Geographic and Forest information), Benin Plateau

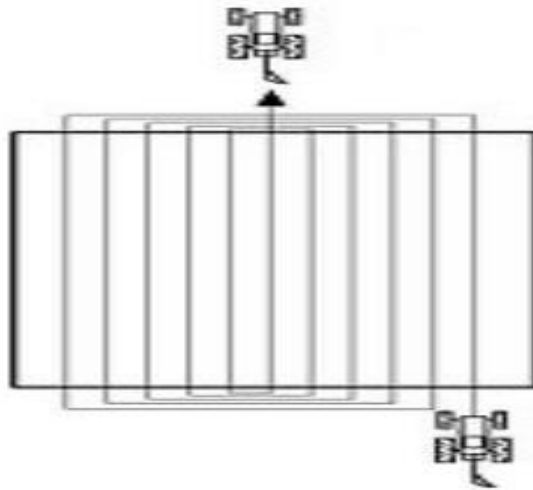


**Fig. 2. Trajectory for flat plowing (LP)**

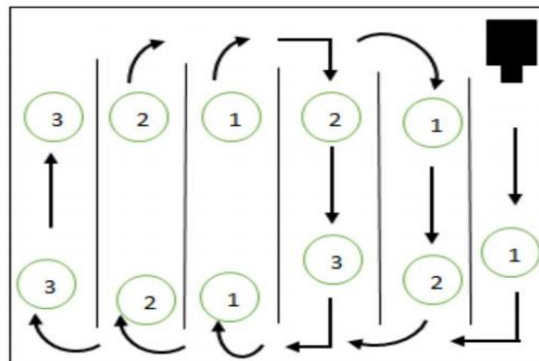
Legend : LP – Flat Plowing



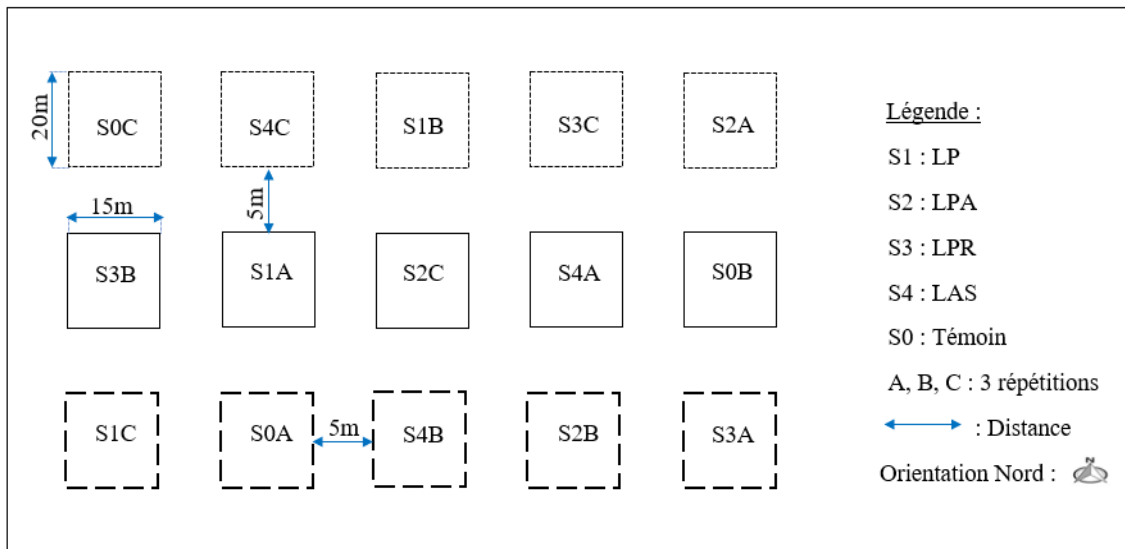
**Fig. 3. Trajectory for back-to-back plowing (LPA)**  
Legend : LPA - Backing Board Plowing



**Fig. 1. Trajectory for splitting board plowing (LPR)**  
Legend : LPR - For Splitting Board Plowing



**Fig. 5. Trajectory for superimposed alternating plowing (LAS)**  
Legend : LAS - Alternating Superimposed Plowing



**Fig. 2. Randomized complete block experimental design**

Legend : LP – Flat Plowing, LPA - Backing Board Plowing, LPR - For Splitting Board Plowing, LAS - Alternating Superimposed Plowing, A, B, C - Repetition of Treatments

## 2.4 Sample Collection Methods

A soil profile was carried out on the experimental site. This cultural profile of 1m width, 1m length and 1m depth was installed in order to measure the depth of the Arab layer which is 20 cm; this allowed us to maintain a plowing depth of 15 cm. For the particle size analysis which allowed us to determine the texture and structure of the soil, disturbed soil samples were taken using a manual auger from the control plots (S0) following the diagonal of the plots in three points, starting from both ends of the diagonal to end in the right middle. These samples taken from the control plots were mixed to have a representative sample.

## 2.5 Particle Size Analysis

The particle size analysis of a sediment consists of determining the proportion of the various particle size classes : sand, silt, clay, etc [9]. This analysis was carried out according to standard [10].

## 2.6 Methods for Determining Tractor Slip on the Ground

The slip rate is determined based on the distance traveled by the tractor while plowing and that traveled with the implement raised. For this we marked a reference point where one of the rear wheels was in contact with the ground. We made

5 turns of the wheel while plowing, then we marked the finishing point on the ground. This distance was measured and denoted by A. Then we repeated the previous steps with the tool raised. The new distance traveled with the tool raised was also measured and designated by B. The slip rate is calculated using the equation from Leghari et al [11] :

$$\% \text{ de glissement} = \frac{B-A}{B} \times 100 \quad (1)$$

## 2.7 Fuel Measurement Methods

Fuel consumption is measured in liters but was evaluated in g in the remainder of the study. For this fact, we considered the density of diesel p diesel = 0.840 Kg/l [12]. The measurement procedure involves completely filling the fuel tank at the start of each plowing operation. At the end of the plowing operation of a plot, the quantity of fuel required for the supplement is measured and this allowed us to know the fuel consumption during the plowing of said plot.

## 2.8 Methods for Measuring Time Parameters

The different times, namely : the actual plowing time, the time lost during plowing and the total plowing time were recorded with a stopwatch. Four people were used to record the different times. Two people recorded the actual plowing

time and the other two recorded the time lost during plowing. The recording of actual plowing time and time lost during plowing was carried out by two people in order to minimize measurement errors. The accumulation of these two recorded times gives us the total plowing time.

### 2.9 Determination of Time Efficiency in the Field

According to E-Agri. [13], time efficiency is a percentage of the ratio between the actual operating time of a machine and the total time the machine is spent in operation. Anytime the machine doesn't actually process the field, it counts as wasted time.

The time efficiency in the field (Ef) of each trajectory for motorized plowing was calculated using the 1st formula of Zenebe and Chernet [2] :

$$(Ef)\% = \frac{\text{Temps effectif de labour (s)}}{\text{Temps total de labour (s)}} \times 100 \tag{2}$$

### 2.10 Effective Field Capacity

This is the actual area covered by the tool based on its total time consumed and its width [14]. It is defined by the second formula of Zenebe and Chernet [2].

$$C = \frac{vW}{10} Ef \tag{3}$$

With :

**VS** : the effective field capacity (ha/h) ; **V** : plowing speed (Km/h) ; **W** : the working width of

the tool (m) and **Ef** : the time efficiency in the field of the tractor in decimal.

### 2.11 Data Analysis and Processing

Excel software was used to create the databases. The R 4.2.2 softwares (2022-10-31) was used for the statistical analysis of the data of the different parameters recorded and the statistical significance was set at 10%. We first checked the normality of the data for the different parameters using the Shapiro-Wilk test. The statistical analysis was based on the ANOVA 1 method followed by the Tukey test for pairwise comparison in order to structure the means in the case where the data follow a normal distribution. If applicable, the Kruskal-Wallis test followed by the Mann-Whitney test was done. After the analyses, interpretations are made and these allowed us to designate the best trajectory for motorized plowing. Boxplots and histograms were also produced with this software.

## 3. RESULTS AND DISCUSSIONS

### 3.1 Particle Size Analysis

Table 1 presents the results from the particle size analysis of the representative sample taken from the plots.

Table 2. Gives us indications of the texture of the soil on which we carried out our experiment

According to the results in Tables 1 and 2, we will say that coarse sands are predominant than coarse silts ; which gives it the type of sandy loamy soil. Thus, the soil of Awai has a lumpy

**Table 1. Result of the particle size analysis**

Samples	LG	LF	A	SF	SG
	%				
Awai 0-20cm	8.5	10.4	8.6	24.93	47.06

Legend : LG = Coarse silts, LF = Fine silts, A = Clays, SF = Fine sands, SG = Coarse sands

**Table 2. Summary of the result**

Sample	Texture	Interpretation
Awai 0-20cm	SL to LA	Sandy Silty on the surface (0-15 cm) ranging from Silty-Clays at depth (15 – 20 cm)

Legend : SL = Sandy silty, LA = Silty Clays

structure. This will allow soil organisms to have a primary action in the soil, such as earthworms, by digging galleries, creating a real aeration network thus promoting the deep circulation of air and water.

### 3.2 Determination of Slip on Each Plot

The slip values on the plots are around 7%. According to Firestone [15], the slip values must be below 15%. In our case, the slip values calculated on the different plots of the experiment are less than 15%, so they are acceptable. Consequently, the physical state of the soil and the state of the tractor tires did not then influence the plowing of the plots following the different trajectories. The data collected during the experiment for the evaluation of agro-economic parameters are recorded in Table 3 and their statistical analysis is summarized in Tables 4 and 5.

Table 4 presents the statistical results from the statistical analyzes of the different parameters.

### 3.3 Fuel Consumption (g) of Trajectories for Motorized Plowing

The boxplot (**Error! Reference source not found.**) shows the variation in fuel consumption for each type of trajectory for motorized plowing.

The analysis of these boxplots initially indicates that there is a large variation in the volume of fuel used for each type of trajectory for motorized plowing, particularly for LP compared to the other three trajectories for motorized plowing. With an extremum of 189 g and 294 g, the fuel consumption required for LP is greater than that of the others, especially compared to LAS which presented an extremum ranging from 147 g to 168 g.

Indeed, as shown in the bar histogram produced, on average 245 g of fuel were consumed for the establishment of the plots on which LP was carried out compared to respectively 158 g, 161 g and 182 g for the plots having sheltered LPA, LAS and LPR. Kruskal-Wallis chi-squared = 6.0527; Pr = 0.109\*

**Table 3. Data recorded on experimental plots for motorized plowing trajectory**

Agronomic and Economic Parameters								
PLOTS	Fuel Consumption (g)	Effective Plowing Time (s)	Time Lost During Plowing (s)	Total Plowing Time (s)	Time Efficiency in the Field (%)	Effective Field Capacity (ha/h)	Theoretical Field Capacity (ha/h)	Fuel Consumption Per Hectare (g/ha)
S1A	189	104	226	330	31.52	0.19	0.6	10903.85
S1B	252	151	276	427	35.36	0.21	0.6	10013.25
S1C	294	192	319	511	37.57	0.23	0.6	9187.5
S2A	180.6	177	131	308	57.47	0.34	0.6	6122.03
S2B	147	145	102	247	58.70	0.35	0.6	6082.76
S2C	147	135	121	256	52.73	0.32	0.6	6533.33
S3A	168	165	123	288	57.29	0.34	0.6	6109.09
S3B	147	140	113	253	55.34	0.33	0.6	6300
S3C	231	188	189	377	49.87	0.30	0.6	7372.34
S4A	168	156	130	286	54.55	0.33	0.6	6461.54
S4B	147	163	108	271	60.15	0.36	0.6	5411.04
S4C	168	178	117	295	60.34	0.36	0.6	5662.92

Legend : S : Plots, A, B, C – Repetition of treatments



**Table 4. One-way ANOVA results**

Parcels_Trajectories for motorized plowing	Settings	Mean ± Standard Deviation	Mann-Whitney	Kruskal-Wallis chi-squared F	Prob
S1_LP	Fuel consumption	245 ± 52.84	b	6.0527	0.109
S2_LPA		158 ± 19.39	a		
S3_LPR		182 ± 43.71	b		
S4_LAS		161 ± 12.12	a		
S1_LP	Fuel consumption per hectare	10034.86± 858.37	b	7,307	0.06271*
S2_LPA		6246.04± 249.57	a		
S3_LPR		6593.81± 680.95	a		
S4_LAS		5845.16 ± 548.44	a		
S1_LP	Time lost during plowing	273.66 ± 46.54	vs	6,589	0.086*
S2_LPA		118 ± 14.73	a		
S3_LPR		141.66 ± 41.29	ab		
S4_LAS		118.33 ± 11.06	a		
S1_LP	Time efficiency in the field	34.82 ± 3.06	a	7,513	0.057*
S2_LPA		56.3±3.15	b		
S3_LPR		54.16 ± 3.84	b		
S4_LAS		58.34 ± 3.29	b		
S1_LP	Field capacity	0.21± 0.018	a	7.5128	0.05723*
S2_LPA		0.33 ± 0.018	b		
S3_LPR		0.325 ± 0.023	b		
S4_LAS		0.35 ± 0.019	b		

*SD – Standard Deviation, Mann Whitney, Kruskal Wallis test results, Prob- Probability*  
*S : plots, LP – Flat Plowing, LPA - Backing Board Plowing, LPR - for splitting Board plowing, LAS - Alternating Superimposed Plowing*

**Table 5. Results of the Kruskal-Wallis test**

Types of plowing	Settings	Mean ± Standard deviation	Tukey	F	Prob
S1_LP	Effective plowing time	149 ± 24	a	0.27	0.844
S2_LPA		152.33 ± 21.94	a		
S3_LPR		164.33 ± 44.03	a		
S4_LAS		165.66 ± 11.23	a		
S1_LP	Total plowing time	422.66 ± 90.57	a	4.28	0.044*
S2_LPA		270.33± 32.92	b		
S3_LPR		306 ± 63.92	ab		
S4_LAS		284 ± 12.12	b		

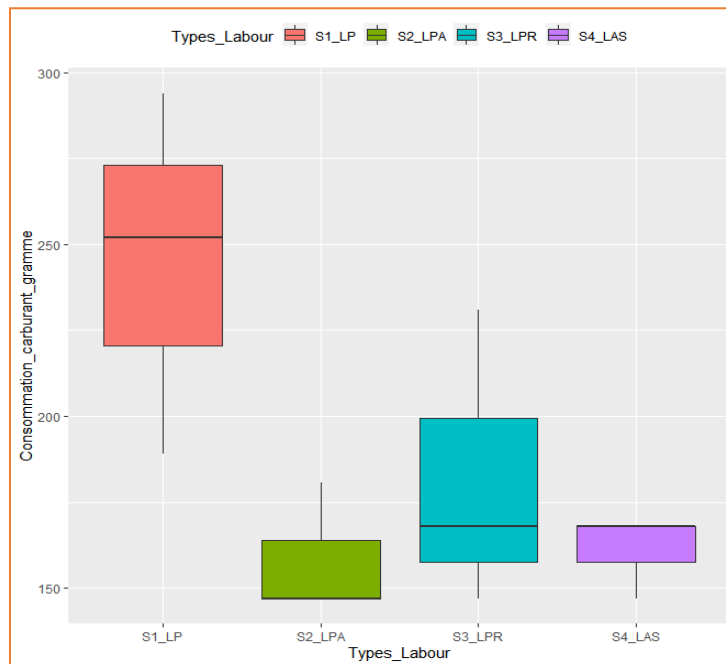
*SD – Standard Deviation, Tukey, F Frequence, Prob- Probability*  
*S : Plots, LP – Flat Plowing, LPA - Backing Board Plowing, LPR - for Splitting Board Plowing, LAS - Alternating Superimposed Plowing*

Furthermore, the assessment of normality through the Shapiro-Wilk test showed that fuel consumption does not follow a normal distribution. The use of non-parametric tests (Kruskal-Wallis) to compare these average consumptions showed, however, that there is no significant difference at the 10% threshold. Which means that regardless of the trajectory for motorized plowing, the fuel consumption is not statistically different although LP consumed more fuel than the others.

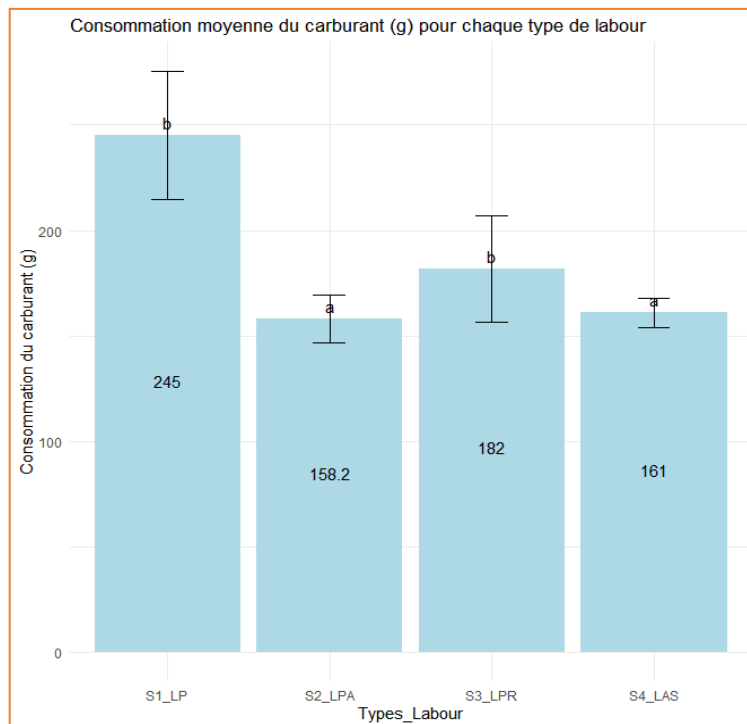
However, the pairwise comparison resulting from the Mann-Whitney analysis shows a structuring of two groups with similar consumption of LP and LPR (group b) while the two other trajectories for motorized plowing present fuel consumption which is equivalent (group a).

### 3.4 Effective Time (s) for Each Trajectory for Motorized Plowing

In order to appreciate the level of complexity of each trajectory for motorized plowing, other



**Fig. 7. Boxplot of fuel consumption (g) of trajectories for motorized plowing**  
*S : Plots, LP – Flat Plowing, LPA - Backing Board Plowing, LPR - For Splitting Board Plowing, LAS - Alternating Superimposed Plowing*



**Fig. 3. Comparison of fuel consumption (g) of trajectories for motorized plowing**  
*S : Plots, LP – Flat Plowing, LPA - Backing Board Plowing, LPR - for Splitting Board Plowing, LAS - Alternating Superimposed Plowing*

parameters such as "the time" taken to execute each trajectory for motorized plowing were explored. Indeed, in terms of effective time, that

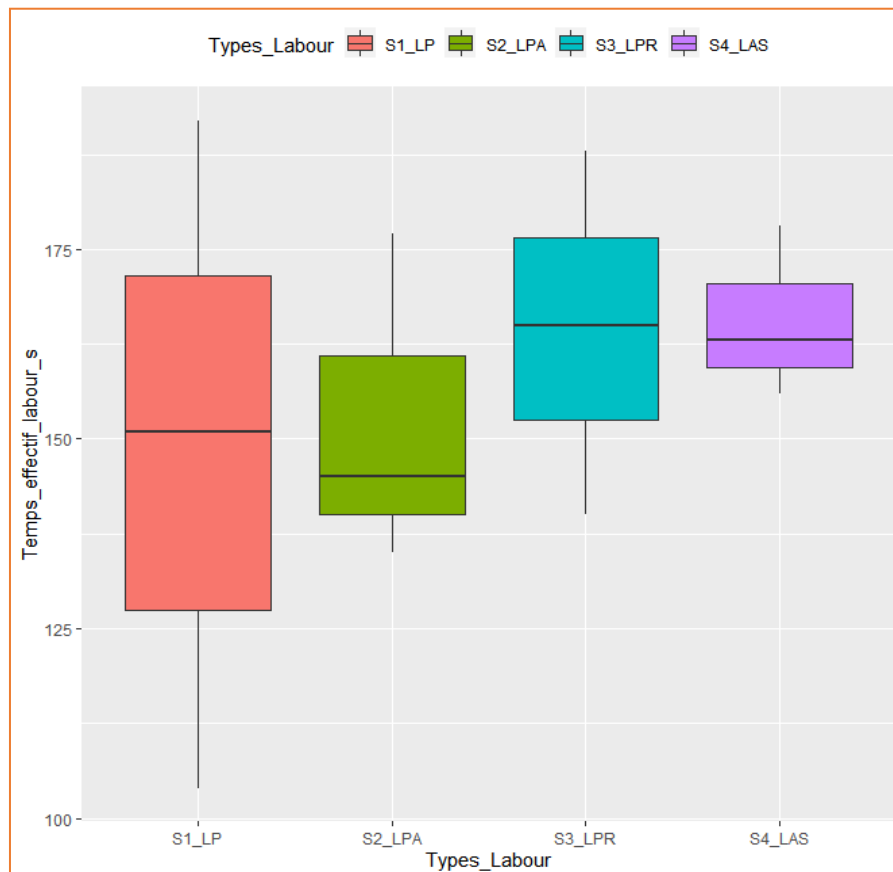
is to say the time during which the plowing operator was actively engaged in the execution of each plowing trajectory, without taking into

account interruptions, pauses or non-working times. Productive ; this is the time actually used to execute each type of trajectory.

The analysis of the boxplots linked to this parameter also indicates a variation in the extreme duration taken for each type of plowing operation, in particular for LP compared to the three other types of trajectory. As with the volume of fuel consumption, the trajectory for flat plowing (LP) has a wider interval, i.e. an effective time ranging from approximately 104 seconds to more than 192 s. Then comes the trajectory for splitting board plowing (LPR) with extremums ranging from at least 140 s to 188 s at most.

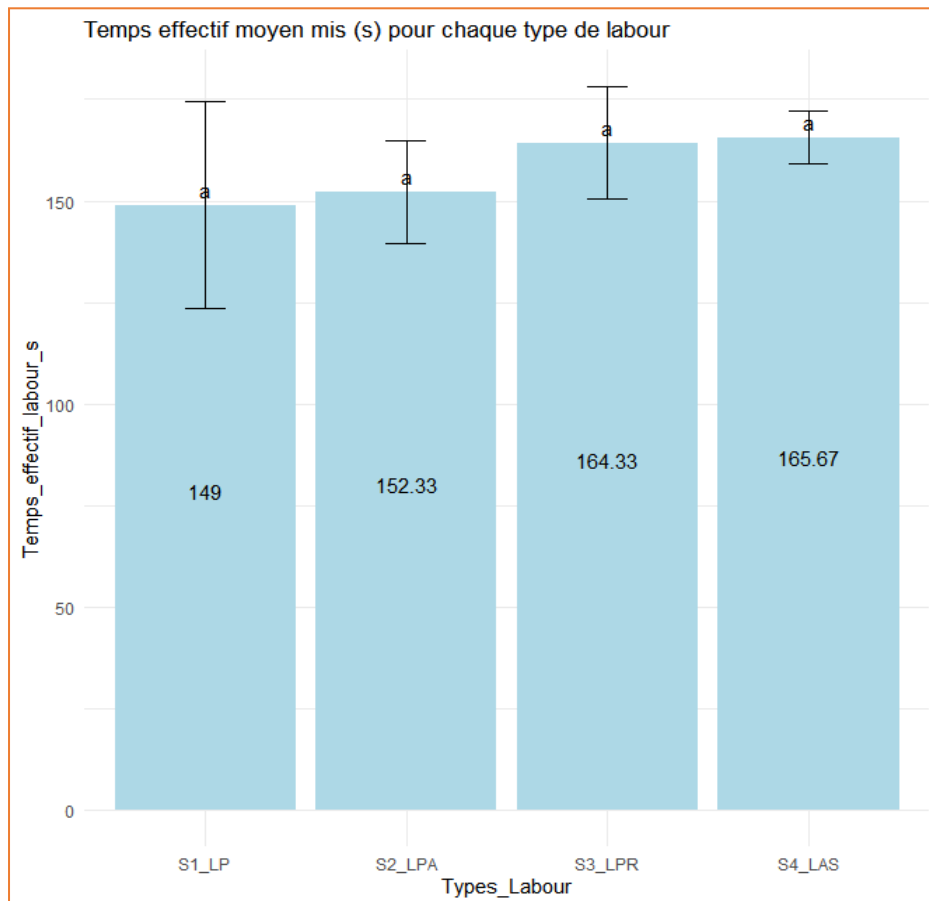
Indeed, as shown in the histogram, on average the effective times range from 149 s (LP) to approximately 165 s (LAS) or between 2 min 29 s (LP) and 2 min 45 s (LAS). Anova:  $F = 0.27$ ;  $Pr = 0.844$

The assessment of normality through Shapiro showed that this parameter follows a normal distribution in general. This made it possible to carry out a one-way analysis of variance (ANOVA 1) thus showing a non-significant difference at the 10% threshold in terms of effective time taken for each type of trajectory for motorized plowing. Which means that whatever the trajectory, the time actually spent carrying out these operations per plot does not vary statistically. This is also what is reflected in the pairwise comparison resulting from Tukey's analysis which shows an identical structure (same group: a) for all the trajectories for motorized plowing; nevertheless LPR and LAS took longer than the others. Furthermore, the results of the study of Zenebe and Chernet [2]. show that back-to-back plank plowing (LPA) has an effective time of 5257 s compared to a time of 5558.3 s for splitting plank plowing (LPR) but these results are not based on any statistical analysis as this was done in our case.



**Fig. 4. Boxplots of the effective time (s) according to the different trajectories for motorized plowing**

S : Plots, LP – Flat Plowing, LPA - Backing Board Plowing, LPR - For Splitting Board Plowing, LAS - Alternating Superimposed Plowing



**Fig. 10. Comparison of the average effective time (s) spent on plowing with the different trajectories**

*S : plots, LP – Flat Plowing, LPA - Backing Board Plowing, LPR - For Splitting Board Plowing, LAS - Alternating Superimposed Plowing*

### 3.5 Time Lost during Motorized Plowing Operations

The assessment of time also takes into consideration the “lost time” aspect, referring mainly to the seconds or minutes necessary for the operator before repositioning for a new start for plowing.

The analysis of the boxplots linked to this parameter clearly indicates two different groups in terms of evaluation of time lost for the realization of the different trajectories for motorized plowing. Indeed, this is mainly the group of plots on which LP was carried out with a greater extremum ranging from 226 s or 3 min 46 s to 319 s or 5 min 19 s. On the other hand, the interval of time lost is less important for the other three, especially for LAS where the time lost is between 108 s, or less than 2 min, and 130 s, or exactly 2 min 10 s.

This difference is even more observed through the histogram of the averages with an average time lost of around 273 s for LP while the three other plowing trajectories indicate an average time lost ranging from 118 s (LPA) to 141 s (LPR). Kruskal-Wallis chi-squared = 6.589; Pr = 0.086\*

However, not following a normal distribution, the Kruskal-Wallis test shows a significant difference in terms of time lost for each trajectory for motorized plowing. Thus, the operator takes more time to reposition himself when he executes the trajectory for flat plowing (LP) than when he executes one of the three other trajectories for motorized plowing, especially that for plowing on a plank by leaning against it. (LPA).

This is also what is reflected in the pairwise comparison resulting from the Mann-Whitney analysis which shows that the time lost during

the execution of LPs is significantly different from the others while LPAs and LASs are statistically similar. in terms of wasted time. The results of Zenebe and Chernet [2] confirm our results in the case where they lost for the plowing of one hectare, 1954 s using the circular (square) plowing model from ridges (LPA) versus 2580 s using the circular (square) plowing model from boundaries (LPR).

### 3.6 Total Plowing Time(s)

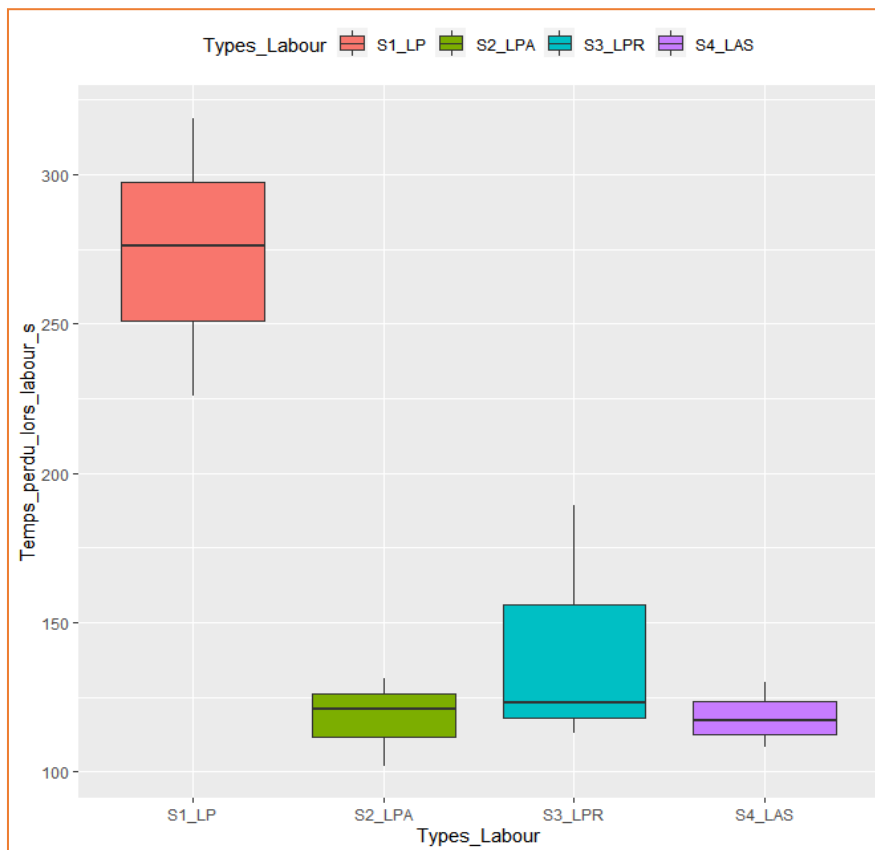
Overall, an assessment of the total time (workforce plus wasted) makes it possible to identify the trajectory that allows time to be saved.

The analysis of the boxplots linked to this parameter also clearly indicates two different groups in terms of evaluation of total time for the realization of the different trajectories for motorized plowing. Indeed, initially we find the plots on which the trajectories for flat plowing (LP) were carried out with a greater extremum ranging from 330 s or approximately 5 min 30 s

to 511 s or approximately 8 min 30 s. On the other hand, the interval of time lost is less important for the other three, especially for the trajectories for superimposed alternating plowing (LAS) where the total time seems to be less varied, i.e. between 271 s and 295 s at most.

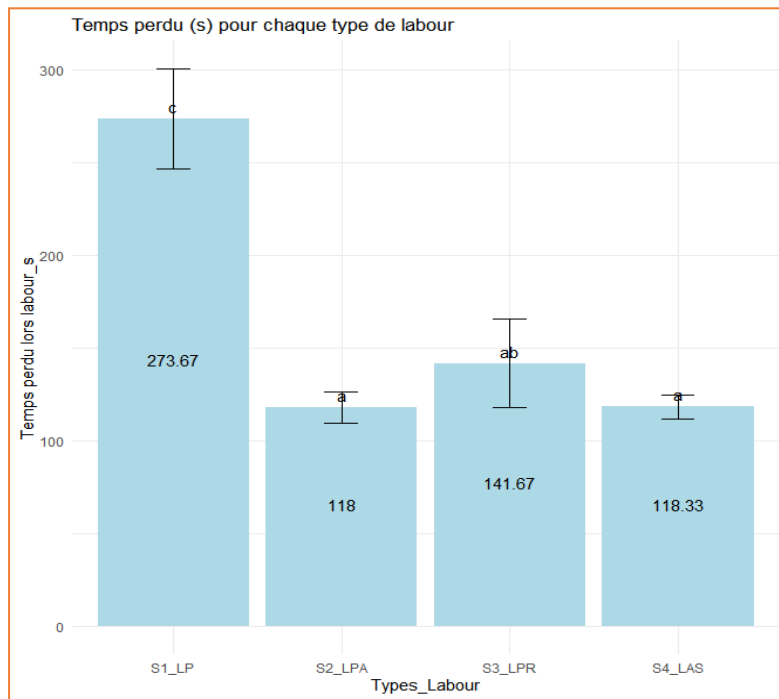
The histogram makes it possible to better perceive this difference with an average total time of approximately 422 s for LP, or approximately 7 min, while the three other trajectories for motorized plowing indicate an average total time ranging from 270 s (LPA) to 306 s (LPR). Anova:  $F = 4.28$ ;  $Pr = 0.044^*$

The assessment of normality through Shapiro showed that this parameter follows a normal distribution in general. As a result, the one-way analysis of variance (ANOVA 1) shows a significant difference at the 10% threshold in terms of total time carried out for each plowing trajectory. Thus, the operator takes more time not only for the actual LP operations but also loses a lot of time before its repositioning.



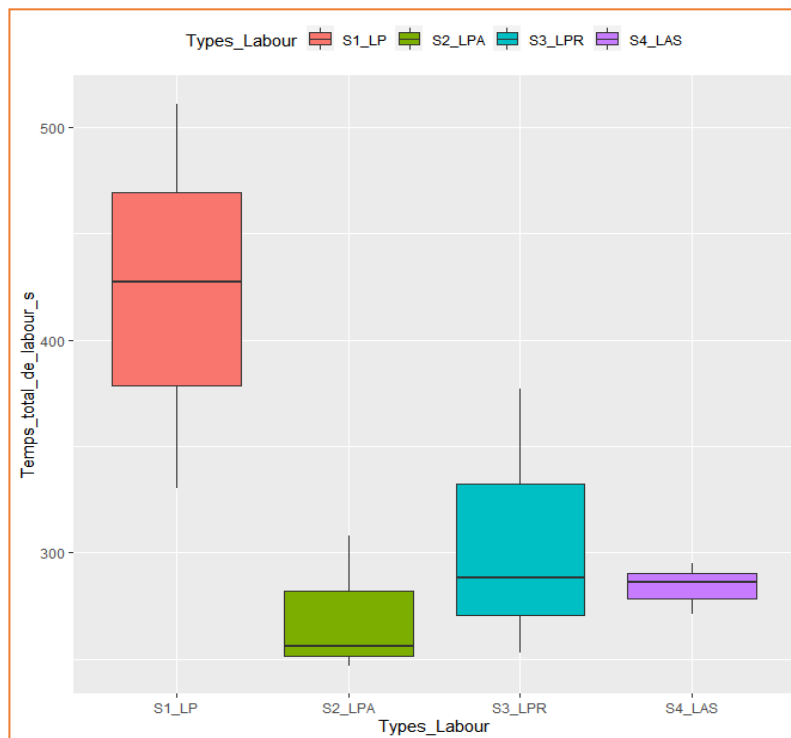
**Fig. 11. Boxplot of time lost (s) during plowing**

S : plots, LP – Flat Plowing, LPA - Backing Board Plowing, LPR - for Splitting Board Plowing, LAS - Alternating Superimposed Plowing



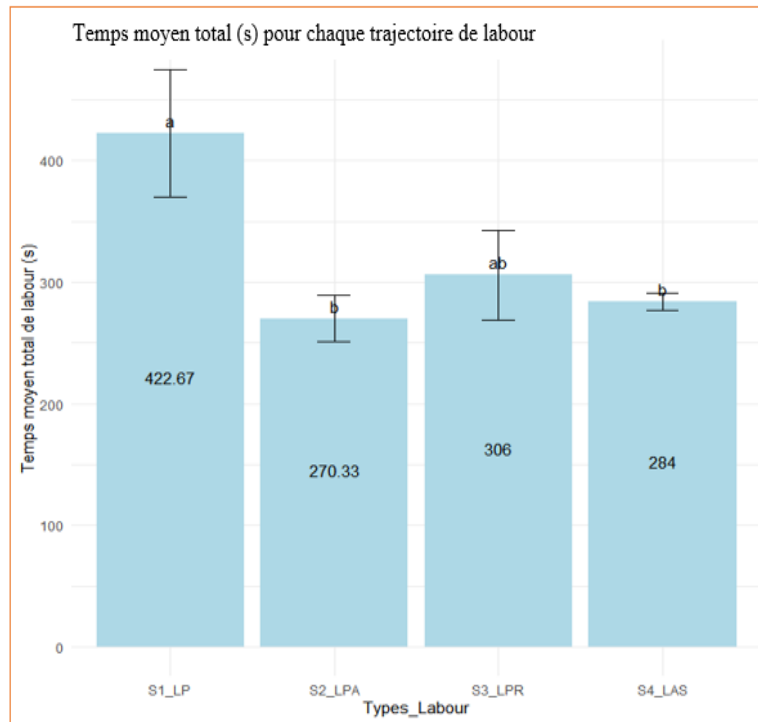
**Fig. 5. Comparison of the average time lost (s) when executing trajectories for motorized plowing**

S : plots, LP – Flat Plowing, LPA - Backing board plowing, LPR - for splitting board plowing, LAS - Alternating superimposed plowing



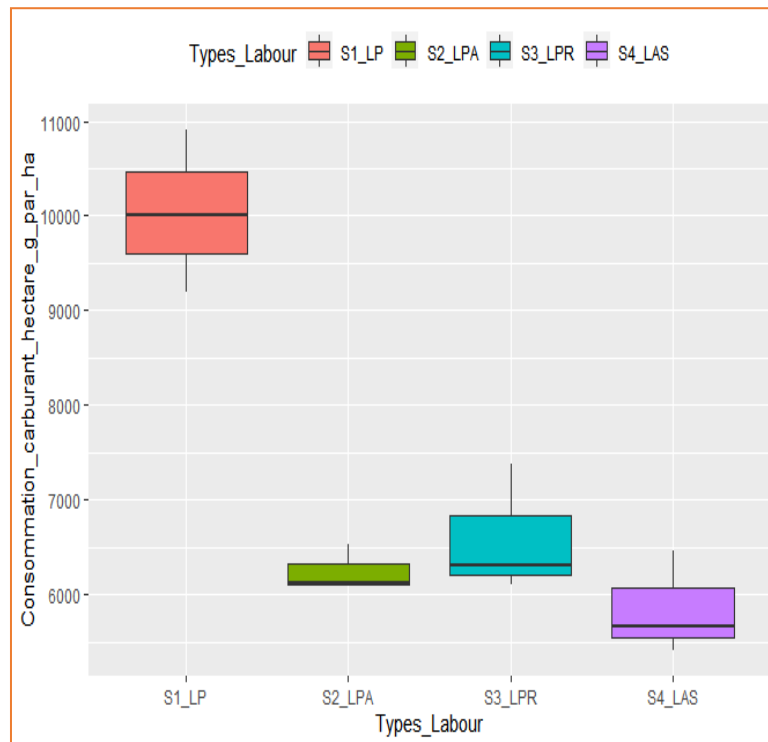
**Fig. 6. Boxplot of the total plowing time (s) according to the different trajectories for motorized plowing**

S : plots, LP – Flat Plowing, LPA - Backing Board Plowing, LPR - for Splitting Board Plowing, LAS - Alternating Superimposed Plowing



**Fig. 7. Comparison of the total average plowing time (s) according to the different trajectories for motorized plowing**

S : plots, LP – Flat Plowing, LPA - Backing board plowing, LPR - for splitting board plowing, LAS - Alternating superimposed plowing



**Fig. 8. Boxplots of fuel consumption per hectare (g/ha)**

S : plots, LP – Flat Plowing, LPA - Backing Board Plowing, LPR - for Splitting Board Plowing, LAS - Alternating Superimposed Plowing

Furthermore, the pairwise comparison from Tukey's analysis indicates that LAS and LPA belong to the same group in terms of total time spent for plowing operations while LPRs are statistically closer to LPs. This analysis is confirmed by the work of Sarkar et al [3] which showed that the overlapping alternation (LAS) model required 18 min of total plowing time compared to 25 min for the circuit alternation (LPR) model. The work of Zenebe and Chernet [2] Comparative Evaluation of Alternate Plowing Pattern Designs at Metahara Sugar Estate of Ethiopia” also shows that the trajectory for back-to-back plowing (LPA) takes less time than the path for splitting-plank plowing (LPR).

### 3.7 Designation of the Best Trajectory for Motorized Plowing

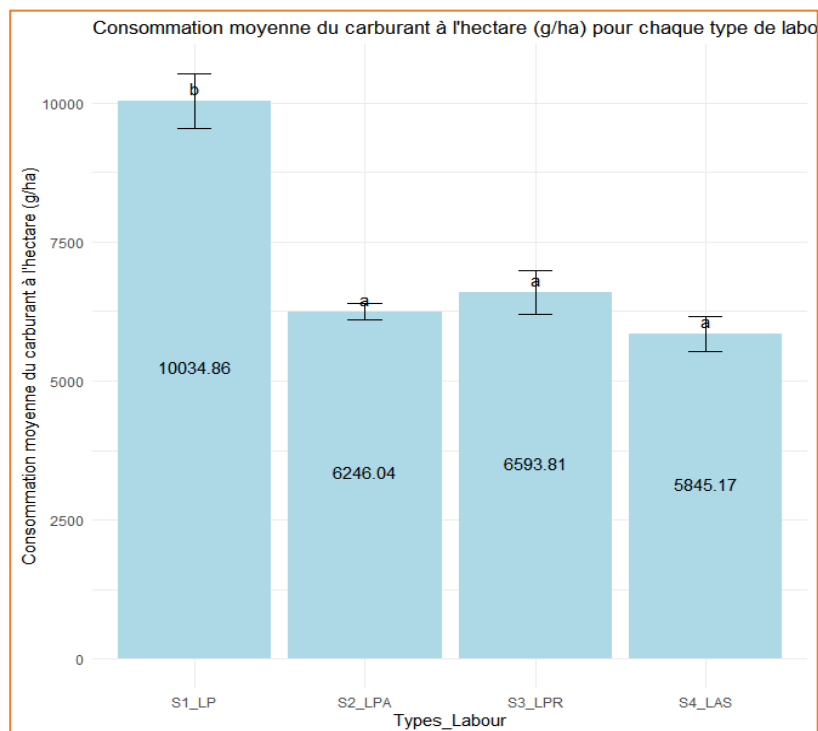
#### 3.7.1 Fuel consumption per hectare (g/ha)

The evaluation of fuel consumption per hectare initially shows, from the boxplots, two groups of methods having a very different level of consumption per hectare. Indeed, the trajectory for flat plowing (LP) stands out considerably with extremes between approximately 9000 g/ha and more than 10,000 g/ha, while the other three

trajectories present a consumption range ranging from 5000 g/ha at approximately 7000 g/ha.

On average, as shown in the histogram (fig 15), 10034 g/ha of fuel were consumed for the establishment of the plots on which LP was carried out compared to respectively 5845.16 g/ha, 6246 g/ha and 6593.8 g/ha for the plots having hosted the LAS, LPA and LPR trajectories. Kruskal-Wallis chi-squared = 7.307; Pr = 0.06271\*

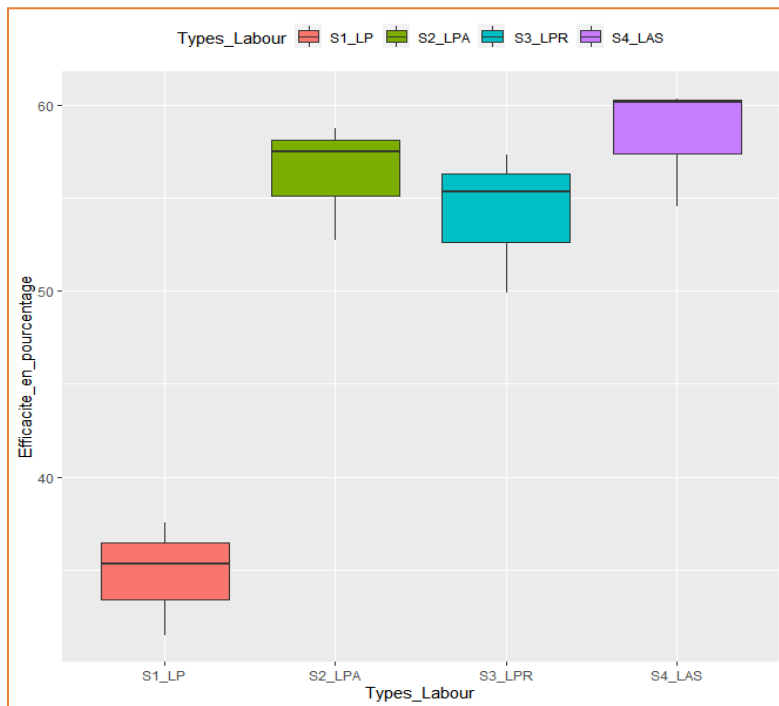
The assessment of normality through Shapiro showed that this fuel consumption does not also follow a normal distribution. However, the Kruskal-Wallis test carried out to compare these average consumptions showed a significant difference at the 10% threshold; which in fact means that fuel consumption varies statistically depending on the trajectory for motorized plowing adopted with greater consumption per hectare for LP. However, the study of Sarkar et al [3] on the selection of a suitable tillage model for fuel economy revealed that the amount of fuel consumed by the tractor for plowing one hectare using the tillage model overlap alternation (LAS) is the same as that consumed by the tractor when using the rectilinear alternation model (LP with reversible plow) which was not studied in our work.



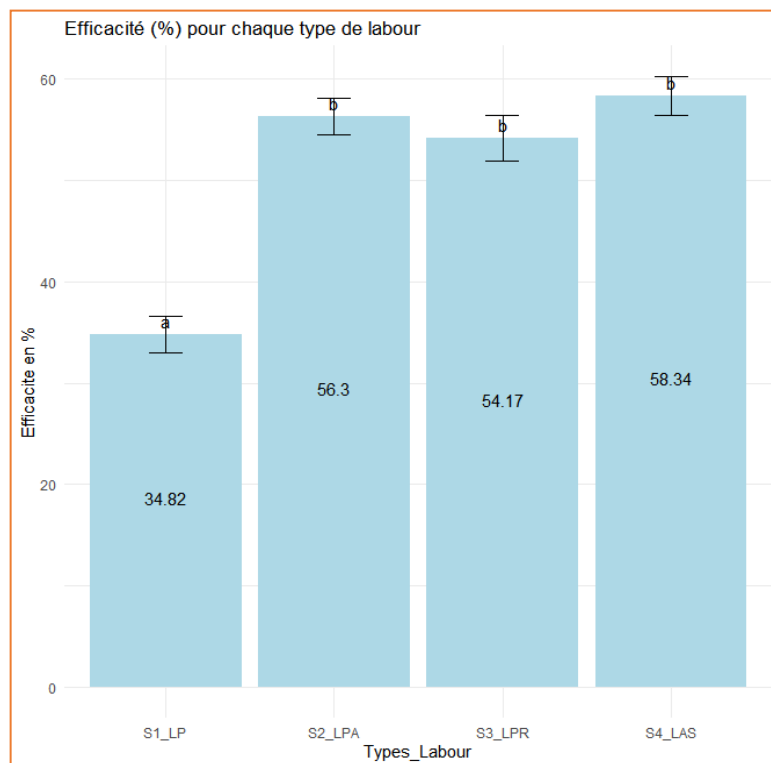
**Fig. 9. Average fuel consumption per hectare (g/ha)**

S : plots, LP – Flat Plowing, LPA - Backing Board Plowing, LPR - For Splitting Board Plowing, LAS - Alternating Superimposed Plowing





**Fig. 10. Boxplot of field temporal efficiency (%) by trajectory for motorized plowing**  
*S : plots, LP – Flat Plowing, LPA - Backing Board Plowing, LPR - For Splitting Board Plowing, LAS - Alternating superimposed Plowing*



**Fig. 11. Comparison of average time efficiency (%)**  
*S : plots, LP – Flat Plowing, LPA - Backing Board Plowing, LPR - For Splitting Board Plowing, LAS - Alternating Superimposed Plowing*

Furthermore, we cannot confirm its results which indicate that the overlap alternation model (LAS) consumes 17.78 l of fuel per hectare compared to 21.11 l per hectare for the circuit alternation model. (LPR) because the author has not done any statistical study that proves his assertion. This is reflected in our study by the pairwise comparison resulting from the Mann-Whitney analysis which shows that the trajectories for motorized plowing LAS, LPA, then LPR present significantly similar fuel consumption per hectare. And lower than that of the LPs studied.

### 3.7.2 Time efficiency in the field (%) for each type of plowing

To designate the best trajectory for motorized plowing, other parameters, in particular that of time efficiency (%) and field capacity (ha/h), were evaluated and compared.

Field time efficiency is calculated by comparing effective plowing time (time during which work is actually done) to total plowing time (total time spent on the field). The higher the time efficiency in the field, the more efficiently time is used to accomplish work, indicating better productivity.

The boxplot (Fig 17) shows the variation in the efficiency level for each path for motorized plowing. The analysis of these boxplots initially indicates that there is a variation in the level of efficiency from one plowing trajectory to another. With an extremum of 31.52% and 37.57%, the trajectory for flat plowing (LP) is the least efficient with an average efficiency of 34.82%. This relatively low efficiency compared to the efficiencies of the other trajectories suggests that only 34.82% of the total plowing time is used effectively to accomplish the work.

On the other hand, the three other trajectories for motorized plowing show extrema which are equivalent and well above the first type of trajectory for motorized plowing. Indeed, LAS are the most efficient with an extreme ranging from 54.55% to 60.34% for an average efficiency of 58.34%, thus reflecting that 58.34% of the total time spent on the plot is used in an efficient manner. Efficient to actually do the work with these LAS trajectories. Notwithstanding this, LAS do not offer good plowing quality with the simple plows used in our study. They are suitable for plowing carried out with reversible plows or hillers. Kruskal-Wallis chi-squared = 7.513; Pr = 0.057\*

Furthermore, the comparison of these average efficiencies showed, however, that there is a

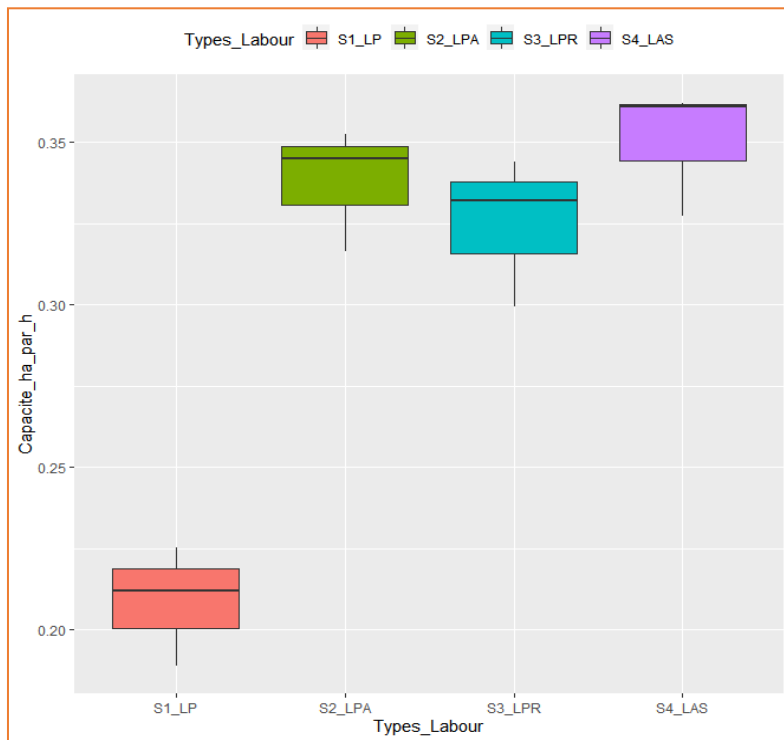
significant difference at the 10% threshold ; which means that the efficiency is determined by the plowing path carried out. However, the pairwise comparison resulting from the Mann-Whitney analysis shows that LAS, LPA and LPR have a similar level of efficiency while LPs have an average efficiency significantly different from the others. We cannot therefore confirm the results of Zenebe and Chernet [2] which present a difference between the temporal efficiency in the field which is 72.9% for the circular (square) plowing model from the ridges (LPA) and the time efficiency in the field which is 68.3% for the circular (square) plowing model from the limits (LPR) especially since its These statements are not based on any statistical study.

### 3.7.3 Field capacity (ha/h) from each trajectory for motorized plowing

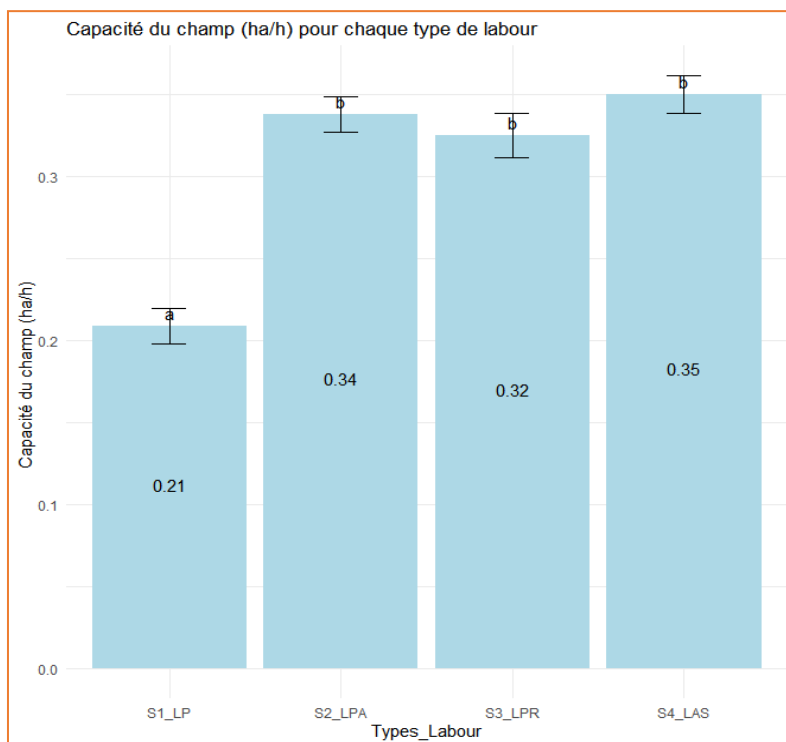
The evaluation of the field capacity of the trajectories for motorized plowing also confirms the results of the temporal efficiency in the field previously obtained. This parameter measures the area of land (in hectares) that the tractor can plow in one hour (ha/h) according to each path. In the context of the present study based on motorized plowing trajectories, a high capacity for a precise plowing trajectory indicates greater efficiency of the machine tool or a good adaptation of the tractor-plow assembly used for this trajectory for precise plowing, because it assumes that it can plow a larger area of field in less time.

Indeed, the boxplots (Fig 18) indicate a variation in the field capacity for each trajectory. The analysis of these boxplots also shows that LP has the lowest capacities with an extremum of 0.19 ha/h and 0.23 ha/h. This capacity is significantly lower with an average of 0.21 ha/h compared to that of other trajectories, notably that of LAS where the average capacity is 0.35 ha/h.

Just as for efficiency, the comparison of average capacities showed that there is a significant difference at the 10% threshold, thus reflecting that each trajectory for motorized plowing has a given capacity statistically different from that of a other. However, the pairwise comparison resulting from the Mann-Whitney analysis also shows that the LAS, LPA and LPR have significantly similar capacities at the 10% threshold but different from that of the LPs. Kruskal-Wallis chi-squared = 7.5128, Pr = 0.05723\*



**Fig. 19. Boxplot of field capacity (ha/h) per trajectory for motorized plowing**  
*S : plots, LP – Flat Plowing, LPA - Backing board plowing, LPR - for splitting board plowing, LAS - Alternating superimposed plowing*



**Fig. 12. Comparison of average capacity (ha/h) per trajectory for motorized plowings**  
*S : plots, LP – Flat Plowing, LPA - Backing board plowing, LPR - for splitting board plowing, LAS - Alternating superimposed plowing*

Thus, the results from these analyzes made it possible to evaluate the performance of the tractors with each type of trajectory for motorized plowing, to identify the trajectories which are the most productive (LAS, LPA and LPR) and those which possibly require improvements. To increase their efficiency like the trajectory for flat plowing (LP) studied. As in terms of efficiencies, the results of Zenebe and Chernet [2] which show a difference between the field capacities obtained with the circular (square) plowing model from boundaries (LPR) and the circular (square) plowing model from ridges (LPA) cannot be confirmed either because they are not subject to any statistical analysis.

#### 4. CONCLUSION

This research consisted of the study of trajectories for motorized plowing to draw out their advantages and disadvantages. It was based on the specification of trajectories for motorized plowing in order to determine the difference between their economic and agronomic parameters with the aim of designating the best trajectory. Although there is not a statistically significant difference at the 10% threshold between the economic parameters of the LPA, LPR and LAS trajectories, except the parameter of the maximum headland width measured and taking into account the results obtained, we recommend the LAS trajectory in the case where plowing is carried out with a reversible plow or with a ridger. If plowing is carried out with a simple plow, we first recommend the path for plowing in planks by backing LPA and then that for plowing in planks by splitting LPR because the path LPA offers better economic parameters than the path LPR.

#### DISCLAIMER (ARTIFICIAL INTELLIGENCE)

Author(s) hereby declare that generative AI technologies such as Large Language Models, etc have been used during writing or editing of manuscripts. This explanation will include the name, version, model, and source of the generative AI technology and as well as all input prompts provided to the generative AI technology.

#### Details of the AI usage are given below:

1. Bibliographic review on the subject
2. Summarize the trajectory techniques and methods used in plowing and compare to that of benin.

3. formulas and statistical analyzes to process my results.

#### COMPETING INTERESTS

Authors have declared that no competing interests exist.

#### REFERENCES

1. Wikipedia. Wikipedia; 2023. Available:<https://fr.wikipedia.org/wiki/Labour>
2. Zenebe MB, Chernet GA. Comparative evaluation of alternate plowing pattern designs at metahara sugar Estate of Ethiopia. *African Journal of Agricultural Science and Technology*. 2016;4(7)(ISSN 2311-5882):1024-831. DOI: 10.13140/RG.2.2.13710.51521
3. Sarkar S, Mahmud MS, Kabir AB, Sarker MK, Munnaf MA. Selection of Suitable Tillage Pattern for Fuel Economy. *Research Journal of Agriculture and Forestry Sciences*. 2016;4(4);1-4. DOI: 10.13140/RG.2.1.1116.2484
4. Ansoorge D, Godwin RJ. The effect of tires and a rubber track at high axle loads on soil compaction, Part 1: Single axle-studies. *Biosystems Engineering*. 2007;98(1):115-126. Available:<https://doi.org/10.1016/j.biosystemseng.2007.06.005>
5. Zhou K, Allan LJ, Dionysis B, Claus GS. Quantifying the benefits of alternative fieldworks patterned in a potato cultivation system. *Computers and Electronics in Agriculture*. 2015 ;119:228-240. DOI:10.1016/j.compag.2015.10.012
6. RGPH; 2002.
7. Department of Demographic Studies. Monograph of the commune of Kétou ; 2008.
8. ASECNA. Agency for Air Navigation Safety in Africa and Madagascar. Climatic and rainfall data service, Cotonou-Benin ; 2023.
9. Center of expertise in environmental analysis of Quebec. Method of analysis: Determination of particle size in agricultural soils and sediments: Bouyoucos method. Quebec;2003. Available:[https://www.ceaeq.gouv.qc.ca/index\\_en.asp](https://www.ceaeq.gouv.qc.ca/index_en.asp).
10. NF EN ISO 17892-4. Geotechnical reconnaissance and testing - Laboratory tests on soils - Part 4: Determination of particle size distribution; 2018.

11. Leghari N, Oad VK, Shaikh, AA, Soomro AA. Analysis of different tillage implements with respect to reduced fuel consumption, tractor operating speed and its wheel slippage. Sindh University Research Journal (science series). 2016;48(1):37-40.
12. Innovation, science and economic development Canada. Diesel volume-fuel correction factors. Canada ; 2008. Available:[https://www.ic.gc.ca/eic/site/mc-mc.nsf/vwapj/FCV\\_Diesel.pdf/\\$file/FCV\\_Diesel.pdf](https://www.ic.gc.ca/eic/site/mc-mc.nsf/vwapj/FCV_Diesel.pdf/$file/FCV_Diesel.pdf)
13. Hunt D. Farm power and machinery management (Tenth ed.). Illinois: Waveland Press, Inc; 2008.
14. E-Agri. Development of e-Course for B.Sc (Agriculture). E-Agri; 2023. Available:<http://www.eagri.org/eagri50/FM P211/lec05.html>.
15. Firestone. Agricultural tire technology. Retrieved from firestone agriculture; 2021. Available:<https://www.firestone-agriculture.fr/blog/vous-voulez-tout-savoir-sur-le-patinage-de-vos-pneus-de-tracteur>.
16. El-Sanat GMA, Aiad MA, Amer MM. Impact of Some soil amendments and different tillage depths on saline heavy clay soils properties and its yield water productivity. Int. J. Plant Soil Sci. 2017; 14(2):1-13. Accessed On:2024 May 17. Available:<https://journalijpss.com/index.php/IJPSS/article/view/316>
17. Ali Behaen M. Application of Tillage implements in different depths of soil on sugar beet (*Beta vulgaris* L.) Yield and some soil properties. Asian J. Adv. Agric. Res. 2018;7(4):1-9. Accessed On :2024 May 17. Available:<https://journalajaar.com/index.php/AJAAR/article/view/11>
18. Gál A, Vyn TJ, Michéli E, Kladvko EJ, McFee WW. Soil carbon and nitrogen accumulation with long-term no-till versus moldboard plowing overestimated with tilled-zone sampling depths. Soil and Tillage Research. 2007;96(1-2):42-51.

© Copyright (2024): Author(s). The licensee is the journal publisher. This is an Open Access article distributed under the terms of the Creative Commons Attribution License (<http://creativecommons.org/licenses/by/4.0>), which permits unrestricted use, distribution, and reproduction in any medium, provided the original work is properly cited.

*Peer-review history:*

*The peer review history for this paper can be accessed here:*  
<https://www.sdiarticle5.com/review-history/117754>