



**HAL**  
open science

# A comparison of power plant energy flow prediction using real data applied to linear programming and if-else algorithms

Chaker Ibrahim, Jean-Michel Reboul, David Houivet, Hamid Gualous, Hassan Ali Barkad

## ► To cite this version:

Chaker Ibrahim, Jean-Michel Reboul, David Houivet, Hamid Gualous, Hassan Ali Barkad. A comparison of power plant energy flow prediction using real data applied to linear programming and if-else algorithms. *Energy Reports*, 2023, 9, pp.294-300. 10.1016/j.egy.2023.09.169 . hal-04614577

**HAL Id: hal-04614577**

**<https://hal.science/hal-04614577v1>**

Submitted on 17 Jun 2024

**HAL** is a multi-disciplinary open access archive for the deposit and dissemination of scientific research documents, whether they are published or not. The documents may come from teaching and research institutions in France or abroad, or from public or private research centers.

L'archive ouverte pluridisciplinaire **HAL**, est destinée au dépôt et à la diffusion de documents scientifiques de niveau recherche, publiés ou non, émanant des établissements d'enseignement et de recherche français ou étrangers, des laboratoires publics ou privés.



Distributed under a Creative Commons Attribution - NonCommercial - NoDerivatives 4.0 International License

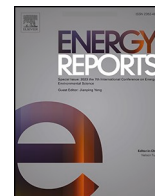

# A comparison of power plant energy flow prediction using real data applied to linear programming and if-else algorithms<sup>☆</sup>

Chaker Ibrahim<sup>a,b,\*</sup>, Jean-Michel Reboul<sup>a</sup>, David Houivet<sup>a</sup>, Hamid Gualous<sup>a</sup>, Hassan Ali Barkad<sup>b</sup>

<sup>a</sup> University of Caen-Normandie, 60, Rue Max-Pol Fouchet, 50130 Cherbourg, France

<sup>b</sup> University of Djibouti, Croisement RN2-RN5, 1904 Djibouti, Djibouti

## ARTICLE INFO

### Keywords:

Hybrid microgrids  
Storage systems  
Energy management systems  
Renewable energy  
Linear programming (LP)

## ABSTRACT

In this paper, the energy flow prediction of a grid-connected Hybrid Microgrid (HMG) is studied. The studied system consists of a 19 kW photovoltaic (PV) array, a 6.5 kW wind turbine (WT), and a 59.32 kWh battery Energy Storage System (ESS). Two energy prediction and optimization algorithms, Linear Programming and If-Else (LP-If-Else), are applied to analyze the site's energy flow behavior and accurately predict it one day in advance. Meteorological data collected at the site and real load profiles are used in this study. To highlight the effectiveness of the offline prediction approach, three extreme cases are applied to three energy management strategies and compared. The results of the prediction performed by the two algorithms showed that a single prediction algorithm (LP) is not sufficient to accurately predict the energy flow for the next day.

## 1. Introduction

The energy transition is currently imposing profound changes on electricity networks. The increase in demand, coupled with the massive integration of renewable and intermittent production sources, is jeopardizing their stability.

The integration of distributed energy resources, storage systems, distributed electrical loads, and the main distribution grid through the common coupling point is called a microgrid (Jiayi et al., 2008). The use of microgrids is one of the solutions to overcome the problem of overproduction or underproduction of energy. The use of clean and renewable energy sources such as PV (photovoltaic) and wind power is a remarkable and environmentally friendly method (Bernal-Aguistin and Dufo-Lopez, 2009; Elsied et al., 2014). In the review Olatomiwa et al. (2016) and Zia et al. (2018), several papers have been listed that cover different configurations of hybrid renewable energy systems for power generation. To address this problem, the University of Djibouti has a multi-source power plant. This microgrid is connected to the main grid and serves as an auxiliary facility for the university during off-peak and peak hours. When the plant produces less energy to meet its own load demand, the site can draw power from the grid. On the other hand, when the plant produces more energy than its own load demand, the site can

feed the excess energy back to the University to partially reduce the University's bill. The main objective of this study is to accurately determine the energy flow of the power plant one day in advance using two algorithms (LP and If-Else), while adhering to the constraints and limits set by the energy management strategy formulated in this study. The emphasis is placed on quantifying the excess energy that can be injected into the university. This study aims to provide a clear understanding of the site's energy behavior by considering meteorological data and consumption fluctuations. In our study, we focus on linear programming approaches using Matlab. Below is Table 1, which summarizes the different works that are closely related to our case study, whether it is their configuration, approach, or strategies used.

This paper is structured into five sections, each addressing specific aspects of the study. The first section provides an overview and introduction to the research topic. The second section delves into the architecture and mathematical modeling of the studied system. In the third section, the problem formulation is presented, along with an analysis of the constraints and limitations of the system under study. The fourth section comprises the results and discussion, including the comparison of the two algorithms and the analysis of the three scenarios. Finally, the fifth section concludes the paper and provides potential avenues for further research.

<sup>☆</sup> 2023 8th International Conference on Sustainable and Renewable Energy Engineering (ICSREE 2023) 11–13 May, Nice, France.

\* Corresponding author at: University of Caen-Normandie, 60, Rue Max-Pol Fouchet, 50130 Cherbourg, France.

E-mail address: [chaker.ibrahim-omar@unicaen.fr](mailto:chaker.ibrahim-omar@unicaen.fr) (C. Ibrahim).

**Table 1**  
Summary of studies of energy management system (EMS) based linear programming.

Ref.	Configuration	EMS Approach	Remarks
(Dash and Bajpai, 2015)	Standalone PV/ Battery/ Fuel cell	LP via Simulink	An energy management strategy based on injecting excess energy into the electrolyzer when the battery is full was adopted in this study. The study emphasizes battery protection and achieving a balanced load and output.
(Pascual et al., 2015)	Standalone PV/ Wind/ Battery/Grid	LP	In this EMS, the generation forecast, battery state of charge, and system input/output are taken into account. The grid is used as a backup, and the battery compensates for any discrepancies between the measured and forecasted power. An EMS strategy has been developed to predict the power produced one day in advance, irrespective of weather conditions. The objective of this strategy is to address the unpredictability of PV production and reduce primary fuel dependency. The utility grid serves as a backup.
(Comodi et al., 2015)	Standalone Wind/PV/ Microgaz/Grid	LP	An online and real-time EMS has been developed to minimize the costs of electricity operation and shutdown. The developed model is analyzed using three case studies: perfect prediction, imperfect prediction, and accurate information. These case studies are subject to comparative analysis in terms of economic gain and calculation time.
(Luna et al., 2017)	PV/Fuel cell/ Battery/Grid	LP-PSO	An optimal energy management strategy is proposed to minimize the operational cost of microgrids, considering the integration of compressible and movable loads in demand response. The objective function encompasses operating and maintenance costs, start-up and shutdown costs, energy exchange costs with the main grid, and power outage costs.
(Tenfen and Finardi, 2015)	PV/Wind/ Battery/ Fuel cell/Micro-turbines/Grid	Mixed integer LP	In this study, a prioritization of the PV and the Battery as the primary sources to supply the load has been formulated. The Generator is utilized as a backup in cases of energy insufficiency from the PV and the Battery. Three strategies for an energy management system have been formulated to minimize the excess of energy by feeding directly one building of the university. The objective of strategy 1 is to prioritize renewable sources (PV-Wind) to feed the load and use batteries up to the State of Charge $SOC_{min} = 30\%$ . Excess energy should be fed to the University. The main grid will be used as a backup power supply in case of unavailability of PV, Wind, and
(Ismail et al., 2013)	Standalone PV/ Battery/Diesel	LP via Matlab	
(This study)	Standalone PV/ Wind/ Battery/Grid	LP via Matlab	

**Table 1 (continued)**

Ref.	Configuration	EMS Approach	Remarks
			Battery systems. The objective of strategies 2 and 3 have the same priority as strategy 1, as a different strategy 2 discharges the battery to a $SOC_{min} = 50\%$ , and the other fully discharge the battery to 100 %.

**2. Architecture & mathematical model of the studied system**

**2.1. Architecture of the system**

The architecture of the system is presented in Fig. 1, which includes a photovoltaic park with a capacity of 19 kW. The park consists of four rows of 19 panels, each with a power rating of 250 W, connected in series. Additionally, there is a three-bladed ANTARIS wind turbine with a capacity of 6.5 kW and a diameter of 5.3 m. The system also incorporates a storage system (Hoppecke 6 OPzV) comprising 72 batteries, each with a voltage of 2 V and a capacity of 412 Ah, resulting in a total capacity of 1236 Ah  $C_{10}$ . The batteries are divided into three rows connected in parallel, and each row consists of 24 batteries connected in series.

**2.2. Mathematical model of the study system**

**2.2.1. Photovoltaic panel model**

The mathematical model of the photovoltaic module has been found in the literature (Ayop and Tan, 2017; Thangamani et al., 2020). The expected power output of a module depends on factors such as ambient temperature, site irradiation rate, and the technical characteristics of the module. To estimate the power output of the module, the following equation can be used (Bhandari et al., 2015a):

$$P_{pv} = P_{ref_{pv}} \frac{I}{I_{ref}} [1 + k((T + 0.0256 \times I) - T_{ref})] \tag{1}$$

Where  $P_{ref_{pv}}$  is the reference power of the module (in kW),  $I_{ref}$  is the reference irradiation rate (1 kW/m<sup>2</sup>),  $I$  is the actual irradiation exposed at the surface of the module (in W/m<sup>2</sup>),  $k$  is the temperature coefficient (in °C<sup>-1</sup>),  $T$  is the ambient temperature (in °C), and  $T_{ref}$  is the reference temperature (in °C).

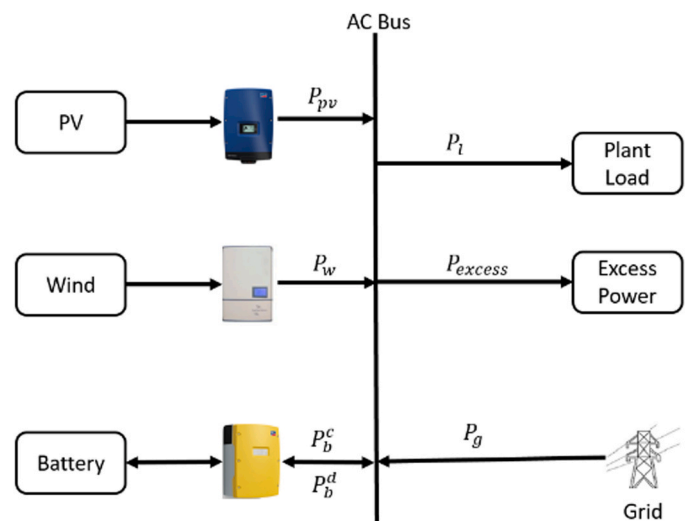

**Fig. 1.** Power plant architecture installed in the University of Djibouti.

### 2.2.2. Wind turbine model

The power output  $P_w$  of the wind turbine can be represented mathematically by Eq. (2) as reported in Bhandari et al. (2015b) and Shin et al. (2017).

$$P_w = \begin{cases} 0, & 0 \leq v \leq v_{ci} \\ P_{ref_w} \times \eta(v), & v_{ci} \leq v \leq v_r \\ P_{ref_w}, & v_r \leq v \leq v_{co} \\ 0 & v_{co} \leq v \end{cases} \quad (2)$$

Where  $v$ ,  $v_{ci}$ ,  $v_r$  and  $v_{co}$  are the wind speed, the cut-in wind speed, the rated speed of the turbine and the cut-out wind speed respectively (in m/s).  $P_{ref_w}$  is the rated electric of turbine (in kW) and  $\eta(v)$  is the wind speed coefficient. The formula for the wind speed coefficient  $\eta(v)$  is given in Eq. (3).

$$\eta(v) = \frac{v - v_{ci}}{v_r - v_{ci}} \quad (3)$$

### 2.2.3. Storage system model

The mathematical model of the battery power can be represented according to Eqs. (4) and (5) as reported in (Lan et al., 2015). The discharge and charge power of the batteries (in kW) is respectively:

$$P_b^d(t) = P_l(t) - P_{pv}(t) - P_w(t) \quad (4)$$

$$P_b^c(t) = P_{pv}(t) + P_w(t) - P_l(t) \quad (5)$$

The energy of the batteries can also be represented according to Eqs. (6) and (7) as reported in (Chen et al., 2011).

$$E_b^c(t) = E_b^c(t-1) + P_b^c(t) \cdot \frac{\Delta t}{\eta_c} \quad (6)$$

$$E_b^d(t) = E_b^d(t-1) + P_b^d(t) \cdot \frac{\Delta t}{\eta_d} \quad (7)$$

Where  $P_b^d$ ,  $P_b^c$ ,  $\eta_c$ ,  $\eta_d$ ,  $E_b^c(t-1)$ ,  $E_b^d(t-1)$  are the battery discharging and charging power (in kW), the battery charging and discharging efficiency, the battery charging and discharging energy (in kWh) and  $\Delta t$  is the observed time interval set to 1 h and  $P_l(t)$  is the load power of plant (in kW).

## 3. Problem formulation

### 3.1. Objective function

The objective function chosen is a cost function considering the cost of energy taken from the main grid. Minimizing the cost function will inversely increase the excess energy. The formula is written in the form of Eq. (8) as shown in (Elaouni et al.,):

$$Min f_{LP}(x) = \sum_{i=1}^T (C_G(i) \times P_g(i)) \quad (8)$$

Where  $C_G$  is the cost of purchasing energy from the electricity grid (0.27€ / kWh)<sup>1</sup>,  $P_g$  the power drawn from the main grid (in kW) and  $T$  is the energy management system period 24 h and  $i$  is the time interval (e.g., 1 h).

### 3.2. Design constraint and system parameters

The net power balance constraint imposes at each time of the day according to Eq. (9).

$$\sum (P_l(t) + P_b^c(t) + P_{excess}(t) - P_{pv}(t) - P_w(t) - P_g(t) - P_b^d(t)) = 0 \quad (9)$$

The storage constraint is formulated based on the limitations of the battery's charge and discharge rates at each time. These limits are imposed by three Sunny Island 6.0 H units, with a charge current limit of 90 A and a discharge current limit of 103 A. These constraints are represented by the following inequalities (10) and (11).

$$0 \leq P_b^c(t) \leq P_b^{cmax} \quad (10)$$

$$0 \leq P_b^d(t) \leq P_b^{dmax} \quad (11)$$

Where  $P_b^{cmax}$ ,  $P_b^{dmax}$ , are the maximum charge power of the battery (in kW) and the maximum discharge power of the battery (in kW).

Djibouti, it is not permitted to inject excess energy into the main grid. Therefore, only the power drawn from the grid will be considered, as indicated by the following inequality (12).

$$0 \leq P_g(t) \leq P_l(t) \quad (12)$$

Table 2 shows the rest of the limits of the system.

### 3.3. Linear program implementation

This section introduces the linear programming (LP) algorithm applied in this study for predicting the site's energy flow one day in advance, as depicted in Fig. 2. The advantages of this algorithm can be summarized as follows (Dantzig et al., 1955):

- It is one of the earliest and most widely used algorithms.
- It demonstrates faster computational speed compared to other linear system-solving algorithms.
- It is particularly effective when dealing with problems involving more than three variables, where graphical methods may not be suitable.

### 3.4. If-else algorithm

The If-Else algorithm is used to refine the prediction made by linear programming. In this approach, the same variables are used:

- The excess power injected into the university ( $P_{excess}$ ).
- The battery charge and discharging power ( $P_b^c$  and  $P_b^d$ ).
- The battery state of Charge (SOC).
- The power withdrawn from the utility grid ( $P_g$ ).

The results of the linear programming, including the cost function formulated in Section 3.1, as well as the limits and constraints formulated in Section 3.2, are utilized as inputs for the If-Else algorithm. The estimation of the site's energy flow involves calculating the differences in load, Solar, and Wind power between the previously recorded data and the current data, as demonstrated by Eqs. (13) and (14).

$$\Delta_{day}(t) = P_l(t) - P_{pv}(t) - P_w(t) \quad (13)$$

$$\Delta_{forecast}(t) = P_{l-forecast}(t) - P_{pv-forecast}(t) - P_{w-forecast}(t) \quad (14)$$

$\Delta_{day}$  is the difference in power of the day (in kW),  $\Delta_{forecast}$  is the

**Table 2**  
The limits of the system.

ID	Type	Min. Power (kW)	Max. Power (kW)
1	$P_{pv}$	0	19
2	$P_w$	0	6.5
3	$P_l$	0	8.5
4	$P_b^c$	0	1.48
5	$P_b^d$	0	1.23

<sup>1</sup> 55 Fdj = 0.27 € the price of kWh in Djibouti 2023.

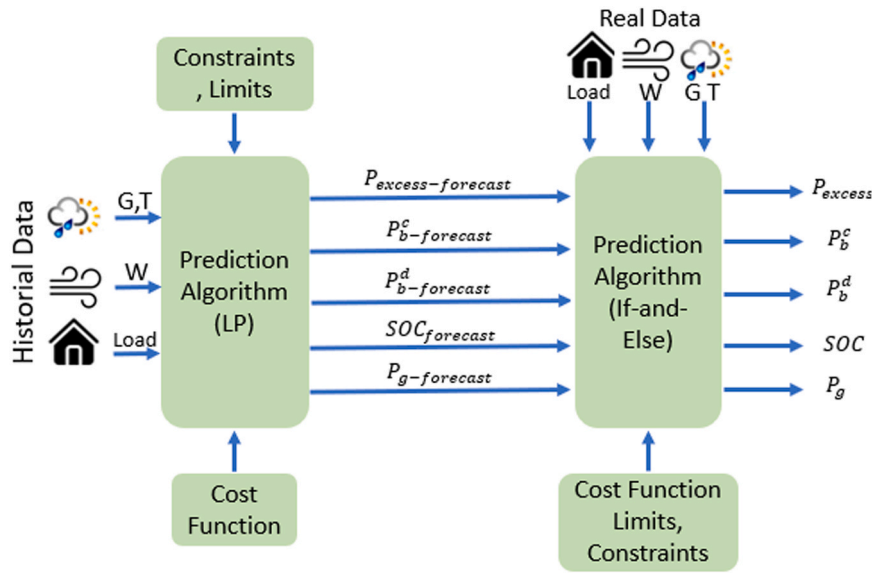

Fig. 2. The prediction approach adopted in this study.

difference in power of the previous day (in kW) and  $t$  is the time (in 24 h).

Subsequently, a difference in results is made as shown in Eq. (15).

$$\Delta(t) = \Delta_{day}(t) - \Delta_{forecast}(t) \tag{15}$$

$\Delta(t)$  are the result of the energy flow powers (in kW).

$$If - Else = \begin{cases} P_{excess-forecast}, \\ P_b^c-forecast, \\ P_b^d-forecast, \\ P_g-forecast, \\ SOC_{forecast}, \end{cases} \quad \text{if } \Delta(t) = 0 \tag{16}$$

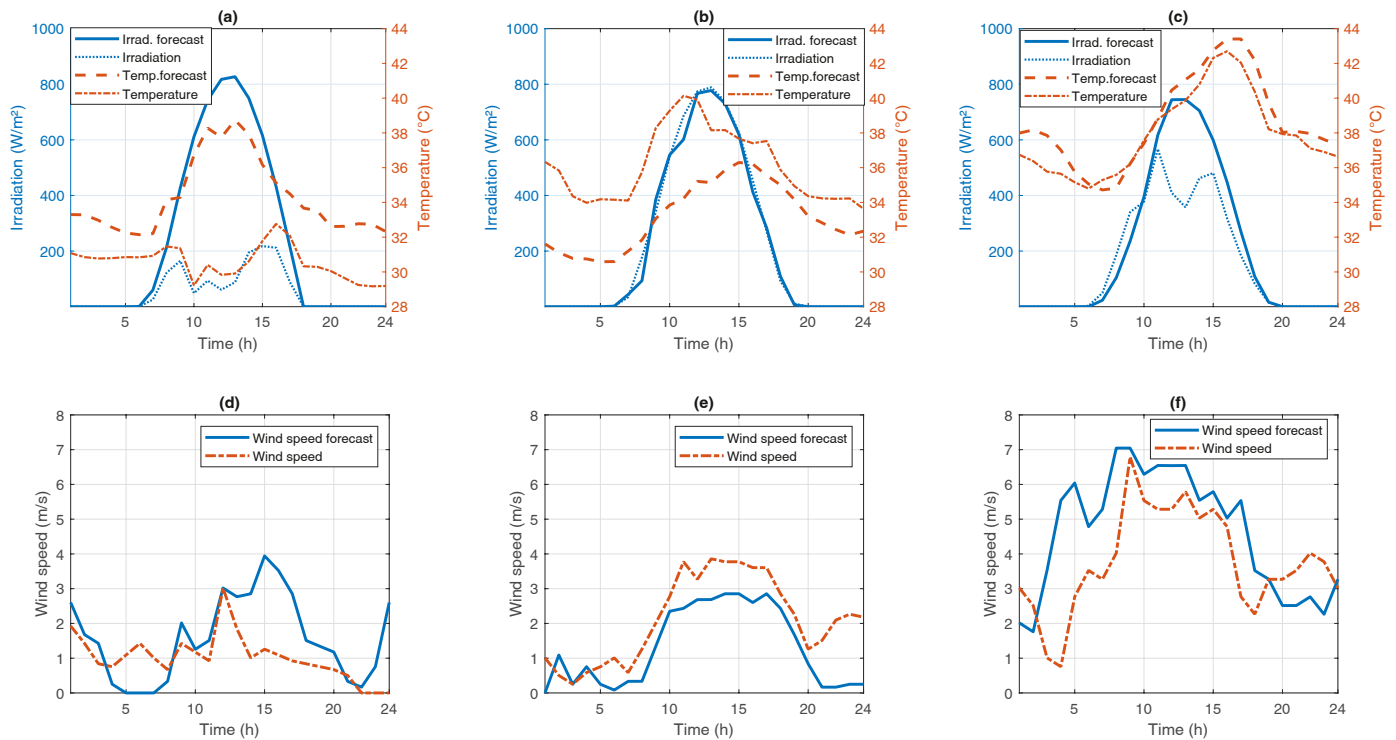

Fig. 3. (a) and (d) depict the evolution of temperature, solar irradiation, and wind speed on October 7–8, 2021, for scenario 1. (b) and (e) illustrate the evolution of temperature, solar irradiation, and wind speed on November 29–30, 2021, for scenario 2. (c) and (f) showcase the evolution of temperature, solar irradiation, and wind speed on July 4–5, 2022, for scenario 3.

$$If - Else = \begin{cases} P_{excess}, \\ P_b^c, \\ P_b^d, \\ P_g, \\ SOC, \end{cases} \quad \text{if } \Delta(t) \neq 0 \quad (17)$$

### 4. Discussion and results

The energy flow prediction for the next day in a power plant is determined using the linear programming algorithm. The algorithm considers the actual weather data and load profile as input to forecast the power generated by the battery, excess power, and power drawn from the utility grid. The meteorological data recorded by a station installed at the University of Djibouti is used in this study. Fig. 3 illustrates the patterns of temperature, irradiation, and wind speed for three different scenarios: October 7–8, 2021; November 29–30, 2021; and July 4–5, 2022. To evaluate the performance of the two algorithms, three scenarios were formulated in this study. Scenario 1: In this case, the power plant’s performance is evaluated under the worst weather conditions recorded in Djibouti. The weather data from October 7, 2021, and October 8, 2021, were used for this case study. Due to forgetfulness or other reasons, certain buildings in Djibouti might continue to operate without being turned off, making it important to simulate this situation. Scenario 2: This scenario assumes that the devices in the power plant operate for a full day, resulting in a significantly higher charging power compared to the expected charging power. The weather data from November 29, 2021, and November 30, 2021, were used for this case study. Scenario 3: This scenario considers summer weather conditions with high load and weather fluctuations. The weather data from July 4, 2022, and July 5, 2022, were used for this case study. This scenario is inspired by real situations that occurred in Djibouti.

#### 4.1. Comparison of the two algorithms

In scenario 1, a 100 % difference between the results of the Linear Programming (LP) algorithm and the If-Else algorithm can be observed for grid power. However, the difference between the excess power and the excess power forecast is not as significant, with a maximum difference of 50 %. In scenarios 2 and 3, there is a significant difference between the two algorithms for the excess power, grid power, and battery power, with a 100 % difference observed. In both case studies, there is a notable disparity between the predicted and observed power flow behavior. These findings highlight that a single algorithm is insufficient to accurately predict the power flow behavior of the plant.

#### 4.2. Comparison of the three strategies

Fig. 4 illustrates the scenario 1, focusing on strategy 1, with a daily production of 17.65 kWh (significantly lower than the forecasted 81.6 kWh), the site consumes 33.2 kWh of energy from the network, accounting for 55 % of the daily load. In strategy 2, the site consumes 34.47 kWh of grid energy, representing 57.5 % of the daily load power. Strategy 3 demonstrates the lowest grid energy consumption among the three strategies, with the site drawing 31.5 kWh or 52.5 % of the daily load consumption. Notably, in all three strategies, no excess energy is generated, and a significant amount of energy is drawn from the grid, contrary to what was predicted by the LP algorithm.

Fig. 5 illustrates the results for scenario 2, focusing on strategy 1. With a daily load of 204 kWh, significantly higher than the predicted load of 60 kWh, the site consumes 118 kWh of energy from the utility grid, accounting for 57 % of the daily load. Simultaneously, 26 % of the daily production, equivalent to 20.88 kWh, is injected into the university, representing 53 % of the predicted amount. Notably, the LP algorithm predicted that no energy would be drawn from the grid. In strategy 2, the site consumes 121.26 kWh of energy from the grid, which corresponds to 59.4 % of the daily load power. Additionally, a slightly

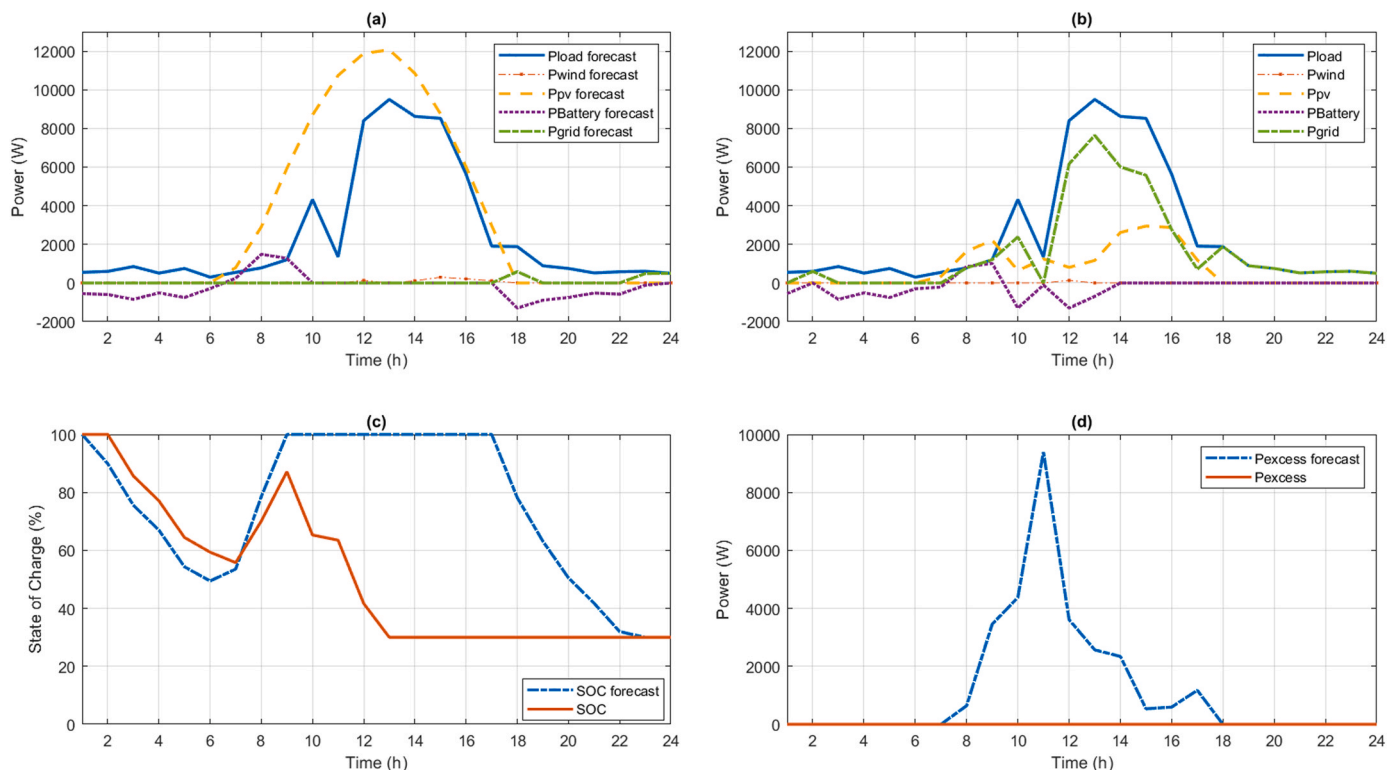
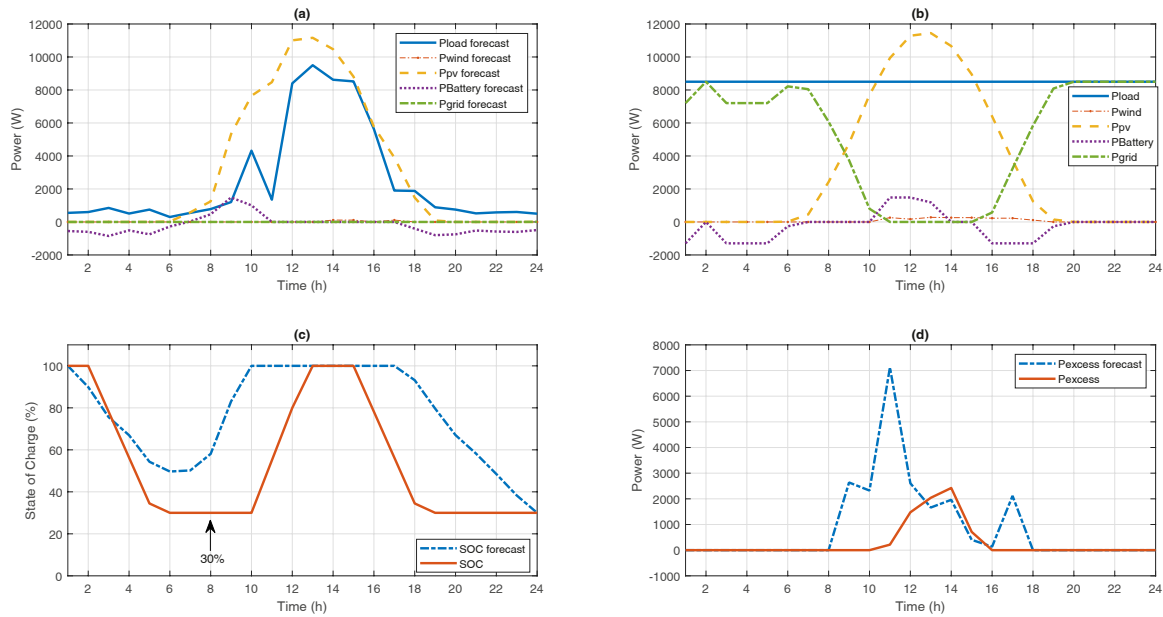

Fig. 4. (a) Represents the power of PV, Load, Battery, and Grid predicted by LP of scenario 1, (b) Represents the power of PV, Load, Battery, and Grid rectified by If-Else of scenario 1. The variation in the state of charge and excess power was predicted and rectified by LP and If-Else for scenarios 1 (c) and (d).



**Fig. 5.** (a) Represents the power of PV, Load, Battery, and Grid predicted by LP of scenario 2, (b) Represents the power of PV, Load, Battery, and Grid rectified by If-Else of scenario 2. The variation in the state of charge and excess power was predicted and rectified by LP and If-Else for scenarios 2 (c) and (d).

higher amount of excess energy is generated, amounting to 22.07 kWh, or 27.8 % of the daily production. However, in strategy 3, the site has the lowest energy consumption from the grid at 115.3 kWh, accounting for 56 % of the daily consumption. In terms of excess energy, this strategy generates 19.1 kWh, equivalent to 24 % of the daily production. This can be attributed to the battery discharging to its maximum capacity, effectively storing as much energy as possible.

Fig. 6 demonstrates the results for scenario 3, focusing on strategy 1. With a daily load of 236 kWh, significantly higher than the predicted load of 60 kWh, the plant consumes 143 kWh of energy from the utility grid, accounting for 60 % of the daily load. Interestingly, we can observe a consistent discharge of the battery throughout the day. However, no excess energy is injected into the university. It is worth noting that the LP algorithm predicted that no energy would be drawn from the grid,

and 30.83 kWh of energy was expected to be injected into the university. In strategies 2 and 3, regardless of the state of charge (50 % and 100 %), we observe the same result provided by both algorithms. The comparison of the three strategies is summarized in Table 3.

**5. Conclusion**

This study focused on predicting the day-ahead energy flow of a power plant installed at the University of Djibouti. Two prediction algorithms, namely LP and If-Else, were utilized for three energy management strategies under extreme scenarios. A comparison between the LP and If-Else algorithms revealed a significant difference of at least 90 % between the predicted and observed results. These findings highlighted that a single prediction algorithm, such as LP, is insufficient for

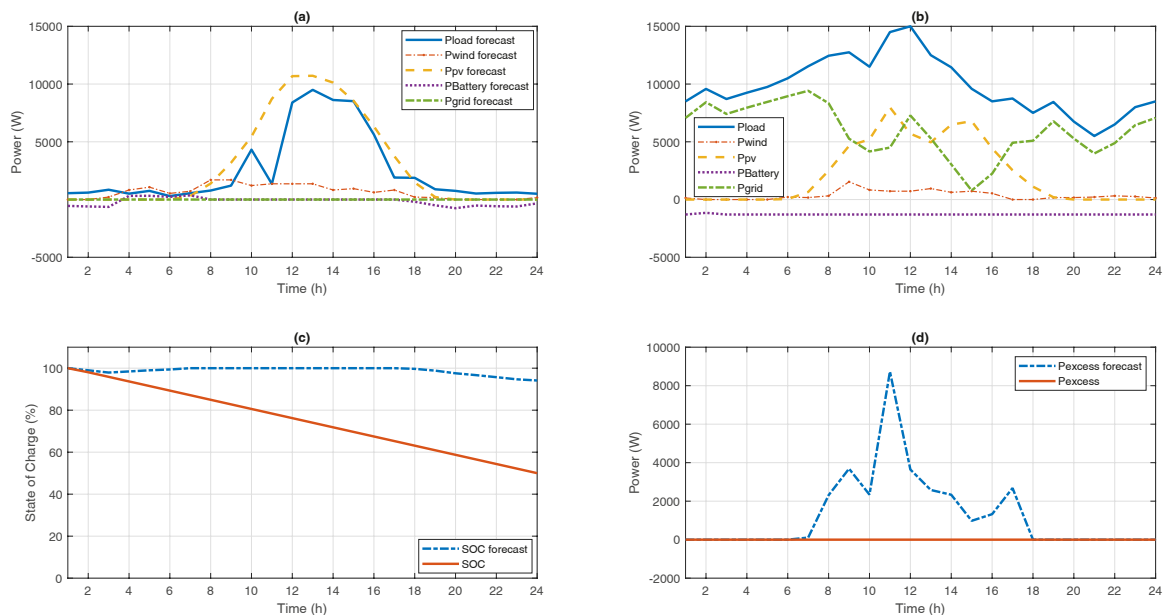

**Fig. 6.** (a) Represents the power of PV, Load, Battery, and Grid predicted by LP of scenario 3, (b) Represents the power of PV, Load, Battery, and Grid rectified by If-Else of scenario 3. The variation in the state of charge and excess power was predicted and rectified by LP and If-Else for scenarios 3 (c) and (d).

Table 3

Comparison of the three strategies with the three extreme cases.

Scenario	Strategy 1 ( $SOC_{min} = 30\%$ )				Strategy 2 ( $SOC_{min} = 50\%$ )				Strategy 3 ( $SOC_{min} = 100\%$ )			
	LP (kWh)		If-Else (kWh)		LP (kWh)		If-Else (kWh)		LP (kWh)		If-Else (kWh)	
	$P_g$	$P_{excess}$	$P_g$	$P_{excess}$	$P_g$	$P_{excess}$	$P_g$	$P_{excess}$	$P_g$	$P_{excess}$	$P_g$	$P_{excess}$
Case 1	0	39.35	118	20.88	0.82	39.37	121.26	22.07	0	39.35	115.3	19.10
Case 2	1.5	48.83	33.2	0	2.78	48.86	34.47	0	0.58	48.83	31.5	0
Case 3	0	30.83	142.9	0	0	30.83	143.06	0	0	30.83	142.9	0

accurately predicting the next day's energy flow. Furthermore, a comparison between the three strategies was conducted, and the most favorable result was obtained with strategy 1, which incorporated a minimum State of Charge (SOC) of 30 %. This strategy aligned perfectly with the objectives outlined in this study, including the protection of battery life (a crucial criterion for the Djiboutian desert climate) and low energy consumption from the grid. For future work, it is recommended to reinforce this study by exploring additional prediction algorithms, such as genetic algorithms and the Fuzzy logic algorithm, and comparing them to linear programming. To enhance accuracy, real-time prediction of energy flow could be implemented using multiple prediction algorithms, such as a combination of linear programming and genetic algorithms. All these predictions could be compared to real-time data using a Supervisory Control and Data Acquisition (SCADA) system.

#### Declaration of Competing Interest

The authors declare no conflict of interest.

#### Data availability

The authors are unable or have chosen not to specify which data has been used.

#### Acknowledgements

Chaker Ibrahim's thesis is funded by the French Government through Campus France. The author also thanks the University of Djibouti and the University Laboratory of Applied Sciences of Cherbourg (LUSAC).

#### References

- Ayop, R., Tan, C.W., 2017. A comprehensive review on photovoltaic emulator. *Renew. Sustain. Energy Rev.* 80, 430–452.
- Bernal-Aguistin, J.L., Dufo-Lopez, R., 2009. Simulation and optimization of stand-alone hybrid renewable energy systems. *Renew. Sustain. Energy Rev.* 13 (8), 2111–2118.
- Bhandari, B., Lee, K.-T., Lee, G.-Y., Cho, Y.-M., Ahn, S.-H., 2015a. Optimization of hybrid renewable energy power systems: a review. *Int. J. Precis. Eng. Manuf. -Green Technol.* 2 (1), 99–112.

- Bhandari, B., Lee, K.-T., Lee, G.-Y., Cho, Y.-M., Ahn, S.-H., 2015b. Optimization of hybrid renewable energy power systems: a review. *Int. J. Precis. Eng. Manuf. Green Technol.* 2 (1), 99–112.
- Chen, S.X., Gooi, H.B., Wang, M., 2011. Sizing of energy storage for microgrids. *IEEE Trans. Smart Grid* 3 (1), 142–151.
- Comodi, G., Renzi, M., Cioccolanti, L., Caresana, F., Pelagalli, L., 2015. Hybrid system with micro gas turbine and PV (photovoltaic) plant: guidelines for sizing and management strategies. *Energy* 89, 226–235. <https://doi.org/10.1016/j.energy.2015.07.072>.
- Dantzig, G.B., Orden, A., Wolfe, P., 1955. The generalized simplex method for minimizing a linear form under linear inequality restraints. *Pac. J. Math.* 5 (2), 183–195.
- Dash, V., Bajpai, P., 2015. Power management control strategy for a stand-alone solar photovoltaic-fuel cell–battery hybrid system. *Sustain. Energy Technol. Assess.* 9, 68–80. <https://doi.org/10.1016/j.seta.2014.10.001>.
- H. Elaoui, H. Obeid, S.L. Masson, H. Gualous, O. Foucault, Performance of Linear Programming in Optimizing the Energy Schedule of a Grid-connected Hybrid System Compared to Particle Swarm Optimization.
- M.F. Elsieid, A. Oukaour, H. Gualous, Y. Slamani, R. Hassan, A. Amin, Analysis, modeling, and control of an AC microgrid system based on green energy. In: Proceedings of the International Conference on Renewable Energies and Power Quality (ICREQP'14) ISSN, 2014, 2172–038.
- Ismail, M.S., Moghavvemi, M., Mahlia, T.M.I., 2013. Techno-economic analysis of an optimized photovoltaic and diesel generator hybrid power system for remote houses in a tropical climate. *Energy Convers. Manag.* 69, 163–173. <https://doi.org/10.1016/j.enconman.2013.02.005>.
- Jiayi, H., Chuanwen, J., Rong, X., 2008. A review on distributed energy resources and MicroGrid. *Renew. Sustain. Energy Rev.* 12 (9), 2472–2483.
- Lan, H., Wen, S., Hong, Y.-Y., David, C.Y., Zhang, L., 2015. Optimal sizing of hybrid PV/diesel/battery in ship power system. *Appl. Energy* 158, 26–34.
- Luna, A.C., Meng, L., Diaz, N.L., Graells, M., Vasquez, J.C., Guerrero, J.M., 2017. Online energy management systems for microgrids: experimental validation and assessment framework. *IEEE Trans. Power Electron.* 33 (3), 2201–2215.
- Olatomiwa, L., Mekhilef, S., Ismail, M.S., Moghavvemi, M., 2016. Energy management strategies in hybrid renewable energy systems: a review. *Renew. Sustain. Energy Rev.* 62, 821–835.
- Pascual, J., Barricarte, J., Sanchis, P., Marroyo, L., 2015. Energy management strategy for a renewable-based residential microgrid with generation and demand forecasting. *Appl. Energy* 158, 12–25. <https://doi.org/10.1016/j.apenergy.2015.08.040>.
- Shin, J., Lee, J.H., Realff, M.J., 2017. Operational planning and optimal sizing of microgrid considering multi-scale wind uncertainty. *Appl. Energy* 195, 616–633.
- Tenfen, D., Finardi, E.C., 2015. A mixed integer linear programming model for the energy management problem of microgrids. *Electr. Power Syst. Res.* 122, 19–28.
- Thangamani, K., Manickam, M.L., Chellaiab, C., 2020. An experimental study on photovoltaic module with optimum power point tracking method. *Int. Trans. Electr. Energy Syst.* 30 (1), e12175.
- Zia, M.F., Elbouchikhi, E., Benbouzid, M., 2018. Microgrids energy management systems: a critical review on methods, solutions, and prospects. *Appl. Energy* 222, 1033–1055.