

Evaluation of scenarios for an energy, economic and social transition of the Fessenheim region (ESTEES project)*



Florian Labaude¹, Nadège Blond¹, Thierry de Laroche Lambert²

¹Laboratoire Image Ville Environnement, Strasbourg, France.

²Laboratoire FEMTO-ST, Besançon, France.

* **Evaluation de scénarios pour une transition énergétique, économique et sociale de la région de Fessenheim (projet ESTEES)**

"Energy transition" Session

Summary

- Context
- Project objectives
- Research methodology
- Energy analysis & planning tool EnergyPLAN
- Reference scenario and validation
- Energy transition scenarios 2030
- Towards Renewable Smart Energy Systems by 2050

Context

- Fessenheim NPP decommissioning
→ sustainable energy conversion of the territory 2020 - 2050
- global warming accelerating
- energy and geopolitical crises

Main guidelines

- (1) drastically reduce energy and material consumption = **sufficiency**
- (2) change the energy system : **renewable, resilient, efficient, sectorial-storage coupling**

Energy-climate pathways 2030-2050 of the Fessenheim territory

- (1) structural energy system changes → climate neutrality
- (2) energy investment and costs pathways (holistic vision)
- (3) socio-economic, environmental and health benefits

Project Objectives

- **developing** a permanent and accurate energy-climate **data-base** of the Haut-Rhin department
 - structure
 - construction methodology for further updates and simulations
 - **simulating** possible transformations of the **energy system**
 - Reference scenario 2018 – simulation – validation
 - Transition scenarios 2030 & 2050 – assumptions and parametric design – simulations
 - **comparing** with official **regional schemes**
- cost analysis
- planning recommendations
- publications

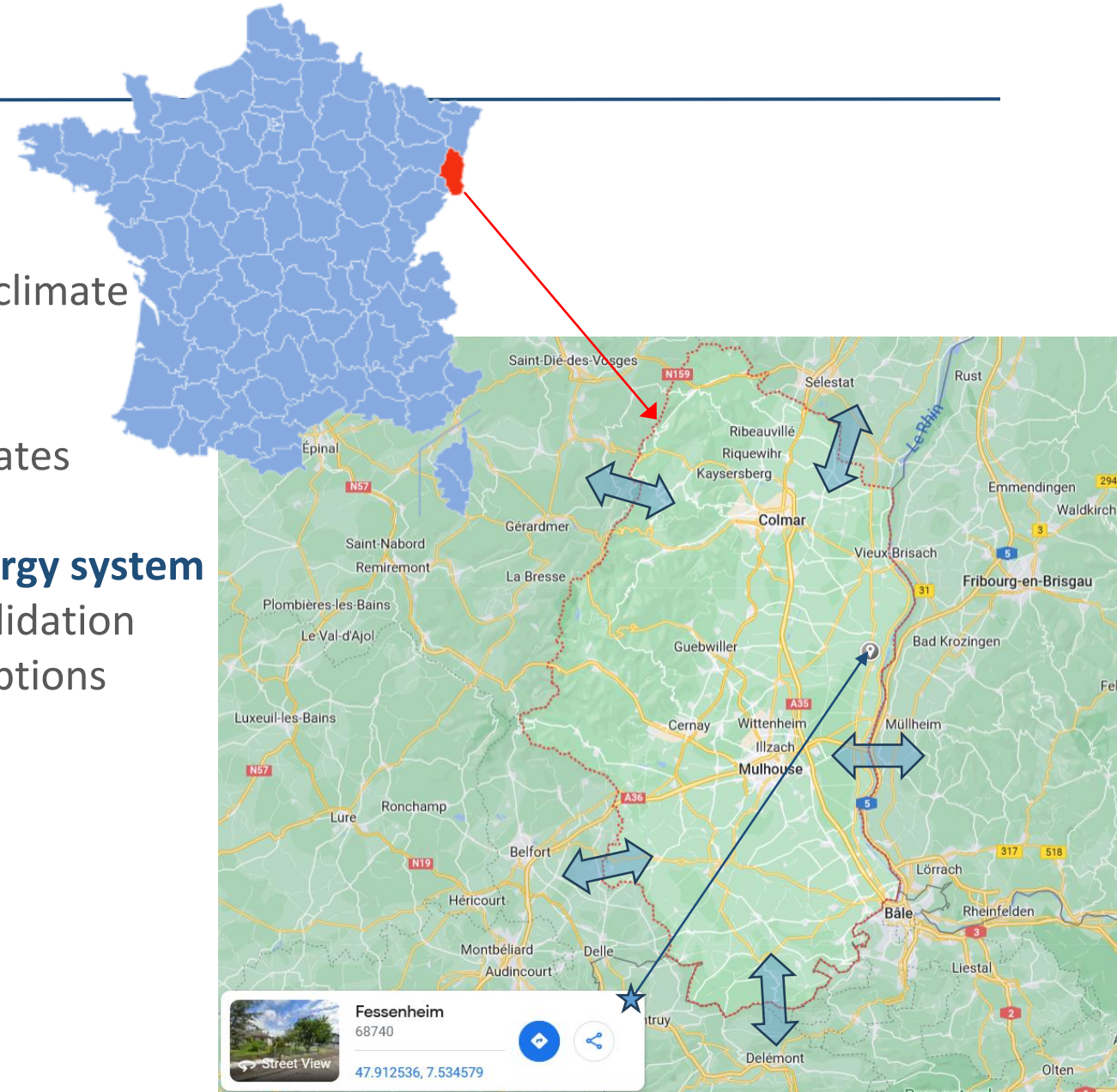

Research methodology

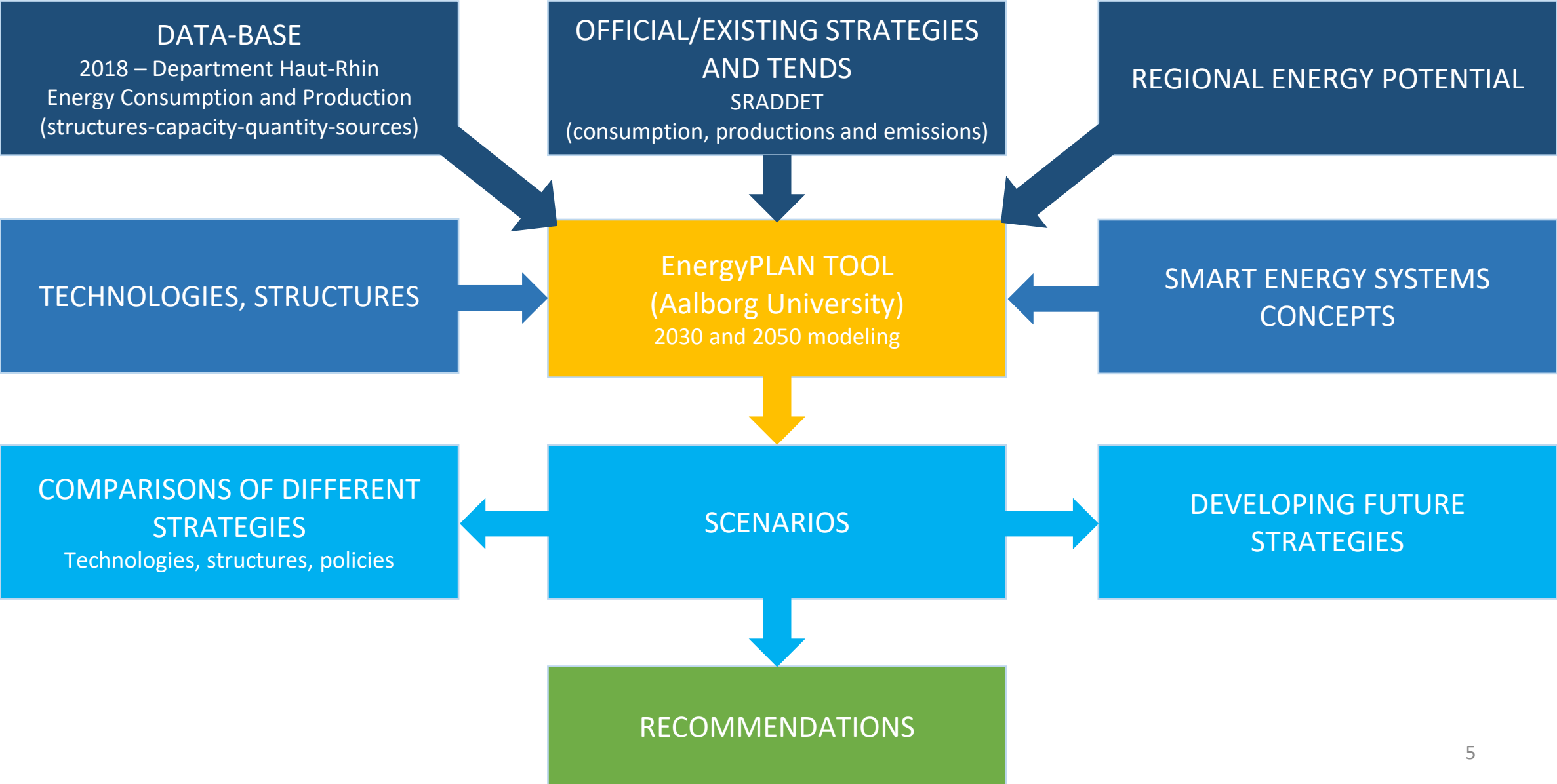

Energy analysis & planning tool EnergyPLAN

work progress

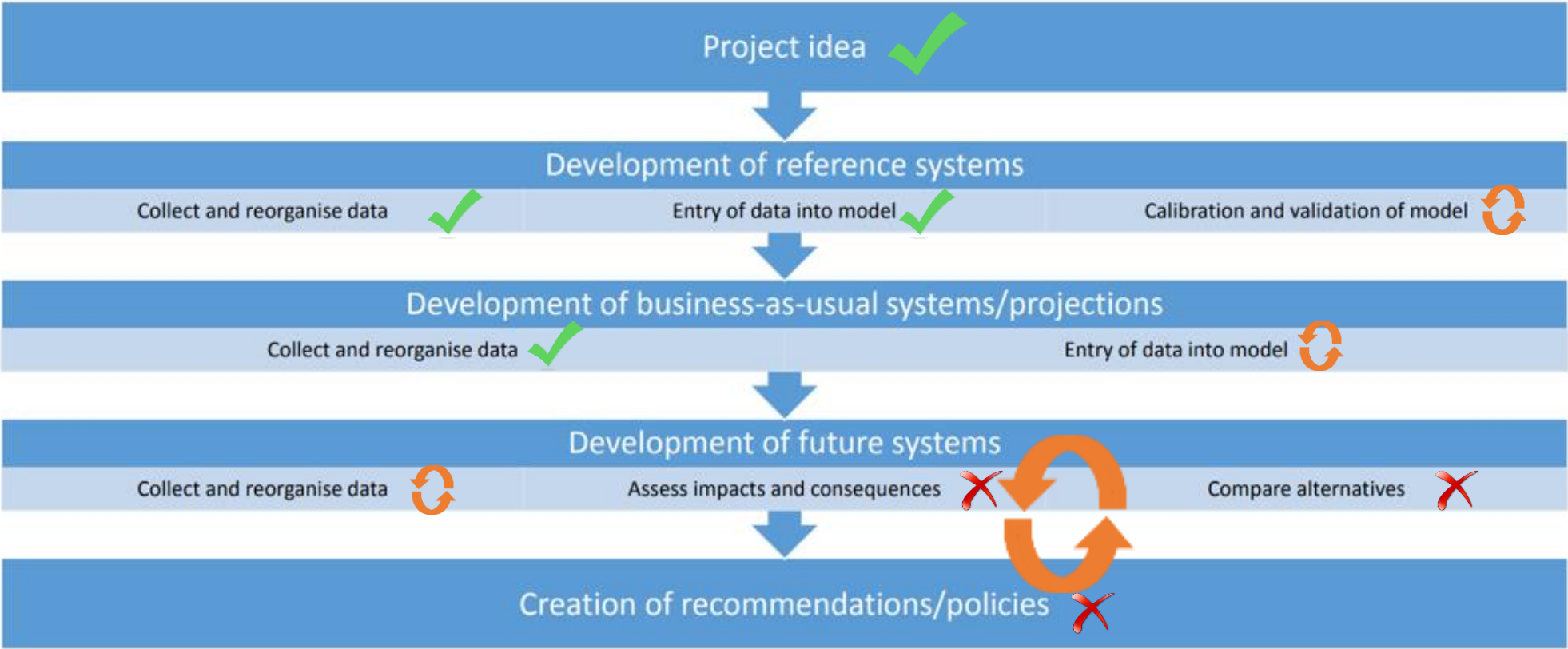

Steps from Jakob Zinck Thellufsen, Aalborg University

Reference scenario and validation

various sources of data



...

Detailed energy-GHG data-base

Current situation
Reference year: 2018

- fuel/electricity/transport/heating demand
- demand/production hourly distribution
- infrastructure (CHP, DH, storages, capacities)

Validation

Control of coherence
(demand-production ; GHG)

- Difficulty accessing to**
- accurate, detailed data
 - coherent information's structure
 - aggregated for the department
 - hourly-distributions

Hydraulics capacity factor - Haut-Rhin

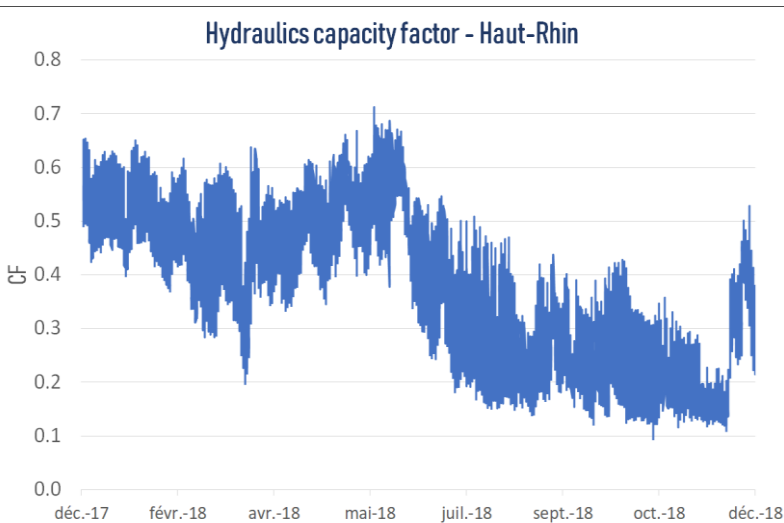

Hourly solar capacity factor Haut-Rhin

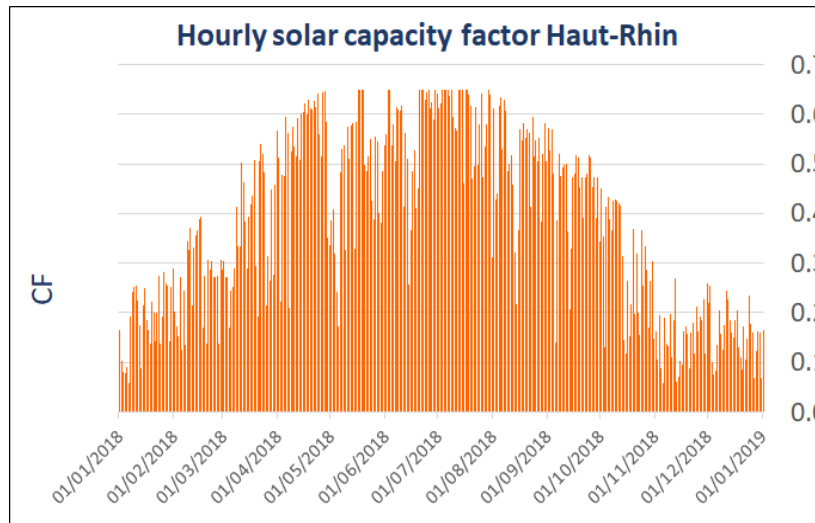

DJU₁₈ - Haut-Rhin 2018

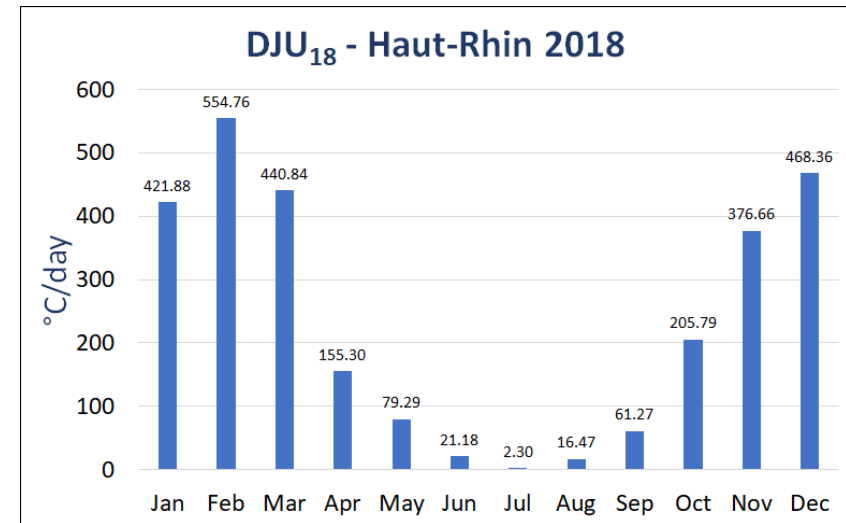

Reference scenario and validation

Haut-Rhin
department

reference scenario - validation EnergyPLAN			
Fuel consumption (GWh/year)	ATMO GE	EnergyPLAN	Relative difference
Oil	8069	8070	0.0%
Natural gas	7167	7542	5.2%
Total	15236	15612	2.5%
CO2 emissions (ktCO2)	ATMO GE	EnergyPLAN	Relative difference
Oil	2114	2150	1.7%
Natural gas	1913	1993	4.2%
Total	4027	4143	2.9%
Electricity import/export (GWh/year)	ATMO GE	EnergyPLAN	Relative difference
	9 235	9526	3.1%
Renewable electricity production (GWh/year)	ATMO GE	EnergyPLAN	Relative difference
River Hydro	3080	3068	0.4%
PhotoVoltaic	63	62.7	0.5%

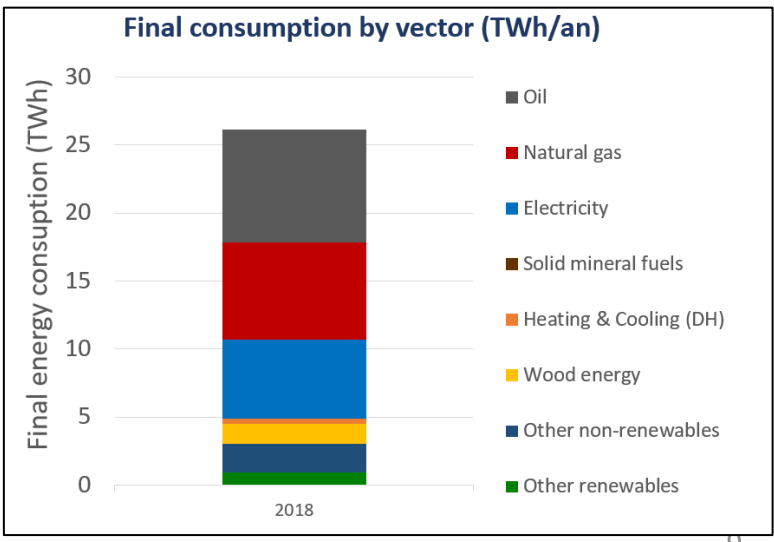
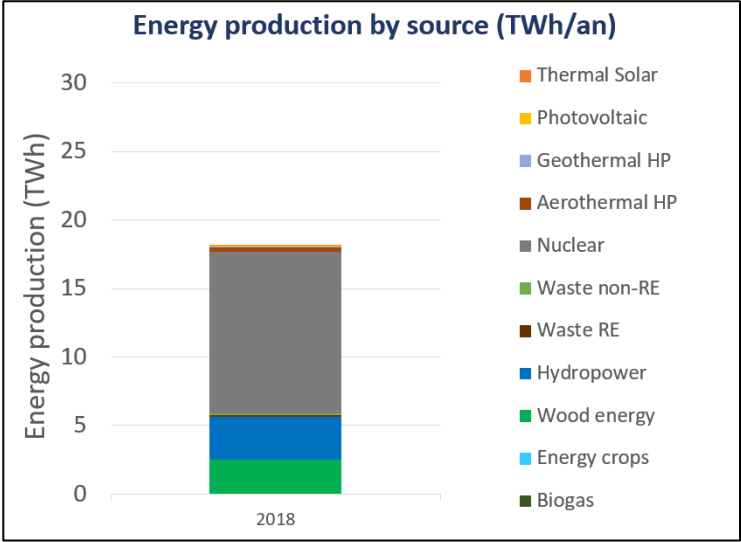
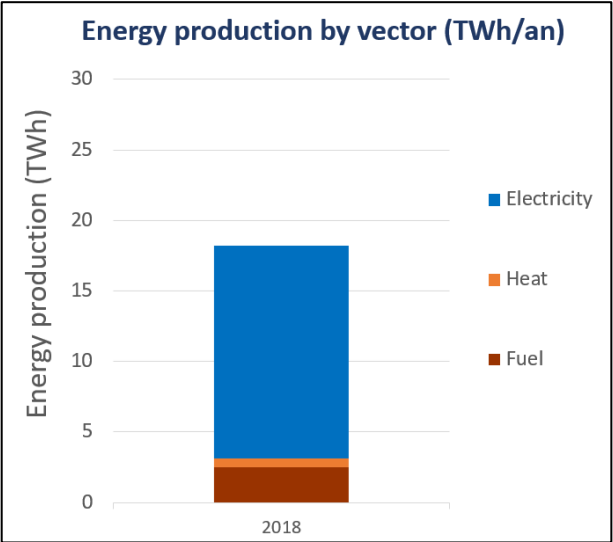

Source : Invent'air 2022 ATMO Grand Est

Reference scenario and validation

Hourly simulations

- district heating
 - demand/production/storage
- electricity
 - demand/production/balance
- gas
 - demand/balance

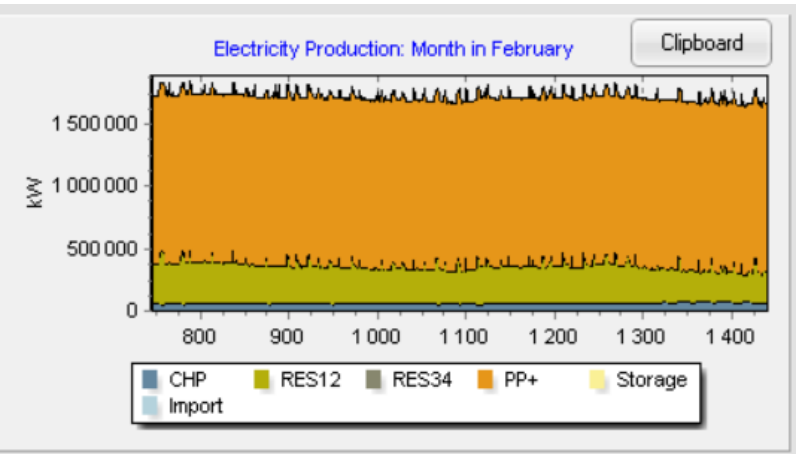
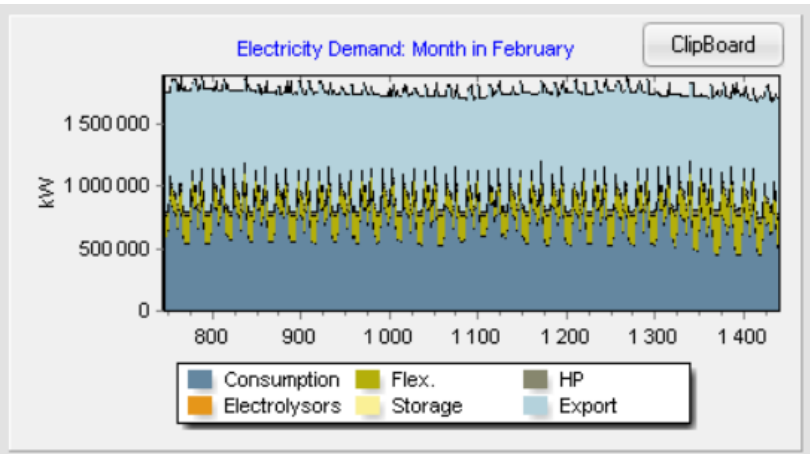
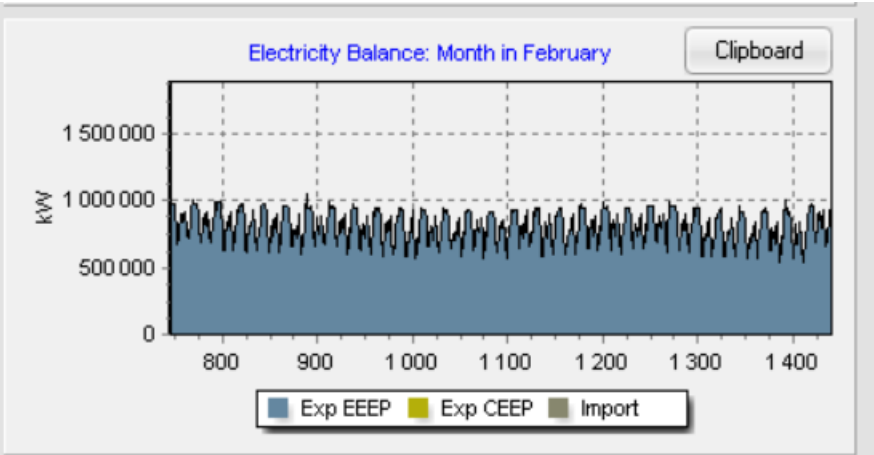
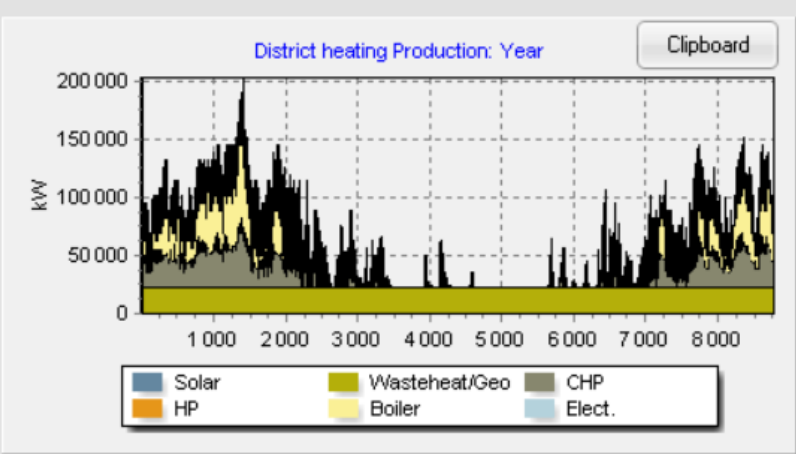
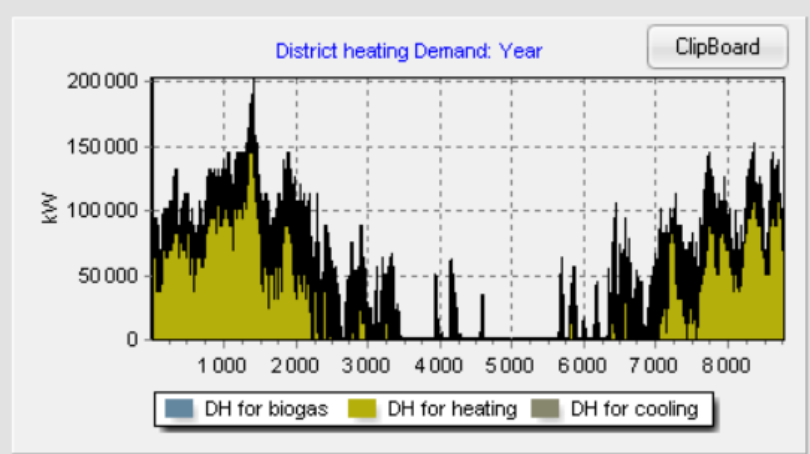

Energy transition scenarios 2030

SRADDET

Regional plans for spatial planning, sustainable development, territorial equality

- energy and climate goals
- more ambitious or equal to national strategies
- regional strategy
- general but not prescriptive guidelines
- do not detail pathways



Challenges

- local territory adaptation (Haut-Rhin)
- energy structure changes (production, regulation, storages, etc.)
- cross sectorial integration
- transport decarbonation
- Regulation
- RE production choice

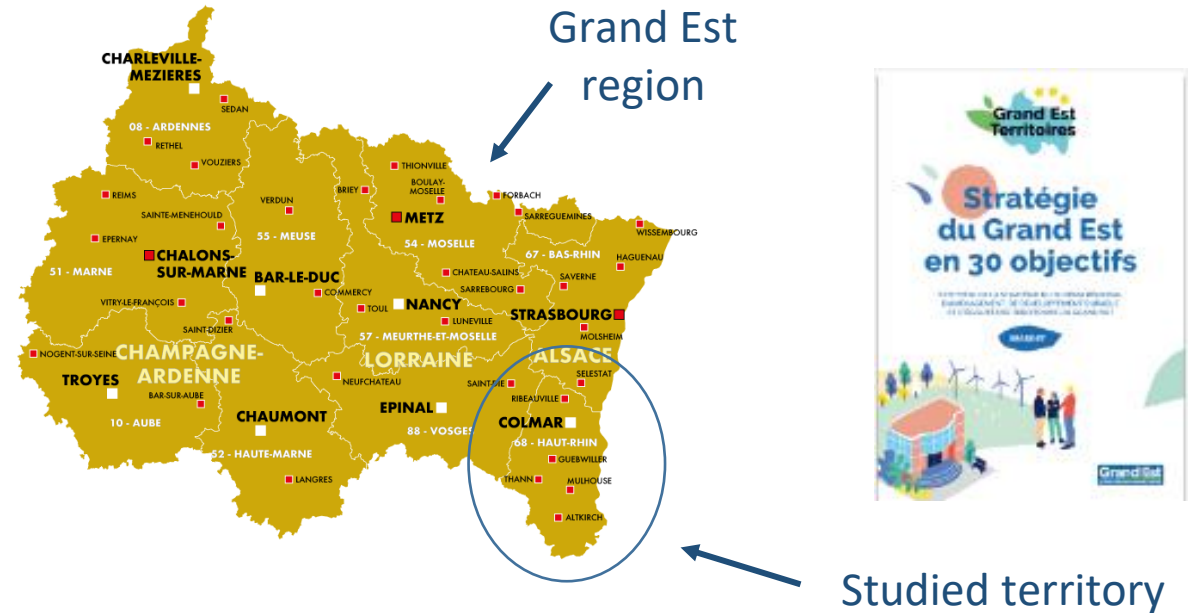

Assumptions for reference scenario 2030

- following the main guidelines of the SRADDET
- no structural change
- sectorial consumption reduction considered
- final consumptions unchanged base scenario SRADDET/EnergyPLAN

Energy transition scenarios 2030

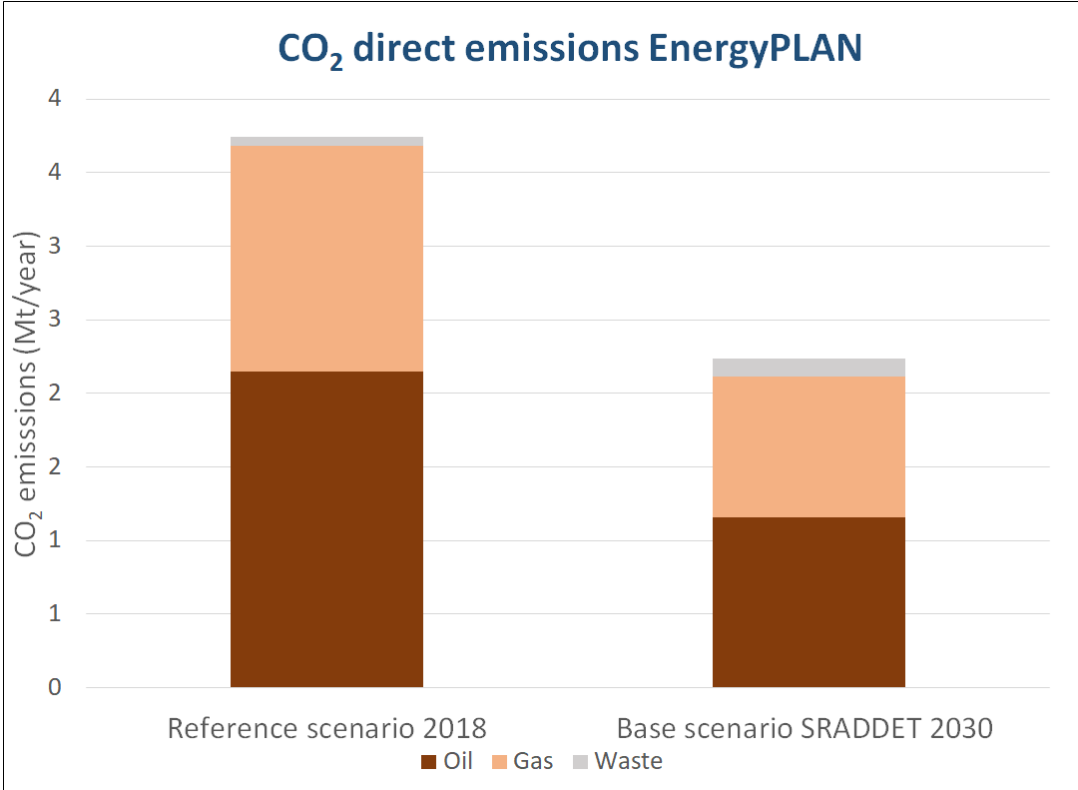
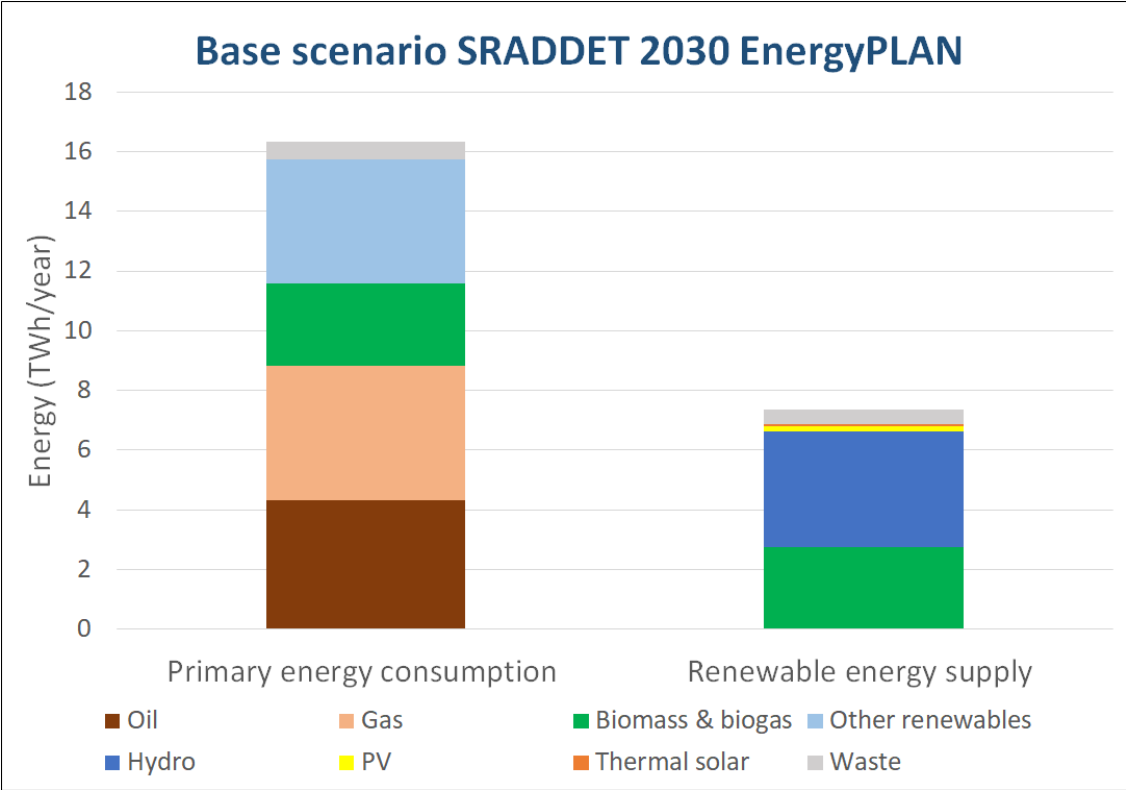

Haut-Rhin
department

base scenario SRADDET 2030 EnergyPLAN			
	Balancing Heat = reference	Balancing Heat & Electricity	Difference
Electricity import (GWh/an)	1691	1691	0.00%
Electricity export (GWh/an)	528	499	-5.49%
Gas and biomass consumption (GWh/an)	8115	8082	-0.41%
CO ₂ emissions (kt/an)	2236	2235	-0.04%

Towards Renewable Smart Energy Systems by 2050

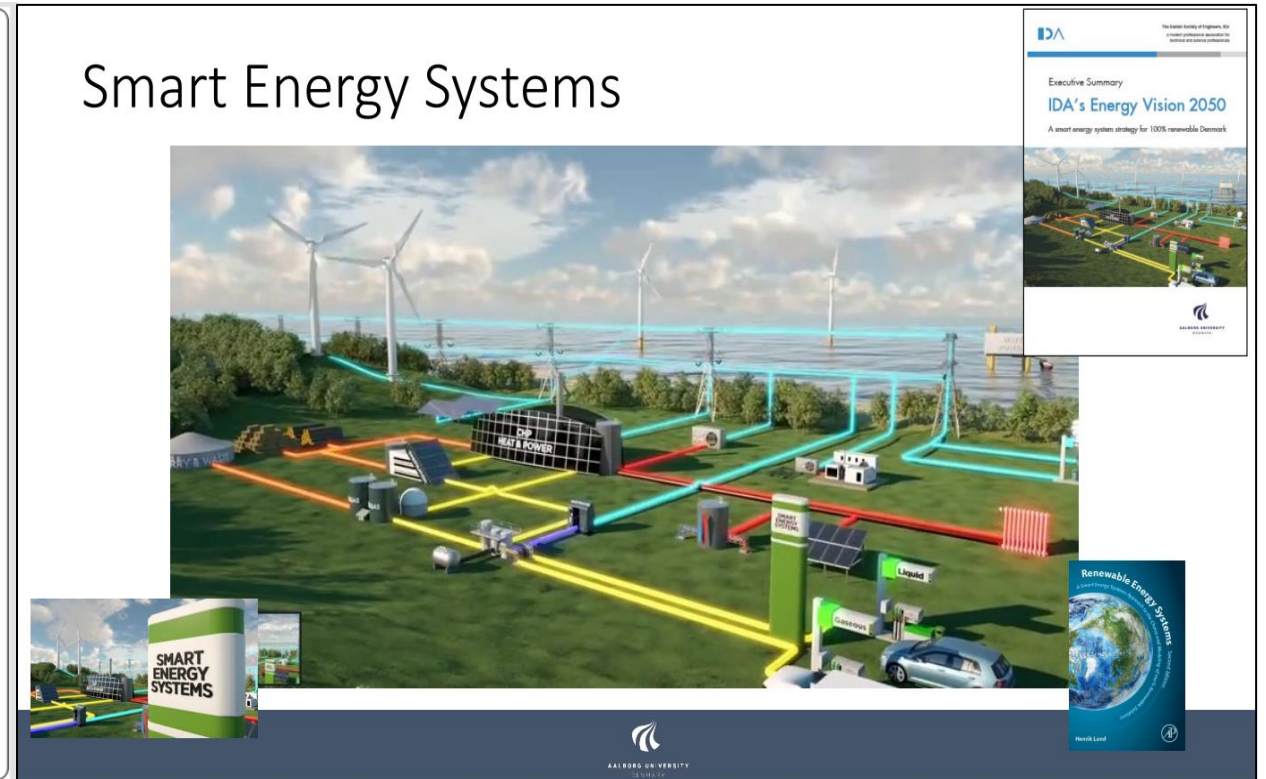
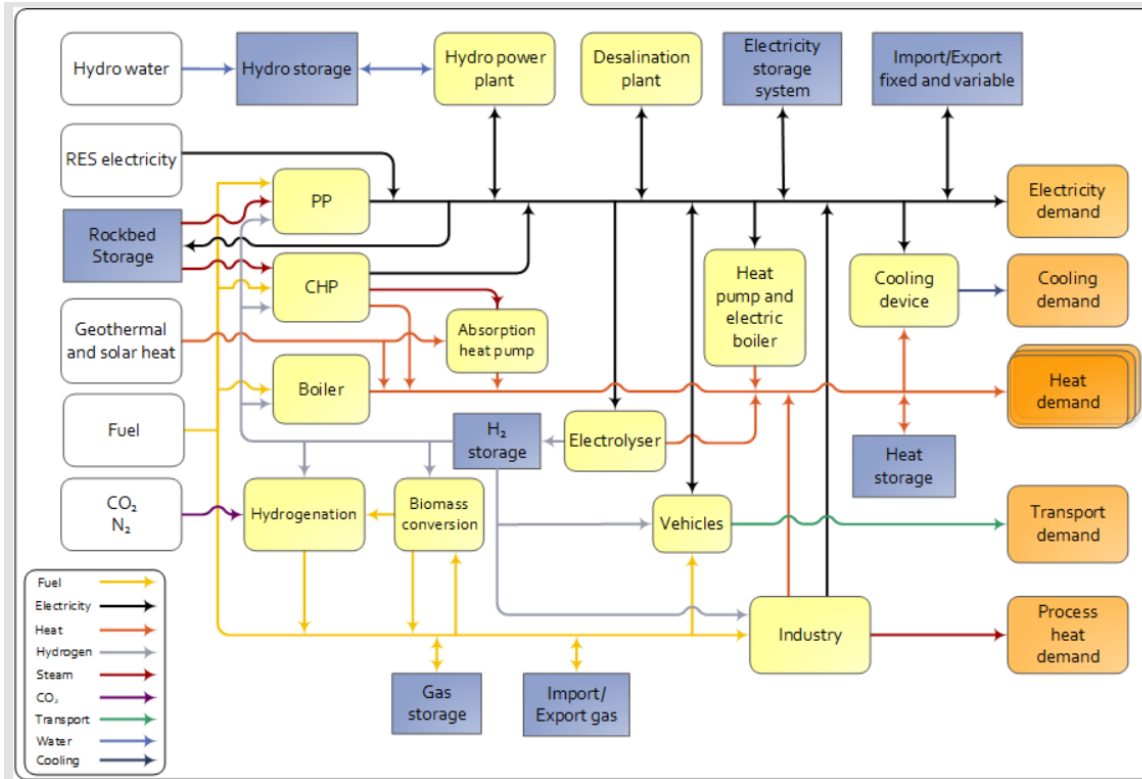

Smart Energy Systems concept

sector couplings (electricity, heating, cooling, gas, transport)
 +
 multi-energy, multi-scale storage coupling + DHC-CHP
 +
 intelligence (flexibility, metering, regulation, optimization)

Smart Energy Systems objectives

- maximize energy efficiency
- maximize RE penetration (up to 100%)
- minimize electricity excess and costs
- resilient system (hourly balanced electricity, heating, cooling, gas)

Towards Renewable Smart Energy Systems by 2050

Detailed energy-GHG strategy

- effective carbon neutrality (elimination of GHG emissions)
- energy sufficiency + efficiency objectives -55% / 2012
- > 100% RE supply with local productions + RE exchanges with surroundings + interconnections
- overall Smart Energy System implementation (CHP, DHC, couplings, storages)
- maximizing thermal renewable productions (solar thermal, geothermies)
- minimizing biomass production (sustainable use)
- optimizing seasonal solar thermal storage for District Heating & Cooling
- maximizing ecological transport (pedestrian, cyclist, tram, train)
- electrifying public and individual transports (trams, trains, busses, vehicles, trucks, ferries, barges)
- maximizing V2G storage, battery storage → minimizing transmission lines, backup units → maximizing grid stability
- hourly heating, cooling, electricity, gas balance

work in progress

Evolutionary energy-GHG data-base

- new renewable supply capacities
- new thermal, electricity, methane, hydrogen storage capacities (daily, weekly, seasonal scales)
- new distribution-conversion units (DHC, CHP, HP, electrolysers)

work in progress

Scenario 2050 simulations

→ costs comparison of numerous RSES structures → investment & decision planning tool

work in progress

Thank you for attention



Florian Labaude¹, Nadège Blond¹, Thierry de Laroche Lambert²

¹Laboratoire Image Ville Environnement, Strasbourg, France.

²Laboratoire FEMTO-ST, Besançon, France.

florian.labaude@etu.unistra.fr

nadege.blond@live-cnrs.unistra.fr

thierry.laroche Lambert@femto-st.fr

"Energy transition" Session