



**HAL**  
open science

## Development of a friction modulation haptic interface based on thin-film AlN actuators

Théotime Goubault, F. Casset, R. Le Magueresse, K. Benedetto, S. Brulais,  
D. Mermin, M. Colin

### ► To cite this version:

Théotime Goubault, F. Casset, R. Le Magueresse, K. Benedetto, S. Brulais, et al.. Development of a friction modulation haptic interface based on thin-film AlN actuators. EuroSimE 2024 - 25th International Conference on Thermal, Mechanical and Multi-Physics Simulation and Experiments in Microelectronics and Microsystems, Apr 2024, Catane, Italy. 10.1109/EuroSimE60745.2024.10491542 . hal-04608420

**HAL Id: hal-04608420**

**<https://hal.science/hal-04608420>**

Submitted on 13 Jun 2024

**HAL** is a multi-disciplinary open access archive for the deposit and dissemination of scientific research documents, whether they are published or not. The documents may come from teaching and research institutions in France or abroad, or from public or private research centers.

L'archive ouverte pluridisciplinaire **HAL**, est destinée au dépôt et à la diffusion de documents scientifiques de niveau recherche, publiés ou non, émanant des établissements d'enseignement et de recherche français ou étrangers, des laboratoires publics ou privés.

# Development of a friction modulation haptic interface based on thin-film AlN actuators

T. Goubault, F. Casset, R. Le Magueresse, K. Benedetto, S. Brulais, D. Mermin, M. Colin  
CEA-Leti, Univ. Grenoble Alpes, F-38000 Grenoble, France  
theotime.goubault@cea.fr +33 4 38 78 20 95

## Abstract

This article presents the design, modelling and characterisation of a transparent haptic interface based on friction variation. Using a glass plate with thin-film aluminium nitride (AlN) actuators, a compact, self-contained haptic system has been designed. An evaluation of the system has shown that it is possible to achieve a focused Lamb mode at  $67.2\text{ kHz}$ . A displacement amplitude of  $300\text{ nm}$  peak-to-peak was measured at  $48\text{ V}_{pp}$  using a laser Doppler vibrometer. A sensation was felt by the finger at this low actuation voltage. The whole system is currently being integrated with its control electronics into a fully autonomous friction modulation haptic demonstrator.

## 1. Introduction

Today, many applications operate using tactile interfaces. In particular, smartphones and touch-sensitive tablets can be enhanced with haptic rendering that further immerse the user. Haptic effects are already in use, but with limited feedback such as that from a simple vibrator. Various types of haptic solutions are emerging [1]–[3], and the friction variation principle, through the squeeze-film effect seems to be one of the most promising one [4]–[6]. It consists in modifying the friction between the finger and a rigid surface. It allows to reduce the coefficient of friction of a surface traversed by an ultrasonic bending wave. By modulating this effect, it is then possible to create a wide range of textural sensations. The result is a finer, more variable haptic sensation. To actuate our haptic system, we chose to integrate thin-films aluminium nitride (AlN) actuators rather than bulk piezoceramics, which require individual integration. The aim is to create an easy-to-use haptic demonstrator that highlights the integration possibilities of thin-film AlN actuators, which require low-actuation voltage. Based on the principle of piezoelectric conversion, an electrical alternative signal can be linearly transformed into an acoustic vibration. The aim is then to maximize displacement amplitude for a minimum input energy by exploiting a resonance phenomenon. We present in this paper a transparent glass plate applying this principle, driven by thin-film piezoelectric actuators at the ultrasonic resonant frequency of an anti-symmetric Lamb mode.

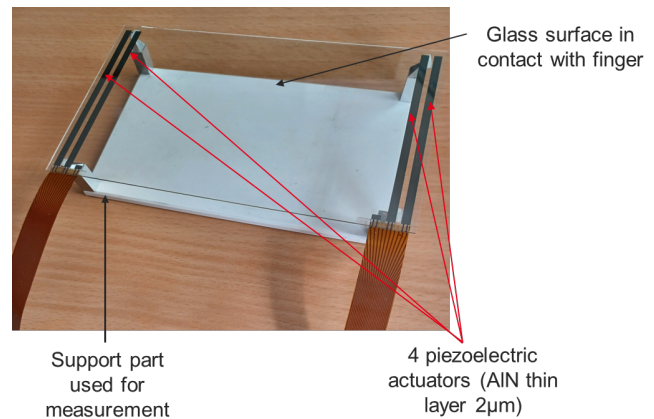

Figure 1: Photograph of the system. The glass plate and actuators are shown, a support part external to the haptic system is visible.

## 2. Design and technological realisation

The system is a thin-film AlN actuated haptic plate designed to generate a Lamb eigenmode at an ultrasonic frequency. The device consists of a free  $140.91\text{ mm} \times 87.73\text{ mm}$  and  $500\text{ }\mu\text{m}$  thick glass plate (Corning eagle XG) and four  $2.9\text{ mm} \times 81.63\text{ mm}$  and  $2\text{ }\mu\text{m}$  thick AlN transducers (Fig. 1). AlN-based devices had already been manufactured out of  $200\text{ mm}$  glass substrates in a clean room. The electrodes generating the electric field in each actuator are made of molybdenum and are located both below and above the AlN layer. The AlN ( $2\text{ }\mu\text{m}$  thick) is deposited using reactive sputtering from an aluminium target under a nitrogen atmosphere. Finally, the glass substrate is sawed to obtain the individual plate. Flexible electrical connectors were used in order to electrically connect the metal pads of the haptic plate with the electronic board. By generating an AC voltage at the frequency corresponding to an ultrasonic Lamb mode, a decrease in the coefficient of friction proportional to the voltage amplitude should be observed. Our aim is to modulate this effect at a frequency that is sensitive to the finger to create a variety of interesting textural effects.

## 3. Modelling

The FEM modelling was carried out using COMSOL Multiphysics®, this finite element model software takes into account the equations of piezoelectricity and thus allows to model our system. The modelling stage aims to identify the resonant frequencies corresponding to Lamb

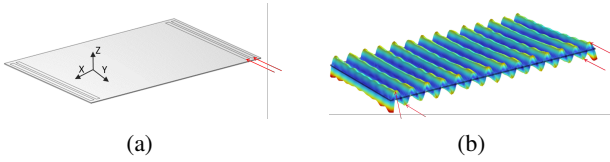

Figure 2: a) FEM model under COMSOL Multiphysics®; b) Lamb's 28-node mode. Position of the actuators is indicated by red arrows.

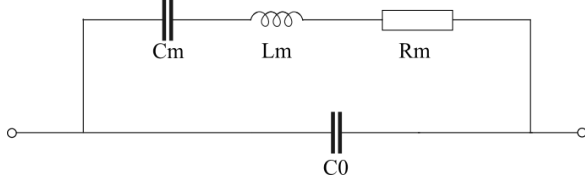

Figure 3: Butterworth Van Dyke (BVD) model representing the electromechanical behavior of a piezoelectric resonator in the form of an electrical circuit.

modes for which the actuators are located in maximal displacement amplitude areas (Fig.2a). Lamb modes can be compared to stationary bending modes, and if an actuator is positioned on a "nodal line" of a Lamb mode, it will not contribute to the actuation of said mode. An eigenvalue study was conducted with the plate being free as a boundary condition. The molybdenum electrodes have been neglected in this modelling stage because of their very small thickness and low influence on the electromechanical behavior of the system. One of the guidelines given by the state of the art is to generate a bending mode whose half-wavelength is approximately the length of the fingertip with a peak-to-peak displacement of at least  $1 \mu\text{m}$  and a resonance frequency of at least  $25 \text{ kHz}$  [2]. Considering these criteria, we selected the 28-node Lamb mode at the frequency of  $60.3 \text{ kHz}$  (Fig. 2b). One can note that in this mode, the actuators must be actuated two by two in phase opposition.

#### 4. Characterisation

To validate the simulation results and size the electronic system, several series of measurements are carried out on the system. A support part was designed and produced to do so (support part is noticeable in Fig. 1). This part was designed to ensure that the points of contact with the plate were located on vibration nodes so that they did not disrupt the vibrations and left the plate as free as possible.

##### A. Impedance measurement

First, we want to confirm the value of the resonance frequency provided by the simulation. This was achieved by measuring the electrical impedance of an actuator as a function of frequency. To do this we use an *HP 4194A* impedance meter. The piezoelectric properties of the actuators are used in this electrical impedance measurement to determine the mechanical behavior of the entire system. A linear relationship exists between the mechanical deformation applied to a transducer and the

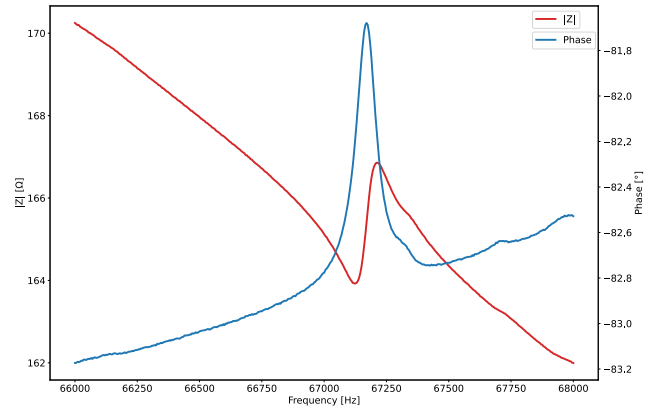

Figure 4: Impedance measurement (Modulus and phase) around the resonance

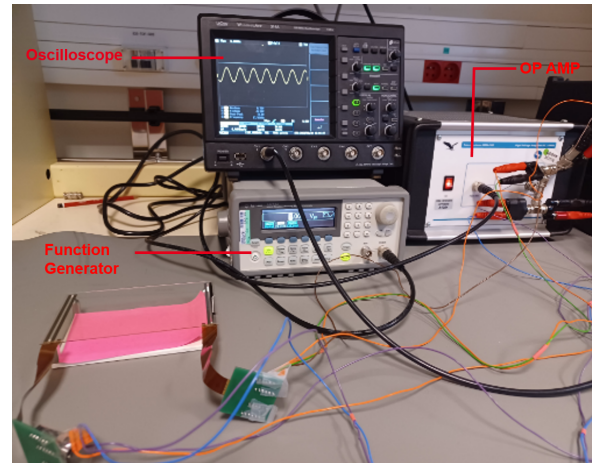

Figure 5: Photography of the glass plate actuated with a function generator and a voltage amplifier.

electrical signal measured across it. This enables mechanical phenomena, such as stiffness, damping, or mass, to be represented in an equivalent lumped-element model, the *Butterworth Van-Dyke* (BVD) model (Fig.3) [7]. In this circuit, the capacitance  $C_0$  represents capacitive effects between electrodes and the RLC circuit is the "motion branch" that represents the mechanical behavior as a resonant circuit. This representation is valid close to the resonance, which is our case here [8]. Fig.4 confirms the presence of a resonance at frequency  $f_0 = 67.2 \text{ kHz}$ . The discrepancy with the model can be attributed to the imprecision resulting from the selection of boundary conditions during the calculation of the finite element model.

##### B. Actuation

Following these initial measurements, an actuation test is carried out. We use a function generator (*Agilent 33250A*), an OP AMP (*Falco WMA-300*) and an oscilloscope (*LeCroy WaveJet 314-A*). The installation is shown in Fig.5. Fig.6 shows the vibrating haptic plate covered with sugar while excited at its resonant frequency  $f_0$ .



Figure 6: Haptic system covered with sugar and activated at the frequency corresponding to the focused Lamb's mode. The sugar concentrates at the vibratory nodes, creating a Chladni pattern.

When the glass plate is actuated the sugar grains move towards the nodal points and reveal the Chladni figure of the Lamb mode identified in the modelling stage with 28 nodes.

### C. Capacitance measurement

In order to design the control and power electronics, we need to evaluate the power consumed by the system. The literature shows that for resonant piezoelectric systems, power consumption  $P$  is a function of actuation frequency  $f$ , actuator capacitance  $C$  and supply voltage  $U$  [9].

$$P = CU_{rms}^2 f \quad (1)$$

The theoretical capacitance of an actuator with surface area  $S$  and thickness  $e$  being :

$$C = \epsilon_r \epsilon_0 \frac{S}{e} \quad (2)$$

Since AlN has a relative permittivity  $\epsilon_r \approx 10$  we find a capacitance  $C \approx 10.4 \text{ nF}$  for each of our actuators. At a frequency of  $67.2 \text{ kHz}$  and an actuation voltage of  $48 \text{ V}_{pp}$ , the theoretical power consumption is therefore  $P \approx 0.20 \text{ W}$ . The power consumed by four actuators connected in parallel is then  $P \approx 0.80 \text{ W}$ .

By measuring the capacitance of actuators using a RLC-meter (*Agilent 4284A*) we get a mean capacitance of  $C = 11.59 \text{ nF}$  and a power consumption  $P = 0.90 \text{ W}$  under the same conditions. This result is crucial for us, as it confirms that the system can be powered by a serial USB port ( $2.5 \text{ W}$ ).

### D. Laser Doppler vibrometer measurement

One of the guidelines given in the literature for creating a haptic interface with effective friction variation is to obtain a vibration amplitude of  $1 \mu\text{m}$  peak to peak [2]. A laser Doppler vibrometer (*Polytec MSA-400*) was used to measure the vibration amplitude of our system. The

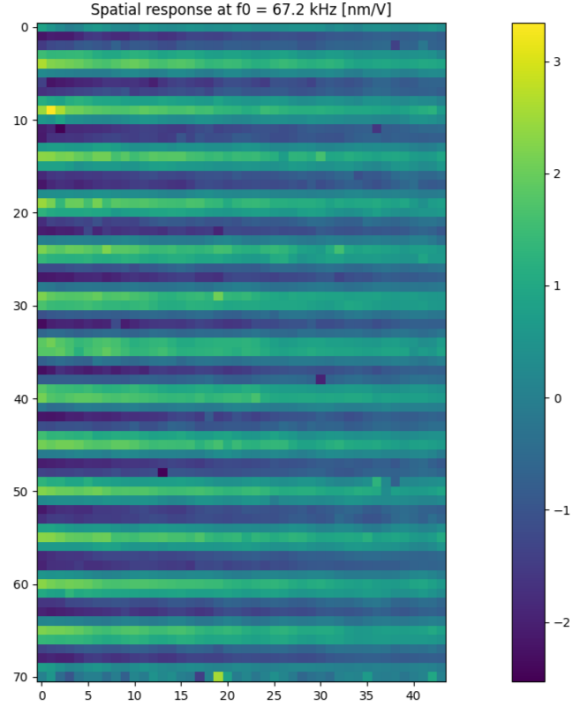

Figure 7: Mapping of the response of the system at resonant frequency  $f_0$

vibrometer emits a laser which encounters the vibrating plate at a point and is reflected before returning to its source. The frequency of the reflected signal changes in proportion to the speed of the vibrating plate, in accordance with the Doppler effect. Once calibrated, the vibrometer is able to calculate the vertical displacement amplitude at a point from the measured frequency variation. Measuring the displacement amplitude at each point once the harmonic regime has been established at resonance frequency  $f_0$  confirms the presence of Lamb's 28-nodes mode (7). At maximum vibration amplitude the measurement of vibration amplitude as a function of actuation voltage at frequency  $f_0$  follows a linear model when increasing actuation voltage, but the displacement amplitude does not exceed  $300 \text{ nm}$  peak-to-peak for  $48 \text{ V}_{pp}$  (Fig.8). This value is lower than  $1 \mu\text{m}$  that is the value usually required to feel an haptic sensation, even though we have been able to feel a satisfactory haptic feedback at voltages below  $48 \text{ V}_{pp}$ . This result can be counterbalanced by a closer look at the effect causing the friction reduction, it has been established that frequency plays a predominant role [10], [11] and it can be argued that the higher actuation frequency is what enables the system to create a haptic sensation despite its small displacement amplitude.

### E. Haptic rendering

To produce a perceptible sensation, the signal must be modulated at a frequency perceptible to the skin's mechanoreceptors. Amplitude modulation with a sine sig-

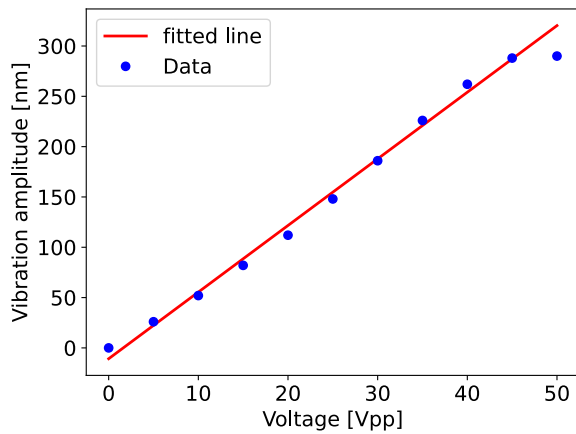

Figure 8: Voltage/Displacement characteristic at resonant frequency in a maximum amplitude point

nal at the frequency  $f_{mod} = 250 \text{ Hz}$  allowed us to feel an haptic sensation at the fingertip for voltages above  $36 \text{ V}_{pp}$ . It confirms that our interface can produce an haptic sensation using a low actuation voltage even if a full psychophysical campaign is still required to assess the entire potential of the system.

## 5. Electronics

Up to now, the system has been powered by a low frequency generator and an operational amplifier to achieve the required actuation frequencies and voltages. This setup is heavy and takes up a lot of space (as can be seen in Fig. 5) and in order to create a more integrated demonstrator, the aim is to have a compact, robust and easily transportable system. The electronic circuit must meet several objectives: Being able to supply an AC voltage of  $48 \text{ V}_{pp}$  at  $67.2 \text{ kHz}$  from an easily accessible source such as a PC USB serial port, and to be able to modulate this voltage at low frequency, while being fully integrable on an electronic board. In addition, to study the haptic effect, a secondary objective is to be able to change the modulation frequency and shape without shutting the system down. The chosen circuit was inspired by the one presented by Hudin et al. [3], and is shown in Fig.9. This circuit consists of a boost component (*CUI PESE1-S5-D24-M*) that turns the  $5 \text{ V}_{dc}$  voltage from the USB port into a  $24 \text{ V}_{dc}$  voltage. This signal will then be converted to a pseudo-sinusoidal PWM signal between  $-24 \text{ V}$  and  $+24 \text{ V}$  by an H-bridge (*Renesas Electronics L298N*). To create and modulate the pseudo-sinusoidal signal a microcontroller is used (*STM32 F100RBT6B*), which will also allow to vary the modulation frequency and shape during operation. Fig. 10 displays a photograph of the electronic board. An interface enables variation of the modulation frequency and shape of the modulating signal during operation.

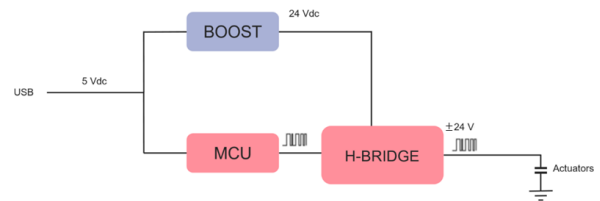

Figure 9: Schematic representation of the operating principle of the demonstrator's control electronics

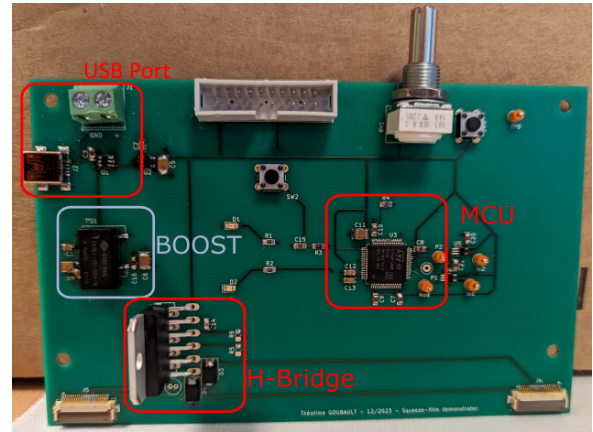

Figure 10: Photo of the electronic board used to control the system

## 6. Conclusion

This article presents a tactile transparent glass plate for haptic applications. The design has been validated through finite element modelling and characterisation. The Lamb mode was confirmed at  $67.2 \text{ kHz}$ , with an amplitude of approximately  $300 \text{ nm}$  measured for this frequency. The system can be powered and controlled entirely through a serial USB port. Although a haptic effect has been confirmed for low voltages, a tribological study and a psychophysical campaign are currently ongoing to confirm the relevance of the system from the user's point of view. The results of the characterisation stage will be used to adjust the finite element model to increase its robustness and make it a reliable predictive model for future designs. The electronic control has been specified and produced. The entire system is currently being integrated to form a low-voltage, compact, and robust haptic demonstrator based on friction variation.

## 7. Acknowledgements

The authors would like to thank Charles Hudin and the LISA laboratory team for their advice and help.

## References

- [1] Olivier Bau, Ivan Poupyrev, Ali Israr, and Chris Harrison. Tactatouch: Electro-vibration for Touch Surfaces. pages 283–292, October 2010.
- [2] F. Giraud, M. Amberg, B. Lemaire-Semail, and G. Casiez. Design of a transparent tactile stimulator. pages 485–489, 2012.

- [3] Charles Hudin, José Lozada, and Vincent Hayward. Localized Tactile Feedback on a Transparent Surface through Time-Reversal Wave Focusing. *IEEE Transactions on Haptics*, 8(2):188–198, April 2015. Conference Name: IEEE Transactions on Haptics.
- [4] T. Watanabe and S. Fukui. A method for controlling tactile sensation of surface roughness using ultrasonic vibration. In *Proceedings of 1995 IEEE International Conference on Robotics and Automation*, volume 1, pages 1134–1139 vol.1, May 1995. ISSN: 1050-4729.
- [5] F. Casset, JS. Danel, P. Renaux, C. Chappaz, F. Bernard, T. Sednaoui, S. Basrou, B. Desloges, and S. Fanget. 4-inch transparent plates based on thin-film AlN actuators for haptic applications. *Mechatronics*, 40:264–269, December 2016.
- [6] T. Sednaoui, E. Vezzoli, B. Dzidek, B. Lemaire-Semail, C. Chappaz, and M. Adams. Friction Reduction through Ultrasonic Vibration Part 2: Experimental Evaluation of Intermittent Contact and Squeeze Film Levitation. *IEEE Transactions on Haptics*, 10(2):208–216, 2017.
- [7] Karl S Van Dyke. The piezo-electric resonator and its equivalent network. *Proceedings of the Institute of Radio Engineers*, 16(6):742–764, 1928.
- [8] Vittorio Ferrari, Daniele Marioli, and Andrea Taroni. Theory, modeling and characterization of PZT-on-alumina resonant piezoelectric layers as acoustic-wave mass sensors. *Sensors and Actuators A: Physical*, 92(1-3):182–190, August 2001.
- [9] S. Glinsek, M.A. Mahjoub, M. Rupin, T. Schenk, N. Godard, S. Girod, J.-B. Chemin, R. Leturcq, N. Valle, S. Klein, C. Chappaz, and E. Defay. Fully Transparent Friction-Modulation Haptic Device Based on Piezoelectric Thin Film. *Advanced Functional Materials*, 30(36), 2020.
- [10] Eric Vezzoli, Zlatko Vidrih, Vincenzo Giamundo, Betty Lemaire-Semail, Frederic Giraud, Tomaz Rodic, Djordje Peric, and Michael Adams. Friction Reduction through Ultrasonic Vibration Part 1: Modelling Intermittent Contact. *IEEE Transactions on Haptics*, 10(2):196–207, April 2017. Conference Name: IEEE Transactions on Haptics.
- [11] Frédéric Giraud, Tomohiro Hara, Christophe Giraud-Audine, Michel Amberg, Betty Lemaire-Semail, and Masaya Takasaki. Evaluation of a friction reduction based haptic surface at high frequency. In *2018 IEEE Haptics Symposium (HAPTICS)*, pages 210–215, March 2018. ISSN: 2324-7355.