



HAL
open science

Air Conditioning Systems Fault Detection and Diagnosis-Based Sensing and Data-Driven Approaches

Abdellatif Elmouatamid, Brian Fricke, Jian Sun, Philip W T Pong

► **To cite this version:**

Abdellatif Elmouatamid, Brian Fricke, Jian Sun, Philip W T Pong. Air Conditioning Systems Fault Detection and Diagnosis-Based Sensing and Data-Driven Approaches. *Energies*, 2023, 16 (12), pp.4721. 10.3390/en16124721 . hal-04607724

HAL Id: hal-04607724

<https://hal.science/hal-04607724>

Submitted on 11 Jun 2024

HAL is a multi-disciplinary open access archive for the deposit and dissemination of scientific research documents, whether they are published or not. The documents may come from teaching and research institutions in France or abroad, or from public or private research centers.

L'archive ouverte pluridisciplinaire **HAL**, est destinée au dépôt et à la diffusion de documents scientifiques de niveau recherche, publiés ou non, émanant des établissements d'enseignement et de recherche français ou étrangers, des laboratoires publics ou privés.



Open licence - etalab

Air Conditioning Systems Fault Detection and Diagnosis-Based Sensing and Data-Driven Approaches

Abdellatif Elmouatamid ¹, Brian Fricke ², Jian Sun ³ and Philip W. T. Pong ^{1,*}

¹ Department of Electrical and Computer Engineering, New Jersey Institute of Technology, Newark, NJ 07102, USA; abdellatif.elmouatamid@njit.edu

² Building Equipment Research, Oak Ridge National Laboratory, Oak Ridge, TN 37831, USA; frickeba@ornl.gov

³ Multifunctional Equipment Integration, Oak Ridge National Laboratory, Oak Ridge, TN 37831, USA; sunj2@ornl.gov

* Correspondence: philip.pong@njit.edu

Abstract: The air conditioning (AC) system is the primary building end-use contributor to the peak demand for energy. The energy consumed by this system has grown as fast as it has in the last few decades, not only in the residential section but also in the industry and transport sectors. Therefore, to combat energy crises, urgent actions on energy efficiency should be taken to support energy security. Consequently, the faults in AC system components increase energy consumption due to the degradation of the system's performance and the losses in the energy conversion procedure. In this work, AC system fault detection and diagnosis (FDD) methods are investigated to propose analytic tools to identify faults and provide solutions to those problems. The analysis of existing work shows that data-driven approaches are more accurate for both soft and hard fault detection and diagnosis in AC systems. Therefore, the proposed methods are not accurate for simultaneous fault detection, while in some works, authors tested the method with several faults separately without investigating scenarios that combine more than one fault. Moreover, this study shows that integrating data-driven approaches requires deploying an optimal sensing and measurement architecture that can detect a maximum number of faults with minimally deployed sensors. The new sensing, information, and communication technologies are discussed for their integration in AC system monitoring in order to optimize system operation and detect faults.

Keywords: air conditioning; data-driven approaches; energy efficiency; fault detection and diagnosis; power optimization; process history-based; sensor technologies; simultaneous faults



Citation: Elmouatamid, A.; Fricke, B.; Sun, J.; Pong, P.W.T. Air Conditioning Systems Fault Detection and Diagnosis-Based Sensing and Data-Driven Approaches. *Energies* **2023**, *16*, 4721. <https://doi.org/10.3390/en16124721>

Academic Editor: Jose Luis Calvo-Rolle

Received: 15 May 2023

Revised: 9 June 2023

Accepted: 12 June 2023

Published: 15 June 2023



Copyright: © 2023 by the authors. Licensee MDPI, Basel, Switzerland. This article is an open access article distributed under the terms and conditions of the Creative Commons Attribution (CC BY) license (<https://creativecommons.org/licenses/by/4.0/>).

1. Introduction and Literature Review

Electrical energy is considered the “fuel” of the future, with global electricity demand growing by 4.4% in 2021 to more than 230 TWh [1]. Faced with this increase in global electricity demand, more urgent actions are needed to develop all clean energy solutions and improve efficiency, especially in the building sector, which represents 30% of the total energy consumption [2]. AC systems in industrial, residential, and commercial buildings consume 50% of the final buildings' energy demand [3], and they are a main contributor to greenhouse gas emissions. Depending on the geography and the seasons of the year, the AC system is used to maintain the comfort of the occupants in the buildings, and its consumption can reach its maximum during extreme weather conditions (e.g., a heat wave or a cold wave). Therefore, it is a main factor in energy savings while maintaining comfort for the occupants within acceptable ranges. In this way, many studies are presented, putting more emphasis on the control and retrofit of the system components [4–6]. However, faults in the system components trigger a huge waste of energy, and it is an interesting issue that is addressed to minimize the consumption of such a system. The objective is to profit from the maximum performance of the system with high efficiency in order to do the best with less energy. The severity of the fault depends on the component source of this

fault and the ability to identify the problem with the existing deployed sensors [7]. These faults are classified into two families: soft and hard faults [8]. Hard faults in the AC system cause total damage to the system's operation and can be detected by the occupants due to uncomfortable occupant conditions [9], while soft faults result in the AC system's performance degradation without affecting occupant comfort [10]. In fact, soft faults are more difficult to detect, and they increase the electricity consumption of the AC system because the system is still working with minimal efficiency for an extended time without the occupant detecting the faults. For example, in the case of a fouled condenser, the system takes more time to regulate the indoor temperature to the selected setpoint temperature, causing more consumption of electric power and consequently decreasing the energy efficiency of the building [11]. This type of fault requires the installation of specified sensors capable of generating alerts to the occupant indicating the degradation of the system's performance.

The motivation for this work is the need to increase the energy efficiency of the building by minimizing energy consumption while maintaining maximal occupant comfort and high building service quality. Several approaches are investigated to improve the energy efficiency of buildings, focusing on the building construction material and insulation [12], the control of active/passive equipment [13], and the integration of renewable energy resources [14]. However, service monitoring and fault detection are the main keys to optimizing energy consumption, especially for the services that consume a large part of the electrical energy in the building. In this way, the detection of heating, ventilation, and air conditioning (HVAC) system faults is an active area of research (Table 1). The benefit is not only to reduce power consumption but also the maintenance cost, refrigerant leakage, and carbon emissions at power plants. One of the main faults that can drop the performance of the AC system is the compressor fault, which increases the workload of the system and is the most expensive repair. The authors in [15] proposed an online method for compressor liquid flood-back. The backpropagation neural network structure is used to establish the fault diagnosis model and correlation coefficient to analyze the relationship between data variables. A set of sensors is installed to form the raw dataset. The number of neurons in the input layer is assumed to depend on the following eight measured parameters: compressor discharge temperature, accumulation inlet temperature, accumulation outlet temperature, compressor/outdoor fan voltages, working current of the compressor, and compressor/outdoor fan operating frequencies, while the output layer is assumed to depend on the three operating states of the compressor: normal, fault 1, and fault 2. Compared with other works about compressor fault detection that used offline methods [16,17], this work deployed an online method with high performance under standard test conditions, with fault diagnosis accuracies of 99.83% for the training and 99.46% for the testing, as mentioned by the authors. The main limitation of the proposed method is the high number of installed sensors; therefore, the concept of virtual sensing is discussed in the literature in order to minimize the number of physical sensors deployed in the AC system. Another interesting work is presented in [18], combining data-driven and virtual sensing techniques to develop an online refrigerant charge fault diagnosis strategy based on a virtual sensor technique. The principal component-based exponentially weighted moving average method is combined with the virtual refrigerant charge method to identify refrigerant charge faults for variable refrigerant flow (VRF). The authors showed that the virtual refrigerant charge method is suitable for undercharge fault detection but is not sensitive to overcharge faults. However, the principal component-based exponentially weighted moving average method obtained outstanding performance in detecting overcharge faults but failed to identify severe undercharge faults. For that, the work investigated a hybrid strategy whose advantages are well exploited. This work was reinforced by another energy diagnosis method based on data mining and a statistical quality control approach for VRF [19].

Table 1. State of the art of the present works on fault detection methods for AC systems.

Ref	Type Faults	Fault Investigated	Fault Detection Method	Simultaneous Faults	Fault Diagnosis	System Studied
[7]	Soft	Drift deviation	Combining kernel principal component analysis and double-layer bidirectional long- and short-term memory	No	No	Heating, ventilation, and air conditioning
[9]	Hard	Broken heating coil valve Dampers and valves control	Three algorithms are compared: an artificial neural network, a genetic algorithm, and multiple linear regression	Yes	No	Air handling units
[10]	Soft	Refrigerant leakages and condenser/evaporator fouling	On-field measurements and related degradation of performance	No	Yes	Residential heat pumps
[11]	Hard	Non-condensable gas and liquid line restrictions	Experimental study of an AC system with a microtube condenser using coefficient of performance analysis	No	No	Air conditioner with a microtube condenser
[16]	Hard	Refrigerant undercharge, four-way reversing valve, and indoor unit fouling faults	Fault detection strategy based on modularized principal component analysis	Yes	Yes	VRF air conditioning system
[17]	Hard	Liquid floodback for scroll compressor	Classification and regression trees are used to develop Decision Tree models	No	Yes	VRF air conditioning system
[18]	Hard	Refrigerant charge fault	Principal component analysis based on the exponentially weighted moving average method	No	Yes	VRF air conditioning system
[19]	Hard	Refrigerant undercharge and overcharge	Energy diagnosis method-based data mining technique and statistical quality control approach	No	Yes	VRF air conditioning system
[20]	Hard	Refrigerant charge fault, four-way valve failure, and compressor liquid floodback	Unsupervised principal component based on hybrid data mining methods and analyzed the thermodynamic interpretation	Yes	Yes	VRF air conditioning system
[21]	Hard	Compressor liquid floodback and refrigerant charge fault	Data-driven methods of analysis: Decision Tree, support vector machines, clustering, shallow neural networks, and deep neural networks.	No	Yes	VRF air conditioning system
[22]	Hard	Cooling tower fan failure, damper stuck, supplied chilled water clogging, and air duct leakage	Coefficient of performance analysis using deep learning, support vector machines, and multi-layer perceptron	No	No	Air conditioning system
[23]	Soft	The proposed method can be deployed to detect several faults	Internet of Things and cyber-physical systems: distributed sensor-fault detection and diagnosis framework	Yes	Yes	HVAC
[24]	Soft	Refrigerant charge faults and condenser fouling	Virtual sensors and fault impact models	Yes	No	HVAC
[25]	Hard	Damper stuck, air flow rate reading frozen, and low supply air static pressure failures	Proactive FDD	No	Yes	Variable-air-volume (VAV) AC systems

Table 1. Cont.

Ref	Type Faults	Fault Investigated	Fault Detection Method	Simultaneous Faults	Fault Diagnosis	System Studied
[26]	Soft	Fan, valve, and temperature sensor faults	Grey-box model approach based on polynomial regression	Yes	Yes	HVAC fan-coil
[27]	Hard	Refrigerant system faults	Combination of principle component analysis feature extraction technology and binary Decision Tree-based multiclass support vector machine classification algorithm	No	Yes	Vapor-compression refrigeration systems
[28]	Soft	Return and mixed air temperature sensor faults	Hybrid modeling approach integrating first-principles knowledge with statistical methods	No	No	HVAC
[29]	Hard	Obstruction of the air filters	Physics-based models with data-driven	No	Yes	HVAC
[30]	Soft	Condenser fouling, refrigerant leak, non-condensable refrigerant, reduced Condenser/evaporator water flow	Combining extended Kalman filter and recursive one-class SVM	Yes	No	HVAC Chiller
[31]	Soft	The proposed method can be deployed to detect faults in the chiller	Symbolic artificial intelligence technique based on digital twin architecture	Yes	Yes	HVAC
[32]	Soft	Stuck valves and temperature sensor offset faults	Evolving learning-based methods and growing Gaussian mixture regression	No	Yes	Chilled beam systems
[33]	Soft	The proposed method can be deployed to detect faults in the chiller	Self-attention mechanism-based temporal convolutional network	Yes	No	HVAC Chiller
[34]	Soft	Refrigerant charge fault, condenser fouling, and evaporator fouling	Supervised and semi-supervised machine learning	No	Yes	Rooftop units
[35]	Soft	Reduced condenser/evaporator water flow, refrigerant faults, excess oil, and condenser fouling	Adaptive 1D-convolutional neural network-based approach	Yes	Yes	Chiller
[36]	Soft	Reduced condenser/evaporator water flow, refrigerant faults, and condenser fouling	Feature-recognition model and spectral regression kernel discriminant analysis	Yes	No	Chiller

The development of data mining and the improvement of computer technologies encourage researchers to focus more on [20,21]. In this work, the different techniques used for AC system fault detection are presented, putting more emphasis on the new techniques based on the new information and communication technologies for data collection and analysis (e.g., Internet of Things, machine learning, big data, virtual sensing). Moreover, in order to identify the sensor types and positions that should be installed, soft faults should be identified and classified depending on their effect on the “coefficient of performance” that is used in the literature to analyze the AC system efficiency depending on the input/output power ratio [37,38]. Therefore, there is a need for new fault testing to understand fault impacts on systems. Additionally, the new concept of “virtual sensor” is investigated in order to propose new measurement methods for the AC system to detect faults using minimal physical sensors. In fact, the concept of “virtual sensing” refers to the concept of

data analysis using software components such as artificial intelligence in order to imitate the behavior of one or multiple physical sensors by leveraging information available from other measurements and estimating the quantity of interest. This concept starts to improve in several research domains due to the development of new information and communication technologies [39–41]. Consequently, the faults in the AC system shall be detected based on other measurements that are realized today for other usage in the buildings, such as the power conception, the inside/outside temperature/humidity, and the total heat load. The coefficient of performance is estimated based on the available measurements (e.g., weather conditions, power consumption), and the analytics tool will identify a fault if the real-time data does not conform to the rules or the optimal relationship [22,23,42].

The remainder of this paper is structured as follows: Section 2 presents the research methodology together with a summary of the new research on FDD methods for AC systems. The classification of major common faults in AC systems is presented in Section 3. This classification helps with the identification of the existing methods used to detect and diagnose the faults while specifying the limits and the required measurements for the techniques' deployment. In Section 4, detection and diagnostic techniques for AC soft faults are summarized based on the global architecture of the system that depends on the building size (e.g., residential, commercial, industrial). The existing works are interpreted depending on the investigated area and the type of sensors and data measurement that are used to develop the technique. The data source and sensor deployment architecture are presented in Section 5. Section 6 discusses the shortcomings of the existing methods and proposes new research perceptions for researchers; therefore, computing-based and data-driven techniques are present as the main keys for the future development of FDD methods. Conclusions and perspectives are presented in Section 7.

2. Research Scope and Methodology

The development of a robust method for fault detection with minimal physical sensor deployment is required for AC systems. The need to improve new FDD methods is highlighted by their main shortcomings. The literature works considered in this work were collected through an extensive search in digital academic libraries, as presented in Figure 1. The method "Reference-by-Reference" is used to organize the relevant publications. The main objective is to classify the existing FDD methods used for HVAC systems, identify the limitations of each method, and investigate the possibility of integrating new technologies to handle these limitations. The classification is based on the statistics presented in the existing literature. The statistics are collected using the fault reports sent to several heat pump manufacturers during the warranty period. Most of these recent research efforts focused on detecting hard faults in the air handling units for large-scale HVAC systems, as depicted in Table 1. It is shown that few studies focused on soft faults occurring in the mechanical system, dampers, valves, sensors, programming, controller errors, and in general human intervention. Therefore, a main part of the existing work for soft fault detection focuses on specific safety faults without the ability to detect simultaneous faults in the HVAC system. On the other hand, the investigated FDD strategies are deployed only in the laboratory testbeds without having a real strategy used in the existing operational HVAC systems. By analyzing the new existing research, the process history-based method, named the data-driven method, can detect both soft and hard faults in the AC systems. The soft faults are more difficult to detect by the classical methods, and the system still works for an extended time with minimal performance and high energy consumption, causing a degradation of the system's energy efficiency. In many cases, soft faults generate some parameter deviations without knowing the physical meaning; however, an expert system can detect the fault source and type depending on the sensor's position and type.

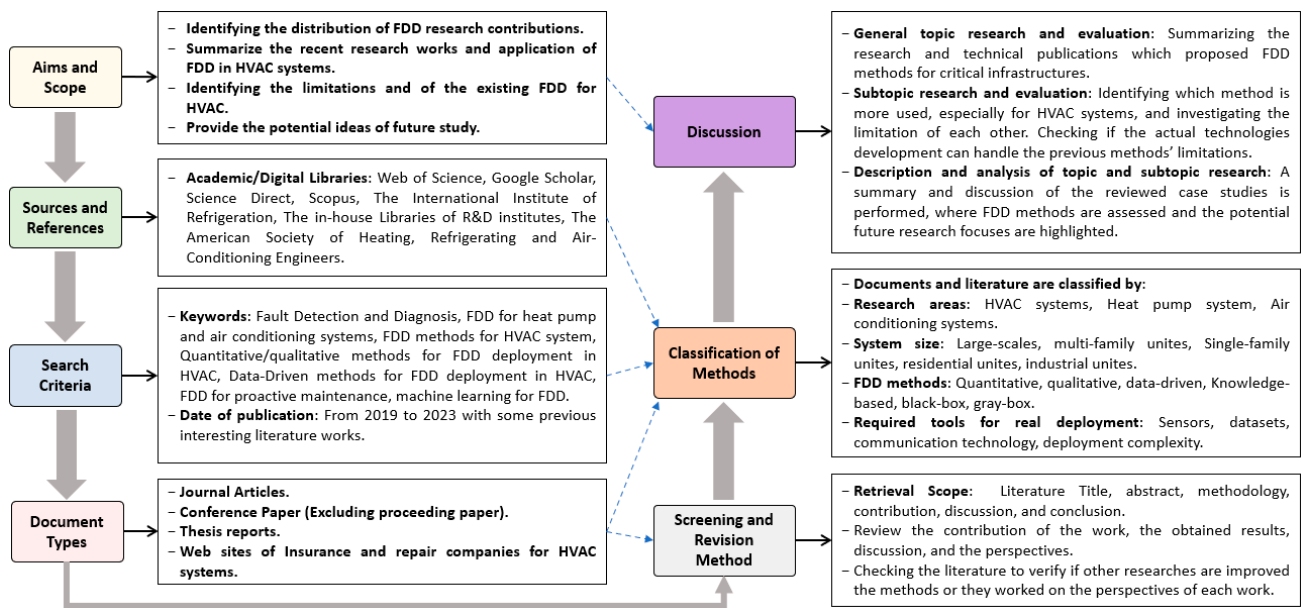

Figure 1. Summary of research methodology.

In addition, machine learning models for data classification can help with high accuracy in the identification of faults. The existing process history-based models are classified into two categories: black-box and gray-box models. The black-box models form a statistical model to describe the relationship between the system's inputs and outputs. The gray-box models create a relationship between the normal operating conditions and the estimated coefficients based on the fundamental physics laws. In this case, physical knowledge is used to specify the mathematical models, and data history is used to empirically determine the model parameters. A dataset is used to train machine learning algorithms and to estimate gray-box AC parameters depending on the measured data. The historical data are obtained by specific laboratory tests and AC manufacturer information or by the installation of sensors in different positions during the normal operation of the system. However, in order to specify the sensor type and position, experts should identify the components that are frequently damaged in the AC systems and identify the equivalent power losses caused by each fault. The work presented in [8] presented an approximate breakdown of faults in the literature for building systems according to system type. The authors mentioned that air-handling units present more than 42% of the total fault sources in a large commercial AC system. However, the statistics were based only on the existing work without any technical details or field statistics. Mainly, the authors in [11] experimented with single-fault impacts on an AC system with a microtube condenser. A unitary AC was tested in a well-controlled psychrometric chamber with four individual faults imposed: evaporator airflow, refrigerant charge, liquid line restrictions, and the presence of non-condensable gas in the system prior to adding the refrigerant. The impacts of each installation fault on AC capacity and coefficient of performance are investigated, and interesting results are presented concerning the capacity decrease. The main limitation of the proposed study is the number of installed sensors. A set of temperature, pressure, and airflow sensors are installed for the experimental testing. In reality and for economic assessment, the installation of additional sensors would be expensive and difficult to install in the existing system.

According to the analysis of the existing works, a large part of the proposed FDD methods focus on hard fault detection, while the proposed soft fault methods are not able to detect simultaneous soft faults. A set of tests tested more than one fault, but these faults were established separately without combining more than one failure in the same scenario. On the other hand, the proposed methods focus on a specific failure in an AC system and use only the manufacturer's deployed sensors without proposing an optimal sensing architecture capable of detecting simultaneous faults. Additionally, existing works focus

more on the analysis of the coefficient of performance of the studied system; however, it is difficult to detect soft faults by analyzing this coefficient without considering the lifetime of the components. Therefore, this work shows that data-driven methods are more accurate for both soft and hard fault detection and diagnosis, with the ability to be developed to detect simultaneous faults in AC systems with high accuracy.

3. Major Common Faults in Air Conditioning Systems

The operation of an AC system with faults leads to significant energy loss and affects the occupant's productivity and health. The energy consumed by this system has a principal impact on the improvement of energy efficiency in buildings. However, the complexity of the AC system with its several coupling components (e.g., evaporator, condenser, compressor, fans, and control units) makes it a critical infrastructure requiring numerous measurements for monitoring. This variability in the components with different disciplines (e.g., mechanics, thermodynamics, chemical, and electric) requires the use of several sensor types and locations to detect faults during the system's operation. For that, common faults in the AC system should be classified, and an approximation of each component breakdown should be identified to specify the essential sensors for fault detection, location, and diagnosis. Depending on the space requirements, air distribution requirements, and primary equipment requirements, AC systems are classified into two main categories: Stand-Alone AC units and Split-System AC units (Figure 2). These two categories vary essentially depending on the space size (e.g., room, offices, distributed course rooms) and the primary equipment distribution (e.g., central unit, unitary unit).

This classification will help with the identification of the existing installed sensors and the required measurements and sensors that should be installed for fault detection and diagnosis. Therefore, in large buildings, the central AC system is more used due to its central control and management. However, the central AC systems are still the largest consumers of electricity due to several control constraints and their large size, which causes more faults and losses in the system. The work will focus more on fault detection and diagnosis in the central AC systems, while the study is able to be generalized for the other local units. A comprehensive classification of faults is helpful in understanding and learning the faults sources and types and thus proposing solutions. The classification is made in various ways based on different considerations. In this work, we propose three fault classes in the AC systems (Figure 3). The first class concerns component faults. Generally, this type of fault is caused by the degradation of the components due to a long period of use or by failures in the manufacturing process. The second class is the man-made faults caused by an inexperienced maintenance staff or due to the improper installation of the system. Generally, man-made faults degrade the system's operation, such as an improperly sized duct, a frozen or hot condenser location, a refrigerant quantity that was not correctly added, and an evaporator that was improperly installed. The third fault class concerns the faults generated due to ignored commands, decisions, or actions. The actual AC systems use some temperature sensors to measure the outside/inside temperatures in order to generate actions for the condenser and the evaporator. Depending on the context-driven awareness, the system is controlled in a way to minimize energy consumption, while faults in the sensor installation or the command execution reduce the performance of the system. This type of fault is detected by the analysis of the context parameters (e.g., inside/outside temperature, humidity, pressure) compared with the electrical consumption of the condenser and evaporator. Therefore, most AC faults are soft faults, meaning that the system is still working without affecting the occupant's comfort while the coefficient performance is at its minimum, causing high energy consumption. The development of a technique for fault detection, classification, and location is based on the measurable parameters in the system and the positioning of the installed sensors.

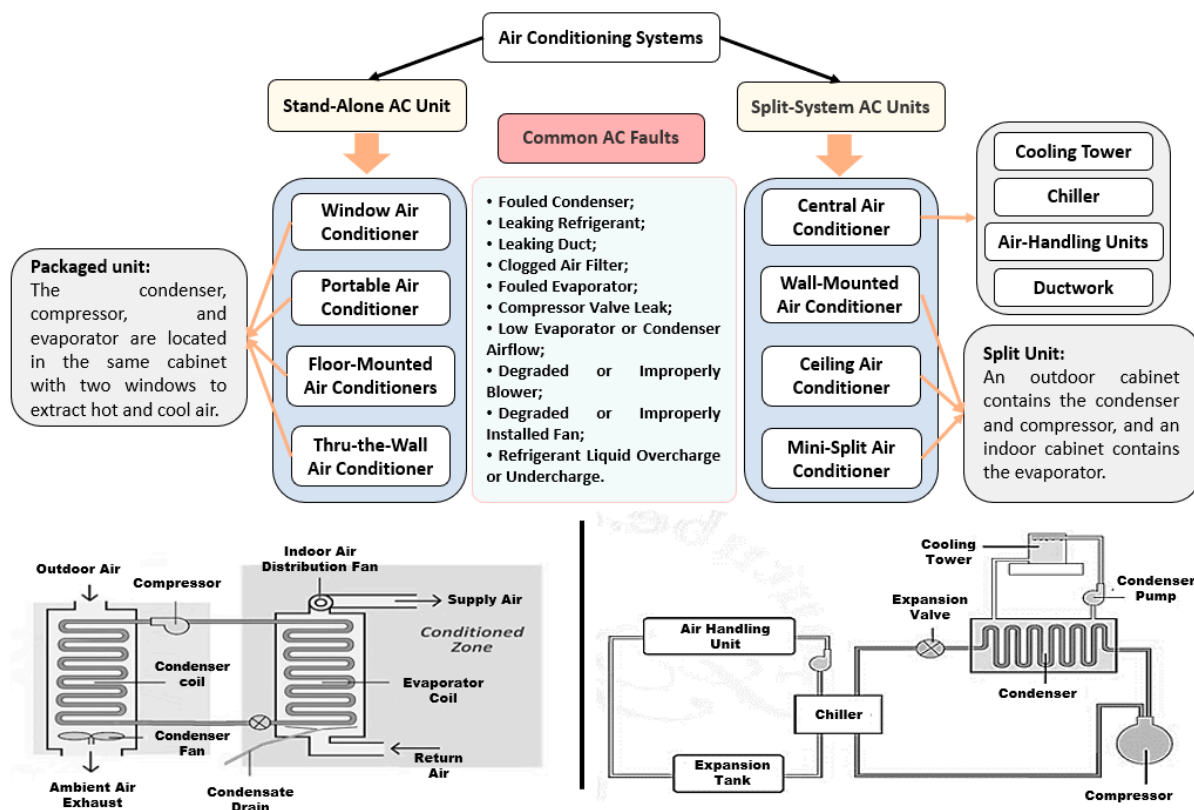

Figure 2. Air conditioning system type, common faults, and architecture.

An accurate technique is one that can detect several types of faults with a minimal number of sensors. In order to select the sensor types and positions in an AC system to detect faults, another classification is proposed based on the system components. An AC system is a combined mechanical, thermodynamic, and electrical environment requiring several types of sensors to monitor the different quantities. The main measurements in an AC system are affected by the refrigerant or the air side (Figure 3). The refrigerant side requires direct interaction with the system to install internal sensors for flow and pressure measurements at specific points in the system cycle. The data collected from this side necessitates expert system interpretation and analysis to identify if the system is in optimal operation or not.

Though air-side measurements are affected by the installation of external sensors (e.g., temperature, air flow, pressure, and power consumption) to identify the context driven of the system and conclude the coefficient performance for a given context, several measurements should be established on the airside to create a direct and indirect relationship between the system’s operation and other external parameters such as weather conditions and occupants’ activities. In fact, this is the main research key that researchers focus on to reduce the energy consumption of the AC system, depending on occupant detection and activity identification [43]. On the other hand, a relationship is established between weather conditions and the optimal operation of an AC system using virtual sensing techniques to detect faults. Mainly, during the lifetime of an AC system, some faults are more frequent than others, requiring more downtime and maintenance costs. For that reason, a classification of AC faults depends on their frequency and percentage occurrence. Consequently, according to the analysis of existing literature, the only sources of data are the manufacturers, repair and insurance companies, and research laboratories that focus on specific measurements and data gathering [8,10,44]. In fact, during the warranty period, the manufacturer’s customer service receives feedback from the end-users for fault repair, presenting interesting statistics to identify the common faults of AC systems. After the warranty period, large-scale AC systems (e.g., hospital, multifamily building, university

campuses) are monitored and maintained by repair/replacement companies. These companies are the main key to gathering the necessary data collected from real systems during several types of simultaneous faults while at the same time identifying the fault percentage and the frequency of repairing each fault [45]. The more frequent and costliest faults are summarized in Figure 4. The presented results are summarized based on several review papers that present statistics on common faults in AC systems [46–48].

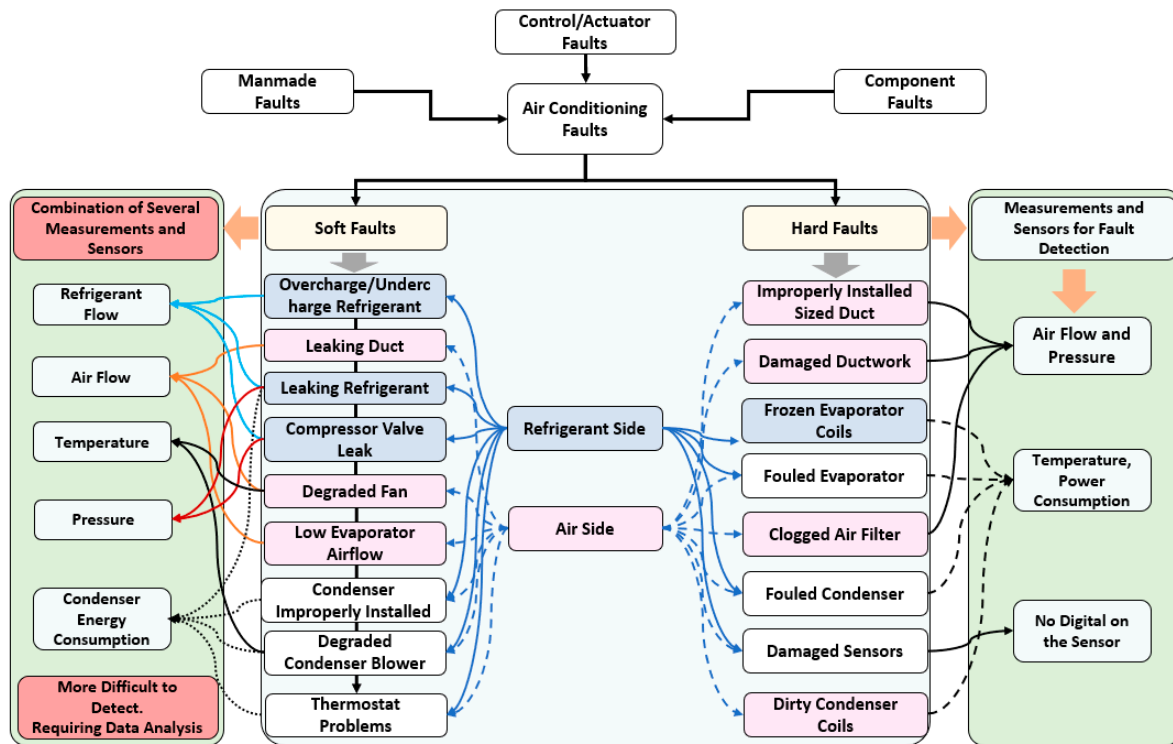

Figure 3. Air conditioning fault classification and the required detection sensors.

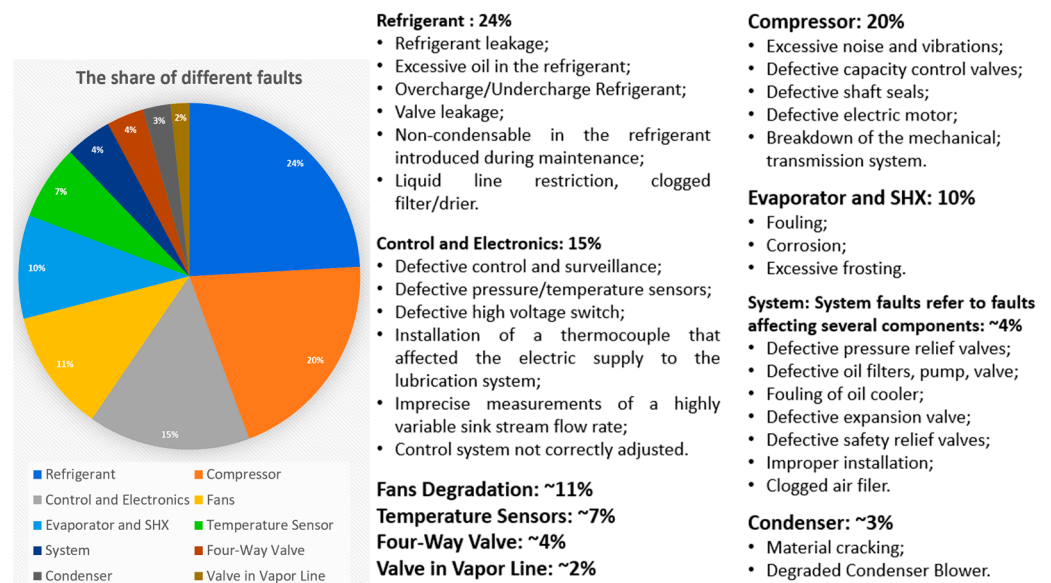

Figure 4. The share of different components' faults.

These alarming statistics presented in Figure 4 show that more than 60% of repaired faults are due to refrigerant, compressor, and control/electronics faults. A survey and analysis of several AC systems in domestic buildings show that more than 72% have

an improper refrigerant charge, 60% have a degraded compressor's motor, 54% have improper air flow, and 20% have failed sensors or control cards, with the possibility to combine more than one fault [8,49,50]. By the analysis of these faults, a large part affects significantly the compressor, control/electronics, and sensor units [50]. On the other hand, the associated faults in these components are generally soft, which are more difficult to detect, and they will develop into hard faults if they are not detected and maintained correctly. In the next section, the different existing FDD methods used for AC fault detection are summarized, focusing more on the actual techniques based on the new information and communication technologies.

4. Fault Detection and Diagnostic Techniques for Air Conditioning

At this stage, it is important to distinguish between fault detection and fault diagnostic methods. The task of fault detection is to find faults within the AC system without generating analytic actions to accurately identify or isolate them. Depending on the proposed method, in some case studies, the faults are detected and classified in order to identify the component source of these failures in the system [31,32]. The fault diagnostic task is generally combined with the fault detection task, and it is responsible for generating indications for the fault diagnosis process. In some applications, diagnostic and detection tasks are not explicitly separated because diagnostic methods require the use of sophisticated techniques for automated fault detection, classification, and location. Several existing works propose classifications of fault detection and diagnostic methods for buildings and for heating, ventilation, and AC systems [51,52]. The different works classified the methods into quantitative/qualitative-based models, data-driven-based models, black/gray box models, and prior knowledge-based models (Figure 5). Focusing more on these classes, the black/gray box models are presented as a sub-class of the other classes, as is presented in [28]. For some existing work, the gray box is named a white box, while the analysis of the method shows that both are based on the estimation of state space model parameters based on a predeveloped mathematical equation of the system [53]. These methods continuously measured AC operation status and automatically compared the results with the established baselines of normal operation depicted by physics- and engineering-based models. The black/gray box models are more robust when combined with data-driven methods. The use of deep learning methods for data analysis and process history strengthens the performance of the model that considers the AC system as a black/gray box. Unlike the black/gray box models, quantitative model-based systems present a set of mathematical relationships between the system and its fundamental physics, while qualitative model-based systems involve qualitative relationships resulting from knowledge of the fundamental physics. On the other hand, process history model-based analysis analyzes the measurement data during system operation in order to create a typical behavior model of the system and detect abnormal events. Therefore, process history-based methods are based on the new information and communication technologies (e.g., Internet of Things, artificial intelligence, big data) in order to interpret specific measurements to identify faults. A parameter deviation shall be automatically detected, and the analysis of this deviation by an expert system can identify exactly the sources of this trouble. Unlike the quantitative and qualitative model-based methods, this method can detect faults at the beginning before they cause total damage to the system, avoiding higher energy consumption and long breakdown times. This method is interpreted in the next section of this work. Moreover, based on the analysis of other research works, process history-based models are called data-driven-based models [54,55]. Focusing on these methods' classification, it is important to identify the difference between knowledge-based and data-driven-based models that are confused on the principle of operation. In fact, knowledge-based methods focus more on the interpretation of real-time data collection or periodic measurements in order to identify abnormal operating conditions. The model decision is based on the employment of human experts' knowledge and expertise to support fault alarms. For the automation area and maintenance staff, knowledge-based models should be improved by other techniques, such

as artificial intelligence, to automatically select abnormal events. For that, data-driven models are developed. Data-driven or process history-based models use both historical datasets and real-time data collection for the learning of supervised, unsupervised, or regression-based learning models [56,57]. The different classes are summarized in Figure 5 based on different literature works [28,51–53,55,58–60].

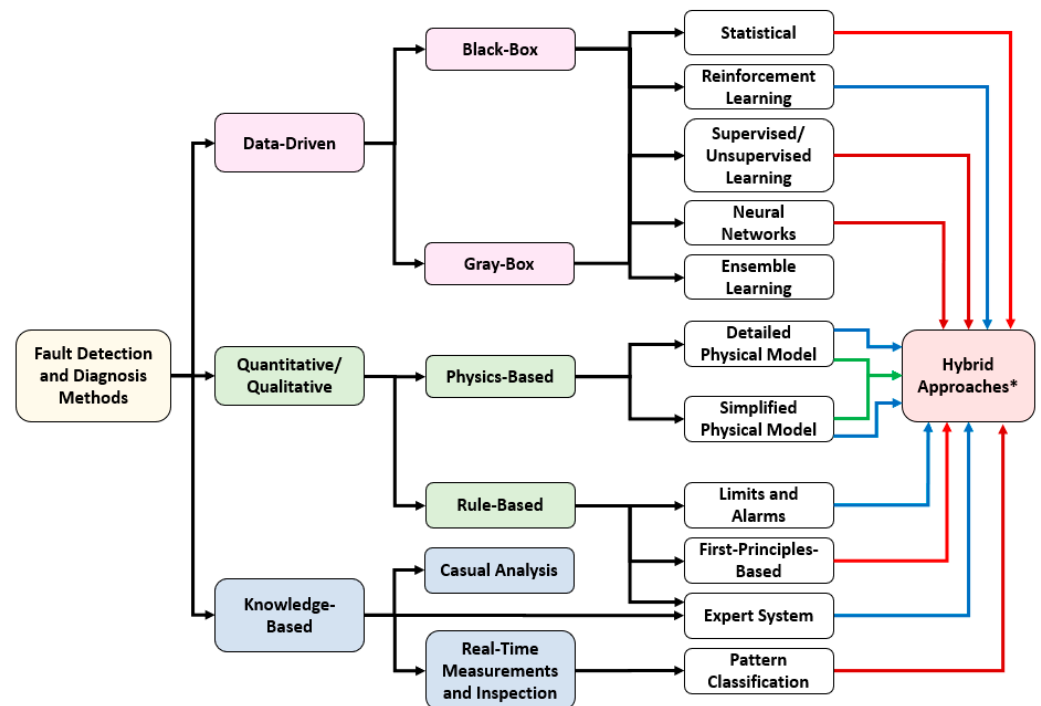

* The approaches linked with the same colors are already combined in the literature for hybrid approaches

Figure 5. Fault detection and diagnostic method classification.

Actually, the gray-box model is combined with the new artificial intelligence methods in order to improve the performance of the model. Automated fault detection uses the physical equation of the system together with process history models for not only fault detection but also to perform diagnostic tasks [33]. For the hybrid approaches, the arrows are connected depending on the existing works that make a hybridity of methods [34–36,60,61].

The analysis of these methods shows that process history-based methods present several advantages compared with the other methods. Therefore, process history-based methods use a diversity of measurements and datasets to learn the model without having physical knowledge of the system. The achievement of this method is based on the type, position, and number of deployed sensors to prepare a large amount of data. A set of relationships should be created between the different measurements and the equivalent faults that can be detected in order to minimize the number of installed sensors and maintain high modeling accuracy. A contribution is presented in the next section, classifying the measurements, sensor positions, and equivalent faults that are detected based on AC system architectures. The investigated method can be deployed for all types of AC systems, including those with variable air volume and variable refrigerant flow. The only difference can depend on the system size (e.g., large-scale, multi-family, window unit).

5. Sensor Deployment and Data Source Architecture

Sensor deployment type, position, and number are the main phases before carrying out the fault detection and diagnostic process. This phase requires more focus from researchers in order to specify the effect of each fault on the other AC system's output. A fault can affect one of several parameters in the system with different intensities. An accurate positioning (e.g., chiller, heat pump, air handling unit) and type (e.g., temperature,

refrigerant flow, pressure, humidity) of the sensor is the one that can detect the maximum number of faults. For that, more studies should be carried out to identify, for the common faults in the AC system, the equivalent parameters that are more influenced. In this way, the required measurements for several fault-type detections are assembled into one sensor with a specific position in the AC architecture. An interesting work is presented in [11], studying the fault intensity of four faults (improper evaporator airflow, refrigerant charge, liquid line restriction, and non-condensable gas) during three operating conditions tests corresponding to AHRI standard 210/240 [62]. A psychrometric chamber is used with a set of sensors to measure the refrigerant mass flow rate, refrigerant pressure/temperature, atmospheric pressure, air pressure drops, cooling capacity, and outdoor unit power. The authors concluded that the evaporator airflow fault had linear impacts on cooling capacity and the coefficient of performance. Moreover, the refrigerant undercharge and liquid line faults affected cooling capacity and coefficient of performance, while the coefficient of performance was more impacted by the non-condensable gas fault than the capacity. From this study, it is shown that the outdoor unit coefficient of performance allows us to detect different faults in AC systems. The major problem in this study was the multiple neglected parameters during the different scenario tests. An optimal method should be established to select the suitable conditions and the effect of each fault [63,64]. Otherwise, it is difficult to assume the impact of the studied faults. A set of studies should be established in order to identify the intensity of the common AC faults, helping with the improvement of new data-driven methods for fault detection and diagnostics. A centralized AC system is presented in Figure 6 with the proposed sensor architecture that is deployed for testing. Generally, in the AC system, temperature sensors are installed to measure the indoor/outdoor temperature in order to execute the equivalent command to reach the setpoint. The actual AC systems are improved by the integration of new techniques (e.g., variable air volume, variable refrigerant flow) to optimize the use of energy depending on different indoor comfort zones. However, the AC system has not yet improved in line with actual technological developments. It is the first consumer of electricity in the building, while the different existing research projects focus more on the internal operational system to increase performance.

Based on the analysis of the existing work in the literature, a large amount of research used internal system measurements (e.g., refrigerant flow, pressure, and temperature) to detect the faults. These measurements present acceptable results in the laboratory with the use of controllable environments such as the psychrometric chambers. Nevertheless, more research should be conducted by experts to identify the effect of each component fault on the other measured parameters. This research can help identify the required sensors that should be installed to detect both soft and hard faults. Figure 6 presents both internal (e.g., refrigerant flow, refrigerant pressure, and temperature) and external (e.g., power consumption, outdoor temperature/pressure, indoor temperature/pressure) measurement architectures to study the effect of faults on the system. In this work, we propose a data-driven method based on external measurements (e.g., compressor power consumption, fan power, external/internal temperature) to detect faults in the system. The coefficient of performance is a parameter rating that is calculated to determine the effectiveness of AC systems against the amount of electrical power in a given context. The movement of heat from a low-temperature zone into a high-temperature zone requires work. The work consumed by the evaporator and the compressor is theoretically equal to the work used by the condenser. The electrical power consumed to generate the equivalent work to move a certain quantity of heat at certain conditions (e.g., temperature, pressure, humidity) is measured during the normal operation of the system, and it will be used for the machine learning algorithm training. Therefore, a set of sensors, such as current/voltage sensors, should be installed to measure separately the power consumed by both internal and external units. Temperature, pressure, and humidity sensors should be installed for indoor and outdoor use to specify the operating context of the system, which influences directly the evaporator, the compressor, and the condenser, as well as automatically the

electrical power consumed. These parameters will be used as input to a multivariable machine learning model to perform the model objectives.

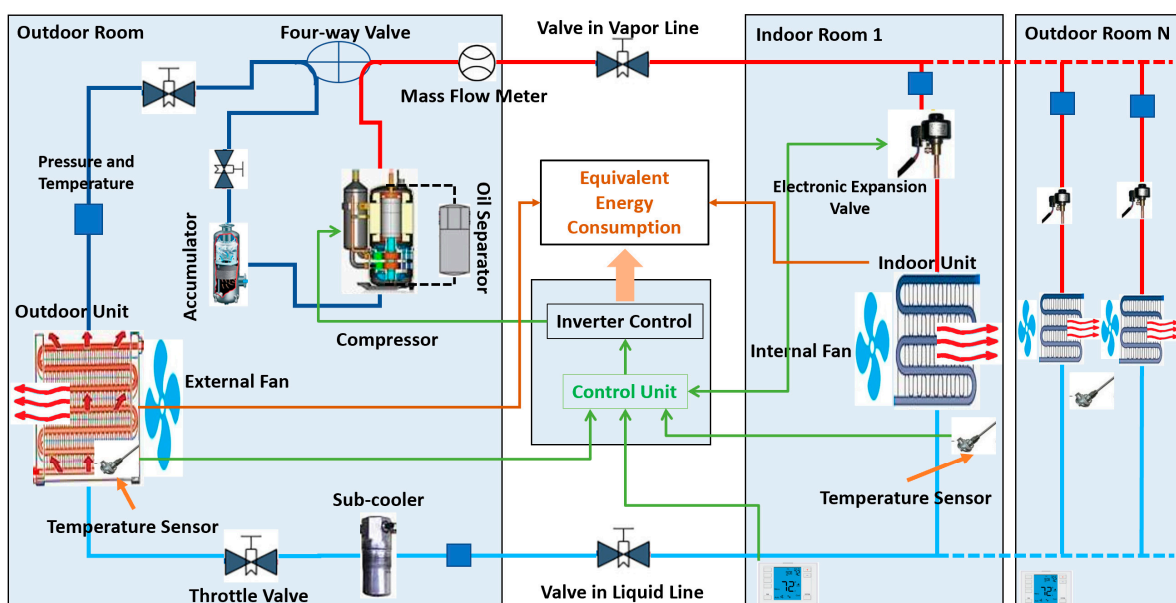

Figure 6. Schematic of a typical air conditioning system.

6. Synthesis and Contribution

6.1. Synthesis and Discussion

Current FDD methods still have the shortcoming of detecting simultaneous soft faults in several components in the AC system. A large part of the existing work focuses on specific components without proposing a new method to detect faults in several parts (e.g., compressor, evaporator, condenser, and refrigerant) of the AC system simultaneously. Moreover, in the past decades, literature has focused more on hard fault detection without improving efficient solutions to detect the faults in the AC systems or planning a shutdown period for maintenance. However, few papers have been published that use data-driven approaches for FDD. Data-driven approaches have a high capability for detecting both soft and hard faults. The authors (Table 1) used an offline model based on machine learning algorithms to classify datasets in order to detect abnormal operation of a specific component in the AC systems. The datasets used for the training and testing of the algorithms are collected during normal and faulty operation of a given AC system, while the obtained results cannot assume the usefulness of the test FDD methods for all other types of AC systems. Depending on the manufacturer and the AC size, the method should be totally changed in order to deploy the FDD method using a data-driven approach. Until now, there has been no real AC system equipped with the FDD method for real-time fault detection. The investigated methods are tested in the laboratory with a controllable psychrometric chamber because the real AC system has a limited number of sensors that are deployed by the manufacturers only for control and temperature regulation. Consequently, more studies are required in order to investigate the common faults in AC systems and propose an optimal sensor architecture that can detect a maximal number of faults with a minimal number of sensors. Some faults have the same fluctuations in the system, and a sensor optimally installed is the one that can detect more than one fault with high accuracy without generating redundant data for the machine learning algorithm. In the laboratory, researchers can install several types and numbers of sensors; however, for real deployment, this number should be minimized in order to minimize the cost for manufacturers. In the existing work, the authors focused on a specific component in the AC system, while other components faults have the same fluctuations and can be detected by the same sensors without duplicating the measurements. Studies of simultaneous common faults are

required in order to identify the sensors' architecture that can detect simultaneous faults in the different AC components. On the other hand, the existing fault detection shortcomings require the investigation of new FDD methods for AC systems capable of detecting soft faults that shall be developed to detect hard faults if they are not detected and maintained correctly. The use of new information and communication technologies (e.g., the Internet of Things, artificial intelligence, and big data) is a main factor in future data-driven method investigation and development. As opposed to any other smart service in the building, the AC system should be improved in a way to allow more interaction with the consumer, especially for fault alert and identification. After the development of the present study, possible lines of future research were identified:

- Identifying an optimal sensor architecture to detect a maximal number of faults with a minimal number of sensors.
- Developing new FDD methods to detect simultaneous faults in AC systems with a greater on soft faults.
- The development of FDD methods capable of being deployed for each type of AC system without considering the AC size (e.g., large-scale, multi-family, single-family, residential AC unit) or the manufacturer.
- Investigating new online FDD methods capable of detecting the abnormal operation of AC systems without planning a shutdown time for the system.
- The investigation of new FDD methods based on the Internet of Things. The AC system is a system that will be improved into a smart service in the building in a way to be connected to other services at the same time as the cloud computing services. In this case, the deployment of machine learning algorithms for FDD will be robust.
- The use of social sensing methods together with the actual FDD methods is a main research motivation to minimize the cost of the sensors deployed in the AC system to detect faults.
- The FDD methods-based, data-driven approaches should be improved to have the capability to be deployed in isolated areas where the AC system is not connected to the internet. This research motivation is boosted by the development of new machine learning algorithms and artificial intelligence methods that minimize the processing time and reduce the required computing performance [65,66].

6.2. Contribution

The objective is to detect simultaneous faults using data processing history-based methods. In this way, the model's input parameter selection is the main challenge. In fact, the power consumption variability is the main key that is affected by the fault in the system. Although energy consumption levels are quite variable due to several uncontrollable indoor and outdoor unit operation states (e.g., different outdoor unit temperatures, different indoor temperature setpoints), the power consumed by the compressor is affected by all faults in any component of the AC system as well as internal compressor faults (e.g., defective electric motor, defective shaft seals, breakdown of the mechanical system). When the coefficient of performance is degraded due to several faults in the system, the compressor consumes more energy to generate the same work in a given context (e.g., indoor/outdoor temperature, compressor temperature, humidity, pressure). Hence, other parameters are proposed to be combined with energy consumption to detect faults (e.g., compressor temperature, compressor vibration). The refrigerant flow, the variable compressor speed control, the compressor vibration, and the system energy consumption are proposed for future investigation. The framework of the proposed process history-based method is presented in Figure 7.

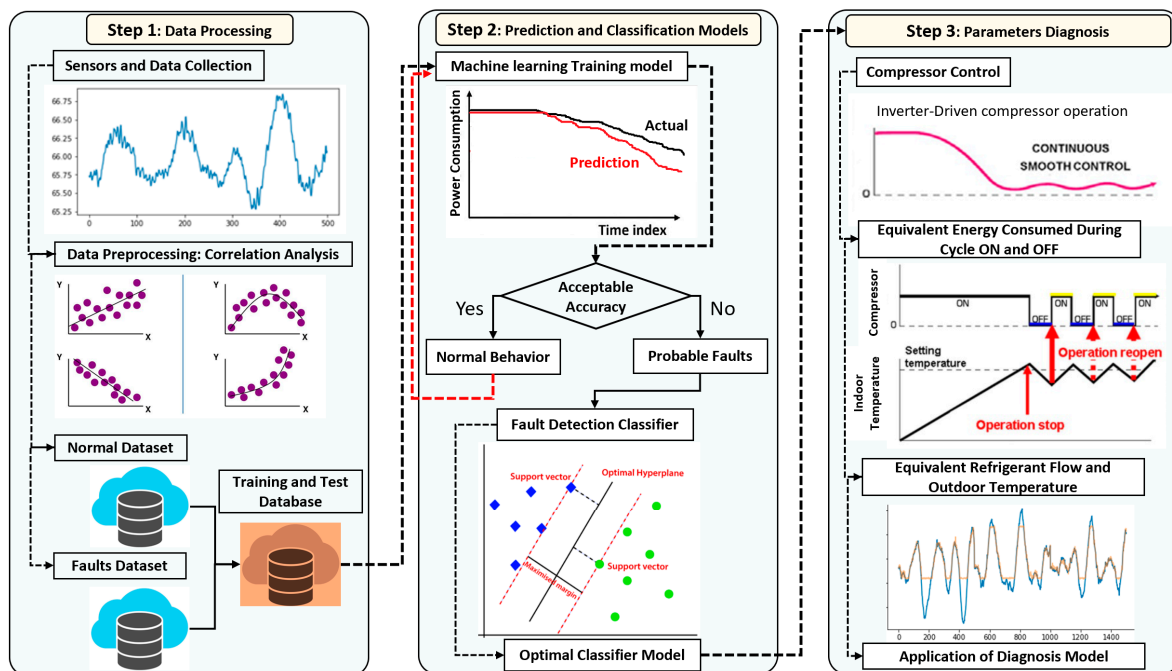

Figure 7. Fault detection and diagnosis model framework.

Mainly, in “step 1”, a set of measurements is collected (e.g., power consumption, refrigerant flow, indoor and outdoor temperature). These measurements are stored in order to construct the initial database for both normal and faulty scenarios. The initial database is used for training and algorithm testing. In “step 2”, the training data are used to predict the future power consumption of the AC system, while the results are compared with the testing data to identify the accuracy of the model. In the event of accurate results, the model will restart the test using the actual measurements. However, in the case of a large deviation from the model, the actual data will be classified using a machine learning classifier model (e.g., Extra Tree, Random Forest, support vector machines). Since the power fluctuation is generated for several reasons, other parameters will be used for the diagnosis. In “step 3”, since the speed of the compressor varies depending on the setpoint, the compressor operates continuously for the “ON” period, consuming an equivalent amount of power. This energy will be compared with the normal dataset, including indoor and outdoor conditions. At the same time, the required refrigerant flow is supplied to the indoor fan coil, and once the setpoint is obtained, the refrigerant flow is adjusted to maintain the room temperature smoothly without fluctuations. The concept of this model is based on a large dataset obtained from the same sensors in different operational contexts.

In the first phase, the power consumed by the condenser, evaporator, and compressor will be used for training. The power consumed by the condenser depends on the difference between indoor and outdoor temperatures, the pressure, and the humidity. These measurements are used for the training of the multivariable model, along with the power consumption. Other internal parameters of the system, such as the refrigerant pressure and temperature, are used to improve the model parameters. In fact, the work methodology is the same, while several machine learning methods are used for data classification (e.g., support vector machines, Decision Trees, Extra Tree Classifiers, Ada-Boost Classifiers). The AC system is considered a black box with input and output based on experimental data. Linear and non-linear models are used to present the process of black-box strategy. Since the measurements considered are nonlinear due to changes in indoor/outdoor conditions, artificial neural network models are commonly used for nonlinear prediction in plants with nonlinear behavior. The artificial neural network models have the ability to learn from examples to detect faults. Models are trained, and the selected parameters represent the relationship between the past values and the future measurements to identify abnormal

events. The idea of the future work is to combine an Extra Tree Classifier model for fault detection with an artificial neural network for the proposed model (Figure 8).

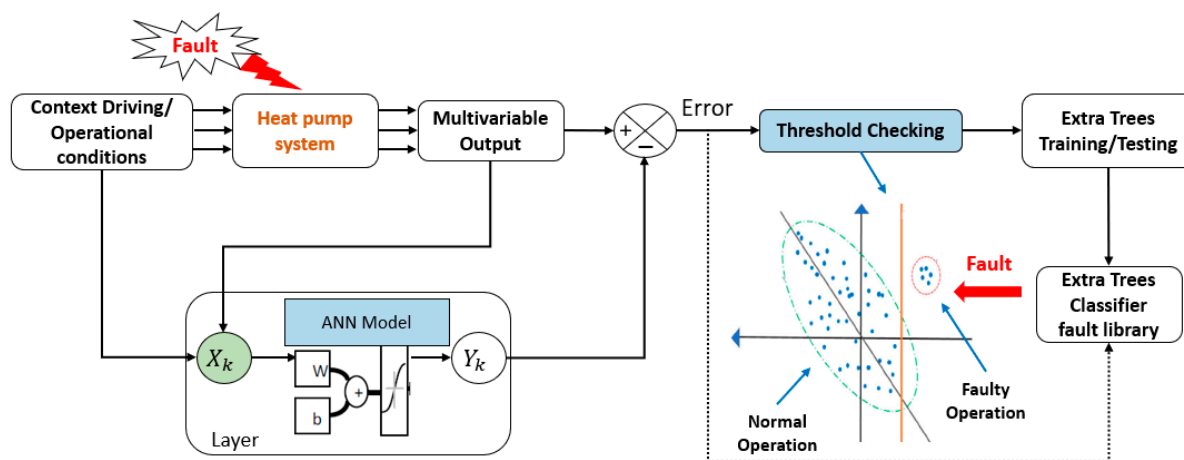

Figure 8. Diagram of black-box model-based ANN-Extra Tree fault detector.

The FDD process is organized as follows:

- Selecting the list of common and frequent faults as the objective of the FDD method.
- Identifying the optimal sensor position and number capable of detecting the maximal number of common faults without having redundant data.
- Collecting the data during normal and faulty cases.
- Training the first ANN model (Figure 8) using the compressor power consumption dataset and the indoor/outdoor operational context (i.e., temperature, humidity). This step allows us to detect two cases: normal operation or faulty operation. It requires less processing and data analysis performance, and it allows you to detect faults at their beginning.
- In the case of fluctuated compressor power consumption for the same operation context used for the training, the Extra Tree Classifier model starts the analysis of the other measurements (e.g., compressor vibration and temperature, refrigerant pressure, input/output condenser, and evaporator temperature) in a way to identify, from the fault library, the equivalent fault cause of this fluctuation.
- Detecting simultaneous faults based on the library fault. In the case of faults that have similar symptoms, another sensor should be added to distinguish the two similar faults, which is the role of the optimal sensing step.

7. Conclusions and Perspectives

This work highlights the main shortcomings of existing FDD methods for AC systems. Common faults are summarized, along with the different methods used for fault detection. Soft faults attracted more attention due to their effect on the performance of the system and because they were more difficult to detect. During soft faults, the AC system still works without affecting occupant comfort, but the system's performance is degraded, which increases energy consumption and automatically reduces the energy efficiency of buildings. Some terrifying statistics show that 30% of the actual heating, ventilation, and AC systems have two or more soft faults. A survey and analysis of several AC systems show that 72% have an improper refrigerant charge, 54% have improper air flow, 20% have failed sensors, and more than 80% have non-optimal control. Due to the lack of alarms for examination in the field and the improper installation, AC systems do not achieve their rated efficiency, and they are still the largest consumer of electricity in the building. This system should attract more attention from research communities to make it "smart and interactive", especially for fault detection and diagnostics. Existing FDD methods focus more on specific component faults without the ability to detect simultaneous faults. The development of new methods to

detect simultaneous faults is required, and the new methods should be capable of detecting faults independently of the AC size or manufacturer. In fact, data-driven approaches have the ability to deal with existing limitations due to the integration of new information and communication technologies. The major conclusions and perspectives are summarized as follows:

- Significant energy can be saved by the proper diagnosis of AC systems. Simultaneous faults should be detected as quickly as possible, requiring robust methods for detection, classification, and diagnostics. The new FDD-based, data-driven approaches should be capable of being deployed in isolated areas where the AC system is not connected to the internet.
- The development of information and communication technologies is a key to improving the efficiency of AC systems. The use of artificial intelligence is a factor that can help automate the system with the deployment of new methods for predictive maintenance. The Internet of Things concept should be integrated into AC system monitoring and control to make the system more interactive with its environment and especially with the occupant. Additionally, the use of the Internet of Things helps with the data collection and processing integrated for the development of new control and predictive maintenance methods.
- AC systems can be connected with other building services for optimal control and also for the integration of new concepts such as virtual sensing in order to have a larger dataset for monitoring and fault detection. Weather conditions datasets are interconnected with the system control for optimal operation to achieve rated efficiency.
- Research should consider the context-driven awareness of AC systems to minimize the energy consumed and maintain maximal occupancy comfort. The occupancy and activity detection in the building are the main keys to optimally controlling the AC system in a way to minimize the use of this massive consummator of energy. The use of new information and communication technologies, especially the Internet of Things, is an interesting concept used to make the AC system a “smart service” that interacts with the end user and with other services.
- The use of machine learning methods is an interesting key for future work in order to develop new methods for fault detection, diagnostics, and AC system control. The identification of accurate machine learning algorithms for parameter prediction and data classification is required for precise FDD deployment.

In the future, the emphasis should be on the development of a sensor architecture deployed for optimal control and monitoring of AC systems in order to achieve the mentioned objectives. The effect of each fault should be selected to identify the type, the location, and the number of sensors required to detect a maximal number of faults with a minimal number of sensors. The AC system should be considered a smart service for building communication with other devices using the Internet of Things platform. This communication allows for the combination of social sensing and data-driven methods for FDD, which reduces the cost of their deployment and increases AC efficiency. In short, further work needs to be done in optimizing architecture, detecting simultaneous faults, developing FDD methods independent of AC size, applying the Internet of Things, social sensing, and deployment in isolated areas.

Author Contributions: Conceptualization, A.E. and P.W.T.P.; methodology, A.E.; validation, P.W.T.P., B.F. and J.S.; formal analysis, P.W.T.P., B.F. and J.S.; investigation, P.W.T.P.; writing—original draft preparation, A.E.; writing—review and editing, P.W.T.P., B.F. and J.S.; visualization, A.E.; supervision, P.W.T.P. All authors have read and agreed to the published version of the manuscript.

Funding: This research received no external funding.

Data Availability Statement: Data sharing is not applicable to this article.

Conflicts of Interest: The authors declare no conflict of interest.

References

1. International Energy Agency. Global Energy Review 2021: Electricity Demand. Available online: <https://www.iea.org/reports/global-energy-review-2021/electricity> (accessed on 20 September 2022).
2. Wu, J.; Xu, Z.; Jiang, F. Analysis and development trends of Chinese energy efficiency standards for room air conditioners. *Energy Policy* **2019**, *125*, 368–383. [[CrossRef](#)]
3. Ahmad, J.; Larijani, H.; Emmanuel, R.; Mannion, M.; Javed, A. Occupancy detection in non-residential buildings—A survey and novel privacy preserved occupancy monitoring solution. *Appl. Comput. Inform.* **2021**, *17*, 279–295. [[CrossRef](#)]
4. Che, W.; Tso, C.Y.; Sun, L.; Ip, D.Y.; Lee, H.; Chao, Y.H.C.; Lau, A.K. Energy consumption, indoor thermal comfort and air quality in a commercial office with retrofitted heat, ventilation and air conditioning (HVAC) system. *Energy Build.* **2019**, *201*, 202–215. [[CrossRef](#)]
5. Tang, R.; Wang, S. Model predictive control for thermal energy storage and thermal comfort optimization of building demand response in smart grids. *Appl. Energy* **2019**, *242*, 873–882. [[CrossRef](#)]
6. Kharbouch, A.; Berrabah, S.; Bakhouya, M.; Gaber, J.; El Ouadghiri, D.; Kaitouni, S.I. Experimental and Co-Simulation Performance Evaluation of an Earth-to-Air Heat Exchanger System Integrated into a Smart Building. *Energies* **2022**, *15*, 5407. [[CrossRef](#)]
7. Yan, X.; Guan, T.; Fan, K.; Sun, Q. Novel double layer BiLSTM minor soft fault detection for sensors in air-conditioning system with KPCA reducing dimensions. *J. Build. Eng.* **2021**, *44*, 102950. [[CrossRef](#)]
8. Rogers, A.; Guo, F.; Rasmussen, B. A review of fault detection and diagnosis methods for residential air conditioning systems. *Build. Environ.* **2019**, *161*, 106236. [[CrossRef](#)]
9. Torabi, N.; Gunay, H.B.; O'Brien, W.; Moromisato, R. Inverse model-based virtual sensors for detection of hard faults in air handling units. *Energy Build.* **2021**, *253*, 111493. [[CrossRef](#)]
10. Pelella, F.; Viscito, L.; Mauro, A. Soft faults in residential heat pumps: Possibility of evaluation via on-field measurements and related degradation of performance. *Energy Convers. Manag.* **2022**, *260*, 115646. [[CrossRef](#)]
11. Hu, Y.; Yuill, D.P. Impacts of common faults on an air conditioner with a microtube condenser and analysis of fault characteristic features. *Energy Build.* **2022**, *254*, 111630. [[CrossRef](#)]
12. da Cunha, S.R.L.; de Aguiar, J.L.B. Phase change materials and energy efficiency of buildings: A review of knowledge. *J. Energy Storage* **2020**, *27*, 101083. [[CrossRef](#)]
13. Elkhokhi, H.; NaitMalek, Y.; Bakhouya, M.; Berouine, A.; Kharbouch, A.; Lachhab, F.; Hanifi, M.; El Ouadghiri, D.; Essaaidi, M. A platform architecture for occupancy detection using stream processing and machine learning approaches. *Concurr. Comput. Pract. Exp.* **2020**, *32*, e5651. [[CrossRef](#)]
14. Elmouatamid, A.; Ouladsine, R.; Bakhouya, M.; El Kamoun, N.; Khaidar, M.; Zine-Dine, K. Review of control and energy management approaches in micro-grid systems. *Energies* **2020**, *14*, 168. [[CrossRef](#)]
15. Zhou, Z.; Wang, J.; Chen, H.; Wei, W.; Xu, C. An online compressor liquid floodback fault diagnosis method for variable refrigerant flow air conditioning system. *Int. J. Refrig.* **2020**, *111*, 9–19. [[CrossRef](#)]
16. Guo, Y.; Li, G.; Chen, H.; Hu, Y.; Li, H.; Liu, J.; Hu, M.; Hu, W. Modularized PCA method combined with expert-based multivariate decoupling for FDD in VRF systems including indoor unit faults. *Appl. Therm. Eng.* **2017**, *115*, 744–755. [[CrossRef](#)]
17. Wang, J.; Li, G.; Chen, H.; Liu, J.; Guo, Y.; Hu, Y.; Li, J. Liquid floodback detection for scroll compressor in a VRF system under heating mode. *Appl. Therm. Eng.* **2017**, *114*, 921–930. [[CrossRef](#)]
18. Liu, J.; Li, G.; Chen, H.; Wang, J.; Guo, Y.; Li, J. A robust online refrigerant charge fault diagnosis strategy for VRF systems based on virtual sensor technique and PCA-EWMA method. *Appl. Therm. Eng.* **2017**, *119*, 233–243. [[CrossRef](#)]
19. Liu, J.; Liu, J.; Chen, H.; Yuan, Y.; Li, Z.; Huang, R. Energy diagnosis of variable refrigerant flow (VRF) systems: Data mining technique and statistical quality control approach. *Energy Build.* **2018**, *175*, 148–162. [[CrossRef](#)]
20. Wang, Y.; Li, Z.; Chen, H.; Zhang, J.; Liu, Q.; Wu, J.; Shen, L. Research on diagnostic strategy for faults in VRF air conditioning system using hybrid data mining methods. *Energy Build.* **2021**, *247*, 111144. [[CrossRef](#)]
21. Zhou, Z.; Li, G.; Wang, J.; Chen, H.; Zhong, H.; Cao, Z. A comparison study of basic data-driven fault diagnosis methods for variable refrigerant flow system. *Energy Build.* **2020**, *224*, 110232. [[CrossRef](#)]
22. Sulaiman, N.A.; Abdullah, M.P.; Abdullah, H.; Zainudin, M.N.S.; Yusop, A.M. Fault detection for air conditioning system using machine learning. *IAES Int. J. Artif. Intell.* **2020**, *9*, 109. [[CrossRef](#)]
23. Jan, S.U.; Lee, Y.D.; Koo, I.S. A distributed sensor-fault detection and diagnosis framework using machine learning. *Inf. Sci.* **2021**, *547*, 777–796. [[CrossRef](#)]
24. Kim, W.; Lee, J.-H. Fault detection and diagnostics analysis of air conditioners using virtual sensors. *Appl. Therm. Eng.* **2021**, *191*, 116848. [[CrossRef](#)]
25. Zhao, Y.; Li, T.; Fan, C.; Lu, J.; Zhang, X.; Zhang, C.; Chen, S. A proactive fault detection and diagnosis method for variable-air-volume terminals in building air conditioning systems. *Energy Build.* **2019**, *183*, 527–537. [[CrossRef](#)]
26. Ranade, A.; Provan, G.; Mady, A.E.-D.; O'Sullivan, D. A computationally efficient method for fault diagnosis of fan-coil unit terminals in building Heating Ventilation and Air Conditioning systems. *J. Build. Eng.* **2020**, *27*, 100955. [[CrossRef](#)]
27. Han, H.; Cao, Z.; Gu, B.; Ren, N. PCA-SVM-based automated fault detection and diagnosis (AFDD) for vapor-compression refrigeration systems. *HoacR Res.* **2010**, *16*, 295–313. [[CrossRef](#)]
28. Hassanpour, H.; Mhaskar, P.; House, J.M.; Salisbury, T.I. A hybrid modeling approach integrating first-principles knowledge with statistical methods for fault detection in HVAC systems. *Comput. Chem. Eng.* **2020**, *142*, 107022. [[CrossRef](#)]

29. Gálvez, A.; Diez-Olivan, A.; Seneviratne, D.; Galar, D. Fault detection and RUL estimation for railway HVAC systems using a hybrid model-based approach. *Sustainability* **2021**, *13*, 6828. [CrossRef]
30. Yan, K.; Ji, Z.; Shen, W. Online fault detection methods for chillers combining extended kalman filter and recursive one-class SVM. *Neurocomputing* **2017**, *228*, 205–212. [CrossRef]
31. Xie, X.; Merino, J.; Moretti, N.; Pauwels, P.; Chang, J.Y.; Parlikad, A. Digital twin enabled fault detection and diagnosis process for building HVAC systems. *Autom. Constr.* **2023**, *146*, 104695. [CrossRef]
32. Wang, L.; Braun, J.; Dahal, S. An evolving learning-based fault detection and diagnosis method: Case study for a passive chilled beam system. *Energy* **2023**, *265*, 126337. [CrossRef]
33. Shen, C.; Zhang, H.; Meng, S.; Li, C. Augmented data driven self-attention deep learning method for imbalanced fault diagnosis of the HVAC chiller. *Eng. Appl. Artif. Intell.* **2023**, *117*, 105540. [CrossRef]
34. Albayati, M.G.; Faraj, J.; Thompson, A.; Patil, P.; Gorthala, R.; Rajasekaran, S. Semi-supervised machine learning for fault detection and diagnosis of a rooftop unit. *Big Data Min. Anal.* **2023**, *6*, 170–184. [CrossRef]
35. Yan, K.; Zhou, X. Chiller faults detection and diagnosis with sensor network and adaptive 1D CNN. *Digit. Commun. Netw.* **2022**, *8*, 531–539. [CrossRef]
36. Bai, X.; Zhang, M.; Jin, Z.; You, Y.; Liang, C. Fault detection and diagnosis for chiller based on feature-recognition model and kernel discriminant analysis. *Sustain. Cities Soc.* **2022**, *79*, 103708. [CrossRef]
37. Li, W.; Gong, G.; Fan, H.; Peng, P.; Chun, L. Meta-learning strategy based on user preferences and a machine recommendation system for real-time cooling load and COP forecasting. *Appl. Energy* **2020**, *270*, 115144. [CrossRef]
38. Anka, S.K.; Mensah, K.; Boahen, S.; Ohm, T.I.; Cho, Y.; Choi, J.W.; Choo, S.H.; Kim, H.-Y.; Choi, J.M. Performance optimization of an air source HVAC system for an internet data center building using the integrated COP method. *J. Build. Eng.* **2022**, *61*, 105308. [CrossRef]
39. Wang, J.; Sun, J.; Ge, W.; Zhang, F.; Gao, R.X. Virtual Sensing for Online Fault Diagnosis of Heat Exchangers. *IEEE Trans. Instrum. Meas.* **2022**, *71*, 9508708. [CrossRef]
40. Paepae, T.; Bokoro, P.N.; Kyamakya, K. From fully physical to virtual sensing for water quality assessment: A comprehensive review of the relevant state-of-the-art. *Sensors* **2021**, *21*, 6971. [CrossRef] [PubMed]
41. Lin, L.; Guan, X.; Peng, Y.; Wang, N.; Maharjan, S.; Ohtsuki, T. Deep reinforcement learning for economic dispatch of virtual power plant in internet of energy. *IEEE Internet Things J.* **2020**, *7*, 6288–6301. [CrossRef]
42. Chen, J.; Zhang, L.; Li, Y.; Shi, Y.; Gao, X.; Hu, Y. A review of computing-based automated fault detection and diagnosis of heating, ventilation and air conditioning systems. *Renew. Sustain. Energy Rev.* **2022**, *161*, 112395. [CrossRef]
43. Elkhoukhi, H.; Bakhouya, M.; Hanifi, M.; El Ouadghiri, D. On the use of deep learning approaches for occupancy prediction in energy efficient buildings. In Proceedings of the 2019 7th International Renewable and Sustainable Energy Conference (IRSEC), Agadir, Morocco, 27–30 November 2019; pp. 1–6.
44. Weigert, A. Identification and classification of heat pump problems in the field and their implication for a user-centric problem recognition. *Energy Inform.* **2022**, *5*, 70. [CrossRef]
45. Rains, T. Home Repair Statistics by State. Available online: <https://www.consumeraffairs.com/homeowners/home-repair-statistics.html#heating-repairs-by-state> (accessed on 3 May 2023).
46. Bellanco, I.; Fuentes, E.; Vallès, M.; Salom, J. A review of the fault behavior of heat pumps and measurements, detection and diagnosis methods including virtual sensors. *J. Build. Eng.* **2021**, *39*, 102254. [CrossRef]
47. Madani, H. The common and costly faults in heat pump systems. *Energy Procedia* **2014**, *61*, 1803–1806. [CrossRef]
48. Aguilera, J.J.; Meesenburg, W.; Ommen, T.; Markussen, W.B.; Poulsen, J.L.; Zühlsdorf, B.; Elmegaard, B. A review of common faults in large-scale heat pumps. *Renew. Sustain. Energy Rev.* **2022**, *168*, 112826. [CrossRef]
49. Madani, H.; Roccatello, E. A comprehensive study on the important faults in heat pump system during the warranty period. *Int. J. Refrig.* **2014**, *48*, 19–25. [CrossRef]
50. Boahen, S.; Lee, K.H.; Choi, J.M. Refrigerant charge fault detection and diagnosis algorithm for water-to-water heat pump unit. *Energies* **2019**, *12*, 545. [CrossRef]
51. Katipamula, S.; Brambley, M.R. Methods for fault detection, diagnostics, and prognostics for building systems—A review, part I. *HvacR Res.* **2005**, *11*, 3–25. [CrossRef]
52. Yang, H.; Zhang, T.; Li, H.; Woradechjumroen, D.; Liu, X. HVAC equipment, unitary: Fault detection and diagnosis. In *Encyclopedia of Energy Engineering and Technology*, 2nd ed.; CRC Press: Boca Raton, FL, USA, 2014; pp. 854–864.
53. Muller, T.; Réhault, N.; Rist, T. A Qualitive Modeling Approach for Fault Detection and Diagnosis on HVAC Systems. In Proceedings of the 13th International Conference for Enhanced Building Operations, Montreal, QC, Canada, 8–11 October 2013.
54. Zhao, Y.; Li, T.; Zhang, X.; Zhang, C. Artificial intelligence-based fault detection and diagnosis methods for building energy systems: Advantages, challenges and the future. *Renew. Sustain. Energy Rev.* **2019**, *109*, 85–101. [CrossRef]
55. Dey, M.; Rana, S.P.; Dudley, S. A case study based approach for remote fault detection using multi-level machine learning in a smart building. *Smart Cities* **2020**, *3*, 401–419. [CrossRef]
56. Fan, C.; Liu, Y.; Liu, X.; Sun, Y.; Wang, J. A study on semi-supervised learning in enhancing performance of AHU unseen fault detection with limited labeled data. *Sustain. Cities Soc.* **2021**, *70*, 102874. [CrossRef]
57. Wang, T.; Qiao, M.; Zhang, M.; Yang, Y.; Snoussi, H. Data-driven prognostic method based on self-supervised learning approaches for fault detection. *J. Intell. Manuf.* **2020**, *31*, 1611–1619. [CrossRef]

58. Singh, V.; Mathur, J.; Bhatia, A. A Comprehensive Review: Fault Detection, Diagnostics, Prognostics, and Fault Modelling in HVAC Systems. *Int. J. Refrig.* **2022**, *144*, 283–295. [[CrossRef](#)]
59. Shi, Z.; O'Brien, W. Development and implementation of automated fault detection and diagnostics for building systems: A review. *Autom. Constr.* **2019**, *104*, 215–229. [[CrossRef](#)]
60. Mirmaghi, M.S.; Haghighat, F. Fault detection and diagnosis of large-scale HVAC systems in buildings using data-driven methods: A comprehensive review. *Energy Build.* **2020**, *229*, 110492. [[CrossRef](#)]
61. Mulumba, T.; Afshari, A.; Yan, K.; Shen, W.; Norford, L.K. Robust model-based fault diagnosis for air handling units. *Energy Build.* **2015**, *86*, 698–707. [[CrossRef](#)]
62. Arlington. Performance Rating of Unitary Air-Conditioning & Air-Source Heat Pump Equipment. AHRI Standard 210/240-2017, Air-Conditioning & Refrigerant Institute. Available online: <https://www.ahrinet.org/search-standards/ahri-210240-2017-performance-rating-unitary-air-conditioning-air-source-heat-pump> (accessed on 1 April 2023).
63. Laknizi, A.; Mahdaoui, M.; Abdellah, A.B.; Anoune, K.; Bakhouya, M.; Ezbakhe, H. Performance analysis and optimal parameters of a direct evaporative pad cooling system under the climate conditions of Morocco. *Case Stud. Therm. Eng.* **2019**, *13*, 100362. [[CrossRef](#)]
64. Laknizi, A.; Ben Abdellah, A.; Mahdaoui, M.; Anoune, K. Application of Taguchi and ANOVA methods in the optimisation of a direct evaporative cooling pad. *Int. J. Sustain. Eng.* **2021**, *14*, 1218–1228. [[CrossRef](#)]
65. Mohammadi, H.; Ghardallou, W.; Mili, A. Assume, capture, verify, establish: Ingredients for scalable software analysis. In Proceedings of the 2021 IEEE 21st International Conference on Software Quality, Reliability and Security Companion (QRS-C), Hainan, China, 6–10 December 2021; pp. 415–424.
66. Mohammadi, H.; Ghardallou, W.; Linger, R.C.; Mili, A. Computing program functions. In Proceedings of the IEEE/ACM 10th International Conference on Formal Methods in Software Engineering, Pittsburgh, PA, USA, 22–23 May 2022; pp. 102–112.

Disclaimer/Publisher's Note: The statements, opinions and data contained in all publications are solely those of the individual author(s) and contributor(s) and not of MDPI and/or the editor(s). MDPI and/or the editor(s) disclaim responsibility for any injury to people or property resulting from any ideas, methods, instructions or products referred to in the content.