



HAL
open science

A Review-Durability, Mechanical and Hygrothermal Behavior of Building Materials Incorporating Biomass

Houssam Affan, Badreddine El Haddaji, Soukaina Ajouguim, Fouzia Khadraoui

► **To cite this version:**

Houssam Affan, Badreddine El Haddaji, Soukaina Ajouguim, Fouzia Khadraoui. A Review-Durability, Mechanical and Hygrothermal Behavior of Building Materials Incorporating Biomass. Eng, 2024, 5 (2), pp.992-1027. 10.3390/eng5020055 . hal-04605557

HAL Id: hal-04605557

<https://hal.science/hal-04605557v1>

Submitted on 8 Nov 2024

HAL is a multi-disciplinary open access archive for the deposit and dissemination of scientific research documents, whether they are published or not. The documents may come from teaching and research institutions in France or abroad, or from public or private research centers.



L'archive ouverte pluridisciplinaire **HAL**, est destinée au dépôt et à la diffusion de documents scientifiques de niveau recherche, publiés ou non, émanant des établissements d'enseignement et de recherche français ou étrangers, des laboratoires publics ou privés.



Distributed under a Creative Commons Attribution 4.0 International License

Review

A Review—Durability, Mechanical and Hygrothermal Behavior of Building Materials Incorporating Biomass

Houssam Affan ^{1,*}, Badreddine El Haddaji ^{1,2,3}, Soukaina Ajouguim ¹ and Fouzia Khadraoui ¹

¹ Builders Lab, Builders École d'Ingénieurs, COMUE Normandie Université, 1 Rue Pierre et 6 Marie Curie, 14610 Épron, France; badreddine.el-haddaji@builders-ingenieurs.fr (B.E.H.); soukaina.ajouguim@builders-ingenieurs.fr (S.A.); fouzia.khadraoui-mehir@builders-ingenieurs.fr (F.K.)

² École Supérieure d'Ingénieurs des Travaux de la Construction (ESITC-Paris), 94110 Arcueil, France

³ Institut de Recherche de l'ESTP, École Spéciale des Travaux Publics, 28 Avenue du Président Wilson, 94234 Cachan, France

* Correspondence: houssam.affan@builders-ingenieurs.fr

Abstract: The growing importance of environmental efficiency in reducing carbon emissions has prompted scientists around the world to intensify their efforts to prevent the destructive effects of a changing climate and a warming planet. Global carbon emissions rose by more than 40% in 2021, leading to significant variations in the planet's weather patterns. Nevertheless, a significant proportion of natural resources continue to be exploited. To prepare for this challenge, it is essential to implement a sustainable approach in the construction industry. Biobased materials are made primarily from renewable raw materials like hemp, straw, miscanthus, and jute. These new materials provide excellent thermal and acoustic performance and make optimum use of local natural resources such as agricultural waste. Nowadays, cement is one of the most important construction materials. In an attempt to meet this exciting challenge, biobased materials with low-carbon binders are one of the proposed solutions to create a more insulating and less polluting material. The aim of this review is to investigate and to analyze the impact of the incorporation of different types of biobased materials on the mechanical, thermal, and hygric performance of a mix using different types of binder.

Keywords: building materials; biomass; biobased insulation; hygrothermal characterization; mechanical characterization; durability



Citation: Affan, H.; El Haddaji, B.; Ajouguim, S.; Khadraoui, F. A Review—Durability, Mechanical and Hygrothermal Behavior of Building Materials Incorporating Biomass. *Eng* **2024**, *5*, 992–1027. <https://doi.org/10.3390/eng5020055>

Academic Editor: Antonio Gil Bravo and Reza Rezaee

Received: 29 March 2024

Revised: 24 May 2024

Accepted: 27 May 2024

Published: 1 June 2024



Copyright: © 2024 by the authors. Licensee MDPI, Basel, Switzerland. This article is an open access article distributed under the terms and conditions of the Creative Commons Attribution (CC BY) license (<https://creativecommons.org/licenses/by/4.0/>).

1. Introduction

The production of concrete consumes a large quantity of resources and energy [1]. The reuse of industry by-products and recyclable materials represents an interesting approach to improve the sustainability of cementitious materials. It should be noted that the construction sector accounts for 40% of the world's energy consumption, much of it dedicated to heating [2]. In France, the residential building sector is responsible for 45% of total energy demand and 21% of CO₂ emissions [3]. The construction industry must, therefore, urgently address the issue of reducing greenhouse gas emissions and promote the use of energy-efficient and environmentally friendly building materials [4–6], with the additional task of limiting vulnerability to toxic fuels. In addition, a significant pattern has been established between energy consumption and symptoms caused by “unhealthy building conditions”, particularly allergies, demonstrating the necessity of a healthier approach [7]. The decrease in climate change is a primary objective for many UN organizations. The renewed global urban policy platform at the United Nations Habitat III conference in Quito (Ecuador) in October 2016 was primarily focused on the environmental sustainability and low carbon consumption of the built environment as a way of enhancing sustainable livelihoods and addressing the challenge of climate change [8].

As a result, the need for eco-friendly buildings will grow significantly in the years ahead. The eco-building community recognizes “green” building as a “building that, in

its conception, the construction or the exploitation, decreases or avoids the impact, and may decrease the impact, on the climate and the environment" [9]. Recent advances in eco-friendly building concepts incorporate both active and passive technology to increase the energy performance of buildings.

Nowadays, agricultural and industrial waste is being used to produce binders and aggregates in order to reduce the use of natural resources [1]. Another example is the broad range of natural fiber applications [10,11] that have been successfully developed for the ecological construction field [12,13]. Current comfort standards and comfort performance characteristics do not need to be called into question with these wastes [3]. These wastes are made of fibers that are widely used in fiber-reinforced cement components [1,14,15].

This review provides a comprehensive investigation of the characteristics of hydraulic binder components reinforced with natural fibers, along with perspectives for further research. Initially, it presents natural fibers used in hydraulic binder composites, detailing their physical and mechanical properties. It then explores the effects of natural fibers on various aspects, including the physical, mechanical, and hygroscopic properties, as well as the durability of hydraulic materials containing natural fibers.

2. The Use of Biomass Fibers in Building Materials

2.1. Retrospective on the Use of Biomass Fibers in Concrete

In 1910, a series of tests aimed at improving the strength of concrete was carried out by J. Porter [16], who concluded that the presence of short metal fibers in concrete increases its crushing and tensile strength. Later, Graham established a patent on fiber-reinforced concrete. This was the first U.S. patent in which the use of steel plates as fibrous reinforcements in building materials was described. A second U.S. patent on this subject was taken out by Weakly et al., 1912 [17], who studied the use of steel wire strips composed of two wires, with the intermediary of a ring, to ensure lasting adhesion with concrete.

Since the 1970s, there has been a kind of awakening in steel fiber-reinforced concrete technology. Confidence in the specific properties of steel fiber-reinforced concrete is growing steadily as these concretes are used in industrial applications. The first paper on this concept was attributed to Lankard. In this article, he confirmed that the addition of 1% to 2% fiber to refractory concrete gives a significant improvement in strength [18].

The high carbon emission and expensive cost of the synthetic fibers, as well as the amount of fiber waste available, limit their use. For these reasons, natural fibers are an efficient and cost-effective replacement for synthetic fibers, with lower environmental impact. Figure 1 shows how construction has moved from conventional composites to green composites.

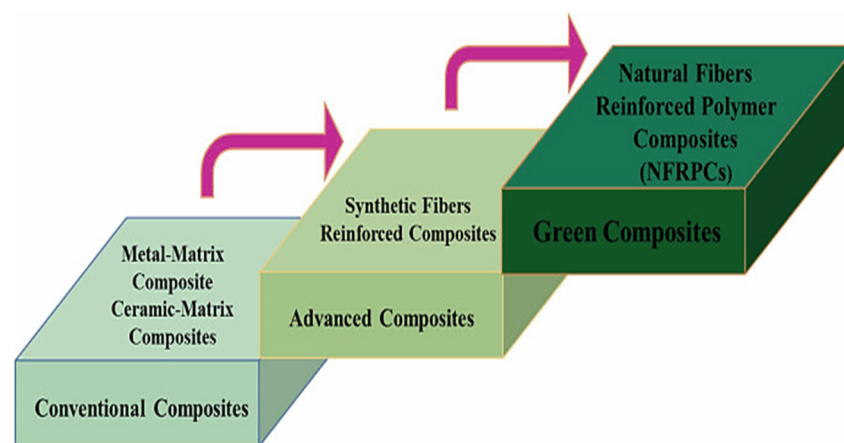

Figure 1. Evolution of the use of metal and ceramic fibers towards synthetic fibers and now towards natural fibers [18].

Natural fibers such as sunflower [19], hemp, flax, abaca, kenaf, bamboo, jute, bagasse, date palm, and pineapple leaf are used to make cement composites stronger because of their properties like cost-effectiveness, having a wide range of mechanical performances, durability, easy production, biodegradability, and good physical and thermal performances [20,21].

Biobased materials have advantages and disadvantages in terms of the physical, mechanical, thermal, and hydric properties of concrete [22,23]. Table 1 shows the mechanical properties of various plant-based materials. Table 2 shows the advantages and disadvantages of biobased materials. Figure 2 shows the difference in the carbon footprint between four different biomasses: hemp, flax, jute, and kenaf. These materials are the most widely used, thanks to their mechanical, thermal, and hydric properties.

Table 1. Description and comparison of 5 mechanical properties of 11 different biobased materials [24].

Plant Fiber	Tensile Strength (MPa)	Young's Modulus (GPa)	Specific Modulus (GPa)	Failure Strain (%)	Density (kg/m ³)	Water Content (eq.) (%)
Cotton	300–700	6–10	4–6.5	6–8	1550	8.5
Kapok	93.3	4	12.9	1.2	311–384	10.9
Bamboo	575	27	18	-	1500	-
Flax	500–900	50–70	34–48	1.3–3.3	1400–1500	12
Hemp	310–750	30–60	20–41	2–4	1400–1500	12
Jute	200–450	20–55	14–39	2–3	1300–1500	12
Kenaf	295–1191	22–60	-	-	1220–1400	17
Ramie	915	23	15	3.7	1550	8.5
Abaca	12	41	-	3.4	1500	14
Sisal	80–840	9–22	6–15	2–14	1300–1500	11
Coir	106–175	6	5.2	15–40	1150–1250	13

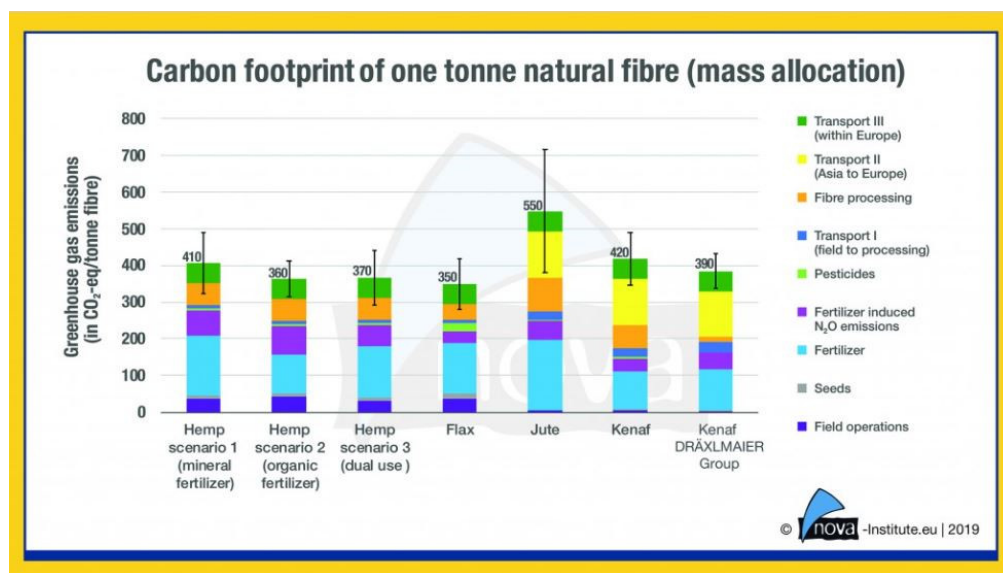

Figure 2. Comparing the carbon footprints of natural fibers of 4 different natural fibers: hemp, flax, jute, and kenaf [24].

The global population is growing, as are living standards. Consequently, consumption of energy, emissions of carbon, and production of waste have been increasing globally. In order to find an alternative, numerous researchers have decided to replace or supplement the use of cementitious materials with a natural fiber. Biobased materials (sugar palm,

pineapple, hemp, jute, kenaf, areca, banana, bamboo, sisal) that are frequently used in construction are shown in Figure 3.

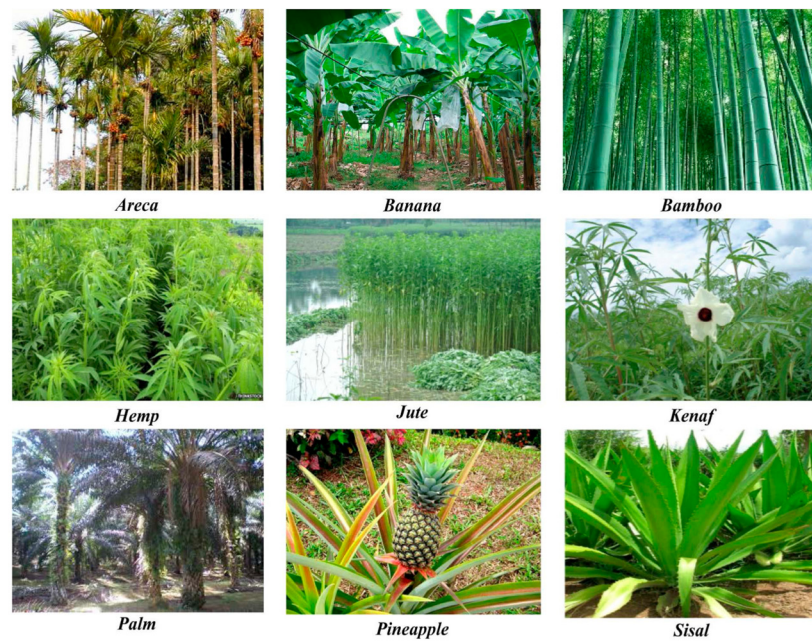

Figure 3. Examples of several natural fibers currently used in the construction field [25].

Biobased materials are becoming increasingly popular in the construction sector because of their excellent mechanical, thermal, and hydric properties. Furthermore, their abundant availability in nature and ease of cultivation makes them attractive resources [26]. Hemp and flax shives are more used, but the biobased used is not limited to these two types. Other materials such as kenaf, sisal, jute, flax, loofah, palm, and wheat are also used, and researchers have even explored the use of brown and red algae in this field [27].

Table 2. Advantages and drawbacks of the use of natural fiber as a construction material [28].

Advantages	Drawbacks
<ul style="list-style-type: none"> • Low specific weight, high specific resistance, and high rigidity. • Fibers are a sustainable resource, production of which demands low levels of energy and involves the absorption of CO₂, while giving oxygen back to the environment. • Fibers may be produced at a lower cost than that of synthetic fibers. • Low levels of toxic fume emission when heated and when incinerated at end-of-life. • Reduced equipment abrasion damage compared to composites based on synthetic fibers. 	<ul style="list-style-type: none"> • Durability less than for synthetic fiber composites, although it can be considerably improved with further treatment. • High absorption of moisture, which causes swelling. • Weaker resistance, in particular impact resistance, compared with composites based on synthetic fibers. • Greater variability in properties. • Reduced treatment temperatures, limiting matrix features.

2.2. Hemp and Flax Plants in Focus

- Hemp plant

Hemp is the generic name given to the high-growth varieties of cannabis sativa, a previously sidelined plant with many applications that is becoming increasingly popular among professionals and entrepreneurs [23].

The plant is estimated to have around 25,000 useful usages [29,30]. Its use is steadily increasing in many areas, such as the textile industry, construction, paper, etc. Hemp (Cannabis Sativa) is an annual plant with palmate leaves grown for its stalk. Hemp

cultivation provides two materials used in civil engineering. After drying and mechanical treatment (defibration or scutching), the stalk is broken down into hemp shives, the granular form of hemp (65–70% of the stalk mass), and filasse or tow, the fibrous form of hemp (30–35% of the stalk mass) [31]. Figure 4 shows the hemp plant in the wild.



Figure 4. Hemp thrives in the wild [32].

Hemp shives (Figure 4) come in the form of small, short sticks measuring from a few millimeters to a few centimeters in length, derived from the stem's bark. These are collected from parallel channels that allow sap to circulate within the plant and contain air when the stem is dry. These morphological characteristics give hemp shive a high porosity, which implies high water sensitivity, low density, and high acoustic and thermal performance [31]. In this context, the addition of biobased materials is an interesting proposition, as they are known for their insulating properties [33–36] and, on the other side, they offer possibilities for recycling naturally occurring waste and protecting the environment [37–39].

Many studies have been carried out on hemp shives [40–46] that can be applied to biobased building materials like hemp concrete [41,47,48]. This insulated material is formed from hemp shives mixed with a binder (lime) and water [49]. Life-cycle assessment of hemp concrete has demonstrated a low carbon footprint and low embodied energy. In addition, researchers [35,41,49,50] have shown that both hemp panels and hemp concrete offer a good insulating material with highly promising physical and hygrothermal properties. Its porous structure and lower density decrease thermal conductivity down to 0.1 W/(mK) in comparison to traditional materials like Portland cement concrete, bricks, and blocks. The overall thermal conductivity of building materials improves with a rising binder ratio. Figure 5 shows hemp shives in bulk with a maximum diameter of 1 cm. The chemical properties of hemp shives are shown in Table 3. The mechanical, thermal, and hydric properties of hemp shives are shown in Table 4.



Figure 5. Hemp shives in bulk with a diameter of 1 cm [50].

Table 3. Chemical composition of hemp shives cited in several studies.

Material	References	Cellulose	Hemicellulose	Lignin	Pectin	Others	Wax
Hemp Shives	[24]	70.2–74.4	17.9–22.4	3.5–5.7	0.9	6.1	0.8
	[51]	44%	18%	28%	4%	3%	1%
	[52]	50–60%	15–20%	30–30%	-	4–5%	-
	[53]	34–44%	31–37%	19–28%	4%	1–2%	1%
	[54]	50–60%	15–20%	20–30%	-	4–5%	-

Table 4. Mechanical, thermal, hydric properties of hemp shives.

Mixture	Bulk Density (kg/m ³)	Water Absorption (%)	Thermal Cond. (W·m ⁻¹ ·K ⁻¹)	Ref.
Hemp shives	140	247%	0.05–0.06	[55,56]

- Flax plant

Flax (*Linum usitatissimum*) is a member of the Linaceae family and of the *Linum* genus, which comprises over two hundred species [57]. The most widespread flax plant is called *Linum usitatissimum*. The plant consists of a stem and a small blue flower at its end. It possesses extended fibers running through its entire length, contributing to its stiffness. Flax plants thriving in the wild are shown in Figure 6.

**Figure 6.** Flax thrives in the wild [58].

One of the plant particles used is flax shives [39,59,60], which offer poor thermal conductivity. In fact, flax concrete, consisting of flax shives, binder (mainly lime), and water, shows a high absorption capacity of around two to three times its weight in 48 h. This is mainly due to its pores' organization in parallel capillaries [38,39] and the presence of a non-cellulosic component [61–63]. Rahim et al. [64] have compared the moisture performance of flax and hemp concretes. They confirmed that flax concrete has a high moisture efficiency with excellent moisture buffering capacity.

Flax fiber, like all types of plant fiber, has good thermal properties. These fibers are used in industry to manufacture insulating materials. Flax fiber has a thermal conductivity of between 0.037 and 0.040 W·m⁻¹·k⁻¹ for fibers, with a bulk density of 1.38 g/cm³ [65]. In terms of acoustic insulation, flax is particularly effective against airborne noise. It achieves an attenuation of around 55 dB [66]. Flax fiber is highly prized in the textile and automotive industries, thanks to its specific mechanical properties. However, flax fiber has several disadvantages that may reduce its use. One of these is the wide dispersion of its mechanical properties, which depend, among other things, on the variety of the plant and its origin.

The chemical properties of flax shives are shown in Table 5. The mechanical, thermal, and hydric properties of hemp shives are shown in Table 6.

Table 5. Chemical composition of flax shives, cited in several studies.

Material	References	Cellulose	Hemicellulose	Lignin	Pectin	Others	Wax
Flax Shives	[61]	43 ± 1.3	19.5 ± 0.7	32.3 ± 1.7	-	5.2 ± 0.2	-
	[62]	38 ± 0.5	25 ± 0.5	31.2	-	1.7	0.4
	[63]	53	13	24	-	2–8	-

Table 6. Mechanical, thermal, hydric properties of flax shives.

Mixture	Bulk Density (kg/m ³)	Water Absorption (%)	Thermal cond. (W·m ⁻¹ ·K ⁻¹)	Ref.
Flax shives	260–540	200–300%	0.057–0.064	[67–70]

2.3. Promising New Plants Used as Biomass in Building Materials

Biobased materials are being increasingly used in the construction sector. Hemp, flax, jute, and kenaf are currently being used [71]. Researchers have been using these biobased materials in mixtures with different binders (earth, lime, traditional cement. . .). Certain natural fibers are not widely used in the construction field. In the following paragraph, the mechanical, thermal, and hygroscopic properties of four different natural fibers, palm, loofah, miscanthus, and seaweed are presented.

- Seaweed

Algae are divided into three main groups: green algae, red algae, and brown algae [72].

- Green algae cannot be used in the construction field because of the emission of H₂S gas [73,74].
- Red algae were used in a conventional cement-based mixture in a single study and only their mechanical properties were studied [75].
- Brown seaweed in various forms (powder and fibers) is used in mixtures based on silty and clayey soils. The mechanical, thermal, and hydric properties have been studied in a mixture of brown seaweed (*Sargassum muticum*) and loamy soil [27,76].

Seaweed is known for its hygrothermal properties. The presence of algae in an earth-based or cement-based mixture makes the mixture more thermally and water-insulating but mechanically weaker [27,76]. Figure 7 shows a type of brown seaweed: (a) material collected from the sea, (b) fiber after washing, (c) fiber after being dried for 24 h in an oven at 40 °C.

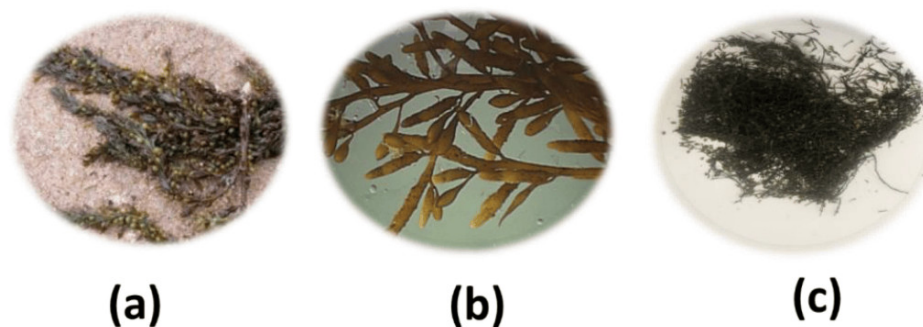

Figure 7. *Sargassum muticum*. (a) Collection; (b) washing; and (c) drying, with color change [27].

- Date palm

Few studies have been carried out on the use of this natural fiber in construction. Benmansour et al. [77] examined the use of this natural fiber with natural prompt cement

(Figure 8), the results of which demonstrated that the incorporation of date palm increased the thermal performance and water absorption capacities of the material. Nevertheless, the density and compressive strength of the composite decreased considerably.



Figure 8. Date palm fiber with two different dimensions, DPF 3 (3 mm) and DPF 6 (6 mm) [77].

- **Miscanthus**

Miscanthus (*x giganteus*) is a biomass-based perennial crop widely grown in Europe for its very efficient use of water, nitrogen, and sunlight [78–80]. Miscanthus is considered to be a strong, sufficiently firm fiber with excellent thermal insulation properties, compared with other natural fibers such as straw, hemp, etc. [81]. Miscanthus is widely used as a natural fiber for lightweight biobased concrete, thanks to its light, porous properties [82,83].

While miscanthus fibers are coated in a confined environment after application to concrete, the alkaline environment has a solvent impact on the cellulosic constituents of miscanthus fibers, which could impact the mechanical strength and the dimensional stability of the miscanthus contained in the cement matrix.

Previous research shows that a concrete alkaline environment could reduce the sugar content present in miscanthus [84]. Miscanthus fiber has a high affinity with water and a high water absorption capacity, which influences the fibers' behavior. Indeed, the fibers' water absorption leads to fiber swelling/shrinkage, which leads to a fiber dimensional variation, and as result, the biobased miscanthus concrete's durability is significantly affected. Figure 9 shows (a) raw miscanthus, (b) miscanthus powder, and (c) heat-treated miscanthus.

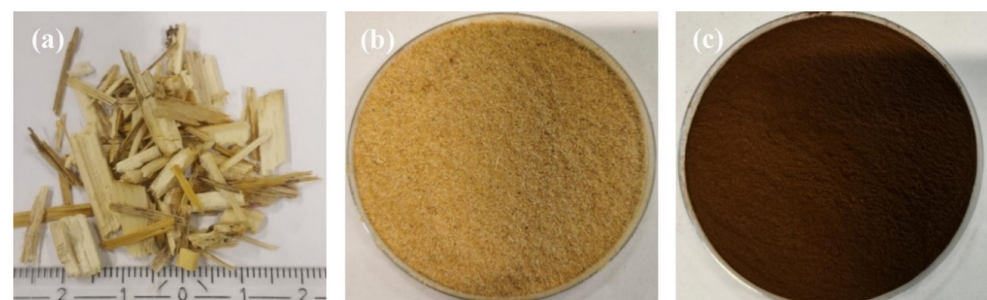

Figure 9. (a) Raw miscanthus, (b) miscanthus powder, and (c) heat-treated miscanthus [85].

Table 7 is a summary of all the mechanical, thermal, and hydric properties of 13 different biomass materials. Plant-based materials are increasingly used in the construction industry. Hemp, flax, jute, rapeseed, and sunflower are commonly used. Several researchers have used these materials in mixtures with earth, lime, traditional cement, or natural prompt cement. The durability of miscanthus concrete is influenced by the presence of cellulose and hemicellulose in higher percentages compared to other natural fibers such

as oak wood and flax fibers. This difference in percentage grants miscanthus a longer setting time than the maximum mechanical resistance achieved. The durability refers to the following phenomena:

- Absorption of water by the fibers can lead to an increase in their volume, and during freezing conditions, this can cause more frequent and intense freeze/thaw cycles. These cycles can create microcracks in the concrete matrix, thereby reducing durability by accelerating material degradation. Additionally, when the fibers absorb water and swell, they can exert internal stresses on the cement matrix. This stress can lead to the rupture or microcracking of the matrix, decreasing the overall strength of the concrete.
- Furthermore, the swelling and shrinking of the fibers due to water absorption and desorption can cause dimensional variations in the concrete.
- These variations can induce internal stresses, leading to the formation of cracks. These cracks can then propagate and widen under mechanical loads or thermal cycles, further compromising the durability of the concrete.

Table 7. Summary of mechanical, thermal, and hydric properties of 13 different biomasses.

Plant Fiber	Tensile Strength (MPa)	Young's Modulus (GPa)	Specific Modulus (GPa)	Failure Strain (%)	Density (kg/m ³)	Moisture Content (eq.) (%)
Cotton	300–700	6–10	4–6.5	6–8	1550	8.5
Kapok	93.3	4	12.9	1.2	311–384	10.9
Bamboo	575	27	18	-	1500	-
Flax	500–900	50–70	34–48	1.3–3.3	1400–1500	12
Hemp	310–750	30–60	20–41	2–4	1400–1500	12
Jute	200–450	20–55	14–39	2–3	1300–1500	12
Kenaf	295–1191	22–60	-	-	1220–1400	17
Ramie	915	23	15	3.7	1550	8.5
Abaca	12	41	-	3.4	1500	14
Banana	529–914	27–32	20–24	1–3	1300–1350	-
Pineapple	413–1627	60–82	42–57	0–1.6	1440–1560	-
Sisal	80–840	9–22	6–15	2–14	1300–1500	11
Coir	106–175	6	5.2	15–40	1150–1250	13

3. Physical Properties of Building Materials Incorporating Biomass

The characteristics of fiber-reinforced concrete are intimately related to the mechanical and physical properties of natural fiber. In all cases, natural fiber is required for internal curing, whose performance is largely influenced by the characteristics of the natural fiber. Owing to its unique nature and constituents, hemp concrete exhibits behavior different from that of traditional construction materials like cement blocks, bricks, cellular cement, and so forth.

3.1. Bulk Density

The density of a material, as indicated by Ohmura et al. (2002) [86], is defined by the specific spatial orientation of the product within the volume. In the hemp concrete case, the content of the material and the fabrication process are both modified. As a result, the density changes, and this parameter is also strongly influenced by the compaction process. Indeed, it appears that in hemp concrete, higher density correlates with greater strength. Additionally, the amount of moisture retained within the wall does influence density, albeit to a lesser degree.

The density of hemp-based concretes varies according to several factors, such as the proportions of the ingredients used and the manufacturing method. The specific gravity of

hemp shives is considerably less than that of standard aggregate concrete. This means that hemp concrete has a much lower density than ordinary concrete. Conventional concrete most probably has a density of 2200–2400 kg/m³. Normal concrete is a lightweight product with a density of approximately 200 to 600 kg/m³, according to [87]. Figure 10 shows the variation in volumetric mass with respect to the mass percentages of added fibers.

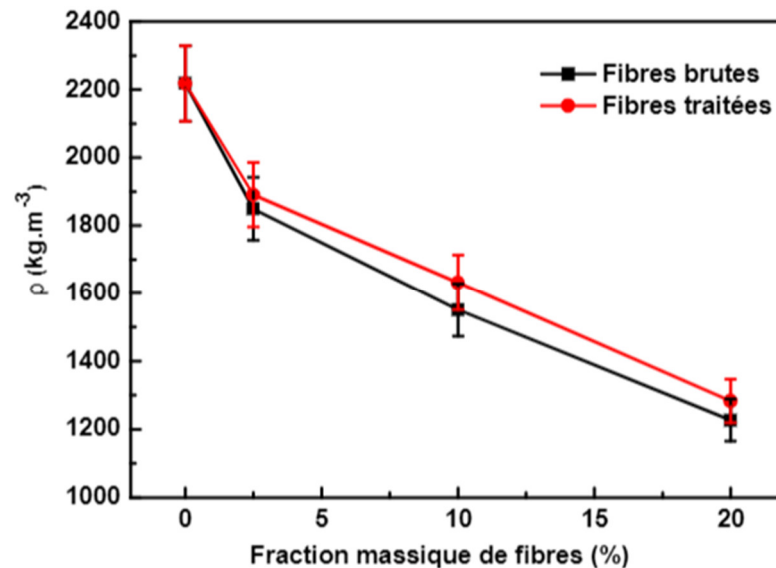

Figure 10. Variation in density with respect to the mass percentages of palm waste fibers [88].

3.2. Porosity

A mixture of hemp (with 50% of the binder mass) and air lime (mixture density around 400 kg/m³) allows a porosity of over 70%. In addition to the mesopores (0.1–1 mm) within the shives and in their contact area with the binder, the mortar also has micropores between the hydrates of the binder matrix and macropores (of around 1 cm) in the arrangement of the particles of the plant aggregate [89].

In fact, the density of flax concrete using the conventional formulation (water-to-binder (W/B) ratio of 0.42 and fiber-to-binder (F/B) ratio of 1.45) is 550 kg/m³ [69]. This characteristic makes flax concrete a light, porous material for use in construction. The average porosity of the flax concretes used is between 72% and 76%. These values are close to the porosity of hemp concrete reported in the literature [62,69,90]. However, a small improvement in flax concrete porosity was observed as a function of flax shives content. The percentage of open porosity is measured following this equation:

$$Pa = \frac{M_{air} - M_{dry}}{M_{air} - M_{water}}$$

The variable “*Pa*” represents the water-accessible porosity in percentage. Other terms include “*M_{air}*” for the sample mass after air saturation in [kg], “*M_{water}*” for the mass of the sample saturated and immersed in water in [kg], and finally, “*M_{dry}*” for the mass of the dry sample, obtained after drying at 60 °C with mass monitoring, also measured in [kg] [91].

4. Mechanical Properties of Building Materials Incorporating Biomass

Compressive strengths of typical 2:1 mixes (binder/hemp by weight) range from 0.2 to 1.2 MPa [92–96] and are primarily a function of density, binder type, and age. Likewise, bending strength is low; resistance values of between 0.06 and 0.12 MPa have been determined [94,97–99]. The low mechanical strength of hemp concretes compared to concrete with natural aggregates is generally explained by their high porosity. Nguyen (2010) estimates that high shive porosity makes the concrete’s mechanical strength lower

than that of other low-weight concretes [98,100]. Bouloc et al. (2006) show that the weak performance of hemp concrete is attributable to the lack of cohesion of the hemp fibers and their irregular arrangement [101].

Reducing the volume of voids requires greater compaction of the concrete in order to achieve a durable concrete. The void volume can also be reduced by adding smaller aggregates or reducing the average particle length. This improves compressive strength [102–104], although more binder is required to keep the smaller-sized materials together. The smaller aggregates may also increase the risk of setting and binder hardening problems caused by the emission of polysaccharides [96,105]. The variations in particle size have improved the compressive strength of the organic binders [50] and mineral binders [106]. Formulations and pre-treatments adapted to the plants can also improve the performance of hemp concrete [105,107] by reducing problems of setting.

Mechanical strength can also be enhanced by adding more binder [108]. According to researchers [109], compacting increases the compressive strength of hemp concrete significantly. This approach improves not only the mechanical strength of the material by using less binder, but also improves its capacity to resist deformation before fracture [99]. The experts believe there is a correlation linking density, compressive strength, and compaction. They noted that a mix with higher density had higher compressive strengths, showing a connection of density with compaction.

Evrard [110] created hemp concrete mixes with compressive strengths between 0.2 and 0.5 MPa. Arnaud et al. [111] found values varying from 0.4 MPa to 1.2 MPa at 28 days of cure. O'Dowd and Quinn [112] reported hemp concretes with compressive strengths between 0.65 and 1.9 MPa at 28 days. Following Jami et al. [113], the properties and ratio of the binder used in the formulation will determine the strength of the cured hemp concrete.

The enhancement in the hydraulic properties of the binder leads to early strength development. Cigasova et al. [114] studied hemp concrete using an MgO-based binder. The experimental mixtures comprised a 40% volume of hemp hurds, MgO-cement, and a 31% volume of water. The study investigated the effects of hardening time on mechanical (compressive strength) and physical properties (density, thermal conductivity, water absorption) of the composites. Conclusions drawn include that hardening time significantly affects bio-composite properties; longer hardening times result in them having a compressive strength of around 2 MPa at 28 days.

With a typical bulk density of 250–660 kg/m³, hemp concretes with various lime-based formulations have shown compressive strengths of between 0.25 and 1.15 MPa with a matching elastic modulus of between 4 and 160 MPa [100]. The calculation of the optimum binder content is a major factor in achieving strong hemp concrete [108].

The compressive strengths of two different types of binders with three different percentages of hemp shives (10%, 50%, and 90%) for ages ranging from 7 days to 90 days were measured by Walker et al. [115]. In addition, it can be remarked that the formulations manufactured with air lime with 10% of the hemp shives reached a maximum of 2.5 MPa at 90 days, whereas those manufactured with air lime reached a maximum value eight times higher at the same age. The results consistently show that formulations containing 50% and 90% hemp shives (by weight), produced with Tradical PF 70 (75% lime, 15% hydraulic binder, and 10% pozzolanic), exhibit greater compressive strength compared to those manufactured with air lime. The compressive strength decreases with the increasing percentage of added hemp shives. Figure 11 shows the difference in compressive strength for these two types of binder with three different percentages of addition of hemp shives.

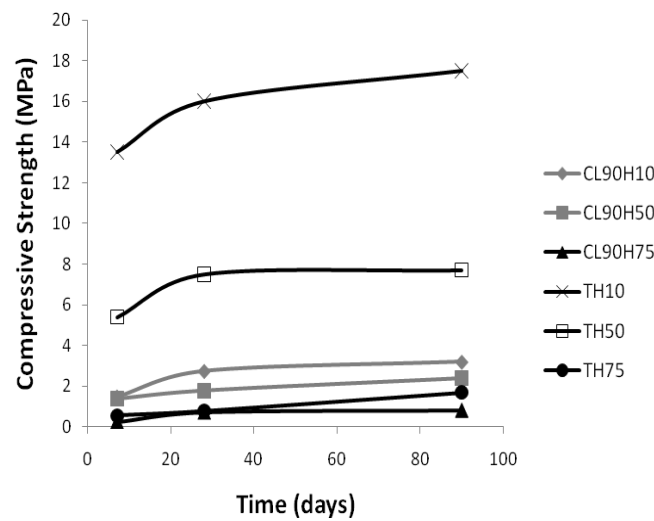

Figure 11. Compressive strength development of hemp composites (CL90H10—10% hemp; CL90H50—50% hemp; CL90H75—75% hemp with 90% calcic lime binder; TH10—10% hemp; TH50—50% hemp; TH75—75% hemp with Tradical binder) [115].

Although compaction has been shown to be effective in enhancing mechanical performance, several authors have expressed doubts about the advantages of incorporating fibers [108,110,116]. Good compaction, coupled with the high workability of hemp shives, makes hemp construction an attractive option in seismic zones [108]. When used as an elastic support for walls made of wood, hemp concretes increase their resistance by a factor of up to four, by preventing weak axes from buckling [117].

Hemp shives are an isotropic material [118], and their specific orientation varies according to the construction method. In fact, the compressive strength is greater and stiffness is weaker when aggregate is positioned parallel to the force direction of the compaction force and is more brittle when it is charged perpendicular to the aggregate orientation [119]. Table 8 summarizes results found in the literature with a focus on the variation in compressive strength with different types of binder. The results show that the compressive strength is greater when the density is higher. The compressive strength for the formulation made with 85% natural hydraulic lime and 15% Portland cement and a density of 753 kg/m³ has a compressive strength of 0.357 MPa, twice that of 100% natural hydraulic lime 3.5, which has a density of 460 kg/m³.

Table 8. Mechanical properties of some hemp shives formulated with different binders.

Authors	Binder Composition	Density (kg/m ³)	Compressive Strength (MPa)
[89]	Natural hydraulic lime (NHL 3.5)	460	0.18
	Natural hydraulic lime (NHL 2.5)	480	0.10–0.22
	Commercial pre-formulated lime-based binder	460–500	0.30–0.34
[120]	Commercial pre-formulated lime-based binder	270–330	0.1–0.2
[121]	85% NHL 3.5 +15% Portland cement	753	0.357
[121]	Portland cement	638	0.622

Flax concrete is specifically developed as an insulator; it is used as a filling material in buildings. However, a minimum compressive strength is required for insulating material, to support at least its own weight during installation.

Flax concrete has a compressive strength of between 0.6 and 1.2 MPa for a content of 54 and 31%, respectively, after 28 days of manufacture [69]. This is sufficient for use as an insulating material in construction. The compressive strength of flax concrete is absolutely related to the quantity of flax shives. The flax shives content decreases compressive strength.

In addition, the increase in the natural fiber content increases its specific surface area in the material. Consequently, this leads to a weak binder/aggregate bond [69] and a low compressive strength. Furthermore, it is also important to remember that the flax shives, which we consider as coarse aggregates in the concrete mix, do not carry any strength compared to the conventional coarse aggregates, hence the low compressive strength values recorded. In general, the resistance sought depends on the application of the material in the building. Roof applications require high natural fiber content and a small amount of binder. In this case, the material will have good thermal insulation with low resistance [69]. Slab formulations contain a low dosage of vegetative particles with a high amount of binder, which gives them good mechanical strength [122].

Seaweed can be a sustainable material above all else, reproducing in the sea and harvested from the seaside. Seaweed has many advantages: it is non-toxic and fire-proof, provides good insulation, and reduces CO₂ emissions [123]. A large quantity of stranded seaweed (between 50,000 and 100,000 m³, corresponding to an average of around 44,640 tons) is collected and processed annually by the local authorities concerned [124].

The advantage of using seaweed is that it improves mechanical, thermal, and hydric properties. The chemical composition of the algae and its absorption capacity will improve the mechanical and hydric properties of the composite [27,76].

Red seaweed is used in powder or gel form in the construction industry. In the literature, works have reported cement-based mortars containing a percentage of red algae (powder and gel) [75]. M. N. I. Siddique et al. [75] studied the mechanical behavior (compression) of cementitious mortar composites with *Eucheuma cottonii* (gel) and composites with *Gracilaria* Sp. (powder). It is also noted that *Cottonii* (gel) and *Gracilaria* Sp. (powder) have rheological properties as gelling and thickening agents [125], which can act as an epoxy resin in a polymer-modified mortar.

In addition, the advantages that natural polymer-modified mortars are expected to provide are excellent adhesion mechanisms, strength, and durability, which are key factors in sustainability [126]. The results showed a better compressive strength performance of natural polymer-modified mortar made with seaweed powder than that made with seaweed gel.

Basing on these results, six formulations were produced (Figure 12). One control formulation (without seaweed) was produced, and five with seaweed, added in the following percentages: 0.1; 0.2; 0.5; 1; 2; and 5.1. The results showed that a low dosage of seaweed (0.1; 0.2; and 0.5%) increased the compressive strength of the mortars. On the other hand, this strength decreased with increasing seaweed content (1; 2; and 5%). The results observed may be due to the mortar's hardening being "killed" by an excessive portion of natural polymer incorporated into the mortar [75]. In this study, it was shown that agarose and agarpectin created a very strong gel and increased the binding mechanism. This makes the performance of natural polymer-modified mortar with seaweed powder more important.

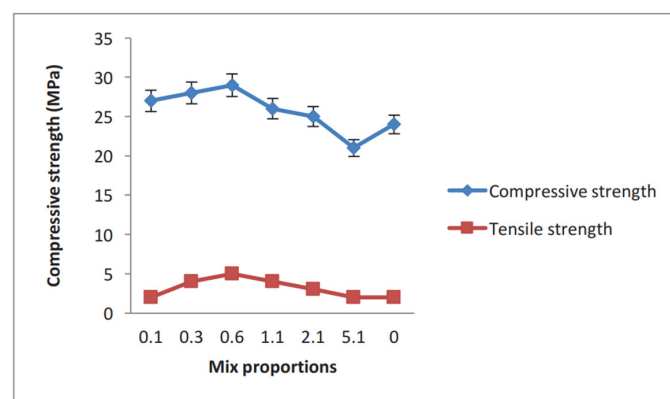

Figure 12. Split tensile strength and compressive strength of the composite modified with seaweed powder [75].

These results are verified in the study by [127]. The same materials were used with the same compositions. The results show that the mixture with 0.6% added seaweed powder has better compressive and tensile strength.

Palm fibers are rarely used in construction. Palm trees are harvested for their fruits. Date palm wood is also an agricultural waste product and has been widely used as a reinforcing material in recycled thermoplastic composites [128–130].

Benmansour et al. [77] studied the effects of adding different percentages of palm fiber types (two different sizes) with the aim of investigating the effects of the percentage additions and size on mechanical properties. In this study, composites were formed using Vicat cement, sand, and water, with percentages of date palm fibers added. Compressive strength decreases with increasing date palm fiber content. This behavior is due to the increase in fiber content, which leads to low sample density. The maximum compressive strength was obtained for the two-dimensional mix at a fiber percentage of 5%, which remained much lower than that of the mortar without fibers.

The results presented in Figure 13 show that the compressive strength of the composite decreases considerably as the percentage of fibers in the composite increases. On the other side, the compressive strength of the composite (with diameter of 6 mm) is almost constant with 5, 10, 15% of addition and decreases largely after this percentage. On the other hand, the compressive strength of MDP3 (diameter of 3 mm) decreases with the percentage of addition.

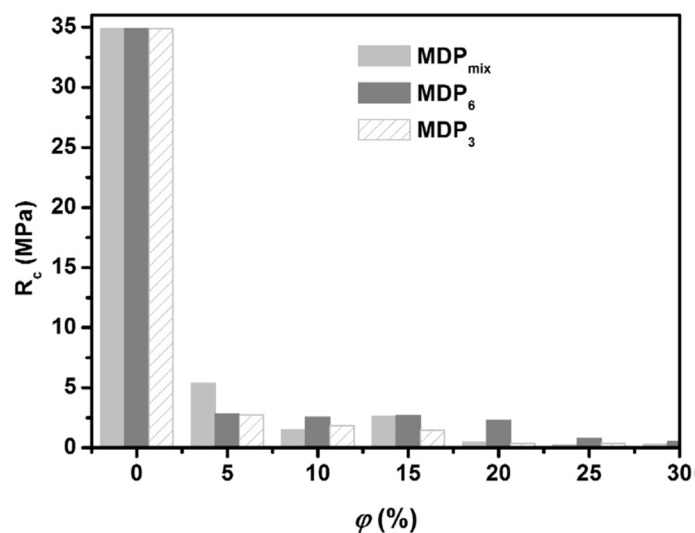

Figure 13. Comparison of the compressive strength of formulations manufactured with 3 different diameters at different rates [77].

Miscanthus has been used in many interesting ways, and lightweight miscanthus concrete is one of them. Studies on miscanthus have shown it can be used for both passive noise protection and fire protection [131]. Miscanthus fibers have already been shown to have a relatively high insulating capacity in regard to temperature [132–134]. Eschenhagen et al. [135] found a low-cost insulated particle board based on miscanthus and sunflower stems in France and demonstrated that it had great potential because of its lower density and better thermal conductivity.

Wu et al. [85] investigated the effect of 1% miscanthus in bulk (RM1), powder (MP1, MP1.5, MP2), and heat-treated miscanthus (HM1). After these three mixtures, two mixtures were made with heat-treated miscanthus with additions of 1.5% and 2%.

The compressive and flexural strengths at 28 days of the HM1 mortar were 52.8 MPa and 8.86 MPa, respectively, with an overall improvement of 82.7% and 26.9%, respectively, compared to the RM1 mortar. The strength of miscanthus mortar at 28 days is shown in Figure 14. This decrease in compressive strength can be explained by the removal of

miscanthus sugar after combustion, which increases adhesion to the mortar and reduces the porosity of HM1.

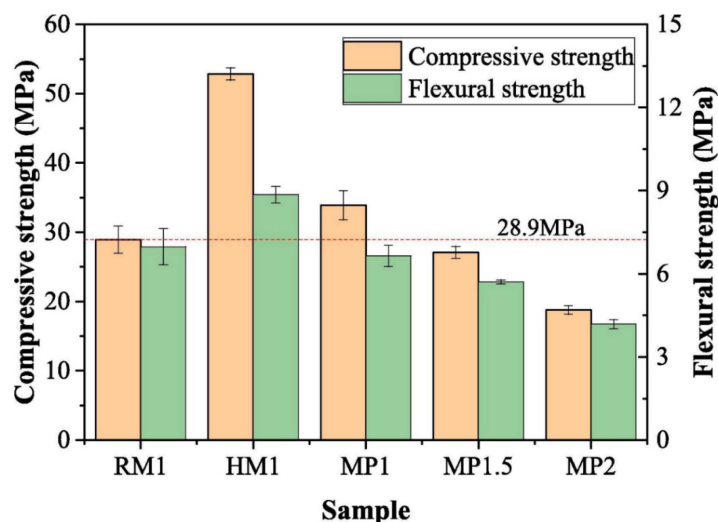

Figure 14. Compressive and flexural strength at 28 days for all mixtures (RM: raw miscanthus; HM: heat-treated miscanthus, and MP: powder miscanthus) [85].

The mechanical properties vary significantly across different materials, influenced by factors such as the type, size, and content of the biomass used, including its physical and chemical composition. Consequently, it is challenging to determine which biomass produces the most mechanically robust materials. Nevertheless, it is evident that seaweed, characterized by its notably high water absorption rate and porosity after drying, experiences a decrease in compressive strength beyond a threshold of 0.06% relative to binder mass. Conversely, hemp and flax shives can be incorporated at high addition rates, up to a maximum of 10%. This rate represents the threshold for achieving good compressive strength, beyond which the resistance begins to decline.

5. Hygrothermal Behavior of Building Materials Incorporating Biomass

5.1. Hygric Properties

The hemp shives' and fibers' absorption capacities vary considerably due to their chemical and physical composition [22]. Hemp concrete is acknowledged as an environmentally friendly construction material, not only because of its low carbon content but also because of its ability to regulate heat, moisture, and relative humidity.

Biobased materials are known for their good thermal and hygric properties due to their chemical and physical compositions. These materials are considered not just low-embodied-carbon materials but materials that are able to regulate heat, moisture, and relative humidity. The significant differences in biodiversity among biobased materials, as well as variations in their proportions in the mixture and particle sizes, result in formulations with varying water absorption capacities [136].

5.1.1. Water Vapor Permeability

Water vapor permeability is measured by two different methods. Permeability is measured using a dry cup (silica gel to make the humidity 0 in the cup and 50% on the outside) or a wet cup (humidity 95% in the cup and 50% on the outside to determine the quantity of water absorbed by the sample) [137].

Two different cups can be used for this test, one dry and one wet. In the dry cup, a substance is used in which the base of the cup is at 0% RH and the outside is at 50% RH, while in the wet cup, where the base of the cup is at 94% RH and the outside is still at 50% RH.

Figure 15 shows at left the dry test and at right the wet test.

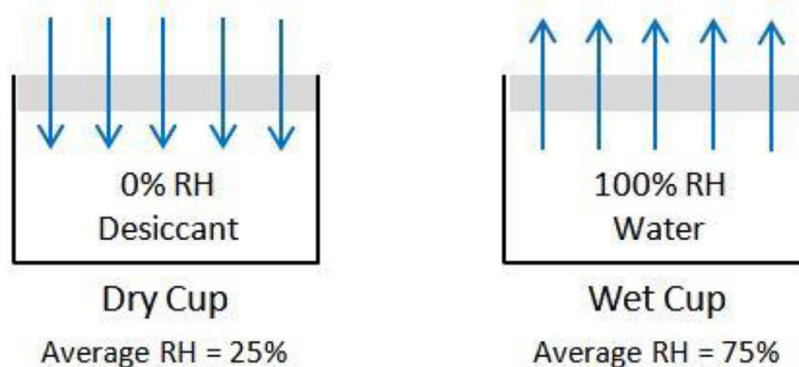

Figure 15. At the left, the water vapor permeability measured in dry cup and at the right, the same measured in wet cup [138].

Hemp concrete is usually manufactured using conventional hemp shives. The research currently published on hemp concretes has, therefore, focused on formulations with insignificant fiber levels. The open porosity of hemp concrete allows heat transfer by conductive heat transfer (in solid, liquid, and gas phases), convective heat transfer (in pores), radiative heat transfer (between pore walls), phase changes (evaporation or condensation of vapor in pores), and water vapor diffusion [122]. It features a high humidity diffusion rate and a water vapor permeability of around 2.3×10^{-11} kg/(Pa.m.s) and is almost constant at low-to-moderate relative humidity [23]. Water vapor diffusion resistance depends on the binder formulation and type. For illustration, a formulation of a wall with natural hydraulic lime (NHL 2) and a density of 476 kg/m^3 has a vapor diffusion resistance factor of 2.6μ , whereas the same formulation prepared with natural hydraulic lime (NHL 3.5) and a density of 563 kg/m^3 has a resistance factor of 3.6μ [122].

The high open porosity of hemp concrete results in a high presence of voids. The high presence of these voids gives the material the ability to absorb more water and, subsequently, it will be less resistant. The water resistance depends on several parameters. One of these parameters is the type of binder used; depending on the binder used the density of the material differs and subsequently the percentage of pores decreases or increases [122].

In this study, Habab et al. [139] used the same formulation and details as the study of Benmansour et al. [77]. However, the type of binder is different. Habab et al. used Portland cement instead of Vicat cement. The constituents are 62% cement, 23% sand, 15% date palm fibers, and $W/C = 0.68$. Portland cement was chosen because of its high mechanical performance, sand was used as a filler for the production of low-cost pastes, and date palm fibers were used in small percentages to improve the physical, mechanical, and hygrothermal properties of the matrix.

The water vapor permeability of date palm concrete (DPC) was studied by using the dry cup method (NF EN ISO 12572) [138]. Walker et al. [140] highlighted that the macropores between the plant fillers have a significant influence on the water vapor permeability when compared to the micropores in the binder of the hemp lime concrete material.

Table 9 presents the results of the moisture vapor resistance factor of date palm concrete (DPC) compared with other construction materials. DPC and hemp-lime are both bio-composite materials, unlike traditional building materials such as solid concrete and aerated autoclaved concrete, which have a higher water vapor resistance value. Therefore, the incorporation of date palm fibers into a cement-based binder has led to a very significant improvement of the microstructure, consequently improving the transfer of water vapor through the DPC. The moisture content of the DPC rose from $12 \text{ kg}\cdot\text{m}^{-3}$ at $27 \pm 5\%$ RH to $19 \text{ kg}\cdot\text{m}^{-3}$ at $47 \pm 5\%$ RH [141–143].

Table 9. Resistance to water vapor diffusion [139].

	Water Vapor Diffusion Resistance	Ref.
DPC	4.4	[139]
LHM-wall	4.8	[144]
Solid concrete	130	[145]
Aerated autoclaved concrete	10	[145]

Wu et al. [85] investigated the effect of 1% miscanthus in bulk (RM1), powder (MP1, MP1.5, and MP2), and heat-treated miscanthus (HM1). After analyzing the first results, two heat-treated mixtures with miscanthus with an addition of 1.5% and 2% were studied.

In this study, they not only investigated the effects of adding miscanthus to these different shapes and sizes on mechanical properties, but also studied their effects on water properties. To this end, Wu et al. [85] studied the water absorption of the mixtures after 24 h immersion in water. The results show that the percentage of water absorption decreased by 15.1% in the mixture with HM1 compared to that with RM1 and increased by 5.8% for the mixture with MP1 compared to RM1. MP1.5 and MP2 had the highest percentages of water uptake at 17.4 and 25.6%, respectively. The detailed results are shown in the attached table (Table 10).

Table 10. Physical and hydic properties of miscanthus properties [85].

Sample	Oven-Dry Density (kg/m ³)	Changes in %	Porosity (%)	Changes in %	24 h Water Absorption	Changes in %
RM1	1932 ± 19	-	16.7 ± 0.3	-	8.6 ± 0.2	-
HM1	2006 ± 26	+3.8	15.1 ± 0.4	-9.6	7.3 ± 0.2	-15.1
MP1	1893 ± 23	-2.0	17.5 ± 0.3	+4.8	9.1 ± 0.2	+5.8
MP1.5	1809 ± 18	-6.4	18.5 ± 0.2	+10.8	10.1 ± 0.1	+17.4
MP2	1688 ± 28	-12.6	19.1 ± 0.2	+14.4	10.8 ± 0.1	+25.6

The hemp shive and the fiber of date palm are capable of absorbing two or three times their weight in 10 min when they are immersed at a saturation level of 95% [89,146]. In contrast, the flax and miscanthus particles can reach three times their weight in 48 hours [38,39,75].

The conclusion that can be drawn from the comparison of these biobased materials is that there are several parameters that directly influence the absorption rate and percentage of a mix: the type, physical and chemical composition, fiber content, and particle size of the plant aggregates.

5.1.2. Moisture Buffering Value

The moisture buffering capacity is a hygroscopic parameter by means of which moisture-bearing materials in contact with the ambient air adsorb and desorb humidity to achieve an equal balance with the relative humidity of the ambient space [147]. There are a number of methods for measuring the buffering capacity of moisture, such as the Japanese standards [148], the Nordtest protocol [141], the method proposed by Padfield [149], the ISO standard [150], and the concept of the ultimate buffering value of moisture [151]. The cumulative amount of humidity buffered by the moisture-absorbing surface material at any time can be obtained from the quantity of water created less the water removed by all the moisture removal mechanisms [152] (Figure 16).

Hemp concrete exhibits an impressive moisture buffer value (MBV) of 2 g/(m²·%RH), significantly exceeding the traditional concrete's MBV of 0.37 ± 0.04 g/(m²·%RH) [147,153]. The MBV measures a material's ability to absorb or release moisture in response to changes in relative humidity levels [107]. A higher MBV indicates a greater capacity for regulating ambient humidity. Unlike traditional concrete, hemp concrete maintains stable relative humidity and temperature conditions, unaffected by its moisture absorption or desorption behavior. MBV values vary based on application methods and thickness. For example, Lelievre et al. [154] recorded a value of 2.3 g/(m²·%RH), while sprayed and cast hemp concrete yielded approximately 2.14–2.15 g/(m²·%RH), respectively [155,156]. The dynamic

moisture behavior of hemp concrete allows for significant humidity absorption, which can reduce energy consumption for cooling. When cycled daily between RH levels of 33% to 80%, with densities ranging from 405 to 510 kg/m³, hemp concrete demonstrated a notable mass gain exceeding 110 g/m² and a steaming depth of over 4 cm [90].

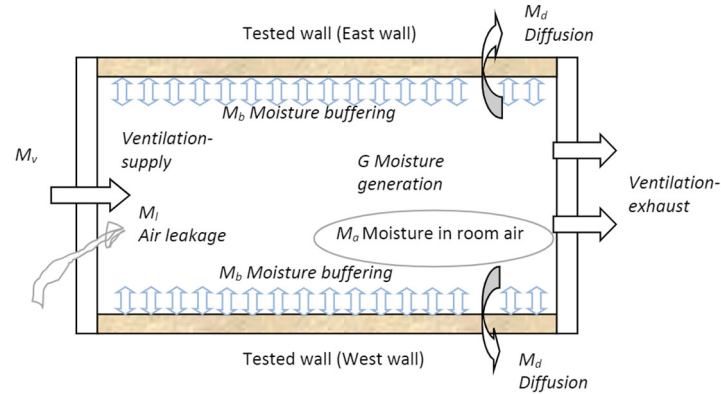

Figure 16. Moisture accumulation in the test room resulting from moisture generation and removal by ventilation, air leakage, and diffusion through test walls [144].

Flax concrete, a natural material, exhibits a high moisture buffer value ranging from 2.03 to 2.82 [69]. Higher F/B ratios result in increased equilibrium water content, especially noticeable at RH levels exceeding 90%. Flax shives have an impressive absorption capacity, able to absorb up to three times their weight within 48 h. The adsorption capacity of flax concrete is closely related to the amount of flax shives present. Interestingly, the size of the flax shives does not significantly affect sorption isotherms. Instead, they enhance the porosity of flax concrete between particles, altering the material’s microstructure and pore sizes. When fine pores dominate the microstructure, water may be trapped inside due to the “ink-bottle effect”, resulting in a larger hysteresis curve [69]. The moisture buffer values for various materials are shown in Figure 17. Table 11 provides a summary comparing the moisture buffering properties between hemp concrete and flax concrete.

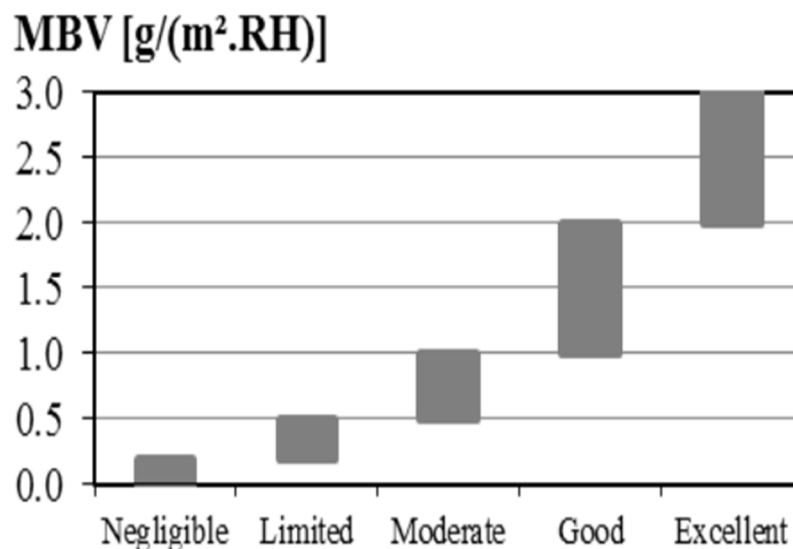

Figure 17. Classes of moisture buffer values from negligible to excellent [147].

Table 11. Comparison of moisture buffering properties between hemp and flax concrete.

Material	Hemp Concrete	Flax Concrete
Moisture Buffer Value (MBV)	2 g/(m ² ·%RH)	2.03 to 2.82 (range)
Application Methods and Thickness	Varies; sprayed: 2.14–2.15 g/(m ² ·%RH), cast: 2.14–2.15 g/(m ² ·%RH)	-
Equilibrium Water Content	Stable, unaffected by water saturation or desorption behavior	Increased with higher F/B ratios, especially noticeable at RH > 90%
Absorption Capacity	Significant, reduces energy consumption associated with cooling	Absorbs up to three times its weight within 48 h
Influence of Dimensions	-	Enhances porosity, alters microstructure and pore sizes
Hysteresis Curve	-	Larger hysteresis curve possible due to “ink-bottle effect” trapping water in fine pores

According to moisture buffer value classes ranging from negligible to excellent, hemp concrete and flax concrete are considered to have excellent moisture buffer values. These values depend strictly on the percentage of plant aggregates present in the material. Flax concrete exhibits a higher MBV than hemp concrete because flax absorbs a higher percentage of water compared to hemp shives.

5.1.3. Sorption Isotherms

The sorption/desorption test is one of the most widely known tests for studying the hydric properties of a material. This test consists of placing the sample at a constant temperature of 23 °C throughout the test and in a relative humidity increasing gradually from 10 to 90% HR for the sorption protocol and decreasing gradually from 90 to 10% HR for the desorption protocol. This test follows the standard NF EN ISO 12571 [157]. Fabbri et al. [158] studied the effect of the percentage of hemp in the mixture on sorption/desorption. Fabbri et al. [158] considered two formulations; the first is a formulation with hemp shives mixed along with a binder (75% lime, 15% hydraulic binder, and 10% pozzolanic), also known as Tradical PF 70. The second formulation is made with a binder developed by ParexGroup. In order to study the hydric properties, both formulations were tested by sorption/desorption tests at two different temperatures, 23 °C and 40 °C. The results show that the higher the percentage of plant aggregates in the mix, the higher the sorption value. Similarly, the increase in temperature had a direct influence on the percentage of water content. In fact, the percentage of water content for the same formulation was higher at 23 °C than at 40 °C, as illustrated in Figure 18 [159–161].

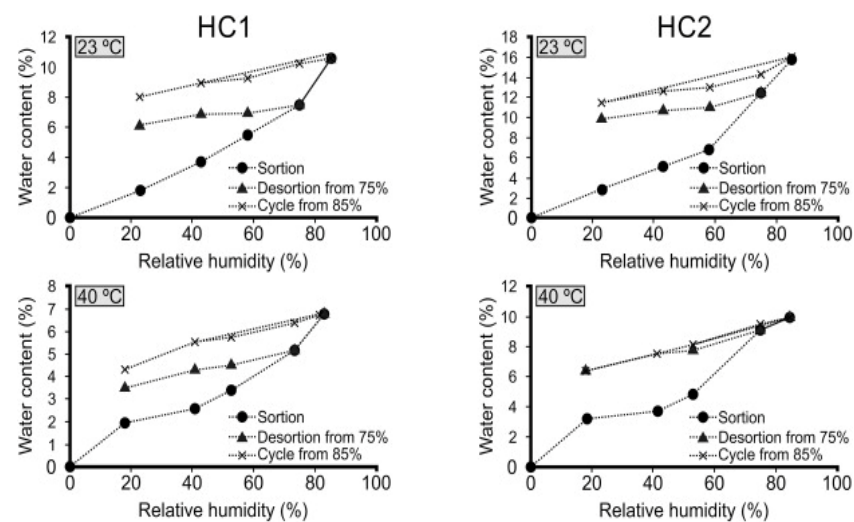

Figure 18. Sorption/desorption curves obtained at 23 °C and 40 °C for the formulation (HC1: hemp/binder = 0.33; HC2: hemp/binder = 0.42) [158].

The isotherms of flax shive concrete were assessed for three different mixtures, with three samples for each mixture, as studied by Benmahiddine et al. [69]. In the mixture with an addition of 17.5% of the weight of the binder by flax shives, the water content was 16%. Conversely, in the mixture with an addition of 11.5% of the weight of the binder by flax shives, the water content was 11%. These findings indicate that, for the same relative humidity, the water content increases as the flax/binder ratio increases. This is attributed to the high absorption capacity of plant flax particles, which can absorb up to three times their weight in 48 h.

In the study of Haba et al. [139], the sorption isotherms of date palm fiber were studied in order to investigate the influence of date palm fiber on the sorption of the composite. The percentage of water absorbed by the material depends on the percentage of palm fibers contained in the mixture. The curve shows that the maximum percentage of water absorption depends on the proportion of palm fibers contained in the mixture.

In conclusion, flax concrete absorbs more water than hemp concrete. Hemp concrete with 50% hemp shives absorbs 17% of water by weight, while flax concrete with 17.5% absorbs almost the same volume. This significant variation is due to the higher water absorption rate of flax shives than hemp shives.

5.2. Thermal Properties

Thermal properties are characterized by many parameters; the main parameters are thermal conductivity and specific heat capacity. A green building is not conditioned only by the strength of its materials, but also by the thermal behavior of the materials. Thermal conductivity is a function of density, porosity, moisture content, and temperature.

Thermal conductivity is the measure of a material's conduction of heat. Thermal conductivity is one of the most important properties that characterize the thermal behavior of materials [69]. This parameter is measured by several methods: the guarded hot plate method, the hot wire method, the heat flow meter method, and the transient plane source with hot disc. The most widely used is the heat flow meter method, which involves placing the material between two plates at two different temperatures to determine its ability to resist heat [162].

Natural fiber has low thermal conductivity, indicating that it can contribute to a reduction in the transmission of heat through the material. Thermal conductivity of hemp concretes is characterized by high-performance values. For roof insulation and wall construction, it ranges from 0.06 to 0.09 W/m·K, while for prefabricated structures, it ranges from 0.14 to 0.27 W/m·K, as shown in study [22,142]. Hemp fiber has a low thermal conductivity, which means it can help reduce heat transmission through the material. This can be useful for structures requiring thermal insulation, such as external walls or roofs. These natural fibers added to concrete mixes can improve the thermal insulation of the material and reduce heat loss. Thanks to its low thermal conductivity, hemp can also help maintain a constant temperature inside the building, reducing heating and cooling requirements.

Thermal conductivity depends on many parameters like density, moisture content, and temperature [163]. According to Arnaud et al. (2013) [164], the thermal conductivity (λ) of hemp concrete ranges from 0.06 to 0.18 W/m·K for a dry specific gravity between 200 and 800 kg/m³ [164]. The thermal conductivity of hemp concrete will be affected by the quantity of fiber, which will have an impact on density. There is considerable research evidence that, regardless of the mineral binder selected or the porosity, the higher the binder content, the higher the thermal conductivity [164]. The thermal performance also improves with increased humidity and temperature, whereas mechanical characteristics increase with greater density [41,99,119,165,166]. Therefore, for a hemp percentage by weight between 20% and 40%, the concrete density decreases on average from 611 to 369 kg/m³, and thermal conductivity from 0.14 to 0.094 W/(m·K) [163]. A 45% reduction in energy consumption was reported when using hemp concrete instead of cellular concrete [167].

Solid and liquid phases are both responsible for the transfer of heat, and conductivity improves with humidity [100]. The results proved this assumption with a light-density hemp concrete of approx. 200 kg/m^3 , wherein the thermal conductivity increased from 0.06 to $0.085 \text{ W/(m}\cdot\text{K)}$ between relative humidity (RH) = 0% and RH = 50%, reaching $0.10 \text{ W/(m}\cdot\text{K)}$ with RH = 75%. The average densities of approximately 450 kg/m^3 increased thermal conductivity by 10% from 0.10 to $0.11 \text{ W/(m}\cdot\text{K)}$ between RH = 0% and RH = 50%, reaching $0.13 \text{ W/(m}\cdot\text{K)}$ with RH = 75%.

The low density of hemp concretes has increased their thermal resistance even further, by as much as 40% between 0 and 50% relative humidity. Specific heat increases in accordance with the amount of humidity absorbed. The open porosity of hemp concretes allows them to control the humidity of the internal air. In this way, their macroporosity makes a greater contribution to their permeability than that of the micropores with different types of binders, particularly when compared to hemp concretes with hydraulic lime, air lime, and Portland cement [140]. For instance, the thermal conductivities of the solid (hemp shive) and air phases are of the order of 0.5755 and 0.025 , respectively $\text{W/(m}\cdot\text{K)}$ [168]. Therefore, hemp has thermal conductivities of 0.089 and $0.1229 \text{ W/(m}\cdot\text{K)}$ in the transversal and longitudinal directions of the particle, respectively [169]. The HFM 446 is commonly used to measure the thermal conductivity of a material. Figure 19 illustrate the upper and lower plate and their positioning during installation measurement.

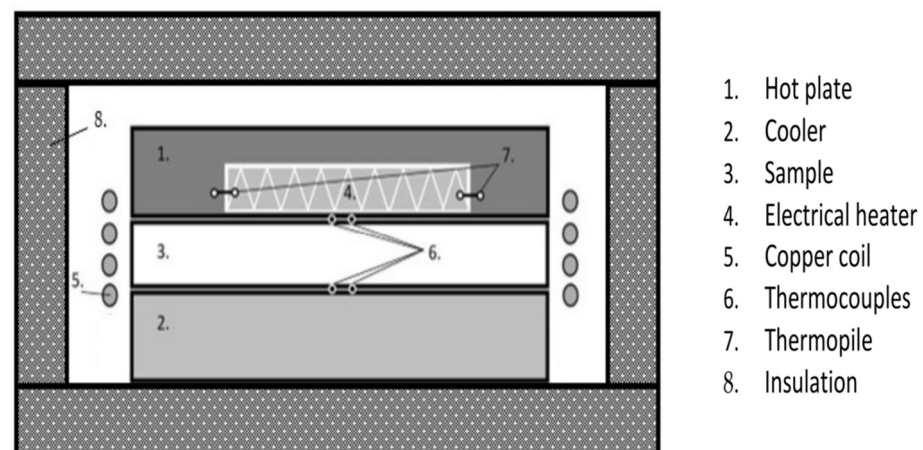

Figure 19. Apparatus used to measure the thermal conductivity [170].

The thermal analyses of hemp concrete conducted in many research units show a scale of insulation values varying from $0.22 \text{ K m}^2/\text{W}$ to $0.40 \text{ K m}^2/\text{W}$ in low-density 200 kg/m^3 to medium-density 400 kg/m^3 wall insulation mixes [167]. Table 12 is a summary table of the thermal conductivity of hemp shives as a function of saturation levels. There is an increase in thermal conductivity as a function of the quantity of fibers and the orientation of the fibers in the transverse orientation compared to the longitudinal one [122].

The mean thermal conductivity of “typical” flax concrete is around $0.100 \text{ W/(m}\cdot\text{K)}$, considerably lower than that of other building materials like concrete cement, valued at $0.12 \text{ W/(m}\cdot\text{K)}$ [171–173]. This value validates the isolating capacity of concrete with flax shives.

In addition, we found that the flax concrete’s thermal conductivity has been established to decline with the level of flax shives used. This decrease can easily be attributed to the increased density and porosity of flax concrete, which improves with the quantity of flax shives, as the thermal conductivity of air is smaller than that of the flax and binder [69].

Table 12. Thermal conductivity of hemp shives formulated with different binders.

Authors	Binder Composition	Density (kg/m ³)	Thermal Conductivity (W/(m·K))
[100]	Air lime 63%; hydraulic lime 37%	200 450	0.06 to 0.085
[142]	Air lime with pozzolanic	611 to 369	0.14 to 0.094
[164]	-	200 to 800	0.06 to 0.18
[170]	Tradical PF 70: 75% air lime with 15% hydraulic and 10% pozzolanic binders	-	0.1

This reduces heat transmission, which in turn reduces the material's thermal conductivity. Another parameter that has a direct influence on thermal conductivity is the size and shape of the flax fiber [69]. Several literature reviews have demonstrated that the thermal conductivity of natural fiber material is lower in the transverse direction than in longitudinal direction. The reasons for choosing this approach are the anisotropy of the natural aggregate and its longitudinally organized porosity [54,168,169,174]. This arrangement leads to lower heat transfer in transverse orientations because the large pore spaces have a much lower thermal conductivity than the solid phase cell walls of the particles.

In addition to their study on the effects of adding a percentage of palm fiber on mechanical properties (two sizes), Benmansour et al. [77] studied the effect on thermal properties. Thermal conductivity was measured using the hot wire method.

Thermal conductivity decreases with date palm fiber content. In the reference sample, the thermal conductivity was of the order of 0.83 W/(m·K), and this value decreased to 0.075 W/(m·K) after an addition of 30% in all three cases. This sharp drop in thermal conductivity in the blend with a high percentage of date palm is due to the very low thermal conductivity of date palm (0.083 W/(m·K)). The decrease in thermal conductivity as a function of the percentage of fiber addition for the three different fiber sizes is illustrated in Figure 20.

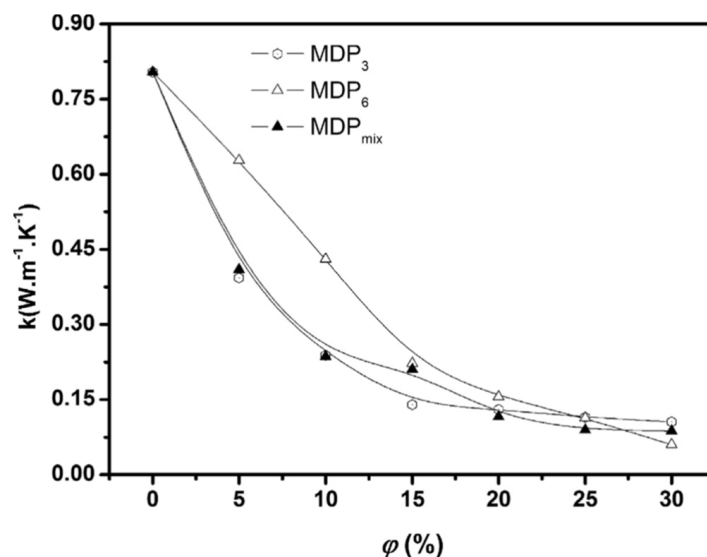

Figure 20. Thermal conductivity of mixtures with 3 different sizes; MDP3: (diameter of 3 mm), MDP6: (diameter of 3 mm), and MDP mix: (diameters between 3 and 6 mm) and several percentages of date palm fiber [77].

Specific Heat Mass

The thermal properties of plant-based concrete are characterized by its thermal conductivity (the thermal conductance of a material) and specific heat (the ability of the material

to store heat). Plant-based concrete has a higher C_p value than traditional concrete due to the presence of plant material, which has a high C_p value.

Based on Evrard (2008) [52], the specific heat capacity of hemp concrete is around 1500 J/kg·K when dry, rising to over 2900 J/kg·K at around 99% relative humidity (RH) [54]. By comparison, concrete made from traditional cement has a specific heat capacity of 800 J/kg·K to 1200 J/kg·K [23].

6. Durability of Building Materials Incorporating Biomass

Evaluating material durability can be achieved through on-site assessments, involving exposure to natural climatic conditions, or through accelerated ageing tests conducted in laboratory settings [170]. There has been limited scientific research into the durability of materials made from natural fibers and hydraulic or mineral binders. Hemp concrete has a good performance in all the durability tests except for the freeze/thaw test [23]. Such studies are not available in abundance, as very few studies have been performed. A hydraulic binder with hemp shives is suitable for reinforcing the composite against the wetting/drying and freezing/thawing cycles.

For the construction field, it is important to remember that concrete is part of the building system and must be protected inside and out by a coating. When applying this type of construction, it is necessary to be aware of the influence on the water content.

Hemp shives are rich in cellulose and lignin components. They are sensitive to moisture, and hemp concrete can age in a damp environment. These problems of durability may be due to a decrease in the mechanical, thermal, or acoustic performance caused by the alkaline degradation of the hemp fibers, the mineralization of the plant fibers, or the expansion caused by the absorption of water or the growth of micro-organisms [175].

The durability of plant-based concrete was examined using various tests: resistance to freeze/thaw, resistance to salt exposure, biodeterioration, and wetting/drying.

6.1. The Influence of Wetting and Drying Cycles on the Mechanical and Hygrothermal Behavior

Wetting/drying is one of the most important tests for measuring the durability of concrete, and the immersion/drying test is one of the tests applied to measure the durability of plant-based concrete. This test is not standardized, but there are several studies that have investigated the effect of immersion/drying on mechanical, thermal, and hydraulic properties.

This test consists of immersing the samples in water for a certain period; this period is not specified, but between 24 and 48 h is considered appropriate, and the samples are then dried either at room temperature or in an oven (this time is between 24 and 72 h). The time it takes for a sample of hemp concrete or plant-based concrete to become saturated is between 24 and 48 h. This time varies according to the type of binder used, the fiber content, and the shape of the sample.

Samples of hemp concrete (34% binder and 16% hemp shives) are immersed for 48 h and then dried for 72 h in a 50 °C oven [170]. This cycle is repeated 10 times, with the test being completed over a period of 40 days. Samples are immersed/dried and reference samples are tested in order to compare them and to study the effect of this test on the mechanical characteristics.

Physical properties are mainly characterized by bulk density, absolute density, and open porosity. In order to study the effects of the immersion/drying test, the open porosity is determined before and after the wetting/drying test. According to study [170], a formulation with the binder Tradical PF 70 (a binder is defined as a commercial binder when it is composed of 75% air lime with 15% hydraulic and 10% pozzolanic binders) and 50% of the weight being hemp shive was studied. The total porosity was measured in samples that had dried under ambient conditions (21 ± 2 °C and 50% RH) and in samples that had undergone immersion/drying. The results show a slight increase in porosity from 71.57% to 73.4%, with this slight increase caused by cracks on the binder/hemp shive interface and

an eventual dissolution of the hydrates initially present in the dough. The decrease in the percent of total porosity is shown in Figure 21.

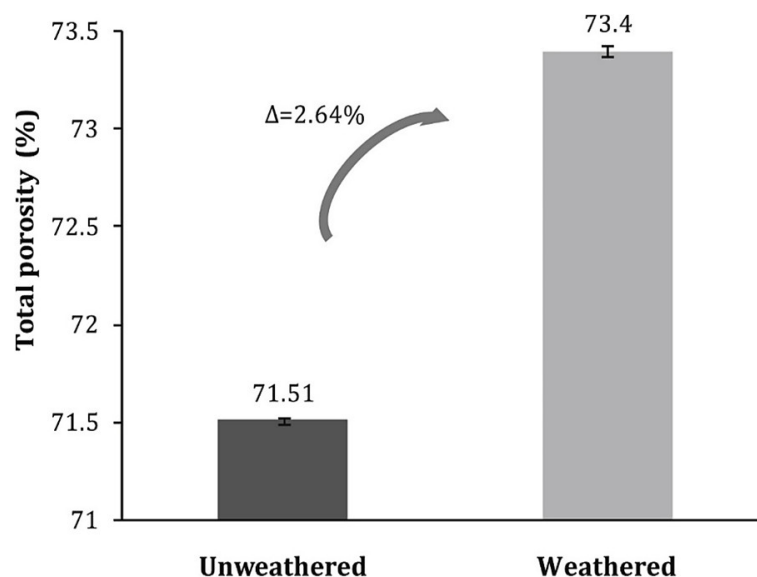

Figure 21. Total porosity of weathered and unweathered hemp concrete [170].

6.1.1. Mechanical Properties

Mechanical properties are some of the properties that are studied after durability, whatever the materials considered, whether insulating or structural. The parameters that have influence on compressive strength are the shape of the sample tested, the type of binder, the type of plant aggregates added, the percentage of plant aggregates added, and the percentage of water added. All these parameters have an influence on the density of the sample, and the compressive strength of the sample is related to the density of the sample. The compressive strength of a material considered to be insulating does not exceed 2 MPa at 28 days [92,170,176]. The compressive strength of samples made with air lime or PF 70 (a binder is defined as a commercial binder when it is composed of 75% air lime with 15% hydraulic and 10% pozzolanic binders) with 50% of the binder mass mixed with hemp shives was around 1 MPa at 28 days [92,170,176].

With the aim of studying the durability of this material, a compressive strength test after the immersion/drying test was measured by several researchers [170,176]. A very significant decrease was observed in the compressive strength of samples made with PF 70 (a binder is defined as a commercial binder when it is composed of 75% air lime with 15% hydraulic and 10% pozzolanic binders) and hemp shives [170] in that the compressive strength decreased by 51%, from 0.94 MPa, for the sample that did not receive the wetting/drying test, to 0.46 MPa for the sample that received accelerated ageing. This decrease in compressive strength was probably due to cracks caused by the swelling and shrinkage of the hemp shives and can be explained by the sharp increase in the percentage of porosity. The compressive strength is determined by two factors: the load velocity and the deformation percentage. Compressive strength is at its maximum when the sample is completely crushed. Figure 22 shows hemp concrete at the moment of crushing (maximum deformation reached).



Figure 22. Typical failure of hemp–lime concrete under an axial compressive load [92].

6.1.2. Hygrothermal Properties

- Thermal conductivity

Thermal conductivity is the ability of a material to resist temperature. This parameter is measured by several methods, the most common of which is the heat flow meter. This apparatus is used by placing the sample in the machine and adjusting the temperatures of the bottom and top plates of the sample, followed by directing a flow of heat from the top plate to the product and then measuring the resistance capacity of this material. Figure 23 shows the apparatus used to measure this parameter. The figure shows the bulk-filled sample at top left and the plate-shaped bio-composite sample at top right, ready for measurement in a Netzsch HFM 446 Lambda Small instrument (Institute of Materials and Structures at Riga Technical University in Latvia, Riga, Latvia).

The distribution can differ if the shives or fibers are distributed in the longitudinal or transversal direction [48,49,177]. A decrease of 6.63% was found in thermal conductivity between the specimen under laboratory conditions ($21 \pm 2 \text{ }^\circ\text{C}$ and 50% RH), when the value of thermal conductivity was $0.10094 \text{ W}/(\text{m}\cdot\text{K})$, and that of the samples after application of the wetting/drying test. This decrease was due to an increase in the percentage of porosity [170].

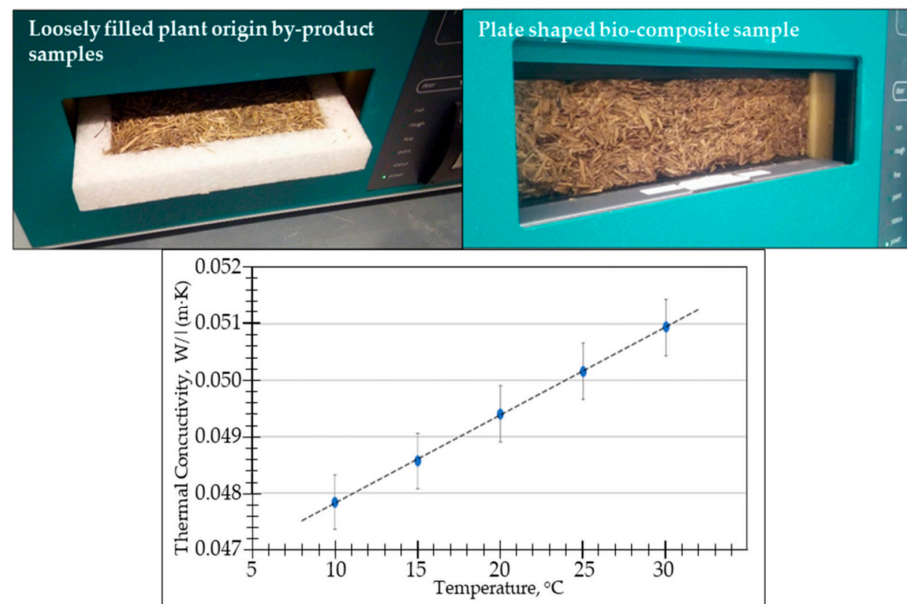

Figure 23. Loosely filled bulk specimen above left and plate-shaped bio-composite specimen above right, ready for measurements in a Netzsch HFM 446 Lambda Small instrument. The graph at the bottom presents the λ values as measured at different average temperatures [178].

- Water vapor permeability

This parameter gives a criterion as to whether the material used will be water-insulating or not. Resistance to water vapor permeability depends on several parameters, for example, in the case of plant-based concrete or vegetable concrete, its resistance depends on the type of binder, the biobased materials, and their percentage in the formulation. The resistance to water vapor diffusion for a formulation with natural hydraulic lime (NHL 2 binder) and a density of 476 kg/m^3 was 2.6×10^{-11} ; for a formulation with the same fiber and the same percentage of natural fibers but with a different binder (NHL 3.5), the density of the formulation increased to 563 kg/m^3 , and the resistance factor increased to $3.6 \times 10^{-11} \text{ kg/(msPa)}$ [122].

The water vapor permeability or the diffusion resistance factor is measured after the application of the immersion/drying test to study a sample's performance against durability. To this end, samples manufactured with PF 70 (Tradical PF 70) and an addition of 50% of the binder mass of hemp shive were subjected to the diffusion resistance factor and water vapor permeability test before and after the immersion/drying test. The results show a very large increase in water vapor permeability from 2.85×10^{-11} to $3.94 \times 10^{-11} \text{ kg/(msPa)}$. This increase was reflected in a sharp drop in the diffusion resistance factor, which fell from 6.88 to 4.99.

- Sorption isotherms

Plant-based concrete is recognized for its thermal and hydric properties. These properties are of particular interest thanks to the high hygrothermal properties of natural fiber. The hygric properties, such as thermal properties, are linked to and dependent on the binder type, the interaction of binder and fiber, the type of fiber, and the percentage of fiber in the mix. Several parameters are known for the study of the hydric properties of a material, one of which is the sorption/desorption test. This test consists of placing the sample in a constant temperature ($23 \text{ }^\circ\text{C}$) and a humidity of 10%, and then it assumes five humidity values varying between 10% and 90% of sorption and five values between 90% and 10% of desorption. This test is standardized under the international standard NF EN ISO 12,571 [157]. The samples were placed into this machine with a temperature set at $23 \text{ }^\circ\text{C}$, and the machine was connected to a computer with a software package that tracked all the calculation points and gave us a sorption/desorption graph when the test was finished.

Sorption isotherms have also been tested by [170]. This test was applied to samples that had undergone the immersion/drying test and reference materials, which had dried at room temperature. The moisture content of the reference materials was more interesting than that of the samples, with respect to the size and random distribution of the shives, as well as the reduced water absorption capacity and reduced water storage capacity of the shives in weathered hemp concrete. The random distribution of pore sizes can cause water to be retained in small pores because of the "ink bottle" effect [179,180]. The conclusion that can be drawn is that hemp concretes lose their ability to absorb water and subsequently become less hydrically resistant.

6.2. Resistance to Freeze/Thaw

Freeze/thaw resistance is one of the most widely used parameters for measuring a material's durability. The resistance of lime mortar or hemp concrete is tested by the standard EN 15304:2010 [181]. This standard involves subjecting the nine-month samples to 10 freeze/thaw cycles between -15 and $20 \text{ }^\circ\text{C}$.

The effects of freezing/thawing are most severe in conditions close to saturation, as the expansion of the ice is then the most damaging. The samples were, therefore, soaked for 48 h before being frozen, with 90% of the water being absorbed. In addition, to ensure that the quantity of water was close to saturation, the samples were submerged for 12 h at the end of cycles 4 and 8 [92]. The freeze/thaw test was applied to two materials, which were then formed into cylindrical specimens, one made from alkali aluminosilicate

cement and the other from Portland cement. The results show that the cylinder made from Portland cement was more affected and sensitive to this test than the one made from alkali aluminosilicate (Figure 24), and the compressive strength of Portland cement is lower than that of alkali aluminosilicate because their microstructure is affected by the freeze/thaw test.

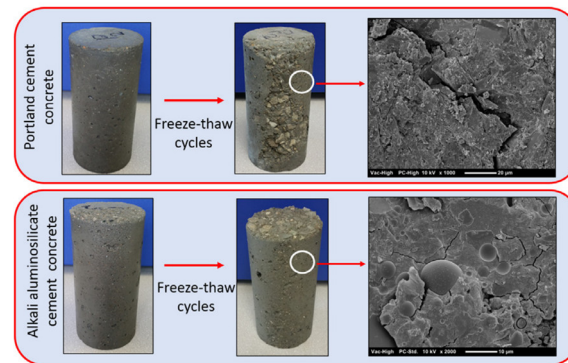

Figure 24. Results of freeze/thaw test on alkali aluminosilicate and Portland cement concrete [182].

6.3. Resistance to Salt Exposure

There are currently no standards for assessing the resistance of hemp–lime concrete manufactured with hemp shive and hydraulic lime to exposure to salt. The samples produced 9 months previously were treated with a salt solution in an SC1000 salt spray chamber with an open lid. Resistance to salt exposure was measured by regularly dispersing a solution of NaCl in the form of small drops through nozzles in the chamber for 12 h, followed by 12 h of drying. The concretes underwent 4 weeks of cycles (the first 2 weeks at 20 °C and the rest at 40 °C). They were dried for 2 months, and their compressive strength was measured [92]. An example of the test’s application is shown in Figure 25. Three cubic specimens (10 × 10 × 10 m³) were semi-immersed in a box containing 5.0% Na₂SO₄ with a pH between 6 and 8 at 25–30 °C. Based on the changes in mass loss, compressive strength, relative dynamic modulus of elasticity, and surface morphology of the concrete samples, the resistance to sulfate attack is ranked as follows: C25 > C25 + 8.0% AS > C25 + 6.0% AS > C25 + 8.0% AF > C25 + 6.0% AF > C25 + 3.0% AR > C25 + 5.0% AR (alkaline accelerator based on sodium aluminate, AR; alkali-free accelerator based on fluoroaluminate, AF; alkali-free accelerator based on aluminum sulfate, AS).

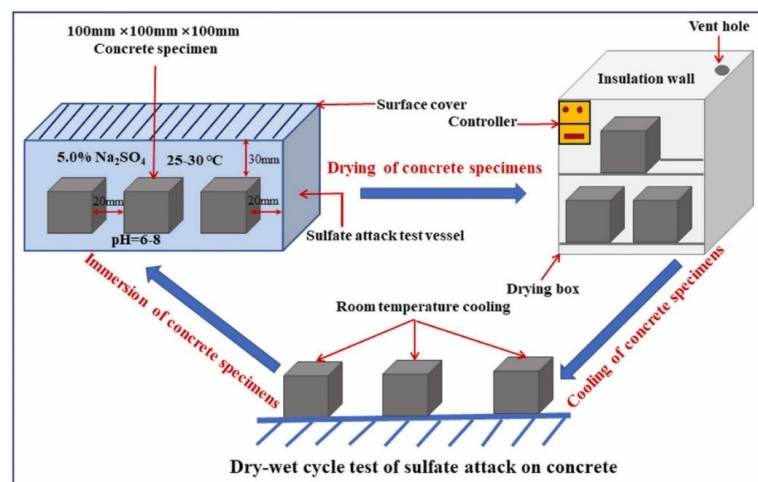

Figure 25. Diagram of the semi-immersion and dry/wet test for sulfate attack on shotcrete [183].

This shows that the addition of liquid accelerators has a negative impact on the sulfate resistance of concrete. Furthermore, under both sulfate attack conditions, the concrete

sprayed with 5.0% RA was the most severely degraded, while the concrete sprayed with 8.0% SA showed the highest resistance to sulfate attack.

6.4. Biodeterioration

There are several tests available to measure the durability of a material on a laboratory scale. One of these tests is the biodeterioration test.

This test is directly related to the choice of cement, which has an influence on the durability of the composites used (concrete, mortar...). Alkalis contained in cement or other concrete constituents can cause chemical reactions with certain aggregates.

To this end, De Muynck et al. [184] measured two concrete samples. One was submitted to eight cycles of the microbiology test. Two different tests were conducted, at different times. The first test series (RC, CC, EC, PUL, and WGC sewer pipes) and the second (RC, FC, and ZC laboratories) involved, respectively, eight and four accelerated test cycles.

The cycle was divided into four steps:

- (1) H₂S immersion in a recipient holding approximately 200 ppm H₂S for 2 days;
- (2) Immersion in a recipient containing 1.5 L of mixed SOB cultures obtained from a sewer pipe biofilm [185] (composition of the medium: 10 g/L elemental sulfur, 3 g/L KH₂PO₄, 0.1/L NH₄Cl, 0.1 g/L MgCl-6H₂O, and 0.14 g/L CaCl-2H₂O) for 10 days;
- (3) Immersion in a container containing distilled water for 2 days;
- (4) Drying at room temperature for 1 day. The vessels from the second and third steps were put on a rotatory shaker at 90 rpm. The other specimen was stored at normal temperature. The results show that a loss of cement paste is clearly visible (Figure 26), in contrast to the residual aggregates, which were unaffected.

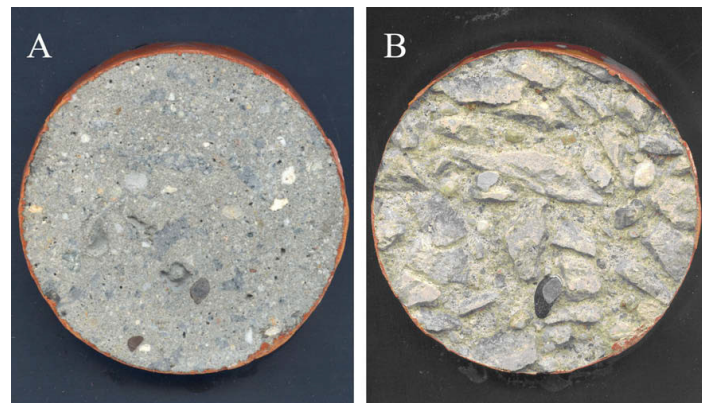

Figure 26. A sample of the concrete before (A) and after (B) eight cycles of the microbiological test. A loss of cement paste is clearly visible, while the aggregate remains relatively unaffected [184].

7. Discussion

The research presented provides a thorough examination of biobased concrete materials derived from various sources such as hemp, flax, date palm, seaweed, and miscanthus. Despite their advantages in energy-efficient construction, biobased concretes generally exhibit lower mechanical properties compared to conventional concrete due to decreased sample density [77]. Compressive strength, a critical mechanical property, varies based on the type and percentage of plant aggregates used, as well as the binder employed. For instance, hemp concrete with a 2:1 mix ratio (binder to hemp shives by mass) typically ranges from 0.2 to 1.2 MPa [92,93,95,96,115], while flax concrete typically falls between 0.6 and 1.2 MPa after 28 days [69]. Variations in compressive strength are often linked to differences in mechanical properties between the types of plant aggregates used [133]. Generally, the introduction of plant aggregates decreases the density of the concrete mix and subsequently its compressive strength due to factors such as low mechanical strength of the aggregates, increased porosity, and compromised fiber/matrix adhesion [85].

Biobased concrete is known for its low thermal conductivity and high water absorption capacity. For example, hemp concrete typically exhibits a thermal conductivity ranging from 0.06 to 0.18 W/(m·K) [41,99,119,165,166], while flax concrete has even lower values, around 0.057 W/(m·K) [54]. Additionally, the addition of date palm fibers can significantly reduce thermal conductivity, with an observed reduction of 30% in a sample's conductivity [51]. Concrete materials based on biomass have unique characteristics that influence their durability and weather resistance. While they may offer frost/thaw resistance comparable to conventional concrete, their behavior regarding carbonation and cracking may vary depending on the types and percentages of plant aggregates used. Research has shown that certain biomass-based concrete materials, such as those containing hemp or flax, may exhibit increased resistance to carbonation due to their chemical composition and specific porosity [186]. However, they may also be more prone to cracking due to their low elasticity modulus and moisture absorption capacity, necessitating specific design and formulation to ensure long-term durability [187]. Environmentally, biomass-based concrete materials offer significant benefits, including plants' ability to absorb carbon dioxide during growth, thereby reducing the overall carbon footprint of constructed structures [188]. These materials also pave the way for new applications in sustainable construction, such as thermal insulation, construction panels, and even structural elements, although challenges remain, including raw material availability and the standardization of formulations to ensure consistent performance [189].

8. Conclusions

All plant-based materials inherently absorb water, affecting their water diffusion resistance. For instance, hemp concrete demonstrates a resistance of 2.6 at a density of 476 kg/m³ [23], whereas palm concrete has a higher resistance of 4.4 [139]. Various factors, including binder and aggregate types and percentages, influence water absorption rates [23]. Despite differences in properties among plant aggregates, determining the optimal material for mechanical, thermal, or hydric performance remains challenging. Generally, adding plant fibers reduces formulation density while increasing porosity, thereby enhancing thermal properties but reducing water resistance.

Funding: This research received no external funding.

Conflicts of Interest: The authors declare no conflict of interest.

References

1. Shi, J.; Liu, Y.; Xu, H.; Peng, Y.; Yuan, Q.; Gao, J. The roles of cenosphere in ultra-lightweight foamed geopolymer concrete (UFGC). *Ceram. Int.* **2022**, *48*, 12884–12896. [CrossRef]
2. Alassaad, F.; Touati, K.; Levacher, D.; Sebaibi, N. Impact of phase change materials on lightened earth hygroscopic, thermal and mechanical properties. *J. Build. Eng.* **2021**, *41*, 102417. [CrossRef]
3. Hache, E.; Leboulenger, D.; Mignon, V. Beyond average energy consumption in the French residential housing market: A household classification approach. *Energy Policy* **2017**, *107*, 82–95. [CrossRef]
4. Maalouf, C.; Ingraio, C.; Scrucca, F.; Moussa, T.; Bourdot, A.; Tricase, C.; Presciutti, A.; Asdrubali, F. An energy and carbon footprint assessment upon the usage of hemp-lime concrete and recycled-PET façades for office facilities in France and Italy. *J. Clean. Prod.* **2018**, *170*, 1640–1653. [CrossRef]
5. Senga Kiessé, T.; Ventura, A.; van der Werf, H.M.G.; Cazacliu, B.; Idir, R. Introducing economic actors and their possibilities for action in LCA using sensitivity analysis: Application to hemp-based insulation products for building applications. *J. Clean. Prod.* **2017**, *142*, 3905–3916. [CrossRef]
6. Mo, K.H.; Alengaram, U.J.; Jumaat, M.Z.; Yap, S.P.; Lee, S.C. Green concrete partially comprised of farming waste residues: A review. *J. Clean. Prod.* **2016**, *117*, 122–138. [CrossRef]
7. Magniont, C.; Escadeillas, G.; Coutand, M.; Oms-Multon, C. Use of plant aggregates in building ecomaterials. *Eur. J. Environ. Civ. Eng.* **2012**, *16*, s17–s33. [CrossRef]
8. Mycoo, M.A. A Caribbean New Urban Agenda post-Habitat III: Closing the gaps. *Habitat Int.* **2017**, *69*, 68–77. [CrossRef]
9. WGBW19. World Green Building Council. Available online: <https://worldgbc.org/wgbw19/> (accessed on 28 March 2024).
10. Chen, T.; Yao, S.; Merlin, M.; Mai, H.; Qiu, Z.; Hu, Y.; Wang, B.; Wang, C.; Jiang, H. Identification of Cannabis Fiber from the Astana Cemeteries, Xinjiang, China, with Reference to Its Unique Decorative Utilization. *Econ. Bot.* **2014**, *68*, 59–66. [CrossRef]

11. Struik, P.C.; Amaducci, S.; Bullard, M.J.; Stutterheim, N.C.; Venturi, G.; Cromack, H.T.H. Agronomy of fibre hemp (*Cannabis sativa* L.) in Europe. *Ind. Crops Prod.* **2000**, *11*, 107–118. [CrossRef]
12. Boutin, M.P.; Flamin, C.; Quinton, S.; Gosse, G. *Etude des Caractéristiques Environnementales du Chanvre par l'Analyse de Son Cycle de Vie*; Ministère de l'Agriculture et de la Pêche: Paris, France, 2006; Volume 102.
13. Summerscales, J.; Dissanayake, N.P.J.; Virk, A.S.; Hall, W. A review of bast fibres and their composites. Part 1—Fibres as reinforcements. *Compos. Part A Appl. Sci. Manuf.* **2010**, *41*, 1329–1335. [CrossRef]
14. Ferreira, S.R.; de Andrade, R.G.M.; Koenders, E.; Silva, F.d.A.; Fairbairn, E.d.M.R.; Filho, R.D.T. Pull-out behavior and tensile response of natural fibers under different relative humidity levels. *Constr. Build. Mater.* **2021**, *308*, 124823. [CrossRef]
15. Rocha Ferreira, S.; Rodrigues Sena Neto, A.; de Andrade Silva, F.; Gomes de Souza, F.; Dias Toledo Filho, R. The influence of carboxylated styrene butadiene rubber coating on the mechanical performance of vegetable fibers and on their interface with a cement matrix. *Constr. Build. Mater.* **2020**, *262*, 120770. [CrossRef]
16. Parkinson, J.P. Specimen of Hypertrophic Stenosis of the Pylorus. *Proc. R. Soc. Med.* **1910**, *3*, 99–101. [CrossRef] [PubMed]
17. Yagoub, M. Evaluation de la Qualité du Béton de Fibres In Situ Cas de Béton Autoplaçant avec des Fibres Mixtes. Master's Degree, Université Mohamed Khider—Biskra, Biskra, Algeria, 2009.
18. Lankard, D.R. Steel fibres in mortar and concrete. *Composites* **1972**, *3*, 65–70. [CrossRef]
19. Affan, H.; Arai, W.; Arayro, J. Mechanical and thermal characterization of bio-sourced mortars made from agricultural and industrial by-products. *Case Stud. Constr. Mater.* **2023**, *18*, e01939. [CrossRef]
20. Tran, M.T.; Vu, X.H.; Ferrier, E. Experimental and numerical investigation of carbon textile/cementitious matrix interface behaviour from pull-out tests. *Constr. Build. Mater.* **2021**, *282*, 122634. [CrossRef]
21. Delannoy, G.; Marceau, S.; Glé, P.; Gourlay, E.; Guéguen-Minerbe, M.; Amziane, S.; Farcas, F. Durability of hemp concretes exposed to accelerated environmental aging. *Constr. Build. Mater.* **2020**, *252*, 31. [CrossRef]
22. Sáez-Pérez, M.P.; Brümmer, M.; Durán-Suárez, J.A. A review of the factors affecting the properties and performance of hemp aggregate concretes. *J. Build. Eng.* **2020**, *31*, 101323. [CrossRef]
23. Jami, T.; Karade, S.R.; Singh, L.P. A review of the properties of hemp concrete for green building applications. *J. Clean. Prod.* **2019**, *239*, 117852. [CrossRef]
24. Cristaldi, G.; Latteri, A.; Recca, G.; Cicala, G. Composites based on natural fibre fabrics. *Woven Fabr. Eng.* **2010**, *17*, 317–342.
25. Thapliyal, D.; Verma, S.; Sen, P.; Kumar, R.; Thakur, A.; Tiwari, A.K.; Singh, D.; Verros, G.D.; Arya, R.K. Natural Fibers Composites: Origin, Importance, Consumption Pattern, and Challenges. *J. Compos. Sci.* **2023**, *7*, 506. [CrossRef]
26. Ren, G.; Yao, B.; Huang, H.; Gao, X. Influence of sisal fibers on the mechanical performance of ultra-high performance concretes. *Constr. Build. Mater.* **2021**, *286*, 122958. [CrossRef]
27. Affan, H.; Touati, K.; Benzaama, M.-H.; Chateigner, D.; El Mendili, Y. Earth-Based Building Incorporating Sargassum muticum Seaweed: Mechanical and Hygrothermal Performances. *Buildings* **2023**, *13*, 932. [CrossRef]
28. Hemp Lime: An Introduction to Low-Impact Building Materials Downloadable Version: BREbookshop.com. Consulté le: 13 Septembre 2023. [En ligne]. Available online: <https://www.brebookshop.com/details.jsp?id=326819> (accessed on 28 March 2024).
29. Hemp as an Agricultural Commodity. Consulté le: 19 Juin 2023. [En ligne]. Available online: <https://apps.dtic.mil/sti/citations/ADA599368> (accessed on 28 March 2024).
30. Mechanics: New Billion-Dollar Crop—Google Scholar. Consulté le: 19 Juin 2023. [En ligne]. Available online: https://scholar.google.com/scholar_lookup?title=New%20Billion-Dollar%20Crop,%20Popular%20Mechanics&publication_year=1938&author=P.%20Mechanics (accessed on 28 March 2024).
31. Collet, F. Caractérisation Hydrique et Thermique de Matériaux de Génie Civil à Faibles Impacts Environnementaux. Doctoral Dissertation, INSA, Rennes, France, 2004.
32. Chanvre—Google Search. Available online: https://www.google.com/search?rlz=1C1GCEA_enFR970FR970&sxsrf=AB5stBjewlOeV4wKOeLKnH3HnUxLP0il4w:1689175283440&q=chanvre&tbm=isch&sa=X&ved=2ahUKEwig-u2lvImAAxXUXaQEhEcsCucQ0pQJegQIDBAB&biw=1920&bih=969&dpr=1#imgrc=E-8SR_RIPxLL8M (accessed on 28 March 2024).
33. Degraeve-Lemeurs, M.; Glé, P.; Hellouin de Menibus, A. Acoustical properties of hemp concretes for buildings thermal insulation: Application to clay and lime binders. *Constr. Build. Mater.* **2018**, *160*, 462–474. [CrossRef]
34. Haik, R.; Bar-Nes, G.; Peled, A.; Meir, I.A. Alternative unfired binders as lime replacement in hemp concrete. *Constr. Build. Mater.* **2020**, *241*, 117981. [CrossRef]
35. Hussain, A.; Calabria-Holley, J.; Lawrence, R.; Jiang, Y. Hygrothermal and mechanical characterisation of novel hemp shiv based thermal insulation composites. *Constr. Build. Mater.* **2019**, *212*, 561–568. [CrossRef]
36. Sheridan, J.; Sonebi, M.; Taylor, S.; Amziane, S. The effect of a polyacrylic acid viscosity modifying agent on the mechanical, thermal and transport properties of hemp and rapeseed straw concrete. *Constr. Build. Mater.* **2020**, *235*, 117536. [CrossRef]
37. Rahmouni, I.; Promis, G.; R'mili, A.; Beji, H.; Limam, O. Effect of carbonated aggregates on the mechanical properties and thermal conductivity of eco-concrete. *Constr. Build. Mater.* **2019**, *197*, 241–250. [CrossRef]
38. Scardecchia, S.; Vita, A.; Santulli, C.; Forcellese, A. A material proposed for re-use of hemp shives as a waste from fiber production. *Mater. Today Proc.* **2020**, *31*, S213–S216. [CrossRef]
39. Garikapati, K.P.; Sadeghian, P. Mechanical behavior of flax-lime concrete blocks made of waste flax shives and lime binder reinforced with jute fabric. *J. Build. Eng.* **2020**, *29*, 101187. [CrossRef]

40. Fourmentin, M.; Faure, P.; Pelupessy, P.; Sarou-Kanian, V.; Peter, U.; Lesueur, D.; Rodts, S.; Daviller, D.; Coussot, P. NMR and MRI observation of water absorption/uptake in hemp shives used for hemp concrete. *Constr. Build. Mater.* **2016**, *124*, 405–413. [CrossRef]
41. Delannoy, G.; Marceau, S.; Gle, P.; Gourlay, E.; Gueguen-Minerbe, M.; Diafi, D.; Nour, I.; Amziane, S.; Farcas, F. Aging of hemp shiv used for concrete. *Mater. Des.* **2018**, *160*, 752–762. [CrossRef]
42. Hussain, A.; Calabria-Holley, J.; Schorr, D.; Jiang, Y.; Lawrence, M.; Blanchet, P. Hydrophobicity of hemp shiv treated with sol-gel coatings. *Appl. Surf. Sci.* **2018**, *434*, 850–860. [CrossRef]
43. Brett, C.; Waldron, K. Physiology and biochemistry of plant cell walls. In *Topics in Plant Physiology*; Springer Science & Business Media: Berlin, Germany, 1990. [CrossRef]
44. Hussain, A.; Calabria-Holley, J.; Lawrence, M.; Ansell, M.P.; Jiang, Y.; Schorr, D.; Blanchet, P. Development of novel building composites based on hemp and multi-functional silica matrix. *Compos. Part B Eng.* **2019**, *156*, 266–273. [CrossRef]
45. Hussain, A.; Calabria-Holley, J.; Lawrence, M.; Jiang, Y. Resilient hemp shiv aggregates with engineered hygroscopic properties for the building industry. *Constr. Build. Mater.* **2019**, *212*, 247–253. [CrossRef]
46. Hussain, A.; Calabria-Holley, J.; Jiang, Y.; Lawrence, M. Modification of hemp shiv properties using water-repellent sol-gel coatings. *J. Sol-Gel Sci. Technol.* **2018**, *86*, 187–197. [CrossRef] [PubMed]
47. Seng, B.; Lorente, S.; Magniont, C. Scale analysis of heat and moisture transfer through bio-based materials—Application to hemp concrete. *Energy Build.* **2017**, *155*, 546–558. [CrossRef]
48. Bennai, F.; El Hachem, C.; Abahri, K.; Belarbi, R. Microscopic hydric characterization of hemp concrete by X-ray microtomography and digital volume correlation. *Constr. Build. Mater.* **2018**, *188*, 983–994. [CrossRef]
49. Bennai, F.; Issaadi, N.; Abahri, K.; Belarbi, R.; Tahakourt, A. Experimental characterization of thermal and hygric properties of hemp concrete with consideration of the material age evolution. *Heat Mass Transf.* **2018**, *54*, 1189–1197. [CrossRef]
50. Fernea, R.; Manea, D.L.; Plesa, L.; Iernuțan, R.; Dumitran, M. Acoustic and thermal properties of hemp-cement building materials. *Procedia Manuf.* **2019**, *32*, 208–215. [CrossRef]
51. Vignon, M.R.; Garcia-Jaldon, C.; Dupeyre, D. Steam explosion of woody hemp chènevotte. *Int. J. Biol. Macromol.* **1995**, *17*, 395–404. [CrossRef] [PubMed]
52. Evrard, A. Transient Hygrothermal Behavior of Lime-Hemp Materials. Ph.D. Thesis, Universite Catholique de Louvain, Ottignies-Louvain-la-Neuve, Belgium, 2008.
53. Thomsen: Hemp Raw Material: The Effect of Cultivar—Google Scholar. Available online: https://scholar.google.com/scholar_lookup?title=Hemp%20Raw%20Materials:%20the%20Effect%20of%20Cultivar,%20Growth%20Conditions%20and%20Pre%20treatment%20on%20the%20Chemical%20Composition%20of%20the%20Fibres&publication_year=2005&author=A.B.%20Thomsen&author=S.K.%20Rasmussen&author=V.%20Bohn&author=K.V.%20Nielsen&author=A.%20Thygesen (accessed on 28 March 2024).
54. Collet, F. Hygric and Thermal Properties of Bio-aggregate Based Building Materials. In *Bio-Aggregates Based Building Materials: State-of-the-Art Report of the RILEM Technical Committee 236-BBM*; RILEM State-of-the-Art, Reports; Amziane, S., Collet, F., Eds.; Springer: Dordrecht, The Netherlands, 2017; pp. 125–147. [CrossRef]
55. Mohamad, A. Semi-Structural Insulating and Waterproof Biobased Concrete. Ph.D. Thesis, Normandie Université, Normandie, France, 2021. Available online: <https://theses.hal.science/tel-03549160> (accessed on 28 March 2024).
56. Fuente, E.; Jarabo, R.; Blanco, Á.; Negro, C. 10—Hatschek process as a way to valorize agricultural wastes: Effects on the process and product quality. In *Sustainable and Nonconventional Construction Materials Using Inorganic Bonded Fiber Composites*; Savastano Junior, H., Fiorelli, J., dos Santos, S.F., Eds.; Woodhead Publishing: Sawston, UK, 2017; pp. 267–290. [CrossRef]
57. Jhala, A.; Hall, L. Flax (*Linum usitatissimum* L.): Current uses and future applications. *Aust. J. Basic Appl. Sci.* **2010**, *4*, 4304–4312.
58. Le lin—Plante Miracle. Available online: <http://www.patrimoine-normand.com/article-144978-le-lin-normandie.html> (accessed on 28 March 2024).
59. Li, X.; Tabil, L.G.; Oguocha, I.N.; Panigrahi, S. Thermal diffusivity, thermal conductivity, and specific heat of flax fiber–HDPE biocomposites at processing temperatures. *Compos. Sci. Technol.* **2008**, *68*, 1753–1758. [CrossRef]
60. Dubois, V.; Leblanc, A.; Carpentier, O.; Alhaik, G.; Wirquin, E. Performances of flax shive-based lightweight composites with rapid hardening. *Constr. Build. Mater.* **2018**, *165*, 17–27. [CrossRef]
61. Mahieu, A.; Alix, S.; Leblanc, N. Properties of particleboards made of agricultural by-products with a classical binder or self-bound. *Ind. Crops Prod.* **2019**, *130*, 371–379. [CrossRef]
62. Ross, K.; Giuseppe, M. Characteristics of Lignin from Flax Shives as Affected by Extraction Conditions. *Int. J. Mol. Sci.* **2010**, *11*, 4035. [CrossRef] [PubMed]
63. Flax Shives Refining, Chemical Modification and Hydrophobisation for Paper Production | Mohini Sain—Academia.edu. Available online: https://www.academia.edu/30062131/Flax_shives_refining_chemical_modification_and_hydrophobisation_for_paper_production (accessed on 28 March 2024).
64. Rahim, M.; Douzane, O.; Tran Le, A.; Promis, G.; Laidoudi, B.; Crigny, A.; Dupre, B.; Langlet, T. Characterization of flax lime and hemp lime concretes: Hygric properties and moisture buffer capacity. *Energy Build.* **2015**, *88*, 91–99. [CrossRef]
65. Dechant, J. Handbook of fiber science and technology. vol. IV. fiber chemistry. Hg. van MENACHEM LEWIN und ELI M. PEARCE. ISBN 0-8247-7335-7. New York/Basel: Marcel Dekker, Inc. 1985. XXIII, 1090 S., geb., \$ 234.00. *Acta Polym.* **1987**, *38*, 507–508. [CrossRef]

66. L'isolation Acoustique par Le Lin. Le Lin Côté Nature. Available online: <https://www.lelin-cotenature.fr/FR/l-isolation-acoustique-par-le-lin-177.html> (accessed on 28 March 2024).
67. Pantaloni, D. Multiscale Characterisation of Biodegradable Flax Composites through Structural, Mechanical and Ageing Investigations. Ph.D. Thesis, Université de Bretagne Sud, Rennes, France, 2021. Available online: <https://theses.hal.science/tel-03704137> (accessed on 28 March 2024).
68. Brachelet, F.; Asli, M.; Antczak, E.; Brue, F.; Defer, D.; Lucas, A. Hygrothermal behaviour of flax shives used as insulation material in an attic of a traditional house. *MATEC Web Conf.* **2020**, *307*, 01017. [[CrossRef](#)]
69. Benmahiddine, F.; Cherif, R.; Bennai, F.; Belarbi, R.; Tahakourt, A.; Abahri, K. Effect of flax shives content and size on the hygrothermal and mechanical properties of flax concrete. *Constr. Build. Mater.* **2020**, *262*, 120077. [[CrossRef](#)]
70. Bos, H.L.; Van Den Oever, M.J.A.; Peters, O.C.J.J. Tensile and compressive properties of flax fibres for natural fibre reinforced composites. *J. Mater. Sci.* **2002**, *37*, 1683–1692. [[CrossRef](#)]
71. New Frontier Data. Biden Administration May Catalyze Hemp Fiber Segment. New Frontier Data. Available online: <https://newfrontierdata.com/cannabis-insights/biden-administration-may-catalyze-hemp-fiber-segment/> (accessed on 28 March 2024).
72. König, C. Classification des Algues: Algues Rouges, Algues Bleues. Futura. Available online: <https://www.futura-sciences.com/planete/dossiers/botanique-algues-surprenants-vegetaux-aquatiques-523/page/7/> (accessed on 28 March 2024).
73. Les Dangers de l'Algue Verte: H2S. Available online: <https://www.be-atex.com/actualites/focus/les-dangers-de-lalgue-verte-h2s> (accessed on 28 March 2024).
74. Auroreensapm. Recycler un Déchet Naturel dans les Matériaux de Construction. Matériaux Pour l'éco-Conception. Available online: <https://seminairematériaux.wordpress.com/2014/02/10/recycler-un-dechet-naturel-dans-les-materiaux-de-construction/> (accessed on 28 March 2024).
75. Siddique, M.N.I.; Wahid, Z. Effect of mixing proportion on the properties of seaweed modified sustainable concrete. In *AIP Conference Proceedings*; AIP Publishing: Melville, NY, USA, 2017; Volume 1891. [[CrossRef](#)]
76. Bouasria, M.; El Mendili, Y.; Benzaama, M.-H.; Pralong, V.; Bardeau, J.-F.; Hennequart, F. Valorisation of stranded *Laminaria digitata* seaweed as an insulating earth material. *Constr. Build. Mater.* **2021**, *308*, 125068. [[CrossRef](#)]
77. Benmansour, N.; Agoudjil, B.; Gherabli, A.; Kareche, A.; Boudenne, A. Thermal and mechanical performance of natural mortar reinforced with date palm fibers for use as insulating materials in building. *Energy Build.* **2014**, *81*, 98–104. [[CrossRef](#)]
78. Lewandowski, I.; Clifton-Brown, J.; Kiesel, A.; Hastings, A.; Iqbal, Y. 2—Miscanthus. In *Perennial Grasses for Bioenergy and Bioproducts*; Alexopoulou, E., Ed.; Academic Press: Cambridge, MA, USA, 2018; pp. 35–59. [[CrossRef](#)]
79. Lv, Y.; Ye, G.; De Schutter, G. Utilization of miscanthus combustion ash as internal curing agent in cement-based materials: Effect on autogenous shrinkage. *Constr. Build. Mater.* **2019**, *207*, 585–591. [[CrossRef](#)]
80. Ben Fradj, N.; Rozakis, S.; Borzęcka, M.; Matyka, M. Miscanthus in the European bio-economy: A network analysis. *Ind. Crops Prod.* **2020**, *148*, 112281. [[CrossRef](#)]
81. Chen, Y.; Yu, Q.L.; Brouwers, H.J.H. Acoustic performance and microstructural analysis of bio-based lightweight concrete containing miscanthus. *Constr. Build. Mater.* **2017**, *157*, 839–851. [[CrossRef](#)]
82. Ntimugura, F.; Vinai, R.; Harper, A.B.; Walker, P. Environmental performance of miscanthus-lime lightweight concrete using life cycle assessment: Application in external wall assemblies. *Sustain. Mater. Technol.* **2021**, *28*, e00253. [[CrossRef](#)]
83. Pereira Dias, P.; Bhagya Jayasinghe, L.; Waldmann, D. Machine learning in mix design of Miscanthus lightweight concrete. *Constr. Build. Mater.* **2021**, *302*, 124191. [[CrossRef](#)]
84. Boix, E.; Gineau, E.; Narciso, J.O.; Höfte, H.; Mouille, G.; Navard, P. Influence of chemical treatments of miscanthus stem fragments on polysaccharide release in the presence of cement and on the mechanical properties of bio-based concrete materials. *Cem. Concr. Compos.* **2020**, *105*, 103429. [[CrossRef](#)]
85. Wu, F.; Yu, Q.; Brouwers, H.J.H. Long-term performance of bio-based miscanthus mortar. *Constr. Build. Mater.* **2022**, *324*, 126703. [[CrossRef](#)]
86. Ohmura, T.; Tsuboi, M.; Tomimura, T. Estimation of the Mean Thermal Conductivity of Anisotropic Materials. *Int. J. Thermophys.* **2002**, *23*, 843–853. [[CrossRef](#)]
87. Bio-Aggregate-Based Building Materials: Applications to Hemp Concretes | Wiley. Wiley.com. Available online: <https://www.wiley.com/en-us/Bio+aggregate+based+Building+Materials:+Applications+to+Hemp+Concretes-p-9781848214040> (accessed on 28 March 2024).
88. Lahouioui, M.; Fois, M.; Ghorbal, A.; Ibos, L.; Arfi, R.B.; Brahim, A.B. Etude des Performances Thermiques et Mécaniques de Matériaux à Matrice Cimentaire Renforcés par des Fibres de Bois de Palmier. 2016. Available online: https://www.certes-upec.fr/wp-content/uploads/2020/07/Lahouioui_2017_SFT_ciment_palmier-1.pdf (accessed on 28 March 2024).
89. Arnaud, L.; Gourlay, E. Experimental study of parameters influencing mechanical properties of hemp concretes. *Constr. Build. Mater.* **2012**, *28*, 50–56. [[CrossRef](#)]
90. Chabannes, M.; Becquart, F.; Garcia-Diaz, E.; Abriak, N.-E.; Clerc, L. Experimental investigation of the shear behaviour of hemp and rice husk-based concretes using triaxial compression. *Constr. Build. Mater.* **2017**, *143*, 621–632. [[CrossRef](#)]
91. NF ISO 5017; Dense Shaped Refractory Products—Determination of Bulk Density, Apparent Porosity and True Porosity. ISO: Geneva, Switzerland, 2013. Available online: <https://www.boutique.afnor.org/fr-fr/norme/nf-iso-5017/produits-refractaires-faconnes-denses-determination-de-la-masse-volumique-a/fa169530/41164> (accessed on 28 March 2024).

92. Walker, R.; Pavia, S.; Mitchell, R. Mechanical properties and durability of hemp-lime concretes. *Constr. Build. Mater.* **2014**, *61*, 340–348. [CrossRef]
93. Evrard: Hemp Concretes—A Synthesis of Physical Properties—Google Scholar. Available online: https://scholar.google.com/scholar_lookup?title=Hemp%20Concretes:%20A%20Synthesis%20of%20Physical%20Properties&publication_year=2003&author=A.%20Evrard (accessed on 28 March 2024).
94. Murphy, F.; Pavía, S.; Walker, R. An Assessment of Some. Available online: <https://scholar.google.com/scholar?q=Murphy%20F,%20Pav%20S,%20Walker%20R.%20An%20assessment%20of%20some%20physical%20properties%20of%20hemp-lime%20concrete.%20In:%20Proceedings%20of%20the%20BCRI%20bridge%20infrastructure%20concrete%20research%20ireland,%20Univ.%20of%20Cork,%20Ireland,%202010.%20p.%2043138> (accessed on 28 March 2024).
95. Hirst, E.; Walker, P.; Paine, K.; Yates, T. Characterisation of low density hemp-lime composite building materials under compression loading. In Proceedings of the Second International Conference on Sustainable Construction Materials and Technologies, Ancona, Italy, 28–30 June 2010; pp. 28–30.
96. Gourlay, E.; Arnaud, L. Des matières premières au béton de chanvre: Optimisation des propriétés thermiques et mécaniques. In Proceedings of the CFM 2011—20ème Congrès Français de Mécanique, AFM, Maison de la Mécanique, Courbevoie, France, 29 August–2 September 2011.
97. Butschi, P.-Y. Utilisation du Chanvre pour la Préfabrication d’Éléments de Construction. Thèse de Génie Civil, Faculté d’Ingénieurs, Université de Moncton, Moncton, NB, Canada, 2005.
98. Nguyen, T.T. Contribution à l’Étude de la Formulation et du Procédé de Fabrication d’Éléments de Construction en Béton de Chanvre. Ph.D. Thesis, Université de Bretagne Sud, Rennes, France, 2010.
99. Elfordy, S.; Lucas, F.; Tancret, F.; Scudeller, Y.; Goudet, L. Mechanical and thermal properties of lime and hemp concrete (“hempcrete”) manufactured by a projection process. *Constr. Build. Mater.* **2008**, *22*, 2116–2123. [CrossRef]
100. Cérézo, V. Propriétés Mécaniques, Thermiques et Acoustiques d’un Matériau à Base de Particules Végétales: Approche Expérimentale et Modélisation Théorique. Ph.D. Thesis, INSA, Lyon, France, 2005. Available online: <https://www.theses.fr/2005ISAL0037> (accessed on 28 March 2024).
101. Boulloc: Le Chanvre Industriel: Production et Utilisations—Google Scholar. Available online: https://scholar.google.com/scholar_lookup?title=Le%20chanvre%20industriel:%20production%20et%20utilisations&publication_year=2006&author=P.%20Boulloc&author=S.%20Allegret&author=L.%20Arnaud (accessed on 28 March 2024).
102. Stevulova, N.; Kidalova, L.; Cigasova, J.; Junak, J.; Sicakova, A.; Terpakova, E. Lightweight Composites Containing Hemp Hurds. *Procedia Eng.* **2013**, *65*, 69–74. [CrossRef]
103. Ali, M.; Liu, A.; Sou, H.; Chouw, N. Mechanical and dynamic properties of coconut fibre reinforced concrete. *Constr. Build. Mater.* **2012**, *30*, 814–825. [CrossRef]
104. Le, A.T.; Gacoin, A.; Li, A.; Mai, T.H.; El Wakil, N. Influence of various starch/hemp mixtures on mechanical and acoustical behavior of starch-hemp composite materials. *Compos. Part B Eng.* **2015**, *75*, 201–211. [CrossRef]
105. Nozahic, V.; Amziane, S.; Torrent, G.; Saïdi, K.; De Baynast, H. Design of green concrete made of plant-derived aggregates and a pumice–lime binder. *Cem. Concr. Compos.* **2012**, *34*, 231–241. [CrossRef]
106. Stevulova, N.; Kidalova, L.; Junak, J.; Cigasova, J.; Terpakova, E. Effect of Hemp Shive Sizes on Mechanical Properties of Lightweight Fibrous Composites. *Procedia Eng.* **2012**, *42*, 496–500. [CrossRef]
107. Balčiūnas, G.; Pundienė, I.; Lekūnaitė-Lukošiūnė, L.; Vėjelis, S.; Korjakins, A. Impact of hemp shives aggregate mineralization on physical–mechanical properties and structure of composite with cementitious binding material. *Ind. Crops Prod.* **2015**, *77*, 724–734. [CrossRef]
108. T.-Nguyen, T.; Picandet, V.; Amziane, S.; Baley, C. Influence of compactness and hemp hurd characteristics on the mechanical properties of lime and hemp concrete. *Eur. J. Environ. Civ. Eng.* **2009**, *13*, 1039–1050. [CrossRef]
109. Nguyen, T.T.; Picandet, V.; Carre, P.; Lecompte, T.; Amziane, S.; Baley, C. Effect of compaction on mechanical and thermal properties of hemp concrete. *Eur. J. Environ. Civ. Eng.* **2010**, *14*, 545–560. [CrossRef]
110. de et Bruijn, P. Hemp Concretes: Mechanical Properties Using Both Shives and Fibres. 2008. Available online: <https://res.slu.se/id/publ/24988> (accessed on 28 March 2024).
111. Walker, R. A Study of the Properties of Lime-Hemp Concrete with. Pozzolans. Ph.D. Thesis, Department of Civil, Structural and Environmental Engineering, Trinity College, Dublin, Ireland, 2013. Available online: <http://www.tara.tcd.ie/handle/2262/79389> (accessed on 28 March 2024).
112. Allen: Lime as a Building Material—Google Scholar. Available online: https://scholar.google.com/scholar_lookup?title=An%20Investigation%20of%20Hemp%20and%20Lime%20as%20a%20Building%20Material&publication_year=2005&author=J.%20Dowd&author=D.%20Quinn (accessed on 28 March 2024).
113. Jami, T.; Rawtani, D.; Agrawal, Y.K. Hemp concrete: Carbon-negative construction. *Emerg. Mater. Res.* **2016**, *5*, 240–247. [CrossRef]
114. Cigasova, J.; Stevulova, N.; Schwarzova, I.; Junak, J. Innovative Use of Biomass Based on Technical Hemp in Building Industry. *Chem. Eng. Trans.* **2014**, *37*, 685–690. [CrossRef]
115. Walker, R.; Pavia, S. An Assessment of Some Physical Properties of Lime-Hemp Concrete. 2010. Available online: <http://www.tara.tcd.ie/handle/2262/57402> (accessed on 28 March 2024).
116. de Bruijn, P.B.; Jeppsson, K.-H.; Sandin, K.; Nilsson, C. Mechanical properties of lime–hemp concrete containing shives and fibres. *Biosyst. Eng.* **2009**, *103*, 474–479. [CrossRef]

117. Mukherjee, A.; MacDougall, C. Structural benefits of hempcrete infill in timber stud walls. *Int. J. Sustain. Build. Technol. Urban Dev.* **2013**, *4*, 295–305. [CrossRef]
118. Dartois, S.; Mom, S.; Dumontet, H.; Ben Hamida, A. An iterative micromechanical modeling to estimate the thermal and mechanical properties of polydisperse composites with platy particles: Application to anisotropic hemp and lime concretes. *Constr. Build. Mater.* **2017**, *152*, 661–671. [CrossRef]
119. Williams, J.; Lawrence, M.; Walker, P. A method for the assessment of the internal structure of bio-aggregate concretes. *Constr. Build. Mater.* **2016**, *116*, 45–51. [CrossRef]
120. Tronet, P.; Lecompte, T.; Picandet, V.; Baley, C. Study of lime hemp concrete (LHC)—Mix design, casting process and mechanical behaviour. *Cem. Concr. Compos.* **2016**, *67*, 60–72. [CrossRef]
121. Sassu, M.; Giresini, L.; Bonannini, E.; Puppio, M.L. On the Use of Vibro-Compressed Units with Bio-Natural Aggregate. *Buildings* **2016**, *6*, 40. [CrossRef]
122. Le, A.D.T. Etude des Transferts Hygrothermiques dans le Béton de Chanvre et Leur Application au Bâtiment (Sous Titre: Simulation Numérique et Approche Expérimentale). Ph.D. Thesis, Université de Reims—Champagne Ardenne, Reims, France, 2010. Available online: <https://theses.hal.science/tel-00590819> (accessed on 28 March 2024).
123. Widera, B. Possible Application of Seaweed as Building Material in the Modern Seaweed House on Laesø. In Proceedings of the 30th International PLEA Conference, Ahmedabad, India, 16–18 December 2014. [CrossRef]
124. Etude et Suivi des Marées Vertes en Normandie. CEVA. Available online: <https://www.ceva-algues.com/document/algues-vertes-en-normandie/> (accessed on 28 March 2024).
125. Barros, F.C.; da Silva, D.C.; Sombra, V.G.; Maciel, J.S.; Feitosa, J.P.; Freitas, A.L.; de Paula, R.C. Structural characterization of polysaccharide obtained from red seaweed *Gracilaria caudata* (J Agardh). *Carbohydr. Polym.* **2013**, *92*, 598–603. [CrossRef] [PubMed]
126. Susilorini, R.M.R.; Hardjasaputra, H.; Tudjono, S.; Hapsari, G.; Wahyu, S.R.; Hadikusumo, G.; Sucipto, J. The Advantage of Natural Polymer Modified Mortar with Seaweed: Green Construction Material Innovation for Sustainable Concrete. *Procedia Eng.* **2014**, *95*, 419–425. [CrossRef]
127. Salamah, E.; Erungan, A.C.; Retnowati, Y. Pemanfaatan *Gracilaria* sp. dalam pembuatan permen jelly. *Indones. J. Aquat. Prod. Technol.* **2006**, *9*.
128. Abdullah, H.M.; Abdul Latif, M.H.; Attiya, H.G. Characterization and determination of lignin in different types of Iraqi phoenix date palm pruning woods. *Int. J. Biol. Macromol.* **2013**, *61*, 340–346. [CrossRef] [PubMed]
129. AlMaadeed, M.A.; Kahraman, R.; Noorunnisa Khanam, P.; Madi, N. Date palm wood flour/glass fibre reinforced hybrid composites of recycled polypropylene: Mechanical and thermal properties. *Mater. Des.* **2012**, *42*, 289–294. [CrossRef]
130. AlMaadeed, M.A.; Nógellová, Z.; Janigová, I.; Krupa, I. Improved mechanical properties of recycled linear low-density polyethylene composites filled with date palm wood powder. *Mater. Des.* **2014**, *58*, 209–216. [CrossRef]
131. Vo, L.T.T.; Navard, P. Treatments of plant biomass for cementitious building materials—A review. *Constr. Build. Mater.* **2016**, *121*, 161–176. [CrossRef]
132. Dias, P.P.; Jayasinghe, L.B.; Waldmann, D. Investigation of Mycelium-Miscanthus composites as building insulation material. *Results Mater.* **2021**, *10*, 100189. [CrossRef]
133. El Hage, R.; Khalaf, Y.; Lacoste, C.; Nakhil, M.; Lacroix, P.; Bergeret, A. A flame retarded chitosan binder for insulating miscanthus/recycled textile fibers reinforced biocomposites. *J. Appl. Polym. Sci.* **2019**, *136*, 47306. [CrossRef]
134. Schnabel, T.; Huber, H.; Petutschnigg, A.; Jäger, A. Analysis of plant materials pre-treated by steam explosion technology for their usability as insulating materials. *Agron. Res.* **2019**, *17*, 1191–1198. [CrossRef]
135. Eschenhagen, A.; Raj, M.; Rodrigo, N.; Zamora, A.; Labonne, L.; Evon, P.; Weleman, H. Investigation of Miscanthus and Sunflower Stalk Fiber-Reinforced Composites for Insulation Applications. *Adv. Civ. Eng.* **2019**, *2019*, e9328087. [CrossRef]
136. Khalid, M.Y.; Al Rashid, A.; Arif, Z.U.; Ahmed, W.; Arshad, H.; Zaidi, A.A. Natural fiber reinforced composites: Sustainable materials for emerging applications. *Results Eng.* **2021**, *11*, 100263. [CrossRef]
137. NF EN ISO 12572. Afnor EDITIONS. Available online: <https://www.boutique.afnor.org/en-gb/standard/nf-en-iso-12572/hygrothermal-performance-of-building-materials-and-products-determination-o/fa184538/57928> (accessed on 28 March 2024).
138. Mustapha, R.; Zoughaib, A.; Ghaddar, N.; Ghali, K. Modified upright cup method for testing water vapor permeability in porous membranes. *Energy* **2020**, *195*, 117057. [CrossRef]
139. Haba, B.; Agoudjil, B.; Boudenne, A.; Benzarti, K. Hygric properties and thermal conductivity of a new insulation material for building based on date palm concrete. *Constr. Build. Mater.* **2017**, *154*, 963–971. [CrossRef]
140. Walker, R.; Pavia, S. Moisture transfer and thermal properties of hemp–lime concretes. *Constr. Build. Mater.* **2014**, *64*, 270–276. [CrossRef]
141. Rode, C.; Reuhkuri, R.; Time, B.; Gustavsan, A.; Ojanen, T.; Ahonen, J.; Svennberg, K. *Moisture Buffering of Building Materials*; Technical University of Denmark, Department of Civil Engineering: Kongens Lyngby, Denmark, 2005.
142. Shea, A.; Lawrence, M.; Walker, P. Hygrothermal performance of an experimental hemp–lime building. *Constr. Build. Mater.* **2012**, *36*, 270–275. [CrossRef]
143. Tran Le, A.D.; Maalouf, C.; Mai, T.H.; Wurtz, E.; Collet, F. Transient hygrothermal behaviour of a hemp concrete building envelope. *Energy Build.* **2010**, *42*, 1797–1806. [CrossRef]
144. Yang, X.; Ge, H.; Fazio, P.; Rao, J. Evaluation of Parameters Influencing the Moisture Buffering Potential of Hygroscopic Materials with BSim Simulations. *Buildings* **2014**, *4*, 375. [CrossRef]

145. Collet, F.; Pretot, S. Experimental highlight of hygrothermal phenomena in hemp concrete wall. *Build. Environ.* **2014**, *82*, 459–466. [CrossRef]
146. Saba, N.; Alothman, O.Y.; Almutairi, Z.; Jawaid, M.; Ghori, W. Date palm reinforced epoxy composites: Tensile, impact and morphological properties. *J. Mater. Res. Technol.* **2019**, *8*, 3959–3969. [CrossRef]
147. Latif, E.; Lawrence, M.; Shea, A.; Walker, P. Moisture buffer potential of experimental wall assemblies incorporating formulated hemp-lime. *Build. Environ.* **2015**, *93*, 199–209. [CrossRef]
148. Association, J.S. Test Method of Adsorption/Desorption Efficiency for Building Materials to Regulate an Indoor Humidity. Japanese Industrial Standard (JIS) A 1470-2. 2002. Available online: <https://cir.nii.ac.jp/crid/1570854175657122944> (accessed on 28 March 2024).
149. Padfield, T.; Jensen, L.A. Humidity buffering of building interiors by absorbent materials. In Proceedings of the Nordic Symposium on Building Physics, Tampere, Finland, 29 May–2 June 2011; Volume 1, p. 8.
150. ISO 24353:2008/Amd 1:2021; Hygrothermal Performance of Building Materials and Products—Determination of Moisture Adsorption/Desorption Properties in Response to Humidity Variation. ISO: Geneva, Switzerland, 2021. Available online: <https://www.iso.org/standard/79351.html> (accessed on 28 March 2024).
151. Wu, Y.; Gong, G.; Yu, C.W.; Huang, Z. Proposing ultimate moisture buffering value (UMBV) for characterization of composite porous mortars. *Constr. Build. Mater.* **2015**, *82*, 81–88. [CrossRef]
152. Yang, X.; Fazio, P.; Ge, H.; Rao, J. Evaluation of moisture buffering capacity of interior surface materials and furniture in a full-scale experimental investigation. *Build. Environ.* **2012**, *47*, 188–196. [CrossRef]
153. Mukhopadhyaya, P.; Kumaran, M.K. *Heat-Air-Moisture Transport: Measurements on Building Materials*; ASTM International: West Conshohocken, PA, USA, 2007.
154. Lelievre, D.; Colinart, T.; Glouannec, P. Hygrothermal behavior of bio-based building materials including hysteresis effects: Experimental and numerical analyses. *Energy Build.* **2014**, *84*, 617–627. [CrossRef]
155. Collet, F.; Chamoin, J.; Pretot, S.; Lanos, C. Comparison of the hygric behaviour of three hemp concretes. *Energy Build.* **2013**, *62*, 294–303. [CrossRef]
156. Collet, F.; Pretot, S. Experimental investigation of moisture buffering capacity of sprayed hemp concrete. *Constr. Build. Mater.* **2012**, *36*, 58–65. [CrossRef]
157. NF EN ISO 12571; Performance Hygrothermique des Matériaux et Produits pour le Bâtiment—Détermination des Propriétés de Sorption Hygroscopique. ISO: Geneva, Switzerland, 2013. Available online: <https://m.boutique.afnor.org/fr-fr/norme/nf-en-iso-12571/performance-hygrothermique-des-materiaux-et-produits-pour-le-batiment-deter/fa177734/42249> (accessed on 28 March 2024).
158. Fabbri, A.; McGregor, F. Impact of the determination of the sorption-desorption curves on the prediction of the hemp concrete hygrothermal behaviour. *Constr. Build. Mater.* **2017**, *157*, 108–116. [CrossRef]
159. Zeyad, A.M.; Tayeh, B.A.; Adesina, A.; de Azevedo, A.R.; Amin, M.; Hadzima-Nyarko, M.; Agwa, I.S. Review on effect of steam curing on behavior of concrete. *Clean. Mater.* **2022**, *3*, 100042. [CrossRef]
160. Chen, Y.; Liu, P.; Sha, F.; Yu, Z.; He, S.; Xu, W.; Lv, M. Effects of Type and Content of Fibers, Water-to-Cement Ratio, and Cementitious Materials on the Shrinkage and Creep of Ultra-High Performance Concrete. *Polymers* **2022**, *14*, 1956. [CrossRef] [PubMed]
161. He, F.; Biolzi, L.; Carvelli, V. Effects of elevated temperature and water re-curing on the compression behavior of hybrid fiber reinforced concrete. *J. Build. Eng.* **2023**, *67*, 106034. [CrossRef]
162. Calnesis, L.; Mesure de Conductivité Thermique. Laboratoire Calnesis. Available online: <https://www.calnesis.com/mesures/conductivite-thermique/> (accessed on 28 March 2024).
163. Collet, F.; Pretot, S. Thermal conductivity of hemp concretes: Variation with formulation, density and water content. *Constr. Build. Mater.* **2014**, *65*, 612–619. [CrossRef]
164. Arnaud, L.; Boyeux, B.; Hustache, Y. Hemp and the construction industry. In *Hemp: Industrial Production and Uses*; CABI: Wallingford, UK, 2013; pp. 239–259. [CrossRef]
165. Rame, J.-M. Habitat et Santé: Synthèse des Deuxièmes Journées du Réseau d’Allergologie de Franche-comté (RAFT). *Revue Française d’Allergologie* **2010**, *50*, S46–S54. [CrossRef]
166. Dinh, T.M.; Magniont, C.; Coutand, M.; Escadeillas, G. Hemp concrete using innovative pozzolanic binder. *Acad. J. Civ. Eng.* **2015**, *33*, 2. [CrossRef]
167. Magwood, C. *Essential Hempcrete Construction: The Complete Step-by-Step Guide*; New Society Publishers: Gabriola Island, BC, Canada, 2016; Available online: <https://newsociety.com/products/9780865718197> (accessed on 28 March 2024).
168. Tran-Le, A.D.; Nguyen, S.-T.; Langlet, T. A novel anisotropic analytical model for effective thermal conductivity tensor of dry lime-hemp concrete with preferred spatial distributions. *Energy Build.* **2019**, *182*, 75–87. [CrossRef]
169. Nguyen, S.T.; Tran-Le, A.D.; Vu, M.N.; To, Q.D.; Douzane, O.; Langlet, T. Modeling thermal conductivity of hemp insulation material: A multi-scale homogenization approach. *Build. Environ.* **2016**, *107*, 127–134. [CrossRef]
170. Benmahiddine, F.; Bennai, F.; Cherif, R.; Belarbi, R.; Tahakourt, A.; Abahri, K. Experimental investigation on the influence of immersion/drying cycles on the hygrothermal and mechanical properties of hemp concrete. *J. Build. Eng.* **2020**, *32*, 101758. [CrossRef]
171. Liu, M.Y.J.; Alengaram, U.J.; Jumaat, M.Z.; Mo, K.H. Evaluation of thermal conductivity, mechanical and transport properties of lightweight aggregate foamed geopolymer concrete. *Energy Build.* **2014**, *72*, 238–245. [CrossRef]

172. Asadi, I.; Shafigh, P.; Hassan, Z.F.A.B.; Mahyuddin, N.B. Thermal conductivity of concrete—A review. *J. Build. Eng.* **2018**, *20*, 81–93. [CrossRef]
173. Trechsel, H.R. *Moisture Analysis and Condensation Control in Building Envelopes*; ASTM International: West Conshohocken, PA, USA, 2001; Available online: https://books.google.fr/books/about/Moisture_Analysis_and_Condensation_Contr.html?id=g9FSAAAAMAAJ&redir_esc=y (accessed on 28 March 2024).
174. Bennai, F.; Abahri, K.; Belarbi, R. Contribution to the Modelling of Coupled Heat and Mass Transfers on 3D Real Structure of Heterogeneous Building Materials: Application to Hemp Concrete. *Transp. Porous Media* **2020**, *133*, 333–356. [CrossRef]
175. Amziane, S. Influence of Wetting-Drying Cycles on the Mechanical, Physico-Chemical, and Microstructural Properties of Hemp Concretes. Available online: https://www.academia.edu/18135297/Influence_of_wetting_drying_cycles_on_the_mechanical_physico_chemical_and_microstructural_properties_of_hemp_concretes (accessed on 28 March 2024).
176. Sassoni, E.; Manzi, S.; Motori, A.; Montecchi, M.; Canti, M. Experimental study on the physical–mechanical durability of innovative hemp-based composites for the building industry. *Energy Build.* **2015**, *104*, 316–322. [CrossRef]
177. Mazhoud, B.; Collet, F.; Pretot, S.; Chamoin, J. Hygric and thermal properties of hemp-lime plasters. *Build. Environ.* **2016**, *96*, 206–216. [CrossRef]
178. Vitola, L.; Gendelis, S.; Sinka, M.; Pundiene, I.; Bajare, D. Assessment of Plant Origin By-Products as Lightweight Aggregates for Bio-Composite Bounded by Starch Binder. *Energies* **2022**, *15*, 5330. [CrossRef]
179. Proceedings of the 4th Congrès International de Géotechnique—Ouvrages-Structures: CIGOS 2017, 26–27 October, Ho Chi Minh City, Vietnam | SpringerLink. Available online: <https://link.springer.com/book/10.1007/978-981-10-6713-6> (accessed on 28 March 2024).
180. Wu, M.; Johannesson, B.; Geiker, M. A study of the water vapor sorption isotherms of hardened cement pastes: Possible pore structure changes at low relative humidity and the impact of temperature on isotherms. *Cem. Concr. Res.* **2014**, *56*, 97–105. [CrossRef]
181. EN 15304:2010; Determination of the Freeze-Thaw Resistance of Autoclaved Aerated Concrete. iTeh Standards: Etobicoke, ON, Canada, 2010. Available online: <https://standards.iteh.ai/catalog/standards/cen/412c9869-4350-403a-83d8-47cbc0d80305/en-15304-2010> (accessed on 28 March 2024).
182. Matalkah, F.; Soroushian, P. Freeze thaw and deicer salt scaling resistance of concrete prepared with alkali aluminosilicate cement. *Constr. Build. Mater.* **2018**, *163*, 200–213. [CrossRef]
183. Yang, R.; He, T.; Guan, M.; Xu, Y.; Ma, X.; Lin, Y.; Gui, M.; Ke, Y. Experimental study on sulfate resistance of shotcrete with different liquid accelerators. *Case Stud. Constr. Mater.* **2022**, *16*, e01100. [CrossRef]
184. De Muynck, W.; De Belie, N.; Verstraete, W. Effectiveness of admixtures, surface treatments and antimicrobial compounds against biogenic sulfuric acid corrosion of concrete. *Cem. Concr. Compos.* **2009**, *31*, 163–170. [CrossRef]
185. Vincke, E.; Verstichel, S.; Monteny, J.; Verstraete, W. A new test procedure for biogenic sulfuric acid corrosion of concrete. *Biodegradation* **1999**, *10*, 421–428. [CrossRef] [PubMed]
186. Bedada, K.; Nyabuto, A.; Kinoti, I.; Marangu, J. Review on Advances in Bio-based Admixtures for Concrete. *J. Sustain. Constr. Mater. Technol.* **2023**, *8*. [CrossRef]
187. Aher, P.D.; Patil, Y.D.; Waysal, S.M.; Bhoi, A.M. Critical review on biopolymer composites used in concrete. *Mater. Today Proc.* **2023**. [CrossRef]
188. Bourbia, S.; Kazeoui, H.; Belarbi, R. A review on recent research on bio-based building materials and their applications. *Mater. Renew. Sustain. Energy* **2023**, *12*, 117–139. [CrossRef]
189. Ghorbel, E.; Limaiem, M.; Wardeh, G. Mechanical Performance of Bio-Based FRP-Confined Recycled Aggregate Concrete under Uniaxial Compression. *Materials* **2021**, *14*, 1778. [CrossRef] [PubMed]

Disclaimer/Publisher’s Note: The statements, opinions and data contained in all publications are solely those of the individual author(s) and contributor(s) and not of MDPI and/or the editor(s). MDPI and/or the editor(s) disclaim responsibility for any injury to people or property resulting from any ideas, methods, instructions or products referred to in the content.