



**HAL**  
open science

# Unified Adaptive Flux Observer for AC Machines

Rashad Ghassani, Zohra Kader, Maurice Fadel, Pascal Combes

► **To cite this version:**

Rashad Ghassani, Zohra Kader, Maurice Fadel, Pascal Combes. Unified Adaptive Flux Observer for AC Machines. 2024 IEEE International Conference on Industrial Technology (ICIT), Mar 2024, Bristol, United Kingdom. pp.1-6, 10.1109/ICIT58233.2024.10540751 . hal-04603144

**HAL Id: hal-04603144**

**<https://hal.science/hal-04603144v1>**

Submitted on 6 Jun 2024

**HAL** is a multi-disciplinary open access archive for the deposit and dissemination of scientific research documents, whether they are published or not. The documents may come from teaching and research institutions in France or abroad, or from public or private research centers.

L'archive ouverte pluridisciplinaire **HAL**, est destinée au dépôt et à la diffusion de documents scientifiques de niveau recherche, publiés ou non, émanant des établissements d'enseignement et de recherche français ou étrangers, des laboratoires publics ou privés.

# Unified Adaptive Flux Observer for AC Machines

Rashad Ghassani

*Université de Toulouse*

*Laplace Laboratory, CNRS, INPT, UPS*

Toulouse, France

rashad.ghassani@laplace.univ-tlse.fr

Zohra Kader

*Université de Toulouse*

*Laplace Laboratory, CNRS, INPT, UPS*

Toulouse, France

zohra.kader@laplace.univ-tlse.fr

Maurice Fadel

*Université de Toulouse*

*Laplace Laboratory, CNRS, INPT, UPS*

Toulouse, France

maurice.fadel@laplace.univ-tlse.fr

Pascal Combes

*Schneider Toshiba Inverter Europe*

*Schneider Electric*

Pacy-sur-Eure, France

pascal.combes@se.com

**Abstract**—This work develops a novel unified observer for flux estimation in ac machines. It has been demonstrated that a unified adaptive flux observer based on the active flux concept can be implemented for both Permanent Magnet Synchronous Machines (PMSMs) and Induction Machines (IMs). Using the well-known "Voltage Model" (VM) in addition to the modified "Current Model" (CM), a full-order adaptive flux observer can be designed. This unified state observer is essentially the same for all ac machines, in which only the stator resistance and equivalent inductance are needed. The stability conditions of this novel flux observer scheme based on the proposed model have been derived analytically using the Lyapunov theory. Digital simulations in MATLAB/Simulink are given to illustrate the theoretical results for both PMSMs and IMs. Finally, experimental tests were done on both IMs and PMSMs to validate the proposed unified observer's performance.

**Index Terms**—ac machines, active flux, unified observer

## A. Nomenclature

The notations used in this paper are as follows:

$\bar{v}_s$	Stator voltage complex space vector
$\bar{i}_s$	Stator current complex space vector
$\bar{\psi}_s$	Stator flux complex space vector
$\bar{\psi}_a$	Active flux complex space vector
$\omega$	Synchronous angular speed
$\theta$	Rotor flux angular position
$\theta_s$	Stator flux angular position
$R_s$	Stator resistance
$L_d, L_q$	Direct and quadrature axis stator inductances
$L_\Delta$	$L_d - L_q$
$\psi_m$	PMSM permanent magnet flux
$L_{eq}$	Equivalent stator inductance
$L_s$	Stator inductance
$\sigma$	IM leakage inductance factor
$\sigma L_s$	IM total leakage inductance
$\psi_{rd}$	IM d-axis rotor flux
$k_r$	IM rotor coupling factor
$\dagger$	Hermitian conjugate transpose
$\text{sgn}(x)$	Signum function: $ x  = x \text{sgn}(x)$ , $x \in \mathbb{R}$
$\text{Sgn}(\bar{z})$	$\text{sgn}(\text{Re}(\bar{z})) + j \text{sgn}(\text{Im}(\bar{z}))$ , $\bar{z} \in \mathbb{C}$

## I. INTRODUCTION

Nowadays, Variable-Speed Drives (VSDs) are used in combination with ac motors for motion control to boost industrial output and reduce power consumption. Modern high-performance ac drives often use vector control techniques such as Field-Oriented Control (FOC) [1] and Direct Torque Control (DTC) [2]. There are primarily two approaches to FOC: rotor field orientation [3] and stator field orientation [4]. The flux orientation is required in both methods to convert all of the motor physical quantities into the flux-oriented rotating reference frame [5]. To determine the rotor or stator flux position, a flux observed is normally utilized.

During the last two decades, different flux observers have been proposed in the literature for both synchronous and asynchronous machines [6]. One of the earliest attempts to unify sensorless flux observers for salient and non-salient-pole-synchronous machines was the Extended Electro-Motive Force (EEMF) theory, which simplifies the salient pole machine's nonlinear equations into a linear model [7]. As a result, the flux observers suggested in the literature for non-salient poles Surface-mounted Permanent Magnet Synchronous Machines (SPMSMs) can also be used. However, this method can't extended to asynchronous machines. The Fictitious Permanent-Magnet (FPM) flux model was proposed later to solve the problem of nonlinear equations of salient-pole-synchronous machines as well as the complexity and asymmetry of the EEMF model [8]. However, only PMSMs were involved in these studies. The active flux concept, which was proposed by Boldea et al. [9] was an extension of the FPM idea to Induction Machines (IMs), which is one of the six types of ac motors that are described by the active flux concept. The active flux for IMs is the equivalent rotor flux in the  $\Gamma$ -inverse model and proved to be helpful in the study and analysis of the IM sensorless flux observer [10].

Using the concept of active flux, different flux observers have been proposed with the aim of sensorless control for SMs. For example, in [11] the authors estimate the active flux using an adaptive second-order observer. Similarly, another observer

was suggested for IPMSM to extract the speed in the rotating synchronous frame [12]. All these observers were proposed for PMSMs only. To the author's knowledge, the first unified flux estimation was proposed by Harnefors et al. [13], in which a sensorless unified flux estimator theory was proposed for AC machines. This estimator, however, suffers from a drawback that is heavily impacted by measurement errors and parameter variations. Additionally, only non-salient pole machines were studied in this work.

In this paper, to address the aforementioned limitations, we propose a unified adaptive flux observer based on the active flux model. The unified observer is designed to be used with different types of ac machines, particularly IMs and PMSMs, without altering the observer structure. This paper's novel idea is to estimate the stator and active flux of different ac machines using a single unified observer structure. First, Section II recalls the ac machine unified active flux model in the stator stationary reference frame. A novel full-order adaptive flux observer for ac machines is proposed in Section III. Both the stability analysis and the speed adaptation law are developed in this section using the Lyapunov theory. The numerical simulation results presented in Section IV, show the unified flux observer's performance when tested on both IMs and PMSMs. Finally, the experimental results for the observer on a real test bench, which features both IM and PMSM, are presented in Section V.

## II. MOTOR MODELS

The unified ac machine model is developed in this section using the concept of active flux [9]. All models of ac machines can be expressed as a non-salient PMSM model with an equivalent rotor active flux  $\psi_a$  and an equivalent stator inductance  $L_{eq}$  [14]. Consequently, the stator flux equation can be expressed in the stator stationary frame  $\alpha\beta$  as follows:

$$\bar{\psi}_s = L_{eq}\bar{i}_s + \bar{\psi}_a \quad (1)$$

$$\bar{\psi}_a = \psi_a e^{j\theta}. \quad (2)$$

such that  $L_{eq} = L_q$  for synchronous machines and  $L_{eq} = \sigma L_s$  for asynchronous machines. Depending on the type of machine, the active flux amplitude can be written as follows:

$$\psi_a = \psi_m \quad \text{SPMSM} \quad (3)$$

$$\psi_a = L_{\Delta} i_{sd} + \psi_m \quad \text{IPMSM} \quad (4)$$

$$\psi_a = L_{\Delta} i_{sd} \quad \text{SynRM} \quad (5)$$

$$\psi_a = k_r \psi_{rd} \quad \text{IM}. \quad (6)$$

Using the Voltage Model (VM), the stator flux equation of ac machine is written as follows:

$$\frac{d\bar{\psi}_s}{dt} = \bar{v}_s - R_s \bar{i}_s. \quad (7)$$

Substituting (1) in (7), we obtain:

$$\bar{v}_s = R_s \bar{i}_s + L_{eq} \frac{d\bar{i}_s}{dt} + \frac{d\bar{\psi}_a}{dt}. \quad (8)$$

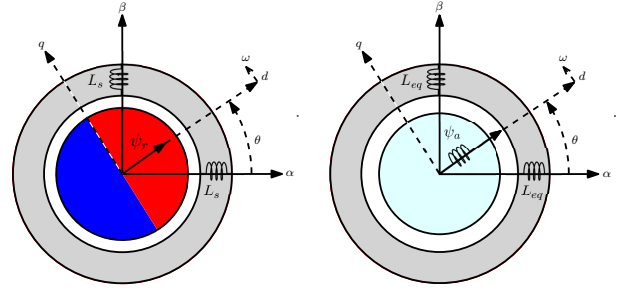

Fig. 1. SPMSM (left) and Unified Model (right)

The torque equation in the active flux model is written as:

$$T_e = \frac{3}{2} n_p \text{Im}(\bar{i}_s \bar{\psi}_a^*) \quad (9)$$

where  $\bar{\psi}_a^*$  is the complex conjugate of  $\bar{\psi}_a$ . The direct axis of the rotating synchronous frame is aligned with the active flux vector (see Fig. 1). Deriving (2) leads to the modified Current Model (CM) written in the active flux framework:

$$\frac{d\bar{\psi}_a}{dt} = j\omega \bar{\psi}_a + \frac{d\psi_a}{dt} e^{j\theta}. \quad (10)$$

Finally, the stator current can be written as the difference between the stator and active flux, as follows:

$$\bar{i}_s = \frac{\bar{\psi}_s - \bar{\psi}_a}{L_{eq}}. \quad (11)$$

Taking  $x = [\bar{\psi}_s \quad \bar{\psi}_a]^T$  as the states of the system and  $u = \bar{v}_s$  as the control input, from (7), (10), and (11), the ac machine unified model can be represented by the following system:

$$\begin{cases} \dot{x} = A(\omega)x + Bu + f(x, \omega, t) \\ \bar{i}_s = Cx \end{cases} \quad (12)$$

such that the matrices  $A(\omega)$ ,  $B$ , and  $C$  are defined as follows:

$$A(\omega) = \begin{bmatrix} -\frac{R_s}{L_{eq}} & \frac{R_s}{L_{eq}} \\ 0 & j\omega \end{bmatrix}, \quad B = [1 \quad 0]^T, \quad C = \begin{bmatrix} \frac{1}{L_{eq}} & \frac{-1}{L_{eq}} \end{bmatrix} \quad (13)$$

and the nonlinear term is modeled by the vector  $f(x, \omega, t)$  as:

$$f(x, \omega, t) = [0 \quad \frac{d\psi_a}{dt} e^{j\omega t}]^T \quad (14)$$

## III. UNIFIED OBSERVER DESIGN

This section presents the proposed unified observer. Using the unified model presented in (12), a unified observer structure is developed under the following assumption:

**Assumption 1.** The time derivative of the active flux amplitude  $\psi_a$  is assumed to be equal to zero (i.e.,  $f(x, \omega, t) = [0 \quad 0]^T$ ).

This assumption is valid for SPMSM and applies to IPMSM, Syn-RM, and IM operated under constant  $d$ -axis stator current  $i_{sd}$  [15]. This also results in a constant  $d$ -axis rotor flux  $\psi_{rd}$  in the case of IM, which is compatible with the most commonly used vector control method for IM [16]. Let us define the stator and active flux as state variables for the observer. Thus,

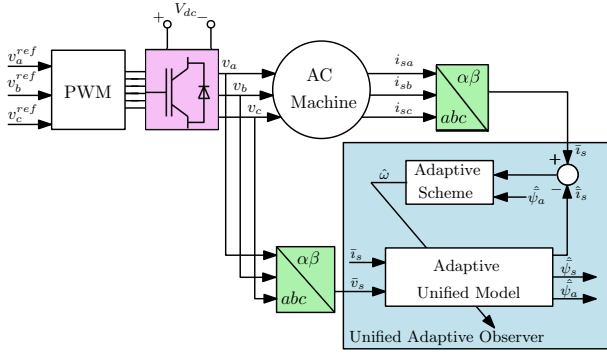

Fig. 2. Block diagram of the proposed unified adaptive flux observer

the proposed unified sliding mode observer in the stationary  $\alpha\beta$  reference frame is written as follows:

$$\begin{cases} \frac{d}{dt}\hat{\psi}_s = \bar{v}_s - R_s\hat{i}_s + \bar{g}_1(\bar{v}_s - \hat{i}_s) + \bar{k}_1\text{Sgn}(\bar{v}_s - \hat{i}_s) \\ \frac{d}{dt}\hat{\psi}_a = j\omega\hat{\psi}_a + \bar{g}_2(\bar{v}_s - \hat{i}_s) + \bar{k}_2\text{Sgn}(\bar{v}_s - \hat{i}_s) \end{cases} \quad (15)$$

where  $\bar{g}_i$  is the Luenberger complex gain, and  $k_i$  is the sliding mode complex gain. Substituting (11) in (15), we obtain the following:

$$\begin{cases} \frac{d}{dt}\hat{\psi}_s = \bar{v}_s - \frac{R_s}{L_{eq}}\hat{\psi}_s + \frac{R_s}{L_{eq}}\hat{\psi}_a + \bar{g}_1(\bar{v}_s - \hat{i}_s) \\ + \bar{k}_1\text{Sgn}(\bar{v}_s - \hat{i}_s) \\ \frac{d}{dt}\hat{\psi}_a = j\omega\hat{\psi}_a + \bar{g}_2(\bar{v}_s - \hat{i}_s) + \bar{k}_2\text{Sgn}(\bar{v}_s - \hat{i}_s). \end{cases} \quad (16)$$

Since the synchronous speed  $\omega$  is unknown, an estimate of its value is to be used. Consider the following adaptation law:

$$\dot{\hat{\omega}} = \gamma \text{Im}(\bar{e}_{\psi_a}\hat{\psi}_a^*) \quad (17)$$

such that  $\bar{e}_{\psi_a}$  is the active flux estimation error. Combining (16) and (17), we can rewrite the observer model as:

$$\begin{cases} \dot{\hat{x}} = A(\hat{\omega})\hat{x} + Bu + G\bar{e}_{i_s} + K\text{Sgn}(\bar{e}_{i_s}) \\ \hat{i}_s = C\hat{x} \\ \dot{\hat{\omega}} = \gamma \text{Im}(\bar{e}_{\psi_a}\hat{\psi}_a^*) \end{cases} \quad (18)$$

where  $\hat{x} = [\hat{\psi}_s \ \hat{\psi}_a]^T$  is the observer state vector, and  $\bar{e}_{i_s}$  is the current estimation error. Note that  $B$  and  $C$  are the same as before, while  $A(\hat{\omega})$ ,  $G$ , and  $K$  are defined as follows:

$$A(\hat{\omega}) = \begin{bmatrix} -\frac{R_s}{L_{eq}} & \frac{R_s}{L_{eq}} \\ 0 & j\hat{\omega} \end{bmatrix}, \quad G = \begin{bmatrix} \bar{g}_1 \\ \bar{g}_2 \end{bmatrix}, \quad K = \begin{bmatrix} \bar{k}_1 \\ \bar{k}_2 \end{bmatrix}. \quad (19)$$

### A. Observability Analysis

The model mentioned above is a linear time-varying system. We may examine the system using the linear time-invariant theory by assuming that the synchronous speed is constant throughout time samples [17]. The observability matrix, which is calculated as part of the observability analysis, shows that observability is always guaranteed as long as the synchronous speed  $\omega$  differs from zero. After ensuring the matrix pair  $(A, C)$  is observable, a full-order Luenberger observer with sliding mode correction can be designed.

### B. Stability Conditions

**Proposition 1.** Consider the system (12) under assumption 1. There exists a gain  $G$  such that for any positive real numbers  $\gamma$  and  $k$ , the estimated states of the proposed observer in (18) converge asymptotically to the real states of the machine, i.e.:

$$\lim_{t \rightarrow +\infty} e(t) = |x(t) - \hat{x}(t)| = 0.$$

*Proof.* The error dynamics of the observer are written as:

$$\dot{e} = (A(\omega) - GC)e - \Delta A\hat{x} - K\text{Sgn}(Ce) \quad (20)$$

where  $e = [\bar{e}_{\psi_s} \ \bar{e}_{\psi_a}]^T$  is the error vector. Knowing that:

$$\Delta A = A(\hat{\omega}) - A(\omega) = \begin{bmatrix} 0 & 0 \\ 0 & j\Delta\omega \end{bmatrix} \quad (21)$$

such that  $\Delta\omega = \hat{\omega} - \omega$  is the synchronous speed estimation error. Let us define the Lyapunov function:

$$V = e^\dagger e + \frac{\Delta\omega^2}{\gamma} \quad (22)$$

where  $V > 0$  for all  $e$ ,  $\Delta\omega \neq 0$ , and  $\gamma > 0$ . Assuming that the speed is constant within a sampling interval and deriving the Lyapunov function, we obtain:

$$\dot{V} = e^\dagger \dot{e} + \dot{e}^\dagger e + 2\frac{\dot{\Delta\omega}}{\gamma}\Delta\omega. \quad (23)$$

Substituting (20) in (23) and taking  $A(\omega) = A$  gives us:

$$\begin{aligned} \dot{V} = e^\dagger ((A - GC)^\dagger + (A - GC)) e - e^\dagger \Delta A\hat{x} - \hat{x}^\dagger \Delta A^\dagger e \\ + 2\frac{\dot{\Delta\omega}}{\gamma}\Delta\omega - e^\dagger K\text{Sgn}(Ce) - \text{Sgn}(Ce)^\dagger K^\dagger e. \end{aligned} \quad (24)$$

Replacing the error vector  $e$  with its components leads to:

$$\begin{aligned} \dot{V} = e^\dagger ((A - GC)^\dagger + (A - GC)) e - 2\text{Im}(\bar{e}_{\psi_a}\hat{\psi}_a^*)\Delta\omega \\ + 2\frac{\dot{\Delta\omega}}{\gamma}\Delta\omega - \frac{2}{L_{eq}}\text{Re}((\bar{k}_1\bar{e}_{\psi_s}^* + \bar{k}_2\bar{e}_{\psi_a}^*)\text{Sgn}(\bar{e}_{\psi_s} - \bar{e}_{\psi_a})). \end{aligned} \quad (25)$$

Letting  $\bar{k}_1 = -\bar{k}_2 = k + j0 > 0$ , we obtain the following:

$$\begin{aligned} \dot{V} = e^\dagger ((A - GC)^\dagger + (A - GC)) e + 2\Delta\omega\left(\frac{\dot{\Delta\omega}}{\gamma} - \text{Im}(\bar{e}_{\psi_a}\hat{\psi}_a^*)\right) \\ - \frac{2}{L_{eq}}k(|e_{\psi_{s\alpha}} - e_{\psi_{a\alpha}}| + |e_{\psi_{s\beta}} - e_{\psi_{a\beta}}|). \end{aligned} \quad (26)$$

From the second term of (26), the speed-adaptation law is obtained:

$$\dot{\hat{\omega}} = \gamma \text{Im}(\bar{e}_{\psi_a}\hat{\psi}_a^*) \quad (27)$$

Hence, by choosing  $G$  so that the first term of (26) is negative definite, the proposed observer is stable.  $\square$

Note that, in reality, the active flux is not measured, so an alternative expression for the speed adaptation law is used:

$$\dot{\hat{\omega}} = \gamma L_{eq} \text{Im}(\bar{e}_{i_s}\hat{\psi}_a^*) = \gamma L_{eq}(e_{i_{s\beta}}\hat{\psi}_{a\alpha} - e_{i_{s\alpha}}\hat{\psi}_{a\beta}). \quad (28)$$

Both expressions will lead to the same results. To increase the dynamic response, a proportional controller is added:

$$\hat{\omega} = \gamma_p \epsilon + \gamma_i \int \epsilon \quad (29)$$

where  $\epsilon = L_{eq} \text{Im}(\bar{e}_{i_s} \hat{\psi}_a^*)$  and  $\gamma_i$  and  $\gamma_p$  are positive gains. The complete diagram of the observer is seen in Fig. 2.

### C. Flux Angle Calculation

Both the Rotor FOC (RFOC) and the Stator FOC (SFOC) require the flux orientation angle to be implemented. The stator-field-oriented frame in SFOC is aligned with the stator flux vector  $\hat{\psi}_s$ , whereas the rotor-field-oriented frame in RFOC is aligned with the active flux vector  $\hat{\psi}_a$ . Using the estimated flux components, we can determine these angles:

$$\hat{\theta} = \tan^{-1} \left( \frac{\hat{\psi}_{a\beta}}{\hat{\psi}_{a\alpha}} \right); \quad \hat{\theta}_s = \tan^{-1} \left( \frac{\hat{\psi}_{s\beta}}{\hat{\psi}_{s\alpha}} \right) \quad (30)$$

## IV. SIMULATION RESULTS

The proposed unified observer was simulated in MATLAB/Simulink on 3.5 kW PMSM and 0.75 kW IM models. The motor parameters are presented in Table I. The observer was tested in an open-loop manner (i.e., the observer output is not used in the controller). Both PMSM and IM were controlled to follow a specified speed profile trajectory using sensed closed-loop vector control, such that any operating point could be reached. The  $i_{sd}$  current reference was chosen to be equal to the nominal fluxing current for IM and zero in the case of PMSM.

TABLE I  
MOTORS NAMEPLATE

	IM	PMSM
Rated Power	750 [Watt]	3500 [Watt]
Rated Voltage	400 [V]	480 [V]
Rated Speed	1440 [rpm]	3000 [rpm]
Rated Current (RMS)	1.7 [A]	12.0 [A]
Rated Torque	5 [N.m]	12 [N.m]
Rated Frequency	50 [Hz]	250 [Hz]
$n_p$	2	5
$R_s$	9.165 [ $\Omega$ ]	0.250 [ $\Omega$ ]
$R_r$	4.5 [ $\Omega$ ]	-
$L_{ls}$	24.5 [mH]	-
$L_{lr}$	24.5 [mH]	-
$L_m$	850 [mH]	-
$L_d$	-	3 [mH]
$L_q$	-	3 [mH]
$\psi_m$	-	0.13 [Wb]
J	0.05 [kg.m <sup>2</sup> ]	0.0034 [kg.m <sup>2</sup> ]

### A. Proposed observer performance

The observer gains were tuned so that the closed-loop poles of the observer were set to be five times faster than the open-loop poles of the motor. The numerical simulation results for the observer when implemented on the IM are shown in Fig. 3. It is clear that even when a torque load is applied at 0.5 s, the flux estimation magnitude of both the active and stator flux tracks the real flux of the motor. The synchronous frequency

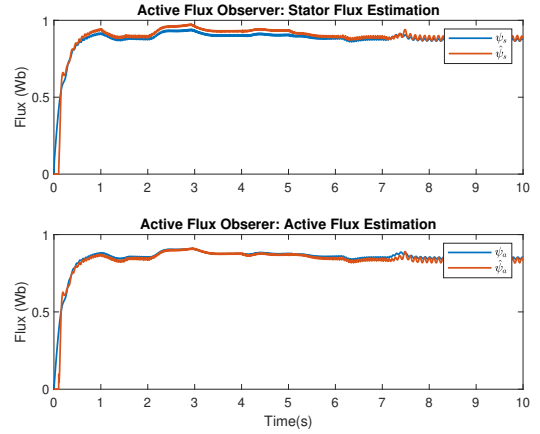

Fig. 3. IM flux estimation numerical simulation results

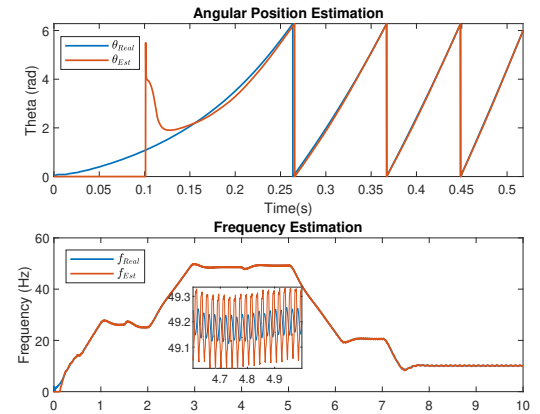

Fig. 4. IM frequency and angular position estimation numerical simulation results

and angular position estimation for the IM are shown in Fig. 4, where we can see the fast dynamic response of the observer's speed estimation. The proposed observer was tested next on a PMSM. Fig. 5 shows the observer estimation of the frequency and angular position estimation  $\theta$ , where we can see that the tracking error is almost zero.

## V. EXPERIMENTAL RESULTS

Experimental tests were done using a rapid control prototyping test bench (Imperix). The unified observer was discretized using the forward Euler method with a sampling frequency  $f_s = 20\text{kHz}$  and tested in an open-loop manner on a motor test bench that includes PMSM and IM, as seen in Fig. 6. The speed-torque profile in Fig. 7 was chosen such that the IM and PMSM are working as speed-controlled and torque-controlled machines, respectively. Fig. 8 shows the observer tracking performance for the frequency and angular position on the IM, where it is seen that the estimation error is less than 1 Hz and 0.1 rad for the frequency and angular position estimation, respectively, as seen in Fig. 9. In the case of PMSM, the unified observer tracks well the real frequency

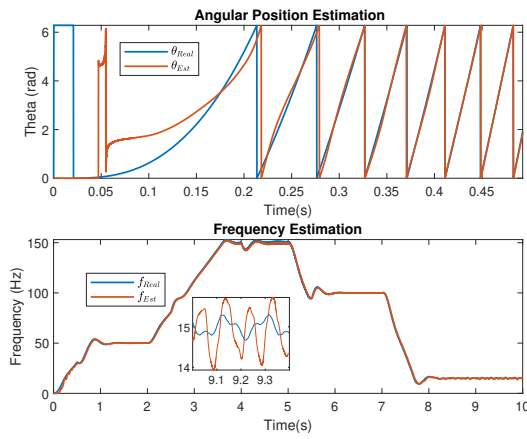

Fig. 5. PMSM simulation results for angular position and frequency estimation

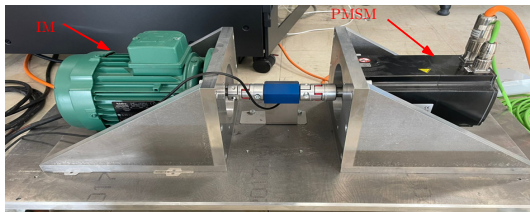

Fig. 6. Motor test bench

and angular position, as seen in Fig. 10. Finally, the results for stator and active flux estimation are shown in Fig. 11, where it is obvious that the observer tracking for the PM flux constant is very good.

## VI. CONCLUSION

This paper proposes a novel unified adaptive sliding mode flux observer for ac machines. The observer has the advantage that it only depends on two motor parameters: the stator resistance and the equivalent inductance. The general structure is unified enough to be applied to any ac machine. It is seen that

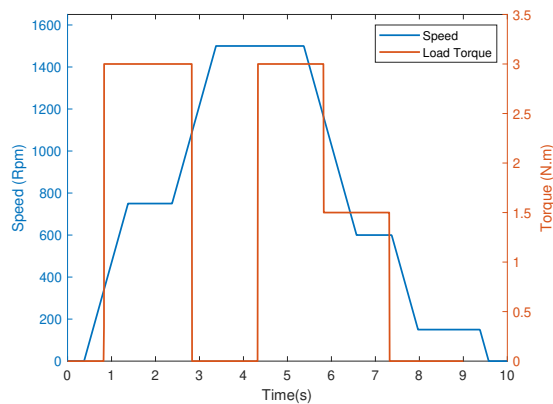

Fig. 7. The employed speed-torque profile for the experimental results

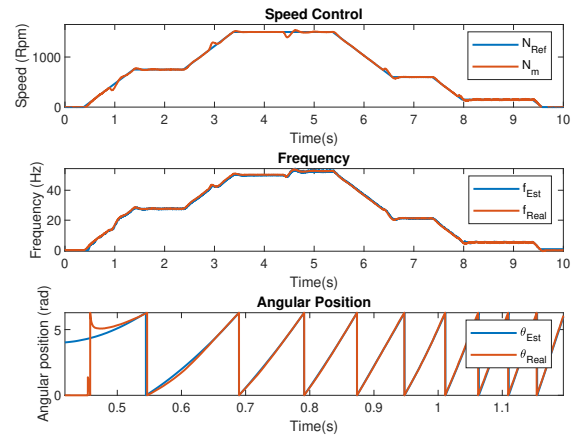

Fig. 8. IM experimental results for angular position and frequency estimation

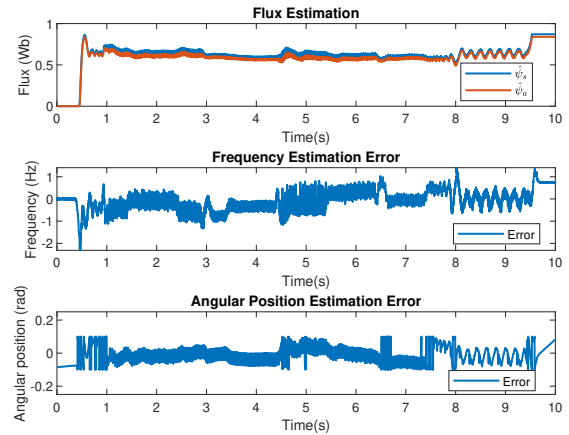

Fig. 9. IM experimental results for observer estimation error

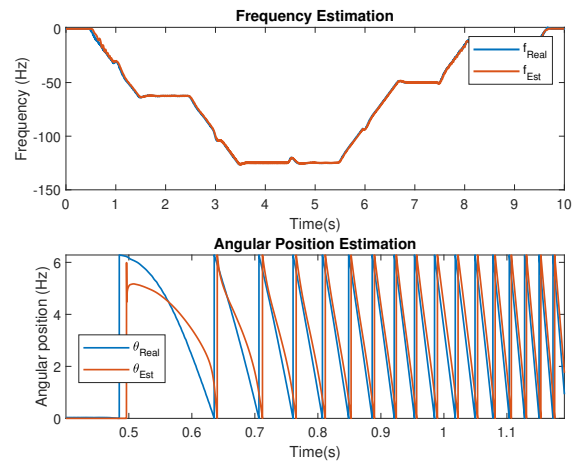

Fig. 10. PMSM experimental results for angular position and frequency estimation in torque mode



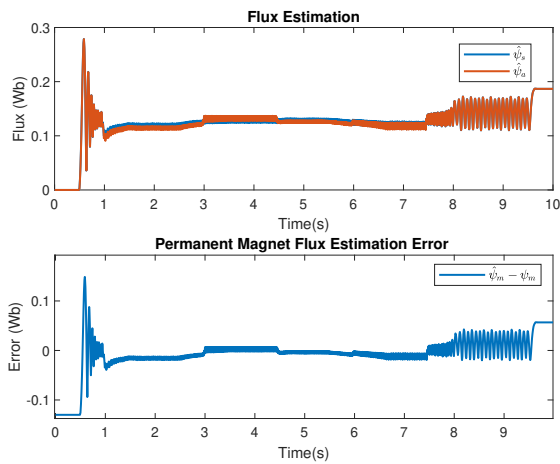

Fig. 11. PMSM experimental results for flux estimation

the unified observer delivers very good performance regarding stator and active flux magnitude and position estimation. The convergence of the observer is very fast in both PMSMs and IMs, even in the case of a speed ramp and load torque disturbance. Finally, experimental results show that the unified observer can work on both IM and PMSM without knowing its type, which can be used later for a unified sensorless control of ac machines.

Although the unified observer shows promising results in the field of a unified observer framework for ac machines, there are a few important issues that need to be addressed:

- Improve the observer performance at very low speeds.
- The assumption that the derivative of active flux amplitude is equal to zero is to be relaxed.
- Investigating the observer's parameter sensitivity.

#### REFERENCES

- [1] F. Blaschke, "The principle of field orientation as applied to the new transvector closed-loop system for rotating-field machines," *Siemens Review*, vol. 34, no. 3, pp. 217–220, 1972.
- [2] I. Takahashi and Y. Ohmori, "High-performance direct torque control of an induction motor," *IEEE Transactions on Industry Applications*, vol. 25, no. 2, pp. 257–264, 1989. DOI: 10.1109/28.25540.
- [3] F. Briz and M. Hinkkanen, "Design, implementation and performance of synchronous current regulators for ac drives," *Chinese Journal of Electrical Engineering*, vol. 4, no. 3, pp. 53–65, 2018.
- [4] R. Bojoi, P. Guglielmi, and G. Pellegrino, "Sensorless stator field-oriented control for low-cost induction motor drives with wide field weakening range," *2008 IEEE Industry Applications Society Annual Meeting*, pp. 1–7, 2008. DOI: 10.1109/08IAS.2008.18.
- [5] S.-H. Kim, "Preface," *Electric Motor Control*, pp. xi–xii, 2017. DOI: <https://doi.org/10.1016/B978-0-12-812138-2.00014-3>.

- [6] D. Xu, B. Wang, G. Zhang, G. Wang, and Y. Yu, "A review of sensorless control methods for ac motor drives," *CES Transactions on Electrical Machines and Systems*, vol. 2, no. 1, pp. 104–115, 2018. DOI: 10.23919/TEMS.2018.8326456.
- [7] Z. Chen, M. Tomita, S. Doki, and S. Okuma, "An extended electromotive force model for sensorless control of interior permanent-magnet synchronous motors," *IEEE Transactions on Industrial Electronics*, vol. 50, no. 2, pp. 288–295, 2003. DOI: 10.1109/TIE.2003.809391.
- [8] S. Koonlaboon and S. Sangwongwanich, "Sensorless control of interior permanent-magnet synchronous motors based on a fictitious permanent-magnet flux model," in *Fourtieth IAS Annual Meeting. Conference Record of the 2005 Industry Applications Conference*, vol. 1, 2005, pp. 311–318. DOI: 10.1109/IAS.2005.1518326.
- [9] I. Boldea, M. C. Paicu, and G.-D. Andreescu, "Active flux concept for motion-sensorless unified ac drives," *IEEE Transactions on Power Electronics*, vol. 23, no. 5, pp. 2612–2618, 2008.
- [10] M. Hinkkanen, "Analysis and design of full-order flux observers for sensorless induction motors," *IEEE Transactions on Industrial Electronics*, vol. 51, no. 5, pp. 1033–1040, 2004. DOI: 10.1109/TIE.2004.834964.
- [11] D. Chen, J. Wang, and L. Zhou, "Adaptive second-order active-flux observer for sensorless control of pmsms with mras-based vsi nonlinearity compensation," *IEEE Journal of Emerging and Selected Topics in Power Electronics*, vol. 11, no. 3, pp. 3076–3086, 2023.
- [12] A. T. Woldegiorgis, X. Ge, H. Wang, and Y. Zuo, "An active flux estimation in the estimated reference frame for sensorless control of ipmsm," *IEEE Transactions on Power Electronics*, vol. 37, no. 8, pp. 9047–9060, 2022.
- [13] L. Harnefors, M. Jansson, R. Ottersten, and K. Pietilainen, "Unified sensorless vector control of synchronous and induction motors," *IEEE Transactions on Industrial Electronics*, vol. 50, no. 1, pp. 153–160, 2003. DOI: 10.1109/TIE.2002.807653.
- [14] M. Koteich, G. Duc, A. Maloum, and G. Sandou, "A unified model for low-cost high-performance ac drives: The equivalent flux concept," *Third International Conference on Electrical, Electronics, Computer Engineering and their Applications (EECEA)*, pp. 71–76, 2016.
- [15] J. Chen, J. Mei, Y. Zuo, J. Zhu, X. Yuan, and C. H. T. Lee, "Overview of ac motor sensorless algorithms: A unified perspective," *tehrxiv*, Sep. 2021.
- [16] G. Yang and T.-H. Chin, "Adaptive-speed identification scheme for a vector-controlled speed sensorless inverter-induction motor drive," *IEEE Transactions on Industry Applications*, vol. 29, no. 4, pp. 820–825, 1993. DOI: 10.1109/28.232001.
- [17] M. Hinkkanen, "Flux estimators for speed-sensorless induction motor drives," English, Doctoral thesis, 2004, 46, [55], ISBN: 951-22-7189-3.