



HAL
open science

Deployment and Experimental Evaluation of Micro-Grid Systems

Abdellatif Elmouatamid, M. Bakhouya, R. Ouladsine, N. El Kamoun, K. Zine-Dine, M. Khaidar, R. Abid

► **To cite this version:**

Abdellatif Elmouatamid, M. Bakhouya, R. Ouladsine, N. El Kamoun, K. Zine-Dine, et al.. Deployment and Experimental Evaluation of Micro-Grid Systems. 2018 6th International Renewable and Sustainable Energy Conference (IRSEC), Dec 2018, Rabat, France. pp.1-6, 10.1109/IRSEC.2018.8703025 . hal-04601191

HAL Id: hal-04601191

<https://hal.science/hal-04601191>

Submitted on 4 Jun 2024

HAL is a multi-disciplinary open access archive for the deposit and dissemination of scientific research documents, whether they are published or not. The documents may come from teaching and research institutions in France or abroad, or from public or private research centers.

L'archive ouverte pluridisciplinaire **HAL**, est destinée au dépôt et à la diffusion de documents scientifiques de niveau recherche, publiés ou non, émanant des établissements d'enseignement et de recherche français ou étrangers, des laboratoires publics ou privés.

Copyright

Deployment and Experimental Evaluation of Micro-Grid Systems

A. Elmouatamid^{1,2,*}, M. Bakhouya¹, R. Ouladsine¹, N. El kamoun², K. Zine-Dine², M. Khaidar², R. Abid³

¹International University of Rabat

Faculty of Computing and Logistics, TICLab, ECINE, LERMA Lab, Sala El Jadida, Morocco
{abdellatif.elmouatamid, mohamed.bakhouya, radouane.ouladsine}@uir.ac.ma

²Chouaib Doukkali University, Faculty of Sciences, El Jadida, Morocco
STIC Lab, CUR''EnR&SIE'', LAROSERI Lab
{elkamoun.n, khaidar.m, zinedine}@ucd.ac.ma

³AlAkhawayn University- Hassan II Ave, Ifrane 53000
r.abid@aui.ma

Abstract—Renewable energy sources (RES) have been promoted to overcome environmental constraints as well as the scarcity of fossil energy sources. In fact, many initiatives have been deployed by integrating these sources (e.g. Photovoltaic panel, Wind, Fuel cell...) in order to increase energy efficiency (i.e., electricity production) in buildings while limiting CO₂ emissions. In parallel to this development, micro-grids have emerged as decentralized systems to allow connecting different decentralized sources in which buildings become active electricity producers in addition to the main traditional electric grid. However, a smarter demand response management system is required to efficiently balancing the energy production, storage, and the electricity consumption. In this paper, a demand/response control approach is introduced by integrating into a holistic platform different RES together with storage devices for supplying electricity to buildings equipment (e.g. ventilation system, lighting...). A prototype was developed and deployed in our EEELab for experiments and real-testing. Preliminary experimental results are reported and show the usefulness of the proposed holistic approach.

Keywords; photovoltaic systems; wind turbine; energy management system; hybrid system; buffer battery; main storage; micro-grids; context-driven control; IoT.

I. INTRODUCTION

The production of electrical energy constitutes one of the main sources of greenhouse gases emission. In order to reduce CO₂ emissions, renewable energy was promoted in the past decades as main sources for producing green energy. However, an electrical generating system, which depends entirely or partially on the renewable energy sources, is not reliable because of the availability and the intermittent nature of these sources. In fact, the solar output varies throughout the day and through the seasons, and is mainly affected on cloudy days [9]. Wind generated power is a variable resource, and the amount of produced electricity depends on turbine characteristics, wind speeds, and air density [11]. Therefore, electrical energy storages could be incorporated to balance the intermittency of power supply caused by the weather conditions variation [8]. So, it is necessary to characterize as precisely as possible the production of these sources as well as the consumption profile for their efficient integration and control.

Recent studies put more emphasize on the development of energy management systems (EMS) for connecting, integrating and controlling these micro-grid (MG) systems.

However, the random nature of electricity production by these hybrid energy resources (e.g., PV, Wind) makes their efficient control a difficult task without taking into consideration the actual circumstances (e.g., weather conditions, occupancy). In this work, two renewable energy sources (RES) is integrated together with storage devices and a control strategy is implemented to manage the power flow based on the power production/consumption (Figure 1).

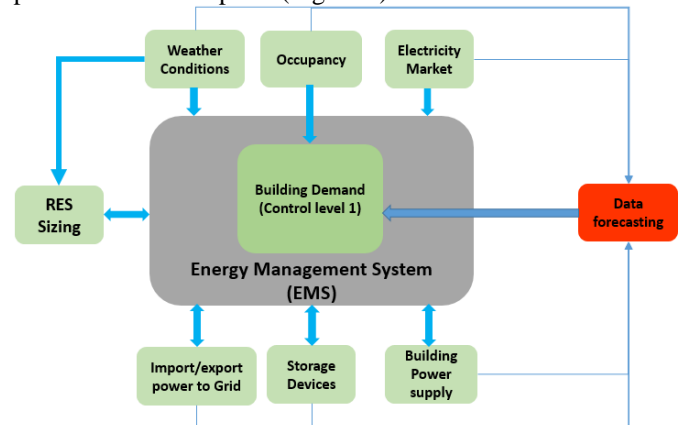

Figure 1. Energy management system

This paper focuses mainly on the development of a preliminary control strategy for predicting, estimating and controlling the interaction between power production (wind, PV), storage devices and building demands. The aim is to ensure a continuous power supply to the building according to the actual context. The work presented in this paper is a part of an ongoing project, which aims to develop a context-aware platform for performing instantaneous equilibrium of the Demand/Response balance [8, 10, 20].

The remainder of this paper is organized as follow. Section 2 presents the existing work related to the Demand/response control approaches of MG systems and existing architectures. In Section 3, the general architecture of our EEELab MG is presented together with the Hw/Sw control switch and the proposed control strategy. In Section 4, the testbed and the deployed MG system are presented together with experimental results. Conclusions and perspectives are given in Section 5.

II. RELATED WORK

Face to the increase of electricity demand, the integration of different RESs to produce the electricity have gained an outstanding interest. The idea is that the consumer becomes an energy producer by installing different RESs (e.g., PV, Wind) together with the traditional grid to minimize energy billing. According to the integration of this hybrid system, different studies have been focused to improve the control strategies for an optimal energy management in the micro-grid. The study of a control strategy must begin with a study of the connection architecture of the sources and the AC/DC bus installation. For example, authors in [12] present different configurations of hybrid photovoltaic and diesel systems, they distinguish the advantages and disadvantages of each configuration.

In [13], the advantages of DC distribution in terms of transmission losses are illustrated with the help of three case studies, authors compare the DC grid to AC grid regarding efficiency and power transport capability, and they present three applications where a DC grid could be employed. Also, an AC and DC load flow is performed for each of the three collection and distribution grid and the losses are compared. Other work is [14], in this study the hybrid system classifications are performed according to the chosen criterion, the first one is the connection to the grid or stand-alone system and the second one is the hybrid system with or without storage devices. According to that, [15] propose a distributed micro-grid topology structure and illustrates the principles of network, design dispatch control and energy management strategy with battery capacity prediction. Another interesting work is [16], authors present some insight and considerations that need to be taken into account when sizing storage capacity for a hybrid system of RESs, also modeling of hybrid system components is illustrated in this paper. After studying the connection architecture of different sources and sizing the storage devices, the production and the consumption powers, the next step that is the main objective of this work is the study of the control strategy to be implemented to make the system optimal and more reliable. According to this step, several research works have been conducted in the past few years aiming at integrating and controlling these hybrid systems (e.g., PV-Wind, PV-Wind-battery, PV-Wind-Diesel and PV-Wind-Grid). For instance, Authors in [1] have used neural networks as a strategy for controlling a PV-Diesel systems. In fact, a dynamic system is used to optimize the operation of the diesel generator while minimizing the fuel costs by taking into account the energy demand and the solar irradiation.

In [2], various strategies have been developed and compared for the operation of a hybrid system. Mainly, authors proposed a predictive control strategy for charging/discharging batteries according to the predicted electricity production and consumption. With this strategy, the energy loss from the renewable energies tends to decrease, however, authors consider ideal batteries, without taking into account losses or the influence of the cycles in the lifespan of batteries. In [6, 7], authors introduced a supervisor control for a hybrid system that comprises wind and photovoltaic generation subsystems, a battery bank, and an AC load. Authors in [4, 5] proposed an

economic-based control approach of photovoltaic systems with energy storage devices. This approach could determine the best suitable device (i.e., batteries, hydrogen) for either storing extra energy or supplying demanded electricity.

It's worth noting that the architecture of the MG systems is another important issue that needs to be considered when deploying MG systems. In fact, depending on the nature of the energy AC or DC, and the nature of the loads to be supplied, different topologies can be defined, generally they are two types as shown in Figure 2. In the first type, named series architectures, the available renewable energy is delivered to a DC or AC bus before powering the loads. In AC bus case, it is necessary to use a charge controller to the batteries, then the energy stored in the batteries is converted to AC using an inverter to supply AC loads. In DC bus case, the whole energy source is first delivered to the batteries before powering the loads. The disadvantages of this architecture are the following. The battery must have a large capacity and it is constantly subjected to charge/discharge cycles. Also, the system has relatively low efficiency, because the power supplied is converted twice before reaching the consumer and a possible failure of the inverter causes a total power failure.

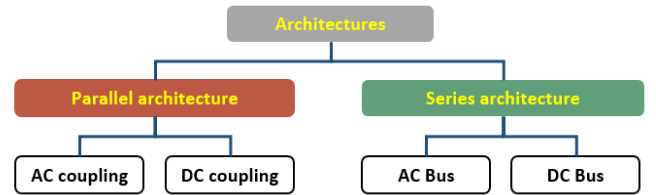

Figure 2. Hybrid system architectures

Unlike the series architecture, in the parallel architecture, there are two busses, AC and DC. In fact, the system is more flexible concerning the control, in case of failure of a source, the system can be managed by supplying loads from another source. Furthermore, the system components should not be sized for the total load, as the load can be simultaneously powered by multiple sources. In some cases, the loads can be powered directly by the RESs avoiding a large charge/discharge cycles of the batteries. However, the voltage and frequency of the AC network must be kept within very strict limits in order to ensure the stability of the system's operation, which depends on the quality of the inverter.

Next section focuses on the presentation of our MG system and its main components, which are connected following the parallel architecture using both AC and DC busses.

III. EEBLAB MICRO-GRID ARCHITECTURE

This section introduce the deployed micro-grid together with the control approach implemented in order to test different control strategies. A PV and wind turbine (WT) is deployed in the EEBLab and connected together with storage devices to supply different AC/DC equipment. Furthermore, in order to ensure the power during the night or when we have bad weather conditions, the system is connected to the traditional grid. Figure 3 depicts the general architecture of the deployed MG, which is composed of WT, a photovoltaic

system, batteries, and a weather station together with building's equipment (e.g., lighting, ventilation). The Hw/Sw control switch implements the control approach of the deployed MG. As illustrated in Figure 3, it requires real-time data from the weather station, the equipment used for gathering the power produced by the WT as well as the photovoltaic system, and the consumption profile. All these data are gathered and processed in real-time using our IoT and Big data platform [10, 3]. The control approach uses these data to extract the actual context in order to select the best suitable action for either storing extra energy, or supplying directly the building equipment from the PV/Wind/Batteries, or from the electric grid.

The PV used in this work is modeled and validated in [9, 17]. Also, the wind turbine characteristics used for this paper are described in [19]. Concerning the batteries, the architecture consists of two batteries, the buffer battery with a less capacity, this battery is used to ensure the power to the loads. When the loads are connect directly to the PV, to WT or to PV/WT the buffer battery can smooth the power when there are sudden variations in the weather conditions. The second

battery is the main storage. The main storage has a high capacity, is used to store the power from the sources and to generate the power when the production is less than the loads demands. The battery characteristics used for this work are described in [18].

The weather station deployed in our EEELab contains a set of sensors, a wind speed sensor (Anemometer), a wind direction sensor (weather van), a temperature and humidity sensor, and a pressure sensor. The sensors are connected to an Arduino board, which collect the data and transmit it to a computer to be stored, analyzed and visualized in real-time. All these data are gathered and processed in real-time using our IoT and Big data platform [10] for further usage in different applications related to buildings management systems.

The rest of this section is dedicated mainly to the description of different components related to the integration and the control of the MG system. In fact, a control card is developed to connect and manage all renewable energy sources with the loads and storages.

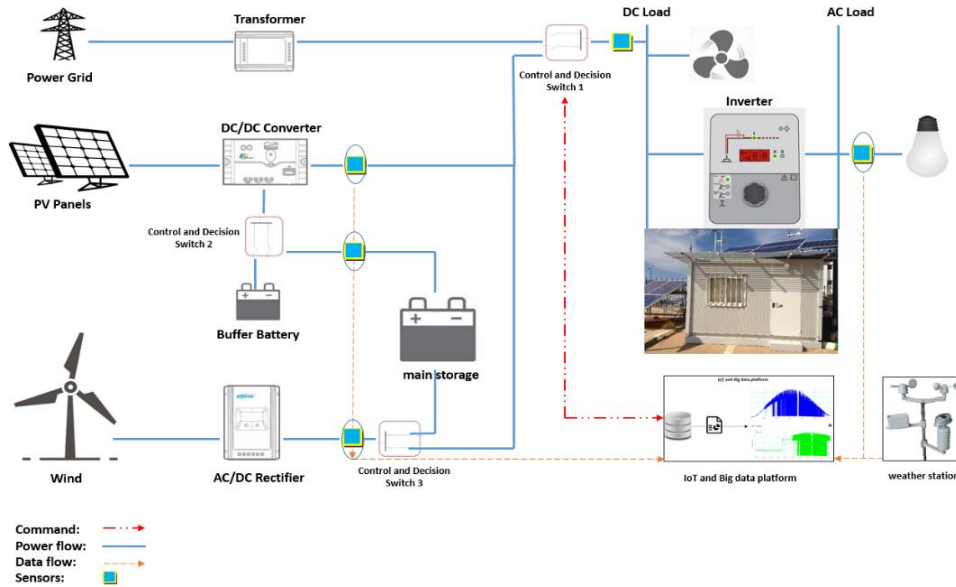

Figure 3. The EEELab micro-grid architecture

The developed card can be seen as an embedded energy management system (EMS) for optimal energy usage according to the actual context. In fact, the PV (resp. WT) system produces the electric power only during sunny (resp. windy) days, but the high power consumption appears to be around the midday and during the moment of sunset. During the day, the aim is to use all the energy produced from renewable energy sources and to avoid a high charging and discharging cycles of the batteries. Also with the EMS, a priority is defined between the PV system and WT to supply the loads. For example, it is preferable to supply the loads by the PV system and use the WT to charge the battery because the radiation is more stable than the wind speed. We can calculate the power produced from each sources during a period to define the sources priority and to minimize the loss

of power supply probability. The total energy produced by the RESs (equation 3) is the summation of E_{PV} and E_{WT} , respectively produced by the PV and WT during one day and can be expressed by (1) and (2), and the maximum power demanded by the storage can be calculated by (4).

$$E_{PV} = \int_0^{24h} P_{PV}(t) dt \quad (1)$$

$$E_{WT} = \int_0^{24h} P_{WT}(t) dt \quad (2)$$

$$E_{RES} = E_{PV} + E_{WT} \quad (3)$$

$$E_{Bat} = E_{RES} - \int_0^{24h} P_{Consumption}(t) dt \quad (4)$$

The total energy calculated for each sources can be taken into account, like input parameter, to design the control strategies.

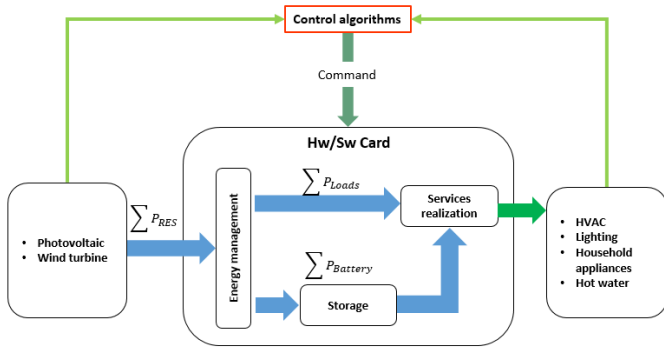

Figure 4. Energy services

Different objective functions can be taken into account when optimizing and designing a control strategy, like the smoothing of the production, the continuity of the power generated to the consumer, and charge/discharge cycle of the batteries. For that, a control strategy is designed to satisfy the loads demands (lighting, ventilation system) throughout the day and night by using the PV, WT, batteries and traditional grid. A main communication infrastructure is employed for the total energy measurement and management purposes. This infrastructure provides the autonomous operation with the required measurements, decisions and controls by collecting data

through the sensors and producing the commands for the Hw/Sw card connected to the control switches used in the hybrid system.

The proposed strategy could control the deployed MG system according to the following cases: i) the power generated by the PV system has priority in satisfying power demand by loads over that delivered by the WT or by the batteries, because in the site of testing there is more radiation during the day than wind, ii) if the power generated by the PV system is higher than the loads demand, the PV system is connected directly to the loads using a buffer battery which allows to balance the power delivered to the load (Figure 3: switch 2), in this case the power generated by the WT will be used to charge the main battery, iii) if the electric power generated by the PV system is less than the demand, power will be supplied from the PV and WT (Figure 3: switch 2, 3), iv) if the load demand exceeds the power generated by PV/WT combination, the difference is supplied by the main storage (Figure 3: switch 2), v) if the power generated by PV/WT is less than the demand and the SOC of the battery is less than 60 % (to avoid a deep discharging), the power will be supplied by the traditional grid (Figure 3: switch 1), during this time PV/WT power is used to charge the main storage. The flowchart of the main control strategy is illustrated in Figure 5.

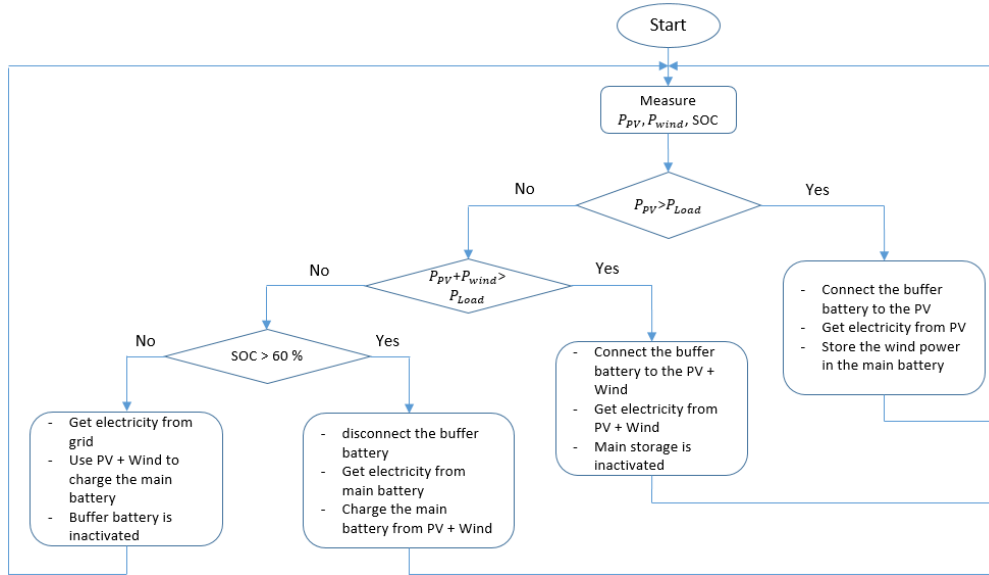

Figure 5. Flowchart of the power flow management

IV. TESTBED AND EXPERIMENTAL RESULTS

In order to validate the behavior of the control strategy and the functionality of the hybrid system, experimental results have been extracted. The main objective is minimizing the electricity consumption from the traditional grid and maximizing the production of renewable energy. A prototype is used to ensure the power supply to a ventilation system and lighting in the laboratory. From those data synthetic profiles that describe the power generation of the WT and PV panels, as well as the power demand of the laboratory (lighting, ventilation system), were obtained. In this part, a real system is presented to extract the data to confirm the usefulness of the

EMS control. The measurements of the power exchanged in the main elements of the Hybrid system are presented. Figure 6 shows the real hybrid system installed in our EEELab.

A. Buffer battery

The buffer battery is used when the renewable energy generators is directly connected to the load. The capacity of this battery is less than the main battery storage. As shown in the figure 7, the charge/discharge current of this buffer battery is low. From 7:00 AM to around 10:00 AM, the PV production is less than the power demand, for that the buffer battery is disconnected and the battery current is zero. From 10:00 AM

to around 18:00 PM we have some peak due to the charge or discharge of the buffer responding to the production variation.

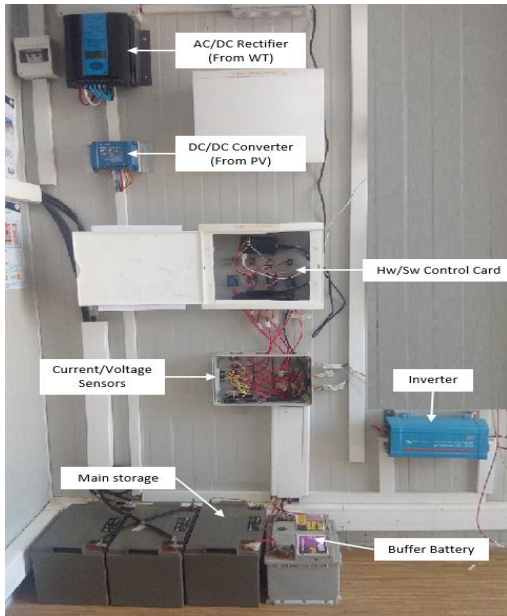

Figure 6. Hybrid system implemented in the EEELab

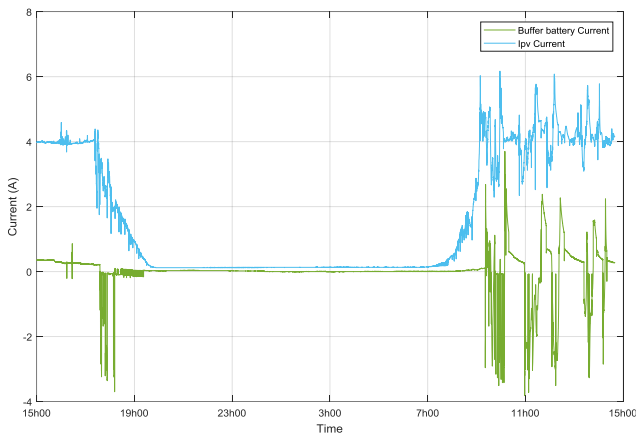

Figure 7. Buffer battery current variation

B. Main storage battery

The batteries used in the main storage have a large capacity. When the power production is higher than the power consumption, these batteries are connected to the RES just for charging. For that, in the figure 8 we can see that from 07:00 AM to 18:00 PM the current is positive, the batteries are charged. In the same time, the power supplied to the consumer is ensured by the PV and the WT. As shown in the figure 8, from 18:00 PM to 20:00 PM the power produced by the RESs is less than the power consumed in the building and the main batteries storage is connected to complete the need of power. During the night, the RESs are around zero and the main storage is discharged, for that we can see in the figure 9 that the system is switched from the RESs to the traditional grid to ensure the power to the loads. The inverter is used to generate the total power from different RESs and storage devices to the loads.

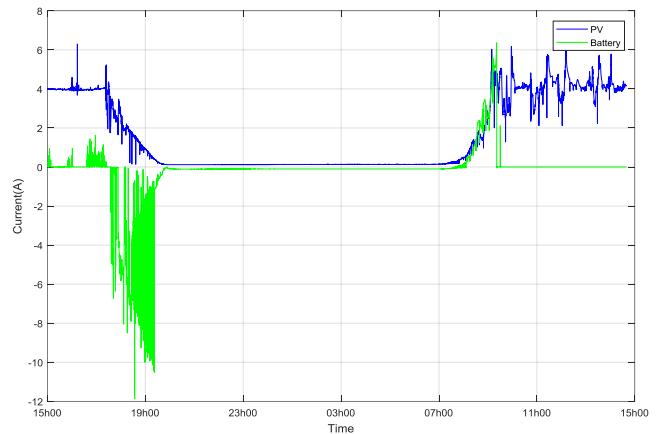

Figure 8. Main storage charge/discharge current variation with PV production

C. Grid power

As mentioned above, the traditional grid is used to ensure the power to the building when the power production is zero and the storage is discharged. During the 24 hours of the experimentation, the batteries are discharged around 20:00 PM and started charging around 07:00 AM. Figure 10 shows that during this period the power generated by the traditional grid is equal to the power consumption (Lighting, ventilation system).

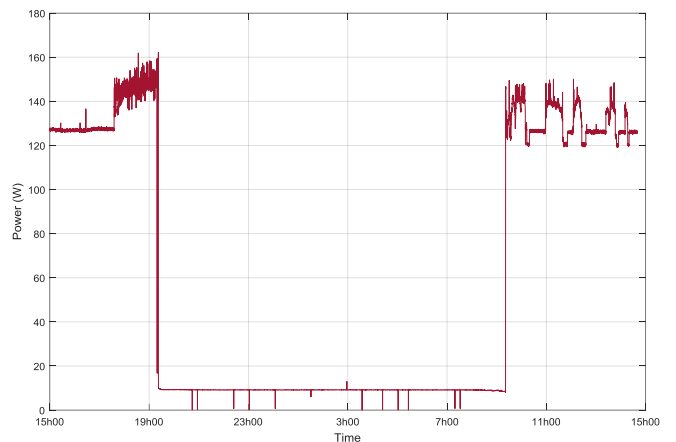

Figure 9. The power generated from the inverter to the loads

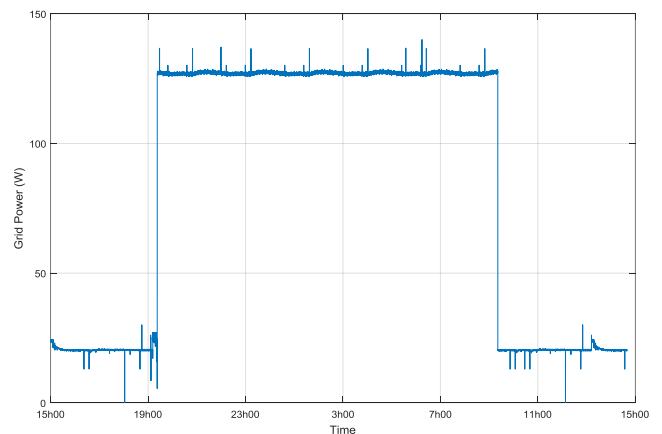

Figure 10. Power consumed from traditional grid

D. PV and wind turbine power

The system is installed in a site where the wind speed has only a limited number of days when it exceeds the rated speed of the wind turbine to levels which allows to give an important production, due to different existing obstacle. For that we can see in figure 11 that the power generated by the WT is less than the power generated by the PV, and is zero also during the night. During the period of production of the WT, the PV can satisfies the demand and the WT is used to charge the batteries.

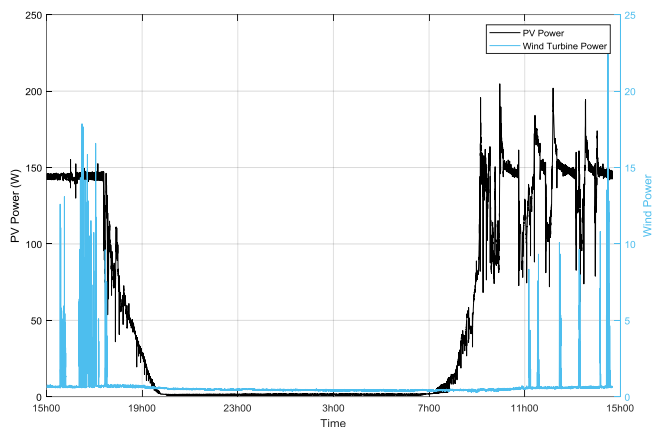

Figure 11. PV-WT power generated during 24 hours

V. CONCLUSIONS AND PERSPECTIVES

To ensure a high level of reliability and flexibility of the power supply demanded by the consumer in an optimal way, a preliminary control strategy for a hybrid system is presented in this work. In fact, a real hybrid system is deployed in our EEELab for conducting experiments. The testbed is composed of a PV system and WT connected together to storage devices in order to ensure the power demanded by ventilation and lighting systems. Preliminary results are presented to show the usefulness of the control strategy for balancing the Demand/Response according to the actual weather condition (production) and the occupancy (consumption). The future works focuses on the development of a predictive control approach. In fact, based on this platform installed and tested, our ongoing work aims to use data processing and predictive analytics to develop a predictive demand/response strategies for MG systems.

ACKNOWLEDGMENT

This work is supported by MIGRID project (grant 5-398, 2017-2019), which is funded by USAID under the PEER program.

REFERENCES

- [1] Ohsawa Y, Emurd S, Arai K. Optimal operation of photovoltaic/diesel power Generation system by neural network. In: Proceedings of the second international forum on applications of neural networks to power systems; 1993. p. 99–103.
- [2] Barley CD, Winn CB, Flowers L, Green HJ. Optimal control of remote hybrid power systems. Part I. Simplified model. In: Proceedings of WindPower'95; 1995.
- [3] Elmoutamid, A., Elkamoun, N., Lakrami, F., & Bakhouya, M. Wireless Sensor Networks for Smart Micro-Grids.
- [4] Kolhe M, Agbossou K, Kelouwani S, Anouar A, Fournier M, Hamelin J, Bose TK. Long-term performance of stand-alone renewable energy system for hydrogen production. In: Proceedings of 14th world hydrogen energy conference; 2002.
- [5] Kolhe M, Agbossou K, Hamelin J, Bose TK. Analytical model for predicting the performance of photovoltaic array coupled with a wind turbine in a stand-alone renewable energy system based on hydrogen. *Renew Energy* 2003; 28 (5):727–42.
- [6] F. Valenciaga and P. F. Puleston, "Supervisor control for a stand-alone hybrid generation system using wind and photovoltaic energy," *IEEE Trans. Energy Convers.*, vol. 20, no. 2, pp. 398–405, Jun. 2005.
- [7] C.Wang and M. H. Nehrir, "Power management of a stand-alone wind/photovoltaic/fuel-cell energy system," *IEEE Trans. Energy Convers.*, vol. 23, no. 3, pp. 957–967, Sep. 2008.
- [8] Elmoutamid, A., NaitMalek, Y., Ouladsine, R., Bakhouya, M., Elkamoun, N., Zine-Dine, K., & Abid, R. (2018, April). Towards a Demand/Response Control Approach for Micro-grid Systems. In 2018 5th International Conference on Control, Decision and Information Technologies (CoDIT) (pp. 984-988). IEEE.
- [9] El Mouatamid, A., Ouladsine, R., Bakhouya, M., Felix, V., Elkamoun, N., Zine-Dine, K., ... & Abid, R. (2017, December). Modeling and Performance Evaluation of Photovoltaic Systems. In 2017 International Renewable and Sustainable Energy Conference (IRSEC) (pp. 1-7). IEEE.
- [10] M. Bakhouya, Y. NaitMalek, A. Elmoutamid, F. Lachhab, A. Berouine, S. Boulmrharj, R. Ouladsine, V. Felix, K. Zine-dine, M. Khaidar, N. Elkamoune, Towards a Data-Driven Platform using IoT and Big Data Technologies for Energy Efficient Buildings, in *CloudTech*, 2017, pp. 1-5, Rabat, Morocco.
- [11] R. Rabeh, M.Ferfra, R. Ouladsine, M. Bakhouya, A. Ezbakhe, Modeling and Performance Evaluation of a Wind Energy Conversion System, under finalization for submission to the 3rd Inter. Conference on Renewable Energies, Power Systems and Green Inclusive Economy, Casablanca, 2018.
- [12] Stoyanov, Ludmil & Notton, G & Lazarov, Vladimir. (2007). Optimisation des systèmes multi-sources de production d'électricité à énergies renouvelables. 10. 1-18.
- [13] Kenzelmann, Stephan. "Modular DC/DC converter for DC distribution and collection networks." (2012).
- [14] Stoyanov, Ludmil. Etude de différentes structures de systèmes hybrides à sources d'énergie renouvelables. Diss. Université Pascal Paoli, 2011.
- [15] Zhang, Jiyuan, et al. "Energy management of PV-diesel-battery hybrid power system for island stand-alone micro-grid." *Energy Procedia* 105 (2017): 2201-2206.
- [16] Gan, Leong Kit, Jonathan KH Shek, and Markus A. Mueller. "Hybrid wind-photovoltaic-diesel-battery system sizing tool development using empirical approach, life-cycle cost and performance analysis: A case study in Scotland." *Energy Conversion and Management* 106 (2015): 479-494.
- [17] A. Elmoutamid, Y. NaitMalek, M. Bakhouya, R. Ouladsine, N. Elkamoun, K. Zine-Dine, M. Khaidar, A Demand/Response Control Strategy for Micro-Grid Systems, submitted to *Journal of Systems and Control Engineering*, 2018.
- [18] Boulmrharj, S., et al. "Towards a battery characterization methodology for performance evaluation of micro-grid systems." 2018 International Conference on Smart Energy Systems and Technologies (SEST). IEEE, 2018.
- [19] R. Rabeh, R. Ouladsine, M. Bakhouya, M.Ferfra, A. Ezbakhe, Modeling and Performance Evaluation of a Wind Energy Conversion System, accepted as poster in the 3rd Inter. Conference on Renewable Energies, Power Systems and Green Inclusive Economy, Casablanca, 2018.
- [20] Boulmrharj, S., NaitMalek, Y., Elmoutamid, A., Bakhouya, M., Ouladsine, R., Zine-Dine, K., ... & Abid, R. (2018). Approach for dimensioning stand-alone photovoltaic systems. *Energy Procedia*, 153, 56-61.