



HAL
open science

Towards a Demand/Response Control Approach for Micro-grid Systems

Abdellatif Elmouatamid, Y. Naitmalek, R. Ouladsine, M. Bakhouya, N.
Elkamoun, K. Zine-Dine, M. Khaidar, R. Abid

► **To cite this version:**

Abdellatif Elmouatamid, Y. Naitmalek, R. Ouladsine, M. Bakhouya, N. Elkamoun, et al.. Towards a Demand/Response Control Approach for Micro-grid Systems. 2018 5th International Conference on Control, Decision and Information Technologies (CoDIT), Apr 2018, Thessaloniki, France. pp.984-988, 10.1109/CoDIT.2018.8394951 . hal-04599621

HAL Id: hal-04599621

<https://hal.science/hal-04599621>

Submitted on 3 Jun 2024

HAL is a multi-disciplinary open access archive for the deposit and dissemination of scientific research documents, whether they are published or not. The documents may come from teaching and research institutions in France or abroad, or from public or private research centers.

L'archive ouverte pluridisciplinaire **HAL**, est destinée au dépôt et à la diffusion de documents scientifiques de niveau recherche, publiés ou non, émanant des établissements d'enseignement et de recherche français ou étrangers, des laboratoires publics ou privés.

Copyright

Towards a Demand/Response Control Approach for Micro-grid Systems

A. Elmouatamid^{1, 2}, Y. NaitMalek^{1, 3}, R. Ouladsine¹, M. Bakhouya¹, N. Elkamoun², K. Zine-Dine², M. Khaidar², R. Abid⁴

¹International University of Rabat

Faculty of Computing and Logistics, TICLab, ECINE, LERMA Lab, Sala El Jadida, Morocco
{abdellatif.elmouatamid, radouane.ouladsine, mohamed.bakhouya}@uir.ac.ma

²Chouaib Doukkali University, Faculty of Sciences, El Jadida, Morocco
STIC Lab, CUR''EnR&SIE'', Data Processing Lab.
{elkamoun.n, khaidar.m, zinedine}@ucd.ac.ma

³ENSIAS Mohammed V- Souissi University, Rabat, Morocco

⁴AlAkhawayn University- Hassan II Ave, Ifrane 53000
r.abid@aui.ma

Abstract— The intermittent nature and overwhelming variability of the produced electricity from renewable energy sources (RES) constitutes the main challenge for their seamless integration into buildings. Recent studies stated that storage devises, despite their actual high cost, could be used to tackle this issue by balancing the intermittent nature of RES production and the unpredictable building's occupancy. In fact, these storage devises could handle this issue, which is very complex without taking into consideration actual occupancy and environmental context. This paper introduces a demand/response control approach by mainly focusing on micro-grid systems, which are composed of PVs, batteries, and buildings equipment (e.g., ventilation system, lighting, HVAC). A prototype was developed and deployed in a real-setting scenario at our EEBLAB. Experimentations have been performed and results show the usefulness of the proposed control approach for micro-grid systems.

Keywords- Photovoltaic systems, Micro-grids, IoT, Context-driven control.

I. INTRODUCTION

The depletion of traditional resources, the increase of the electricity demand, together with the need of reducing CO₂ emissions, as illustrated in Figure 1, have led to a large scale deployment of renewable energy generators into electrical grids. Unfortunately, the random and discontinuous nature of these energies makes them difficult to control and it is necessary to characterize as precisely as possible the production of these sources. The influence of their nature can be diminished by coupling two or more renewable energy sources (e.g., PV, Wind turbine) that could be connected with storage devices (e.g., Batteries, Fuel cell) or the electric grid network. This coupling of several energy sources requires a control strategy that could reshape the energy Demand/Response. In fact, the control strategy could keep track of the amount of expected consumption (Demand) and the amount of produced energy (Response) in order to maximize the usage of renewable energy according to the actual context [1, 2].

The work presented in this paper is a part of an ongoing project aiming at developing a context-aware platform that could perform an instantaneous equilibrium of the Demand/Response balance. The aim is to integrate a control strategy for predicting, estimating and controlling the interaction between power production, storage and building demands. In this paper, we focus on the development of the first

prototype that includes a PV, battery and the electric grid. These components are connected together to power a ventilation system as illustrated in Figure 2. The goal is to ensure a continuous power supply of this ventilation system according to the actual context. For instance, the power is low when we have bad weather conditions (temperature and irradiation) and zero at night. For this reason, we use a battery for balancing the PV production with the ventilation consumption, but a problem also occurs in this case when the battery is used for long periods without being charged due to a large period of use during the night or due to a lack of irradiation during cloudy days. Because of this intermittent and irregular nature of the PV production, we include also the grid in order to eventually ensure the power supply during these periods. This simple hybrid system, however, needs to be automatically controlled. A Demand/Response control approach is therefore developed for balancing the intermittent PV generation and delay between the power production and the real building consumption.

Figure 1. Figure 1. Three-Dimensional Objective

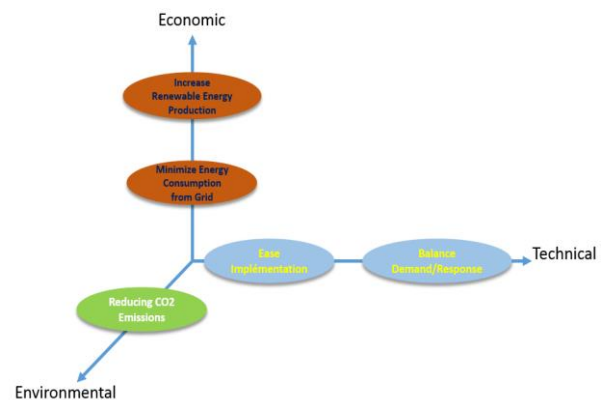

The remainder of this paper is organized as follows. Section 2 describes briefly existing work from literature. Section 3 describes the prototype's architecture and presents the control approach. In Section 4, the testbed system is presented together with experimental results. Finally, conclusions and perspectives are given in Section 5.

II. RELATED WORK

Recent research work in micro-grid focused mainly on the integration of various renewable energy sources (e.g, PV,

Wind, Full cell...) together with storage devices (e.g., hydrogen, lead acid batteries) and the improvement of their optimal control. For instance, authors in [1] present a deterministic operational planning algorithm for a power generation park within a micro-grid. They have also studied the different link topologies in order to select the best one for building a hybrid system. Authors in [2] combined an autonomous PV and wind turbine using a DC bus and the generated output power from the system is fed to all connected loads, while the surplus power is injected to the electric grid. In [3], a local controller for the PV based active generator is developed. A local energy management system is also introduced for controlling the power flows inside the PV active generator. The management system implements several algorithms in order to supply the power demanded by the grid operator, in the same time it extracts the maximum PV power while respecting the storage capacity and power limits.

In [4], authors introduce an approach for active power sharing in a hybrid fuel cell/battery power source to improve the system efficiency and battery life with acceptable load. Authors in [5] proposed a hybrid PV-wind system that provides a sophisticated integration of the wind turbine and solar PV to extract optimum energy from the two sources, PV and Wind. Strategies for controlling and managing optimal energy for a micro-grid have been studied and developed in [6]. Mainly, models have been developed by simulations, using the stochastic approach control. The proposed approach is validated by simulations taking into consideration the uncertainty of PV production and load. Authors in [7] proposed a cost function with an optimization algorithm, which guarantees a power balance and regulation of frequency level, an equal power sharing and a better coordinated operation between PV units and battery storage. This algorithm, based on [8, 9], was implemented and developed in MATLAB-SIMULINK software environment. In [8], authors developed a distributed cooperative control strategy for coordinating the energy storage systems to maintain the supply-demand balance and minimize the total power loss associated with charging-discharging inefficiency. The effectiveness of the proposed approach was validated by simulation results. An overview of current developments of micro-grid control, the requirements and desirable traits of the control systems are presented in [9].

III. THE SYSTEM ARCHITECTURE

This section describes the proposed integration of the solar PV and battery system as depicted in Figure 3. It includes a 70 Watts PV panel [10], a battery 25 Ah, and a ventilation system composed of two ventilators operating with a state feedback control [11, 12, 22, 23] with 24 Watts of maximum power. The connection with the grid is assured by a transformer which gives 12V in the output. This micro-grid is equipped with a platform for measuring the consumption and production (Demand/Response). A set of current and voltage sensors have been installed for measurement of the power in all branches of the installation. The purpose of this installation is to show the switching moments of our control approach between the battery and the electrical grid.

A. The photovoltaic system

A model of PV panel is simulated with real irradiation and temperature data during 12 hours from 7:00am until 7:00pm. Figures 4 (a, b) shows respectively the temperature and the irradiation profile, while Figure 4 (c) shows the PV production

during 12 hours using same data. These data is presented here to show the validation of the PV model we have used for experiments [10].

Figure 2. The architecture of the micro-grid control prototype

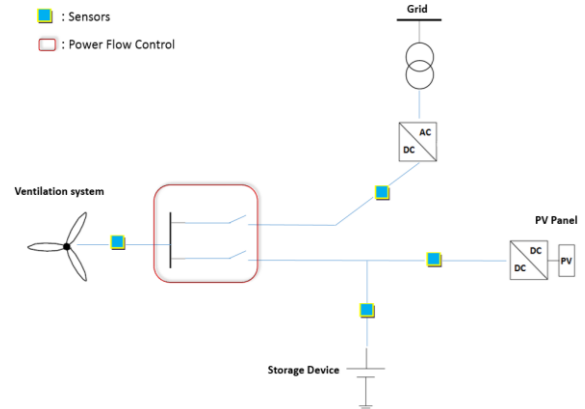

Figure 3. The deployed prototype at our EEELab

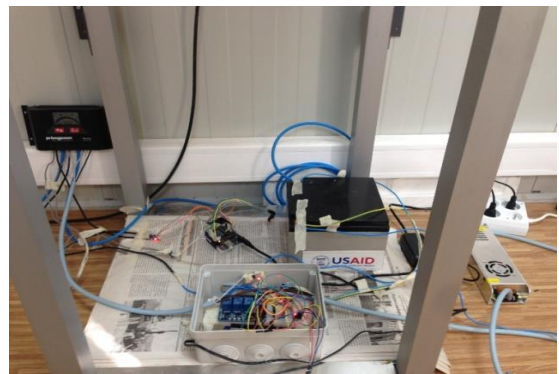
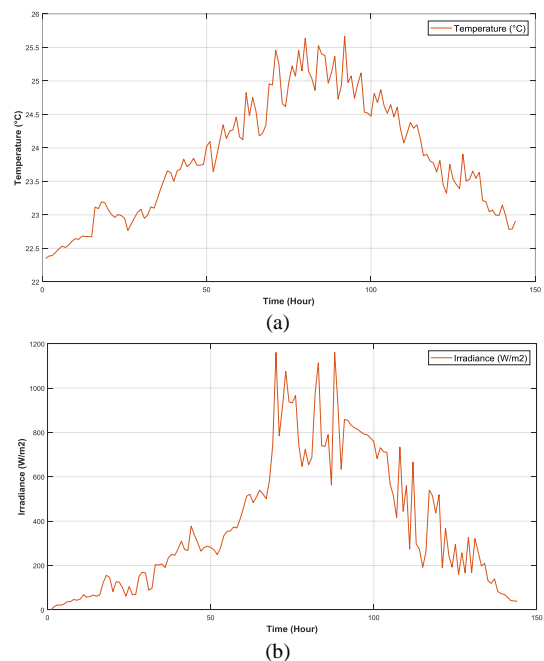
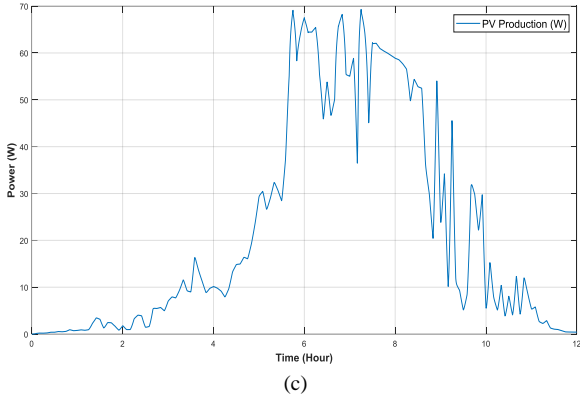

Figure 4. Real data during 12 hours, (a) Temperature, (b) Irradiance and (c) PV production





B. The battery characteristics

A lead acid battery is used because of its robustness and also because flooded lead acid cells are one of the least expensive sources of battery power available [13]. Its characteristics are described in Table I.

TABLE I. Characteristics of the battery

Output voltage	12 V
Rated Capacity	25 Ah
Float charge voltage	13.5-13.8 @ 25°C
Cyclic charge voltage	14.4-15.0 @ 25°C
Recommended maximum depth of discharge	50%
Cycle life	1000

It's worth noting that for real experiments only the voltage and the current can be measured. All the others need to be estimated and the data provided in the catalogs of the batteries are not sufficient to derive all the parameters required to estimate the state of charge (SoC) [14, 15, 16], which is used by the proposed control strategy. Mainly, the battery is described by its voltage $V = V_{OC} \pm IR$, where R is the internal resistance, which is variable and depends on other parameters, such as the temperature, the capacity and the charge/discharge status. V_{OC} is the open circuit voltage and I is the current, which is negative during the charging mode and positive during the discharge mode. Another parameter that could be used for the estimating of the SoC is the Nominal capacity ($Q_{Nominal}$), which is expressed in (Ah). It is the amount of electricity that can provides under certain conditions. It depends on the discharge behavior, the minimum allowable voltage value at the discharge mode and the temperature of the electrolyte [17]. For this reason, it is often useful to define the $Q_{Nominal}$ as the value given by the manufacturer, which indicates the capacity of the battery at the beginning of its life and for a given discharge behavior or regime.

The control strategy needs the SoC as an input together with other parameters to select the most suitable action for either switch to the battery or to the electric grid. It is the ratio between the capacity at a time t and the nominal capacity of the battery ($Q_{Nominal}$). It mainly indicates the amount of electricity available in the battery as described above. It varies between 0 and 100%, the value 0 means that the battery is completely discharged, whereas it is full when it is 100%. The estimation of lead acid batteries SoC is still difficult and it is the subject of many studies [18, 19]. In this paper, we used the battery voltage parameter to estimate the SoC according to the work presented in [16, 20].

C. The control strategy

The control strategy proposed in this paper is very simple [21]. We used the estimated SoC to control the connection between the load and the battery on the one hand and between the load and the electric grid on the other hand. Four modes are considered as shown in Table II.

TABLE II. Operating modes of the battery

Mode	Battery connection		SoC
	Charging	Discharging	
0	OFF	OFF	Battery at rest
1	ON	OFF	$SoC < SoC_{min}$
2	OFF	ON	$SoC > SoC_{max}$
3	ON	ON	$SoC_{min} < SoC < SoC_{max}$

For instance, the control algorithm starts first by computing the SoC and the power of the PV. If the estimated SoC is about 100%, the control stops charging and the ventilators are powered by the battery. Otherwise, a threshold value is used to select between the battery and the grid. If the SoC value is above this threshold, the control selects the battery; otherwise, the control checks the PV power to refine the decision. If it is below a fixed threshold value, the ventilators will be powered by the grid; otherwise it will be powered by the battery. It's worth noting that the prototype we have deployed includes a ventilation system composed of two ventilators operating with 24 Watts of maximum power. This means that the choice of the threshold values of the switching between the battery and the grid needs to consider the load power.

IV. EXPERIMENTAL RESULTS

As mentioned above a small micro-grid was built to test the preliminary control strategy. It contains energy sources (PV, grid) storage devise (battery) and a load (two ventilators). The PV is used to charge the battery and the battery in turn provides power to the ventilation system. However, in bad weather conditions or during the night the battery discharges, in order to ensure the proper operation of the ventilation, the power must switch automatically to the grid following the proposed control strategy. In the rest of this section, we present some preliminary results to show the usefulness of the deployed micro-grid prototype.

A. First Scenario

In this scenario, we have tested the functional behavior of the proposed control approach during a cloudy day. Figure 5 shows the variation of the SoC. The values have been measured during 6 hours (from 11:00 am to 17:00 pm) and show that the battery continues discharging until 13:30 am. By that time the system switches to power the load using the electric grid, which justifies the constant values of the SoC between 13:30 and 14:30. It is worth noting that we have selected 60% as the switching threshold to avoid a depth discharging of the battery, and therefore maintaining a good state of health [24].

During the experimentation, we have bad weather condition; this is why the battery was not charged until 14:30, but its starts charging slightly (see Figure 6) after this time because PV production became significant. During the charging process, the current obtained from the PV is negative (around 14:00 pm to 14:30 pm), in this time the battery is disconnected from the

load and can be just charging but the power obtained from the PV is very low for that the SoC has gone from 50 % to 60% and stay at this value during the rest of the time as also illustrated in Figure 7. This behavior is also shown in Figure 6, which confirms the obtained SoC and current values.

Figure 5. Battery voltage and SoC variation

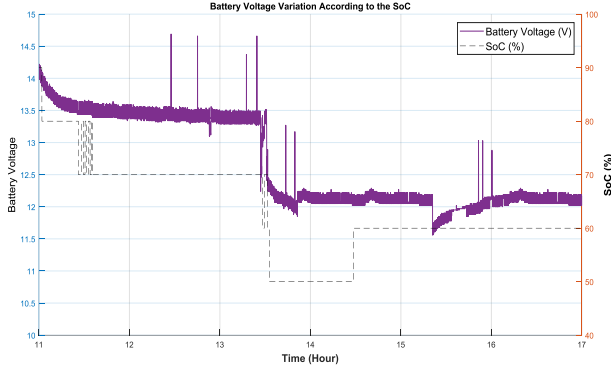

Figure 6. Charge-discharge behavior of the battery

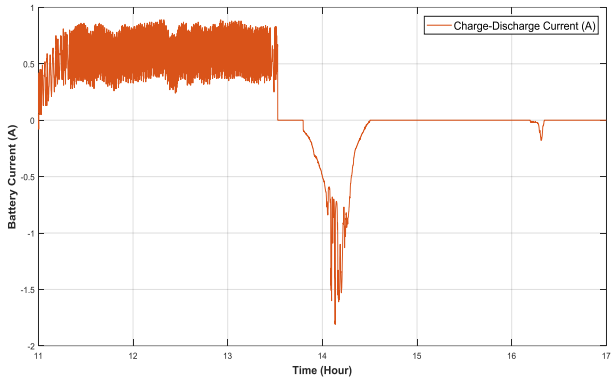
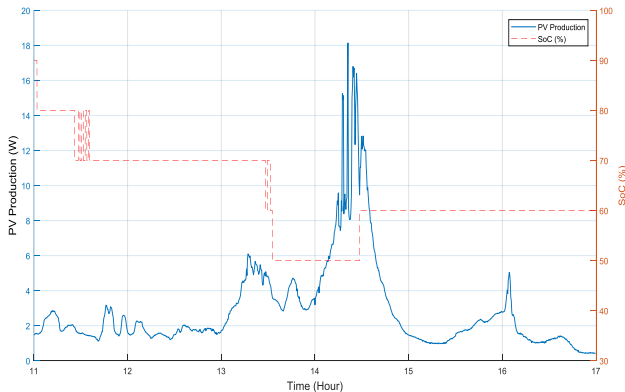

Figure 8 depicts the power consumption, which aims to show the switching times between the battery and the electric grid. This figure shows the consumption of the two ventilators for the entire duration of the experiment. The first curve in gray shows that the power supplied from the battery is between 11:00 am and 13:30 pm. During this time the SoC of the battery is higher than the threshold value (60% in this experiment). However, the battery discharges while supplying the ventilators since the production is too small. At 13:30 the SoC becomes less than 60%, and then the system switches to the grid.

Figure 7. Production and SoC variation



B. Second Scenario

The second scenario tested in this part was performed for 24 hours. The results obtained are presented in Figure 8 and show the behavior of the control during a sunny day. Along the day the ventilators operate on the battery, while charging by the PV power. At a certain time (around 16:00) the production became low, and therefore the ventilators are powered by the battery. Around 18h00, the SoC decreased to reach the threshold value, and the system switched from the battery to the electric grid along the night. At 7:00 pm, the SoC exceeded threshold value and the system switched back to be powered by the battery.

We have also measured the consumption using three current sensors with a constant voltage at 12 V. The first sensor is installed between the regulator and the ventilators, the second is installed between the ventilators and the transformer (220V to 12 V), which provides power supplied from the grid, and the third one is installed after the other two sensors for data validation.

Figure 8. Consumption from battery-grid and SoC status

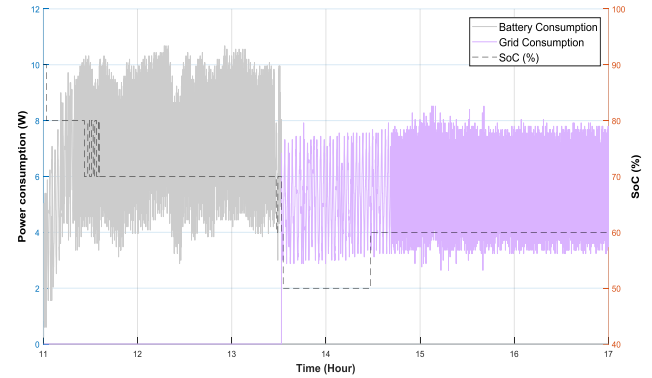
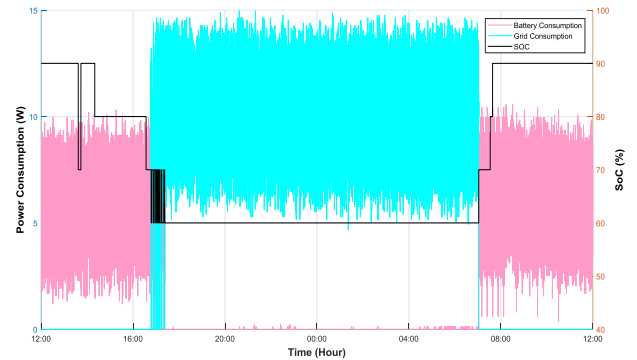

Figure 9. Consumption from battery-grid and SoC status



I. CONCLUSIONS AND FUTURE WORK

In this paper, we have introduced a preliminary control approach for a micro-grid system, which aims to supply the power demanded by the consumer in an optimal way. A prototype was developed and deployed in our EEELab for real-testing of control approaches. Preliminary results are reported to show the usefulness of balancing the power demand and response according to the actual context. Our ongoing work focuses on the integration of the wind model within the deployed micro-grid to study their seamless integration and control. The future work aims to develop an optimal holistic control system, which includes multi-renewable energy sources, storage devices, and the electric grid to satisfy the

building demands. Experimental results will be compared with those obtained from simulations.

ACKNOWLEDGMENT

This work is supported by MIGRID project (grant 5-398, 2017-2019), which is funded by USAID under the PEER program.

REFERENCES

- [1] H. Kanchev, "Management of energy flows in a hybrid system of renewable energy sources: Optimization of operational planning and adjustment of an urban electrical micro-grid", Thesis prepared in the Laboratory L2EP (EA 2697), the Technical University of Sofia, Lille, n°238, 2014.
- [2] D. Betha, M. Satish, S. Kumar, "Design and control of grid connected PV / Wind Hybrid system using 3 level VSC", IEEE 7th International Advance Computing Conference, 2017.
- [3] D. Lu, "Design and control of an active PV generator with integrated storage Application to the aggregation of producer-consumers as part of an urban micro-smart grid", Thesis prepared in Laboratory L2EP, EA 2697 Doctoral School SPI 072, n°147, 2010.
- [4] A. Hajizadeh, M. Aliakbar Golkar, "Intelligent power management strategy of hybrid distributed generation system", *Electrical Power and Energy Systems* 29 (2007) 783–795, Department of Electrical Engineering, K.N. Toosi University of Technology, 2007.
- [5] G.B. Hangaragi, "Recent Integration of A Pv-Wind Energy System with Enhanced Efficiency," *Indian J.Sci.Res.* 11 (1): 072-078, 2015.
- [6] N. An Luu, "Control and management strategies for a microgrid", Grenoble Institute of Technology, 2014.
- [7] V. Arangarajan, A. Ahmad Abu, SWARNA, K. S. V., Khoo, S. Y., & A. Stojcevski, "Intelligent control strategy in the islanded network of a solar PV microgrid. *Electric Power Systems Research*", vol. 155, p. 93-103, 2018.
- [8] Y. Xu, W. Zhang, G. Hug, S. Kar, Z. Li, "Cooperative control of distributed energystorage systems in a microgrid", *IEEE Trans. Smart Grid* 6 (2015) 238–248.
- [9] D.E. Olivares, A. Mehrizi-Sani, A.H. Etemadi, C.A. Cañizares, R. Irvani, M.Kazerani, et al., "Trends in microgrid control", *IEEE Trans. Smart Grid* 5 (2014)1905–1919.
- [10] A. Elmouatamid et al., Modeling and Performance Evaluation of Photovoltaic Systems, in IRSEC'2017, pp. 1-7 Tanger, Morocco.
- [11] F. Lachhab, R. Ouladsine, M. Bakhouya, M. Essaïdi, "A State-feedback Approach for Controlling Ventilation Systems in Energy Efficient Buildings", IRSEC 2015, Marrakech Morocco.
- [12] F. Lachhab, M. Bakhouya, R. Ouladsine, M. Essaïdi, "Monitoring and Controlling Buildings Indoor Air Quality Using WSN-based technologies", in the 4th International Conference on Control, Decision and Information Technologies, April 5-7, 2017, Barcelona, Spain.
- [13] G. Delille and B. Francois, "A review of some technical and economic features of energy storage technologies for distribution systems integration," *Ecol. Eng. Environ. Protect.*, no. 1, pp. 40–49, 2009.
- [14] L. David, Reddy, Thomas, "Handbook of Batteries", 3a Edic, McGraw Hill, 2001.
- [15] S. Abu-Sharkh, D. Doerffel, "Rapid test and non-linear model characterisation of solid state lithium-ion batteries", *Journal of Power Sources*, vol. 130, pp.226–274, 2004.
- [16] Y. Riffonneau, S. Bacha, F. Barruel, S. Ploix, "Optimal Power Flow Management for Grid Connected PV Systems With Batteries", *Sustainable Energy, IEEE Transactions on*, vol.2, no.3, pp.309,320, July 2011.
- [17] G. Dillenseger, "Characterization of new support modes for stationary emergency batteries", PhD Thesis, Montpellier II University, 2004.
- [18] M. Charkhgard, M. Farrokhi, "State-of-charge estimation for lithium-ion batteries using neural networks and EKF", *IEEE transactions on industrial electronics*, 57(12), 4178-4187, 2010.
- [19] S. Piller, M. Perrin, A. Jossen, "Methods for state-of-charge determination and their applications", *Journal of Power Sources*, Volume 96, Issue 1, Pages 113-120, ISSN 0378-7753, 2001.
- [20] S. Piller, M. Perrin, A. Jossen, "Methods for state-of-charge determination and their applications", In *Journal of Power Sources*, Volume 96, Issue 1, 2001, Pages 113-120.
- [21] M. Abarkan, "Modeling and Analysis of the behavior of a building equipped with a Multi Energy Sources System". Diss. Aix Marseille University and Sidi Mohamed Ben Abdellah University, 2014.
- [22] M. Bakhouya, Y. NaitMalek, A. Elmouatamid, F. Lachhab, A. Berouine, S. Boulmrharj, R. Ouladsine, V. Felix, K. Zinedine, M. Khaidar, N. Elkamoune, Towards a Data-Driven Platform using IoT and Big Data Technologies for Energy Efficient Buildings, invited paper at CloudTech,2017, Rabat, Morocco.
- [23] F. Lachhab, M. Bakhouya, R. Ouledsine, M. Essaïdi, *Energy-Efficient Buildings as Complex Socio-technical Systems: Approaches and Challenges*, Volume 18 of the series Nonlinear Systems and Complexity, Springer, pp 247-265, Dec. 2016.
- [24] J. Araujo, R. Matos, V. Conceição, G. Alves, P. Maciel, "Impact of capacity and discharging rate on battery life time: A stochastic model to support mobile device autonomy planning, *Pervasive and Mobile Computing*", Volume 39, Pages 180-194, 2017.