



HAL
open science

Design on CPW Quasi Dipole Meandered Printed Antenna for Cognitive Radio Applications

B Bhuvaneswari, V Aruna, R Monisha, E Pooja

► **To cite this version:**

B Bhuvaneswari, V Aruna, R Monisha, E Pooja. Design on CPW Quasi Dipole Meandered Printed Antenna for Cognitive Radio Applications. JOURNAL OF HIGH-FREQUENCY COMMUNICATION TECHNOLOGIES, 2024, 2 (02), pp.140-152. 10.58399/AJPG4759 . hal-04594068

HAL Id: hal-04594068

<https://hal.science/hal-04594068>

Submitted on 30 May 2024

HAL is a multi-disciplinary open access archive for the deposit and dissemination of scientific research documents, whether they are published or not. The documents may come from teaching and research institutions in France or abroad, or from public or private research centers.

L'archive ouverte pluridisciplinaire **HAL**, est destinée au dépôt et à la diffusion de documents scientifiques de niveau recherche, publiés ou non, émanant des établissements d'enseignement et de recherche français ou étrangers, des laboratoires publics ou privés.



Distributed under a Creative Commons Attribution 4.0 International License



Design on CPW Quasi Dipole Meandered Printed Antenna for Cognitive Radio Applications

B.Bhuvaneswari^{1*}, V.Aruna², R.Monisha³, E.Pooja⁴

^{1,2,3,4} Department of Electronics and Communication Engineering, Panimalar Engineering College, Chennai, Tamil Nadu, India *E-mail address:*
drbhuvanaramani@gmail.com/aruns.latha@gmail.com/
monishamadhu96@gmail.com/poojamohana14@gmail.com

Abstract

In this proposed paper, CPW-fed meandered printed antenna is designed and investigated for cognitive radio application. The suggested antenna is developed using two different substrates for varying the electrical properties. The first design is developed using an FR4 substrate and the second design is developed using jean material. Investigations are done on the design for wide bandwidth response for effective cognitive radio communication. The antennas are made to resonate at 2.45 GHz. The main focus in the proposed design is to achieve compactness and wider bandwidth. The proposed antenna is excited using coplanar waveguide (CPW) structure to reduce the antenna size and spurious radiations near the feed line. Two quarter-wavelength resonators with two separate current routes are part of the proposed antenna's structure. It may therefore function in the WiMAX and WLAN (wireless local area network) frequency ranges. By adjusting the length of the appropriate resonators, the operational bands' center frequencies can be separately controlled. The proposed antennas are designed and simulated for its resonance condition. A parametric study is done to identify the arm length of the proposed antenna for its appropriate resonance. Based on the suitable arm length, the antenna is designed and optimized for effective size reduction. The fabricated antenna module is integrated in the software defined radio (SDR) device for the real-time measurements. The footprint of the antenna is 48.5 mm × 25 mm. Both the simulated and measured results are in good concurrence.

Keywords: Meander antenna, Coplanar Waveguide, Wi-Fi, Software Defined Radio, Quarter wave length

1. Introduction

A single antenna serves as both the transmitter and the receiver in traditional wireless systems. Environmental factors and noise in these systems deteriorate transmission quality and lead to serious issues. An approach that is frequently used to solve this issue is to create MIMO systems using several antennas in the transmitter or receiver sections. In a MIMO system, a signal is initially delivered in multiple copies from multiple antennas. After traveling over different pathways, the transmitted signals arrive at and are gathered by several WLAN receiving antennas. The main signal with the appropriate quality will be formed by constructively combining the signals that

*Corresponding author

Received: 16th, November 2023, Revised: 13th May, 2024, Accepted: 19th May 2024 and available online 30th May 2024



have been gathered at the receiver portion. Therefore, the system's signal to noise ratio and dependability will both be increased by employing the MIMO technology for signal transmission. A wireless mesh network in which the power needed at each node is decreased and the overall capacity is increased with each additional radio. To minimize the near-far problems and interference, each node only transmits loudly enough for the message to hop to the nearest node in that direction. Antennas with multiple operational band of frequency are more desired for its high demand in wireless handheld devices. These devices are used in various communication systems for its various frequency standardizations. It leads to the need of reconfigurable antennas that are discussed in the literature. In continuation, MIMO antenna, which is a frequency reconfigurable antenna, offers greater flexibility with respect to its operating frequency, and thus reduces the need for multiple antennas in a single device. The switching of the frequencies between 2.4 GHz (WLAN) and 3.5 GHz (WiMAX) is performed using a PIN (Positive-Intrinsic-Negative) diode [Khan et al. \(2015\)](#). A reconfigurable MIMO system with switchable ultrawide band operations is demonstrated for cognitive radio applications. Similarly in [Rashed and Tai \(1991\)](#), the authors proposed a reconfigurable MIMO antenna using PIN diodes for WLAN and WiMAX frequency bands. In [Gupta et al. \(2010\)](#), a reconfigurable UWB monopole antenna array is discussed where RF switches are used to change the states between 2.4 GHz and 5.5 GHz with three various switching actions. Two identical CPW-fed reconfigurable planar antenna elements are used in the proposed MIMO array antenna [Garg et al. \(2001\)](#). PIN diodes are used to enable switchable operations in these components [Sankaralingam and Gupta \(2010\)](#). The rest of the manuscript is organized as follows. Section 2 presents the design of meander antenna on partial ground and with CPW structure. The simulated characteristics of the proposed antennas are discussed in Section 3. Section 4 deals with the design of modified meander antenna to achieve triple band response. Section 5 describes the testing of the proposed antenna in SDR communication. Section 6 ends with conclusion.

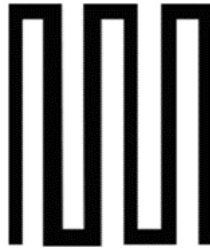

Figure 1. Structure of simple meander antenna

Table 1. Optimized dimensions of multiband meander antenna

Parameters	L	L_1	W	L_2	W_1	W_2	W_3
Dimension (mm)	53.1	28.4	40	19.8	20.08	9.8	7.9
Parameter	W_4	S	G	L_f	W_f	L_g	W_g
Dimension (mm)	15.8	2	1.09	16.3	6.26	12.8	8.3

2. Antenna Design and Configuration

As discussed in Section 1, the structure of a conventional meander antenna using the horizontal and vertical lines is shown in Fig. 1. In this work, the proposed meander antenna is designed on a FR4 substrate whose thickness is 1.6 mm, 4.4 as permittivity, and 0.018 as loss tangent. Along with the conventional structure of the meander lines on the partial ground, the feed line is connected to an SMA connector. The proposed antenna structure consists of two radiating stub arms instead of a conventional patches. Those radiating arms enhance the surface current that resonates at different frequencies [Purohit and Raval \(2014\)](#).

$$\text{Length of radiating stubs} = 0.25\lambda(\epsilon_{eff}) + 12i \quad (1)$$

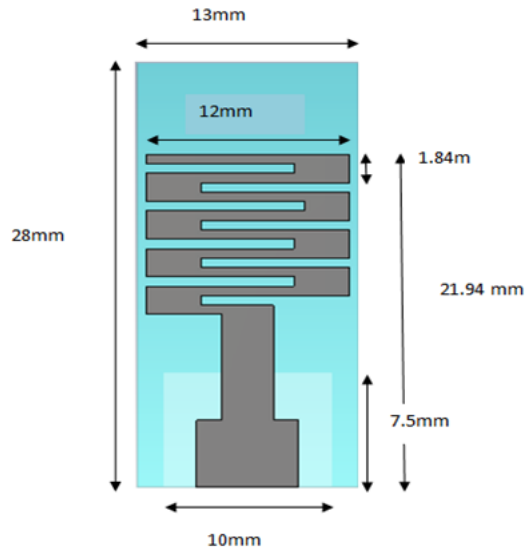

Figure 2. Proposed partial ground meander antenna

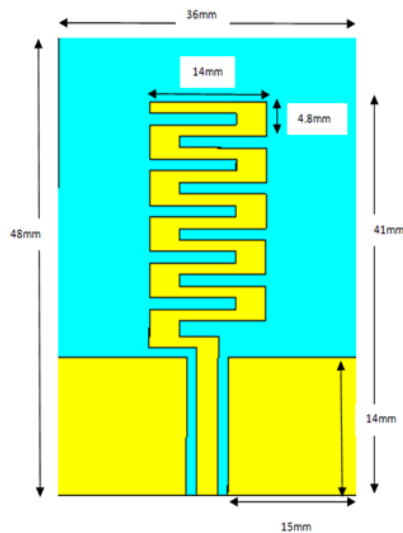

Figure 3. Proposed meander antenna structure using CPW

Equation 1 describes the length of the radiating stubs. To provide a more comprehensive understanding on the performance of the designed radiator, an analysis is conducted on the surface current distribution for different operating bands. The effective radiating element for covering the WLAN band is the shorter radiating stub at 5.5 GHz, where the current distribution is more dominant. However, the longer radiating stub at 3.5 GHz, which covers the WiMAX spectrum, also exhibits more dominance. The design parameters are later optimized. The simulated results are provided and the shorter radiating stub length's influence is examined. The upper resonance frequency of the shorter stub is controlled independently by adjusting its dimensions, whereas the lower resonance frequency is kept fixed [Atrash et al. \(2017\)](#). Vice versa for the longer radiating stub. Thus, the dual-band CPW-fed planar antenna structure looks to be simple, easy, and versatile for the MIMO applications.

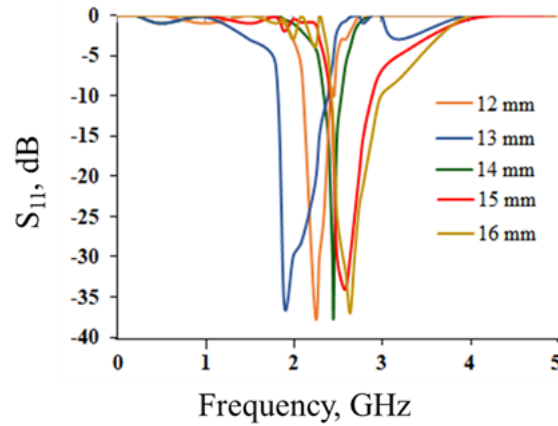

Figure 4. Parametric analysis for various arm length

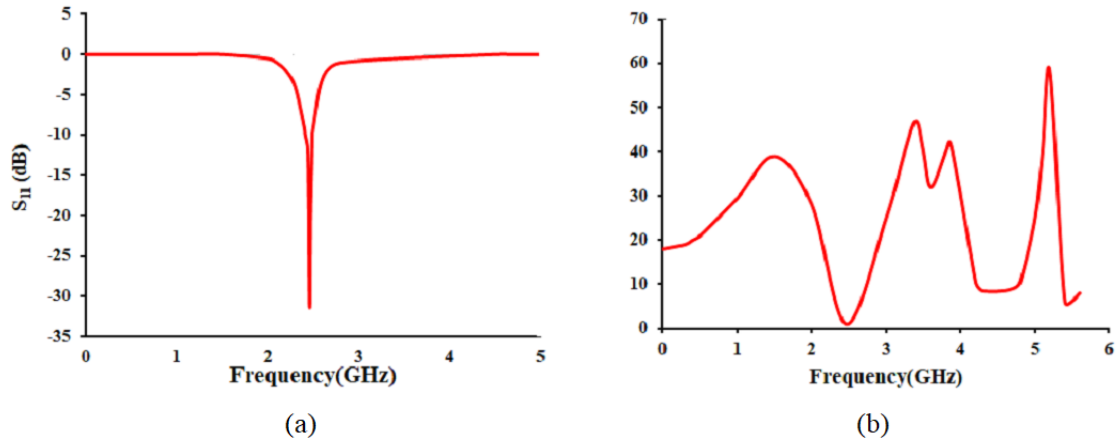

Figure 5. (a) Characteristics of reflection coefficient and (b) VSWR curve of meander antenna with partial ground

2.1. Design Procedures

The meander antenna is mainly used for size reduction of the antenna. The size of the meander antenna is minimized based on the factor, which is directly proportional to the number of turns at the operating frequency. The adjacent turns in the proposed meander antenna should have opposite phase. As a result, the efficiency of the meander antenna increases as its number of turns increases. Thus, the resonant frequency of the meander antenna is a function of spacing and distance between the turns in the antenna [Ramya Bhagavatula and Linehan \(2008\)](#). The resonant frequency decreases with increasing meander spacing and separation [Misman et al. \(2009\)](#). Thus, the meander antenna is small and has a good radiation efficiency when compared with other conventional antennas. With these design procedures, the research proposes a meander antenna with partial ground followed with the coplanar structure.

2.2. Partial Ground Meander Antenna

Partial ground meander line antenna is patterned on jeans as substrate. The footprint of the proposed antenna is $28 \times 13 \text{ mm}^2$ which is electrically small whose length is reduced to $\lambda/10$. The quarter wave transformer helps for impedance matching. The proposed meander antenna, as shown in Fig. 2, consist of 8 turns. Spacing and separations are the same among the 8 turns. A metal layer of size $10 \times 7.5 \text{ mm}^2$ with the thickness as 0.035 mm is placed behind the substrate. The antenna's characteristics depend on the structure of the patch, material of the antenna and

too on the dimensions of the ground plane [Karimian et al. \(2013\)](#). Thus, the reduction in the size of the ground plane enhances the characteristics of the meander antenna. This method improves the efficiency of the proposed meander antenna by better impedance matching, and size reduction.

2.3. CPW Meander Antenna

Followed by the meander antenna with partial ground, the proposed coplanar waveguide (CPW) meander antenna uses jeans substrate. The footprint of the CPW meander antenna is $48 \times 36 \text{ mm}^2$. The most appealing part of the antenna is that it shields the body from backscatter radiation by functioning as a reflector or isolator [Karimian et al. \(2012\)](#). In addition, the performance of the gain of the meander antenna is improved by incorporating CPW. Although the dimension of the substrate is about $48 \times 36 \text{ mm}^2$, whereas the dimension of the patch is about $41 \times 14 \text{ mm}^2$. Both the thickness of the patch and ground is considered as 0.035 mm. The number of turns in the proposed meander antenna with CPW is increased to 11 and the spacing between the turns is 1.2 mm. The proposed CPW meander antenna is shown in Fig. 3. The length of the arm is optimized to 14 mm which resonates at 2.45 GHz. The arm length of the CPW meander antenna is optimized for various lengths as depicted in Fig. 4.

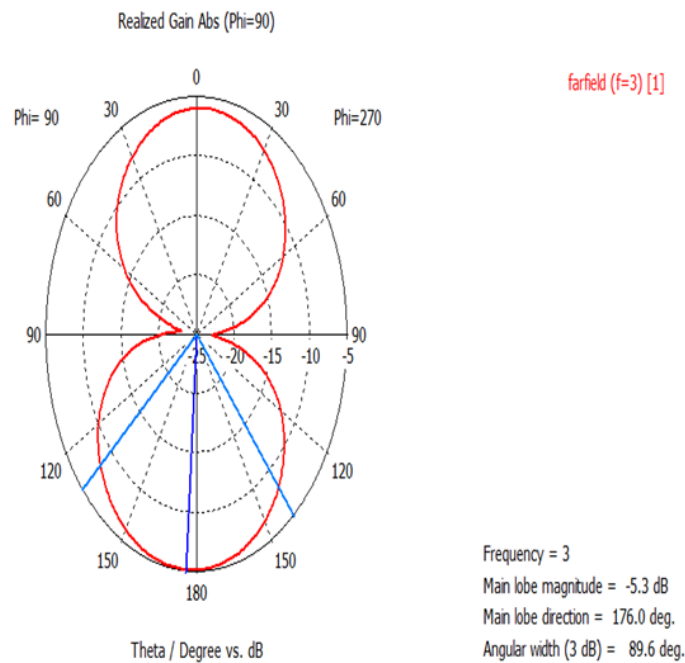

Figure 6. Simulated radiation pattern of meander antenna with partial ground

3. Simulated Results

The proposed meander antenna using partial ground and CPW are simulated and the results are discussed in this section. The parameters viz. VSWR, reflection coefficient, gain and bandwidth are discussed. In general, the reflection coefficient is defined as the amount of power reflected from the antenna. The VSWR of the antenna defines the efficiency of the transmitted power from the antenna. The minimum VSWR is 1.0. The conventional formula of VSWR with respect to the reflection coefficient (Γ) is given in Eq. 2.

$$VSWR = \frac{1 + |\Gamma|}{1 - |\Gamma|} \quad (2)$$

The range of frequencies in which an antenna can operate perfectly is said to be bandwidth. The formula for percentage bandwidth using higher (F_H), lower (F_L), and center frequency (F_C) as

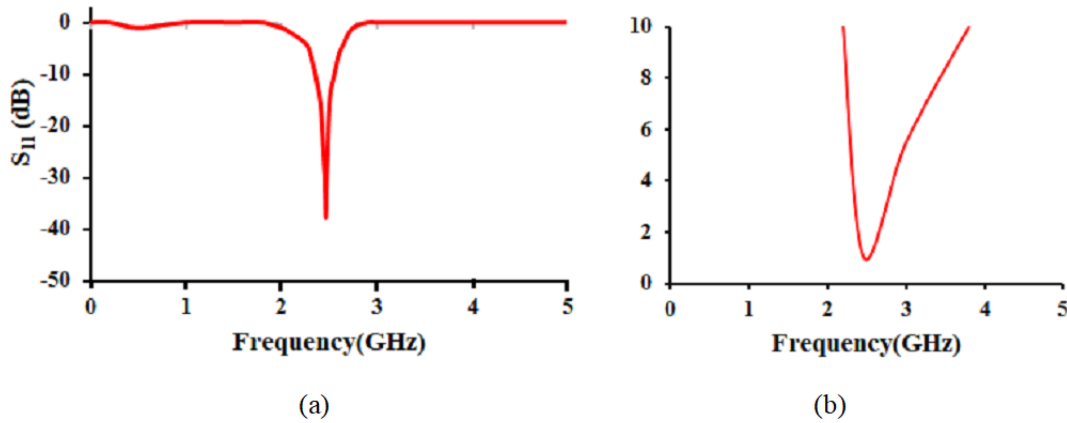

Figure 7. (a) Characteristics of reflection coefficient (S_{11}) and (b) VSWR curve of meander antenna with CPW

shown in Eq. 3

$$\%BW = \frac{(F_H - F_L)}{F_C} * 100 \quad (3)$$

The antenna's relative strength of the fields radiated in different directions at a constant distance is described as the radiation of the antenna. Gain of the antenna is defined as in Eq. 4. Thus,

$$Gain = 4\pi \frac{\text{Radiation Intensity}}{\text{Total Input (accepted)}} = 4\pi \frac{U(\theta, \phi)}{P_{in}} \quad (4)$$

3.1. Meander Antenna Using Partial Ground Plane

The simulated results of the designed partial ground plane meander antenna are discussed in this section. The proposed meander antenna operates at 2.45 GHz with the bandwidth of 120 MHz. This antenna offers -5.2 dB as gain which is not sufficient for WLAN application. The characteristic of reflection coefficient for meander antenna using partial ground is shown in Fig. 5(a). Similarly, the characteristics of VSWR is shown in Fig. 5(b), whose value obtained is 1.028. The simulated gain of the proposed antenna is shown in Fig. 6.

3.2. Meander Antenna using CPW

To enhance the parameters like gain and bandwidth for WLAN applications, the proposed meander antenna is optimized and CPW is incorporated to the meander antenna. The simulated results of the meander antenna with CPW are discussed here. The meander antenna using CPW operates at 2.45 GHz whose bandwidth is 280 MHz as shown in Fig. 7(a). The characteristic of VSWR is shown in Fig. 7(b). The gain of the meander antenna using CPW is improved to 3.528 dB as shown in Fig. 8.

4. Triband Meander Antenna and Simulated Results

4.1. Meander Antenna for Multiband

In the recent years, multimode communication systems uses multiband antennas with high interest. Owing to low cost and process simplicity, these applications uses monopole antennas widely [Nezhad and Hassani \(2010\)](#). In addition to the meander antenna designed in the previous section, the monopole arms are appended with that to achieve better performance of meander antenna for WLAN application. To meet the needs of WLAN (wireless local area networks) and WiMAX (International interoperability for microwave access) applications, research is therefore

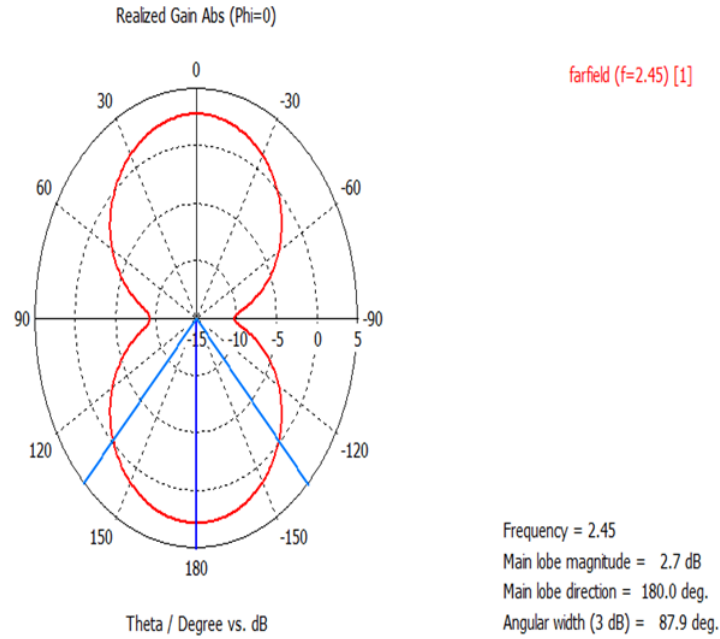

Figure 8. Radiation pattern for meander antenna with CPW based on the simulation

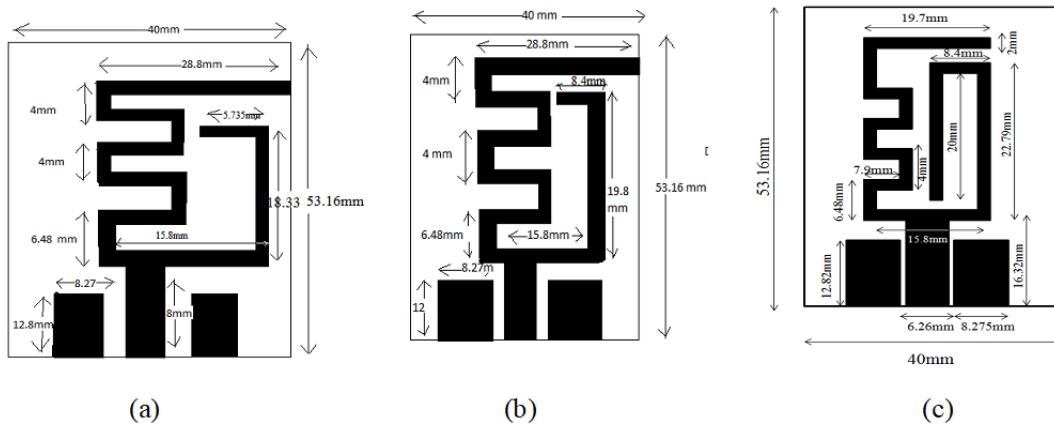

Figure 9. Proposed meander antenna with (a) $\lambda/7$ dipole (b) $\lambda/6$ dipole (c) $\lambda/5$ dipole

expanded to create the meander antenna for triple band operations. Thus, the slit is inserted in the design to achieve triple band with more bandwidth. The triple band performance is most commonly used in 2.4GHz/5.8GHz WLAN bands and 3.5GHz/5.5GHz WiMAX bands [Ambhore and Dhande \(2012\)](#) & [Mallahzadeh et al. \(2011\)](#). The microstrip antenna is modeled and simulated using the EM simulator. The complexity in this design is to consider many dimensional parameters. Later, the parametric analysis is done followed by the design of the microstrip triple band antenna.

4.2. Design of Meander Antenna for Triple Band

The modified meander antenna tend to print on the FR4 substrate whose thickness is 1.6 mm with 4.4 as dielectric constant. The proposed antenna comprises of three folded lines with a fixed strips. To centrally feed the antenna from its bottom edge, a 50Ω CPW feeding signal strip with a thickness of ' W_f ' and a gap spacing of ' g ' between the signals trip and ground is utilized. Equal finite ground planes are utilized, one on each side of the CPW feeding line, with width (W_g) and length (L_g) arranged symmetrically. Table 1 shows the optimized geometrical parameters of the

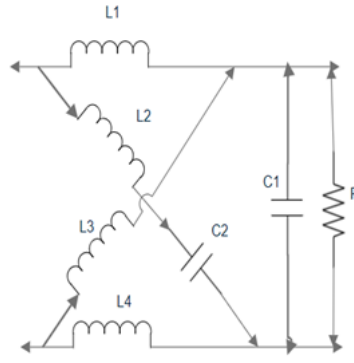

Figure 10. Equivalent circuit for the proposed meander antenna with $\lambda/7$ dipole

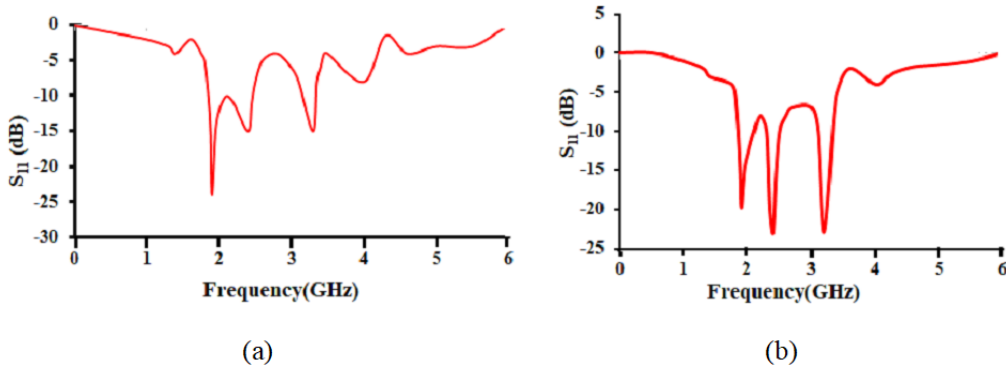

Figure 11. Characteristics of reflection coefficient of meander antenna with (a) $\lambda/6$ dipole and (b) $\lambda/5$ dipole

antenna. Fig. 10 shows the equivalent circuit for the proposed meander antenna with $\lambda/7$ dipole.

4.3. Simulated Results of Meander Antenna for Triple Band

The proposed modified meander antenna with $\lambda/6$ dipole is shown in Fig. 9(b), resonates at three frequencies, such as 1.90 GHz, 2.4 GHz and 3.37 GHz with the magnitude of reflection coefficient as 24.08 dB, -15 dB and -14.94 dB, respectively, as shown in Fig. 11(a). Similarly, the proposed meander antenna with $\lambda/5$ dipole as shown in Fig. 9(c), resonates at 1.8 GHz, 2.4 GHz and 3.2 GHz with the return loss as -19.8 dB, -23 dB and -22.94 dB, respectively as depicted in Fig. 11(b).

4.4. Surface Current of Meander Antenna for Triple Band

Figure 12(a) shows the surface current of the meander antenna whose dipole length is $\lambda/7$. Similarly, the surface current for $\lambda/6$ and $\lambda/5$ dipole is shown in Fig. 12(b-c), respectively. The fabricated meander antenna with different dipole lengths are depicted in Fig. 13(a-c), respectively. Figure 14 shows the measurement set up for the $\lambda/5$ dipole meandered antenna.

5. Testing of Meander Antenna Using SDR Device

5.1. Detection of Spectrum Hole

The proposed meander antenna is designed and developed with appropriate substrates. The fabricated antenna is tested in the real-time environment for its performance. For the real-time environment, the transmission and reception radio link is established and tested using SDR device. The SDR device is operated at 2.5 GHz. The proposed modified meander antenna is tested to

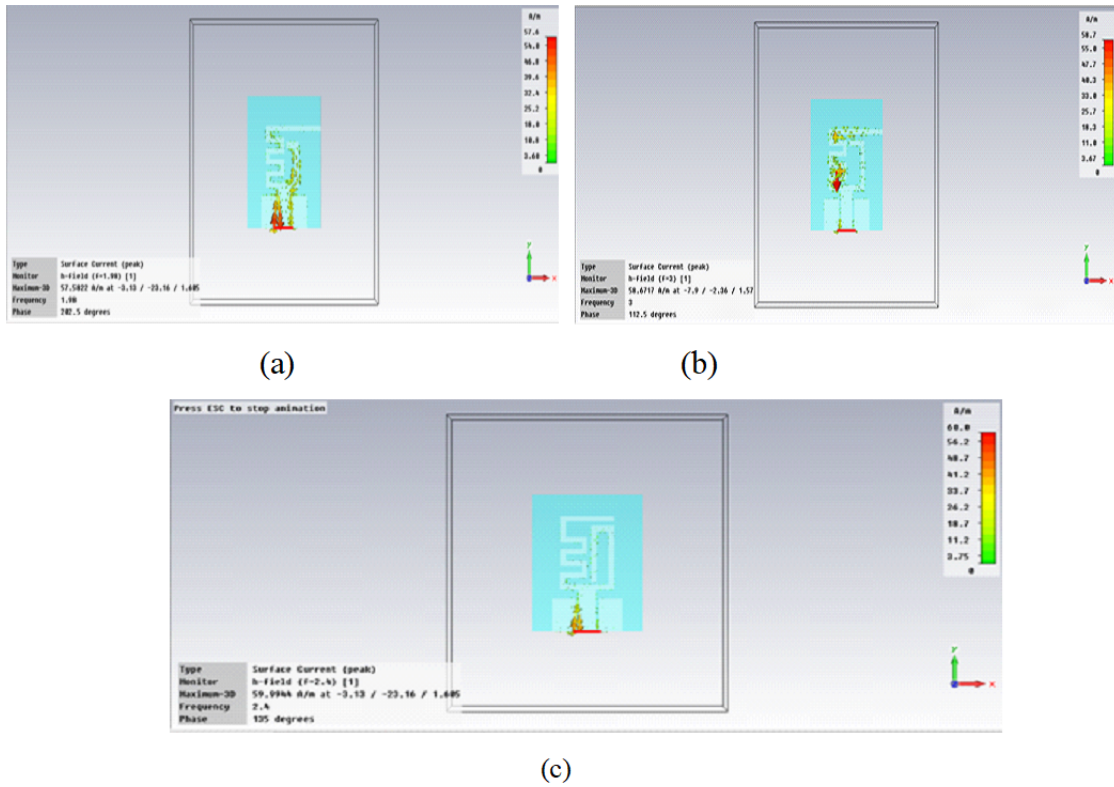

Figure 12. Surface current of the proposed meander antenna with (a) $\lambda/7$ dipole, (b) $\lambda/6$ dipole and (c) $\lambda/5$ dipole

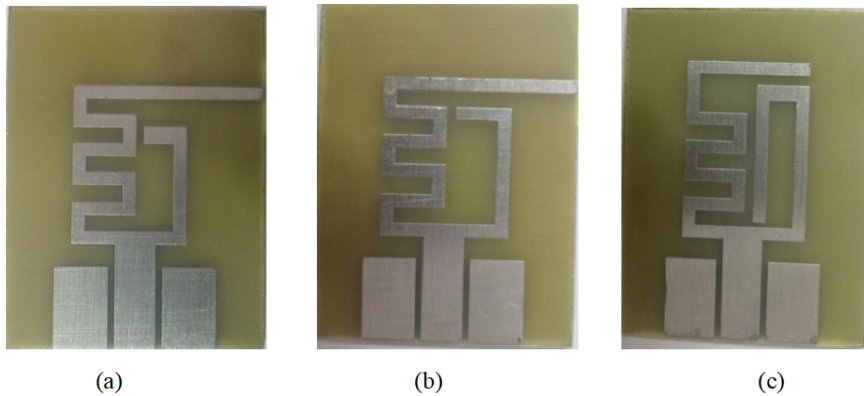

Figure 13. Fabricated meander antenna with (a) $\lambda/7$ dipole, (b) $\lambda/6$ dipole and (c) $\lambda/5$ dipole

observe the spectrum hole using SDR device. Figure 15 shows the spectrum showing the frequency band 452.411 MHz “UNOCCUPIED” in TV band and the power level is also observed. Figure 16 depicts the transmission and reception of audio files in the unoccupied 452.411 MHz frequency band.

5.2. Results and Discussion

This section discusses about the detected and utilized white spaces in the frequency spectrum and their respective SNR analysis.

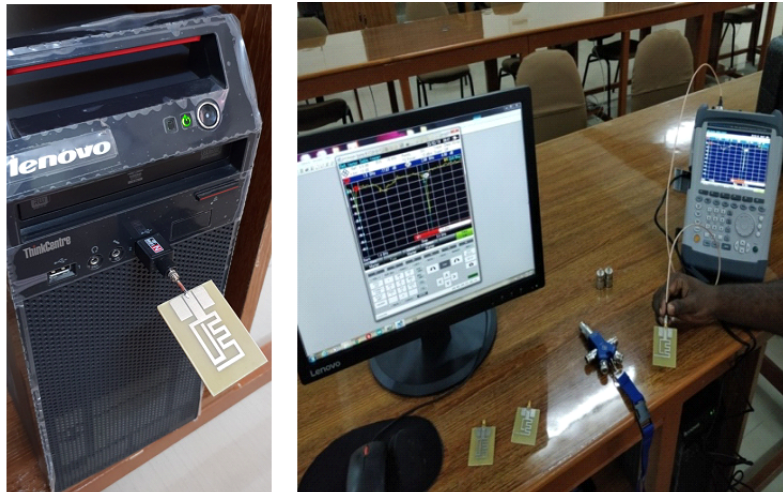

Figure 14. Measurement set up of proposed meander antenna with $\lambda/5$ dipole

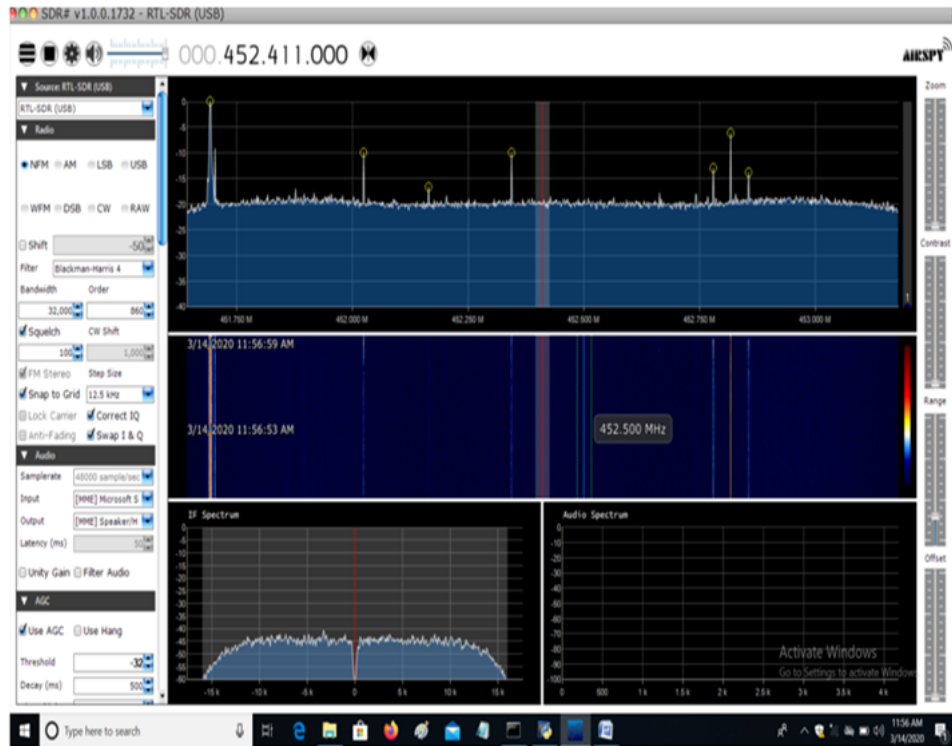

Figure 15. Spectrum showing the frequency band 452.411 MHz “UNOCCUPIED”

5.2.1. White space detection in the military band

The primary mode of communication is narrowband FM. In the 225–400 MHz range, the military application uses the BIG (175 MHz) military aviation band. The intervals between the channels is considered as 25 kHz. Figure 17 illustrates the audio file transmission and reception at 342.4 MHz.

5.2.2. White space detection in the FM band

The FM radio spectrum is located between VHF television Channels 6 and 7 and spans 88 MHz to 108 MHz. Assigning center frequencies to FM stations begins at 88.1 MHz and goes up to 100

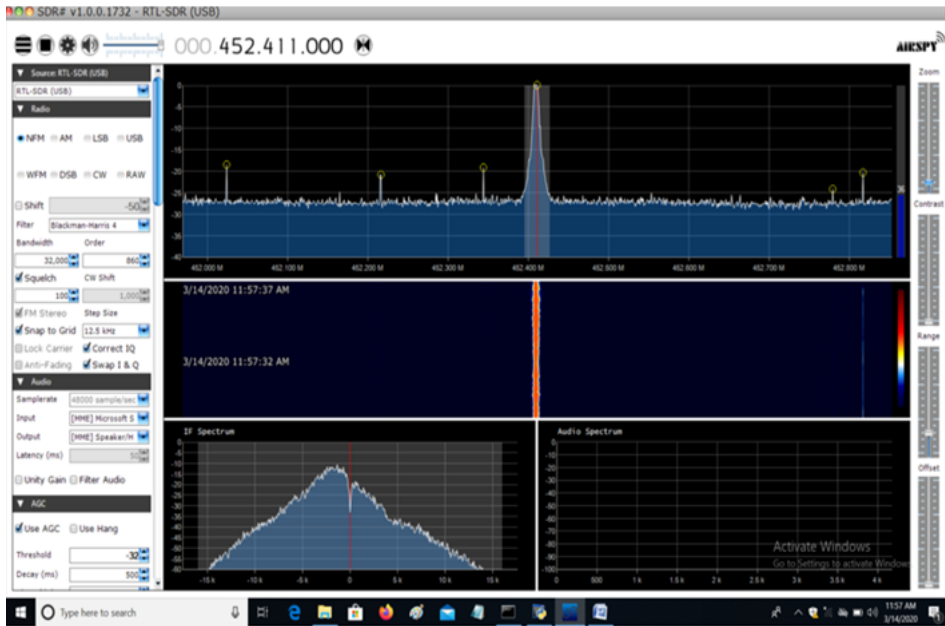

Figure 16. Transmission and reception of audio files in the previously unoccupied 452.411MHz frequency band

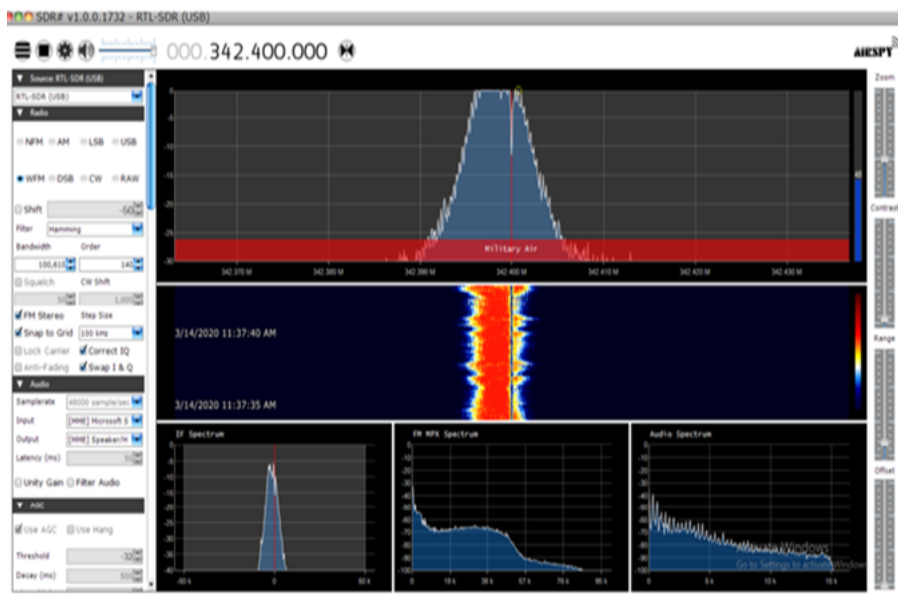

Figure 17. Audio file transmission and reception at 342.4 MHz

stations with a 200 KHz spacing. The audio file transmission in the Ham band at 222.4 MHz with a lower SNR of 24.7 db is shown in Figs. 18 and 19 shows the reception of .wav file in WBFM band (FM broadcast) at an SNR of 33.6 dB. The reception quality of signal is more predominant in WBFM. The SNR value is defining the signal quality.

6. Conclusion

This research proposes a new reconfigurable MIMO antenna design for dual band applications using CPW feeding. PIN diodes are used in the proposed reconfigurable two-element MIMO antenna to enable three controllable performances: simultaneous WLAN and WiMAX coverage, WLAN coverage, and WiMAX coverage. The orthogonal alignment approach is used in the de-

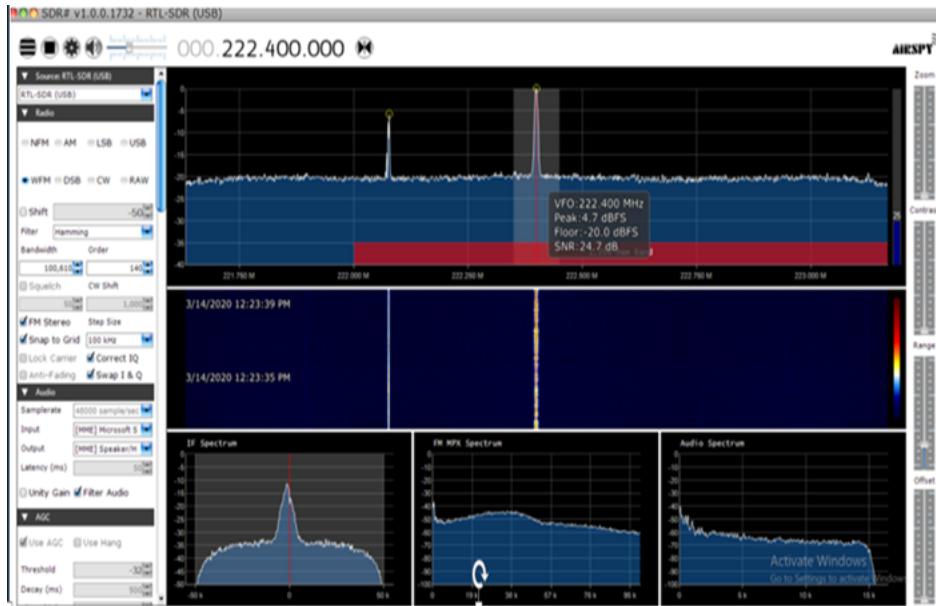

Figure 18. Audio file transmission at 222.4MHz in the Ham band with lower SNR of 24.7dB

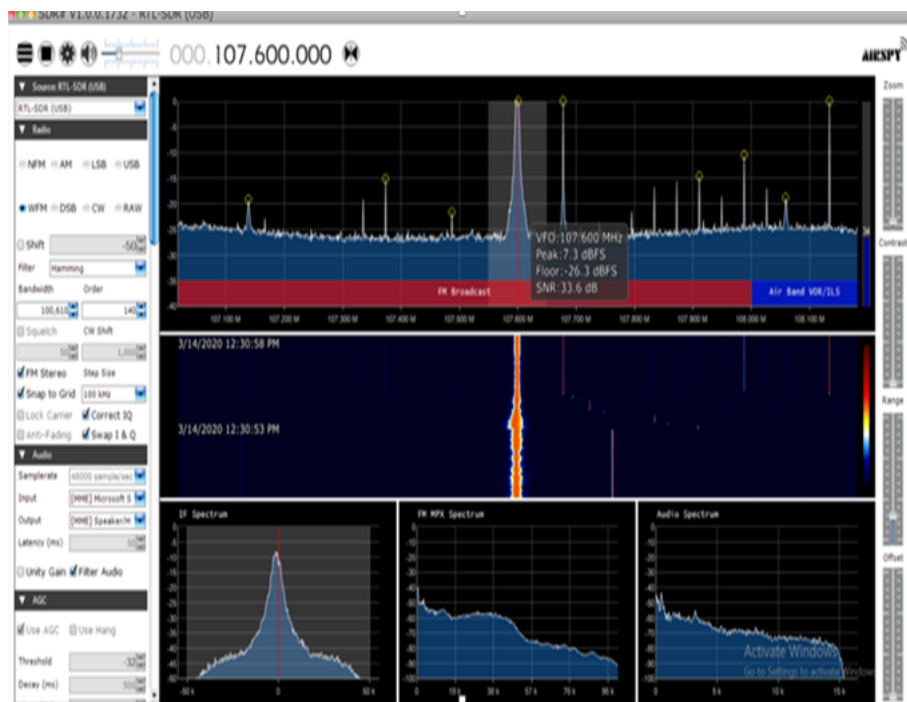

Figure 19. Reception of .wav file in WBFM band (FM broadcast) at an SNR of 33.6dB

scribed MIMO antenna configuration to improve isolation and polarization diversity among the antennas. The manufactured reconfigurable MIMO antenna measures only 48.5×25 mm and offers more than 16 dB of isolation between its ports across all switchable performance levels. The results show that the reconfigurable MIMO antenna that has been suggested can be a good fit for a variety of contemporary WLAN and WiMAX applications owing to its simple configuration and the ease of fabrication.

References

- Ambhore, V and Dhande, A. Properties and design of single element meander line antenna. *International Journal of Advanced Research in Computer Science*, 3, 2012. ISSN 09765697.
- Atrash, M. E; Bassem, K, and Abdalla, M. A. A compact dual-band flexible cpw-fed antenna for wearable applications. volume 2017-January, 2017. doi: 10.1109/APUSNCURSINRSM.2017.8073274.
- Garg, R; Bhartia, P; Bahl, I, and Ittipiboon, A. *Microstrip antenna design handbook*. 2001.
- Gupta, B; Sankaralingam, S, and Dhar, S. Development of wearable and implantable antennas in the last decade: A review. 2010. doi: 10.1109/MMW.2010.5605178.
- Karimian, R; Soleimani, M, and Hashemi, S. M. Tri-band four elements mimo antenna system for wlan and wimax application. *Journal of Electromagnetic Waves and Applications*, 26, 2012. ISSN 09205071. doi: 10.1080/09205071.2012.734433.
- Karimian, R; Oraizi, H; Fakhte, S, and Farahani, M. Novel f-shaped quad-band printed slot antenna for wlan and wimax mimo systems. *IEEE Antennas and Wireless Propagation Letters*, 12, 2013. ISSN 15361225. doi: 10.1109/LAWP.2013.2252140.
- Khan, S; Singh, V. K, and B, N. Textile antenna using jeans substrate for wireless communication application. *International Journal of Engineering Technology Science and Research IJETSR www.ijetsr.com ISSN*, 2, 2015.
- Mallahzadeh, A. R; Seyyedrezaei, S. F; Ghahvehchian, N; Nezhad, S. M. A, and Mallahzadeh, S. Tri-band printed monopole antenna for wlan and wimax mimo systems. 2011.
- Misman, D; Aziz, M. Z. A; Husain, M. N, and Soh, P. J. Design of planar meander line antenna. 2009.
- Nezhad, S. M. A and Hassani, H. R. A novel triband e-shaped printed monopole antenna for mimo application. *IEEE Antennas and Wireless Propagation Letters*, 9, 2010. ISSN 15361225. doi: 10.1109/LAWP.2010.2051131.
- Purohit, S and Raval, F. Wearable -textile patch antenna using jeans as substrate at 2.45 ghz. *International Journal of Engineering Research Technology (IJERT)*, 3, 2014.
- Ramya Bhagavatula, R. W. H. J and Linehan, K. Performance evaluation of mimo base station antenna designs. *Antenna Systems and technology magazine*, 11:14–17, 2008.
- Rashed, J and Tai, C.-T. A new class of resonant antennas. *IEEE Transactions on Antennas and Propagation*, 39, 1991. ISSN 0018926X. doi: 10.1109/8.99054.
- Sankaralingam, S and Gupta, B. Development of textile antennas for body wearable applications and investigations on their performance under bent conditions. *Progress In Electromagnetics Research B*, 2010. ISSN 19376472. doi: 10.2528/PIERB10032705.