



**HAL**  
open science

## Offline real-time high frequency data logging based methodology for PMSM observer design

Samar Alhaj Hassan, Romain Delpoux, Lubin Kerhuel, Vincent Lechappe, Xavier Brun

### ► To cite this version:

Samar Alhaj Hassan, Romain Delpoux, Lubin Kerhuel, Vincent Lechappe, Xavier Brun. Offline real-time high frequency data logging based methodology for PMSM observer design. ELECTRIMACS 2024 - Castelló, May 2024, Castelló de la Plana, Spain. <hal-04591816>

**HAL Id: hal-04591816**

**<https://hal.science/hal-04591816v1>**

Submitted on 29 May 2024

HAL is a multi-disciplinary open access archive for the deposit and dissemination of scientific research documents, whether they are published or not. The documents may come from teaching and research institutions in France or abroad, or from public or private research centers.

L'archive ouverte pluridisciplinaire HAL, est destinée au dépôt et à la diffusion de documents scientifiques de niveau recherche, publiés ou non, émanant des établissements d'enseignement et de recherche français ou étrangers, des laboratoires publics ou privés.



HAL Authorization

# Offline real-time high frequency data logging based methodology for PMSM observer design

Samar ALHAJ HASSAN · Romain DELPOUX · Lubin KERHUEL · Vincent LECHAPPE · Xavier BRUN

**Abstract** This article presents a methodology for a faster development of observers. On board real-time high frequency measurements are logged and used as inputs to validate an open-loop observer in an offline simulation. It allows embedded implementation constraints to be taken into account as early as possible in the development process. The proposed method facilitates and speeds up the design procedure compared to on-board validation, which often involves trial and error gain tuning. The suggested approach is illustrated through the design of an observer for mechanical sensorless control of Permanent Magnet Synchronous Moteur (PMSM) using an industrial benchmark. The solution is implemented on a low-cost microcontroller, using Rapid Control Prototyping (RCP) on Matlab/Simulink. The overall strategy and logged data are available online under an open-source license.

## 1 Introduction

Digital controllers are increasingly present in industrial applications (automotive, aeronautics, space...). Manufacturers in these domains seek ways to reduce global cost while maintaining good performances [8]. Among popular solutions, state space observer are used to replace physical sensors by software ones. Developing embedded controllers requires various skills, some of which are out of scope of the typical curriculum of control system engineers, generally

S. ALHAJ HASSAN, R. DELPOUX, V. LECHAPPE · X. BRUN  
INSA Lyon, Université Claude Bernard Lyon 1, École Centrale de Lyon CNRS, Ampère, UMR5005  
Villeurbanne, France

e-mail: samar.alhaj-hassan@insa-lyon.fr, romain.delpoux@insa-lyon.fr, vincent.lechappe@insa-lyon.fr, xavier.brun@insa-lyon.fr

L. KERHUEL Microchip Technology Inc.  
e-mail: Lubin.Kerhuel@microchip.com

limited to control design tools like Matlab/Simulink® and RCP with dSPACE® or Speedgoat®. However, to speed up the development of observers-based solutions, it is necessary to consider precise models with parameter uncertainties as well as embedded constraints such as Analog to Digital Converter (ADC) quantification, noise measurements, delays, sensors' precision, execution time. . . .

Having a simulation model that takes all these elements into account would be the best approach, but it requires a great knowledge of the physical model, control, RCP tools, sensors properties. . . This modelling solution often leads to complex models, that are often specific to the application, even to the operating conditions, and are slow to execute.

To factor in these elements, with less time and efforts, it is interesting to produce real-time data of system variables required for observation, directly from the application target chip. In this perspective, the proposed approach is based on a RCP solution, using Matlab/Simulink and the advantage of the graphical interface, which targets low cost industrial Digital Signal Controller (DSC) directly. The solution here is based on the use of the Microchip Technology MPLAB® device blocks for Simulink solution. It is important to note that unlike some existing setups [11], the objective is not to hide the code generation process and make it totally transparent, but to make it accessible in order to tackle implementation problems. A dsPIC® DSCs and its MPLAB toolbox for Simulink has been used for this article, but other manufacturer DSCs or Motor Control unites (MCU) may benefit from this methodology whenever a dedicated toolbox exists. Replicating the exact behavior of the on-chip observer in an offline-simulation presents several advantages:

- accelerating the open-loop verification: a fixed-step simulation is faster than RCP and on-board test,
- reducing on-chip gain tuning, since the data used is closer to the embedded behavior,

- having a unified benchmark for offline comparison between open-loop observers,
- taking into account implementation constraints for observer open-loop validation, with no hardware.

This method is limited to open-loop observer validation: the estimation use in the control clearly impacts the observer’s logged inputs.

The contributions of this work are threefold (i) a complete methodology to speed up observer design, based on RCP solution that targets low cost microcontrollers, (ii) implementing the benchmark proposed for sensorless control of electrical motor presented in [5] on a PMSM test bench and finally, (iii) in order to make the process as educational as possible, illustrating the methodology through an example for sensorless strategy ([4], [6], [9]), the data, the hardware, and tutorials required for the proposed solution are available online [2, 1], under open-source license.

The paper is organized as follows: Section 2 describes the suggested methodology and its application to the chosen benchmark, Section 3 details the PMSM model and the design of the observer, the experimental results are then illustrated in Section 4. The last section presents the paper’s conclusion and perspectives.

## 2 Offline real-time high frequency data logging based methodology

### 2.1 Methodology

The proposed methodology in this article follows RCP solution proposed in [3] and available online on our website [2]. In these documents, an efficient solution for RCP of PMSM is proposed based on low-cost microcontrollers. The objective is to use the data from this control strategy for the design of observers. The overall strategy is illustrated in Fig.1, differences with the classical approach are highlighted in green. Classically, observer design process usually consists of simulation (as reported in [7]), followed by on-board tests in open-loop, where estimated variables are compared with the measured ones and then in closed-loop where estimated variables are used in the control instead of the measured ones. Thanks to the realization of real-time high frequency data logging, the observer synthesis can be first tuned offline on real data, before being tested on-board.

While high-frequency data logging was limited to the use of expensive RCP systems like dSpace, here the use of a USB 2.0 Hi-Speed to Universal Asynchronous Receiver Transmitter (UART) cable based on FTDI’s FT232H USB to UART interface device allows high speed transmission. The cable used provides a fast, simple way to connect devices with 3.3 volt digital interfaces to USB. Given that the control algorithm’s sampling frequency is at 20kHz, it has been possible to obtain a data log with 6 variables using a baud rate

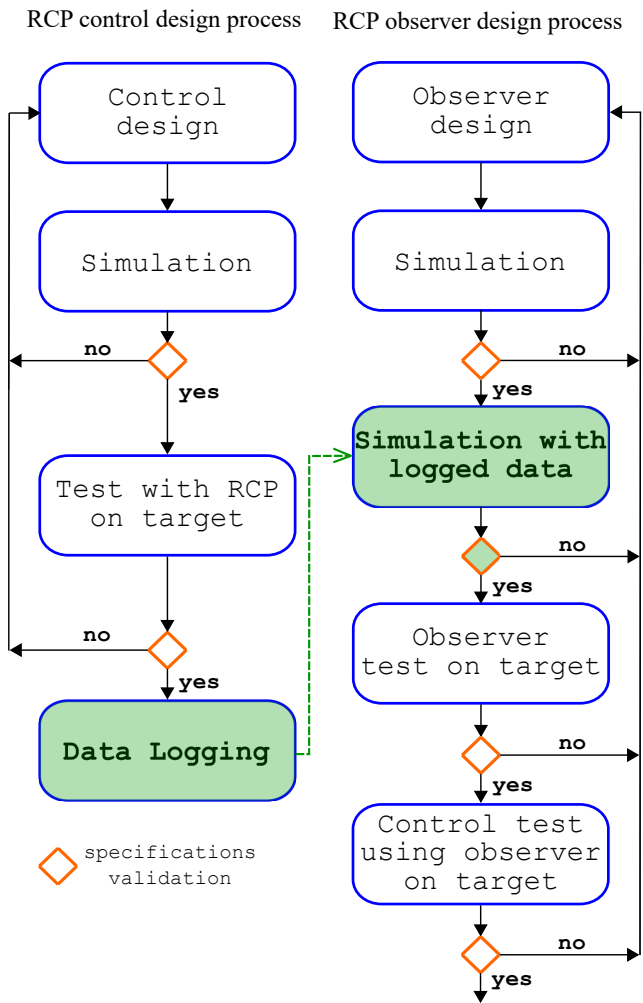

Fig. 1: Proposed observer design methodology

of  $6 \times 10^6$  baud. On the remote computer, the data are collected thanks to a lightweight serial terminal, RealTerm has been used here.

### 2.2 PMSM Benchmark

The test bench used in this article to illustrate the methodology consists of two Teknic-2310P motors PMSMs (PMSM<sub>1</sub> and PMSM<sub>2</sub>) in a head-to-head configuration as shown in Fig.2.

To evaluate the observer’s convergence for different speed ranges and its robustness with load torque variations, an industrial test trajectory (see Fig.3) [5], is used, where the scale has been adapted to the nominal values of the PMSM used.

Both PMSMs are controlled using Field Oriented Control (FOC). PMSM<sub>1</sub>’s speed is regulated in order to impose a speed trajectory and PMSM<sub>2</sub>’s current (image of the torque) is regulated to apply a load torque. Each PMSM has its own

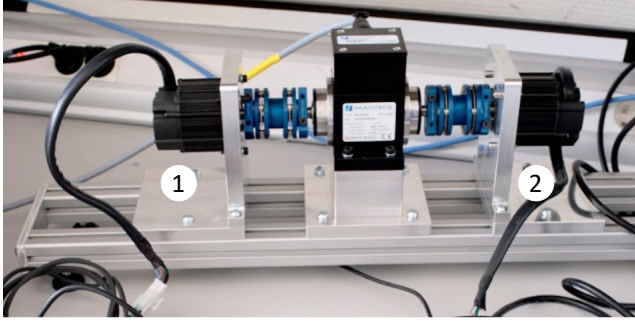

Fig. 2: Experimental setup

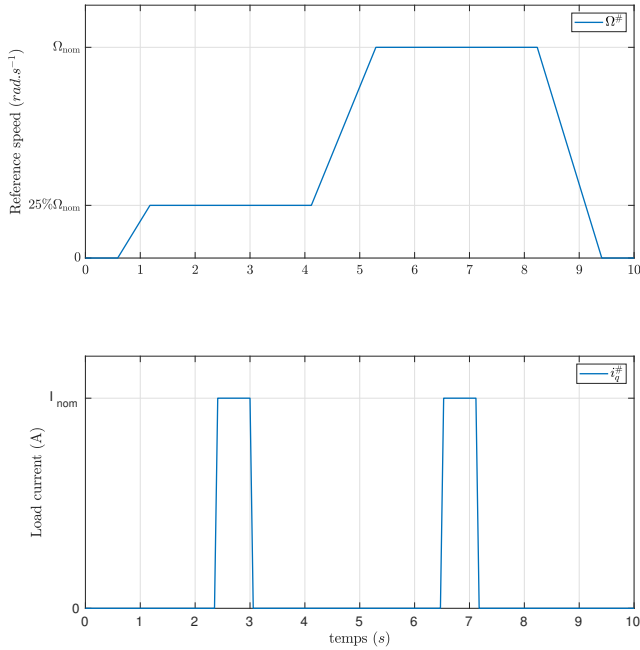

Fig. 3: Industrial benchmark

control board. The control algorithm is detailed in [2]. The proposed closed loop control with load is used to produce the data logging for the offline observer tuning. A general overview of the tested scenarios is schematized in Fig.4

### 3 Study case: PMSM mechanical sensorless control

#### 3.1 Model of the PMSM

In order to properly implement the observation algorithm, the design should be based on the discrete-time model, taking into account the on-chip sample time, the model used is detailed below.

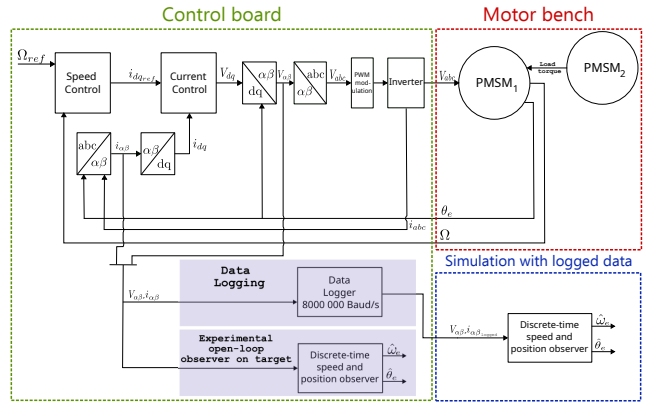

Fig. 4: General tests representation

#### 3.1.1 Continuous model in the $abc$ frame

$$\begin{cases} \frac{di_{abc}}{dt} = -\frac{R}{L}i_{abc} + \frac{1}{L}v_{abc} - \frac{1}{L}e_{abc} \\ J\frac{d\Omega}{dt} = \tau_m - \tau_l \end{cases} \quad (1a)$$

where  $i_{abc}$  are the phase currents,  $v_{abc}$  the phase voltage,  $\Omega$  and  $\theta$  are the motor speed and position.  $L$  and  $R$  are the stator inductance and resistance.

$J$  is the PMSM inertia,  $\tau_l$  is the load torque and  $\tau_m$  is the motor torque.

$$\tau_m = \frac{1}{\Omega} e_{abc}^T i_{abc} \quad (2)$$

$e_{abc}$  are the electromotive forces, with

$$e_{abc} = -\phi_f p \Omega \begin{bmatrix} \sin(p\theta) \\ \sin\left(p\theta - \frac{2\pi}{3}\right) \\ \sin\left(p\theta + \frac{2\pi}{3}\right) \end{bmatrix} \quad (3)$$

where  $\phi_f$  is the flux constant and  $p$  is the pole pairs.

#### 3.1.2 Continuous model in the $\alpha\beta$ frame

In order to observe the speed and angle, the model should be in the  $\alpha\beta$  frame. Through the Clarke transformation of (1a), the continuous current dynamic is expressed as:

$$\begin{cases} \frac{di_{\alpha\beta}}{dt} = -\frac{R}{L}i_{\alpha\beta} + \frac{1}{L}v_{\alpha\beta} - \frac{1}{L}e_{\alpha\beta} \\ e_{\alpha\beta} = \phi_f p \Omega \begin{bmatrix} -\sin(p\theta) \\ \cos(p\theta) \end{bmatrix} \end{cases} \quad (4a)$$

$$(4b)$$

### 3.1.3 Discrete-Time model in the $\alpha\beta$ frame

Using the Zero-Order Hold, for a chosen time step  $T_s$ , (4a) and (4b) can be discretized:

$$\begin{cases} i_{\alpha\beta}(k+1) = A_d i_{\alpha\beta}(k) + B_d v_{\alpha\beta}(k) - B_d e_{\alpha\beta}(k) & (5a) \\ e_{\alpha\beta}(k+1) = e_{\alpha\beta}(k) + T_s p \Omega \mathcal{J} e_{\alpha\beta}(k) & (5b) \end{cases}$$

where  $A_d = e^{-\frac{R}{L} I_2 T_s}$ ,  $B_d = \int_0^{T_s} e^{-\frac{R}{L} I_2 t} \frac{1}{L} I_2 dt$ ,

$\mathcal{J} = \begin{bmatrix} 0 & -1 \\ 1 & 0 \end{bmatrix}$ , the rotation matrix and  $I_2 = \begin{bmatrix} 1 & 0 \\ 0 & 1 \end{bmatrix}$  the identity matrix.

## 3.2 Observer Design

A combination of two observers [6] is implemented to determine the estimated electrical position  $\hat{\theta}_e = p\theta$  and speed  $\hat{\omega}_e = p\Omega$  based on the measured voltage and current in the  $\alpha\beta$  frame as shown in Fig.5.

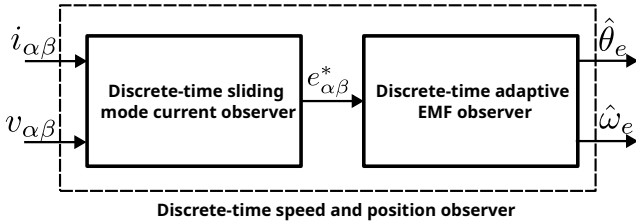

Fig. 5: Block Diagram of the implemented observer

### 3.2.1 Discrete-time Sliding Mode current Observer

Using (5a), a Discrete-time Sliding Mode Observer (DSMO) current observer is proposed:

$$\hat{i}_{\alpha\beta}(k+1) = A_d \hat{i}_{\alpha\beta} + B_d v_{\alpha\beta} - B_d u_{\alpha\beta} \quad (6)$$

where  $\hat{i}_{\alpha\beta}$  is the estimated current and

$$u_{\alpha\beta} = e_{\alpha\beta}^*(k) + (B_d^{-1} A_d B_d + h_1 I) \sigma_{\alpha\beta}(k) + h_2 I \text{sign}(\sigma_{\alpha\beta}(k)) \quad (7)$$

$h_1$  and  $h_2$  being positive constants,  $\sigma_{\alpha\beta} = B_d^{-1} \tilde{i}_{\alpha\beta}(k)$  the sliding function,  $\tilde{i}_{\alpha\beta}(k) = \hat{i}_{\alpha\beta}(k) - i_{\alpha\beta}(k)$  denoting the current estimation error. the estimated EMF  $e_{\alpha\beta}^*$  is obtained by filtering  $u_{\alpha\beta}$  using a first order Low Pass Filter (LPF).

By choosing  $h_1$  and  $h_2$  to comply with the sliding conditions and  $\omega_c$  (LPF's cutoff frequency) according to the electrical

speed (see section 4), we ensure the observer's convergence [6].

$$\max([1 - 1 - h_1]M) < h_2 \leq \min([11 - h_1]M) \quad (8)$$

with  $M = \begin{bmatrix} \tilde{\sigma}_{\alpha\max} & \tilde{\sigma}_{\beta\max} \\ \sigma_{\alpha\max} & \sigma_{\beta\max} \end{bmatrix}$ ,  $\tilde{\sigma}_{\alpha\beta}$  being the estimation error.

### 3.2.2 Discrete-time adaptive EMF observer

Assuming that  $\omega_e$  varies slowly between two successive samples, we can define based on (5b), the following EMF observer [6]:

$$\hat{e}_{\alpha\beta}(k+1) = \hat{e}_{\alpha\beta}(k) + T_s \hat{\omega}_e \mathcal{J} e_{\alpha\beta}^*(k) - h_3 \tilde{e}_{\alpha\beta}(k) \quad (9)$$

with  $h_3$  a constant gain and  $\tilde{e}_{\alpha\beta}(k) = \hat{e}_{\alpha\beta}(k) - e_{\alpha\beta}^*(k)$  the EMF estimation error.

The adaptive law to estimate the rotor speed is:

$$\tilde{\omega}_e(k+1) = \frac{\tilde{\omega}_e(k)}{1 + \frac{T_s^2}{2} \gamma \|e_{\alpha\beta}^*(k)\|_2^2} - \frac{T_s \gamma (1 - h_3) (\tilde{e}_{\alpha\beta}^T(k) \mathcal{J} e_{\alpha\beta}^*(k))}{1 + \frac{T_s^2}{2} \gamma \|e_{\alpha\beta}^*(k)\|_2^2} \quad (10)$$

where  $\gamma$  is a positive gain.

The rotor angle estimation  $\hat{\theta}_e$  is finally given by:

$$\hat{\theta}_e(k) = \tan^{-1} \left( -\frac{\hat{e}_\alpha(k+1)}{\hat{e}_\beta(k+1)} \right) - \delta \quad (11)$$

where  $\delta = \tan^{-1} \left( \frac{\hat{\omega}_e(k+1)}{\omega_c} \right)$  is the compensation of the delay introduced by the LPF. The  $(k+1)$  value is used instead of the  $(k)$  one, in order to compensate the discretization error. After choosing a positive value for  $\gamma$ , an adequate value for  $h_3$  is picked to guarantee the observer's stability ([6] eq 38).

## 4 Experimental results

Using the experimental setup illustrated Fig.2, the first step was to generate a data log from the sensed closed loop strategy. The trajectory tracking, was recorded with a sampling frequency of 20kHz, and the results are represented on Fig.6. As mentioned above,  $PMSM_1$ 's speed is regulated according to the speed trajectory of the benchmark, and  $PMSM_2$ 's torque is regulated according to the torque profile Fig.3. The currents and voltages  $i_{\alpha\beta}$  and  $v_{\alpha\beta}$  are logged for the observer's simulation Fig.6 (Top),  $\Omega$  and  $\hat{\Omega}$  are logged for comparison purpose Fig.6 (Bottom). A zoomed view is shown on the right side for a closer look on the logged data: the speed estimation is almost perfectly superposed with the measured value.

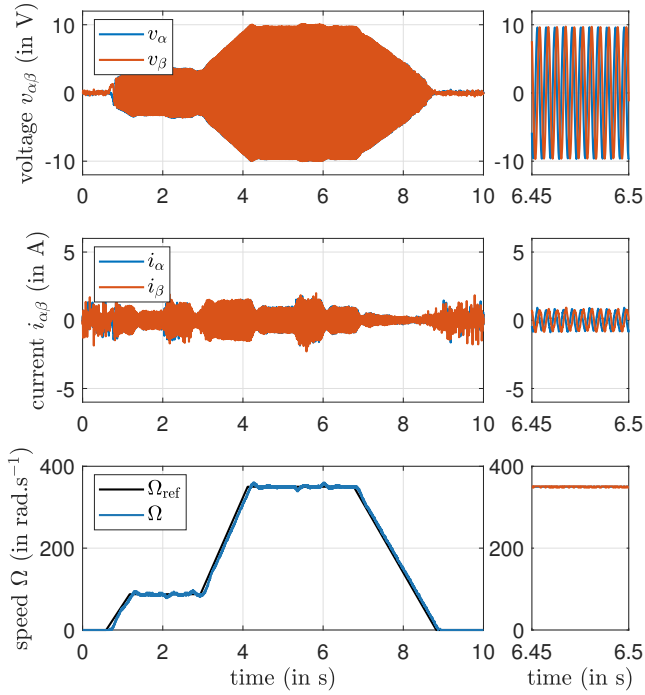

Fig. 6: Embedded sensed closed loop trajectory tracking

The observer's open loop test shows that the embedded and simulated observer, with the same inputs, have very similar results. Fig.7 shows the speed estimation on-board and offline (with the logged data), as well as the estimation error  $e_\Omega$  and the error between offline and online estimations  $e_{\hat{\Omega}_{offline-online}}$ .

These results show that if an observer is validated on offline simulation with the logged inputs, it can safely be assumed that its embedded behavior would also be validated.

After this validation step, the observer's estimations are used instead of the measured speed and angle on-board. Given that the motor speed is not observable near zero, the strategy switches from sensed to sensorless after 2 seconds. A startup strategy, as proposed in [10] should be implemented, but it's a large topic, out of the scope of this article. The results of the closed loop control with the observer are represented on Fig.8. The current and voltages change slightly due to the use of the estimations in the control, the offline estimations are as accurate as before compared to the embedded ones.

## 5 Conclusions and perspectives

In this article a methodology was presented for a faster development of observers. On board real-time high frequency measurement were logged and used as inputs to validate an open-loop observer offline. It allowed embedded implementation constraints to be taken into account as early as possible in the development process. The proposed approach

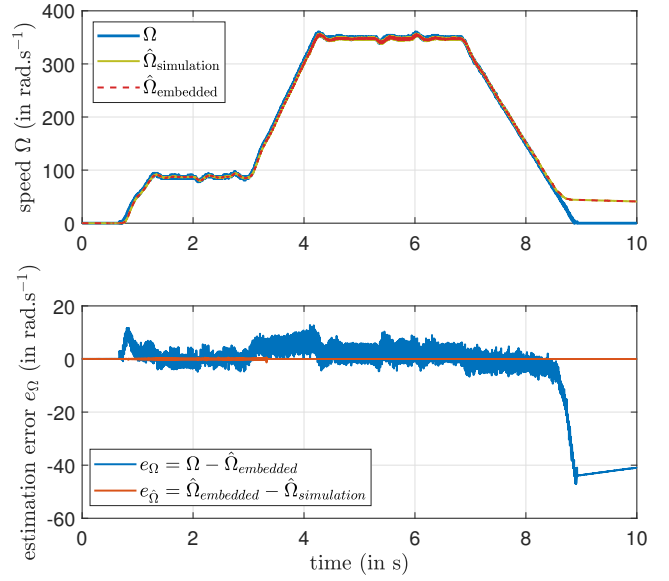

Fig. 7: Speed estimation (Top) and Estimation error (Bottom), embedded and simulated

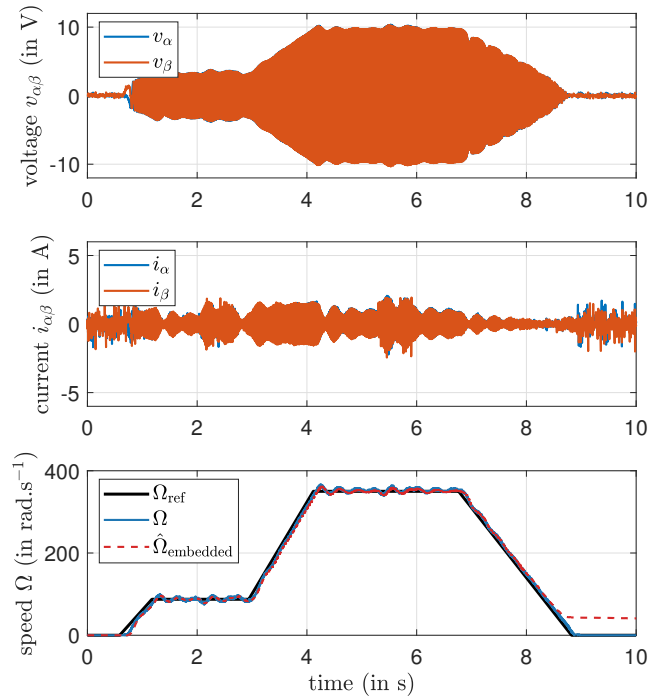

Fig. 8: Embedded sensorless closed loop trajectory tracking

was illustrated through an example: observer design for mechanical sensorless control of PMSM using an industrial benchmark. The proposed benchmark and the logged data are available online.

Future work will focus on using this benchmark for the comparison of different observers from the literature. It would also be interesting to extend the benchmark to other types

of synchronous motor (Interior PMSM, synchronous reluctance motor...).

## References

### References

- [1] *ctrl + elec - github*. URL: <https://github.com/rdelpoux/ctrl-elec>.
- [2] *ctrl + elec - Motor Control University*. URL: <https://ctrl-elec.fr>.
- [3] Romain Delpoux, Lubin Kerhuel, and Vincent Léchappé. “On Chip Rapid Control Prototyping for DC motor”. In: *J3eA* 20 (2021), p. 0001.
- [4] Osama M. Arafa et al. “Observer-based sensorless speed control of PMSM: A focus on drive’s startup”. In: *Journal of Electrical Systems and Information Technology* 3.2 (Sept. 2016), pp. 181–209.
- [5] Alain Glumineau and Jesús De León Morales. *Sensorless AC Electric Motor Control: Robust Advanced Design Techniques and Applications*. Advances in Industrial Control. Cham: Springer International Publishing, 2015.
- [6] Thiago Bernardes et al. “Discrete-Time Sliding Mode Observer for Sensorless Vector Control of Permanent Magnet Synchronous Machine”. In: *IEEE Transactions on Industrial Electronics* 61.4 (Apr. 2014), pp. 1679–1691. ISSN: 0278-0046, 1557-9948.
- [7] Reinhardt Klein et al. “Electrochemical Model Based Observer Design for a Lithium-Ion Battery”. In: *IEEE Transactions on Control Systems Technology* 21.2 (Mar. 2013).
- [8] George Ellis. “Chapter 10 - Introduction to Observers in Control Systems”. In: *Control System Design Guide (Fourth Edition)*. Ed. by George Ellis. Boston: Butterworth-Heinemann, Jan. 2012, pp. 185–212.
- [9] Zihui Wang, Kaiyuan Lu, and F. Blaabjerg. “A Simple Startup Strategy Based on Current Regulation for Back-EMF-Based Sensorless Control of PMSM”. In: *IEEE Transactions on Power Electronics - IEEE TRANS POWER ELECT* 27 (Aug. 2012), pp. 3817–3825.
- [10] Zihui Wang, Kaiyuan Lu, and Frede Blaabjerg. “A Simple Startup Strategy Based on Current Regulation for Back-EMF-Based Sensorless Control of PMSM”. In: *IEEE Transactions on Power Electronics* 27.8 (2012), pp. 3817–3825. DOI: 10.1109/TPEL.2012.2186464.
- [11] Darko Hercog, Milan Curkovic, and Karel Jezernik. “DSP based rapid control prototyping systems for engineering education and research”. In: *2006 IEEE Conference on Computer Aided Control System Design, 2006 IEEE International Conference on Control Applications, 2006 IEEE International Symposium on Intelligent Control*. ISSN: 2165-302X. 2006, pp. 2292–2297.