

A MIXED APPROACH FOR SIMULATING ELASTIC RIBBONS

Sebastien Neukirch (CNRS & Sorbonne University, Paris, France)

Florence Bertails-Descoubes (INRIA Grenoble, France)

Raphael Charrondiere (INRIA Grenoble, France) - *PhD work*

MERCI code:

gitlab.inria.fr/elan-public-code/merci

MERCI = Modèle d'Équilibre de Rubans avec Courbure Intrinsèque



Acknowledgments:

Help with FEniCS-Shell from [Corrado Maurini](#) (Sorbonne University, Paris, France)

Help with Blender from [Octave Crespel](#) (INRIA) and [Lucas Frérot](#) (Sorbonne University)

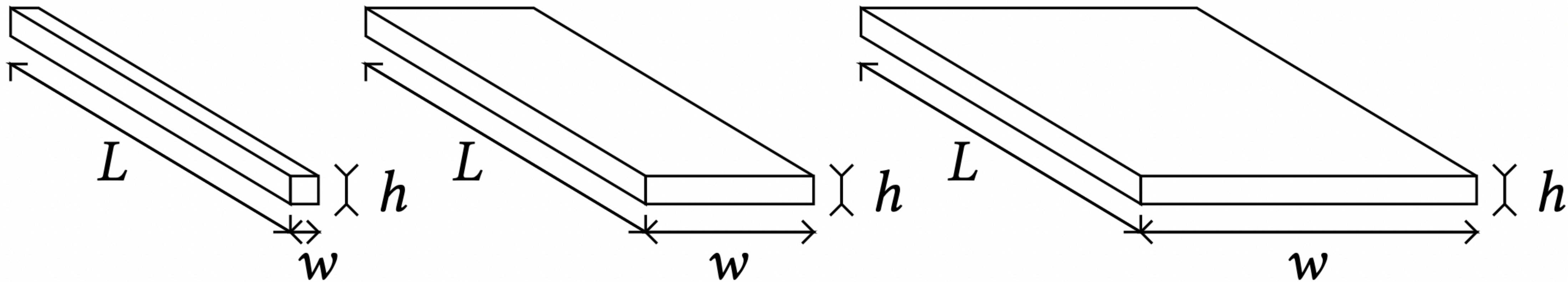

Rod

$$h \sim w \ll L$$

Ribbon

$$h \ll w \ll L$$

Plate

$$h \ll w \sim L$$

Ribbons at all length-scales

Nematic Ribbons (Liquid Crystal Elastomers)

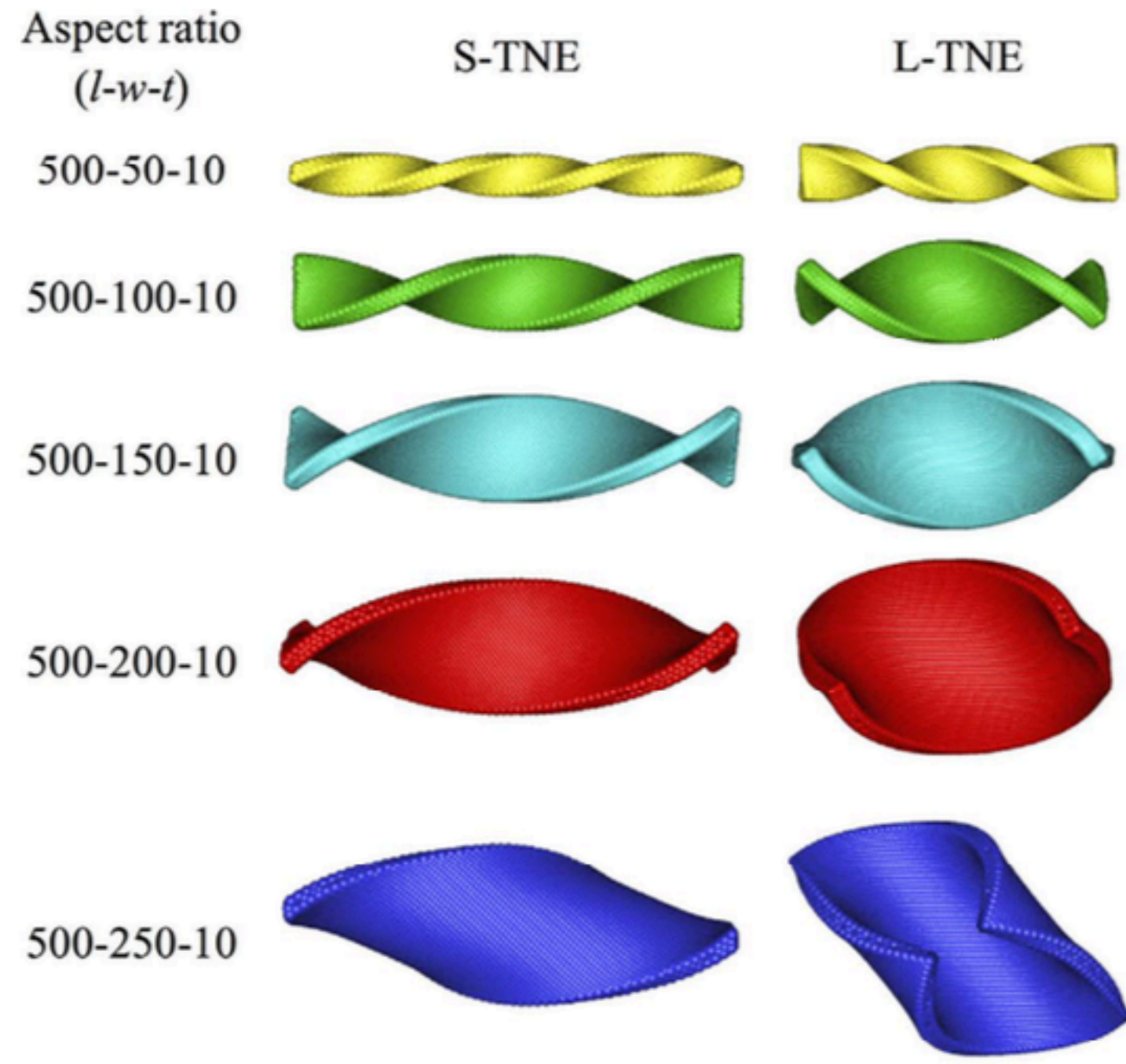

Gimenez-Pinto Scientific Reports 2017

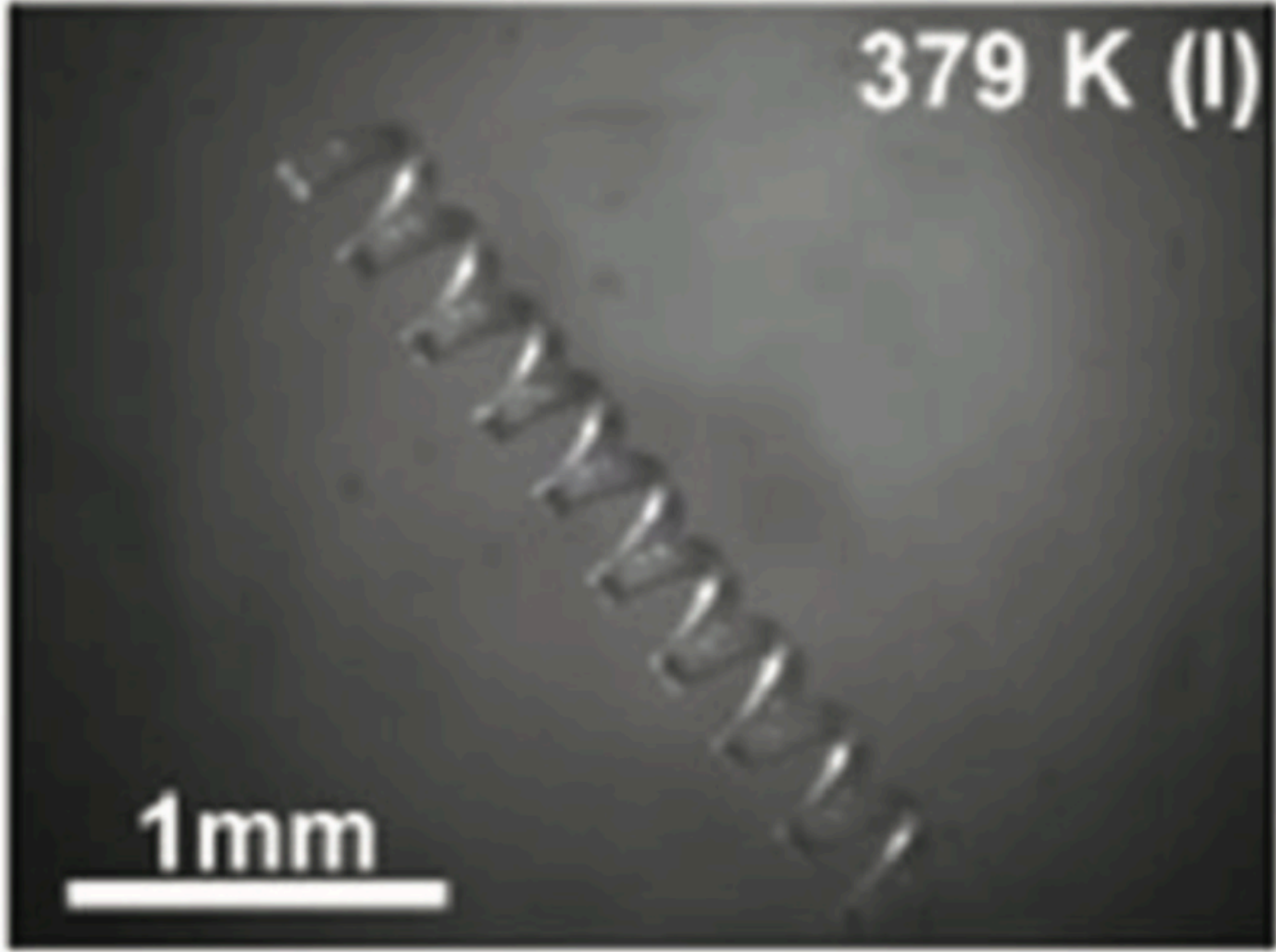

Sawa PRE 2013

Ribbons at all length-scales

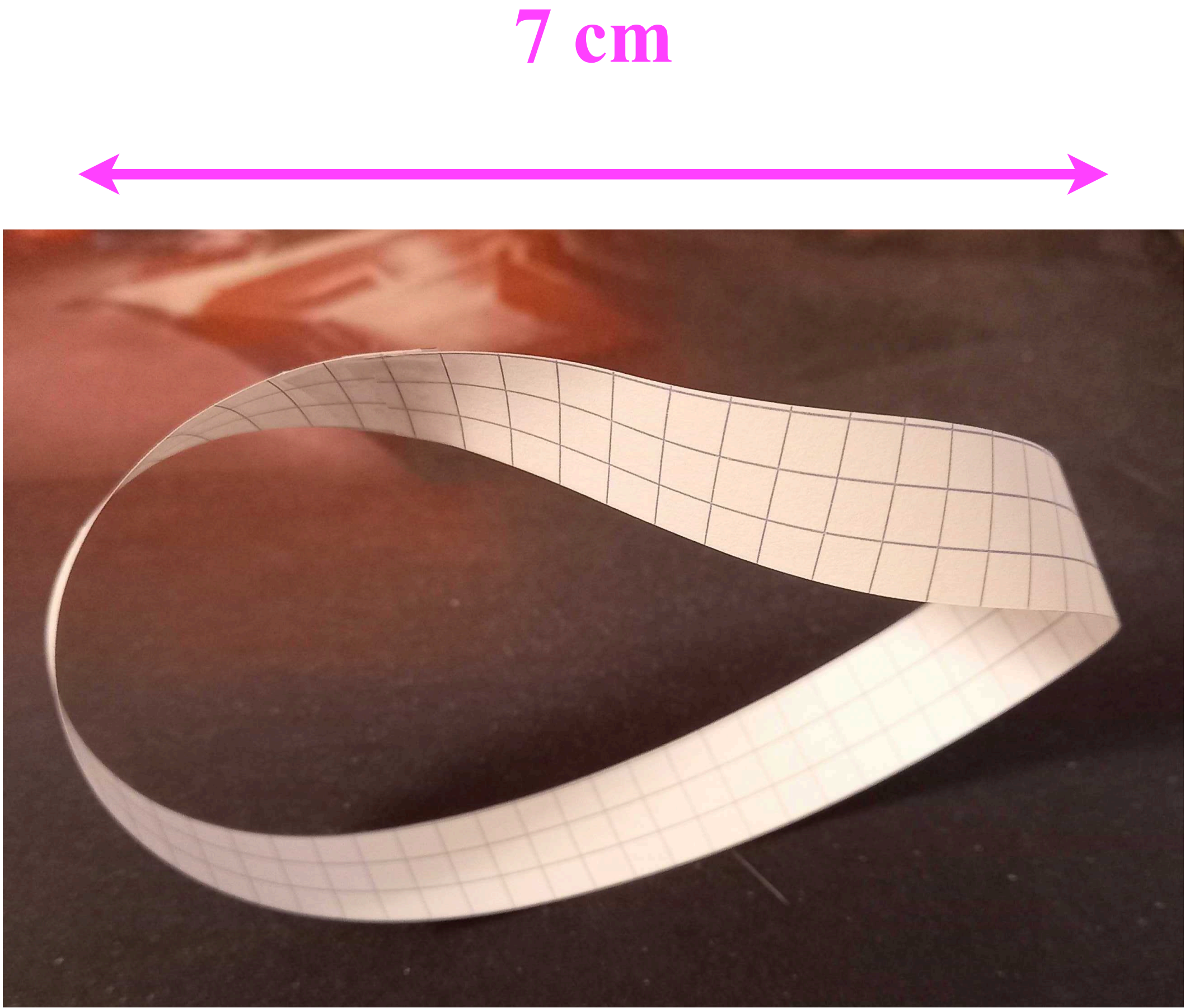

Ribbons at all length-scales

Chebydesic Pavilion

1.5 m

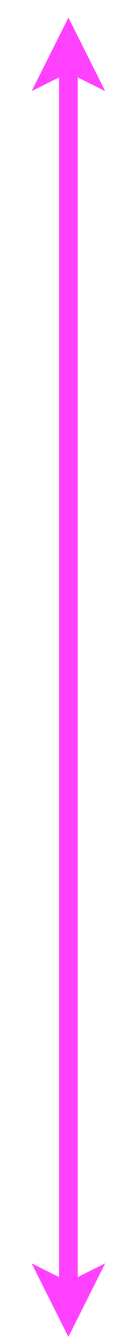

Pr. O Baverel
ENPC, FR
thinkshell.fr

Lateral Torsional Buckling

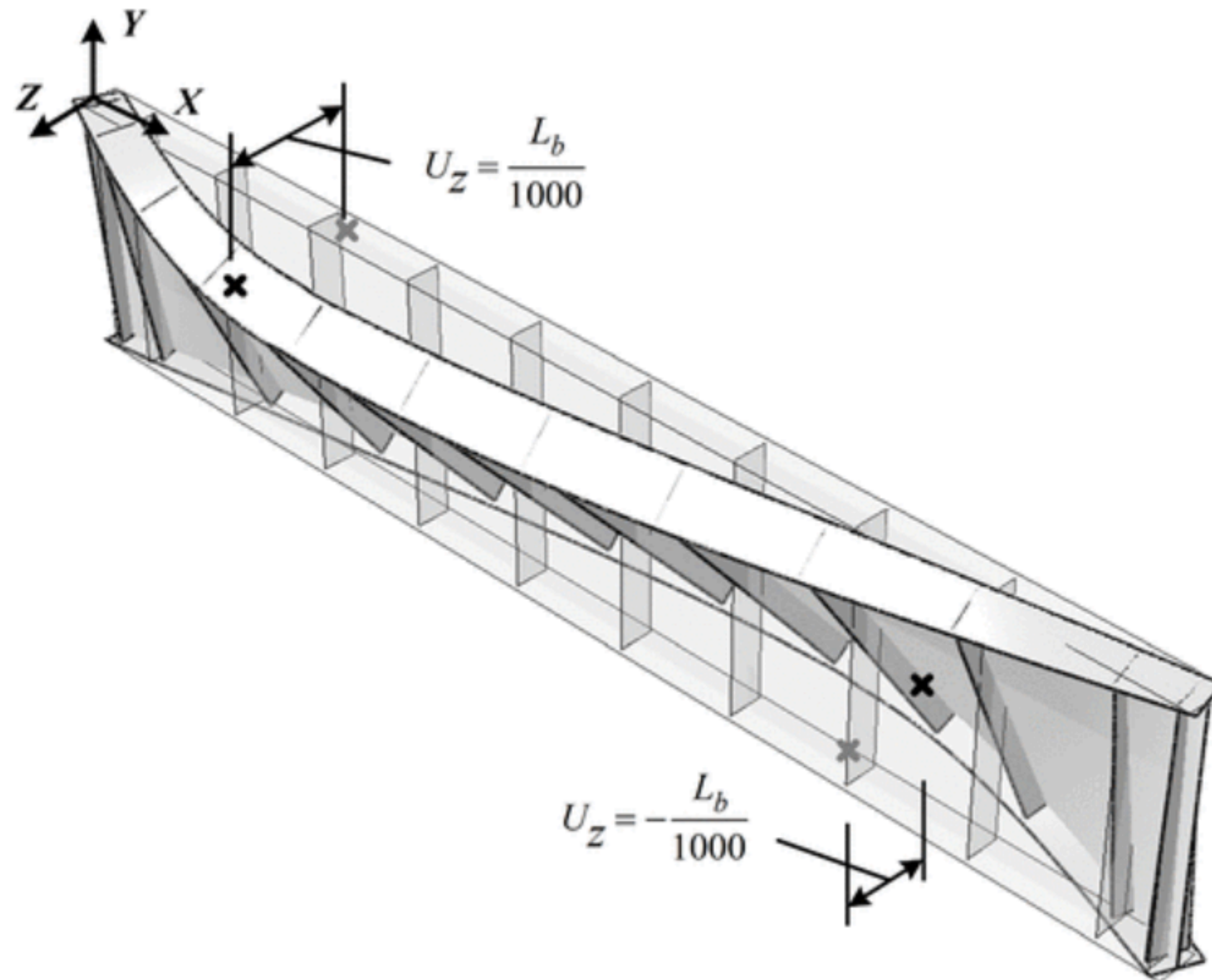

Liang et al, J. Struct. Eng. (2022)

Ribbons at all length-scales

**Edmonton bridge
(Canada)**

total
span
~ 100 m

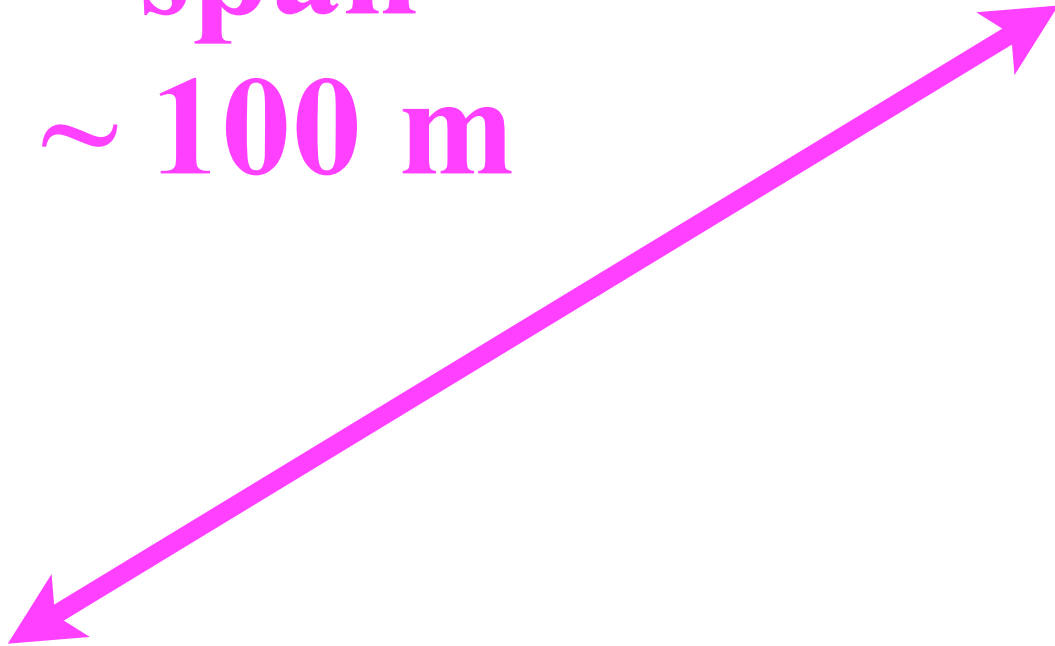

image:
Bruce Edwards
Edmonton Journal



Ribbons at all length-scales

**Edmonton bridge
(Canada)**

3 buckled girders



March 2015

**image:
Bruce Edwards
Edmonton Journal**

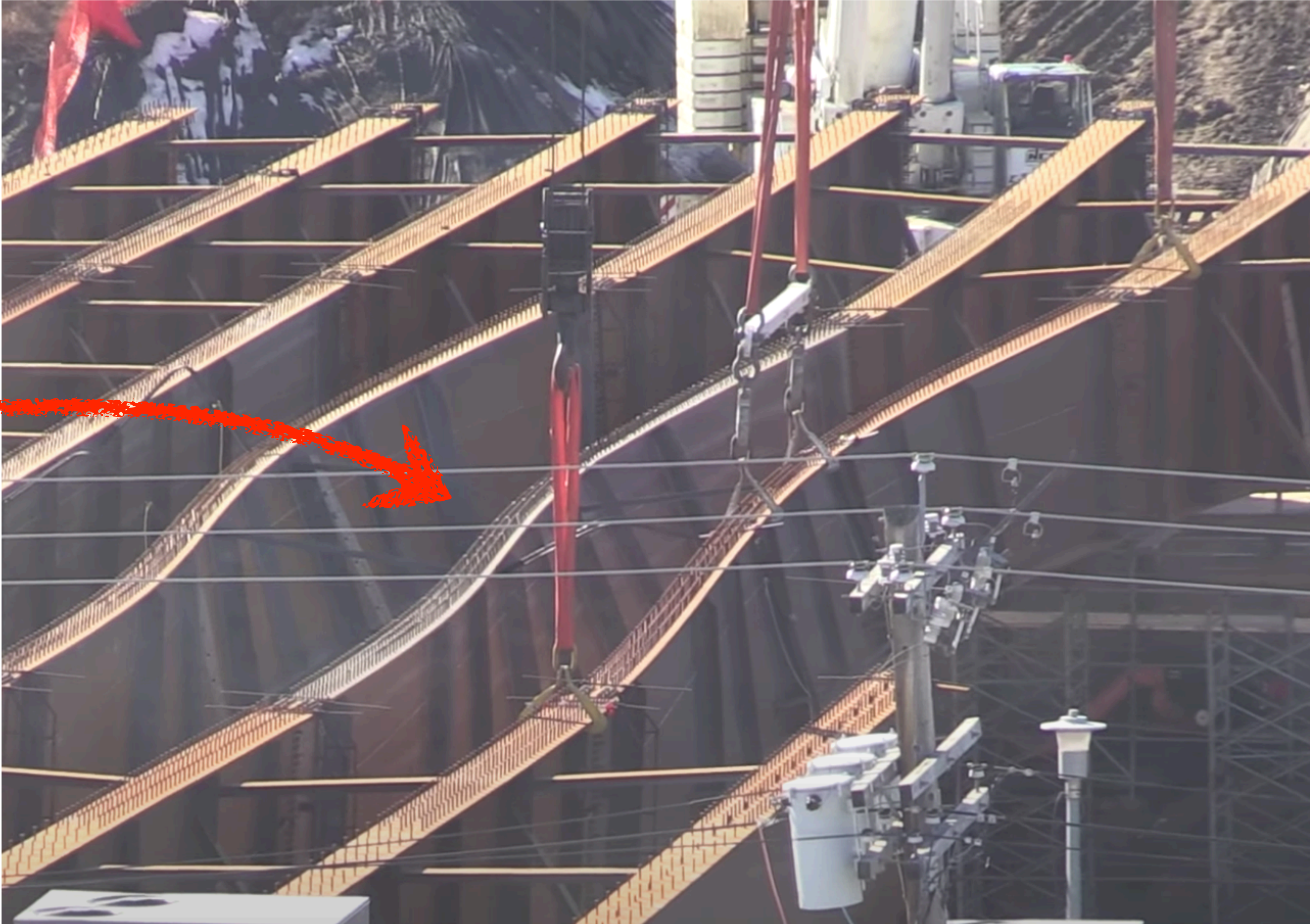

Ribbons at all length-scales

Civil Engineering

V. Z. VLASOV

**THIN-WALLED
ELASTIC
BEAMS**

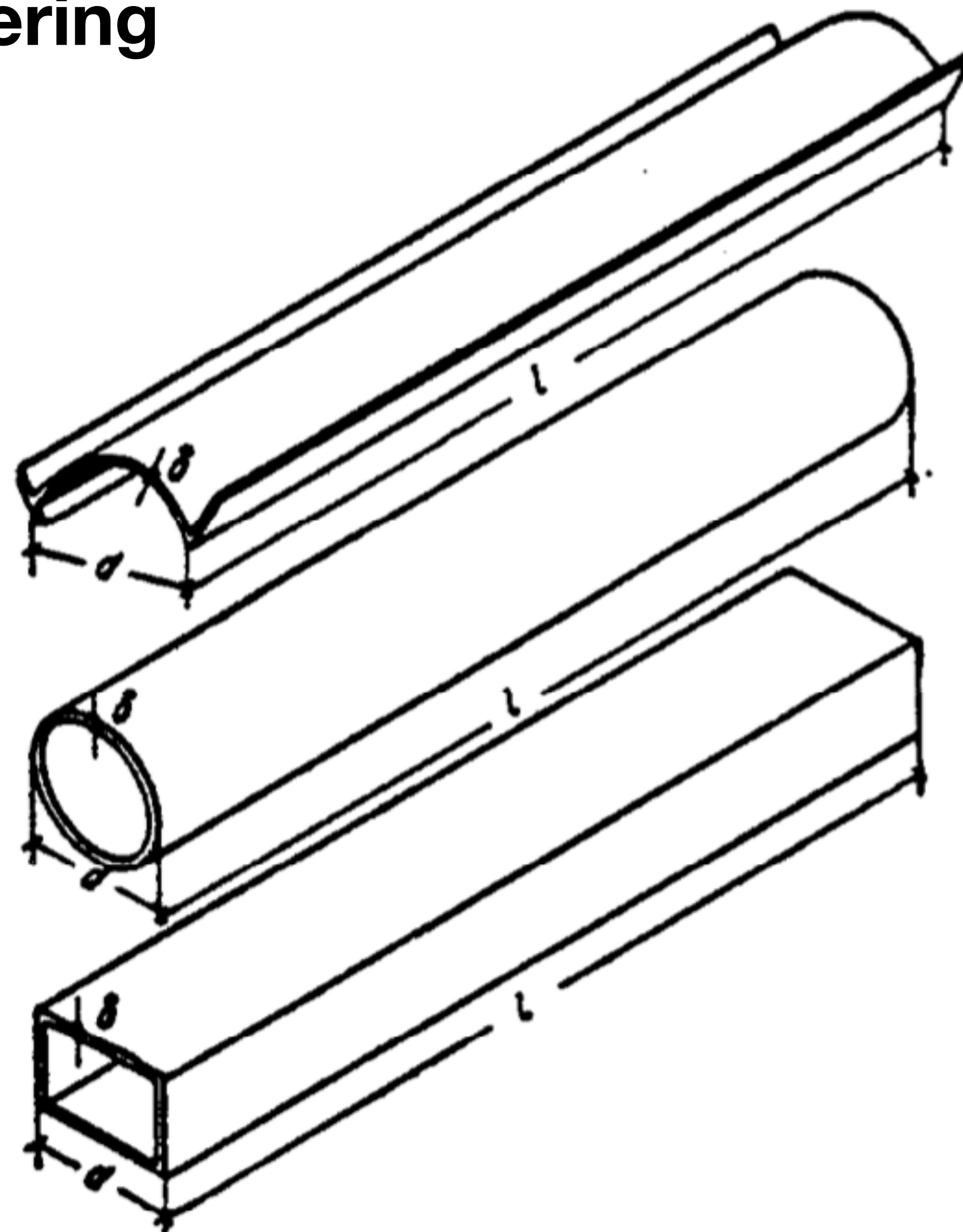

1-Mechanics of a ribbon

2-Numerical implementation

(for statics)

BENDING AND TWIST CONSTITUTIVE RELATIONS

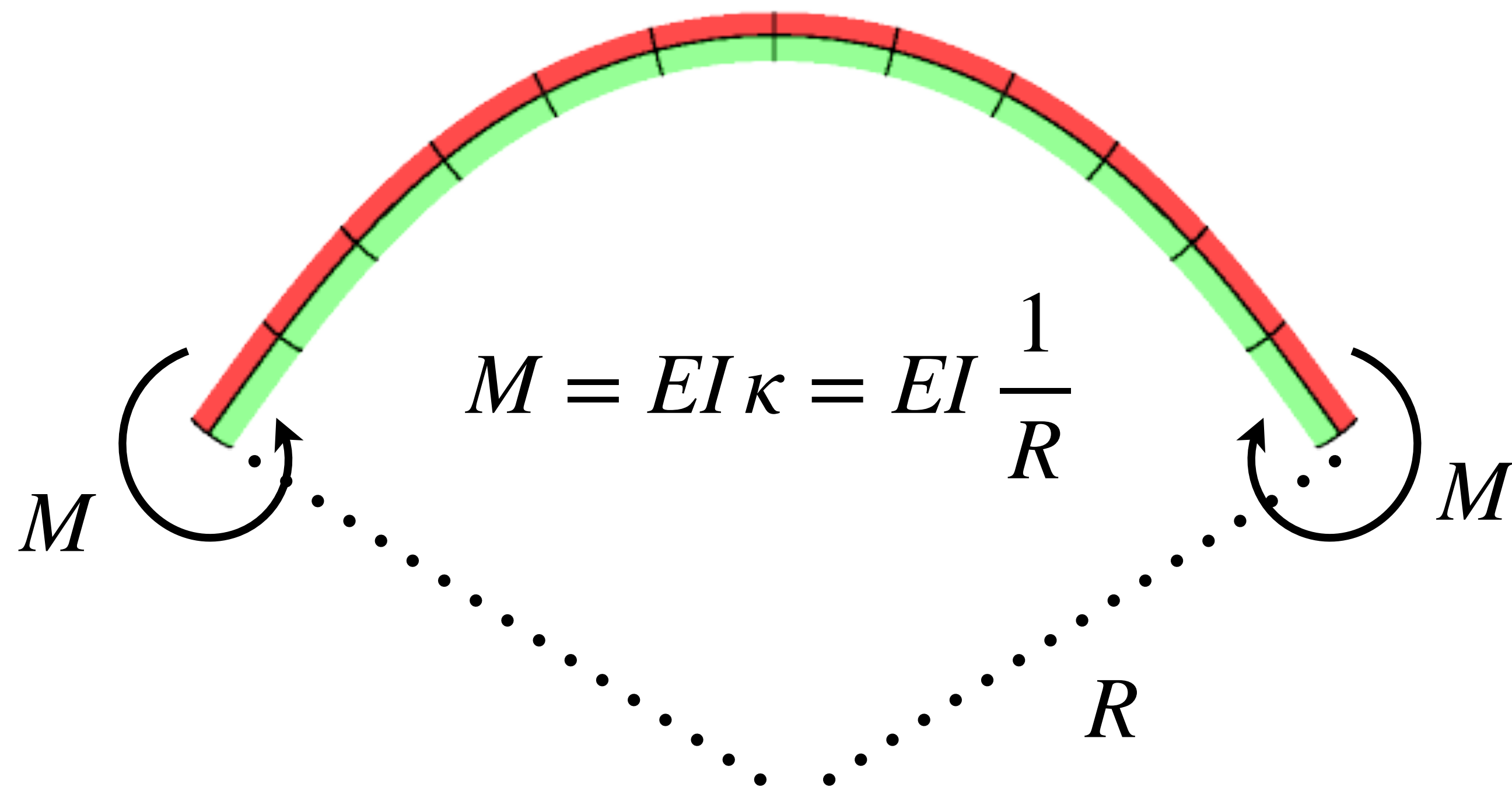

I : moment of inertia
 E : Young's modulus

filament	E
Microtubule	1 GPa
DNA	1 GPa
Actine	2 GPa
<u>Collagen</u>	2 GPa
<u>Rubber</u>	2 GPa
<u>Steel</u>	200 GPa

SQUARE CROSS-SECTION (ROD)

$$G = \frac{1}{2} \frac{E}{1 + \nu}$$

Bending and twist constitutive relations

$$M_1 = E I_1 \kappa_1 \quad I_1 = \frac{1}{12} h^4$$

$$M_2 = E I_2 \kappa_2 \quad I_2 = \frac{1}{12} h^4$$

$$M_3 = G J \kappa_3 \quad J \simeq I_1 + I_2$$

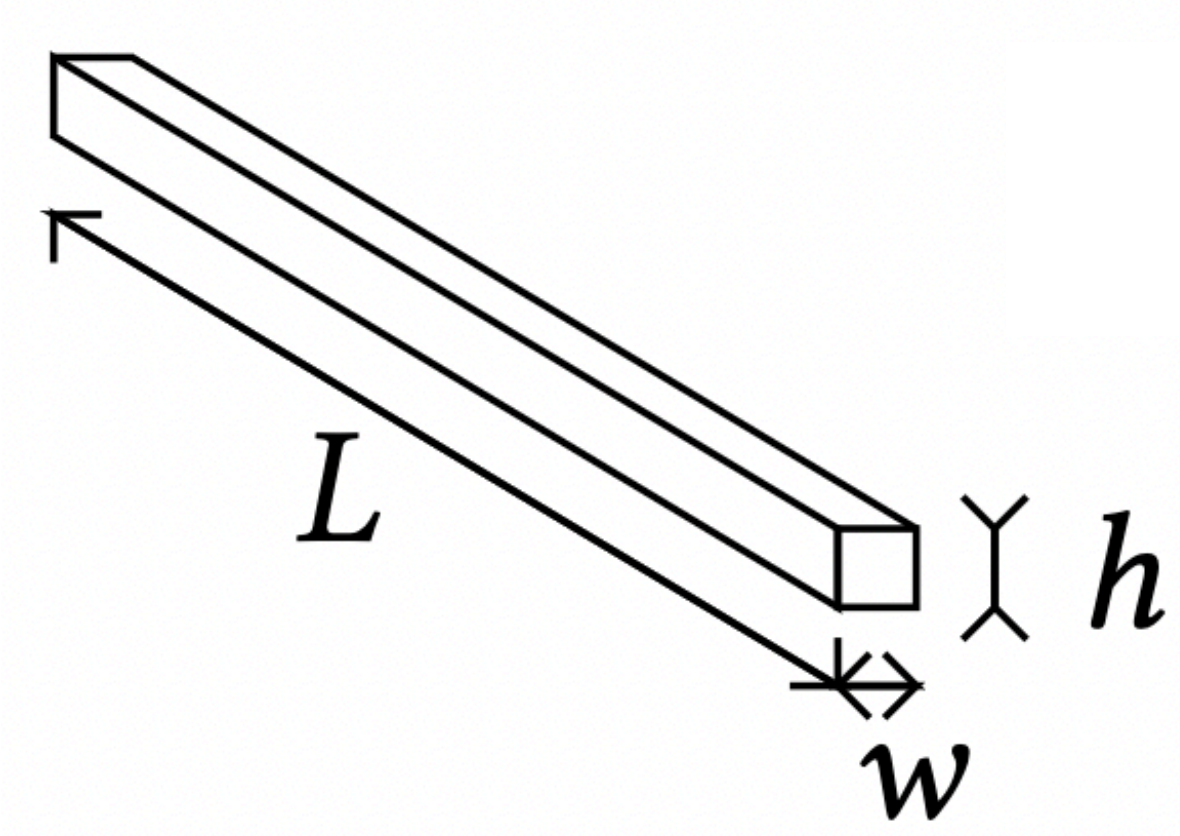

$$w = h$$

RECTANGULAR CROSS-SECTION (ROD)

$$G = \frac{1}{2} \frac{E}{1 + \nu}$$

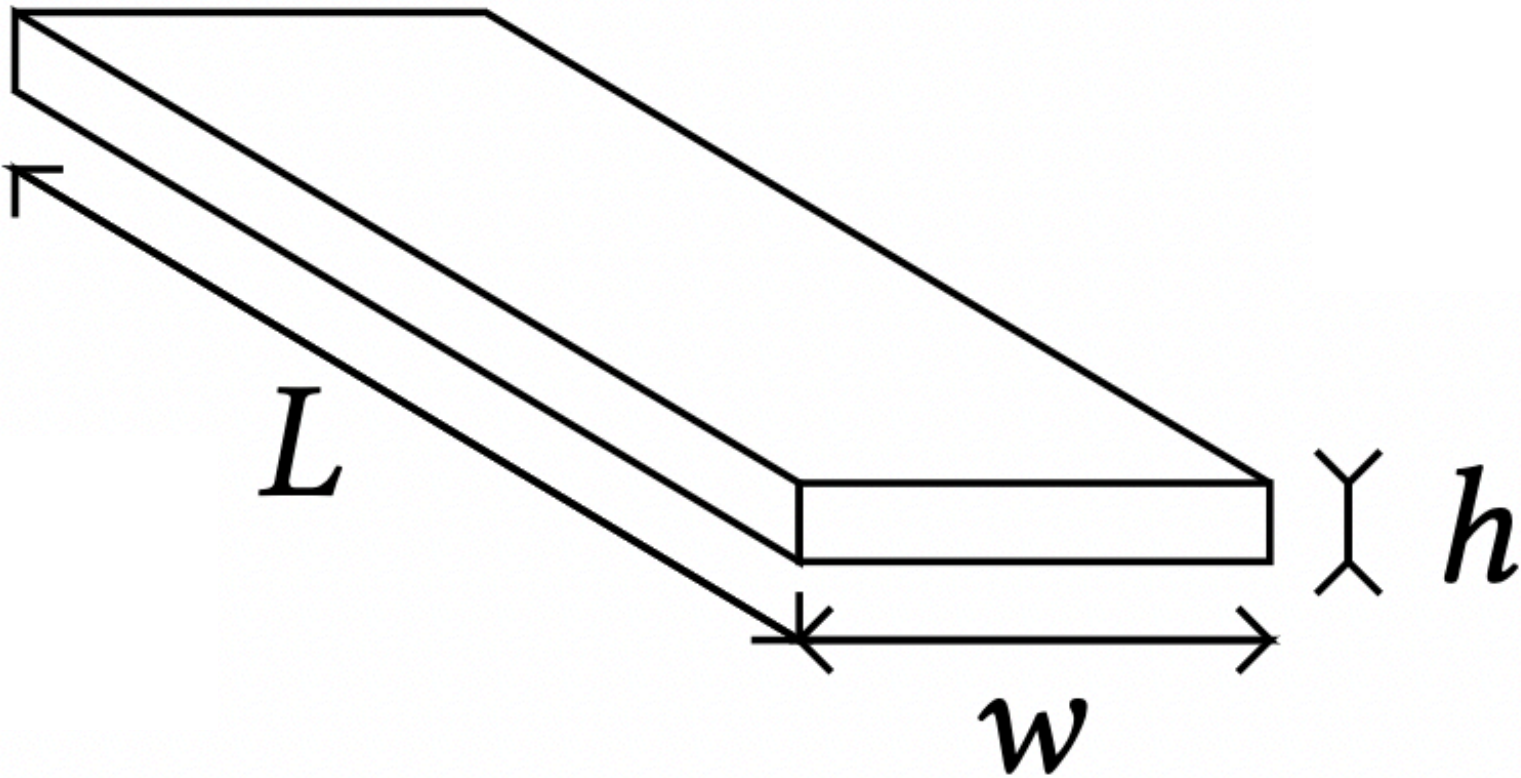

typically $w = 3h$

Bending and twist constitutive relations

$$M_1 = E I_1 \kappa_1 \quad I_1 = \frac{1}{12} h^3 w$$

$$M_2 = E I_2 \kappa_2 \quad I_2 = \frac{1}{12} h w^3 \quad \text{Large}$$

$$M_3 = G J \kappa_3 \quad J = \frac{1}{3} h^3 w \underbrace{\varphi\left(\frac{w}{h}\right)}_{\simeq 1}$$

same magnitude
(x 4)

$$J \neq I_1 + I_2$$

WIDE RECTANGULAR CROSS-SECTION (RIBBON) : THE RIBEXT MODEL

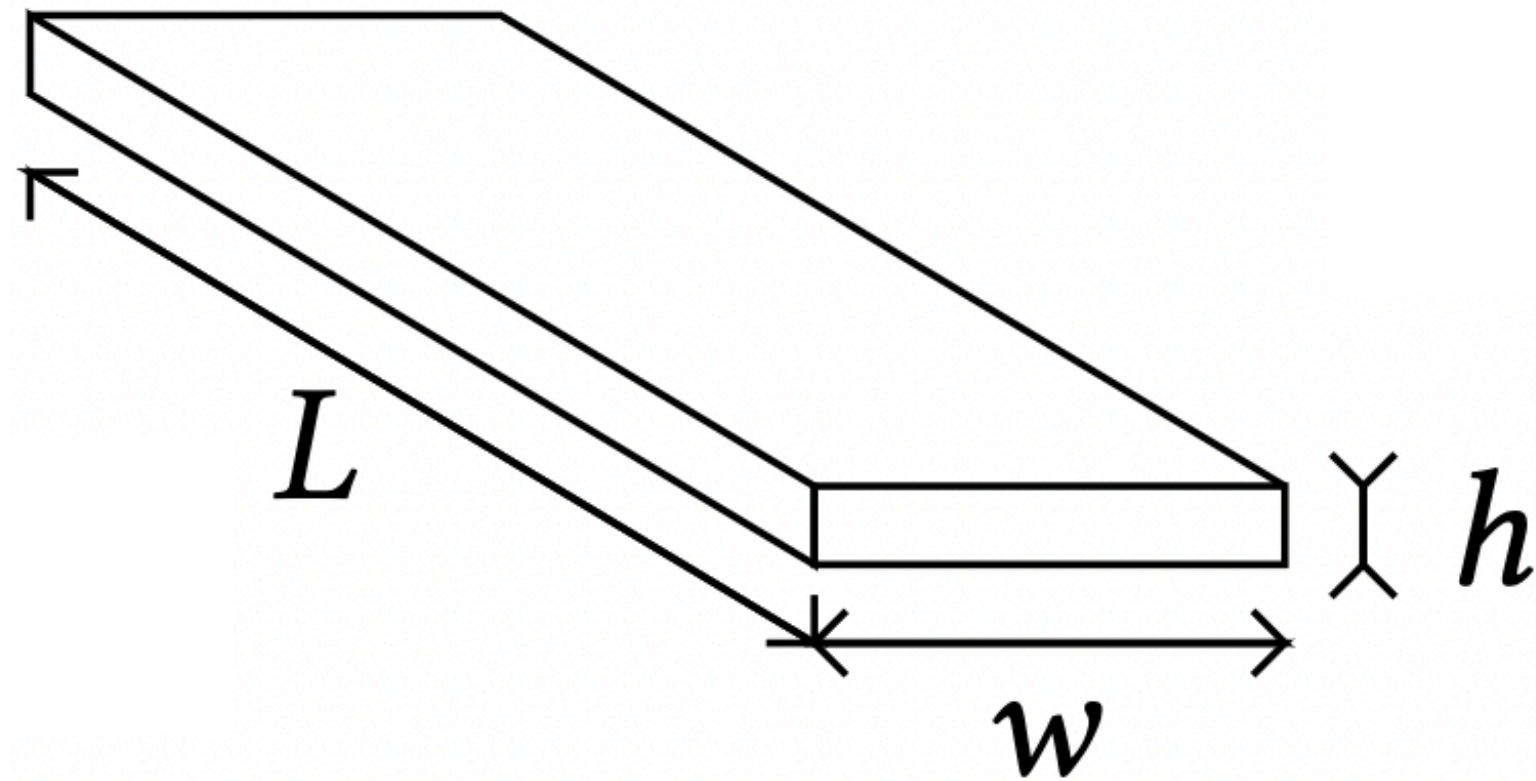

$$w \gg h$$

(typically $w > 10h$)

Bending and twist constitutive relations $\nu = 0$

$$M_1 = EI_1 \kappa_1 \left(1 - \left[\frac{\kappa_3^2}{60 \frac{h^2}{w^4} + \kappa_1^2} \right]^2 \right)$$

$$I_1 = \frac{1}{12} h^3 w$$

$$\kappa_2 = 0$$

$$M_3 = 2EI_1 \kappa_3 \left(1 + \frac{\kappa_3^2}{60 \frac{h^2}{w^4} + \kappa_1^2} \right)$$

Sano Wada PRL 2019
Audoly Neukirch JMPS 2021

Rod behaviour if $\kappa_1^2 \ll 60 \frac{h^2}{w^4}$

Kirchhoff

Ribbon behaviour if $\kappa_1^2 \gg 60 \frac{h^2}{w^4}$

Sadowsky

WIDE RECTANGULAR CROSS-SECTION (RIBBON) : THE RIBEXT MODEL

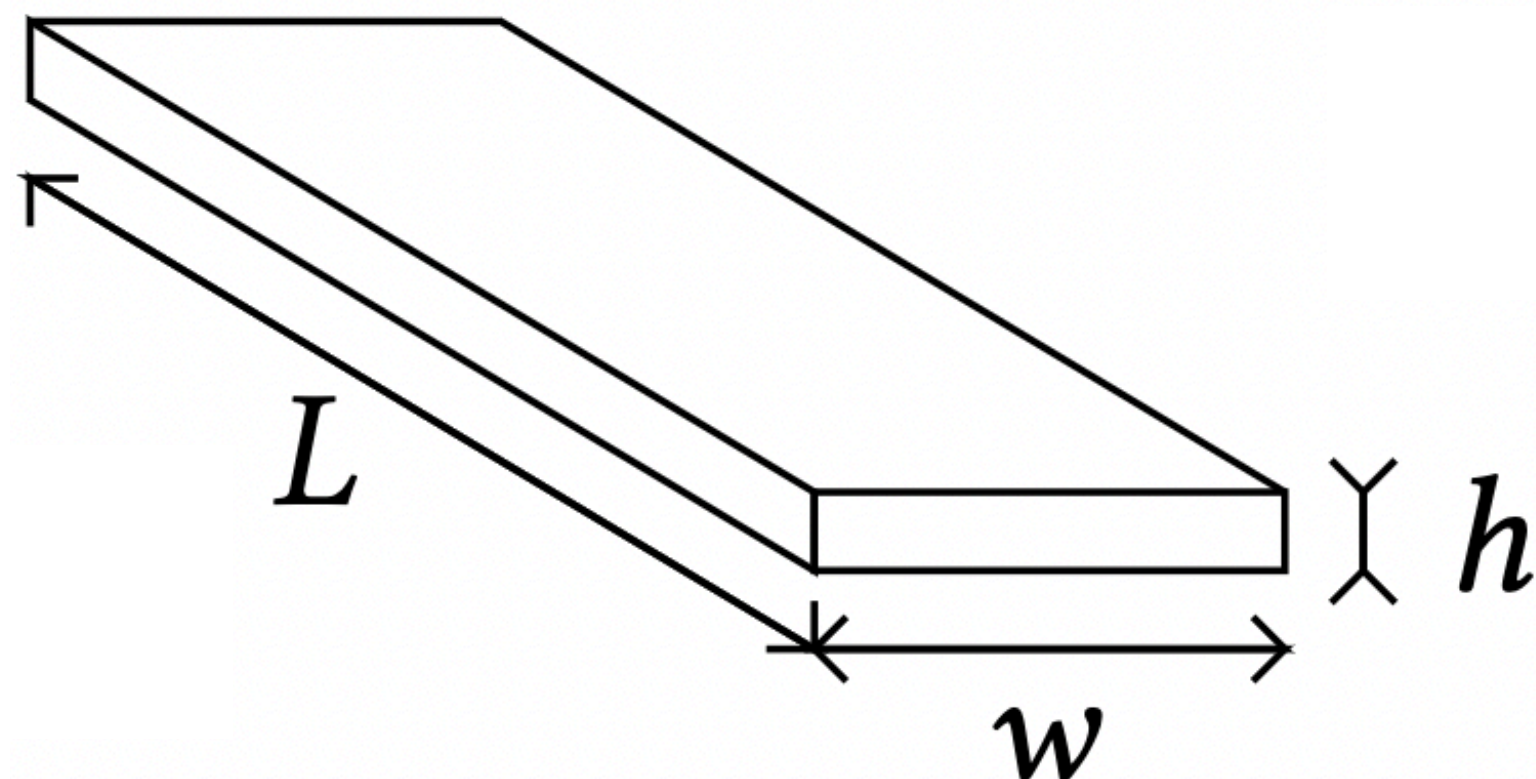

Bending and twist constitutive relations $\nu = 0$

$$\left\{ \begin{aligned} M_1 &= E I_1 \kappa_1 \left(1 - \left[\frac{\kappa_3^2}{60 \frac{h^2}{w^4}} \right]^2 \right) \\ M_3 &= 2E I_1 \kappa_3 \left(1 + \frac{\kappa_3^2}{60 \frac{h^2}{w^4}} \right) \end{aligned} \right.$$

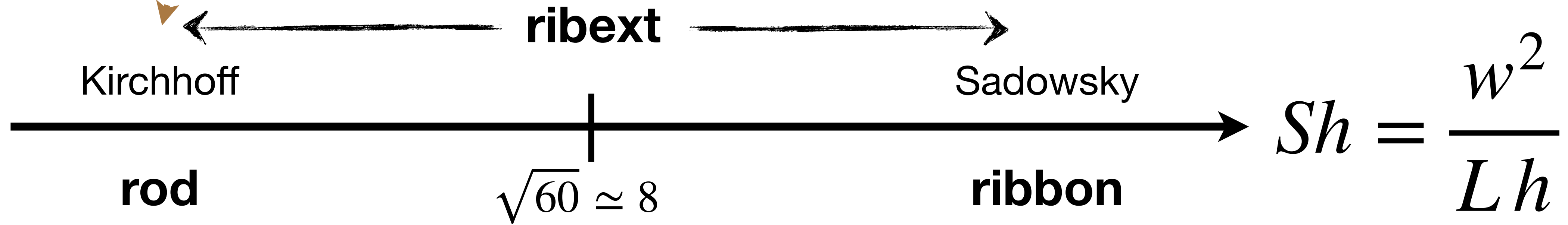
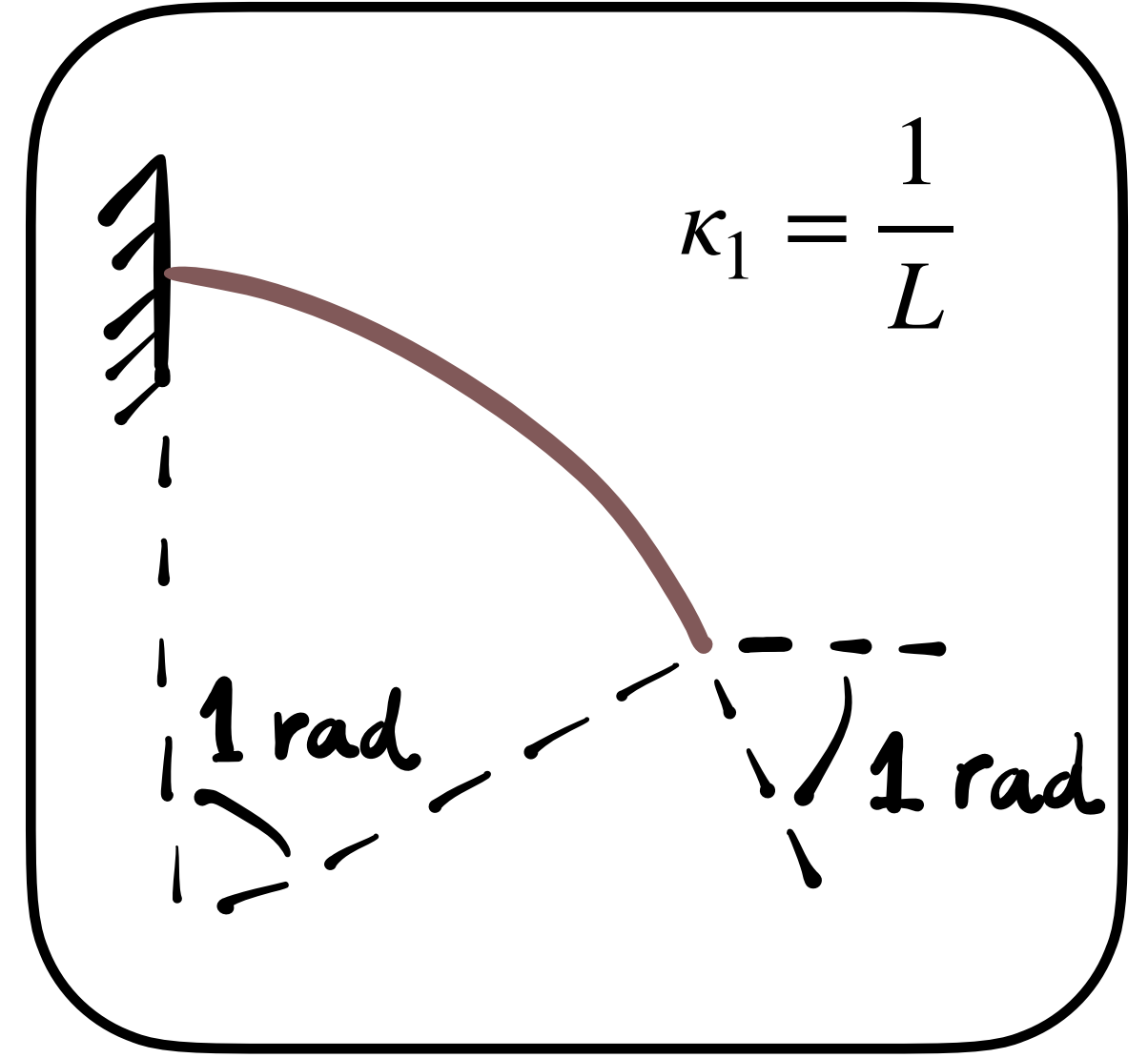

small

WIDE RECTANGULAR CROSS-SECTION (RIBBON) : THE RIBEXT MODEL

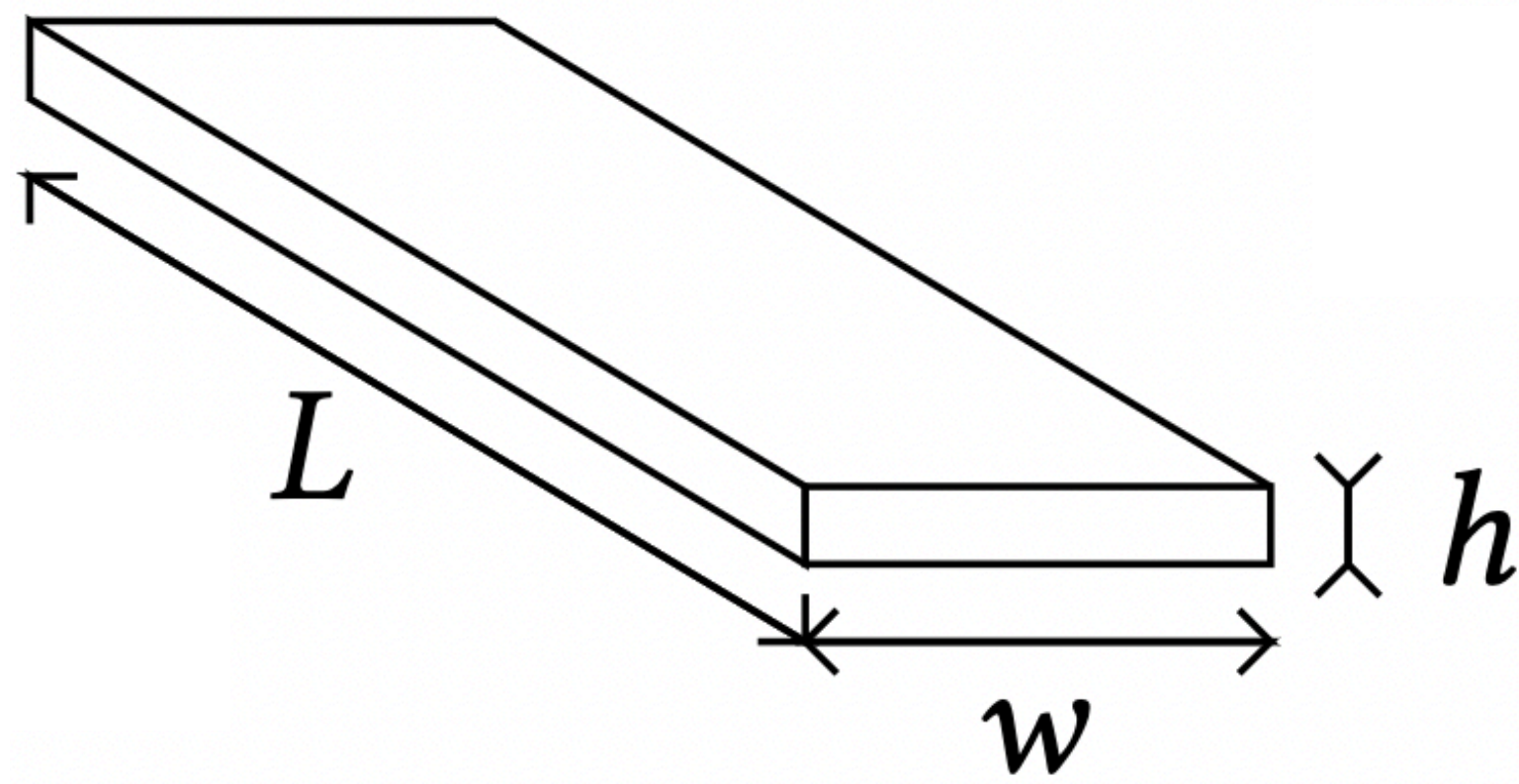

Bending and twist constitutive relations $\nu = 0$

$$\left\{ \begin{aligned} M_1 &= E I_1 \kappa_1 \left(1 - \left[\frac{\kappa_3^2}{\kappa_1^2} \right]^2 \right) \\ M_3 &= 2E I_1 \kappa_3 \left(1 + \frac{\kappa_3^2}{\kappa_1^2} \right) \end{aligned} \right.$$

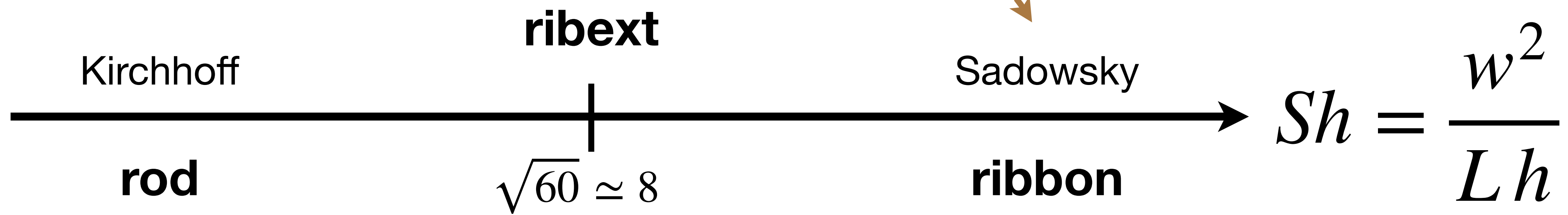
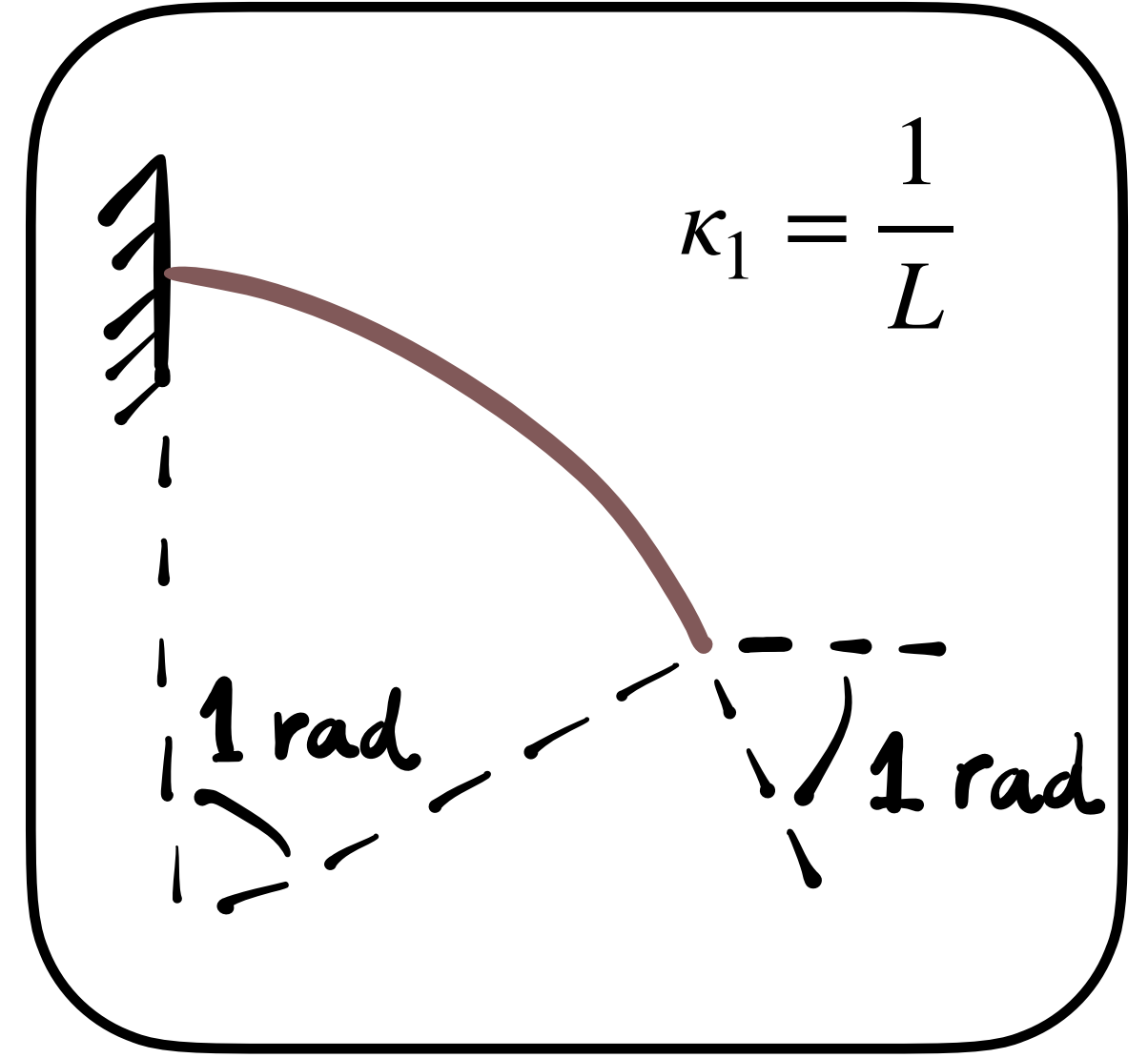

Kirchhoff equations for elastic rods

kinematics

$$x' = d_{3x}$$

$$y' = d_{3y}$$

$$z' = d_{3z}$$

$$d'_{3x} = u_2 d_{1x} - u_1 d_{2x}$$

$$d'_{3y} = u_2 d_{1y} - u_1 d_{2y}$$

$$d'_{3z} = u_2 d_{1z} - u_1 d_{2z}$$

$$d'_{1x} = u_3 d_{2x} - u_2 d_{3x}$$

$$d'_{1y} = u_3 d_{2y} - u_2 d_{3y}$$

$$d'_{1z} = u_3 d_{2z} - u_2 d_{3z}$$

$$d'_{2x} = u_1 d_{3x} - u_3 d_{1x}$$

$$d'_{2y} = u_1 d_{3y} - u_3 d_{1y}$$

$$d'_{2z} = u_1 d_{3z} - u_3 d_{1z}$$

$$n'_1 = n_2 u_3 - n_3 u_2 - f_1 + \rho A (\ddot{x} d_{1x} + \ddot{y} d_{1y} + \ddot{z} d_{1z})$$

$$n'_2 = n_3 u_1 - n_1 u_3 - f_2 + \rho A (\ddot{x} d_{2x} + \ddot{y} d_{2y} + \ddot{z} d_{2z})$$

$$n'_3 = n_1 u_2 - n_2 u_1 - f_3 + \rho A (\ddot{x} d_{3x} + \ddot{y} d_{3y} + \ddot{z} d_{3z})$$

$$m'_1 = m_2 u_3 - m_3 u_2 + n_2$$

$$m'_2 = m_3 u_1 - m_1 u_3 - n_1$$

$$m'_3 = m_1 u_2 - m_2 u_1$$

dynamics

$$m_1 = K_1 u_1, \quad m_2 = K_2 u_2, \quad m_3 = K_3 u_3$$

constitutive relations

21 non linear PDE (arclength & time)

equilibrium & stability

BVP (collocation)

numerical path following

Darboux

Equations for elastic strips

kinematics

$$x' = d_{3x}$$

$$y' = d_{3y}$$

$$z' = d_{3z}$$

$$d'_{3x} = u_2 d_{1x} - u_1 d_{2x}$$

$$d'_{3y} = u_2 d_{1y} - u_1 d_{2y}$$

$$d'_{3z} = u_2 d_{1z} - u_1 d_{2z}$$

$$d'_{1x} = u_3 d_{2x} - u_2 d_{3x}$$

$$d'_{1y} = u_3 d_{2y} - u_2 d_{3y}$$

$$d'_{1z} = u_3 d_{2z} - u_2 d_{3z}$$

$$d'_{2x} = u_1 d_{3x} - u_3 d_{1x}$$

$$d'_{2y} = u_1 d_{3y} - u_3 d_{1y}$$

$$d'_{2z} = u_1 d_{3z} - u_3 d_{1z}$$

$$n'_1 = n_2 u_3 - n_3 u_2 - f_1 + \rho A (\ddot{x} d_{1x} + \ddot{y} d_{1y} + \ddot{z} d_{1z})$$

$$n'_2 = n_3 u_1 - n_1 u_3 - f_2 + \rho A (\ddot{x} d_{2x} + \ddot{y} d_{2y} + \ddot{z} d_{2z})$$

$$n'_3 = n_1 u_2 - n_2 u_1 - f_3 + \rho A (\ddot{x} d_{3x} + \ddot{y} d_{3y} + \ddot{z} d_{3z})$$

$$m'_1 = m_2 u_3 - m_3 u_2 + n_2$$

$$m'_2 = m_3 u_1 - m_1 u_3 - n_1$$

$$m'_3 = m_1 u_2 - m_2 u_1$$

dynamics

$$m_1 = K \left(1 - \frac{u_3^4}{u_1^4} \right) u_1$$

$$u_2 = 0$$

$$m_3 = 2K \left(1 + \frac{u_3^2}{u_1^2} \right) u_3$$

nonlinear
constitutive
relations

Darboux

THE PUSH AND TWIST EXPERIMENT

Wunderlich ribbon

Kirchhoff rod

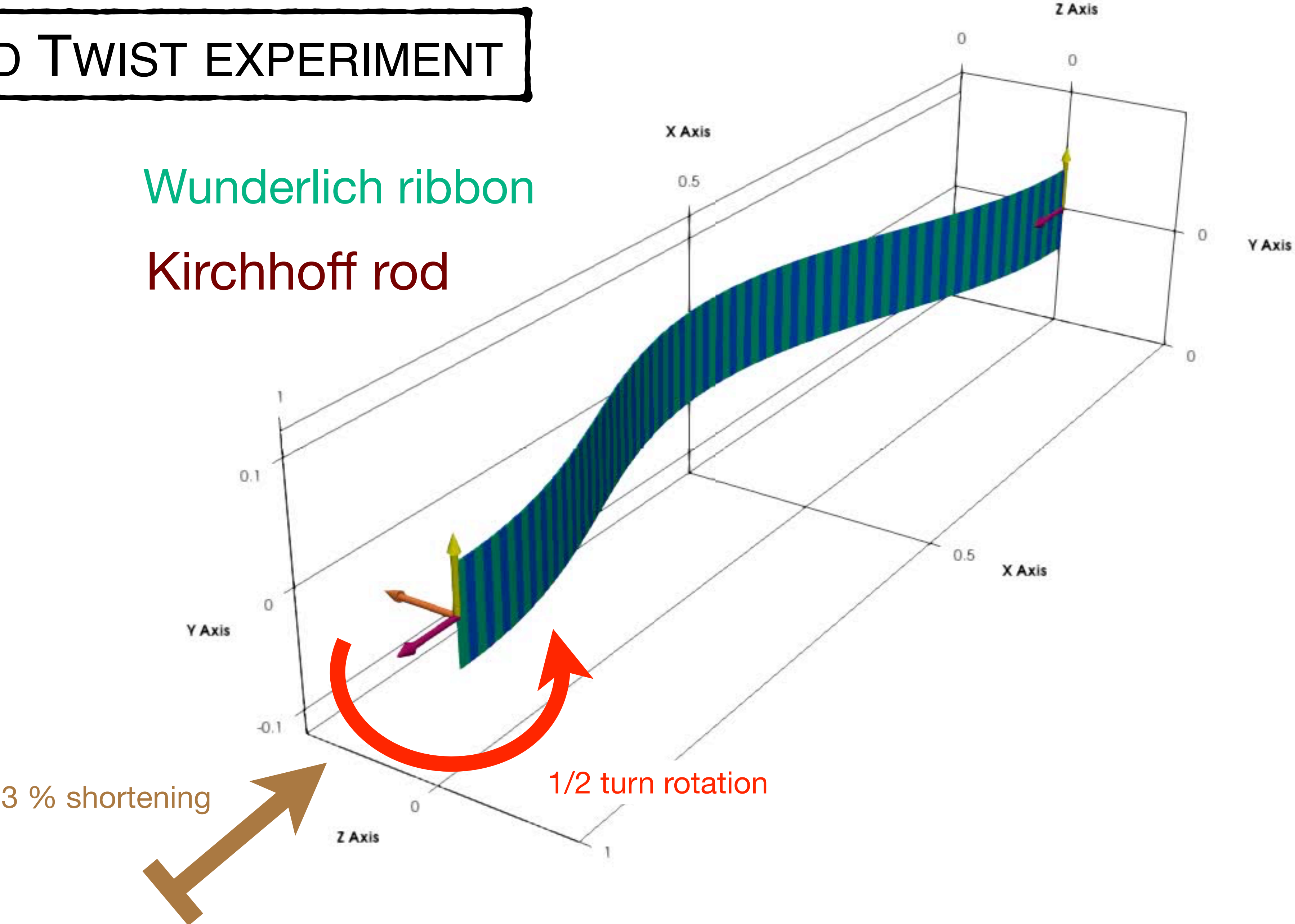

THE PUSH AND TWIST EXPERIMENT

Wunderlich ribbon

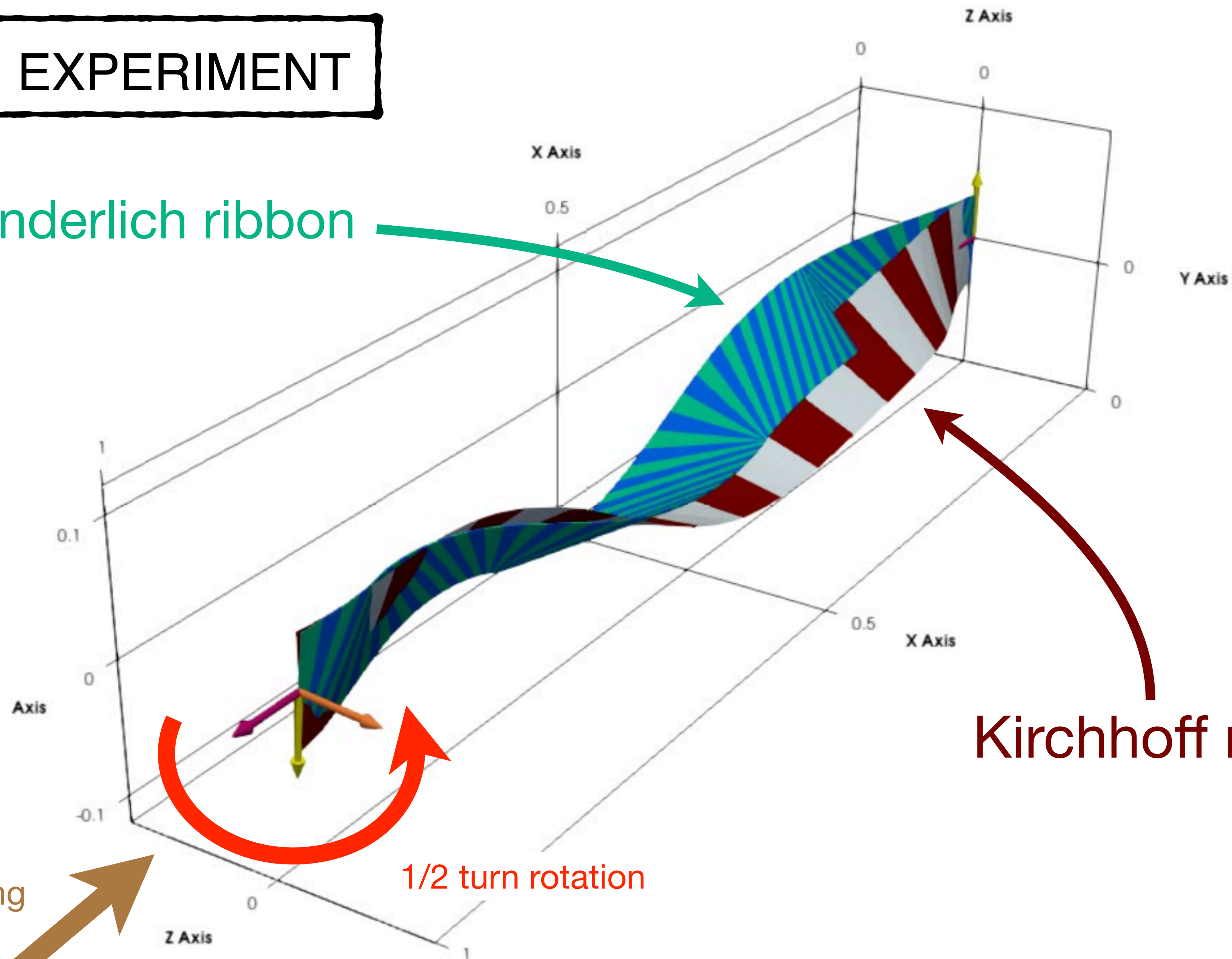

Kirchhoff rod

3 % shortening

1/2 turn rotation

1-Mechanics of a ribbon

2-Numerical implementation

(for statics)

ENERGY APPROACH

$$V = \int_0^L F(\kappa_1, \kappa_3) ds + \int_0^L \rho h w g x(s) ds$$

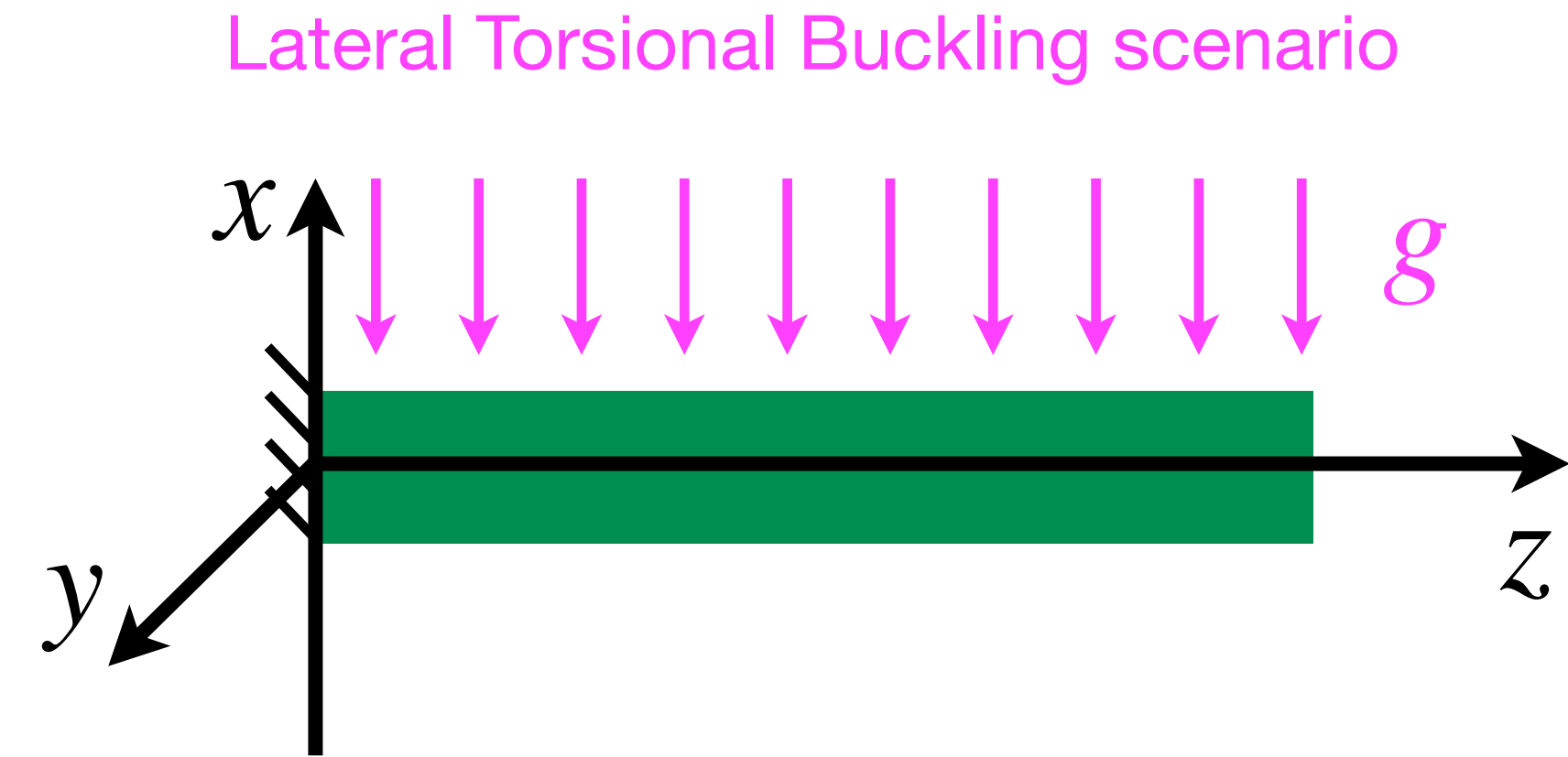

Rod	$F(\kappa_1, \kappa_3) = \frac{1}{2} EI_1 \kappa_1^2 + \frac{1}{2} (2EI_1) \kappa_3^2$	Kirchhoff
Ribbon	$F(\kappa_1, \kappa_3) = \frac{1}{2} EI_1 \kappa_1^2 + \frac{1}{2} (2EI_1) \kappa_3^2 + \frac{1}{2} EI_1 \frac{\kappa_3^4}{60 \frac{h^2}{w^4} + \kappa_1^2}$	RibExt (formula with $\nu = 0$)
Ribbon	$F(\kappa_1, \kappa_3) = \frac{1}{2} EI_1 \kappa_1^2 + \frac{1}{2} (2EI_1) \kappa_3^2 + \frac{1}{2} EI_1 \frac{\kappa_3^4}{\kappa_1^2}$	Sadowsky (limit) (formula with $\nu = 0$)

ENERGY APPROACH: SUPER-HELICES CODE

$$V = \int_0^L F(\kappa_1, \kappa_3) ds + \int_0^L \rho h w g x(s) ds$$

High-order elements : uniform curvatures κ_1 and κ_3

Integration of *Darboux system*:

$$\mathbf{r}'(s) = \mathbf{d}_3 \text{ and } \begin{cases} \mathbf{d}'_1(s) = \kappa_3 \mathbf{d}_2 \\ \mathbf{d}'_2(s) = \kappa_1 \mathbf{d}_3 - \kappa_3 \mathbf{d}_1 \\ \mathbf{d}'_3(s) = -\kappa_1 \mathbf{d}_2 \end{cases}$$

$$V = V(\kappa_1^{(i)}, \kappa_3^{(i)}) \text{ with } i \in (1, 2, \dots, N)$$

min V using IP-OPT

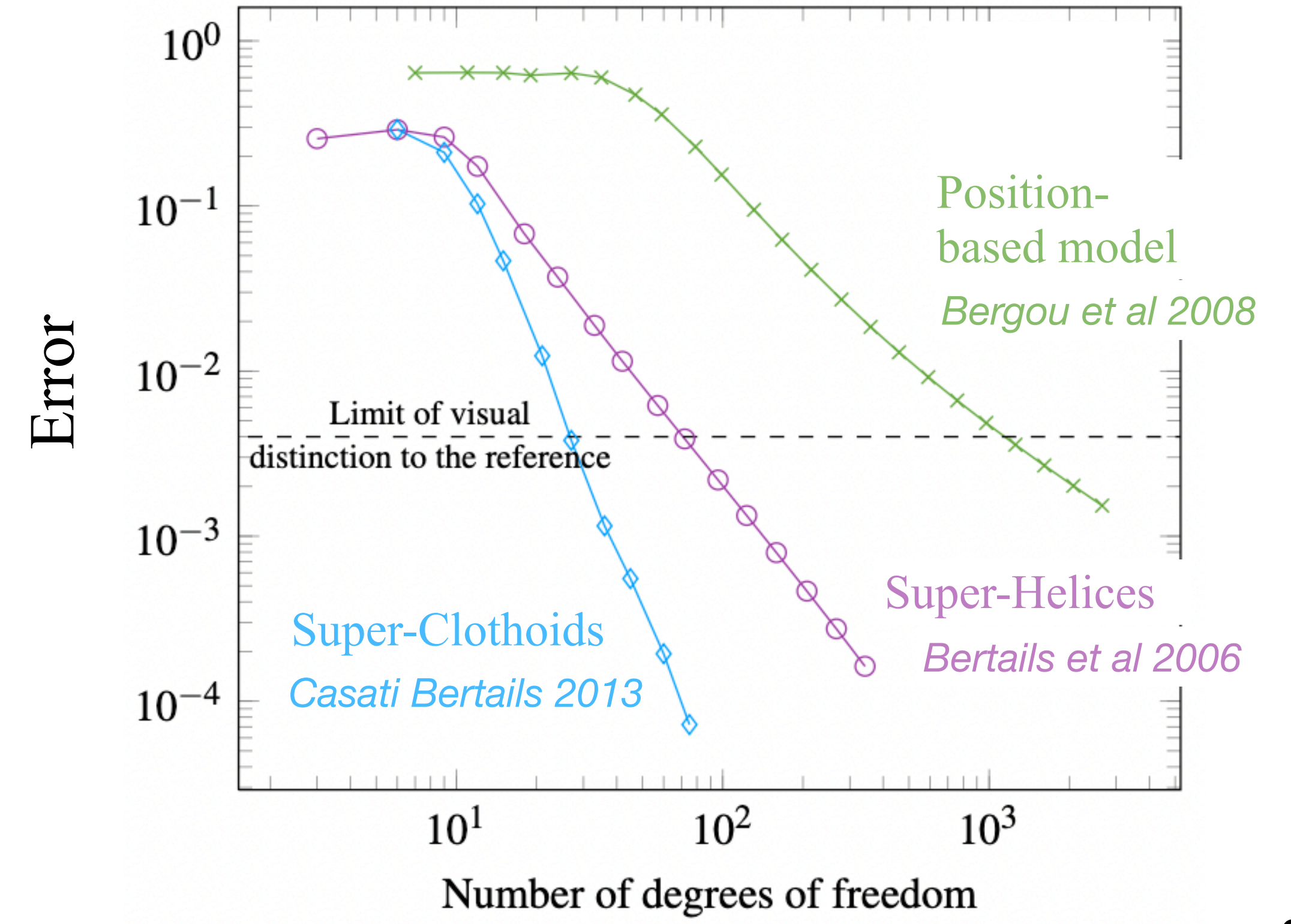
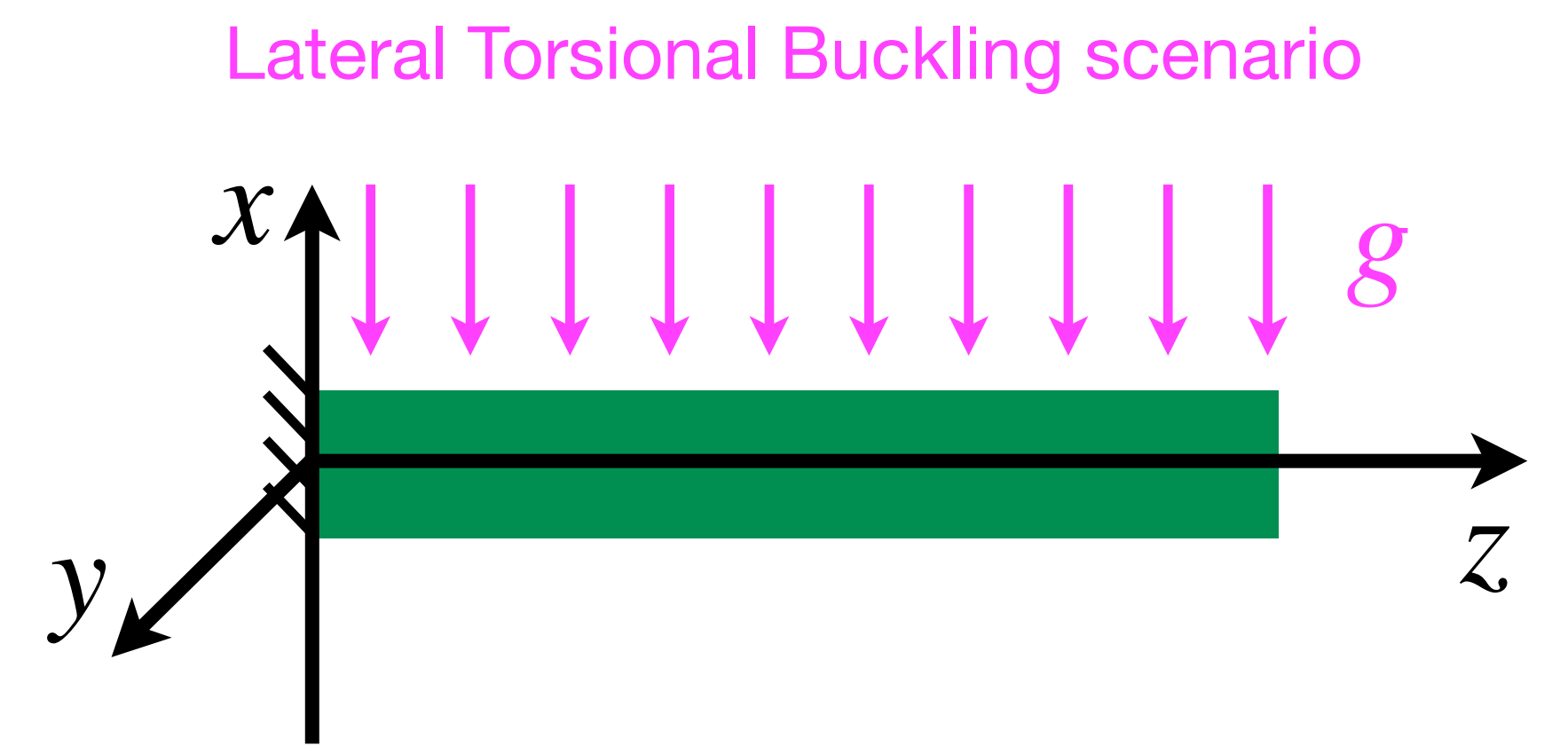

SUPER HELICES ==> SUPER CLOTHOIDS

$$V = \int_0^L F(\kappa_1, \kappa_3) ds + \int_0^L \rho h w g x(s) ds$$

Super Helices: uniform curvatures κ_1 and κ_3

$$\text{Super Clothoids: } \begin{cases} \kappa_1(s) = as + b \\ \kappa_3(s) = cs + d \end{cases}$$

Casati Bertails SIGGRAPH 2013

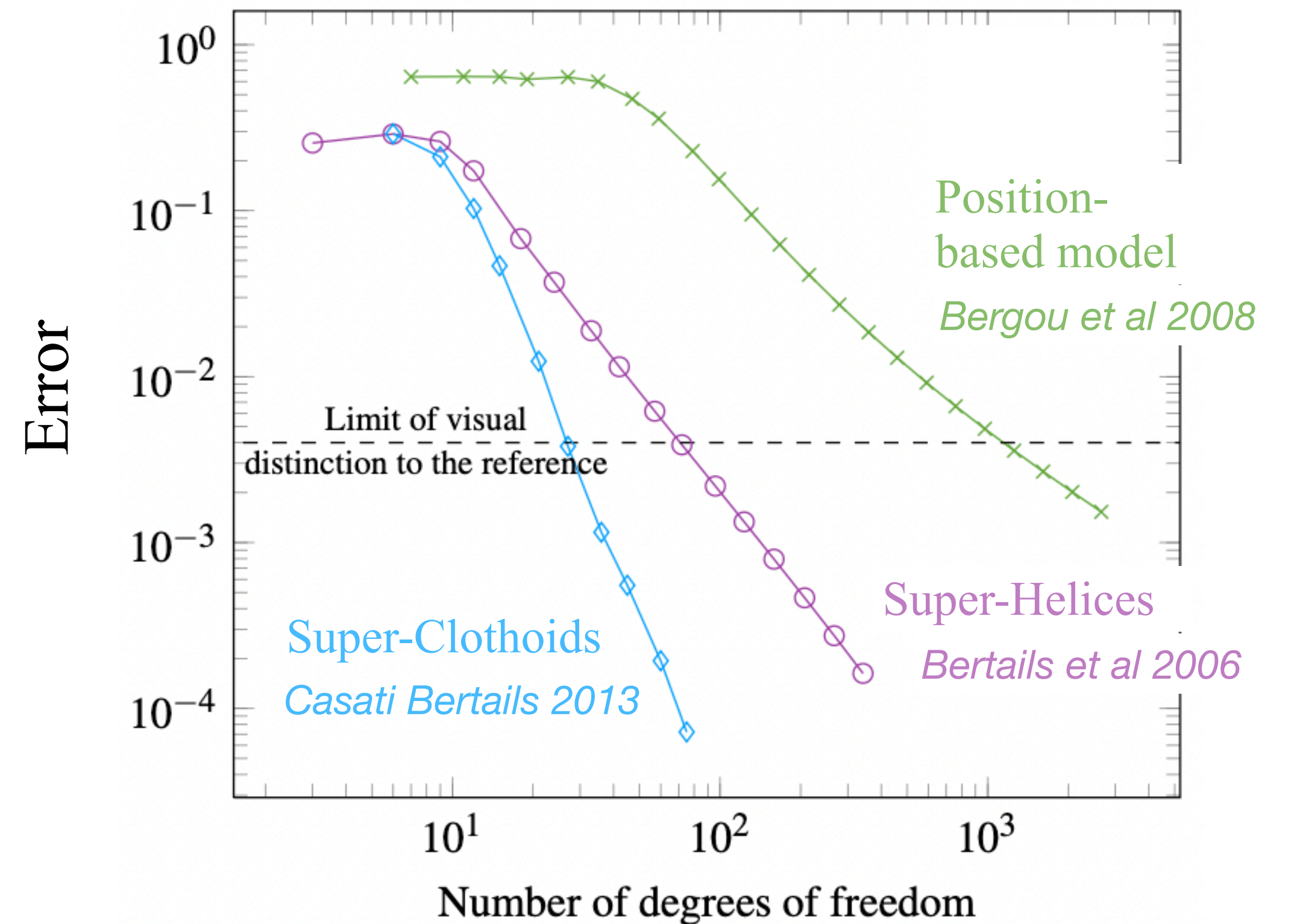
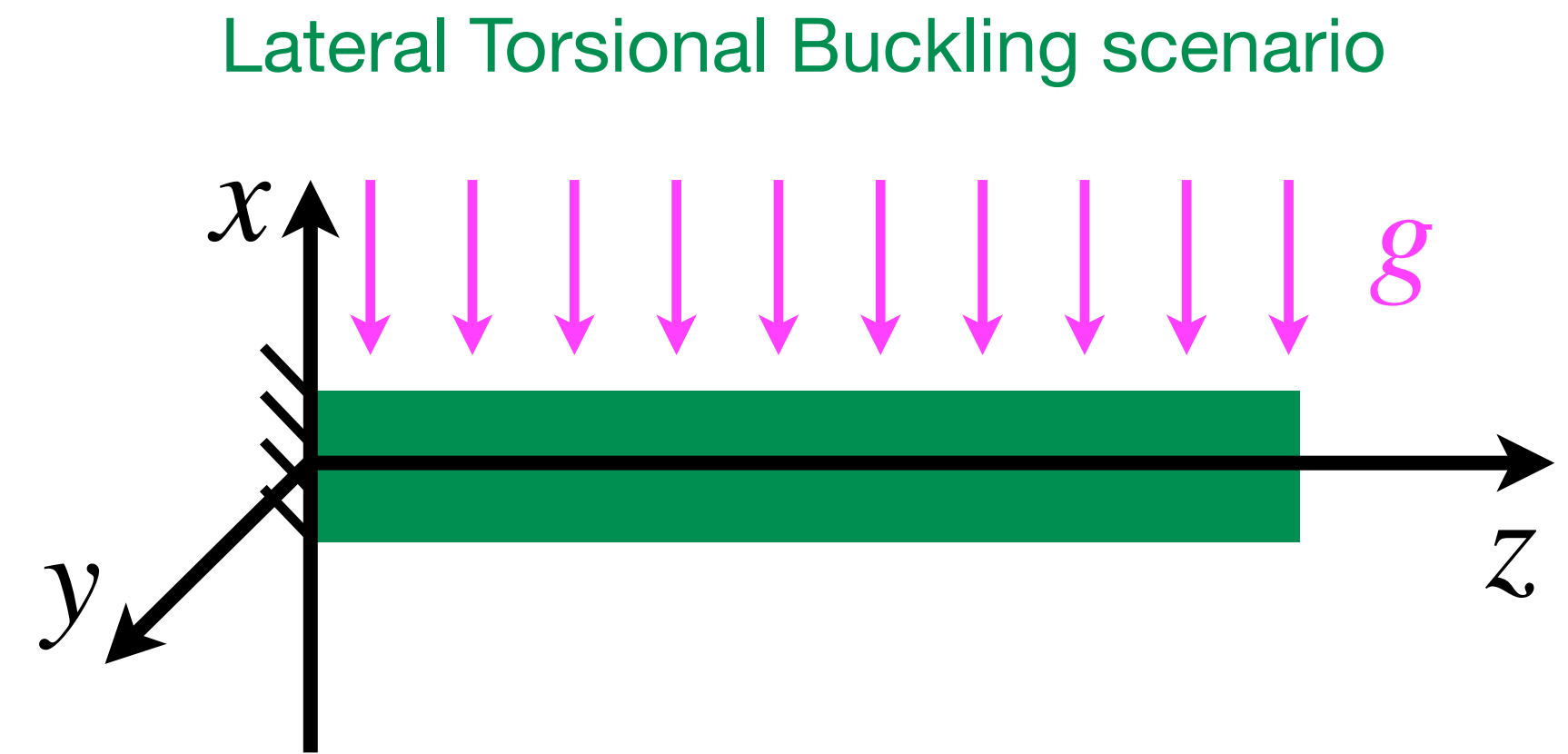

CHAINED SUPER HELICES

Bertails et al SIGGRAPH 2006

$$V[\kappa_{1,3}^{(i)}] = \int_0^1 F(\kappa_1, \kappa_3) ds + \int_0^1 \Gamma x(s) ds$$

$$x_1(s) = \frac{\kappa_1[1] \times \kappa_3[1] \left(s - \frac{\sin[s \sqrt{\kappa_1[1]^2 + \kappa_3[1]^2}]}{\sqrt{\kappa_1[1]^2 + \kappa_3[1]^2}} \right)}{\kappa_1[1]^2 + \kappa_3[1]^2}$$

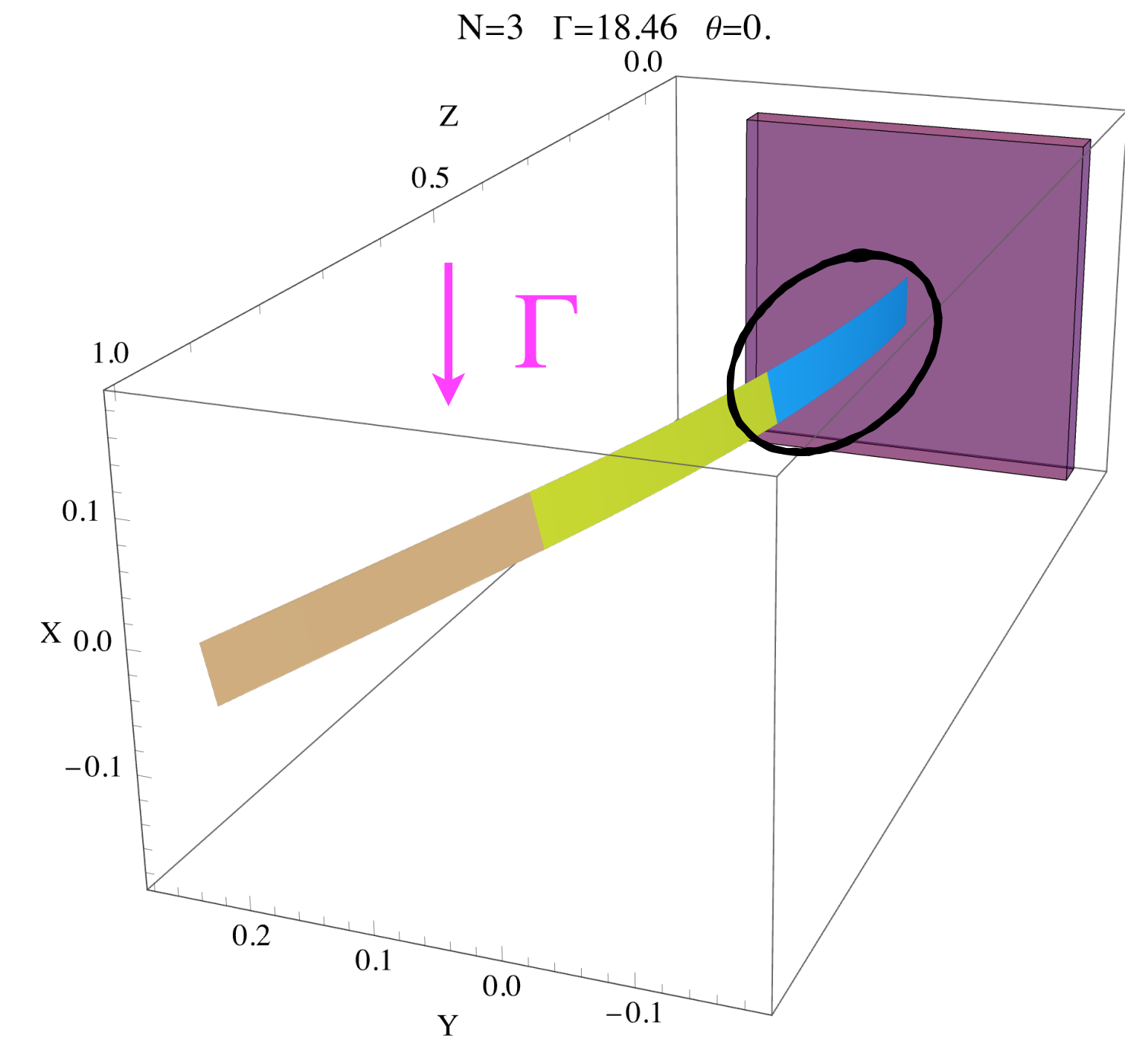

CHAINED SUPER HELICES

$$V[\kappa_{1,3}^{(i)}] = \int_0^1 F(\kappa_1, \kappa_3) ds + \int_0^1 \Gamma x(s) ds$$

$$x_2(s) = \frac{1}{3(\kappa_1[1]^2 + \kappa_3[1]^2)} \left(\kappa_1[1] \times \kappa_3[1] \left(1 - \frac{3 \sin\left[\frac{1}{3} \sqrt{\kappa_1[1]^2 + \kappa_3[1]^2}\right]}{\sqrt{\kappa_1[1]^2 + \kappa_3[1]^2}} \right) + \frac{1}{\kappa_1[2]^2 + \kappa_3[2]^2} \right. \\ \left. \left(-3 \left(-1 + \cos\left[\left(-\frac{1}{3} + s\right) \sqrt{\kappa_1[2]^2 + \kappa_3[2]^2}\right] \right) \sin\left[\frac{1}{3} \sqrt{\kappa_1[1]^2 + \kappa_3[1]^2}\right] \kappa_1[2] \times \kappa_3[1] \sqrt{\kappa_1[1]^2 + \kappa_3[1]^2} + \right. \right. \\ \left. \left. (-1 + 3s) \kappa_1[2] \left(\kappa_1[1]^2 + \cos\left[\frac{1}{3} \sqrt{\kappa_1[1]^2 + \kappa_3[1]^2}\right] \kappa_3[1]^2 \right) \kappa_3[2] + \right. \right. \\ \left. \left. 2(-1 + 3s) \sin\left[\frac{1}{6} \sqrt{\kappa_1[1]^2 + \kappa_3[1]^2}\right]^2 \kappa_1[1] \times \kappa_3[1] \kappa_3[2]^2 - \frac{1}{\sqrt{\kappa_1[2]^2 + \kappa_3[2]^2}} 3 \sin\left[\left(-\frac{1}{3} + s\right) \sqrt{\kappa_1[2]^2 + \kappa_3[2]^2}\right] \right. \right. \\ \left. \left. \left. \kappa_1[2] \left(\kappa_1[1] (-\kappa_1[2] \times \kappa_3[1] + \kappa_1[1] \times \kappa_3[2]) + \cos\left[\frac{1}{3} \sqrt{\kappa_1[1]^2 + \kappa_3[1]^2}\right] \kappa_3[1] (\kappa_1[1] \times \kappa_1[2] + \kappa_3[1] \times \kappa_3[2]) \right) \right) \right) \right) \right)$$

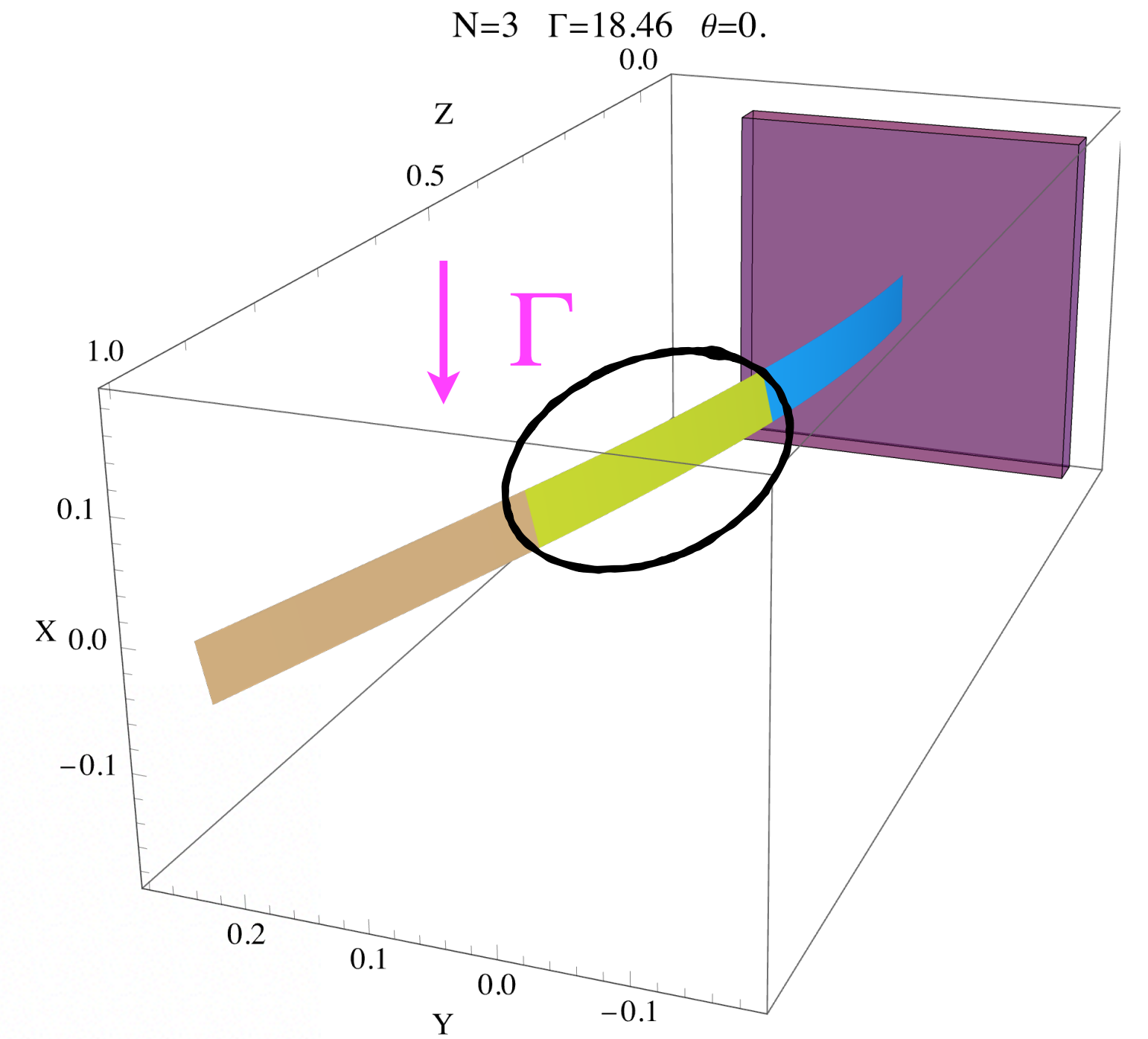

CHAINED SUPER HELICES

$$V[\kappa_{1,3}^{(i)}] = \int_0^1 F(\kappa_1, \kappa_3) ds + \int_0^1 \Gamma x(s) ds$$

$$x_3(s) = \frac{1}{3} \left(\frac{\kappa_1[1] \times \kappa_3[1] \left(-3 \sin\left[\frac{1}{3} \sqrt{\kappa_1[1]^2 + \kappa_3[1]^2}\right] + \sqrt{\kappa_1[1]^2 + \kappa_3[1]^2} \right)}{(\kappa_1[1]^2 + \kappa_3[1]^2)^{3/2}} + \right. \\ \left. \left(-3 \sin\left[\frac{1}{3} \sqrt{\kappa_1[2]^2 + \kappa_3[2]^2}\right] \kappa_1[2] \left(\kappa_1[1] (-\kappa_1[2] \times \kappa_3[1] + \kappa_1[1] \times \kappa_3[2]) + \cos\left[\frac{1}{3} \sqrt{\kappa_1[1]^2 + \kappa_3[1]^2}\right] \kappa_3[1] (\kappa_1[1] \times \kappa_1[2] + \kappa_3[1] \times \kappa_3[2]) \right) + \sqrt{\kappa_1[2]^2 + \kappa_3[2]^2} \right. \right. \\ \left. \left(6 \sin\left[\frac{1}{3} \sqrt{\kappa_1[1]^2 + \kappa_3[1]^2}\right] \sin\left[\frac{1}{6} \sqrt{\kappa_1[2]^2 + \kappa_3[2]^2}\right]^2 \kappa_1[2] \times \kappa_3[1] \sqrt{\kappa_1[1]^2 + \kappa_3[1]^2} + \kappa_3[2] \left(\cos\left[\frac{1}{3} \sqrt{\kappa_1[1]^2 + \kappa_3[1]^2}\right] \kappa_3[1] (\kappa_1[2] \times \kappa_3[1] - \kappa_1[1] \times \kappa_3[2]) + \kappa_1[1] (\kappa_1[1] \times \kappa_1[2] + \kappa_3[1] \times \kappa_3[2]) \right) \right) \right) \right) / \\ \left((\kappa_1[1]^2 + \kappa_3[1]^2) (\kappa_1[2]^2 + \kappa_3[2]^2)^{3/2} + \left(3 \sin\left[\left(-\frac{2}{3} + s\right) \sqrt{\kappa_1[3]^2 + \kappa_3[3]^2}\right] \kappa_1[3] \right. \right. \\ \left. \left. \left(\kappa_1[3] \left(\cos\left[\frac{1}{3} \sqrt{\kappa_1[2]^2 + \kappa_3[2]^2}\right] \kappa_1[2] \left(2 \sin\left[\frac{1}{6} \sqrt{\kappa_1[1]^2 + \kappa_3[1]^2}\right]^2 \kappa_1[1] \times \kappa_1[2] \times \kappa_3[1] - \left(\kappa_1[1]^2 + \cos\left[\frac{1}{3} \sqrt{\kappa_1[1]^2 + \kappa_3[1]^2}\right] \kappa_3[1]^2 \right) \kappa_3[2] \right) + \sin\left[\frac{1}{3} \sqrt{\kappa_1[1]^2 + \kappa_3[1]^2}\right] \sin\left[\frac{1}{3} \sqrt{\kappa_1[2]^2 + \kappa_3[2]^2}\right] \right. \right. \right. \\ \left. \left. \left. \kappa_1[2] \times \kappa_3[1] \sqrt{\kappa_1[1]^2 + \kappa_3[1]^2} \sqrt{\kappa_1[2]^2 + \kappa_3[2]^2} + \kappa_3[2] \left(\cos\left[\frac{1}{3} \sqrt{\kappa_1[1]^2 + \kappa_3[1]^2}\right] \kappa_1[2] \kappa_3[1]^2 + \kappa_1[1] \left(\kappa_1[1] \times \kappa_1[2] + 2 \sin\left[\frac{1}{6} \sqrt{\kappa_1[1]^2 + \kappa_3[1]^2}\right]^2 \kappa_3[1] \times \kappa_3[2] \right) \right) \right) \right) \right) + \\ \left(\cos\left[\frac{1}{3} \sqrt{\kappa_1[2]^2 + \kappa_3[2]^2}\right] \kappa_3[2] \left(2 \sin\left[\frac{1}{6} \sqrt{\kappa_1[1]^2 + \kappa_3[1]^2}\right]^2 \kappa_1[1] \times \kappa_1[2] \times \kappa_3[1] - \left(\kappa_1[1]^2 + \cos\left[\frac{1}{3} \sqrt{\kappa_1[1]^2 + \kappa_3[1]^2}\right] \kappa_3[1]^2 \right) \kappa_3[2] \right) + \sin\left[\frac{1}{3} \sqrt{\kappa_1[1]^2 + \kappa_3[1]^2}\right] \sin\left[\frac{1}{3} \sqrt{\kappa_1[2]^2 + \kappa_3[2]^2}\right] \right. \right. \\ \left. \left. \kappa_3[1] \sqrt{\kappa_1[1]^2 + \kappa_3[1]^2} \kappa_3[2] \sqrt{\kappa_1[2]^2 + \kappa_3[2]^2} - \kappa_1[2] \left(\cos\left[\frac{1}{3} \sqrt{\kappa_1[1]^2 + \kappa_3[1]^2}\right] \kappa_1[2] \kappa_3[1]^2 + \kappa_1[1] \left(\kappa_1[1] \times \kappa_1[2] + 2 \sin\left[\frac{1}{6} \sqrt{\kappa_1[1]^2 + \kappa_3[1]^2}\right]^2 \kappa_3[1] \times \kappa_3[2] \right) \right) \right) \right) \kappa_3[3] \right) - \\ 3 \left(1 - \cos\left[\left(-\frac{2}{3} + s\right) \sqrt{\kappa_1[3]^2 + \kappa_3[3]^2}\right] \right) \kappa_1[3] \left(\sin\left[\frac{1}{3} \sqrt{\kappa_1[2]^2 + \kappa_3[2]^2}\right] \left(2 \sin\left[\frac{1}{6} \sqrt{\kappa_1[1]^2 + \kappa_3[1]^2}\right]^2 \kappa_1[1] \times \kappa_1[2] \times \kappa_3[1] - \left(\kappa_1[1]^2 + \cos\left[\frac{1}{3} \sqrt{\kappa_1[1]^2 + \kappa_3[1]^2}\right] \kappa_3[1]^2 \right) \kappa_3[2] \right) \sqrt{\kappa_1[2]^2 + \kappa_3[2]^2} - \right. \\ \left. \cos\left[\frac{1}{3} \sqrt{\kappa_1[2]^2 + \kappa_3[2]^2}\right] \sin\left[\frac{1}{3} \sqrt{\kappa_1[1]^2 + \kappa_3[1]^2}\right] \kappa_3[1] \sqrt{\kappa_1[1]^2 + \kappa_3[1]^2} (\kappa_1[2]^2 + \kappa_3[2]^2) \right) \sqrt{\kappa_1[3]^2 + \kappa_3[3]^2} + \\ (-2 + 3s) \kappa_1[3] \left(\kappa_1[1]^2 \kappa_1[2]^2 + \kappa_1[1] \times \kappa_1[2] \times \kappa_3[1] \times \kappa_3[2] + \cos\left[\frac{1}{3} \sqrt{\kappa_1[2]^2 + \kappa_3[2]^2}\right] \kappa_1[1] \times \kappa_3[2] (-\kappa_1[2] \times \kappa_3[1] + \kappa_1[1] \times \kappa_3[2]) - \sin\left[\frac{1}{3} \sqrt{\kappa_1[1]^2 + \kappa_3[1]^2}\right] \sin\left[\frac{1}{3} \sqrt{\kappa_1[2]^2 + \kappa_3[2]^2}\right] \right. \\ \left. \kappa_3[1] \sqrt{\kappa_1[1]^2 + \kappa_3[1]^2} \kappa_3[2] \sqrt{\kappa_1[2]^2 + \kappa_3[2]^2} + \cos\left[\frac{1}{3} \sqrt{\kappa_1[1]^2 + \kappa_3[1]^2}\right] \kappa_3[1] \left(\kappa_1[2] (\kappa_1[2] \times \kappa_3[1] - \kappa_1[1] \times \kappa_3[2]) + \cos\left[\frac{1}{3} \sqrt{\kappa_1[2]^2 + \kappa_3[2]^2}\right] \kappa_3[2] (\kappa_1[1] \times \kappa_1[2] + \kappa_3[1] \times \kappa_3[2]) \right) \right) \right) \\ \left. \kappa_3[3] \sqrt{\kappa_1[3]^2 + \kappa_3[3]^2} + (-2 + 3s) \left(\kappa_1[1]^2 \kappa_1[2] \times \kappa_3[2] + \kappa_1[1] \times \kappa_3[1] \kappa_3[2]^2 + \cos\left[\frac{1}{3} \sqrt{\kappa_1[1]^2 + \kappa_3[1]^2}\right] \kappa_3[1] \times \kappa_3[2] (\kappa_1[2] \times \kappa_3[1] - \kappa_1[1] \times \kappa_3[2]) + \right. \right. \\ \left. \left. \sin\left[\frac{1}{3} \sqrt{\kappa_1[1]^2 + \kappa_3[1]^2}\right] \sin\left[\frac{1}{3} \sqrt{\kappa_1[2]^2 + \kappa_3[2]^2}\right] \kappa_1[2] \times \kappa_3[1] \sqrt{\kappa_1[1]^2 + \kappa_3[1]^2} \sqrt{\kappa_1[2]^2 + \kappa_3[2]^2} - \cos\left[\frac{1}{3} \sqrt{\kappa_1[2]^2 + \kappa_3[2]^2}\right] \kappa_1[2] \right. \right. \\ \left. \left. \left(\kappa_1[1] (-\kappa_1[2] \times \kappa_3[1] + \kappa_1[1] \times \kappa_3[2]) + \cos\left[\frac{1}{3} \sqrt{\kappa_1[1]^2 + \kappa_3[1]^2}\right] \kappa_3[1] (\kappa_1[1] \times \kappa_1[2] + \kappa_3[1] \times \kappa_3[2]) \right) \right) \kappa_3[3]^2 \sqrt{\kappa_1[3]^2 + \kappa_3[3]^2} \right) / \left((\kappa_1[1]^2 + \kappa_3[1]^2) (\kappa_1[2]^2 + \kappa_3[2]^2) (\kappa_1[3]^2 + \kappa_3[3]^2)^{3/2} \right) \right)$$

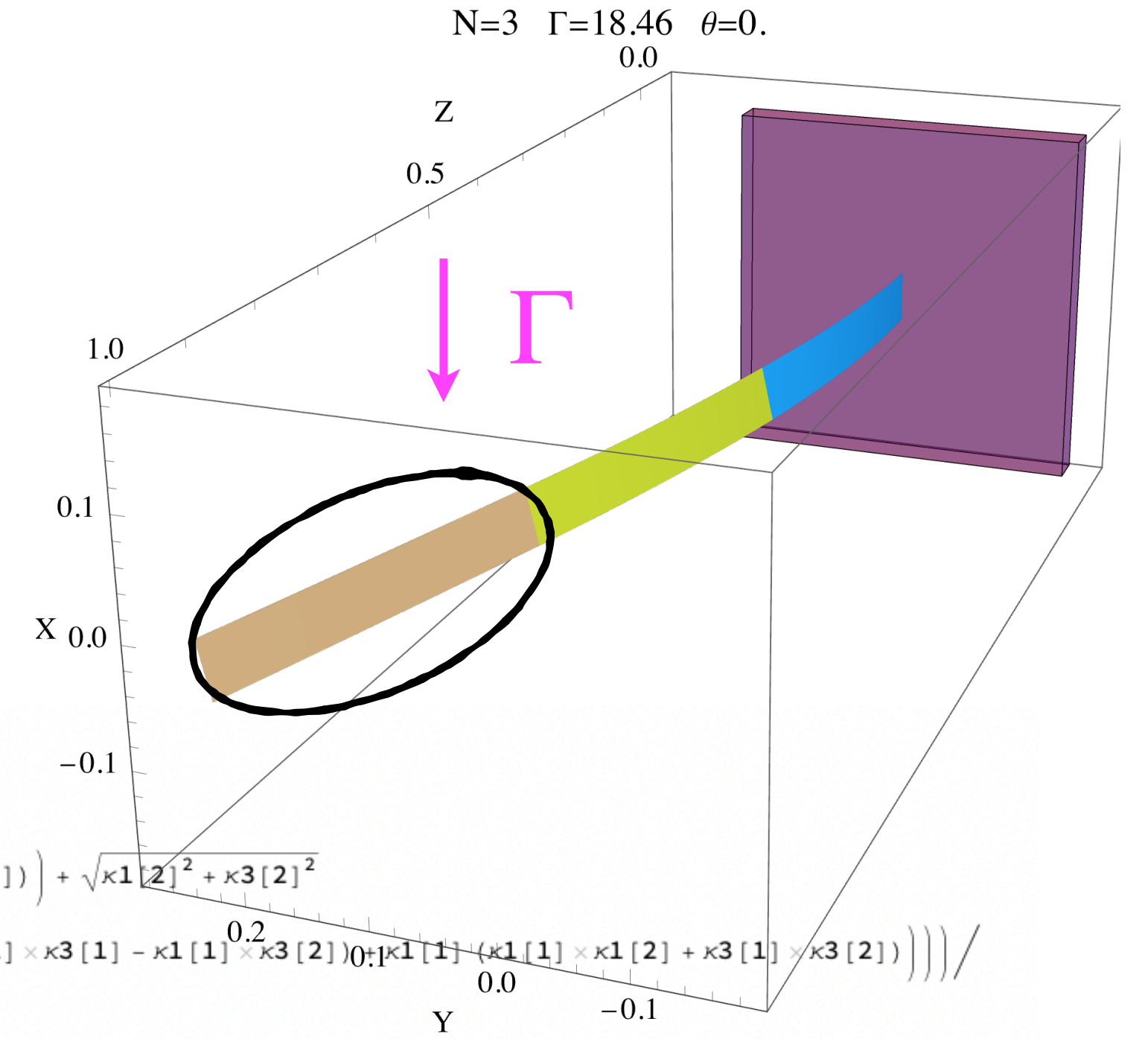

CHAINED SUPER HELICES

$$V[\kappa_{1,3}^{(i)}] = \int_0^1 F(\kappa_1, \kappa_3) ds + \int_0^1 \Gamma x(s) ds$$

equilibrium $\nabla V(\kappa_1^{(i)}, \kappa_3^{(i)}) = 0$

Hessian
(Jacobian) $H_{ij} = \frac{\partial^2 V}{\partial \kappa_{1,3}^{(i)} \partial \kappa_{1,3}^{(j)}}$

$N = 3$
6 dofs

$$H = \begin{pmatrix} 0.343101 & 0.301999 & 0.00818523 & 0.0000260758 & 0.00136636 & 4.8861 \times 10^{-7} \\ 0.301999 & 0.511598 & 0.249532 & 0.00486517 & 0.0349803 & 0.000069284 \\ 0.00818523 & 0.249532 & 0.345727 & 0.10058 & 0.00255619 & 2.67903 \times 10^{-7} \\ 0.0000260758 & 0.00486517 & 0.10058 & 0.496799 & 0.0364329 & 0.0000684055 \\ 0.00136636 & 0.0349803 & 0.00255619 & 0.0364329 & 0.334652 & 0.00917153 \\ 4.8861 \times 10^{-7} & 0.000069284 & 2.67903 \times 10^{-7} & 0.0000684055 & 0.00917153 & 0.493854 \end{pmatrix}$$

Number dofs = 2 N

Full Hessian Matrix

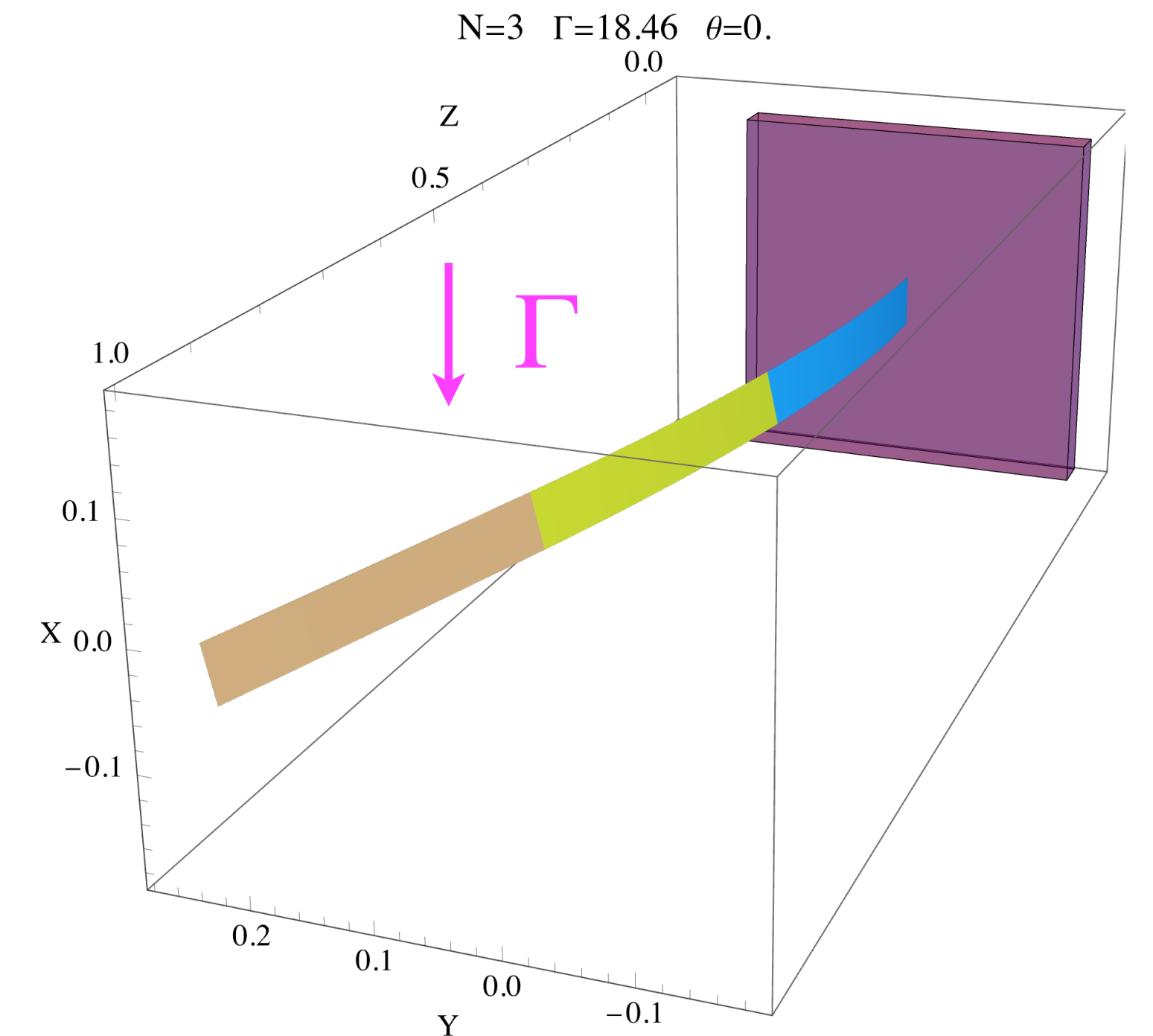

CHAINED VS MIXED APPROACHES

$$V[\kappa_{1,3}^{(i)}] = \int_0^1 F(\kappa_1, \kappa_3) ds + \int_0^1 \Gamma x(s) ds$$

Charrondiere et al CMAME 2020

Total time (seconds)

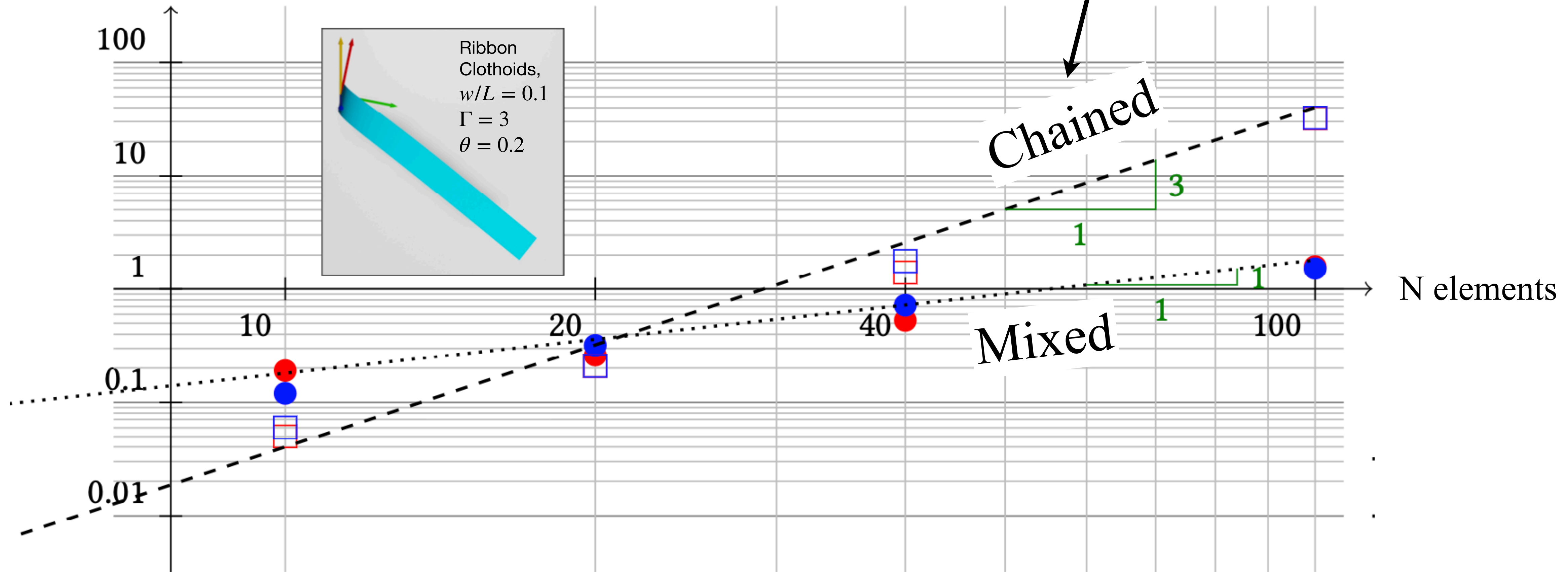

(VISUAL) CONVERGENCE

$$V[\kappa_{1,3}^{(i)}] = \int_0^1 F(\kappa_1, \kappa_3) ds + \int_0^1 \Gamma x(s) ds$$

$N=2 \quad \Gamma=40. \quad \theta=0.$

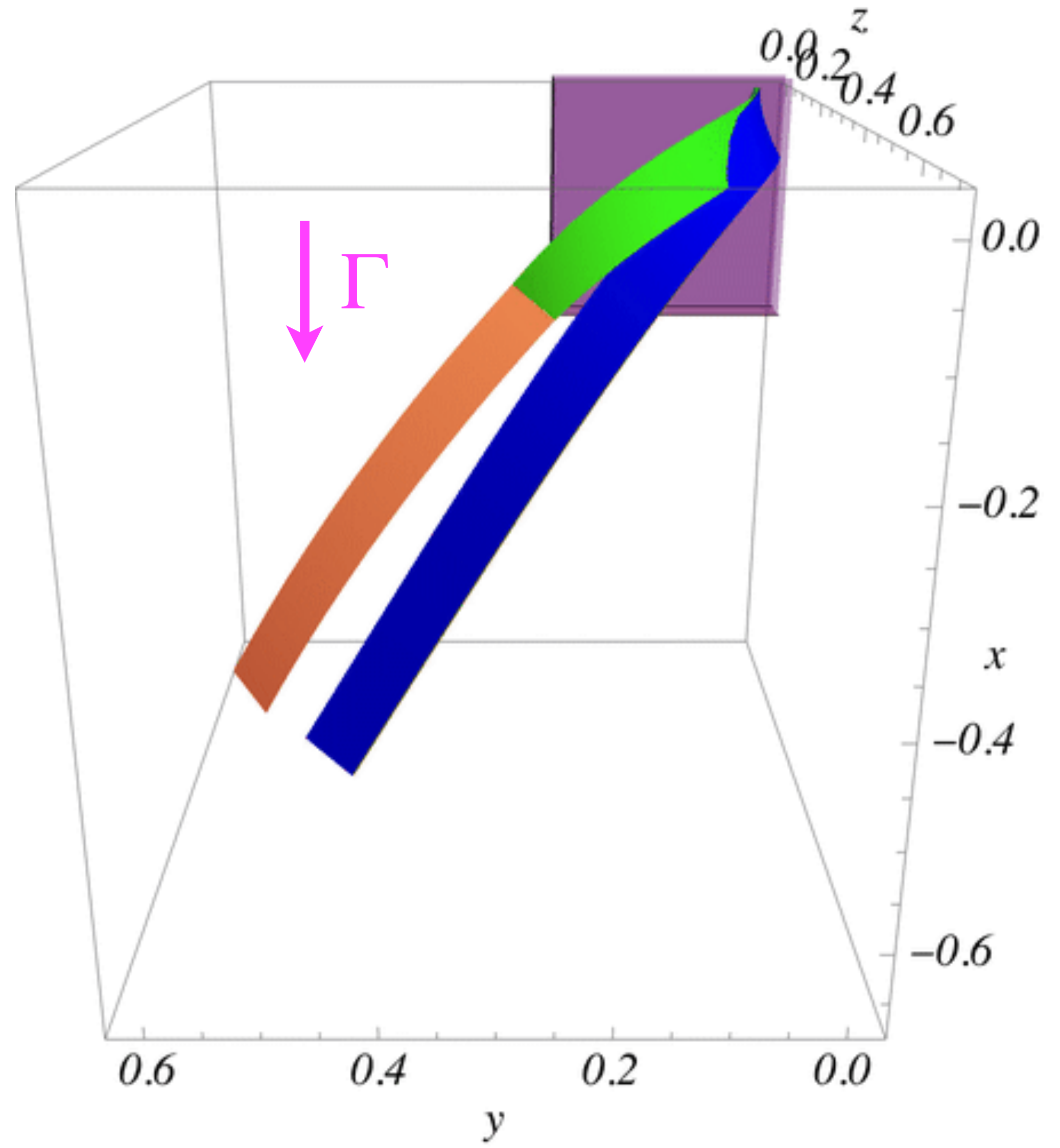

THE MIXED APPROACH

$$V = \int_0^1 F(\kappa_1, \kappa_3) ds + \int_0^1 \Gamma x(s) ds$$

$$V = V(\kappa_1^{(i)}, \kappa_3^{(i)}, r^{(i)}, d_{123}^{(i)}) \text{ with } i \in (1, 2, \dots, N)$$

Minimize V under matching constraints

Number dofs = $14 N$

Banded Hessian matrix

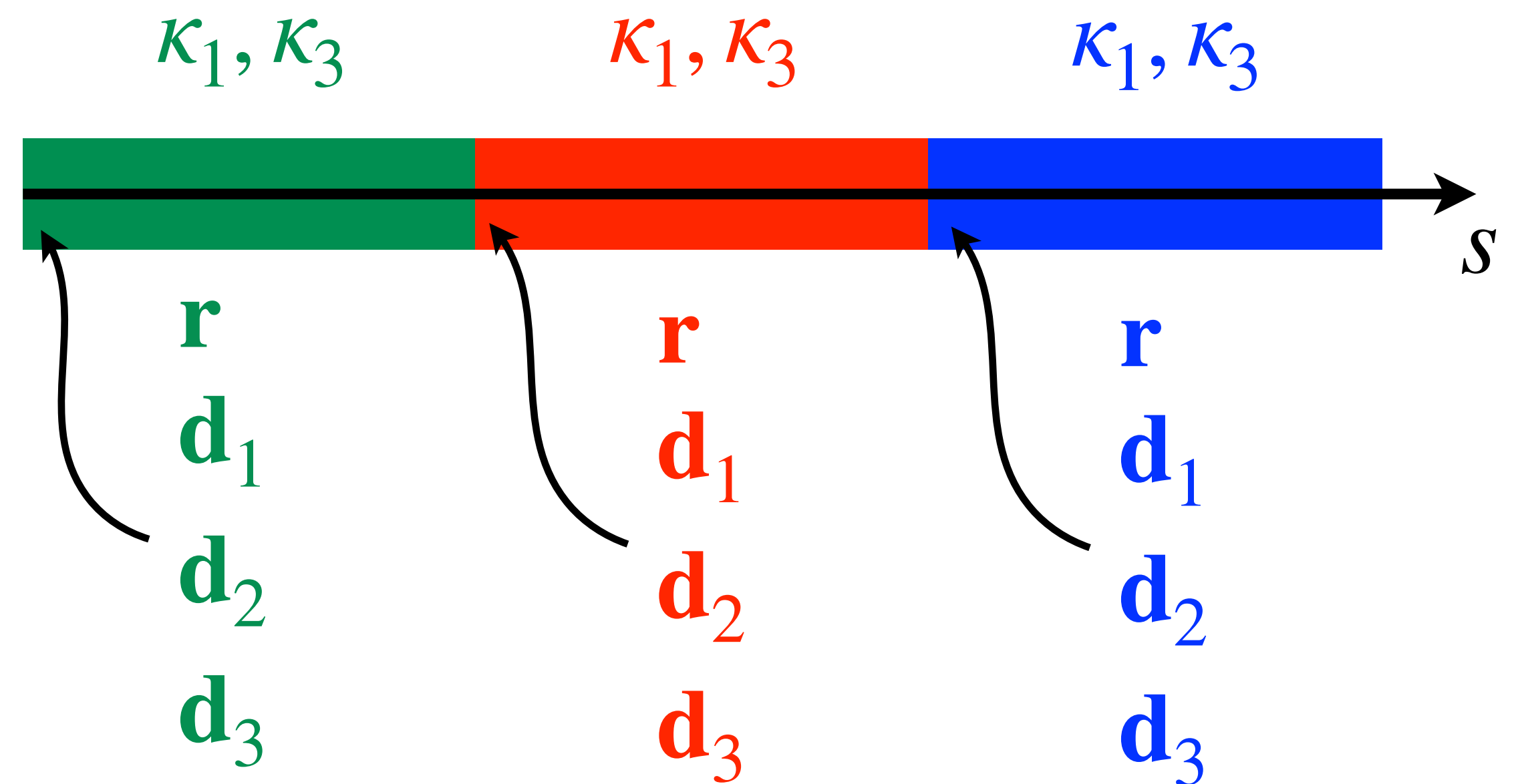

THE MIXED APPROACH

$N = 8$ elements \Rightarrow 112 dofs

$H =$



Banded Hessian matrix

THE MIXED APPROACH

$N = 8$ elements \Rightarrow 112 dofs

$H =$

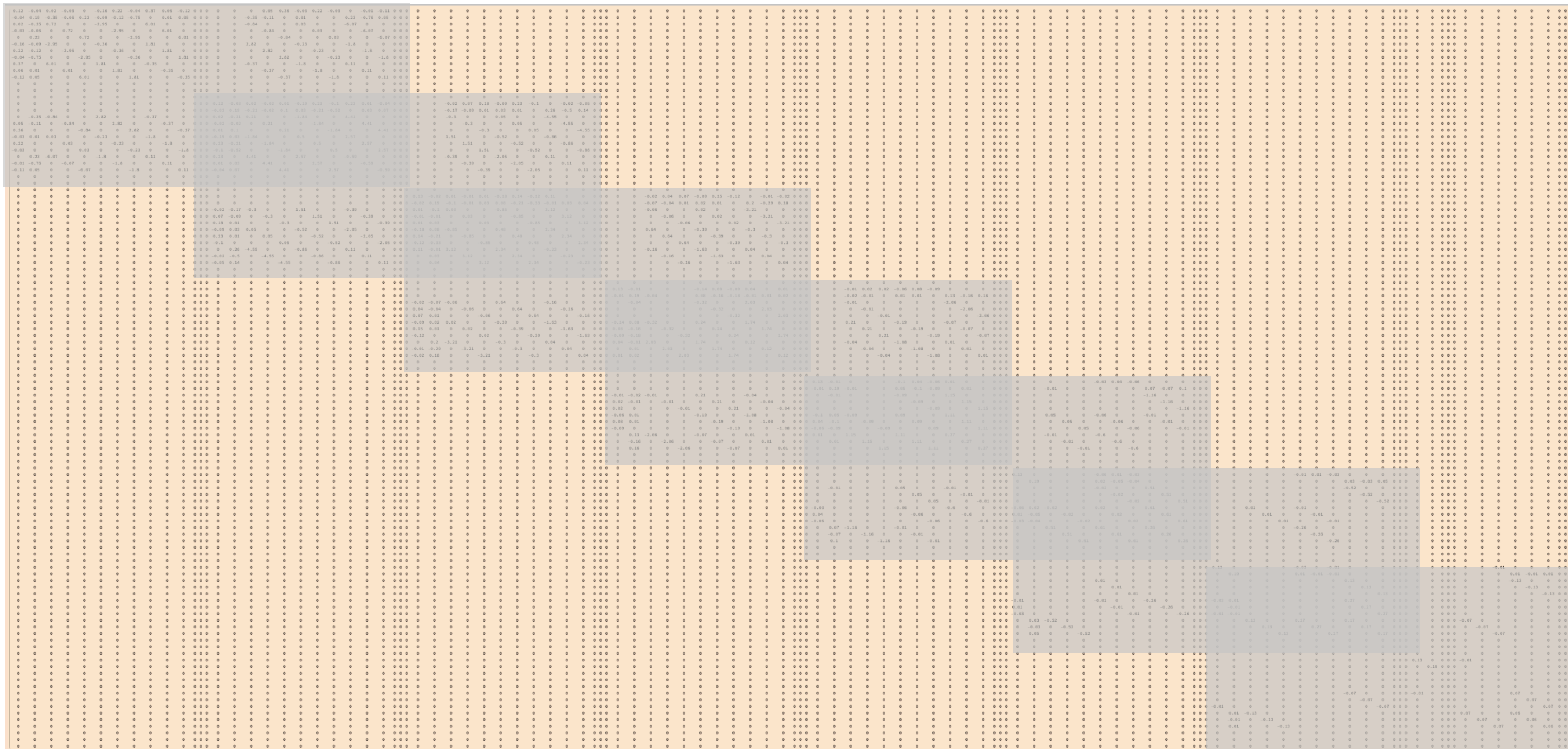

Banded Hessian matrix

CHAINED VS MIXED APPROACHES

$$V[\kappa_{1,3}^{(i)}] = \int_0^1 F(\kappa_1, \kappa_3) ds + \int_0^1 \Gamma x(s) ds$$

Total time (seconds)

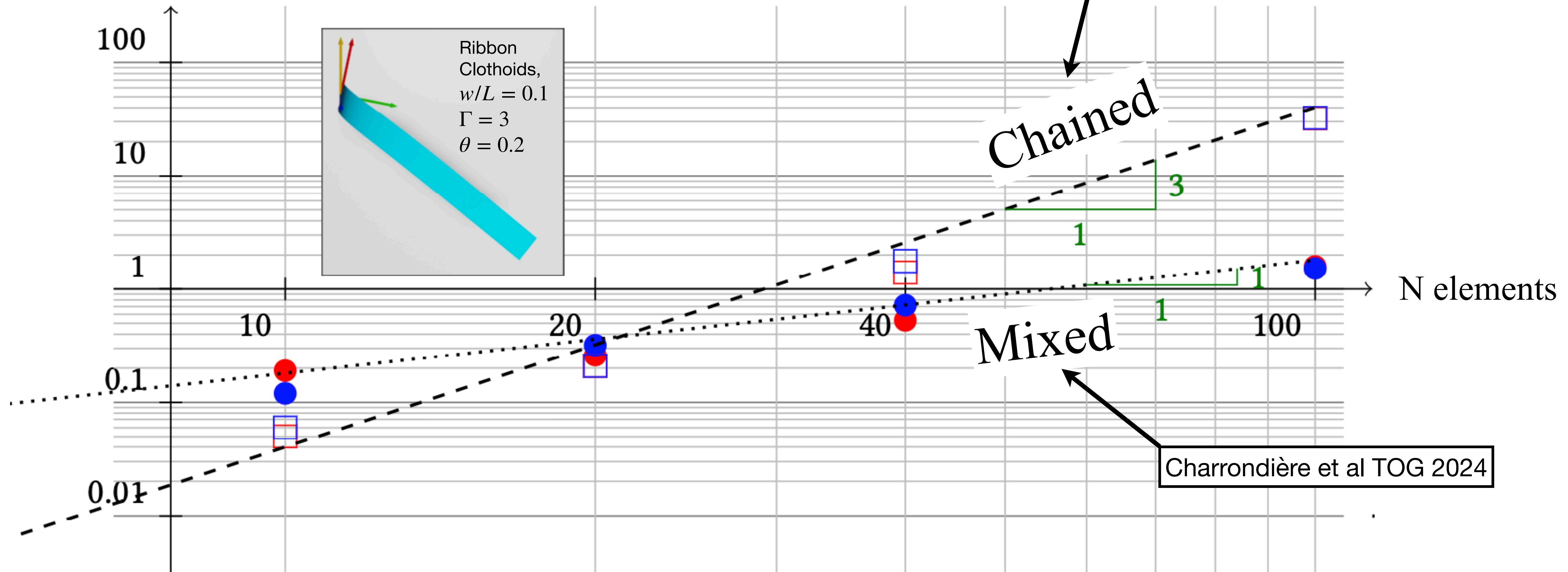

EXAMPLES

MOEBIUS

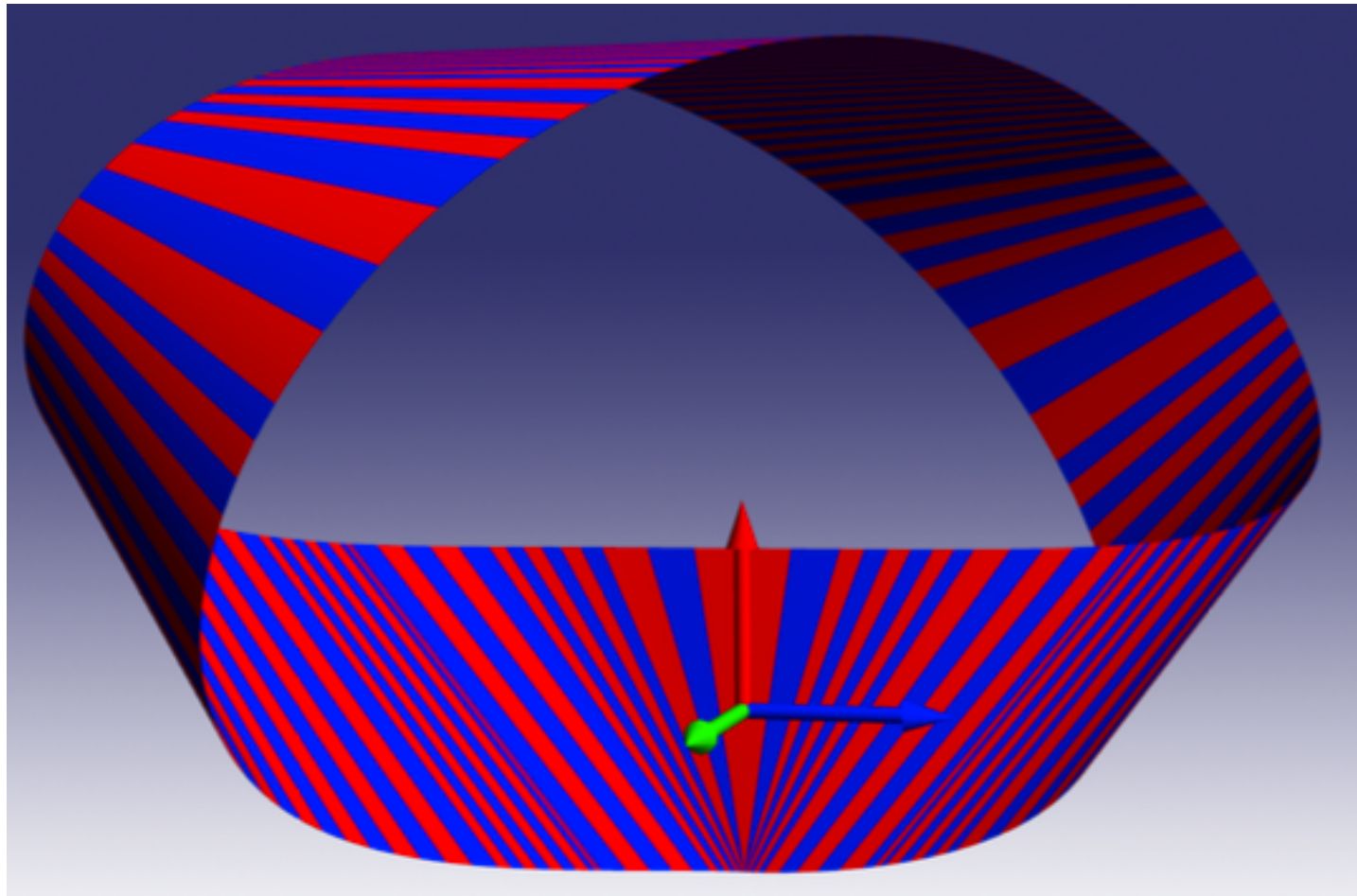

CONSTRAINED BUCKLING

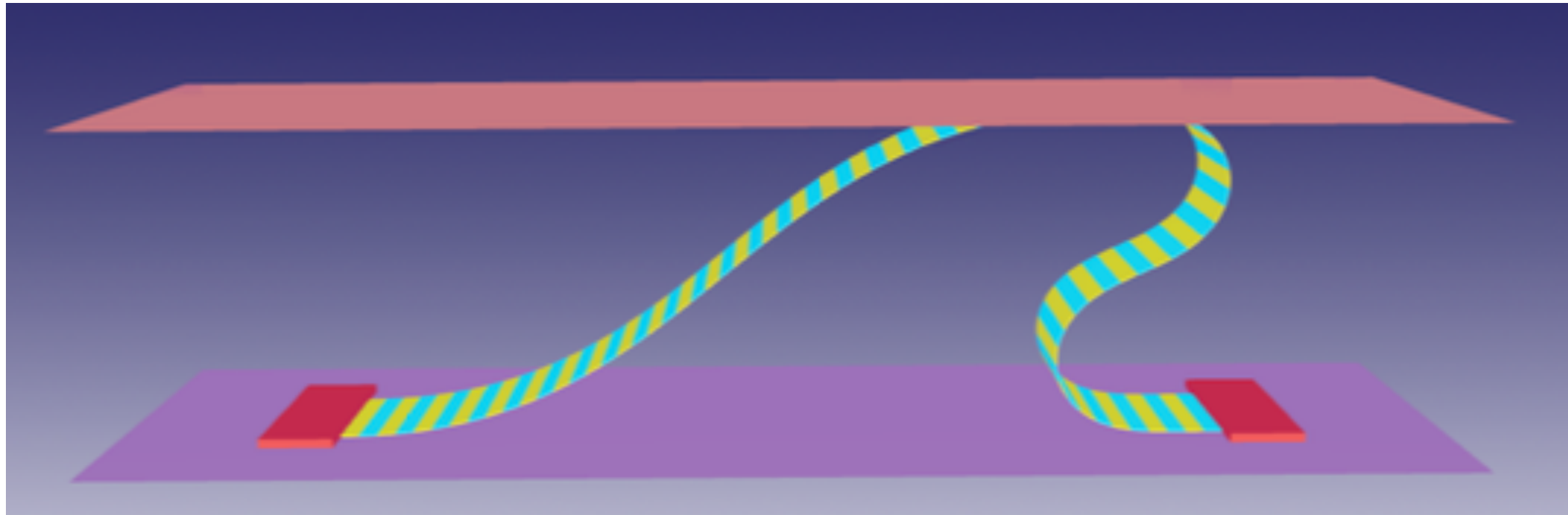

LATERAL TORSIONAL BUCKLING

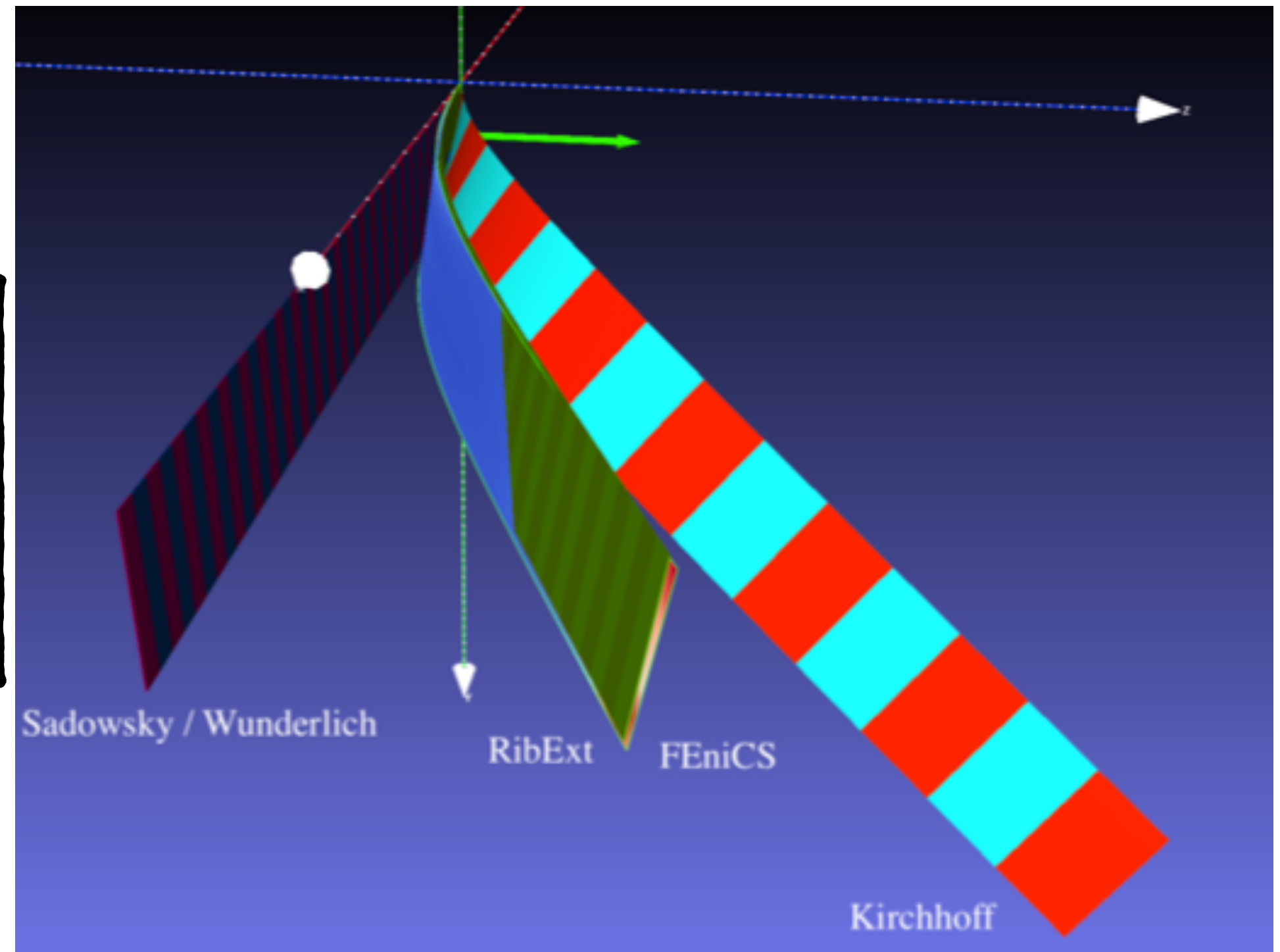

Charrondiere et al TOG 2024

MOEBIUS BAND

Roger Fosdick
Eliot Fried *Editors*

The Mechanics of Ribbons and Möbius Bands

 Springer

1858 Johann Benedict Listing (analysis situs => topology)

1858 A. F. Moebius

1929 M. Sadowsky (developable surface)

1962 W. Wunderlich (exact energy)

2007 Starostin+Heijden (numerics)

2015 Journal of Elasticity
special issue edited by
R. Fosdick & E. Fried

MOEBIUS BAND

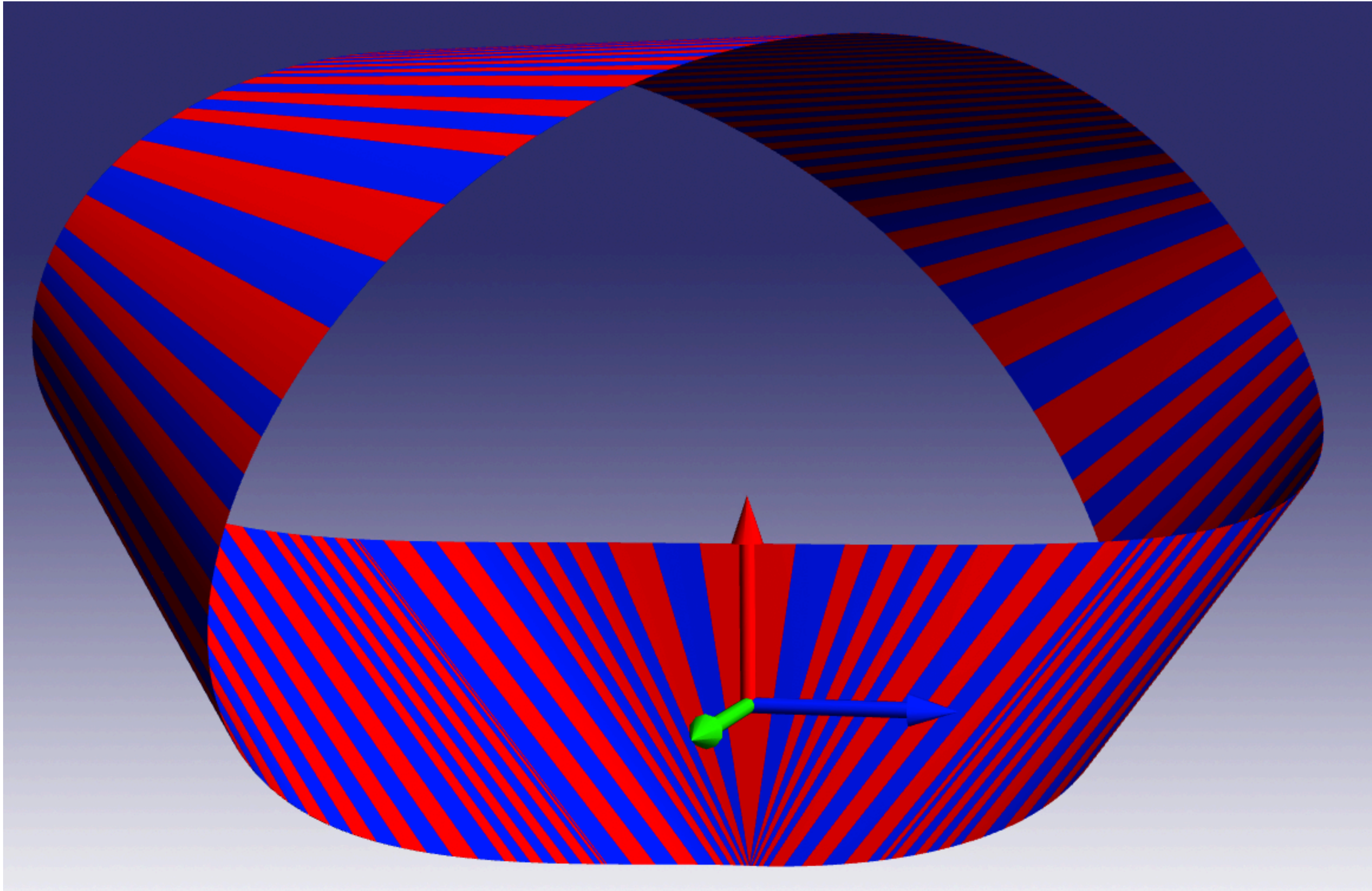

Wunderlich energy

169 elements (resmeshing)

$w/L = 0.1$

approx. 1 second

MOEBIUS BAND: CONVERGENCE RATE

Korner Audoly Bhattacharya Proc Soc A 2021

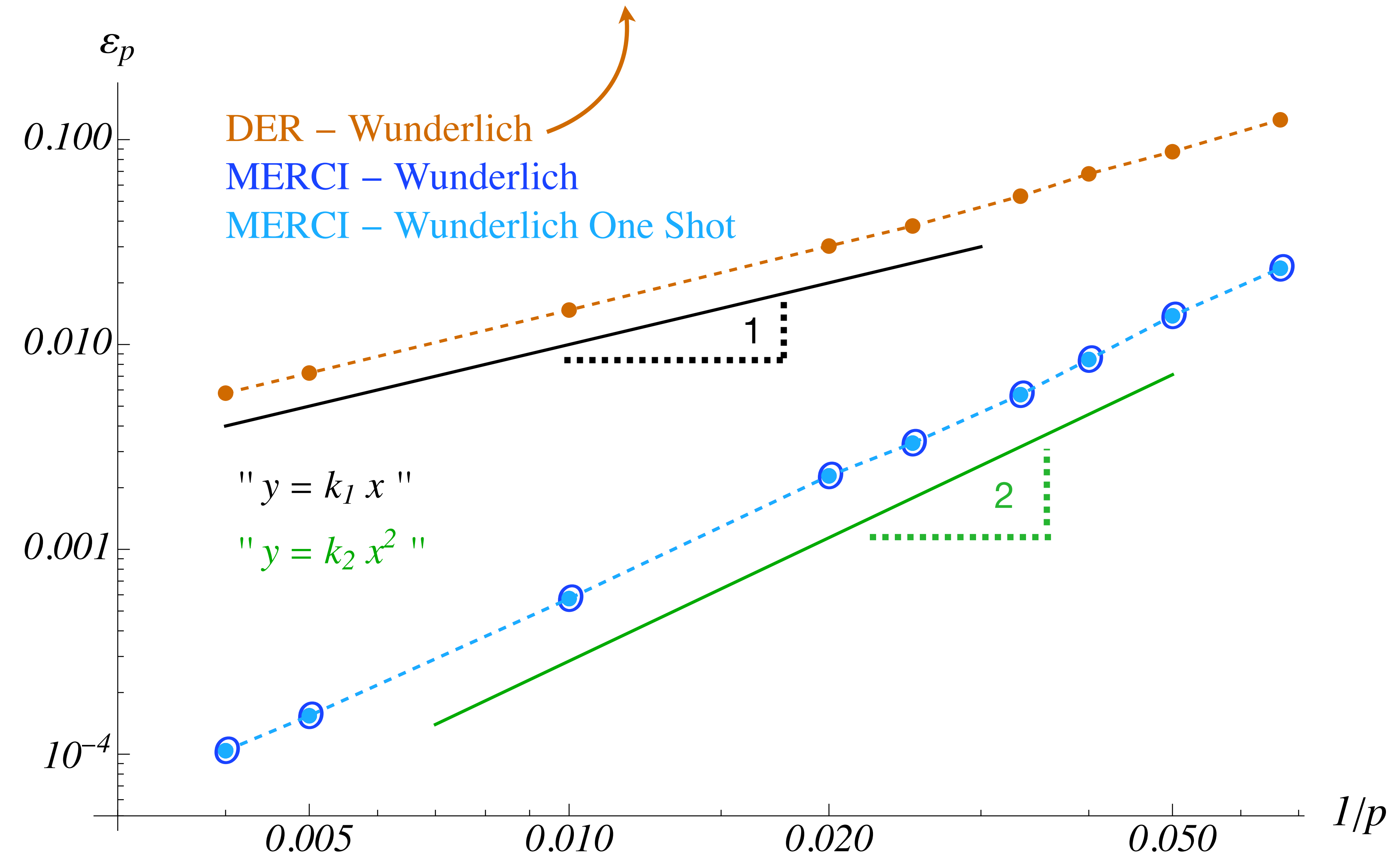

MOEBIUS BAND: COMPUTATION TIME

Korner Audoly Bhattacharya Proc Soc A 2021

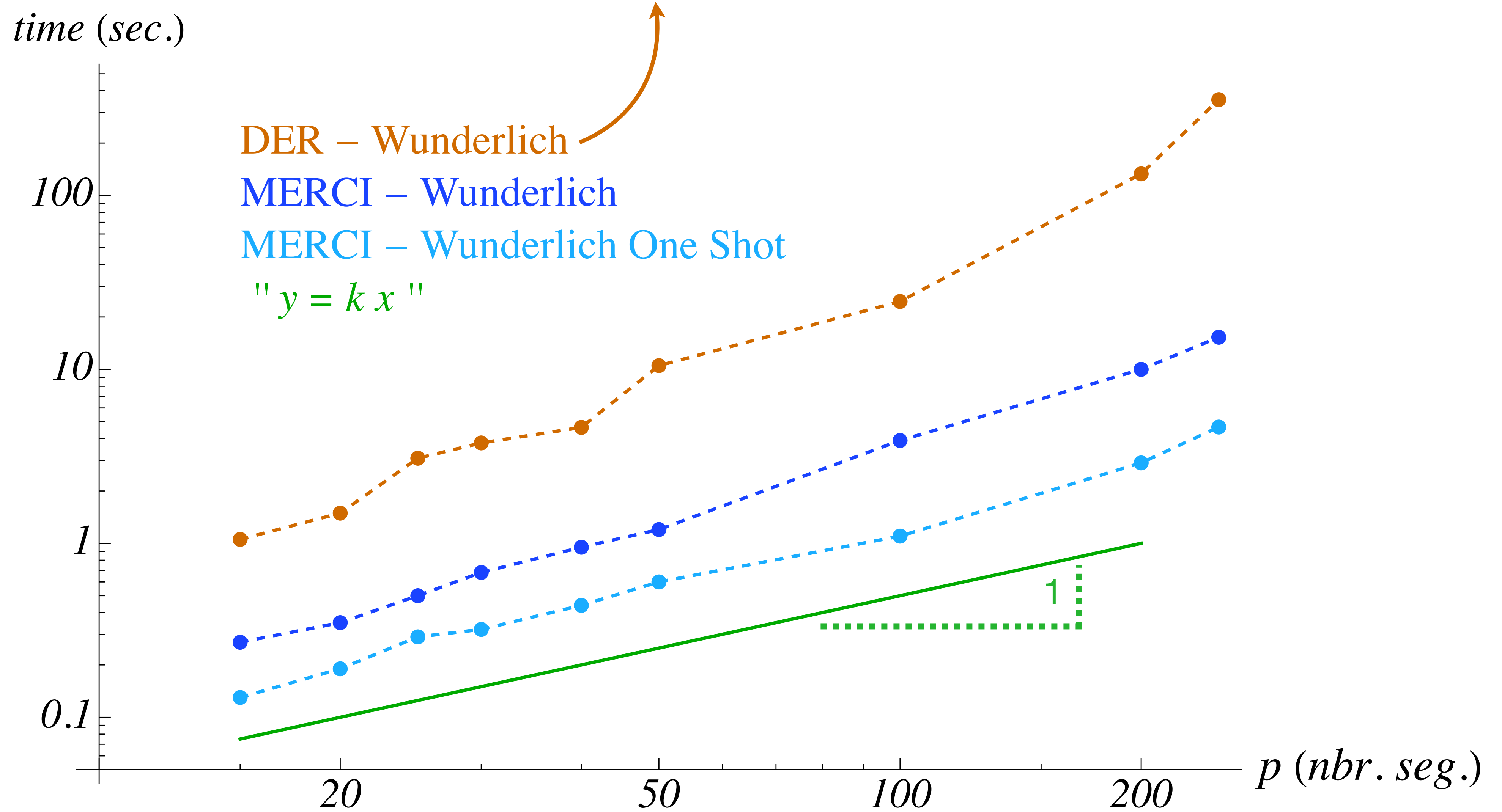

MOEBIUS BAND: EFFICIENCY

Korner Audoly Bhattacharya Proc Soc A 2021

time (sec.)

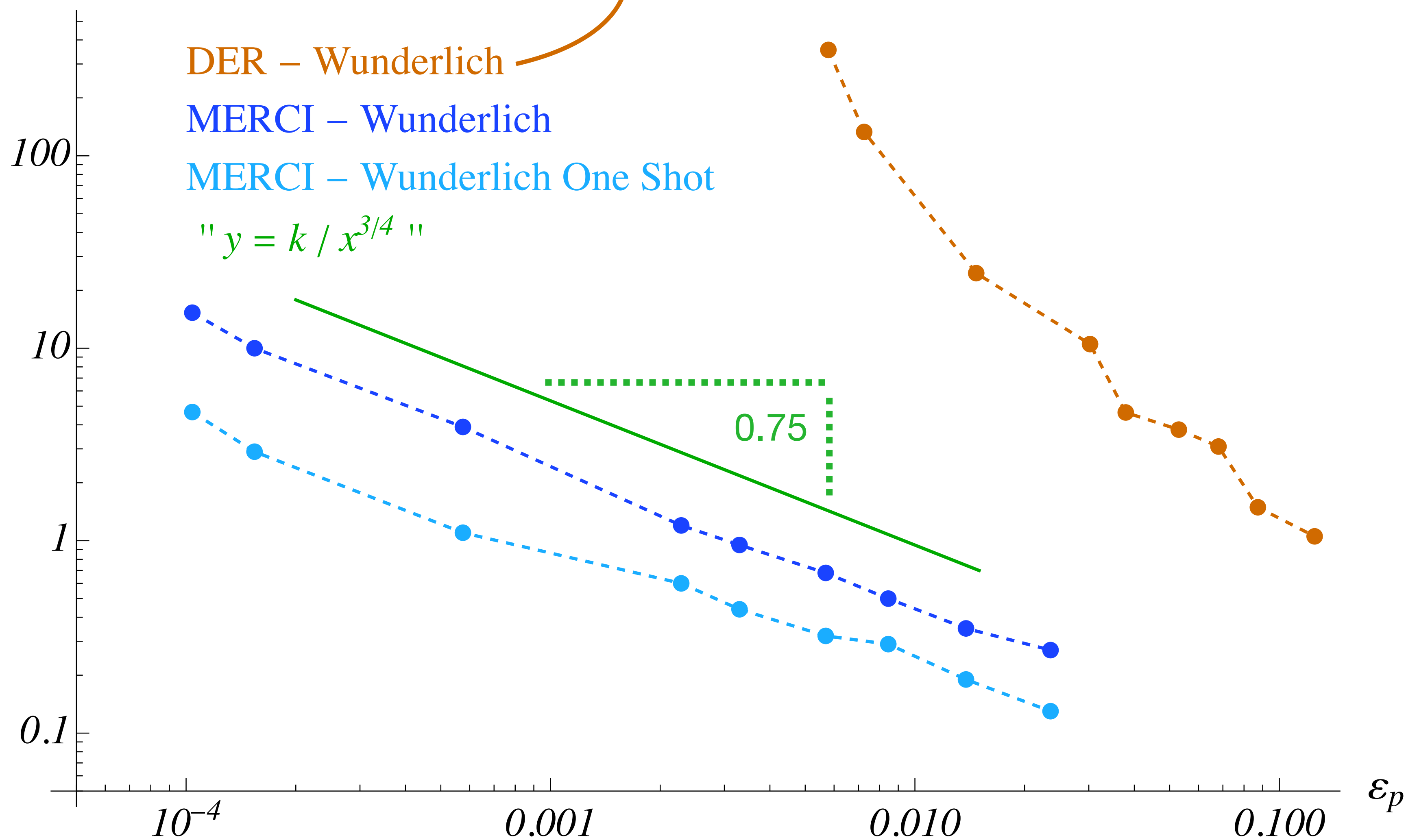

Lateral Torsional Buckling

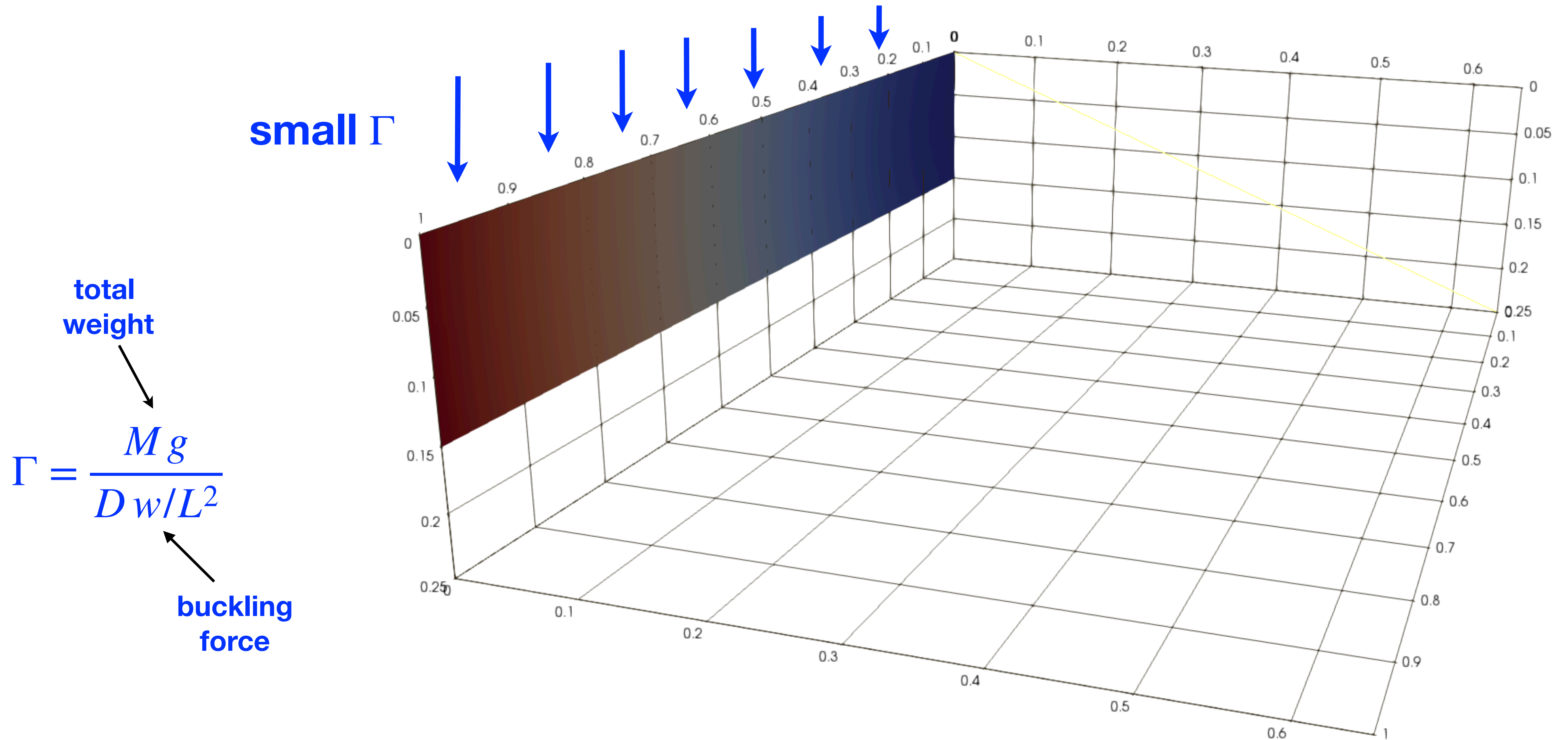

Lateral Torsional Buckling

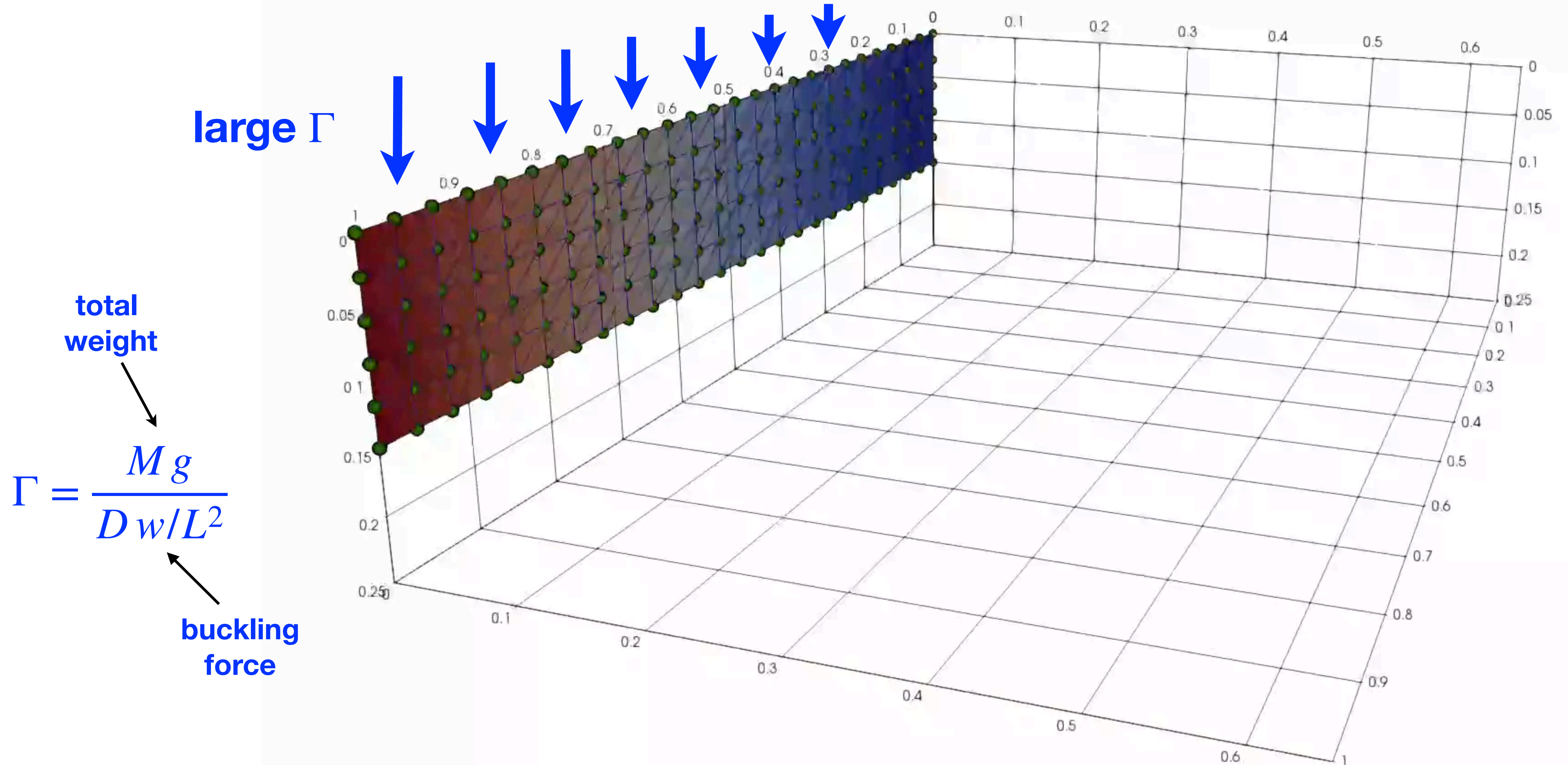

using FEniCS-Shell (Hale, Brunetti, Bordas, Maurini, Comp. & Struct 2018)

Lateral Torsional Buckling

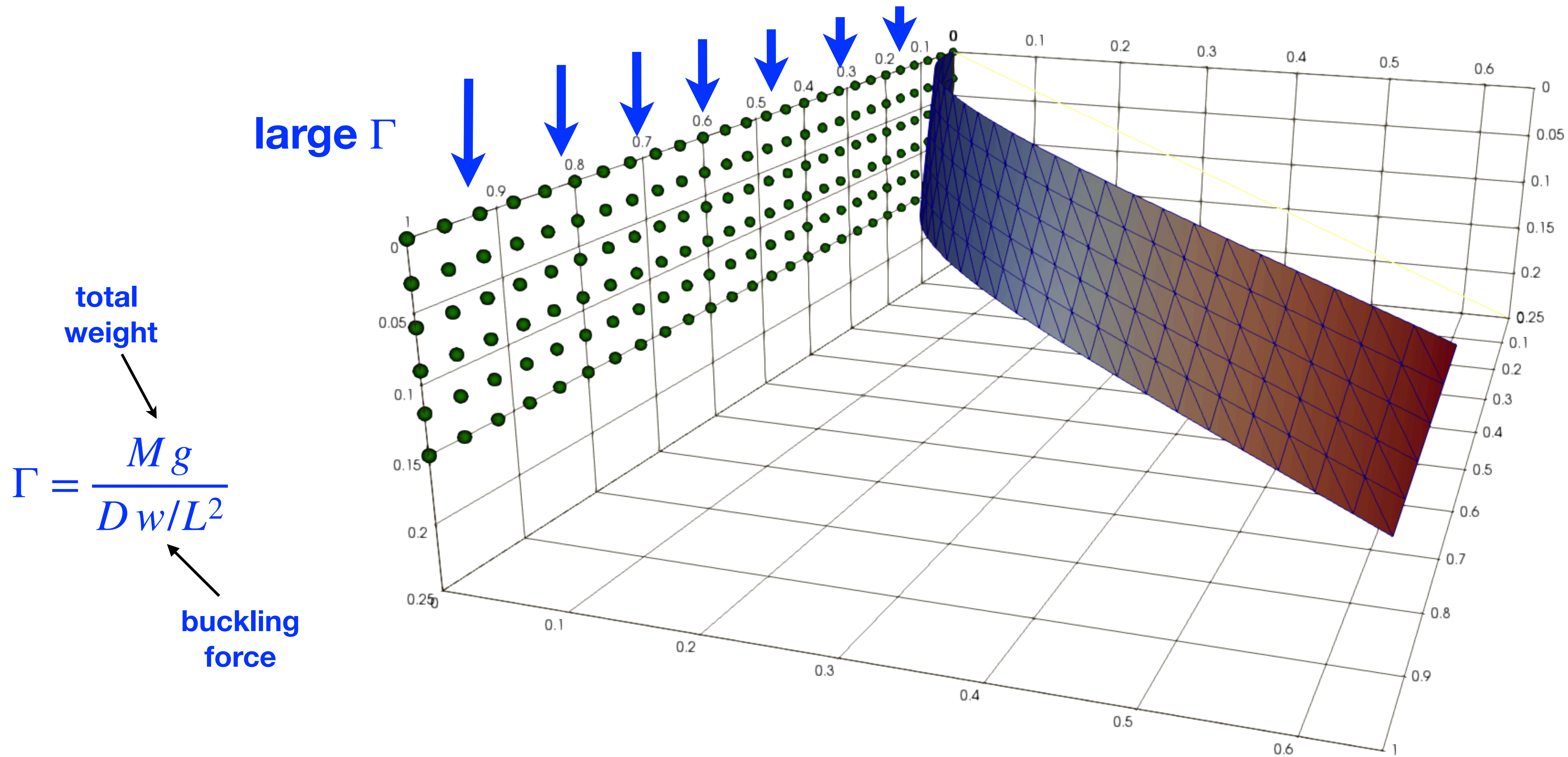

Lateral Torsional Buckling

$$w/L = 0.1$$

$$h/L = 0.001$$

$$\nu = 0.35$$

$$\Gamma = \frac{Mg}{Dw/L^2}$$

$$\Gamma_{\text{buck}} = 15$$

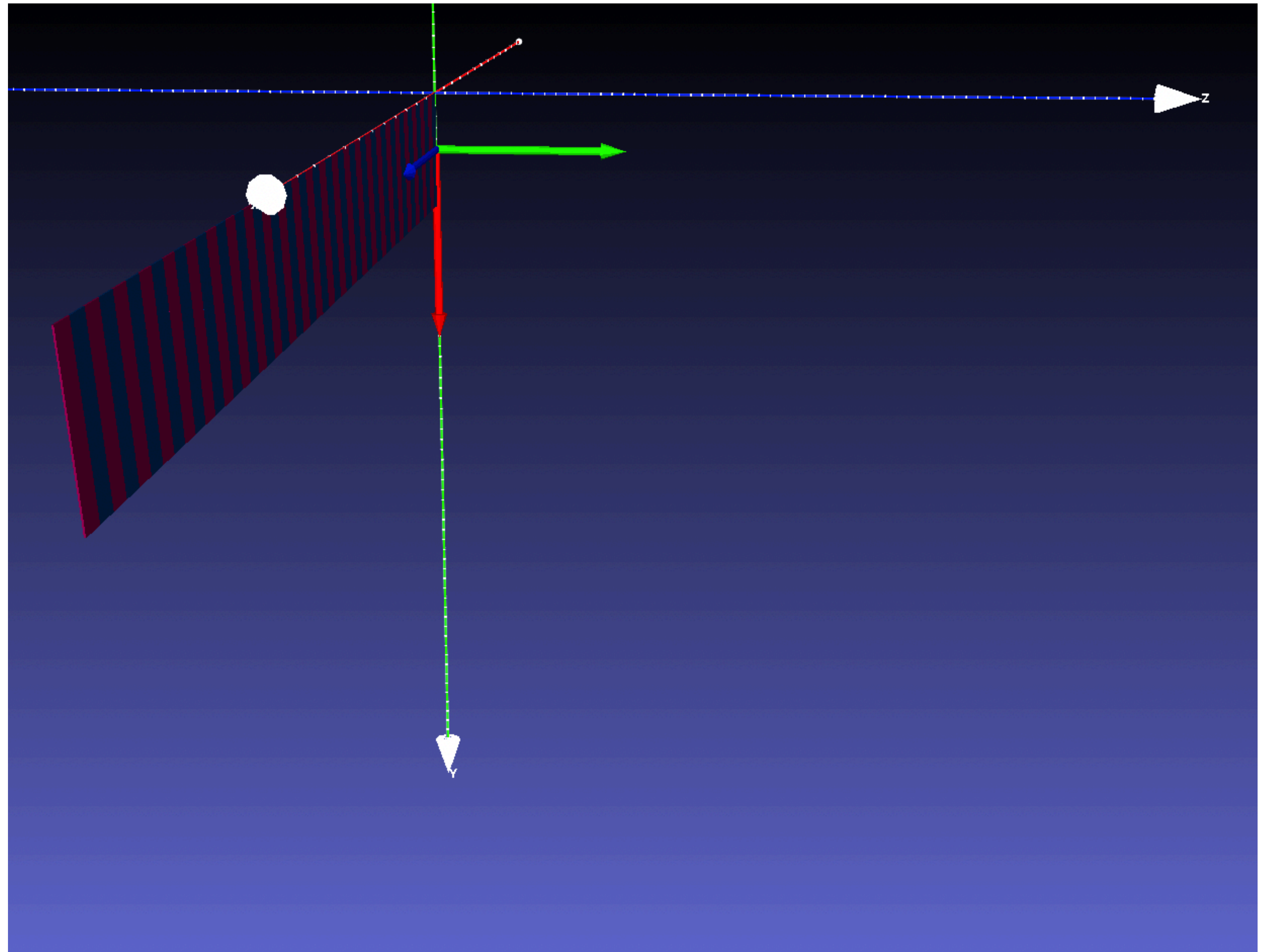

Lateral Torsional Buckling

$$w/L = 0.1$$

$$h/L = 0.001$$

$$\nu = 0.35$$

$$\Gamma = \frac{Mg}{Dw/L^2} = 20$$

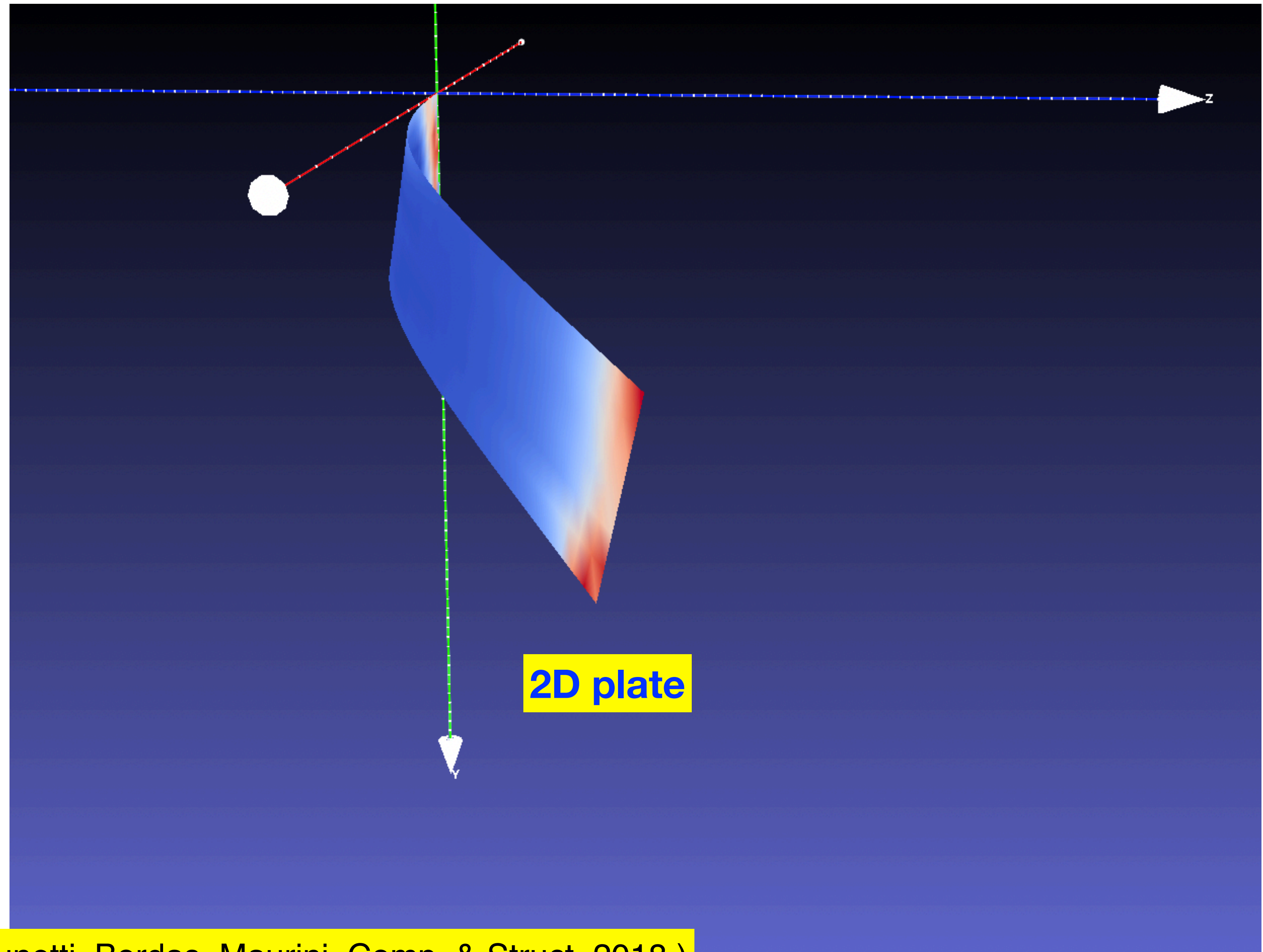

FEniCS-Shell (Hale, Brunetti, Bordas, Maurini Comp. & Struct. 2018)

$$\eta(0) = 0$$

Lateral Torsional Buckling

$$w/L = 0.1$$

$$h/L = 0.001$$

$$\nu = 0.35$$

$$\Gamma = \frac{Mg}{Dw/L^2} = 20$$

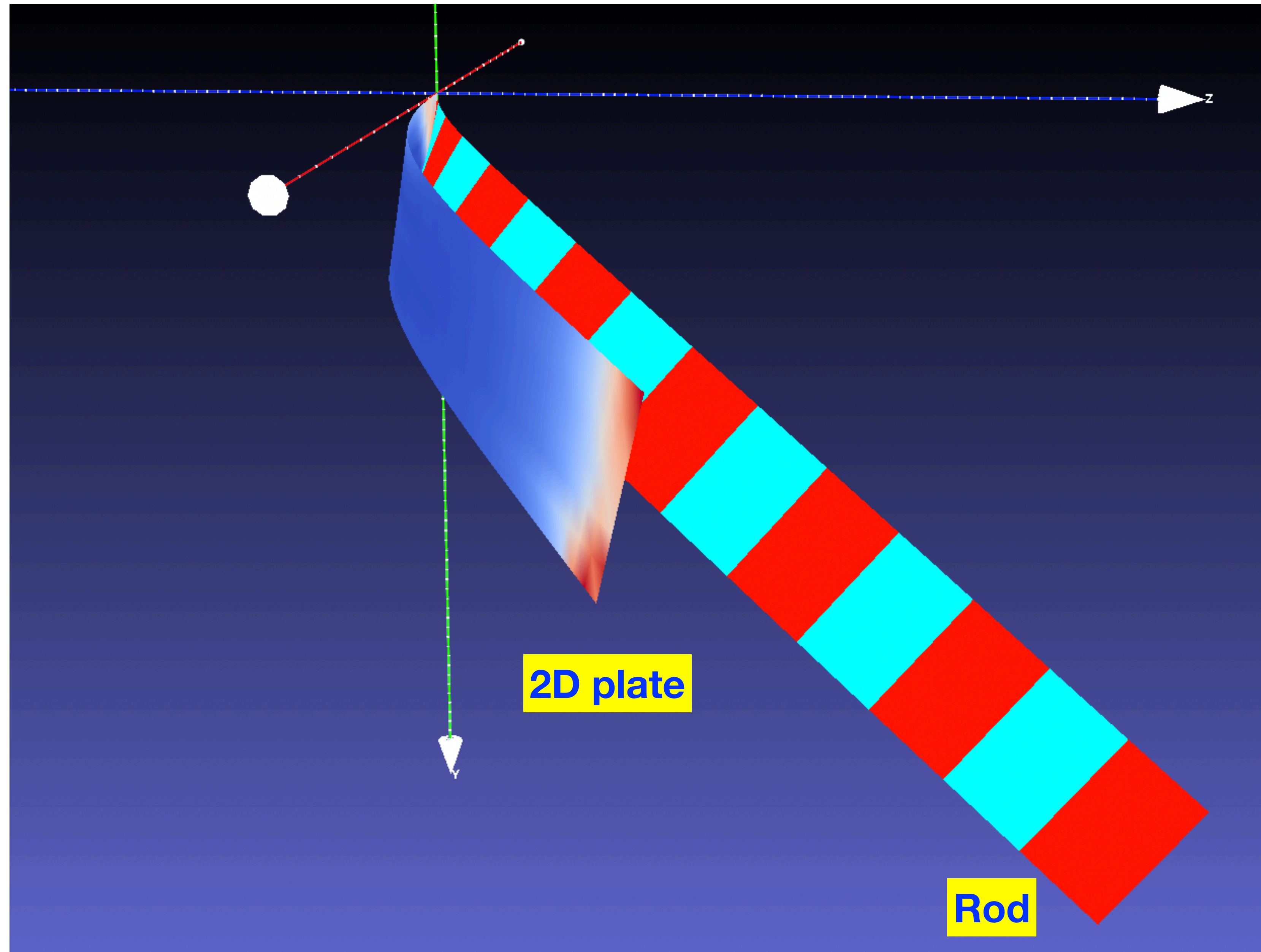

$$\eta(0) = 0$$

Lateral Torsional Buckling

$$w/L = 0.1$$

$$h/L = 0.001$$

$$\nu = 0.35$$

$$\Gamma = \frac{Mg}{Dw/L^2} = 20$$

$$Sh = 10$$

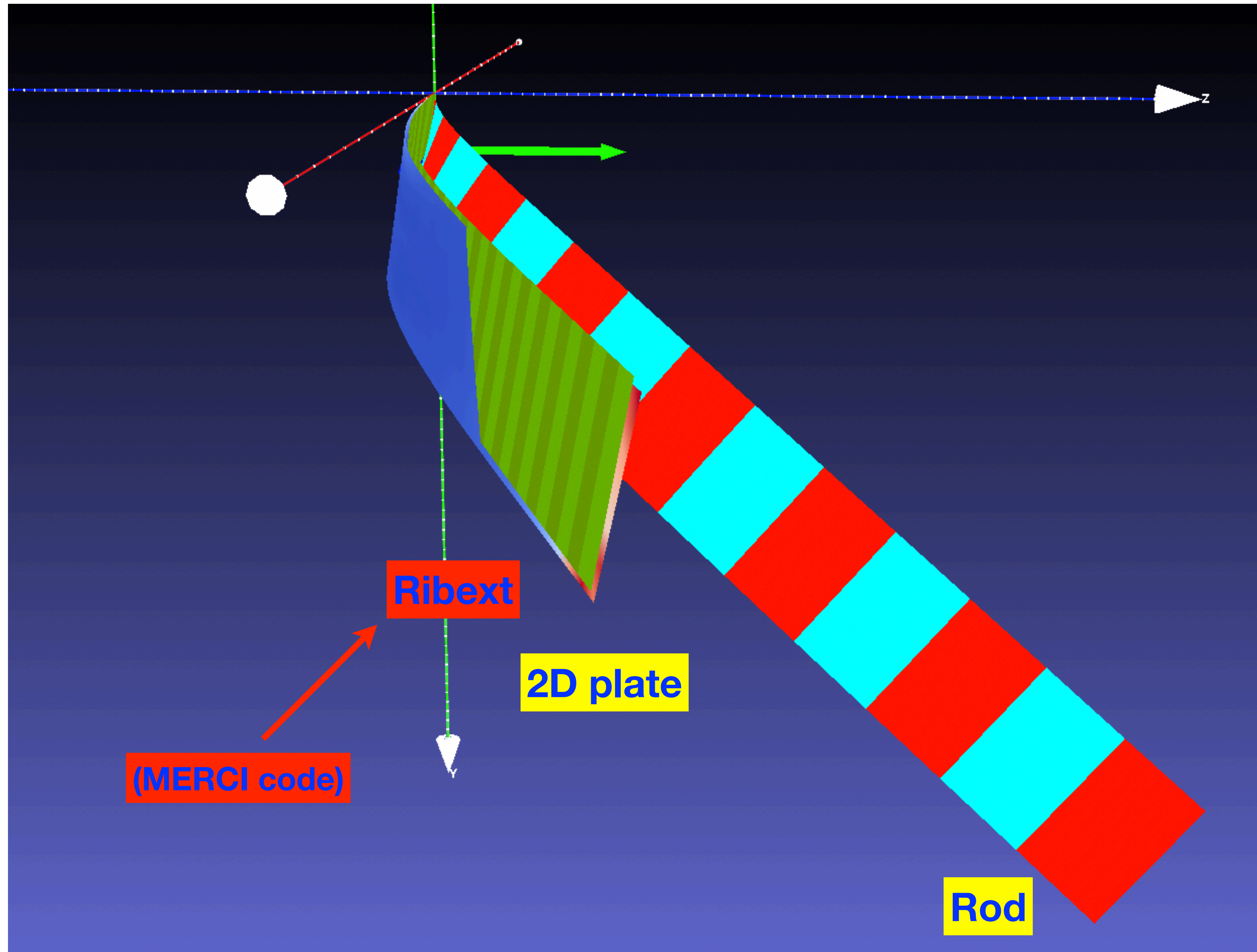

$$\eta(0) = 0$$

Lateral Torsional Buckling

$$w/L = 0.1$$

$$h/L = 0.001$$

$$\nu = 0.35$$

$$\Gamma = \frac{Mg}{Dw/L^2} = 20$$

$$Sh = 10$$

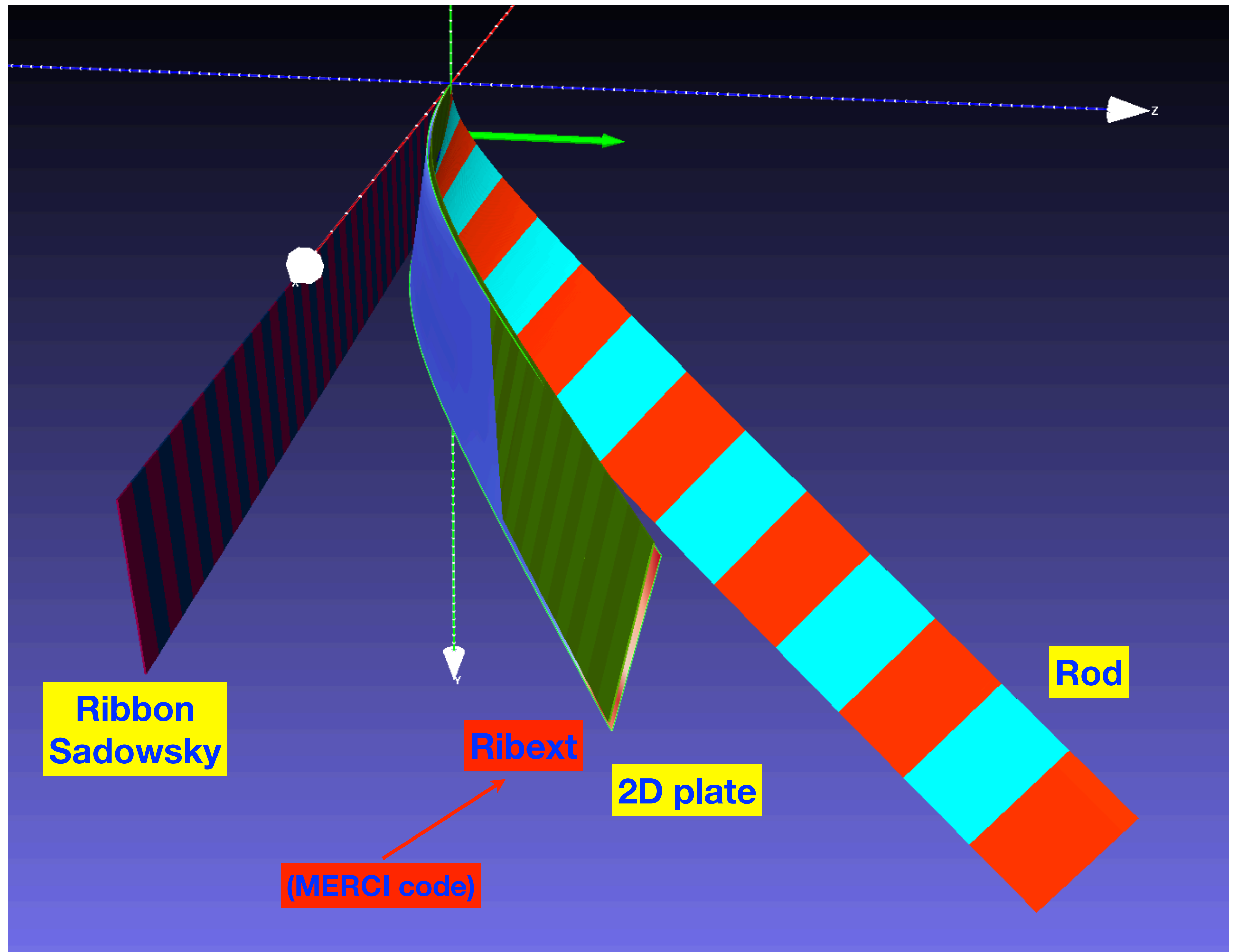

Lateral Torsional Buckling

$$\eta(0) = 0$$

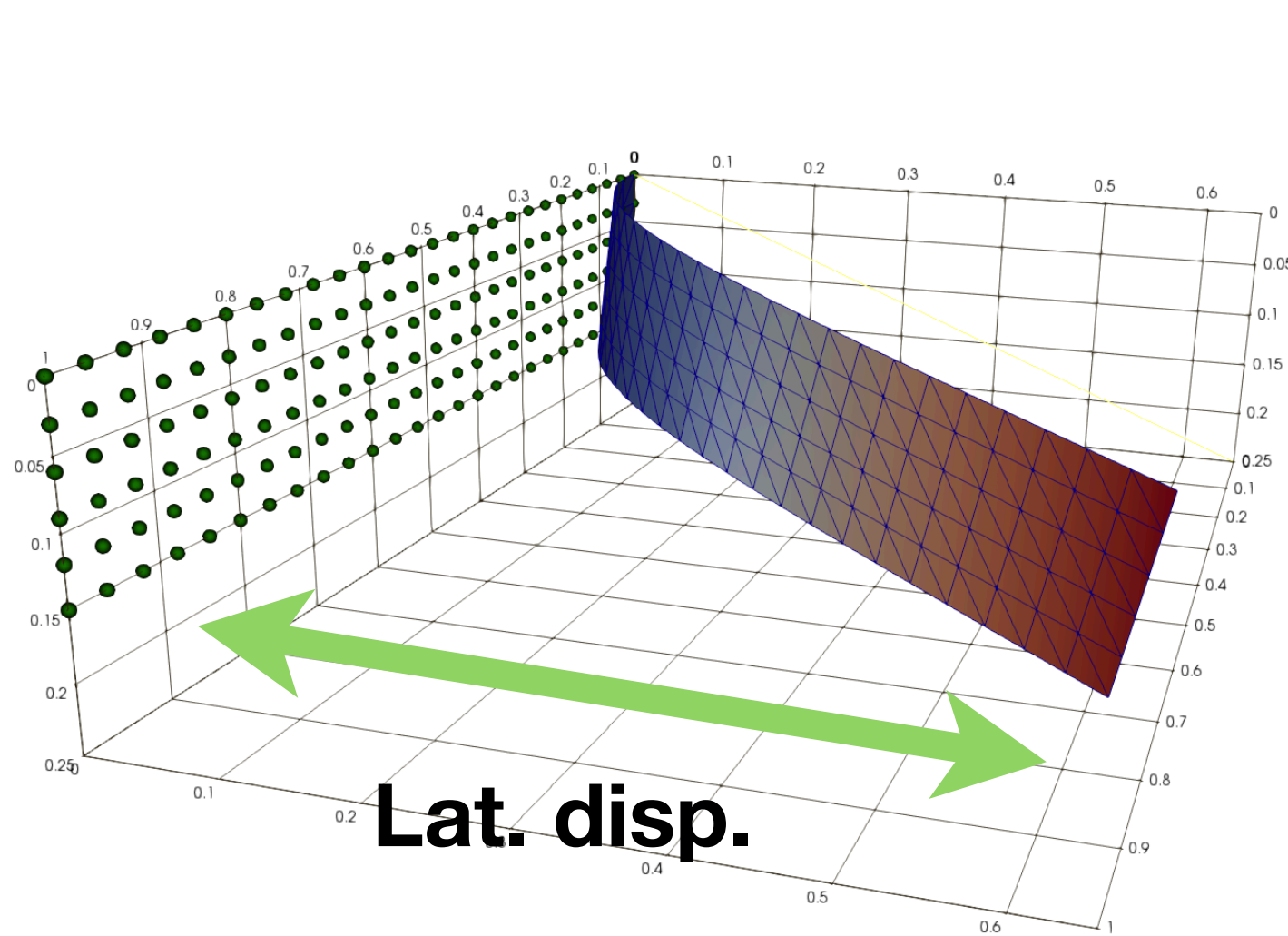

$$w/L = 0.1$$

$$h/L = 0.001$$

$$\nu = 0.35$$

$$Sh = 10$$

Lat. disp.

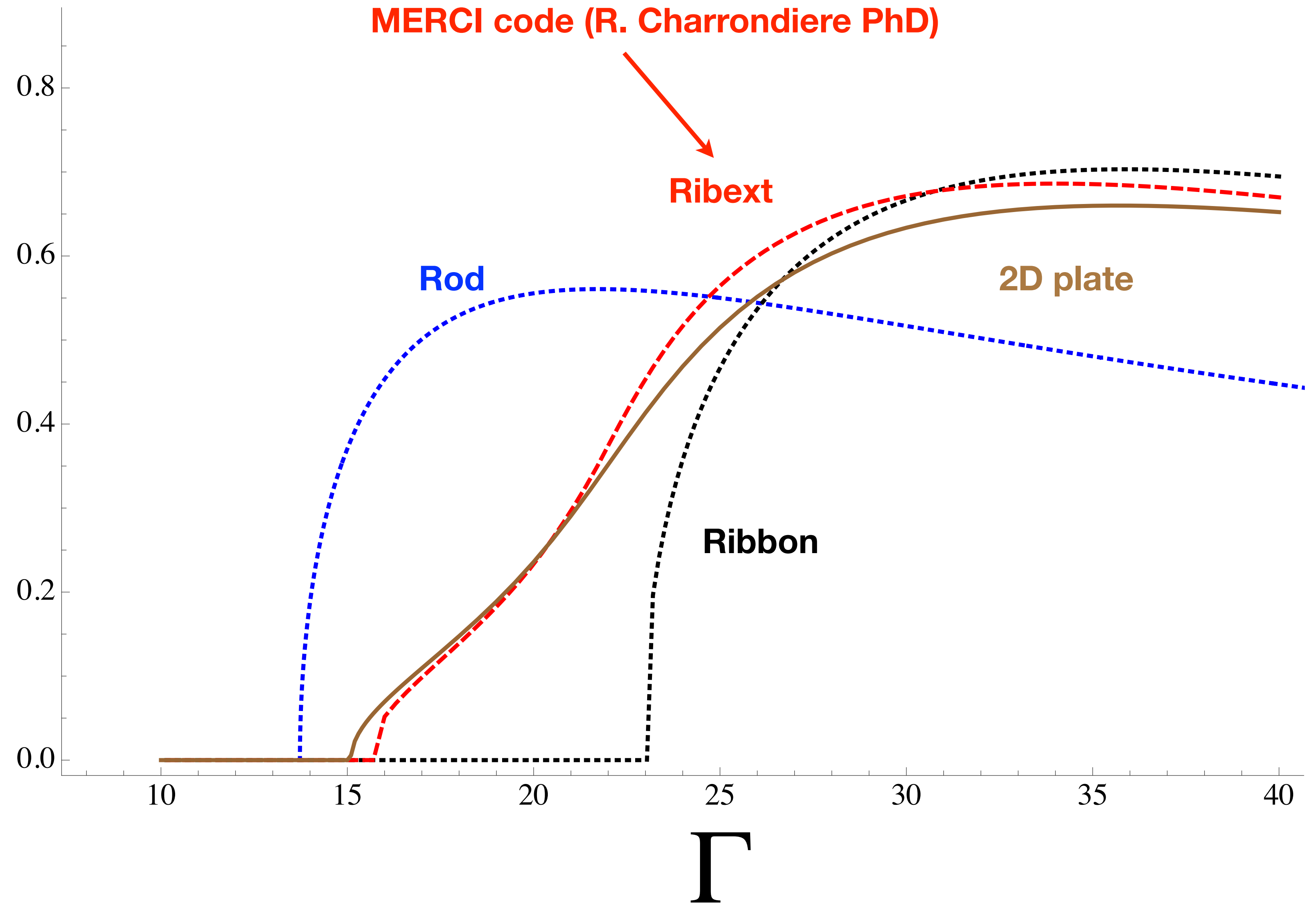

CONCLUSION

Ribbons: between (1D) rods and (2D) plates

(1D) high-order spatial discretisation

Mixed approach: curvature *and* position

Numerical implementation: MERCI code

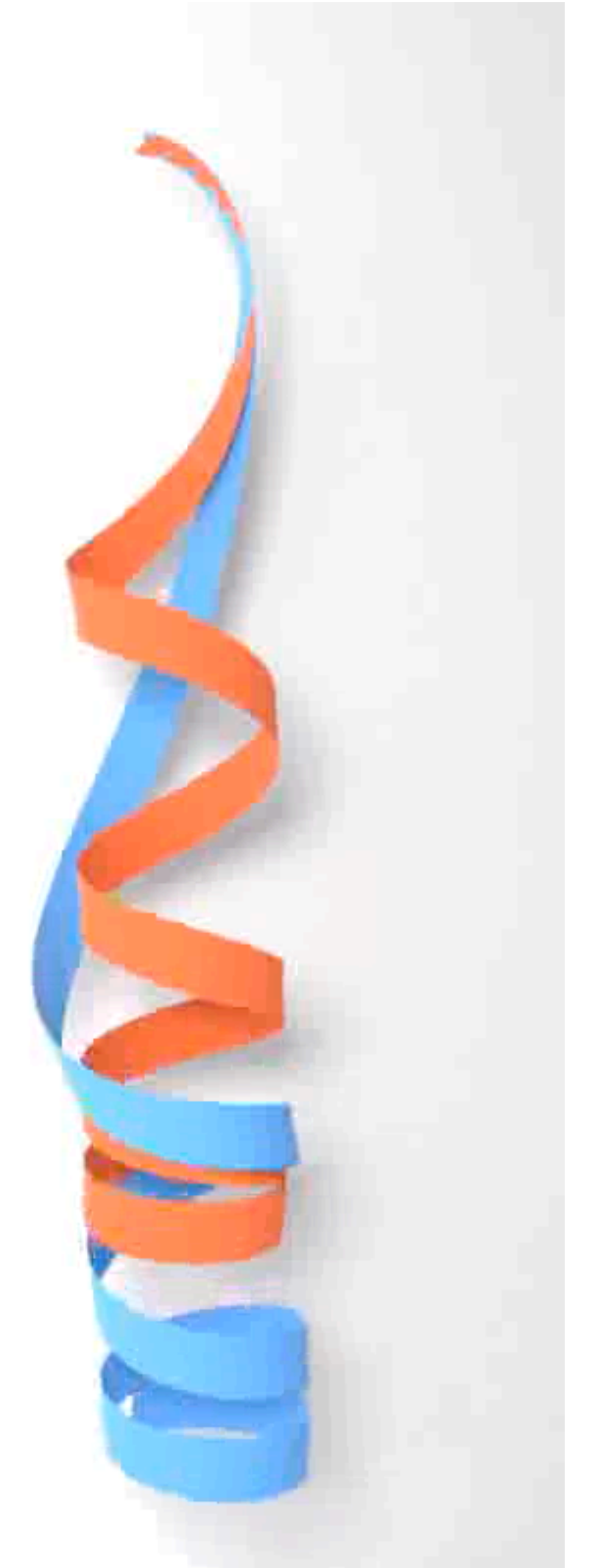
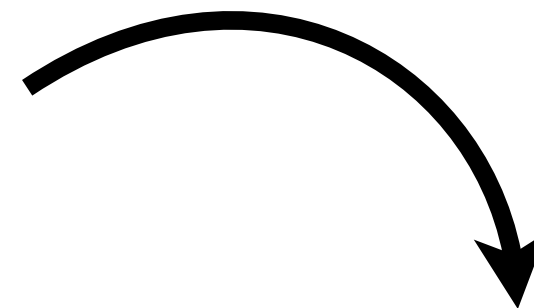

Thank you

CONTACT AND GRAVITY

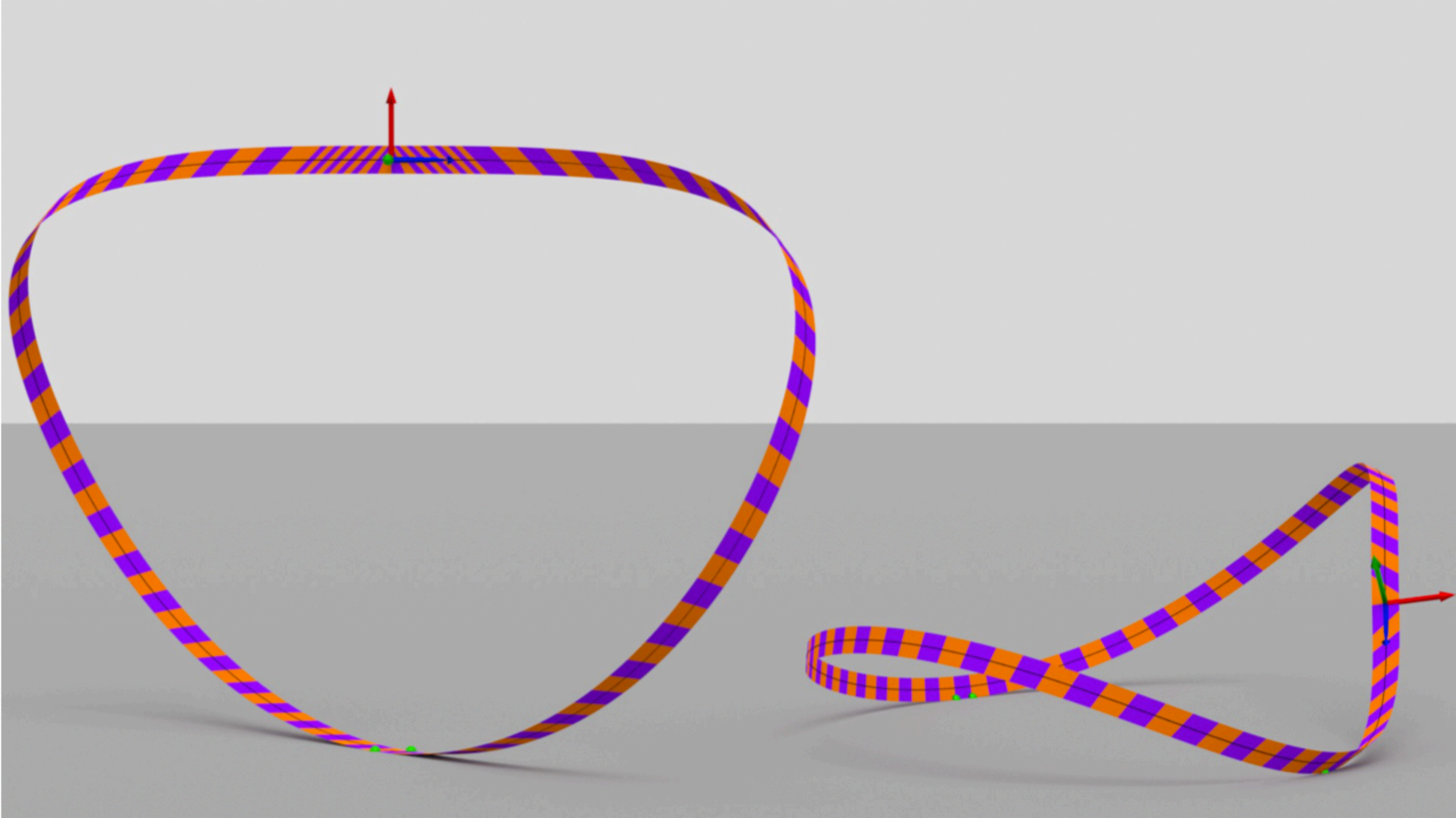

(Left) the heavy Möbius ribbon stands up on a plane, or (right) the ribbon falls on its side, both solutions being stable. Parameters are $\Gamma = 0.1$ and $\frac{w}{L} = 0.01$.

SUPER HELICES, SUPER CLOTHOIDS, AND DISCRETE ELASTIC RODS

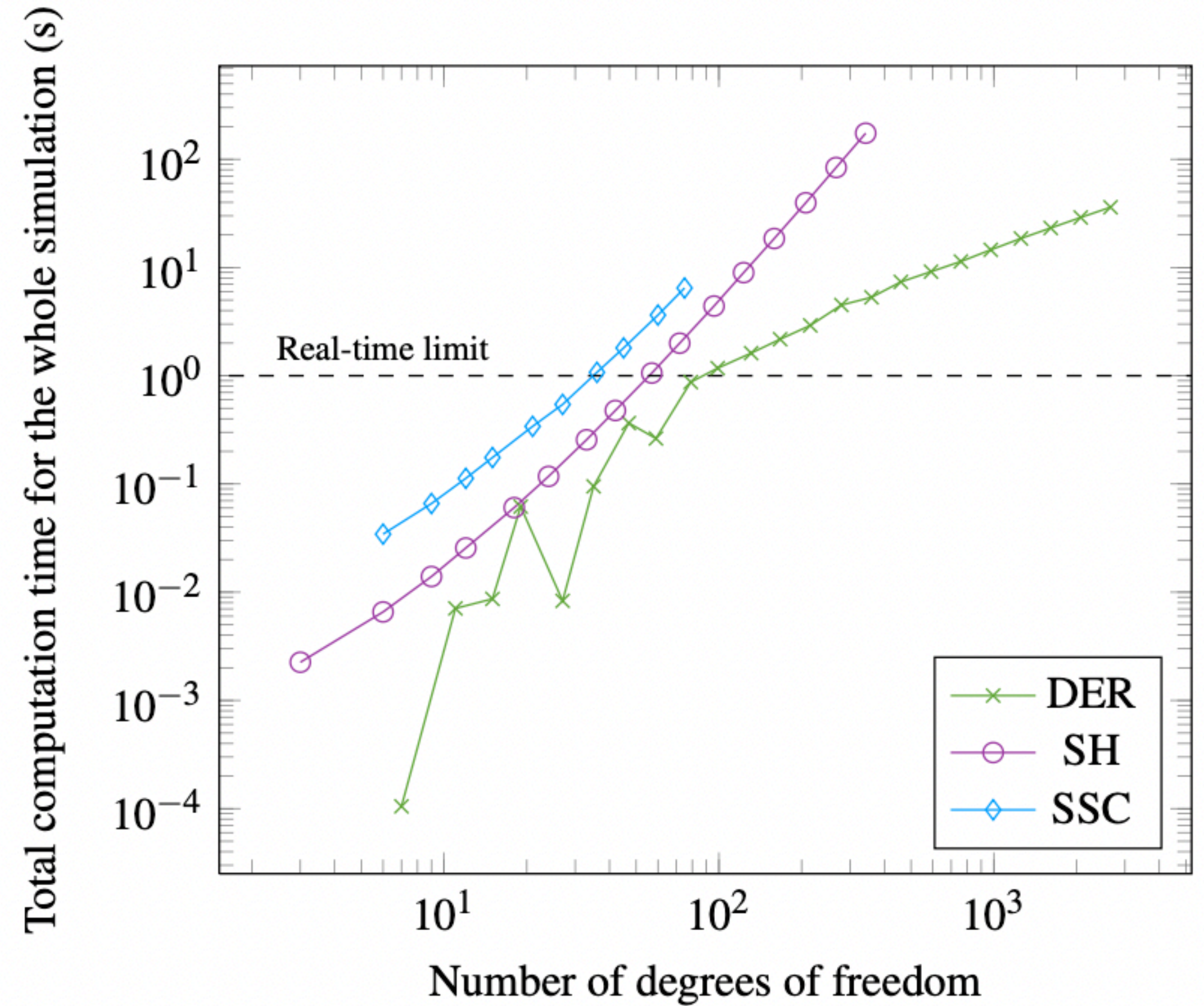
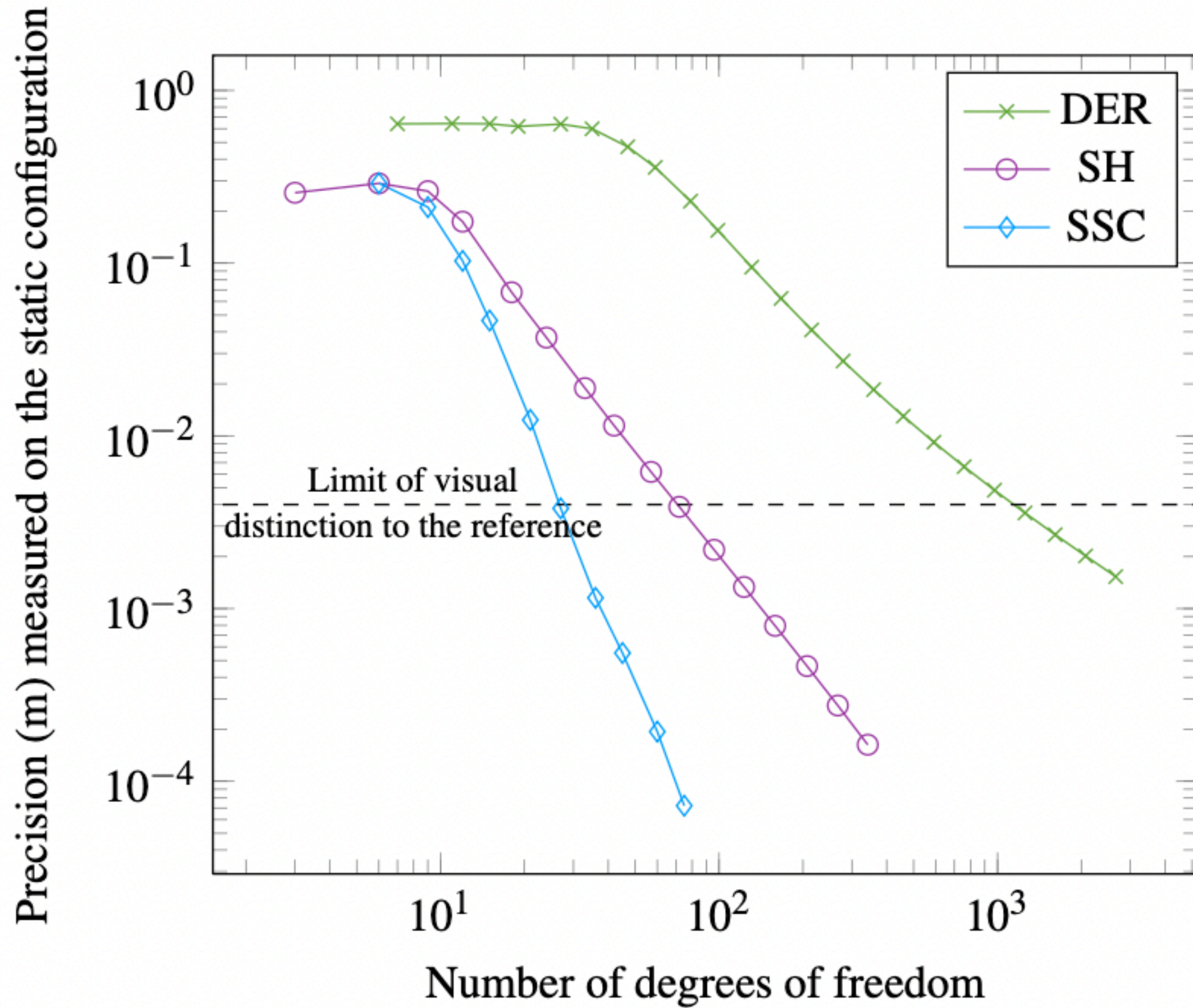

Bertails et al 2006, Casati+Bertails 2013

Up to now: Inextensible Ribbon models

plate theory: extension is expensive

hypothesis: no extension at all

==> equilibrium: developable surface

==> presence of lines on the surface

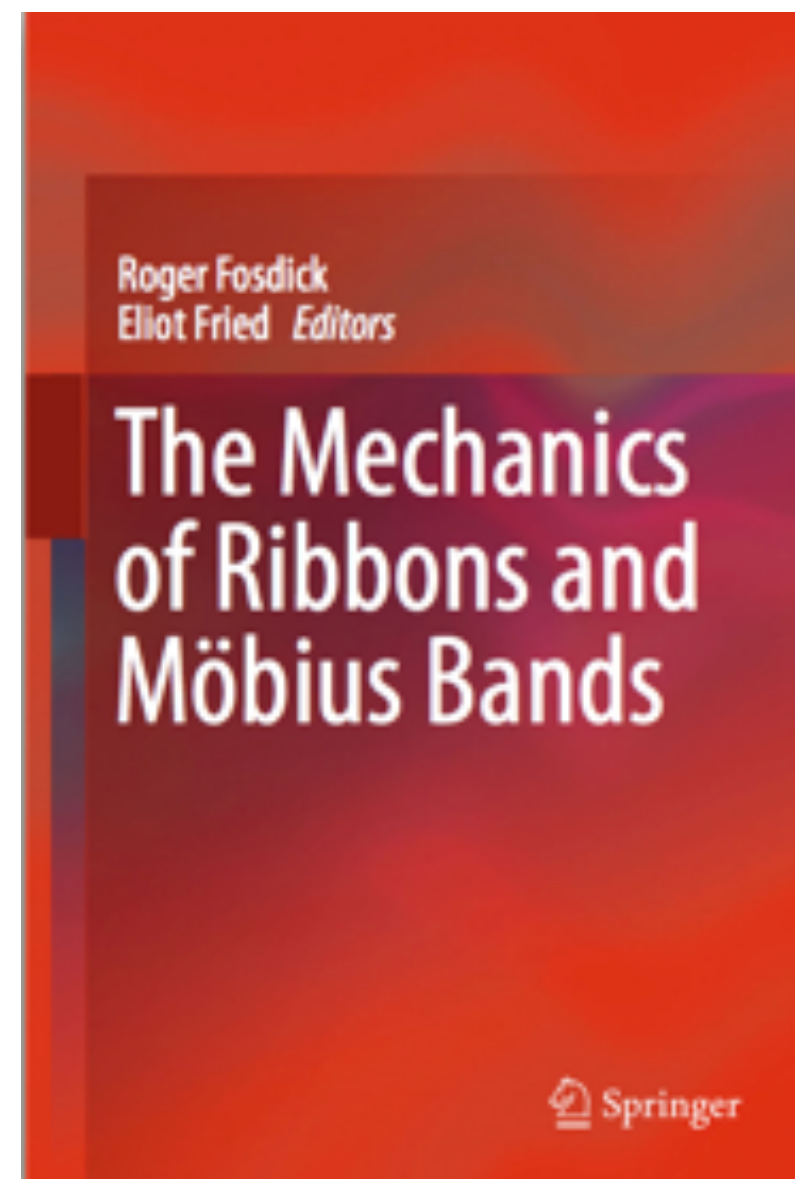

1929 M. Sadowsky

1962 W. Wunderlich

2007 Starostin+Heijden

2015 Journal of Elasticity
special issue edited by
R. Fosdick & E. Fried

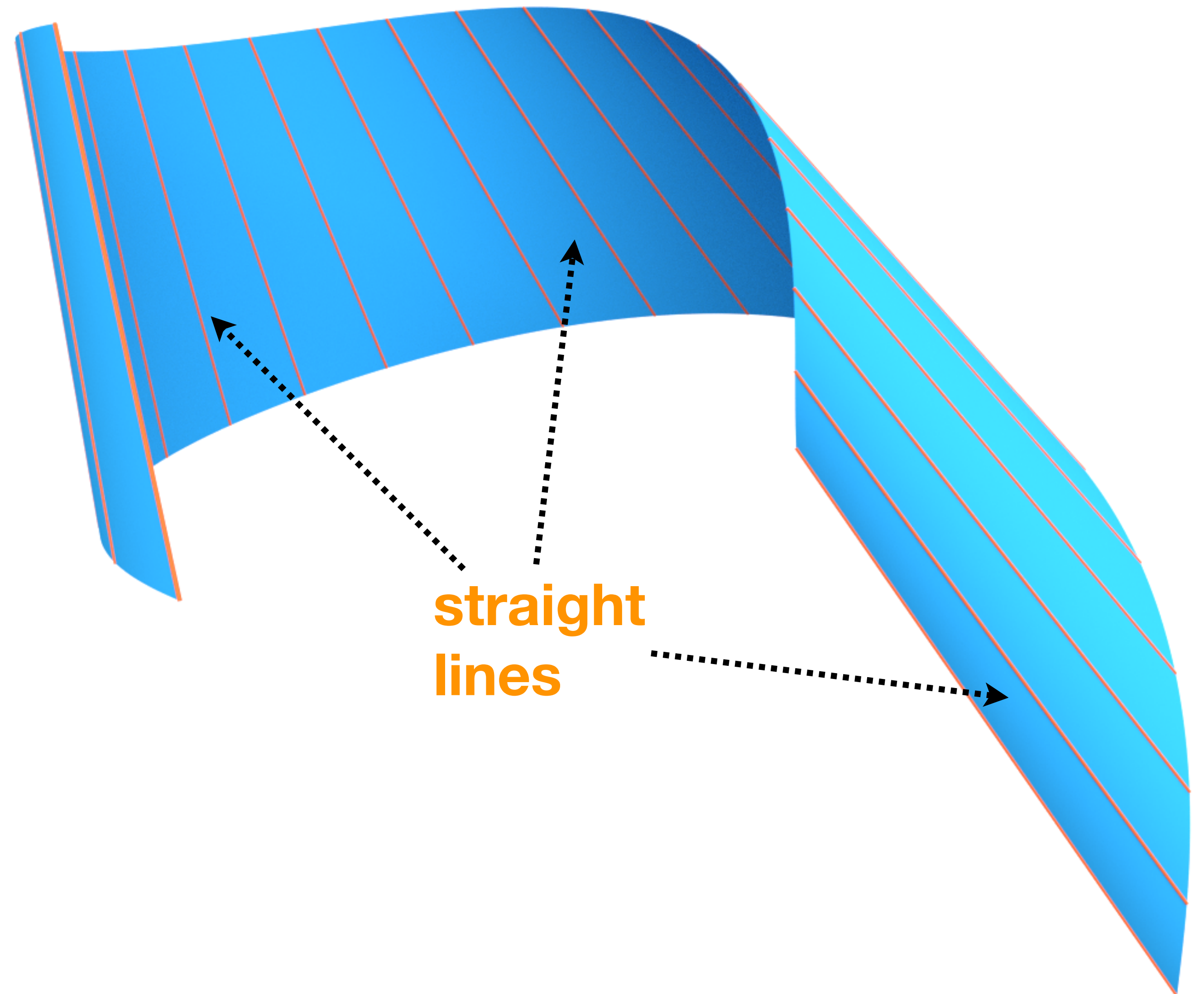

The Ribext model: limits

$$F(\kappa_1 \kappa_3) = \frac{1}{2} EI_1 \left[\kappa_1^2 + \frac{2}{1+\nu} \kappa_3^2 + \frac{(\nu \kappa_1^2 + \kappa_3^2)^2}{(1-\nu^2) \kappa_1^2} \psi(\mu[\kappa_1]) \right] \quad \text{with} \quad \psi(\mu) = 1 - \frac{2}{\sqrt{\mu/2}} \frac{\cosh \sqrt{\mu/2} - \cos \sqrt{\mu/2}}{\sinh \sqrt{\mu/2} + \sin \sqrt{\mu/2}}$$

$$\mu \ll 1 \quad \psi \rightarrow 0 \quad \text{Rod} \quad F(\kappa_1 \kappa_3) = \frac{1}{2} EI_1 \kappa_1^2 + \frac{1}{2} \frac{2EI_1}{1+\nu} \kappa_3^2 \quad \text{Kirchhoff}$$

$$\mu \gg 1 \quad \psi \rightarrow 1 \quad \text{Ribbon} \quad F(\kappa_1 \kappa_3) = \frac{1}{2} \frac{EI_1}{1-\nu^2} \frac{(\kappa_1^2 + \kappa_3^2)^2}{\kappa_1^2} \quad \text{Sadowsky}$$

with $\mu[\kappa_1] = \sqrt{12(1-\nu^2)} \frac{w^2}{Lh} \kappa_1 L$ depends on the equilibrium solution !!

Shield number

The Ribext model: limits

$$F(\kappa_1 \kappa_3) = \frac{1}{2} EI_1 \left[\kappa_1^2 + \frac{2}{1 + \nu} \kappa_3^2 + \frac{(\nu \kappa_1^2 + \kappa_3^2)^2}{(1 - \nu^2) \kappa_1^2} \psi(\mu[\kappa_1]) \right]$$

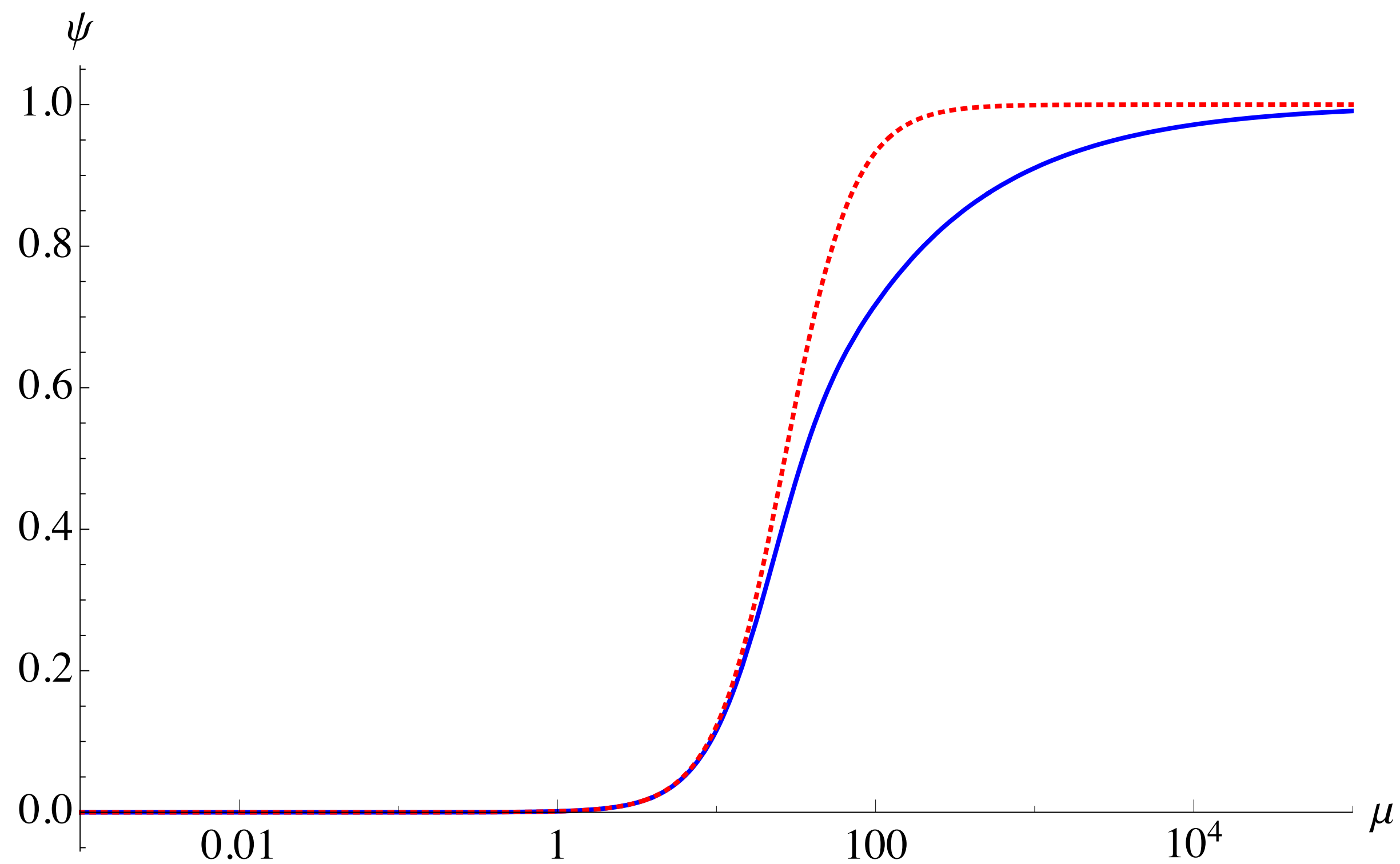

$$\psi(\mu) = 1 - \frac{2}{\sqrt{\mu/2}} \frac{\cosh \sqrt{\mu/2} - \cos \sqrt{\mu/2}}{\sinh \sqrt{\mu/2} + \sin \sqrt{\mu/2}}$$

$$\psi(\mu) = \frac{\mu^2}{720 + \mu^2} \quad \text{Padé approximant}$$

with $\mu[\kappa_1] = \sqrt{12(1 - \nu^2)} \left(\frac{w^2}{Lh} \right) \kappa_1 L$

Shield
number

Sano PRL 2019