



**HAL**  
open science

## Design and implementation of the Luenberger observer for estimating the voltage response of a PEM electrolyzer during supply current variations

Ángel Hernández-Gómez, Diego Langarica-Cordoba, Panfilo R Martinez-Rodriguez, Hernán González-Aguilar, Damien Guilbert, Belem Saldivar

### ► To cite this version:

Ángel Hernández-Gómez, Diego Langarica-Cordoba, Panfilo R Martinez-Rodriguez, Hernán González-Aguilar, Damien Guilbert, et al.. Design and implementation of the Luenberger observer for estimating the voltage response of a PEM electrolyzer during supply current variations. IEEE Access, 2024, 10.1109/ACCESS.2023.0322000 . hal-04576877

**HAL Id: hal-04576877**

**<https://hal.science/hal-04576877>**

Submitted on 15 May 2024

**HAL** is a multi-disciplinary open access archive for the deposit and dissemination of scientific research documents, whether they are published or not. The documents may come from teaching and research institutions in France or abroad, or from public or private research centers.

L'archive ouverte pluridisciplinaire **HAL**, est destinée au dépôt et à la diffusion de documents scientifiques de niveau recherche, publiés ou non, émanant des établissements d'enseignement et de recherche français ou étrangers, des laboratoires publics ou privés.



Distributed under a Creative Commons Attribution 4.0 International License

Date of publication xxxx 00, 0000, date of current version xxxx 00, 0000.

Digital Object Identifier 10.1109/ACCESS.2023.0322000

# Design and implementation of the Luenberger observer for estimating the voltage response of a PEM electrolyzer during supply current variations

Ángel Hernández-Gómez<sup>1</sup>, Diego Langarica-Cordoba<sup>1</sup>, (Senior member, IEEE), Panfilo R. Martínez-Rodríguez<sup>1</sup>, (Senior member, IEEE), Hernán González-Aguilar<sup>1</sup>, Damien Guilbert<sup>2</sup>, (Member, IEEE), and Belem Saldivar<sup>3</sup>

<sup>1</sup>School of Sciences, Universidad Autónoma de San Luis Potosí (UASLP), San Luis Potosí, 78295, San Luis Potosí, Mexico (e-mail: angel.hernandez@uaslp.mx)

<sup>2</sup>Université Le Havre Normandie, GREAH, 76600 Le Havre, France (e-mail: damien.guilbert@univ-lehavre.fr)

<sup>3</sup>Department of Automatic Control, CINVESTAV-IPN, Av. Instituto Politécnico Nacional 2508, Mexico City 07360, Mexico (e-mail: belem.saldivar@cinvestav.mx)

Corresponding author: Belem Saldivar (e-mail: belem.saldivar@cinvestav.mx).

“This work has been supported by Consejo Nacional de Ciencia y Tecnología (CONACYT) Mexico.”

**ABSTRACT** Equivalent electrical circuits (ECM) have proven to be effective in modeling the dynamic behavior of proton exchange membrane (PEM) electrolyzer voltage response. They are a valuable tool for studying the interactions between power electronics and PEM electrolyzers during dynamic operating conditions. Generally, the ECM takes into consideration the activation over-voltage that is present at both the anode and the cathode for the dynamic part of the model. Therefore, the monitoring of the ECM activation over-voltage is an important issue for the correct modeling of the PEM electrolyzer voltage. However, voltage sensors for this over-voltage are expensive and the reported observers of the PEM electrolyzer activation over-voltage are scarce and have not been validated over a sufficiently long time. This work aims at overcoming these drawbacks by proposing the use of a Luenberger observer to accurately estimate the activation over-voltage using an ECM. Based on this proposal, it is possible to build a device capable of emulating the electrolyzer voltage efficiently. Furthermore, a stability analysis of the observable system is provided to ensure its performance throughout the experiment period. Statistical results, based on experimental voltage data from a PEM electrolyzer QL-300, demonstrate the high accuracy and performance of the Luenberger observer under continuous changes in input currents, which demonstrates its robustness.

**INDEX TERMS** Electronic circuit model, Luenberger observer, PEM electrolyzer, Stability analysis, Voltage behavior.

## I. INTRODUCTION

**E**LECTROLYZERS have demonstrated their importance in the production of green hydrogen from environmentally friendly power sources, which is considered one of the main fuels to meet the energy demand of the coming years [1], [2]. The basic operation of an electrolyzer is the production of highly pure hydrogen through the process of water electrolysis [3]. Despite the different technologies developed and reported in the literature for electrolyzers (i.e., solid oxide, anion exchange membrane, alkaline and proton exchange membrane (PEM)), only alkaline and PEM electrolyzers have reached the commercial stage. Between these two technologies, PEM electrolyzers have evidenced to have a better response when coupled with renewable energies due to their operational flexibility [4].

Mathematical modeling of the PEM electrolyzer that efficiently describes the behavior of its internal and external processes, has largely contributed to the development of the PEM electrolyzer technology. Furthermore, with these mathematical models, it is possible to design controllers, failure analysis, energy management, and optimization of the PEM electrolyzer system [5]–[9]. Mathematical models of PEM electrolyzers are classified as analytical, empirical, and mechanistic. Commonly, analytical models consider the performance of the electrolyzer to determine the behavior of the main variables that influence it. Empirical models use experimental data to determine system parameters. However, a disadvantage of these models is that they are limited to a specific PEM electrolyzer. Mechanistic models are more complex compared to the other two types of modeling since

they use differential or algebraic equations to perform highly reliable simulations of the phenomena that occur in the electrolyzer. It is worth mentioning that the time to perform the simulations of the mechanistic models is considerable due to the extensive calculations [10].

Dynamic models, which belong to the class of mechanistic models, are useful to describe systems in real-time, besides, from these models, control theory can be applied [11]. The equivalent electronic circuit model (ECM), which belongs to the dynamic models, allows modeling the PEM electrolyzer voltage response during dynamic operating conditions [12]. Usually, the ECM takes into account the over-voltages that occur within the PEM electrolyzer [13], [14]. Furthermore, these over-voltages can be classified as ohmic, activation, and concentration [15]. In particular, the voltage responses of the PEM electrolyzer take place in the activation over-voltage [16]. Therefore, to efficiently reproduce the voltage of a PEM electrolyzer (to build a voltage emulator based on an ECM), it is important to be able to observe the dynamic behavior of the activation over-voltage [17]. To carry out this task, voltage sensors can be used, which are usually expensive depending on the measurement accuracy. Also, it is possible to replace the measurements of the voltage sensors with the estimations of an observer, which only depend on the input and output signals [18]. Different types of observers have been applied to different research fields, such as PEM fuel cells [19], [20], batteries [21], and underactuated quadrotors [22], [23]. Table 1 shows examples of observers recently applied to different research fields and their details. However, observers for the PEM electrolyzer activation over-voltage are scarce and have not been implemented during a long enough time window [24]. For this reason, the development of observers for PEM electrolyzers is important for the study of responses to dynamic oscillations in the voltage.

Due to the importance of observers for the PEM electrolyzer voltage, this work aims at implementing the Luenberger observer in an ECM since this observer has proven to be practical and robust for linear observable systems [32]. As mentioned in [33], for less complex linear systems, the Luenberger observer is the best choice among other techniques such as Bayesian estimators or AI-based observers, as it provides a valid estimate of the system state without requiring complex computational methods that are usually time-consuming or difficult to implement.

The main characteristics and contributions of the proposed observer in this work are presented below.

- The observability and stability of the system were demonstrated to ensure the effectiveness of the observer throughout the experimental test (4000 s).
- A comparison of the observer with experimental data under constant disturbances in the input current (square wave function at different periods using dSPACE controller board) from a PEM electrolyzer QL-300 of Shandong Saikesaisi Hydrogen Energy Co was made. This comparison validated the performance and robustness of

TABLE 1. Examples of observers applied to research fields.

Reference	Observer	Field	Application
[21]	Nonlinear	Batteries	Active species concentrations
[22]	Extended state	Underactuated quadrotor	Helical trajectory tracking
[23]	Luenberger	Underactuated quadrotor	Helical trajectory tracking
[24]	Luenberger	PEM electrolyzer	Activation over-voltage
[25]	Nonlinear Distributed Parameters	PEM fuel cell	Internal states
[26]	Extended state	PEM fuel cell	Oxygen excess ratio
[27]	Kalman filter	Batteries	state of charge
[28]	Multi-objective nonlinear	Batteries	Fault detection
[29]	Bayesian	Natural daylight	Hue perception
[30]	Impulsive	Wind energy	Flux detection
[31]	Event-triggered impulsive	Disturbed states and disturbed outputs	State of DC microgrids
The present paper	Luenberger	PEM electrolyzer	Activation over-voltage

the observer of the activation voltage (i.e., statistical tests were applied).

- It is possible to build a device that efficiently emulates the PEM electrolyzer voltage by implementing the proposed observer with the ECM design of this work.

The rest of the work is structured as follows: after discussing the state-of-the-art and motivations in the introduction, Section II presents a detailed description of the experimental platform. In Section III, the description of an ECM for estimating the PEM electrolyzer voltage is shown. Besides, in this section, the design of the Luenberger observer and the stability analysis of the observable system are provided. Subsequently, in Section IV, the simulations of the estimations from the observer and the discussion of this work are shown. Finally, in Section V, the conclusion is presented.

## II. EXPERIMENTAL TEST SET-UP

### A. PEM ELECTROLYZER BASIC OPERATION

To carry out electrolysis, the PEM electrolyzer generally operates with an anode, a cathode, a PEM (usually Nafion), and a DC power source. Each part of the PEM electrolyzer

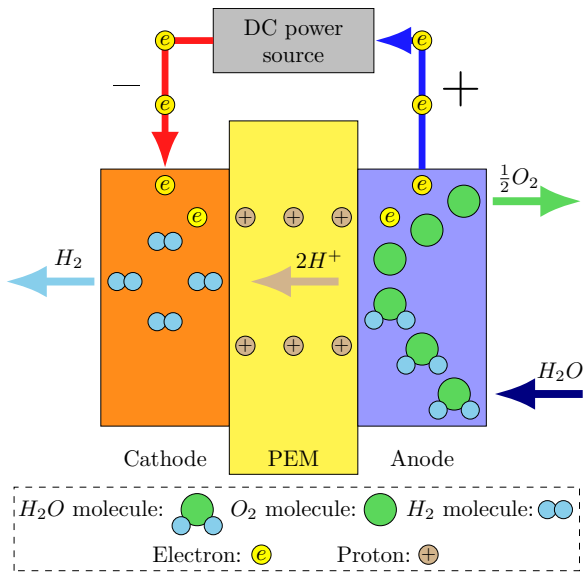
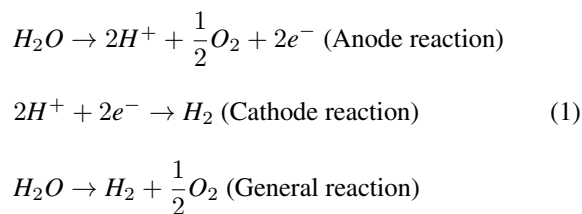


FIGURE 1. PEM electrolyzer basic operation.

system serves a fundamental purpose: at the anode, oxygen, electrons, and protons are produced; the produced protons pass to the cathode through the PEM; the external circuit connected to the DC power source flows the electrons from the anode to the cathode; hydrogen is produced at the cathode by combining protons with electrons [34], [35], see Figure 1. The reactions in the PEM electrolyzer are presented in (1).



The PEM electrolyzer is a promising technology despite being less efficient than the alkaline electrolyzer due to its wide operating range, high current densities ( $2 A \cdot cm^{-2}$ ), fast response time, and good performance when combined with renewable energy sources. Therefore, the PEM electrolyzer can cope with fluctuations from intermittent energy sources due to its partial load [36], [37].

### B. EXPERIMENTAL DATABASE COLLECTION

The different databases were obtained from the PEM electrolyzer QL-300 of Shandong Saikesaisi Hydrogen Energy Co., Ltd. (Jinan, China). The characteristics of this electrolyzer are shown in Table 2.

To obtain reliable databases, the equipment and experimental test described below were proposed, see Figure 2.

- (1) A computer with Matlab-Simulink®.
- (2) An oscilloscope MDO34-1000 of Tektronix Company.
- (3) A PEM electrolyzer QL-300.
- (4) An electrical current sensor.

TABLE 2. PEM electrolyzer QL-300 specifications.

Parameter	Value	Unit
Hydrogen purity	$\geq 99.999$	%
Hydrogen output flow range	0–310.3	$mL \cdot min^{-1}$
Output pressure range	0.2–4	bar
Pressure stability	$< 0.01$	bar
Electrical power range	0–150	W
Operating voltage range	1.4–2.5	V
Current range	0–60	A
Cell number	1	–
Active area section	150	$cm^2$
Solid Polymer Electrolyte (SPE)	183	$\mu m$

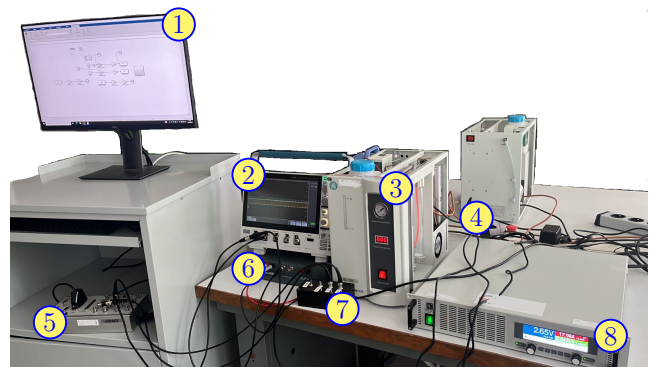
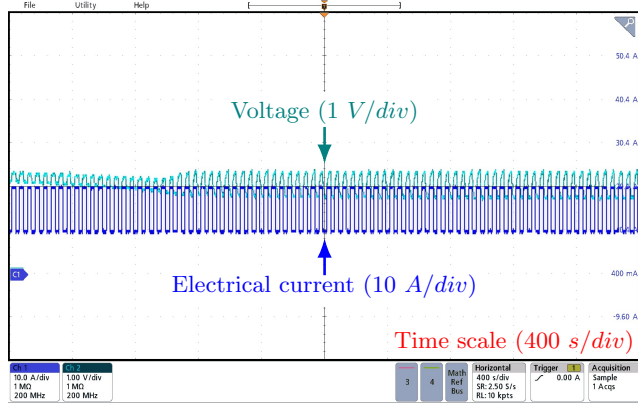


FIGURE 2. Equipment and experimental test set-up.

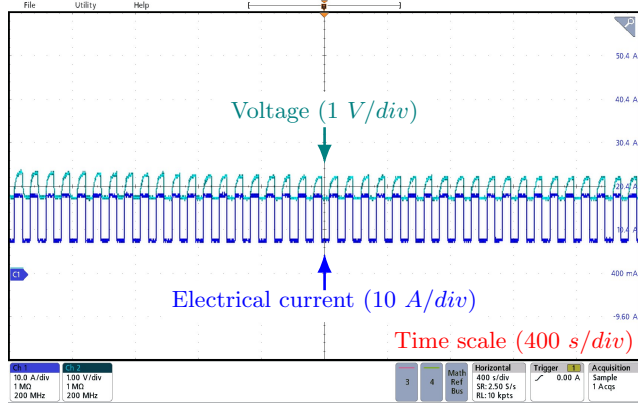
- (5) A DS1104 controller board from dSPACE Company.
- (6) A voltage sensor.
- (7) A signal converter from the dSPACE control to the DC power supply.
- (8) A DC power supply EL 9160-100 of Elektro Automatik (EA) Company.

Seven databases were taken, each data collection had a duration of 4000 seconds and the following mechanics were carried out: A square wave current signal was programmed in Matlab-Simulink® for the dSPACE controller board (i.e., minimum and maximum current values, see Table 4); the dSPACE controller sent this signal to the DC power source using a signal converter; the PEM electrolyzer was supplied by the DC power source using a square wave current signal; the database of the voltage and current sensors was projected and saved by the oscilloscope.

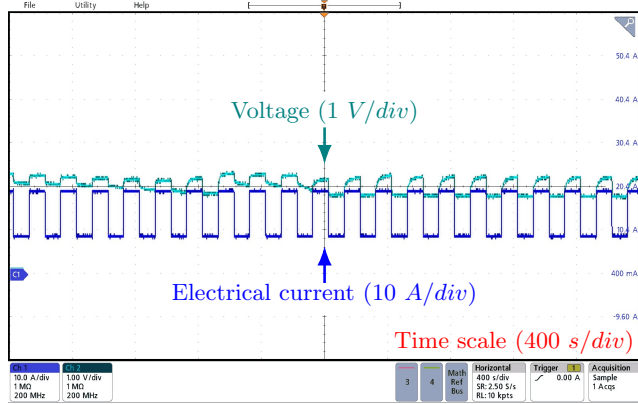
Figure 3 shows the experimental results obtained for the PEM electrolyzer voltage databases and their respective square waveform input currents. The different square waveform current inputs were generated through Matlab-Simulink and dSPACE in a minimum step range of 0 to 10 A and a maximum step range of 7 to 20 A with switching periods of 25 seconds (Figure 3.a), 50 seconds (Figure 3.b), and 100 seconds (Figure 3.c). The different voltage responses varied between 1.6 and 2.2 V for the minimum current input steps and varied between 1.9 and 2.4 V for the maximum current input steps. It is worth mentioning that the PEM electrolyzer



(a) Period of 25 seconds.



(b) Period of 50 seconds.



(c) Period of 100 seconds.

**FIGURE 3.** PEM electrolyzer voltage behavior with different input square waveform currents.

voltage is usually variable due to different factors that occur in the electrolyzer such as pressure, temperature, and the power source (renewable energy source). After obtaining the experimental databases, the Luenberger observer was developed and implemented for an ECM in Section III.

**TABLE 3.** ECM and Luenberger observer parameters.

Parameter	Description	Unit
$C_a$	Equivalent capacitor (anode)	$F$
$C_c$	Equivalent capacitor (cathode)	$F$
$e$	Estimation error	$V$
$i_{el}$	PEM electrolyzer current	$A$
$L$	Luenberger gains vector	$-$
$R_a$	Equivalent resistor (anode)	$\Omega$
$R_c$	Equivalent resistor (cathode)	$\Omega$
$R_{mem}$	Membrane resistor	$\Omega$
$u$	System input	$A$
$v_{act}$	Activation over-voltage	$V$
$v_{act,a}$	Activation over-voltage (anode)	$V$
$v_{act,c}$	Activation over-voltage (cathode)	$V$
$v_{con}$	Concentration over-voltage	$V$
$v_e$	PEM electrolyzer voltage	$V$
$v_{ini}$	DC voltage source	$V$
$v_{rev}$	Reversible over-voltage	$V$
$v_{\Omega}$	Ohmic over-voltage	$V$
$x$	System states	$V$
$x_0$	Initial condition of states	$V$
$\hat{x}$	System estimated states	$V$
$y$	System output	$V$
$\tau_a$	Electrical time constant (anode)	$s$
$\tau_c$	Electrical time constant (cathode)	$s$

### III. DESIGN OF THE LUENBERGER OBSERVER FOR THE PEM ELECTROLYZER VOLTAGE

To start this section, the description of the parameters used in the ECM and observer equations are shown in Table 3.

#### A. PEM ELECTROLYZER MATHEMATICAL MODEL

In this work, the ECM developed in [38], [39] is used. The PEM electrolyzer voltage  $v_e$  is expressed in terms of the reversible  $v_{rev}$ , ohmic  $v_{\Omega}$ , activation  $v_{act}$ , and concentration  $v_{con}$  over-voltages as follows:

$$v_e = v_{rev} + v_{\Omega} + v_{act} + v_{con}. \quad (2)$$

The ECM for (2) is defined as follows:

- A constant DC voltage source  $v_{ini}$  is used for modeling  $v_{rev}$ ,

$$v_{rev} = v_{ini}. \quad (3)$$

- A constant resistance is used for modeling the electrolyzer membrane  $R_{mem}$ , thus  $v_{\Omega}$  is expressed as:

$$v_{\Omega} = R_{mem} i_{el}, \quad (4)$$

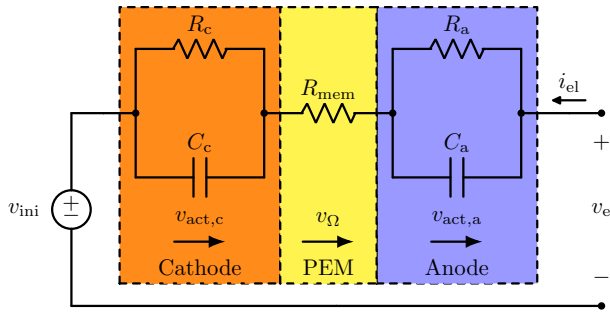
where  $i_{el}$  is the PEM electrolyzer current (A).

- Two resistor-capacitor branches are used for modeling  $v_{act}$ , one for the cathode  $v_{act,c}$  and the other for the anode  $v_{act,a}$ . Besides, it has been reported that the PEM electrolyzer voltage dynamic occurs at this over-voltage.

$$v_{act} = v_{act,c} + v_{act,a}, \quad (5)$$

where the dynamic equations are defined as:

$$\frac{dv_{act,c}}{dt} = \frac{1}{C_c} i_{el} - \frac{1}{\tau_c} v_{act,c}, \quad (6)$$



**FIGURE 4.** Equivalent electronic circuit diagram for PEM electrolyzer voltage.

$$\frac{dv_{act,a}}{dt} = \frac{1}{C_a} i_{el} - \frac{1}{\tau_a} v_{act,a}, \quad (7)$$

where  $C_c$  and  $C_a$  are the equivalent capacitors for the cathode and the anode in (F), respectively.  $\tau_c$  and  $\tau_a$  are the electrical time constants that depend strongly on the operating conditions at the cathode and the anode in (s), respectively.  $R_c$  and  $R_a$  are the resistors for the cathode and the anode in ( $\Omega$ ), respectively. Besides,  $R_c$  and  $R_a$  are calculated using  $\tau_c$  and  $\tau_a$  as follows:

$$\tau_c = C_c R_c, \quad (8)$$

$$\tau_a = C_a R_a. \quad (9)$$

- Finally,  $v_{con}$  is estimated as zero because this over-voltage has been reported to be considerably smaller than  $v_{act}$  and  $v_\Omega$  [40], [41].

So, the ECM for the PEM electrolyzer voltage is expressed as:

$$v_e(t) = v_{ini} + R_{mem} i_{el}(t) + v_{act}(t). \quad (10)$$

Figure 4 shows the equivalent electronic circuit diagram for PEM electrolyzer voltage using the electronic components that make up the ECM (i.e., one DC voltage source, two capacitors, and three resistors). Therefore, this diagram is useful for constructing a real equivalent electronic circuit to emulate the PEM electrolyzer voltage.

## B. DEVELOPMENT OF THE LUENBERGER OBSERVER

In this subsection, the equations describing the PEM electrolyzer voltage are defined as a control system, so that it is easier to structure the Luenberger observer. So, let  $y$  be defined as follows:

$$y := v_e - v_{ini}, \quad (11)$$

and

$$\begin{aligned} x_1 &:= v_{act,c}, \\ x_2 &:= v_{act,a}, \\ u &:= i_{el}. \end{aligned} \quad (12)$$

Substituting (11) and (12) in (6), (7), and (10), it is obtained:

$$\dot{x}_1 = \frac{1}{C_c} u - \frac{1}{\tau_c} x_1, \quad (13)$$

$$\dot{x}_2 = \frac{1}{C_a} u - \frac{1}{\tau_a} x_2, \quad (14)$$

$$y = R_{mem} u + x_1 + x_2. \quad (15)$$

where  $x = [x_1, x_2]^T$  with initial condition  $x_0 = [x_{1,0}, x_{2,0}]^T$ . Then, the system can be represented as:

$$\dot{x} = Ax + Bu, \quad (16)$$

where

$$A = \begin{pmatrix} A_{11} & 0 \\ 0 & A_{22} \end{pmatrix} = \begin{pmatrix} -\frac{1}{\tau_c} & 0 \\ 0 & -\frac{1}{\tau_a} \end{pmatrix} \quad (17)$$

and

$$B = \begin{pmatrix} B_1 \\ B_2 \end{pmatrix} = \begin{pmatrix} \frac{1}{C_c} \\ \frac{1}{C_a} \end{pmatrix} \quad (18)$$

And let

$$y = Cx + Du \quad (19)$$

where  $C = [1, 1]$  and  $D = R_{mem}$ .

To implement the Luenberger observer to the system defined in (16)–(19), it is necessary to prove that this system is observable. Therefore, the rank of the observability matrix defined below was calculated for  $A_{11} \neq A_{22}$  and  $\forall s \in \mathbb{C}$ ,

$$\text{rank} \begin{bmatrix} sI - A \\ C \end{bmatrix} = \text{rank} \begin{bmatrix} s - A_{11} & 0 \\ 0 & s - A_{22} \\ 1 & 1 \end{bmatrix} = 2. \quad (20)$$

By applying the observability matrix criterion [42], one can conclude that the system is observable.

Once the observability property of the system is demonstrated, the Luenberger observer is constructed. This observer is built with the original system including the estimation error to compensate for the inaccuracies in  $A$  and  $B$  [43]. In this way, the observer model is defined as:

$$\begin{aligned} \dot{\hat{x}} &= A\hat{x} + Bu + L(y - C\hat{x} - Du) \\ &= (A - LC)\hat{x} + (B - LD)u + Ly, \end{aligned} \quad (21)$$

where  $\hat{x} = [\hat{x}_1, \hat{x}_2]^T$  is the estimated state and, therefore,  $C\hat{x} + Du$  is the estimated output.  $L = [l_1, l_2]^T$  is the Luenberger vector, which is a weighting vector that continuously corrects the model output and improves the observer's behavior. The error vector  $e$  is defined as the difference between  $x$  and  $\hat{x}$ :

$$e := x - \hat{x}. \quad (22)$$

Therefore, the dynamic of vector  $e$  is given by:

$$\begin{aligned} \dot{e} &= \dot{x} - \dot{\hat{x}} \\ &= (A - LC)(x - \hat{x}) \\ &= (A - LC)e. \end{aligned} \quad (23)$$

Therefore, the eigenvalues of the matrix  $(A - LC)$  must be negative to ensure that  $e$  converges to zero and that  $x$

converges to  $\hat{x}$  exponentially. Thus, this work proposes conditions on  $L$  for which the matrix  $(A - LC)$  has negative eigenvalues. Consider the following expression to calculate the eigenvalues  $\lambda$ :

$$\det(\lambda I - A + LC) = 0. \quad (24)$$

The following expression is obtained from (24):

$$\lambda^2 + b\lambda + c = 0. \quad (25)$$

where  $b = l_1 + l_2 - A_{11} - A_{22}$  and  $c = A_{11}A_{22} - A_{11}l_2 - A_{22}l_1$ . Therefore, the eigenvalues of the matrix are given by:

$$\lambda = \frac{-b \pm \sqrt{b^2 - 4c}}{2}, \quad (26)$$

To find conditions for which the eigenvalues are negative, note that the discriminant satisfies:

$$\begin{aligned} b^2 - 4c &= (A_{22} - A_{11})^2 + 2(A_{22} - A_{11})(l_1 - l_2) \\ &\quad + (l_1 + l_2)^2 \\ &= [(A_{22} - A_{11}) + (l_1 - l_2)]^2 + (l_1 + l_2)^2 \\ &\quad - (l_1 - l_2)^2 \\ &= [(A_{22} - A_{11}) + (l_1 - l_2)]^2 + 4l_1l_2. \end{aligned}$$

Given the above developments,  $(b^2 - 4c)$  is positive as long as  $l_1$  and  $l_2$  have the same sign or if  $l_1 + l_2 > |l_1 - l_2|$ . Now, suppose both values of  $L$  are greater or equal to zero  $l_1, l_2 \geq 0$  (the case when  $l_1 = l_2 = 0$  is the original system (16), which is nominally stable). Then, as the values of  $-A_{11} = \frac{1}{\tau_c}$  and  $-A_{22} = \frac{1}{\tau_a}$  are greater than zero by hypothesis, it is obtained that  $b > 0$  and  $c > 0$ . Therefore,

$$\lambda_1 = \frac{-b - \sqrt{b^2 - 4c}}{2} < 0.$$

Besides, it holds that  $\sqrt{b^2 - 4c} < \sqrt{b^2} = |b| = b$ . Thus,  $-b + \sqrt{b^2 - 4c} < 0$  and hence

$$\lambda_2 = \frac{-b + \sqrt{b^2 - 4c}}{2} < 0.$$

Therefore, the system (23) is stable when  $l_1, l_2 \geq 0$ . For the cases when  $l_1, l_2 \leq 0$  and  $l_1 + l_2 > |l_1 - l_2|$  the restrictions that guarantee negative eigenvalues for (23) are derived below.

It is worth mentioning that case  $l_1 + l_2 > |l_1 - l_2|$  involves the following two cases:

Case 1	Case 2
$l_1 + l_2 > l_1 - l_2$	$l_1 - l_2 > -l_1 - l_2$
$l_2 > -l_2$	$l_1 > -l_1$
$2 \cdot l_2 > 0$	$2 \cdot l_1 > 0$
$l_2 > 0$	$l_1 > 0$

Now, to ensure that  $b > 0$ , let  $l_1 + l_2 > A_{11} + A_{22}$ , so that, for the cases when  $l_1, l_2 \leq 0$  and  $l_1 + l_2 > |l_1 - l_2|$ ,  $b > 0$ .

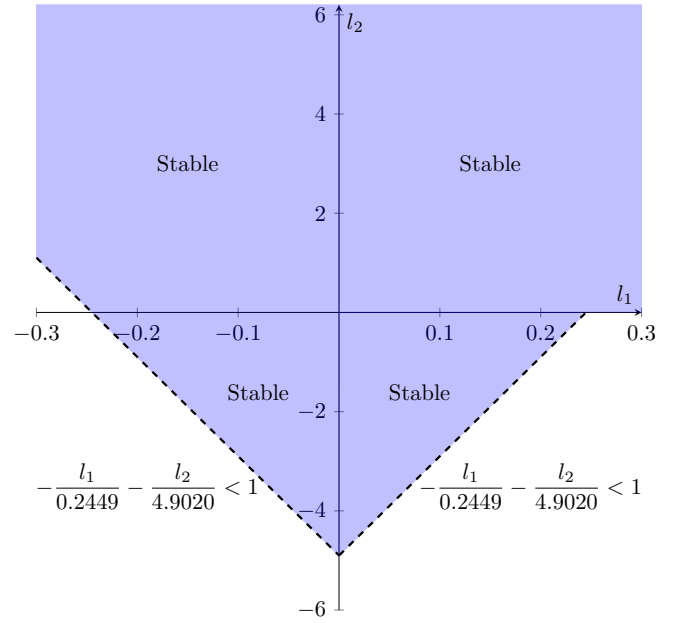


FIGURE 5. Demonstrated stable region for the system (23) using  $\tau_c = 4.0835$  and  $\tau_a = 0.2040$ .

Therefore,  $\lambda_1 < 0$ . Furthermore, to guarantee that  $c > 0$ , it is assumed that  $l_1$  and  $l_2$  satisfy  $\frac{l_1}{A_{11}} + \frac{l_2}{A_{22}} < 1$ . Thus, it is obtained that  $A_{11}l_2 + A_{22}l_1 < A_{11}A_{22}$ . Consequently,  $c > 0$ , and taking into consideration that  $b > 0$ , it holds that  $\sqrt{b^2 - 4c} < \sqrt{b^2} = |b| = b$ . Thus,  $\lambda_2 < 0$ .

Therefore, for the cases when  $l_1, l_2 \leq 0$  and  $l_1 + l_2 > |l_1 - l_2|$ , the system (23) is stable if  $l_1 + l_2 > A_{11} + A_{22}$ , and  $\frac{l_1}{A_{11}} + \frac{l_2}{A_{22}} < 1$ . Figure 5 illustrates the demonstrated stable region of the system (23) for  $\tau_c = 4.0835$  and  $\tau_a = 0.2040$  (these values were considered according to [38]).

Once the observer was determined and its stability region demonstrated, it was simulated. The simulation results of the proposed observer are shown in the next section.

## IV. RESULTS AND DISCUSSION

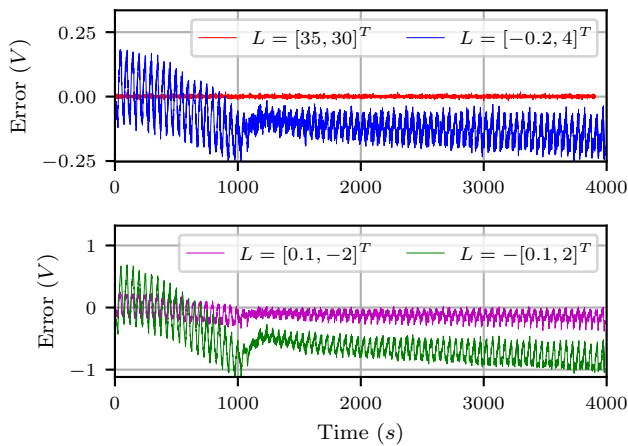
In this section, the simulation results of the observer response are presented in detail. Besides, a discussion of the outcomes is presented.

### A. SIMULATION AND VALIDATION

To carry out the simulations, the Python programming language was used (Python version: 3.8.10 for 64 bits, processor: Intel CORE i7-7700 HQ CPU, 2.80 GHz, operating system: Windows 10). The proposed observer was simulated using the parameter values  $v_{\text{ini}} = 1.43$  V,  $R_{\text{mem}} = 0.0155$   $\Omega$ , and  $C_c = C_a = 125$  F. Furthermore, as mentioned in [39], the parameters  $\tau_c$  and  $\tau_a$  are constants that depend on the input current and other relevant parameters (gas pressure and temperature that are not considered in this current work), for this reason, different values for these parameters were used depending on the database, see Table 4.

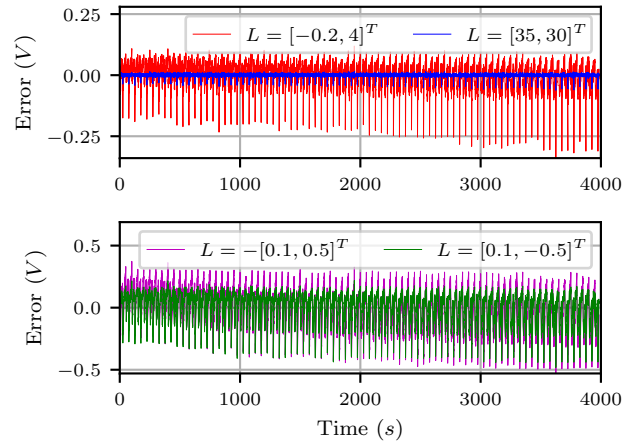
**TABLE 4.** Maximum and minimum input current  $i_{el}$  and values  $\tau_c$  and  $\tau_a$  for each database.

Database	$i_{el}$	$\tau_c$	$\tau_a$
Database 1	min = 10 A, max = 20 A	4.0835 s	0.2040 s
Database 2	min = 1 A, max = 20 A	3.4917 s	0.4819 s
Database 3	min = 5 A, max = 15 A	4.0336 s	0.6644 s
Database 4	min = 6 A, max = 16 A	3.9747 s	0.6556 s
Database 5	min = 8 A, max = 18 A	3.9822 s	0.4040 s
Database 6	min = 9 A, max = 19 A	3.7851 s	0.4321 s
Database 7	min = 2 A, max = 7 A	4.6681 s	1.5860 s

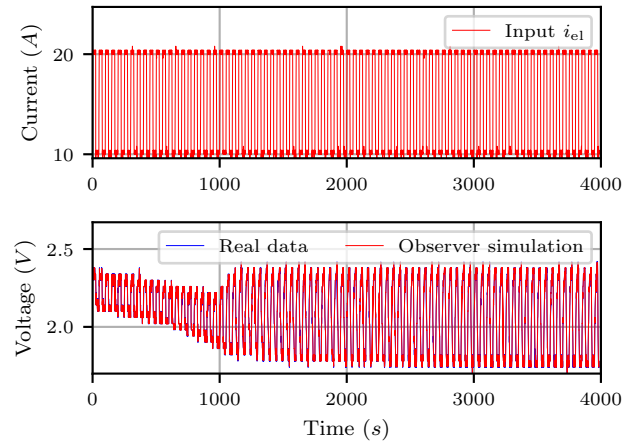


**FIGURE 6.** Observer error behavior with different values of  $L$  (stable region) for Database 1.

The behavior of the observer error under different values of  $L$  ( $l_1$  and  $l_2$  at different points of the stability region) was analyzed using Databases 1 and 2. For Database 1, the Luenberger observer obtained better performance when using  $l_1, l_2 > 0$  with a relative error of 0.075%, while in the other cases  $l_1 < 0$  and  $l_2 > 0$ ,  $l_1 > 0$  and  $l_2 < 0$ , and  $l_1, l_2 < 0$  obtained a relative errors of 3.3717%, 3.6469%, and 17.5394%, respectively. Figure 6 shows the evolution of the observer error concerning time for Database 1 and different values of  $L$ . Similarly, for Database 2, the Luenberger observer obtained a relative error of 0.0911% when using  $l_1, l_2 > 0$ , which demonstrates the effectiveness of convergence with positive values  $l_1$  and  $l_2$ . For the other different values of  $l_1 < 0$  and  $l_2 > 0$ ,  $l_1 > 0$  and  $l_2 < 0$ , and  $l_1, l_2 < 0$  obtained a relative errors of 1.1219%, 3.0287%, and 4.3968%, respectively. These relative errors obtained from Database 2 are lower compared to those obtained from Database 1 due to the different behavior of the databases. Figure 7 shows the evolution of the observer error concerning time for Database 2 and different values of  $L$ . Due to the fast convergence of the error to zero when  $l_1, l_2 > 0$ , the simulations were developed by considering  $l_1 = 35$  and  $l_2 = 30$ . It is worth mentioning that the higher the values of



**FIGURE 7.** Observer error behavior with different values of  $L$  (stable region) for Database 2.



**FIGURE 8.** Comparison of the observer and Database 1 with its respective input current  $i_{el}$ .

$l_1$  and  $l_2$ , the faster the convergence. However, computational work is more demanding due to the small step size to achieve solution iterations. For these values of  $L$ , the computational operation time for all databases varied between 3.41 and 3.95 seconds. Figure 8 shows the result of the comparison of the observer and Database 1 with its respective input current  $i_{el}$  (the dSPACE signal was programmed for an input current of min = 10 A and max = 20 A).

Figure 9 shows the observed states  $v_{act,c}$  and  $v_{act,a}$  with initial values  $v_{act,c,0} = 0.55$  V and  $v_{act,a,0} = 0.03$  V. In this case, a different behavior can be seen during the first 1000 seconds, which agrees with the voltage shown in Figure 8.

Figure 10 shows the behavior of the observer for Database 2 with its respective input current  $i_{el}$  (the dSPACE signal was programmed for an input current of min = 1 A and max = 20 A).

Figure 11 shows the observed states  $v_{act,c}$  and  $v_{act,a}$  with



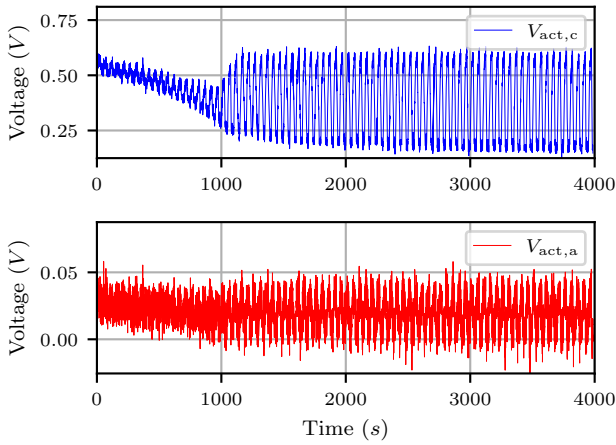


FIGURE 9. Observed states  $v_{act,c}$  and  $v_{act,a}$  for Database 1.

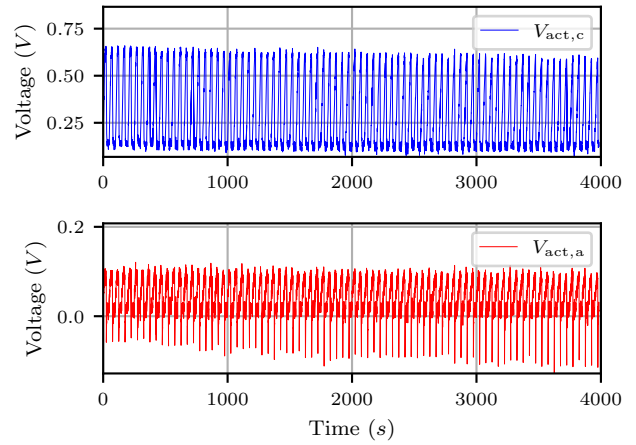


FIGURE 11. Observed states  $v_{act,c}$  and  $v_{act,a}$  for Database 2.

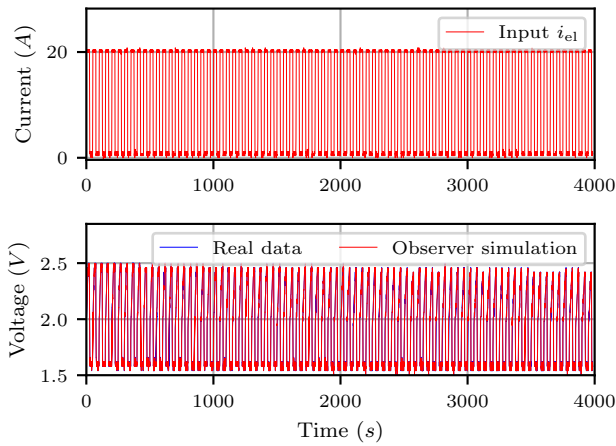


FIGURE 10. Comparison of the observer and Database 2 with its respective input current  $i_{el}$ .

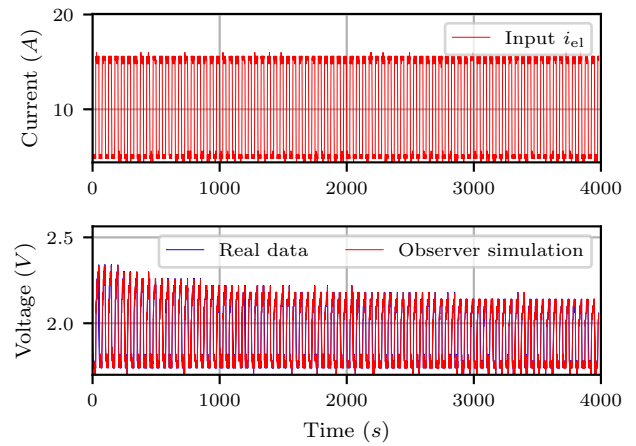


FIGURE 12. Comparison of the observer and Database 3 with its respective input current  $i_{el}$ .

initial values  $v_{act,c,0} = 0.25$  V and  $v_{act,a,0} = 0.06$  V. In this case, a regular voltage behavior can be seen during the experiment, which agrees with the voltage shown in Figure 10.

Figure 12 shows the input current  $i_{el}$  (the dSPACE signal was programmed for an input current of  $\min = 5$  A and  $\max = 15$  A) and the experimental voltage from Database 3 with its respective estimation using the Luenberger observer. Figure 13 shows the observed states  $v_{act,c}$  and  $v_{act,a}$  with initial values  $v_{act,c,0} = 0.29$  V and  $v_{act,a,0} = 0.04$  V. In addition to the high precision observed in Figure 12 between the estimated voltage and the real PEM electrolyzer voltage, the behavior of the observed states agrees with the system output, which proves the effectiveness of the proposed observer.

Figure 14 shows the result of the comparison of the observer and Database 4 with its respective input current  $i_{el}$  (the dSPACE signal was programmed for an input current of

$\min = 6$  A and  $\max = 16$  A).

Figure 15 shows the observed states  $v_{act,c}$  and  $v_{act,a}$  with initial values  $v_{act,c,0} = 0.52$  V and  $v_{act,a,0} = 0.08$  V. In this case, a different behavior is observed around the first 1400 seconds, which agrees with the voltage shown in Figure 14.

Figure 16 shows the behavior of the observer for Database 5 with its respective input current  $i_{el}$  (the dSPACE signal was programmed for an input current of  $\min = 8$  A and  $\max = 18$  A).

Figure 17 shows the observed states  $v_{act,c}$  and  $v_{act,a}$  with initial values  $v_{act,c,0} = 0.27$  V and  $v_{act,a,0} = 0.05$  V. The effectiveness of the observer is demonstrated by the high precision between the estimated voltage and the real voltage of the PEM electrolyzer shown in Figure 16 and the behavior of the observed states, which agrees with the output of the system.

Figure 18 shows the input current  $i_{el}$  (the dSPACE signal

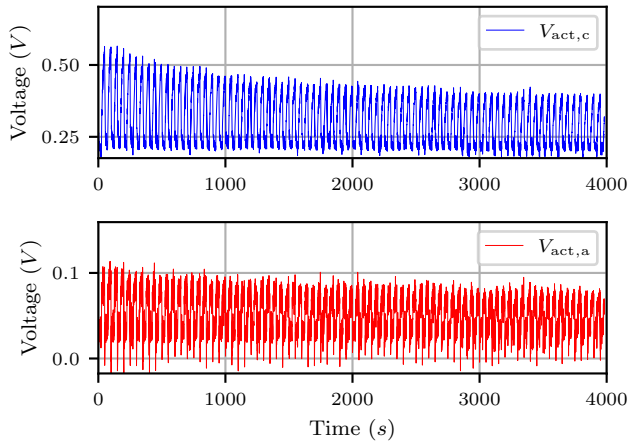


FIGURE 13. Observed states  $v_{act,c}$  and  $v_{act,a}$  for Database 3.

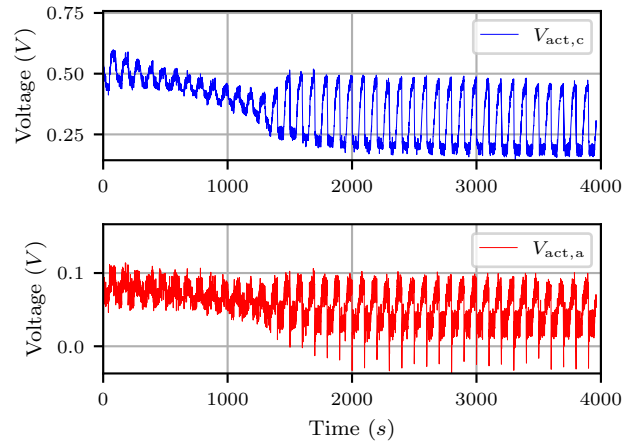


FIGURE 15. Observed states  $v_{act,c}$  and  $v_{act,a}$  for Database 4.

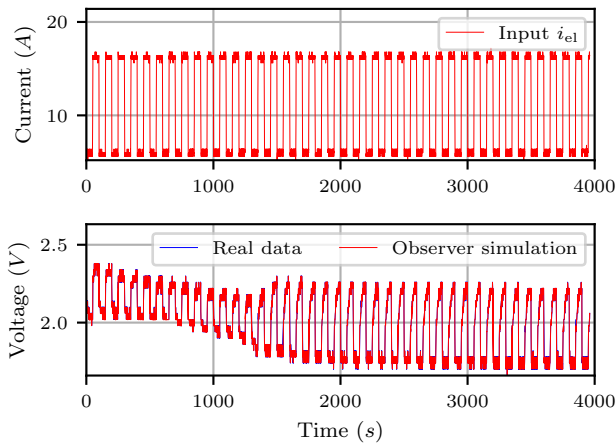


FIGURE 14. Comparison of the observer and Database 4 with its respective input current  $i_{el}$ .

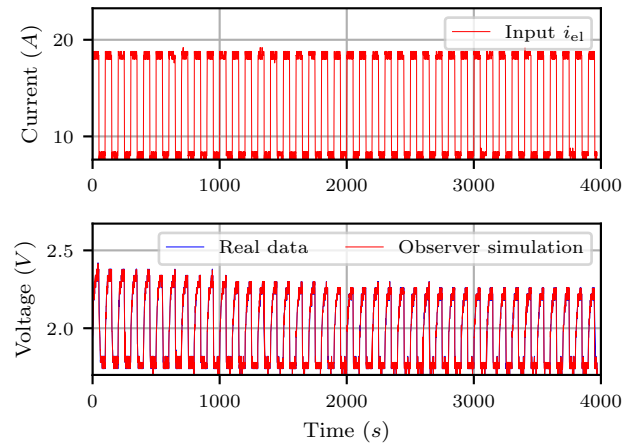


FIGURE 16. Comparison of the observer and Database 5 with its respective input current  $i_{el}$ .

was programmed for an input current of  $\min = 9$  A and  $\max = 19$  A) and the experimental voltage from Database 6 with its respective estimation using the Luenberger observer.

Figure 19 shows the observed states  $v_{act,c}$  and  $v_{act,a}$  with initial values  $v_{act,c,0} = 0.52$  V and  $v_{act,a,0} = 0.05$  V. This Database showed the most irregular behavior of all the databases. However, as can be seen in Figures 18 and 19, the high accuracy of the simulated voltage in estimating the real voltage and the behavior of the observed states demonstrate that the proposed observer is efficient and robust. Figure 20 shows the result of the comparison of the observer and Database 7 with its respective input current  $i_{el}$  (the dSPACE signal was programmed for an input current of  $\min = 2$  A and  $\max = 7$  A). Figure 21 shows the observed states  $v_{act,c}$  and  $v_{act,a}$  with initial values  $v_{act,c,0} = 0.22$  V and  $v_{act,a,0} = 0.03$  V. In this case, a regular behavior can be seen during the experiment, which agrees with the voltage shown in Figure

21.

Statistical tests were applied after observing the comparisons of the different databases with the Luenberger observer. The results of these tests are shown in the next subsection.

## B. DISCUSSION

Relative error  $E_r$ , mean error  $E_m$ , mean squared error  $MSE$ , and root mean squared error  $RMSE$  were applied to validate the effectiveness of the observer. These statistical tests are given by:

$$E_r = \left( \frac{100}{N_d} \right) \sum_{k=1}^{N_d} \left| \frac{v_{exp,k} - v_{sim,k}}{v_{exp,k}} \right|, \quad (27)$$

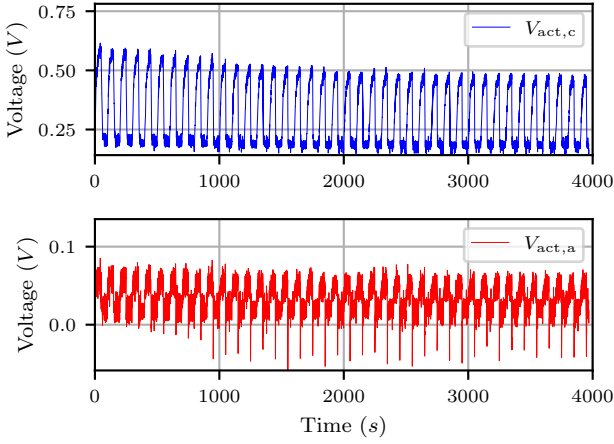


FIGURE 17. Observed states  $v_{act,c}$  and  $v_{act,a}$  for Database 5.

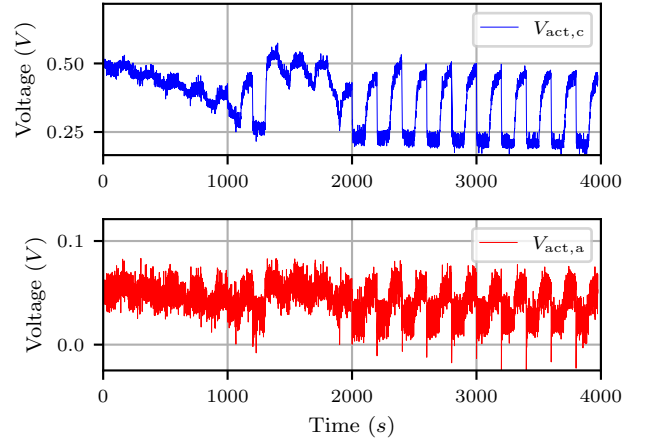


FIGURE 19. Observed states  $v_{act,c}$  and  $v_{act,a}$  for Database 6.

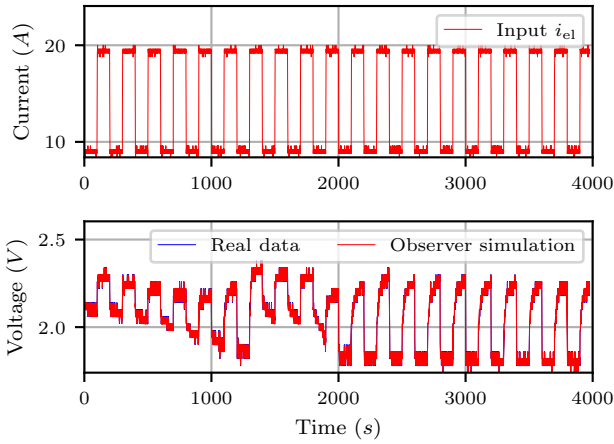


FIGURE 18. Comparison of the observer and Database 6 with its respective input current  $i_{el}$ .

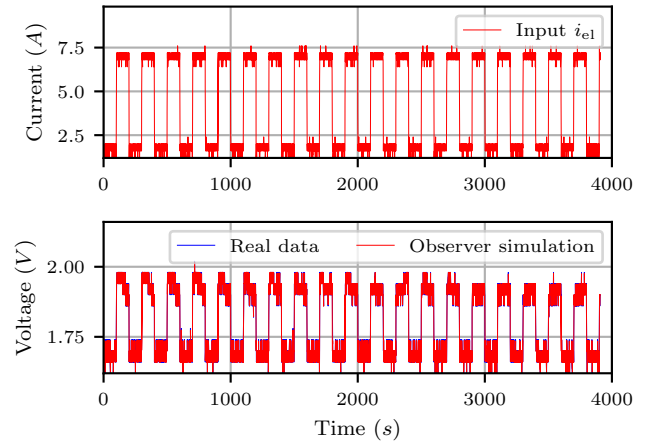


FIGURE 20. Comparison of the observer and Database 7 with its respective input current  $i_{el}$ .

$$E_m = \left( \frac{1}{N_d} \right) \sum_{k=1}^{N_d} |v_{exp,k} - v_{sim,k}|, \quad (28)$$

$$MSE = \left( \frac{1}{N_d} \right) \sum_{k=1}^{N_d} (v_{exp,k} - v_{sim,k})^2, \quad (29)$$

$$RMSE = \sqrt{MSE}, \quad (30)$$

where  $N_d$  is the number of voltage data (i.e.,  $N_d$  varied between 9904 and 9970).  $v_{exp,k}$  is the  $k$ -th voltage data measurement and  $v_{sim,k}$  is the  $k$ -th voltage data simulation. The statistical test results are shown in Table 5.

As can be seen in Table 5, the statistical results demonstrate the high accuracy of the Luenberger observer proposed for

TABLE 5. Statistical test results.

Database	$E_r$	$E_m$	$MSE$	$RMSE$
Database 1	0.0750%	0.0027 V	$1.25e^{-5} V^2$	0.0035 V
Database 2	0.0911%	0.0030 V	$2.78e^{-5} V^2$	0.0053 V
Database 3	0.0752%	0.0025 V	$1.20e^{-5} V^2$	0.0035 V
Database 4	0.0746%	0.0025 V	$1.16e^{-5} V^2$	0.0034 V
Database 5	0.0773%	0.0026 V	$1.29e^{-5} V^2$	0.0036 V
Database 6	0.0768%	0.0027 V	$1.20e^{-5} V^2$	0.0035 V
Database 7	0.0771%	0.0025 V	$1.13e^{-5} V^2$	0.0034 V

different databases. Besides, the observer showed high performance in estimating the electrolyzer voltage under continuous changes in input currents, which demonstrates its robustness. This high precision was achieved using values of  $L$  in the calculated stability region,  $l_1, l_2 > 0$ . Therefore, by using this observer it is possible to appreciate the dynamics of the

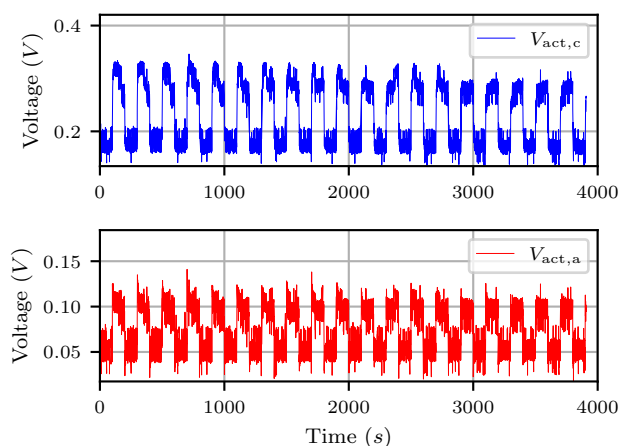


FIGURE 21. Observed states  $v_{act,c}$  and  $v_{act,a}$  for Database 7.

voltage states  $v_{act,c}$  and  $v_{act,a}$  that occur at the cathode and the anode through an ECM. However, the assumption for  $v_{ini}$ ,  $R_{mem}$ , and  $C_c = C_a$  (i.e., these parameters are considered constant to facilitate the development of the Luenberger observer) affects the accuracy of measurements for the dynamic voltage  $v_{act}$  presented in a real PEM electrolyzer.

## V. CONCLUSION

In this work, the effectiveness and robustness of the Luenberger observer were demonstrated for the dynamics present in the PEM electrolyzer voltage when subjected to continuous changes in input currents.

The effectiveness of the implementation of the Luenberger observer to an ECM for PEM electrolyzer voltage opens new research opportunities for different implementations of observers and control. Furthermore, by using the ECM parameters and implementing the Luenberger observer it is possible to build an electronic circuit that emulates the real voltage response of a PEM electrolyzer in a reliable way and that also allows for estimating dynamic behaviors.

## ACKNOWLEDGMENT

This work has been supported by Consejo Nacional de Humanidades, Ciencias y Tecnologías (CONAHCYT) Mexico. The authors are grateful to Dr. Isaac Zetina and Dr. Dulce Serrano for their support in the observer study and Dr. Bahia Cassal for her support in the development of the Luenberger observer code.

## REFERENCES

- [1] Luis M. Abadie and José M. Chamorro. Investment in wind-based hydrogen production under economic and physical uncertainties. *Applied Energy*, 337:120881, 2023.
- [2] Stéphanie Bouckaert, Araceli Fernandez Pales, Christophe McGlade, Uwe Remme, Brent Wanner, Laszlo Varro, Davide D'Ambrosio, and Thomas Spencer. Net zero by 2050: A roadmap for the global energy sector. *The National Academies of Sciences, Engineering, and Medicine*, 2021.

- [3] E. Escobedo, D. García, M. Ruiz, A. Izquierdo, D. Pacheco-Catalán, and L.C. Ordóñez. Design, construction, and performance of a proton exchange membrane water electrolyzer (pem-we). *International Journal of Electrochemical Science*, 18(5):100110, 2023.
- [4] F. Gutiérrez-Martín, Lidia Amodio, and Maurizio Pagano. Hydrogen production by water electrolysis and off-grid solar pv. *International Journal of Hydrogen Energy*, 46(57):29038–29048, 2021.
- [5] Mahdi Kheirrouz, Francesco Melino, and Maria Alessandra Ancona. Fault detection and diagnosis methods for green hydrogen production: A review. *International Journal of Hydrogen Energy*, 47(65):27747–27774, 2022.
- [6] Steffen Becker and Vishy Karri. Predictive models for pem-electrolyzer performance using adaptive neuro-fuzzy inference systems. *International Journal of Hydrogen Energy*, 35(18):9963–9972, 2010.
- [7] M. Erdem Günay and N. Alper Tapan. Analysis of pem and aem electrolysis by neural network pattern recognition, association rule mining and lime. *Energy and AI*, 13:100254, 2023.
- [8] Xinyu Lu, Banghua Du, Shenpei Zhou, Wenchao Zhu, Yang Li, Yang Yang, Changjun Xie, Bo Zhao, Leiqi Zhang, Jie Song, and Zhanfeng Deng. Optimization of power allocation for wind-hydrogen system multi-stack pem water electrolyzer considering degradation conditions. *International Journal of Hydrogen Energy*, 48(15):5850–5872, 2023.
- [9] Joonas Koponen, Antti Kosonen, Vesa Ruuskanen, Kimmo Huoman, Markku Niemelä, and Jero Ahola. Control and energy efficiency of pem water electrolyzers in renewable energy systems. *International Journal of Hydrogen Energy*, 42(50):29648–29660, 2017.
- [10] Lauri Järvinen, Pietari Puranen, Antti Kosonen, Vesa Ruuskanen, Jero Ahola, Pertti Kauranen, and Michael Hehemann. Automated parametrization of pem and alkaline water electrolyzer polarisation curves. *International Journal of Hydrogen Energy*, 47(75):31985–32003, 2022.
- [11] Abhigyan Majumdar, Meridian Haas, Isabella Elliot, and Shima Nazari. Control and control-oriented modeling of pem water electrolyzers: A review. *International Journal of Hydrogen Energy*, 2023.
- [12] V.A. Martinez Lopez, H. Ziar, J.W. Haverkort, M. Zeman, and O. Isabella. Dynamic operation of water electrolyzers: A review for applications in photovoltaic systems integration. *Renewable and Sustainable Energy Reviews*, 182:113407, 2023.
- [13] Øystein Ulleberg. Modeling of advanced alkaline electrolyzers: a system simulation approach. *International Journal of Hydrogen Energy*, 28(1):21–33, 2003.
- [14] Ozcan Atlam and Mohan Kolhe. Equivalent electrical model for a proton exchange membrane (pem) electrolyser. *Energy Conversion and Management*, 52(8):2952–2957, 2011.
- [15] C. Rozain and P. Millet. Electrochemical characterization of polymer electrolyte membrane water electrolysis cells. *Electrochimica Acta*, 131:160–167, 2014. Electrochemical Impedance Spectroscopy.
- [16] Damien Guilbert and Gianpaolo Vitale. Dynamic emulation of a pem electrolyzer by time constant based exponential model. *Energies*, 12(4), 2019.
- [17] Damien Guilbert, Dario Sorbera, and Gianpaolo Vitale. A stacked interleaved dc-dc buck converter for proton exchange membrane electrolyzer applications: Design and experimental validation. *International Journal of Hydrogen Energy*, 45(1):64–79, 2020.
- [18] Awais Khan, Wei Xie, Bo Zhang, and Long-Wen Liu. A survey of interval observers design methods and implementation for uncertain systems. *Journal of the Franklin Institute*, 358(6):3077–3126, 2021.
- [19] Qi Li, Liangzhen Yin, Hanqing Yang, Tianhong Wang, Yibin Qiu, and Weirong Chen. Multiobjective optimization and data-driven constraint adaptive predictive control for efficient and stable operation of pemfc system. *IEEE Transactions on Industrial Electronics*, 68(12):12418–12429, 2021.
- [20] Qi Li, Puren Liu, Xiang Meng, Guorui Zhang, Yuxuan Ai, and Weirong Chen. Model prediction control-based energy management combining self-trending prediction and subset-searching algorithm for hydrogen electric multiple unit train. *IEEE Transactions on Transportation Electrification*, 8(2):2249–2260, 2022.
- [21] Thomas Puleston, Andreu Cecilia, Ramon Costa-Castelló, and Maria Serra. Nonlinear observer for online concentration estimation in vanadium flow batteries based on half-cell voltage measurements. *Computers & Chemical Engineering*, 185:108664, 2024.
- [22] Ghulam E Mustafa Abro, Saiful Azrin Bin Mohd Zulkifli, and Vijanth Sagayan Asirvadam. Dual-loop single dimension fuzzy-based sliding mode control design for robust tracking of an underactuated quadrotor craft. *Asian Journal of Control*, 25(1):144–169, 2023.

[23] Ghulam E Mustafa Abro, Zain Anwar Ali, Saiful Azrin Bin Mohd Zulkifli, and Vijanth Sagayan Asirvadam. Performance evaluation of different control methods for an underactuated quadrotor unmanned aerial vehicle (quav) with position estimator and disturbance observer. *Mathematical Problems in Engineering*, 20:22, 2021.

[24] Kai Jing and Chang Liu. Online observer of the voltage components of the pem electrolyzer based on the time-varying linearization of the semi-empirical model. *Energy Reports*, 9:299–307, 2023. Selected papers from 2022 International Conference on Frontiers of Energy and Environment Engineering.

[25] Julio Luna, Elio Usai, Attila Husar, and Maria Serra. Enhancing the efficiency and lifetime of a proton exchange membrane fuel cell using nonlinear model-predictive control with nonlinear observation. *IEEE Transactions on Industrial Electronics*, 64(8):6649–6659, 2017.

[26] Jianxing Liu, Yabin Gao, Xiaojie Su, Maxime Wack, and Ligang Wu. Disturbance-observer-based control for air management of pem fuel cell systems via sliding mode technique. *IEEE Transactions on Control Systems Technology*, 27(3):1129–1138, 2019.

[27] Khadija El Kadri Benkara, Amalie Alchami, Achraf Nasser Eddine, Ghada Bakaraki, and Christophe Forgez. Field programmable gate arrays implementation of a kalman filter based state of charge observer of a lithium ion battery pack. *Journal of Energy Storage*, 70:107860, 2023.

[28] Yiming Xu, Xiaohua Ge, and Weixiang Shen. Multi-objective nonlinear observer design for multi-fault detection of lithium-ion battery in electric vehicles. *Applied Energy*, 362:122989, 2024.

[29] Yannan Su, Zhuanghua Shi, and Thomas Wachtler. A bayesian observer model reveals a prior for natural daylight in hue perception. *Vision Research*, 220:108406, 2024.

[30] Peng Wang, Han Wang, Xu Cai, and Zhengzhi Han. Flux detection by using impulsive observer for wind energy application. *Journal of Circuits, Systems and Computers*, 22(07):1350054, 2013.

[31] Zhou-Teng Xie, Bin Liu, Yong-Zhong Liu, and Zhijie Sun. Event-triggered impulsive observer with k-asymptotic gain for dc microgrids. *International Journal of Electrical Power & Energy Systems*, 156:109752, 2024.

[32] Francisco Castro Rego, Ye Pu, Andrea Alessandretti, A. Pedro Aguiar, António M. Pascoal, and Colin N. Jones. A distributed luenberger observer for linear state feedback systems with quantized and rate-limited communications. *IEEE Transactions on Automatic Control*, 66(9):3922–3937, 2021.

[33] Jarinah Mohd Ali, N. Ha Hoang, M.A. Hussain, and Denis Dochain. Review and classification of recent observers applied in chemical process systems. *Computers & Chemical Engineering*, 76:27–41, 2015.

[34] Ibrahim Dincer and Abdullah A. AlZahrani. 4.25 electrolyzers. In Ibrahim Dincer, editor, *Comprehensive Energy Systems*, pages 985–1025. Elsevier, Oxford, 2018.

[35] D.S. Falcão and A.M.F.R. Pinto. A review on pem electrolyzer modelling: Guidelines for beginners. *Journal of Cleaner Production*, 261:121184, 2020.

[36] Simone Mucci, Alexander Mitsos, and Dominik Bongartz. Power-to-x processes based on pem water electrolyzers: A review of process integration and flexible operation. *Computers & Chemical Engineering*, 175:108260, 2023.

[37] Manuel Langemann, David L. Fritz, Martin Müller, and Detlef Stolten. Validation and characterization of suitable materials for bipolar plates in pem water electrolysis. *International Journal of Hydrogen Energy*, 40(35):11385–11391, 2015.

[38] Ángel Hernández-Gómez, Victor Ramirez, Damien Guilbert, and Belem Saldivar. Development of an adaptive static-dynamic electrical model based on input electrical energy for pem water electrolysis. *International Journal of Hydrogen Energy*, 45(38):18817–18830, 2020.

[39] Ángel Hernández-Gómez, Victor Ramirez, Damien Guilbert, and Belem Saldivar. Cell voltage static-dynamic modeling of a pem electrolyzer based on adaptive parameters: Development and experimental validation. *Renewable Energy*, 163:1508–1522, 2021.

[40] Haluk Görgün. Dynamic modelling of a proton exchange membrane (pem) electrolyzer. *International Journal of Hydrogen Energy*, 31(1):29–38, 2006.

[41] R. García-Valverde, N. Espinosa, and A. Urbina. Simple pem water electrolyser model and experimental validation. *International Journal of Hydrogen Energy*, 37(2):1927–1938, 2012. 10th International Conference on Clean Energy 2010.

[42] Thomas Kailath. *Linear systems*, volume 156. Prentice-Hall Englewood Cliffs, New York, United States, 1980.

[43] Katsuhiko Ogata. *INGENIERIA DE CONTROL MODERNA*, volume 5. PRENTICE-HALL, United States, 2010.



**ÁNGEL HERNÁNDEZ-GÓMEZ** received the Ph.D. degree in science from the Yucatan Scientific Research Center (CICY), Yucatán, Mexico, in 2022. He is currently a postdoctoral researcher in School of Sciences, Universidad Autónoma de San Luis Potosí (UASLP), San Luis Potosí, Mexico. His current research interests include dynamic systems, control theory, and PEMFC and PEM electrolyzer modeling.



**DIEGO LANGARICA-CORDOBA** (Senior member, IEEE) received the Ph.D. degree in engineering from the Université de Paris Sud XI, Orsay, France, in 2014. He is currently a Researcher at the School of Sciences, Autonomous University of San Luis Potosí (UASLP), San Luis Potosí, Mexico. His current research interests include nonlinear control theory, power conversion, renewable energy, and electric vehicles.



**PANFILO R. MARTINEZ-RODRIGUEZ** (M'07–SM'21) received the Ph.D. degree in Applied Science from the Instituto Potosino de Investigación Científica y Tecnológica A.C. IPICYT, San Luis Potosí, México, in 2007. From 2006 to 2016, he was a full-time Professor with Tecnológico de México, Instituto Tecnológico Superior de Irapuato, TecNM-ITESI, Mexico. Since 2017, he has been holding a Professor-Researcher position at the Facultad de Ciencias, Universidad Autónoma de San Luis Potosí, Mexico. His research interests are focused on power electronics applications and include the modeling, design, and control of power electronics converters applied to the improvement of the electrical power quality and the electrical energy conversion from non-conventional electrical power sources.

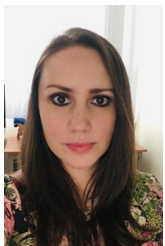


**HERNÁN GONZÁLEZ-AGUILAR** received the Ph.D. degree in Sciences (Mathematics) from the Center for Research in Mathematics (CIMAT), Guanajuato, México, in 2007. He is currently a researcher at the School of Sciences, Universidad Autónoma de San Luis Potosí (UASLP). His current research interests include discrete and computational geometry, dynamic systems, and applied mathematics.



**DAMIEN GUILBERT** (Member, IEEE) was born in Paris, France, in 1987. He received the M.Sc. degree in electrical engineering and control systems and the Ph.D. degree in electrical engineering from the University of Technology of Belfort-Montbéliard, Belfort, France, in 2011 and 2014, respectively, and the habilitation à diriger des recherches in electrical engineering from the University of Lorraine, Longwy, France, in 2022.

From 2016 to 2023, he was an Associate Professor with the University of Lorraine, France and a permanent member of the Group of Research in Electrical Engineering of Nancy (GREEN) Laboratory. Since 2023, he has been a Full Professor with the University of Le Havre Normandy, Le Havre, France, and has been a permanent member of the Group of Research in electrical engineering and automatic control of le Havre (GREAH). His current research interests include power electronics for electrolyzer applications, electrolyzer modeling and emulation, and energy management of multisource systems relying on renewable energy sources and hydrogen technologies.



**BELEM SALDIVAR** received her B.S. degree in electronics and telecommunications engineering from the Autonomous University of Hidalgo State, UAEH, Mexico, in 2007, and an M.Sc. degree in automatic control from the Center for Research and Advanced Studies of the National Polytechnic Institute CINVESTAV, Mexico City, Mexico, in 2010. In 2013, she received a Ph.D. degree in automatic control from CINVESTAV and in informatics and its applications from the Research

Institute of Communication and Cybernetics of Nantes, IRCCyN, Nantes, France. From 2014 to 2022 she was a research professor of the Catedras CONACyT program with the Faculty of Engineering of the Autonomous University of the State of Mexico. Since 2022 she has been a full time professor at the Department of Automatic Control, CINVESTAV-IPN in Mexico. Her research is focused on modeling and control of (finite and infinite-dimensional) dynamic systems, nonlinear and time delay systems.

...