



HAL
open science

Demand response in buildings: Unlocking energy flexibility through district-level electro-thermal simulation

Amin Amin, Oudom Kem, Pablo Gallegos, Philipp Chervet, Feirouz Ksontini, Monjur Mourshed

► **To cite this version:**

Amin Amin, Oudom Kem, Pablo Gallegos, Philipp Chervet, Feirouz Ksontini, et al.. Demand response in buildings: Unlocking energy flexibility through district-level electro-thermal simulation. *Applied Energy*, 2022, 305, pp.117836. 10.1016/j.apenergy.2021.117836 . hal-04573559

HAL Id: hal-04573559

<https://hal.science/hal-04573559>

Submitted on 16 May 2024

HAL is a multi-disciplinary open access archive for the deposit and dissemination of scientific research documents, whether they are published or not. The documents may come from teaching and research institutions in France or abroad, or from public or private research centers.

L'archive ouverte pluridisciplinaire **HAL**, est destinée au dépôt et à la diffusion de documents scientifiques de niveau recherche, publiés ou non, émanant des établissements d'enseignement et de recherche français ou étrangers, des laboratoires publics ou privés.

Highlights

Demand response in buildings: Unlocking energy flexibility through district-level electro-thermal simulation

Amin Amin,Oudom Kem,Pablo Gallegos,Philipp Chervet,Feirouz Ksontini,Monjur Mourshed

- Cloud-based AI framework for grid-safe energy optimisation in buildings of a district
- Abilities for exploiting building flexibility while considering grid constraints
- Reliable electricity demand predictions integration for optimal power grid operation
- Up to 30% energy cost reduction by exploiting PV generation and tariffs asymmetry
- Cost savings of up to 150% through further flexibility from home batteries

Demand response in buildings: Unlocking energy flexibility through district-level electro-thermal simulation^{*,**}

Amin Amin^{a,*}, Oudom Kem^c, Pablo Gallegos^d, Philipp Chervet^e, Feirouz Ksontini^c and Monjur Mourshed^a

^a*School of Engineering, Cardiff University, Cardiff, CF24 3AA, United Kingdom*

^c*Université Paris-Saclay, CEA, List, F-91120 Palaiseau, France*

^d*ENGIE Impact, EMEAI, Brussels, Belgium*

^e*Embedded Software Group, CSEM SA, Neuchâtel, Switzerland*

ARTICLE INFO

Keywords:

Demand response
Energy prediction
Energy optimisation
District simulation
Smart grid

ABSTRACT

European Union households account for 26% of the final energy consumption, yet their participation in demand response (DR) schemes is virtually non-existent. Relatively small amount of flexibility primarily from appliances and the lack of DR-enabled energy management solutions in homes have been identified as the main barriers. As part of a Horizon 2020 funded collaborative research and development project, we developed a cloud-based framework for intelligent optimisation of electricity consumption and generation in buildings to upscale and enhance their demand response effectiveness at a district level. Through electro-thermal simulations that unlock building flexibility while considering low-voltage grid constraints, our approach aims to extend technical and economic assessments of the whole solution to a broad level with capabilities for replication and synthesis of testing scenarios and with low computational time. The framework simultaneously schedules the operation of controllable appliances such as dishwashers, washing machines and dryers in buildings to further reduce peak loads and energy costs of the district. The framework was tested in a real UK district comprising 66 dwellings, which demonstrated its effectiveness in minimising electricity peak loads and costs by prioritising local consumption of the electricity produced from photovoltaics and exploiting the asymmetry on the time-varying electricity tariffs. The results show the ability to achieve an average 30% reduction in energy costs for the district while adhering to low-voltage grid constraints.

1. Introduction

Rising energy demand, especially in the residential sector, is adding further burdens on the existing traditional power grids that can be alleviated by commissioning new generation units or using energy effectively [1]. The increasing penetration of renewable energy sources (RES) such as solar and wind in power systems is displacing fossil fuel-based generation while mitigating climate change impacts by reducing greenhouse gas (GHG) emissions. In particular, decentralised energy systems (DES) provide a promising approach toward environmental sustainability [2]. To fully achieve the environmental promises of these energy technologies, RESs penetration needs to be expanded to provide electricity and thermal energy adequately from the building to district to city level.

The increasingly decentralised energy system presents major challenges for distribution system operators (DSO) to

balance between energy supply and demand. The large-scale penetration of RES can lead to significant fluctuations on the supply side due to their higher production variability, requiring a quick and reliable response from grid operators [3]. Increasing the reliability of DES, especially the ones with battery energy storage systems (BESS), however, is a challenging task that requires an upgrade and integration of existing energy systems with energy management technologies, which would provide opportunities to optimise the usage of the available energy [4]. Smart grids offer a two-way communication between consumers and operators, which can improve reliability and optimally control production, transmission, and distribution of electric systems to: (a) reduce the electricity cost, (b) manage peak loads and (c) mitigate the generation fluctuation of RES and the jeopardising of power systems [1]. On the other hand, demand side management (DSM) provides an effective approach to handle the aforementioned challenges in electricity systems. DSM is a set of measures accomplished on the demand side to optimise energy consumption and improve its load characteristics [5].

Among the benefits of smart grids is that they empower energy consumers and allow them to become more active participants in energy markets by selling electricity and flexibility [3]. However, to benefit from this paradigm, customers need to be ready to adopt flexible load patterns and to support the demands from the system. Load flexibility is defined as any deviation in load profile consumption or generation that is allowed to be carried out [6, 7, 8]. Flexibility provided by costumers includes heating, ventilation and air-

* This document is the results of the TABEDE project funded by the European Union's Horizon 2020 research and innovation programme, <https://www.tabede.eu/>

** The short version of the paper was presented at ICAE2020, Dec 1-10, 2020. This paper is a substantial extension of the short version of the conference paper.

*Corresponding author

✉ AminA8@cardiff.ac.uk (A. Amin); oudom.kem@cea.fr (O. Kem); pablo.gallegos@engie.com (P. Gallegos); philipp.chervet@csem.ch (P. Chervet); feirouz.ksontini@cea.fr (F. Ksontini); MourshedM@cardiff.ac.uk (M. Mourshed)

ORCID(s): 0000-0002-6891-5640 (A. Amin); 0000-0001-8347-1366 (M. Mourshed)

Nomenclature

ABO	Agent-Based Optimiser	EMS	Energy Management System
AC	Alternating Current	EP	EnergyPlus software
ADMM	Alternating Direction Method of Multiplier	EPW	EnergyPlus Weather file
API	Application Programming Interface	EV	Electric Vehicle
BEM	Building Energy Model	GHG	Greenhouse Gas
BES	Building Energy Simulation	HVAC	Heating and Ventilation and Air-conditioning
BESS	Battery Energy Storage System	IDF	EnergyPlus Input Data File
BMS	Building Management System	kW	Power unit in Kilowatt
BMS-E	Building Management System Extender	kWh	Energy unit in kilowatt hour
DC	Direct Current	LV	Low Voltage
DES	Decentralised Energy System	MQTT	Message Queuing Telemetry Transport
DoD	Depth of Discharge	MV	Medium Voltage
DR	Demand Response	PV	Photovoltaic
DRAS	Demand Response Automated Server	REEFS	Real-time Energy and Environmental Forecasting and Simulation
DSM	Distribution System Management	RES	Renewable Energy Source
DSO	Distribution System Operator	SE	Simulation Environment
E-Net	Electrical Net	SO	Smart Operations
		TABEDE	TowArds Building rEady for Demand rEsponse
		€	Euro

conditioning (HVAC) systems, electric appliances, on-site generations, and energy storage systems. Household appliances can be divided into controllable and non-controllable devices. Non-controllable loads are difficult to shift or change because of their dependency on occupant comfort and preferences, and include lights, televisions and most cooking appliances. On the other hand, controllable appliances are loads that can be shifted without violating occupant preferences and comfort, and include items such as washing machine, clothes dryer and dishwasher [8].

The demand side flexibility is exploited by participating in different demand response (DR) schemes, which are the DSM measures adapted by end-users to change their load patterns according to external requests mainly aimed to enhance utility systems operation during peak demand or contingencies through shifting, shaving, shedding, reducing or increasing the electricity consumption [3, 9]. A customer subscribing to a DR program receives a set of signals customised based on their consumption and generation [10]. DR programs can be categorised into two broad types [11]. First, incentive-based programs offer direct incentives to customers to change their consumption patterns upon request. Second, price-based programs provide customers with implicit signals as they are charged according to time-varying energy tariffs [12].

Several researches on building energy flexibility studied the integration of DR optimisation schemes with energy applications. Some have discussed the impacts of the integration on the energy supply side, such as integration with RESs and BESSs [8, 13, 14]. Others focused on implementing DR programs on the end-user load flexibility and investigating their impacts on the energy demand side, for instance, dominating residential HVAC systems can reduce demand and peak loads [15], through adjusting indoor temperature

setpoints for heating and cooling systems without influencing the occupancy comfort [16, 17]. However, scheduling smart appliances such as dishwashers, washing machines, and clothes dryers offers a significant potential flexibility for DR schemes [18, 19]. A study conducted on a residential customer in the UK showed that up to 48% of higher loads during peak hours could be shifted to off-peak periods by controlling a set of household appliances [15].

Energy management in decentralised energy systems is challenging, especially with high penetration rates of fluctuating RESs and BESSs [20]. Moreover, adopting DR programs on the demand side increases the complexity of the decision making process further [21]. Therefore, an intelligent optimisation infrastructure is required for implementing DR, resulting in further rational energy usage and improving power systems efficiency by exploiting the customer flexibility from a grid level perspective [3].

Developing energy management systems (EMS) with integrated optimisation tools are currently ongoing in many studies. For instance, Shakeri et al. [18] presented a home energy management system in residential buildings that allows users to implement DR programs. They were able to reach up to 20% reduction in energy costs and reduce peak load within certain limit autonomously for a single house during a day by implementing a price based DR program to control electrical appliances, photovoltaics (PV) generation and battery storage system. Perez et al. [19] proposed an energy management framework to minimise the peak load for a community of 40 houses via controlling thermostat set points, and shifting individual controllable appliances. The proposed system is able to reduce the overall daily peak load by 25.5% for the whole community.

A remarkable review on existing algorithms and management techniques was accomplished by Vázquez-Canteli

and Nagy [22]. They highlighted traits needed to be featured in future EMS developments. According to existing literature, we concluded essential features for effective exploitation of advanced smart grid features as: (i) A comprehensive energy management tool with embedded intelligent optimisation algorithms is a crucial trait to increase the effectiveness of DR implementation on the demand side [22, 23], and extend the benefits by constantly responding to grid signals, not only during grid emergencies and frequency instabilities [24]; (ii) The capability for upgrading buildings equipped with sensors and EMSs that can control heating and cooling systems and household appliances to adapt their electricity demand in response to smart grid signals [23]; (iii) Increase end-user engagement in DR programs to facilitate the decision-making process through communication channels that customers can provide information and feedback with attention to privacy and data security. Customers are offered to select flexible loads to share for controlling and may identify their scheduling preferences, as well as the convenience for accepting or dismissing the DR signals at any moment [21]; and (x) Forecasting the load patterns for both demand and generation is an essential feature needed at aggregated buildings level in order to evaluate the value and risks on power grids for implementing these tools to simplify the decision-making and support grid operators, which would require further experimental research to validate the capabilities and performance of these tools for DR programs [3].

Within the framework of the TABEDE project, a European Commission-funded Horizon 2020 R&D project standing for "TowArds Building rEady for Demand rEsponse", an intelligent energy infrastructure that enables customers to provide the flexibility and participate in DR schemes has been developed. The TABEDE solution aims at optimising energy consumption and injection through exploiting the flexibility provided by the customers to reduce energy bills, promote RES penetration, and support DR signals from grid operators. The effectiveness of TABEDE solution relies in particular on the achievement of three main objectives as defined in the project's grant agreement: (i) energy cost savings of up to 30%; (ii) higher penetration of distributed renewable energy sources of up to 25%; and (iii) increase building flexibility that can be shifted or curtailed by the system.

However, the optimised behaviour of individual buildings may not present a positive collective behaviour as observed by the grid. For instance, if all the buildings shift their consumption to an off-peak period to benefit from a cheaper energy price, the grid will be overwhelmed by the new peak demands. Assessing the broad effectiveness of DR controlling tools at grid level was accomplished on simulated data in most of the researches [3]. Limitations to real cases due to the need for acceptable periods of analysis before testing, and accompanied uncertainties that are difficult to predict, such as weather conditions and occupancy behaviour. Besides, the trial-and-error approach can jeopardise the power infrastructure and building systems. Building energy simulation (BES) tools facilitate the assessment of the value and

risks associated with the adoption of these tools at a high distribution level, such as residential sectors, due to implementation difficulties of the hardware infrastructure in the real environment [25]. Therefore, aligned with essential challenges and traits previously mentioned, we have developed a Simulation Environment (SE) as a part of the TABEDE solution with the objective of investigating the collective behaviour of customers as well as extending the technical and economic assessments on a large scale, as general conclusions cannot be drawn from individual test sites.

This article outlines the development of the Simulation Environment (SE), which allows electro-thermal grid-level simulation of districts, while considering low-voltage grid constraints. Our contribution aims to address two main questions: (i) assessing the alignment of TABEDE's economic impacts on a larger number of buildings, mapping different energy demand patterns, sizes and occupancy; (ii) investigating the effects that TABEDE will bring upon the power grid whenever scaling up to a larger scale; all of this in the context of a real EMS communication and control infrastructure, specifically designed for the optimisation of building's appliances to benefit from their inherent flexibility.

The novelty of the proposed SE resides, not only in the combination of different based forecasting models (building simulation and machine learning) and optimisation techniques to find optimal controlling strategies for the demand side, but also in utilising real data to diminish the gap between research, development and application through the exploitation of real data and calibrated building energy models (BEM) in order to evaluate the performance of our TABEDE controlling tool with the capability of daily assessment that can be scaled from a single appliance to an entire house level and further to the grid level at sub-hourly resolutions. Besides, the capabilities for the replication and synthesis of testing scenarios and conditions and minimising computational time without further hardware implementations in the real environment.

The paper is structured as follows. The general architecture and components of the TABEDE solution, and the rationale behind the development of the simulation environment (SE) are discussed in Section 2. Then, the technical information for the three key components of SE are discussed along with the data interfacing between them. The components: device and building loads forecasting; individual building optimisation; and aggregated buildings level optimisation are described in Sections 3, 4 and 5, respectively. In Section 6, key elements required for developing the SE are presented along with technical details on evaluation scenarios used in simulations. Section 7 details and discusses the results of various use-cases experiments for techno-economic assessments of TABEDE solution from a community/neighbourhood (aggregated buildings) perspective without and with considering grid constraints, then when applying BESSs at individual buildings level. Finally, Section 8 summarises the achievements and outstanding challenges of the proposed SE platform, and outlines the concluding remarks of the TABEDE techno-economic assessments.

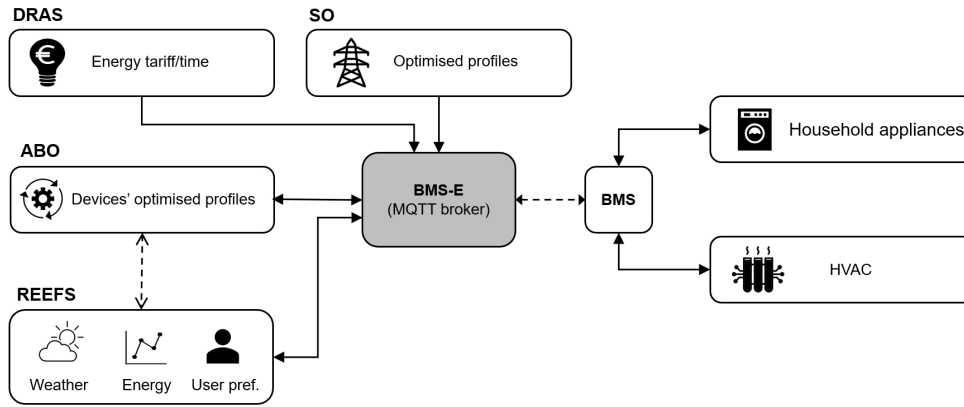

Figure 1: A schematic diagram for the architecture of TABEDE solution - BMS-E acts as the core component that handles the main four components and data interfacing between them and the existing building EMS

2. Smart cloud-based energy solution

In order to achieve the above stated goals of optimising energy consumption and injection by exploiting the flexibility provided by the customers, and promote RES penetration, and support DR signals, the TABEDE infrastructure is developed aiming to allow all buildings equipped with building management systems (BMS) to integrate with smart grids to adopt DR schemes. Deploying a gateway or more in the building is required to connect with the controlling cloud service for predicting and optimising the short-term demand and generation patterns at individual building level up to aggregated buildings level, which boosts the effectiveness of DR by continuously responding to grid signals in order to facilitate grid operation and mitigate the jeopardising of power systems.

The TABEDE solution is built on top of five main components: Demand Response Automated Server (DRAS), Real-time Energy and Environmental Forecasting and Simulation (REEFS), Agent-Based Optimiser (ABO), Smart Operations (SO) and Building Management System Extender (BMS-E). Figure 1 shows an overview of the components and their interactions. DRAS represents the demand response operator and sends price-based and incentive-based DR signals. REEFS provides weather and energy forecasts, ABO handles building-level energy optimisation and SO analyses the suggested consumption and generation with respect to grid constraints and generates alternatives if the constraints are violated. Technical information for these three key components are described in detail following the data interfacing between these components starting from device and building loads forecasting then individual building optimisation up to grid and aggregated buildings level optimisation in Sections 3, 4 and 5, respectively. The last component, BMS-E, serves as a smart gateway and is physically installed in the buildings. It gathers data from different sensors and measurement devices, transforms and stores the data in a unified format, relays the exchanges of data and messages among TABEDE components, and controls the appliances in the building as instructed by ABO.

From a technical point of view, the BMS-E consists of a core, so-called *adapters* and a message broker. The core's main task is to send the control signals to the different appliances in the building according to the optimised schedule received from ABO. In order to be able to communicate with those different appliances, possibly using many different protocols (ModBus, EnOcean, etc.) and thus providing inter-operability with appliances on the market, the *adapters* provide a unified communication interface for the BMS-E core and the other components and translate the exchanged messages to the respective protocols and vice-versa. The MQTT protocol, together with a custom extension to providing a request-response scheme, is used as communication interface. Thus, the BMS-E serves as a message broker to handle all interactions between the components. The standard message flow for one iteration is as follows: (1) REEFS and ABO collect real-time data from the buildings through the BMS-Es, (2) DRAS sends the DR signals to ABO, (3) REEFS sends the forecasts to ABO, (4) ABO does the optimisation and sends the optimised device profiles and schedules for device control to the corresponding BMS-Es and (5) BMS-Es send control signals to the appliances according to the schedules from ABO.

From an operating perspective, the TABEDE approach proceeds as follows: (1) the system forecasts weather and energy consumption and generation for the next 24 hours, (2) based on end-user preferences and inputs from a demand-response operator, it optimises the energy consumption and generation for the next 24 hours, and (3) it controls the appliances according to the optimised profiles in an automated way. In order to assure responsiveness to user preferences, demand-response signals and environmental changes, the system repeats these steps every 15 minutes.

To further study the impact of TABEDE at a district/community level, we also have developed a Simulation Environment (SE), taking into account essential features mentioned in the previous section, as a part of the whole infrastructure providing the ability to simulate and test a high diversity of situations, for instance: weather conditions, day of the year, consump-

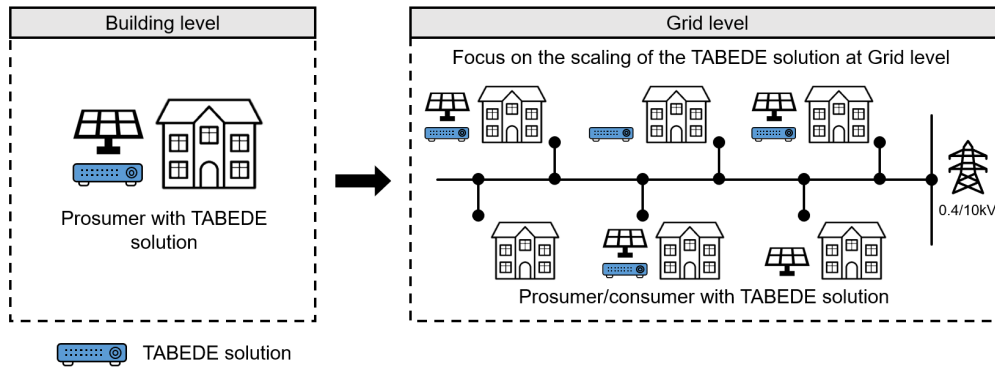

Figure 2: Scaling the implementation of the TABEDE solution from a individual building to aggregated buildings level (district/community) via the Simulation Environment SE

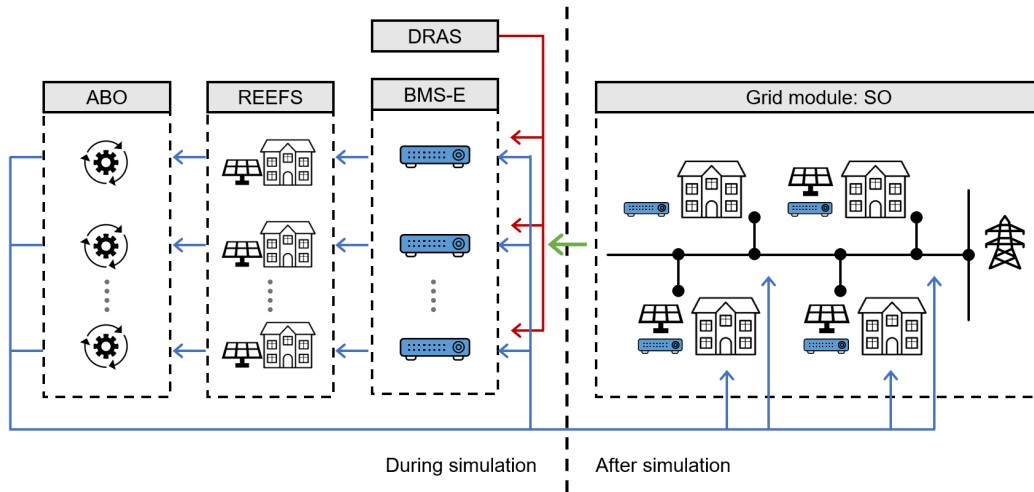

Figure 3: The Simulation Environment (SE), as an imitation of TABEDE solution, to boost the Demand Response (DR) effectiveness at a broadly level - similar data flowing with activating Smart Operations (SO) component for grid controlling

tion patterns, types and number of buildings, and grid topology, as shown in Figure 2. The structure of the SE imitates the general TABEDE architecture, with differences that the BMS-E runs virtually on a server and REEFS provides simulated device profiles instead of real sensors and appliances data, as illustrated in Figure 3. The components interact in the same way starting with sending DR signals by DRAS to the virtual BMS-E that in turn sends request for REEFS and ABO. Then, outputs from ABO were retrieved by SO to check the suggested schedules and generation with respect to grid constraints. If constraints are not adhered to, SO will suggest certain shedding deviations for loads and generation. The results obtained from applying TABEDE in this simulated context represent, not only the behaviour of individual buildings, but also the collective behaviour of the community concerning grid characteristics.

3. Forecasting and simulation framework

REEFS provides a real-time prediction of weather and electricity demand and generation for buildings and neighbourhoods. It uses historical weather condition, historical

energy profiles and building physical information to calculate day-ahead weather, electricity demand and generation profiles from device to district level by implementing a whole building simulation program and data-driven models.

The simulation environment is developed based on a physics-based model to forecast electricity demands and energy productions for each building. EnergyPlus (EP) is used as the simulation engine due to its capabilities to adequately consider the dynamic aspects of building thermal response to weather [26]. The key elements and steps taken to construct the simulation environment are thermal and electrical model development. For running the simulation, EP requires two inputs, namely building energy models formatted as Input Data File (IDF) and weather information for the site location in an EnergyPlus Weather (EPW) file format. In order to reduce the simulation time, each unit is modelled as a separate TABEDE that contains data regarding building physics information and construction materials, taking into account the site's characteristics. Information regarding the occupancy number and behaviours are also included in the energy models.

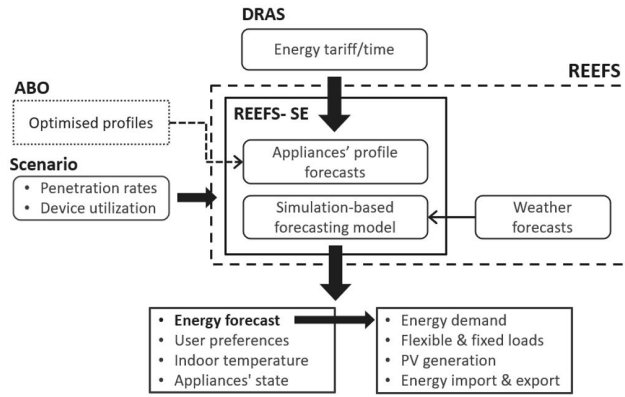

Figure 4: A schematic diagram for REEFS - A simulation-based forecasting platform - behaves as the key component of TABEDE for real-time prediction of weather and building electricity demand and generation

REEFS takes information for the start time as input from DRAS. At the first iteration, REEFS generates forecasts for electrical appliances profile, while calls optimised profiles from ABO during other iterations, as illustrated in Figure 4, then updates building energy models based on electrical household appliances configurations and the simulation scenario settings, more information on simulation scenarios is discussed in Section 6. REEFS allows accommodating weather forecasts for the location of the simulated district from the REEFS weather API then generates the weather file for running the simulation model. The result of simulations from REEFS includes indoor conditions and energy profiles for the next 24-hours, which contains indoor air temperature, user preferences, electrical appliances' state, total electricity demand and consumption profiles for flexible/non-flexible appliances, solar PV generation profile, and amounts of electricity import and export from/to the grid. These allow the building level and grid-level optimisation analysis to take place, in accordance with the simulation environment use cases.

4. Building level optimisation

The role of the optimisation component, Agent-Based Optimiser ABO, is to provide optimised energy consumption, generation, and storage of the building, taking into account the demand response schemes. In TABEDE, a wide range of devices is considered; each device possesses its own dynamic constraints and objectives. Performing an optimisation in such a context over a time horizon entails dealing with a large number of variables, making it computationally impractical to solve in a centralised manner [27]. In TABEDE, we considered various types of appliances providing different types of flexibility, namely:

- Fixed loads: their consumption cannot be altered in any way,
- Shiftable loads: their consumption can be shifted within

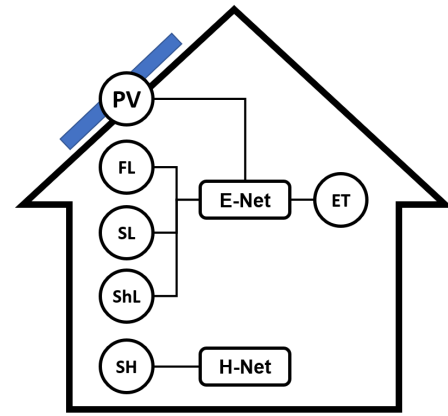

Figure 5: A conceptual implementation structure of the optimisation component (ABO) at an individual building level - Linking different electrical loads included fixed loads (FL), Shiftable loads (SL), Sheddable loads (ShL), and PV at an electrical Net agent (E-Net) with a connection to the External Tie (ET), while space heating (SH) linked to heating Net agent (H-Net)

a specified time interval,

- Sheddable loads: their consumption can be shed to a certain extent at a specified time interval,
- and Space heating: their consumption is tied to the set-point, and the flexibility is with regard to the interval of comfort temperature set-points, specified by the occupants.

Advances in decomposition methods such as Alternating Direction Method of Multipliers (ADMM) [28] have been applied to solve the optimisation of energy flow due to their robustness and privacy-preserving features. To solve this optimisation problem in a distributed fashion, thereby ensuring efficiency, scalability, and privacy, we proposed a multi-agent optimisation approach based on ADMM. For each type of devices, we modelled its objective function and constraints incorporating user constraints and demand-response incentives, when applicable.

In our optimisation approach (refer to [29] for a complete description), each device from appliances types is modelled as an agent, called a Device agent. Virtual agents, called Net agents, are modelled to represent energy exchange zones between devices, which constrain the energy schedules of their associated devices, as illustrated in Figure 5. As ADMM, our approach iteratively solves the problem until convergence, as shown in Figure 6. In each iteration, first, each device computes in parallel its best response to the price and energy requested by the electrical Net agent (E-Net). Second, E-Net upon receiving the offers from all the devices connected to it, checks if the convergence has been reached. If there is no convergence, E-Net computes new requests for the devices considering the devices' previous offers and send the new request to the devices. Third, E-Net updates the scaled dual variables. The result of the

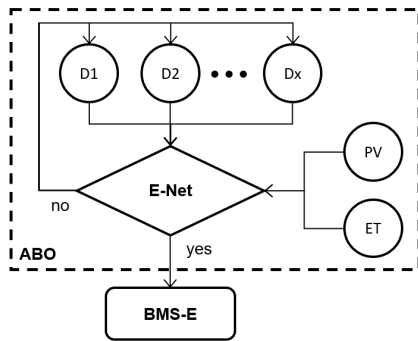

Figure 6: The ABO optimisation framework - Iterative problem solving process until the convergence for all devices (D_x) is reached

optimisation is the optimal energy flow, i.e., consumption and generation profiles that consider the incentives from DR schemes while respecting user constraints, which is sent out to BMS-E at the end.

It is important to note that, in the context of this project, buildings in a given district are not connected to one another. The optimisation is performed at the building level to provide optimised operating schedules for each individual building. One of the goals of the SE is to make it possible to assess the impact of TABEDE at the district level. The challenge is to make use of the outputs from ABO for each individual building to scale up to a larger scope, which can be used to assess the impact at the district level. This challenge is addressed by the SO component of TABEDE, which is described in the next section.

5. Low-voltage grid operation

Smart Operation (SO) [30] is a distribution network operational tool, proprietary software of Engie Impact, used for optimising electric power flows. The tool assesses the optimal operation of electricity distribution networks in the presence of energy resources such as PV systems, wind turbines, electric vehicles (EV), and battery storage, ensuring the adherence to grid constraints. The tool is built around a state-of-the-art multi-period AC optimal power flow core [31]. It is built for static and balanced flows on radial grids, allowing the convexification of its internal formulation and hence uniqueness of the mathematical solution provided. It gives as an output the optimal dispatching strategy of flexible resources: load shifting and shedding, generation curtailment and, EVs and batteries charging/discharging dispatch.

In the context of the current project, SO will be used for analysing the impacts that the ABO's optimised profiles will bring upon the electrical grid connecting the buildings. The assessment will be carried out via a constrained-power-flow analysis, i.e. the model will not perform an optimisation, but rather control that the network values, in terms of voltage variation and thermal capacities of conductors and transformers, are within nominal limits. For doing so, the grid's topology, such as the spatial distribution of consump-

tion and generation nodes, as well as the characteristics of all the equipment, where mapped. The tool will suggest a certain deviation, in terms of load shedding and generation curtailment, from the initial load and generation profiles when constraints cannot be respected.

6. Evaluation scenarios

In this section, key elements required for constructing the SE are provided, such as the number and type of buildings as well as all their possible electrical load configurations. Besides, we provide the technical details on the conception of the different evaluation scenarios to which TABEDE will be subjected. The aim of this exercise, as stayed previously in the introduction, being to perform an assessment by considering a large and realistic distribution of buildings, energy storage systems and PV generators in which TABEDE can be implemented.

The simulated district is modelled based on a part of a neighbourhood and its grid in Cardiff, UK, in which one of our pilot sites is located. The neighbourhood's grid is composed of a single MV/LV transformer with three feeders. One single feeder of the network is selected for simulations, where 66 residential buildings are connected, to ensure the computation time remains acceptable, as illustrated in Figure 7. Building units are distributed across seven archetypes including apartment buildings and terraced houses that allow for a fair representation of energy demand for district-level simulation purposes. The occupancy rate and behaviours are estimated based on the house size with considerations of the household type distribution in Cardiff. User behaviours are simulated according to predefined occupancy profiles of UK houses [32]. The technical characteristics of the grid including resistance and reactance of the cables, nominal capacities of transformers and lines, and technical restrictions for voltage quality were obtained from the local grid operators.

The development of simulation scenarios was carried out based on (1) the ownership and configurations of electrical loads among customers and (2) the ownership rates of PV, battery and TABEDE solution. The number and load profiles for individual electrical appliances are key elements for estimating electricity load profiles since gas boilers are used for heating systems in the district. The electrical load profiles are developed according to the ownership rates of common electrical appliances in residential houses in the UK [33]. The types of these appliances (flexible or non-flexible) include wet appliances, cooking appliances, cold appliances, and miscellaneous appliances, as lists in Table 1. The frequency and utilisation period are defined based on the UK Time of Use Survey scenarios [34].

The district solar generation depends on the number of customers owning a PV module and their power capacity; hence, different PV ownership rates are proposed to assess TABEDE's ability to manage the RES penetration. The power capacity of PVs is defined according to common domestic PVs (3-4 kW) in the UK. These ownership rates are also used to define the implementation of energy storage systems and

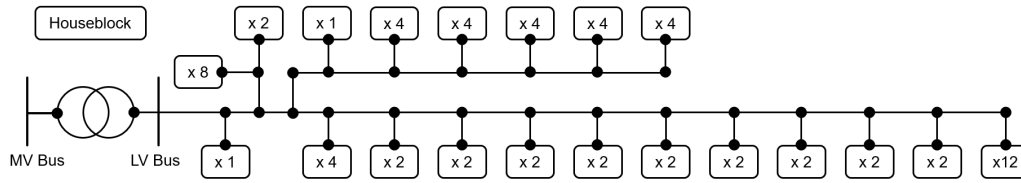

Figure 7: A schematic diagram for the topology of the power network for the simulated district in Cardiff, UK - A single feeder with connections to 66 residential buildings

Table 1

Types and categories of most common electrical UK household appliances used in the simulated district

Type	Category	Appliance	
Flexible	Wet	Washing machine	
		Cloth dryer	
		Dishwasher	
Fixed	Cooking	Electric hob	
		Electric oven	
		Kettle	
		Microwave	
		freezer	
	Cold	Kettle	
		Miscellaneous	TV
			Vacuum
			Iron
			PC

TABEDE penetration, as shown in Table 2.

Battery characteristics are defined based on common domestic battery storage systems in the UK, including charging/discharging power, energy storage capacities and Depth of Discharge (DoD) limitations. Various battery models were distributed among buildings with storage capacities between 3-20 kWh and charging power range from 0.7 kW to 5 kW, while discharging power is between 0.5 kW and 5 kW. A battery cycle is one of factors that influence the battery lifespan, therefore, the DoD of batteries is recommended to be set at 80% [35]. Batteries are installed on the grid-side allowing not only simultaneous storing directly from renewable energy source but also from the utility grid [36], which requires inverters to convert AC/DC and DC/AC for charging and discharging (AC-coupled). High efficient voltage inverters rated at 92% have been implemented. Batteries and TABEDE solution ownership rates are set based on the presence of PVs among customers. For instance, in scenario SC_01, 33 out of 66 houses (50%) are equipped with a PV and battery, and 7 out of 33 houses (10% of 66 houses) have TABEDE installed.

To assess TABEDE with the presence of all the appliances, a set of configurations for flexible appliances is used to run the six scenarios, as shown in Table 3. The highest customers' utilisation rate (100%) with 8% increase in ownership rates are set for wet appliances. As TABEDE aims

Table 2

Simulation scenarios included penetration rates for PV, battery and TABEDE solution that are proposed among the simulated district

Scenario	Penetration rate [%]		
	PV	Battery	TABEDE
SC_01	50	50	10
SC_02	50	50	50
SC_03	50	50	100
SC_04	100	100	10
SC_05	100	100	50
SC_06	100	100	100

Table 3

Simulation configurations for ownership and usage rates of electrical appliances within the simulated district

		Appliance	Config_01	Config_02
Ownership	Washing machine		92%	100%
	Dryer		58%	65%
	Dishwasher		46%	50%
	Fixed loads			+8%
Utilisation	Washing machine		66% weekday, 80% weekend	100%
	Dryer		66% weekday, 80% weekend	100%
	Dishwasher		42%	100%

for controlling the short-term loads profiles (the next day), the techno-economic assessments were carried out on a daily basis. Increasing RES penetration while mitigating the generation injection fluctuation and the jeopardising of grids are key challenges for TABEDE implementations. Therefore, the two extreme days with the highest and lowest amount of solar radiation driven from one year of data (2019) are selected for the assessments. Simulations were executed for both a summer day (highest solar -19/06/2019) and a winter day (lowest solar 19/12/2019).

The billing structure used corresponds to the one applied to that specific district: Buying peak price of 0.20 €/kWh ([07:00, 00:00]) and off-peak price of 0.13 €/kWh ([00:00, 07:00]) and selling price of 0.04 €/kWh.

7. Results and discussion

The current section details and evaluates the results of the use-cases proposed to illustrate the capabilities and effectiveness of TABEDE from technical and economic points of view. The discussion is outlined in three main parts aligned with the flow of the three use-cases implementation. First, an analysis of the results in terms of electricity and cost savings achieved by TABEDE is carried out to understand the mechanisms playing a role on the cost minimisation capabilities of the system from an aggregated buildings perspective. Then, grid constraints will be activated on the electricity grid, and both the cost reduction as well as the impacts on the network is evaluated. Finally, electrical batteries will be equipped on the buildings to further explore the TABEDE capabilities when flexibility is enhanced.

7.1. Techno-economic assessment

The district's electricity demand and generation of the scenarios described in the previous section are shown in Figure 8. The total consumption of the buildings (approximately 960 kWh) is fixed by design and remains constant for all the scenarios. The total generation varies across them: Winter 50% PV penetration shows the lowest generation rate of approximately 70 kWh, whereas Summer 100% PV corresponds to 1800 kWh, which is the highest. These two scenarios represent two extreme situations that can be encountered along the year. We also note that summer scenarios have enough locally produced energy to cover the needs of the district, while in winter, the solar production represents a small percentage of the total consumption. It is noteworthy that consumption patterns of buildings are fixed among all simulation scenarios to demonstrate the dependency of the TABEDE's effectiveness with respect to the available solar energy. The flexible consumption element on the graph represents the amount of consumption exploitable by TABEDE solution. Only the houses with TABEDE installed are considered to provide a certain amount of flexibility. As shown in Figure 8, this amount increases in function of the rate of TABEDE penetration in the district.

The net consumption costs (i.e., the consumption cost of the district minus its injection revenues) of the different scenarios in the function of the TABEDE penetration rate is shown in Figure 9. These costs are calculated using the optimised consumption and generation profiles of the 66 houses, as suggested by ABO, according to Equations 1 and 2.

$$C_{Net} = C_{Imp} - C_{Inj} \quad (1)$$

$$C_{Imp} = (L_P + L_F) + (B_P + B_F) \quad (2)$$

where C_{Net} is the net consumption cost and equals the differences between the import cost C_{Imp} and injection cost revenues C_{Inj} , where the import cost is the sum of loads consumption L and battery charging B from the grid during peak P and off-peak periods F concluded from Equation 2.

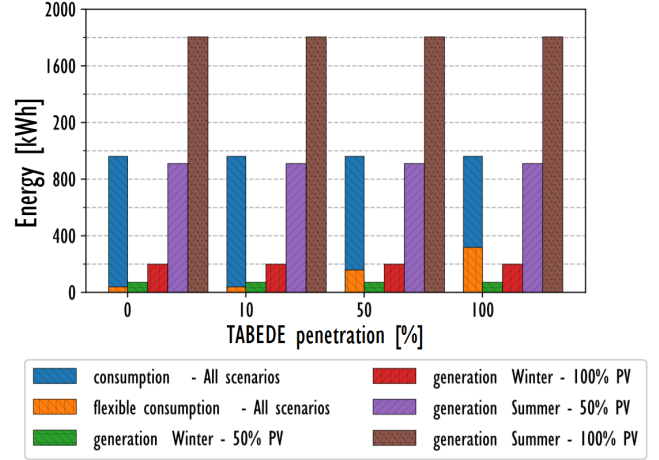

Figure 8: The daily electricity demand and generation at aggregated buildings level for the different simulation scenarios among various TABEDE installation rates

The different elements used in calculations, which are aggregated among the district's buildings and calculated on a daily basis, can be summarised as follows:

- Net consumption cost: it corresponds to the total buying cost of the electricity minus the injection revenues perceived for selling excess PV to the grid.
- Peak load consumption cost: cost of the electricity consumed during the peak price period.
- Off-peak load consumption cost: cost of the electricity consumed during the off-peak price period.
- Off-peak battery charge cost: when available, the cost of the electricity bought from the grid for charging household batteries.
- Injection revenue: income perceived by selling back to the grid excess PV electricity.
- Load self-sufficiency cost-saving: avoided cost of the electricity thanks to self-sufficiency from local PV.

The energy cost reduction increases as more houses are equipped with TABEDE. More specifically, from Winter 50% PV to Summer 100% PV penetration, this reduction goes from 6% to 34%, respectively. It is noteworthy that during the low PV generation periods, as in the case of Winter, the cost reduction results mainly from optimising the flexible consumption to benefit from the off-peak price, while when the PV generation is high, the reduction is due to the increase of self-consumption. These effects will be discussed in detail in the following paragraphs.

Figure 10 exemplifies how TABEDE manages the operation of one of the district's buildings during a 24-hour period. The upper graph shows how the system optimises the consumption when the building is exposed to a significant degree of PV generation (yellow curve). The flexible consumption (red curve), which is the forecasted demand of

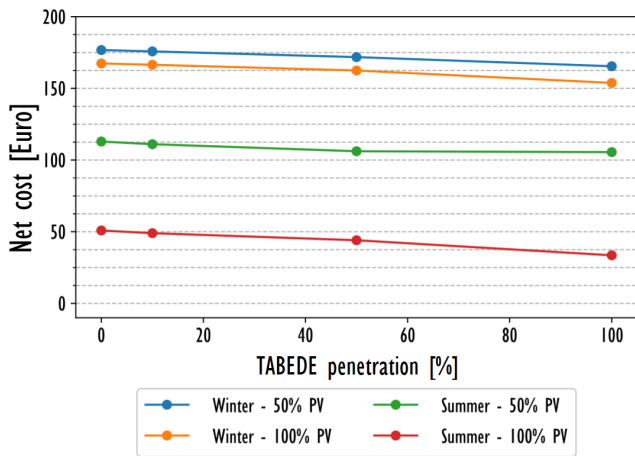

Figure 9: The net daily electricity consumption costs at the district level across the simulation scenarios - The individual building self-consumption is the main driver for cost reduction

the washing machine, the dishwasher and the cloth dryer of the building is modified by TABEDE to synchronise with the PV generation (i.e. increasing self-sufficiency) and therefore benefit from the "free" local electricity coming from it. The outcome can be seen on the flexible optimised profile (green curve), which is the flexible consumption after TABEDE modification, which is being dispatched during the hours of PV generation. A second situation is shown in the lower graph, for which the forecasted consumption is the same as the previous case, whereas the PV generation now is significantly lower. It can be observed now that part of the flexible optimised consumption is dispatched during the low price electricity hours (grey curve), given the reduced PV generation that is not able to fully cover the flexible demand. We note that not all the flexible consumption is shifted towards this period given utilisation constraints coming from the user preferences of the building.

At the district level, a decomposition of the optimised cost and revenues of Winter 50% PV and Summer 100% PV penetration configurations is shown in Figure 11 (upper and lower graphs, respectively), which corresponds to the worst and the best-case scenarios of Figure 9, respectively. During winter we observe that almost all locally produced PV electricity is consumed within the district (the injection revenue – pink bar – is almost not visible as it is only at 1.8€ at 0% TABEDE penetration and at 1.2€ at 100% TABEDE penetration), as the amount of PV generation is very low (see Figure 8). Also, for this same reason we observe that TABEDE is not able to increase the rate of savings from self-sufficiency, which remain low (5.4€ and 8.2€ at 0% and 100% TABEDE penetration, respectively) with respect to the net consumption costs. In this configuration, the main driver for cost reduction comes then from the off-peak electricity period. When the TABEDE penetration increases from 0% to 100%, the off-peak consumption cost (orange bar, Figure 11) increases from 15€ to 32€, whereas the peak consumption costs decreases from 163€ to 134€. Adding up all these

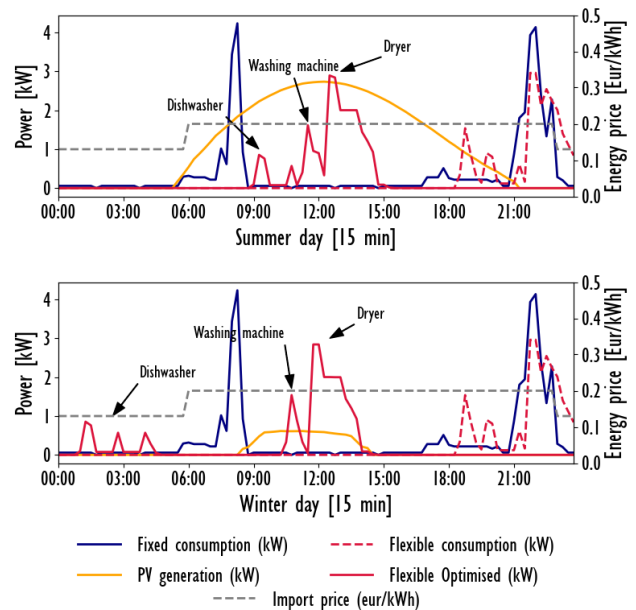

Figure 10: TABEDE optimisation capabilities - The initial 24-hour flexible consumption and optimised profiles for electricity demand and PV generation of an individual customer resulted from REEFS and ABO

effects results in a net consumption cost reduction from 177€ to 165€ (i.e., about 6%).

The situation is different during summer with 100% PV penetration (lower graph of Figure 11). Cost savings are primarily driven by self-sufficiency amounting to around 75€ at 0% TABEDE penetration (i.e., almost 15 times bigger than in Winter). Moreover, as PV generation is significantly higher (see Figure 8), the subsidy payments received from exporting excess PV that cannot be consumed locally amount to 57€ at 0% TABEDE penetration. We note that, compared to the situation in Winter, the flexible consumption enabled by TABEDE is now used to consume as much locally produced solar PV as possible, rather than shifting the flexible demand to lower price hours in the night. This can be seen by looking at the evolution of the off-peak consumption costs and self-sufficiency cost savings, when TABEDE increases from 0% to 100%. While the former decreases from 15€ to 11€, the later increase from 754€ to 100€. We note as well that the injection revenue decreases (since self-sufficiency is increased) from 57€ to 52€. The aggregated outcome of previous effects results in a net consumption cost decrease from 51€ to 34€ (i.e., about 34%).

7.2. Techno-economic assessment with grid constraints

This part of the analysis considers the impact of TABEDE on the low-voltage electricity network interconnecting the district's buildings. For this, grid constraints (thermal limits on cables and transformers, as well as voltage variation limits) are enabled and a power flow simulation analysis is performed using the SO tool. This is done based on the buildings' consumption and generation profiles optimised by

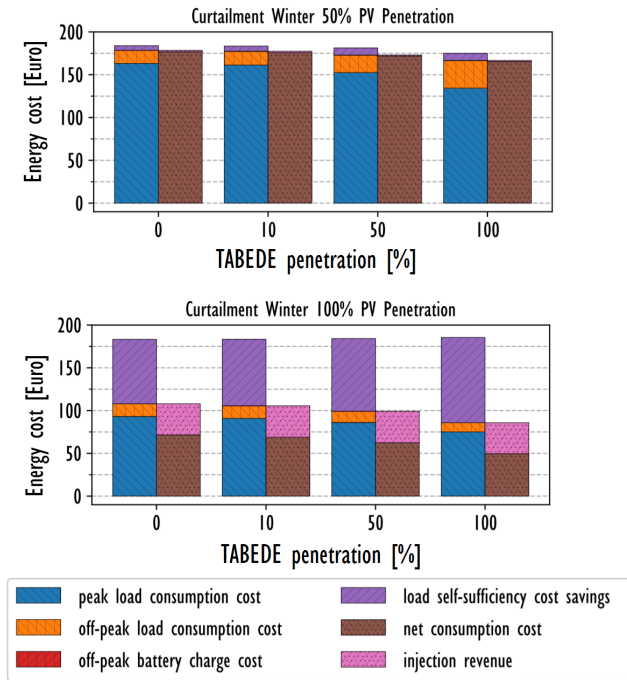

Figure 11: A breakdown for net electricity consumption costs for scenarios with the worst (Winter 50% PV) and best (Summer 100% PV) cases among various TABEDE installation rates

ABO.

We specifically look at the voltage increase on the network, as it is commonly known as one of the main problems faced by distribution grids due to local generation. An example of this is shown in the upper graph of Figure 12, where the 24-hour voltage profiles of all the network's nodes can be seen. The rated network voltage is presented by the blue line, whereas the maximum and minimum technical limits are presented in red. We observe how some of the nodes reach a voltage value above the maximum limit for some periods of time. This is the outcome of simultaneous solar injection into the grid, especially during midday. The lower graph of the same figure depicts an alternative variation profiles when the PV generation is controlled by SO. In this situation, generation is being curtailed to assure the voltage is just below the technical limits. We note that this curtailment is applied only on the exported energy, as local consumption of PV does not have any impact on the grid.

The outcome of the curtailment procedure is summarised in Figure 13, where the relative generation curtailment (which is the percentage of energy that was curtailed with respect to the total district's produced generation) is shown. We observe first that there is no generation curtailment during winter (orange and blue curves are overlapped and equal to zero in Figure 13), as the solar radiation is too low to produce any grid problems. Contrary to this, the highest curtailment rates can be observed during summer at 100% PV, specifically at 0% TABEDE penetration. In that case, more than 28% (368 kWh) of solar PV electricity are curtailed. This is reduced to 22% when going up to 100% TABEDE pene-

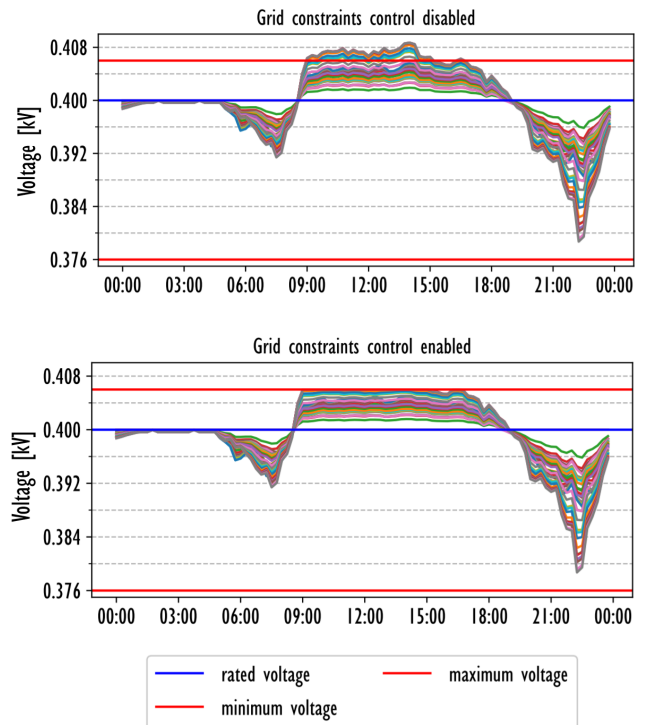

Figure 12: Mitigation of voltage increase across all nodes over the low-voltage grid during summer conditions with 100% PV and 50% TABEDE penetration rates

tration. The increase of self-sufficiency thanks to TABEDE reduces the amount of injection into the grid, and in turn results in less injected PV to curtail. An intermediate situation can be found during summer at 50% PV penetration. The curtailment rate at 0% TABEDE, which is around 8% (63 kWh), is reduced down to about 3% and then increased back up to 4% at 50% and 100% TABEDE, respectively. This case can be particularly interesting as it exemplifies a situation in which even if the net consumption cost is being reduced, other parameters can be negatively impacted. In this particular case, the additional 50% of TABEDE penetration goes into buildings without a PV system, whose consumption is optimised based on the variable electricity prices. This produces a decorrelation between the extra modified consumption and the available generation, increasing its congestion level and, therefore, the level of curtailment. We note however that, even in this situation, TABEDE brings a positive effect on the level of curtailment reduction (with respect to a situation 0% TABEDE penetration).

Figure 14 shows the Winter 50% and Summer 100% PV configurations' cost decomposition when grid constraints are enabled. We first note that, since curtailment is only activated in Summer, due to the excess of PV, impacts on the cost are observed just for this last case. More specifically, whenever comparing Figure 14 with the situation without curtailment (Figure 11) we observe that the main difference is the injection revenue being reduced on the 100% PV configuration (low graph of Figure 14). Indeed, buildings now cannot sell their electricity back to the grid during the criti-

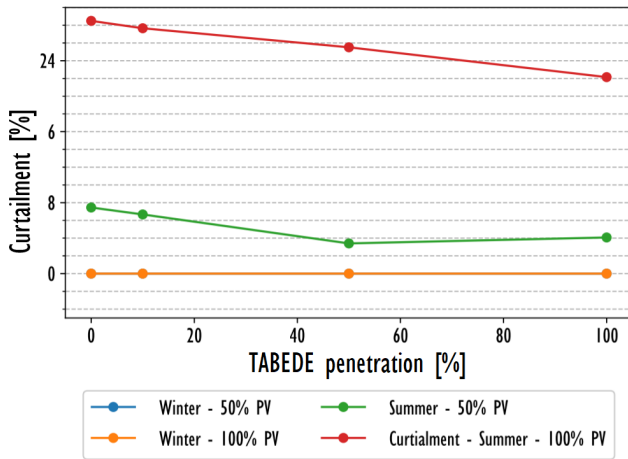

Figure 13: TABEDE capabilities for the PV generation curtailment at the district level among the simulation scenarios with various TABEDE installation rates

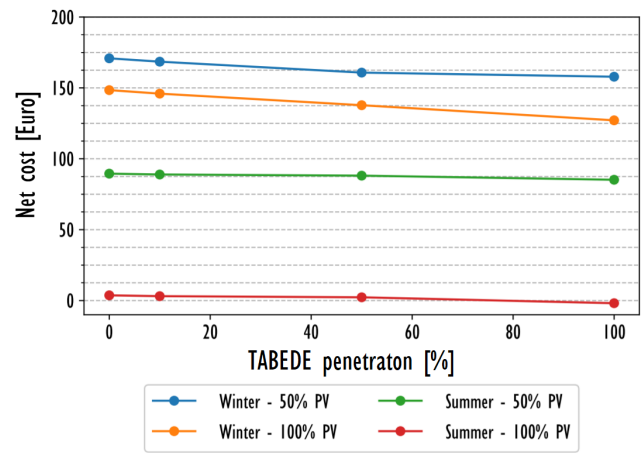

Figure 15: Net daily consumption costs with batteries implementation at individual building level among the simulation scenarios

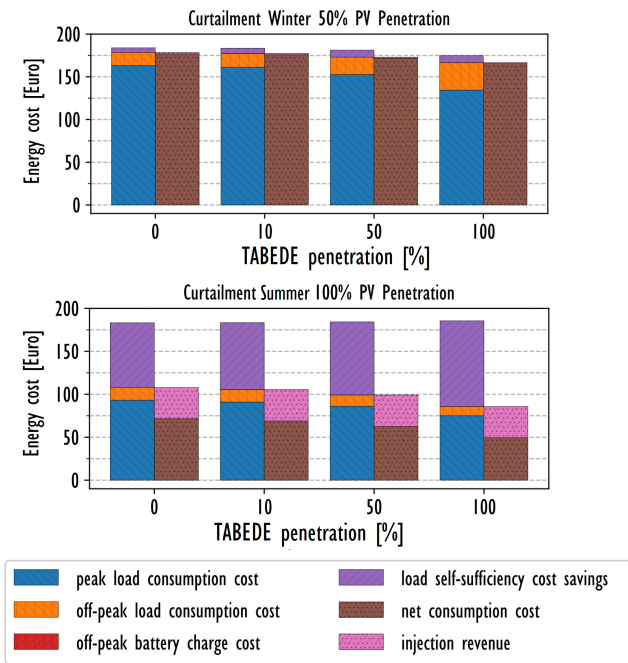

Figure 14: Electricity consumption costs breakdown while activating SO for generation curtailment to respect grid constraints for the scenarios with the worst (Winter 50% PV) and best (Summer 100% PV) cases

cal periods of congestion in order to benefit from its associated injection revenue. However, even if this introduces an absolute increase on the net consumption cost, we still observe a relative decrease on the cost with respect to the situation without TABEDE. This is shown in the lower graph of Figure 14, where a reduction on the net consumption cost from 71€ to 50€ (i.e., about 30%) is observed whenever the TABEDE penetration rate is increased.

7.3. Techno-economic assessment with batteries

In this use case the grid-level impact of adding battery storage at building-level is assessed. As such, the assumptions defined for the previous use cases (PV penetration, electricity tariffs, forecasted consumption patterns, etc.) are kept constant. However, buildings that do have PV installed are now also assumed to have a battery installed (i.e., penetration rates for PV and batteries are therefore the same. See Table 2 for details).

As in the previous section, Figure 15 illustrates the variation of the net consumption costs for different TABEDE penetration levels. A comparison with Figure 9 shows how, overall, there is a reduction of the cost for both winter and summer cases, with the last one experiencing the most important variation. We note first that any configuration (i.e., any point of the figure) presents a lower net consumption cost than its respective value without batteries. As it will be discussed in detail in the following paragraphs, this comes from the fact that with the inclusion of batteries, TABEDE is able to accommodate even more PV energy for self-sufficiency and to, at the same time, perform battery arbitrage with respect to the peak and off-peak tariffs (that is, to charge and discharge the battery during off-peak and peak periods, respectively). Quantitatively, this is observed by a cost reduction both in winter and summer. For the first one, this reduction is about 8% and 14%, at 50% and 100% PV penetration, respectively. For the later, it goes up to 5% and 151%¹ at 50% and 100% PV penetration, respectively. It should be noted as well that for this cases, since batteries buffering excess of PV electricity, no over-voltage problems are experienced on the local grid.

The outcome of TABEDE’s optimisation for a single building is shown in Figure 16. Following the example discussed in Section 7.1, a situation with a high (upper graph) and low

¹We note that for this specific case the starting value is of about 4€. Experiencing a relative variation of 151% is therefore easily achieved for such a small value.

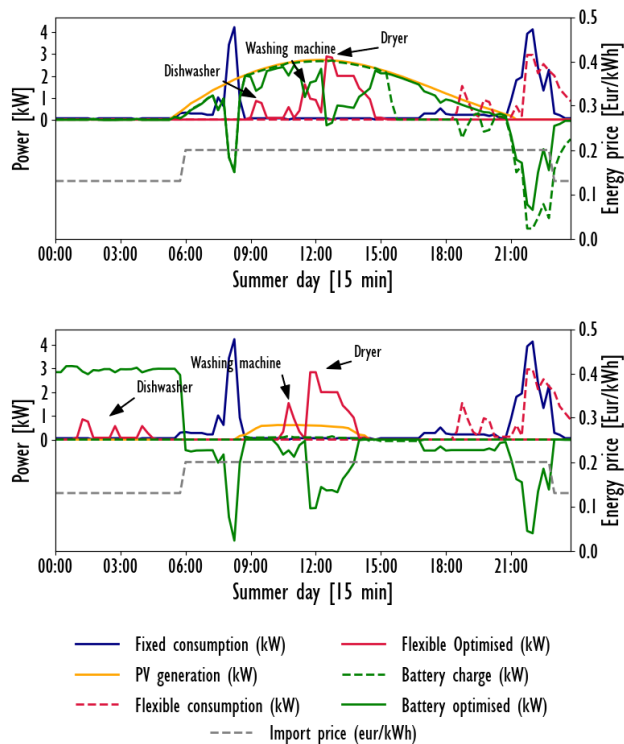

Figure 16: Residential batteries implementation at individual building level to enhance building flexibility - The initial 24-hour predictions and optimised electricity profiles for fixed loads, PV generation, flexible loads and battery charging/discharging of an individual customer resulted from REEFS and ABO

(lower graph) daily PV generation, this time with a household battery equipped on the building, are presented. Without any optimising strategy, the battery is used as a buffer of PV energy: it stores surplus of PV electricity, and discharged lately to satisfy the demand (red dotted curve). When the system is optimised, TABEDE makes again used of the controllable devices to shift the flexible consumption towards the PV generation period and, in parallel, it charges the battery with excess of solar energy (green dotted curve). It can be therefore seen that the both battery's dispatching strategies, before and after optimisation, are somehow similar. The most interesting effect comes in the second situation, when the PV generation is not significant (lower graph). Because of the lack of solar energy, before optimisation the battery is practically not dispatched, whereas after optimisation it is being used to perform price arbitrage: it is charged during the off-peak prices period, to satisfy demand during when the electricity price is higher (green dotted curve).

For the whole district, we first look at the case in winter at 50% PV and battery penetration (upper graph of Figure 17). Compared with the case with no batteries (upper graph of Figure 11), we observe that, for all TABEDE penetration levels, there is a small increase on the self-sufficiency rate and, because all locally produced solar electricity is fully consumed, no injection revenues are generated (note that in the scenario without batteries a small injection was ob-

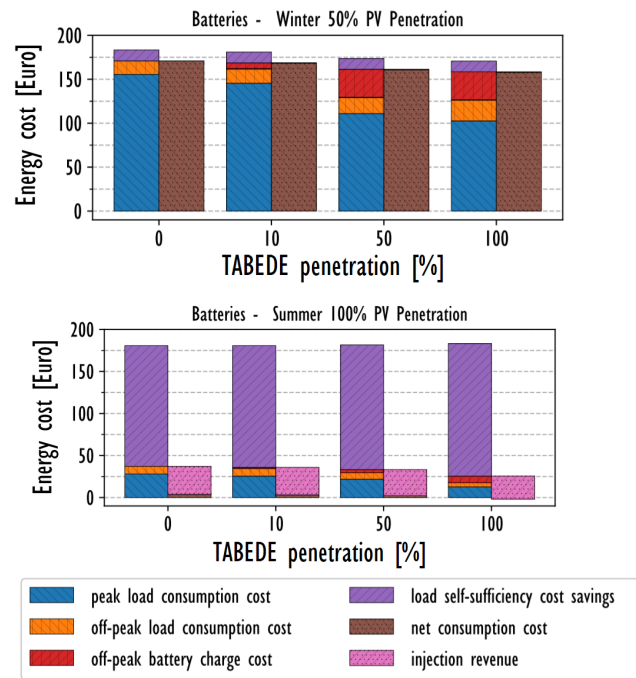

Figure 17: A breakdown for net consumption costs with BESSs implementation at buildings level for the scenarios with the worst (Winter 50% PV) and best (Summer 100% PV) cases among various TABEDE installation rates

served). When increasing the TABEDE penetration from 0% to 100%, cost savings are generated thanks to the use of the peak and off-peak prices periods. This can be seen by an increase of the off-peak electricity and battery charging costs (red and orange bars in Figure 17, respectively). While the former increases from 15€ to 23€ the later increases from 0€ to 32€. This last variation shows how the battery, that before introducing TABEDE was used just as a buffer of PV electricity, now is used for arbitrage to benefit from the peak and off-peak prices asymmetry. These combined effects allow to generate a reduction of the peak consumption cost from 156€ to 103€. Finally, all effects together have an impact on the net consumption cost from 171€ to 158€ (i.e., about 8%) of reduction.

The case of summer and 100% PV and battery penetration (lower graph of Figure 17) might be of particular interest. First, by comparing with the situation without batteries (lower graph of Figure 11) it can be seen how the self-sufficiency costs savings increase substantially, no matter the level of TABEDE penetration. This indicates that batteries themselves (i.e., without TABEDE) are already an effective mechanism for reducing the electricity bill, by storing excess of PV electricity to satisfy demand in periods where there is no generation. Given the fact that there is enough generation to cover the district's electricity needs (see Figure 8), one might expect that TABEDE stores even more PV electricity in the batteries to fully satisfy the demand. This is partially observed, as the self-sufficiency savings improves from 265€ to 338€ when the TABEDE penetration is

increased. However, a certain amount of import in terms of both peak and off-peak consumption still remains. Even if at the district-level there is enough generation, we observe that some buildings do not have enough PV to cover their needs. The TABEDE system therefore cannot locally satisfy their energy needs so it requests electricity from the grid. It is in those situations when battery arbitrage comes into place, to further reduce the cost: a reduction of the off-peak consumption cost from 9€ to 5€, coherently with the increase of self-sufficiency, is offset by an increase of the off-peak battery charging from 0€ to 8€. These effects combined together allow to reduce the peak consumption cost from 28€ to 12€. Netting all these mechanisms will result in a net consumption costs reduction from 4€ to -2€ (i.e., about 151%), this last one being a configuration in which net incomes are perceived by the district.

7.4. Discussion

The results have shown how TABEDE was able to modify the different elements of the cost structure to minimise the daily electricity bill of the district's buildings. This is thanks to the flexibility provided by the controllable appliances, the energy from local PV and, in a second instance, the additional flexibility provided by the inclusion of batteries. TABEDE made use of these previous elements to activate three mechanisms for cost reduction: self-sufficiency costs savings, off-peak price load consumption and battery arbitrage. The type of mechanism that was activated, as well as the monetary savings derived from it, where strongly dependent on the available flexibility and the generation produced during the evaluation day. With regard to this, we distinguish four cases:

- **Low PV and low flexibility (no batteries):** Described by the Winter 50% PV penetration configuration, the main measure for cost reduction was the shifting of the consumption towards low-price periods. Even if self-consumed, local PV energy did not provide any cost improvements due to its low generation rate. In this configuration, savings on the net consumption cost were about 6% with respect to the configuration without TABEDE.
- **High PV and low flexibility (no batteries):** This case, assessed in the Summer 100% Penetration configuration, showed self-sufficiency cost saving to be the main cost-reduction mechanism. Rather than benefiting from the low prices periods, the shifting was used to synchronise the demand with the generation, reducing the cost thanks to the "free" electricity provided by the local PV. The net consumption cost cost reduction observed in this case was around 34%.
- **Low PV and high flexibility (with batteries):** In this case, the Winter 50% PV and battery penetration scenario showed again that the main driver for cost optimisation was the asymmetry on the prices. On top of the shifting of the consumption towards periods of low pricing, it was seen how the battery was used as

a buffer of low price electricity. This last fact meaning that the battery was charged with electricity during the off-peak period to be discharged, in order to supply the demand, during the peak price hours. At this configuration, a net consumption cost reduction of 8% was observed.

- **High PV and high flexibility (with batteries):** In the Summer 100% PV and battery penetration configuration, both self-sufficiency and battery arbitrage were used to further optimise the cost. It was observed that even if at the district-level there was an excess of PV with respect to the demand, some of the buildings did not have enough daily generation to covers their needs. TABEDE then made use of the battery to, in the first time, increase the self-sufficiency level and, in the second, to benefit from the off-peak consumption prices, specifically for those buildings presenting a deficit of PV generation. Net consumption cost reductions in this case were of the order of 151%, being this case the only one presenting a positive net income for the ensemble of buildings. We would like to emphasise that such high level of improvement comes also from the fact that the initial values where small in absolute terms, and as such, a high relative reductions was easily achieved.

Finally, an assessment on the district's low-voltage electricity network whenever increasing the TABEDE penetration showed two main results. In the first hand, it was seen that in a highly congested situation (in Summer 50% and 100% PV penetration) due to simultaneous PV injections on the grid, TABEDE could bring positive benefits by reducing the level of generation curtailment. This effect comes from an increased rate of self-sufficiency (i.e., by a demand and generation synchronisation effect) obtained whenever implementing the solution. It was observed, for instance, that a curtailment reduction from 28% to 22% could be achieved. In the second, injection limitations coming from the grid could potentially lead to a underestimation of the net consumption costs initially computed by TABEDE. This was observed only in the Summer configuration without batteries, as in the other situations the PV injection level was not enough to produce any grid problems. Even if this leads to an increase in the net consumption costs (due to a reduction of the injection revenues), TABEDE still shows a positive relative cost reduction of about 30% when implemented.

8. Conclusion

In this study, we have discussed the development of a Simulation Environment (SE), within the TABEDE project, for evaluating of the capabilities of TABEDE controlling solution whenever scaled from a single household to the district-level, which allows to boost the demand response effectiveness at a broadly level. The developed environment was aiming to address two main questions: (i) to assess whether up to 30% of cost savings could be achieved whenever assessing a wide and realistic range of demand patterns, sizes and

occupancy levels on several buildings and; (ii) to investigate possible synergies and/or limitations on the low-voltage electricity grid interconnecting them. These objectives were achieved through various use-cases experiments for detailed technical and economic assessments of TABEDE solution among aggregated residential buildings level. The combination of optimisation techniques and forecasting models to find optimal controlling strategies, and utilising real data to link between research and market, were the novelty of the developed environment as well as replication and synthesis capabilities of testing conditions with low computational time.

The conception of the environment required the integration of several modules capable of simulating a real daily operation of the buildings equipped with the tool. First, the development of a physical-based simulation REEFS module with the capability of forecasting the energy behaviours of several buildings physically interconnected with the consideration of different occupancy behaviour and appliances ownership. In parallel, a cost-optimisation core capable of considering the REEFS's forecasted energy generation and demand profiles of the buildings, together with their electricity tariffs, was introduced by the ABO module. A communication platform allowing the real-time interfacing of these modules for the real measurement process and control of devices (for the real test sites) and the simulation (for the current study) was encapsulated in the BMS-E module. A last module, the SO operation tool, was in charge of the physical simulation of the district's grid to evaluate the impacts that the demand and generation profiles, piloted by ABO, would impose upon it, from an electrical perspective.

The techno-economic assessment was performed over different configurations of PV and TABEDE penetration, for two different days in Winter and Summer. On top of that, an evaluation of the impact on the inclusion of household batteries was carried out. Results showed positive results in terms of the cost reduction effectiveness and control of the grid congestion level. For doing so, TABEDE activated different cost reduction mechanisms: cost savings due to self-sufficiency from PV, consumption shifting towards low pricing periods and battery arbitrage thanks to the pricing asymmetry of the electricity tariff. Their activation, which showed to be dependent on the level of PV generation and flexibility, can be summarised in the following way:

- **Low PV and low flexibility:** Asymmetry of the pricing tariff, by making use of the shifting of the consumption, was used as the main mechanism for cost reduction.
- **High PV and low flexibility:** Self-sufficiency from PV was shown to be the main driver for cost reduction. It was seen as well how this mechanism helped indirectly to reduce the congestion level of the grid and, therefore, to reduce its congestion level.
- **Low PV and high flexibility:** Together with the shifting of the consumption towards low-price periods, when batteries were considered, pricing arbitrage was observed.

- **High PV and high flexibility:** Self-sufficiency, shifting of the consumption towards low-price periods, and battery arbitrage were used simultaneously to reach the maximum cost reduction.

In terms of assessing its economic impact, TABEDE showed that depending on the level of PV irradiation, the net consumption cost savings could range from about 6% to 30%, and from about 8% to 151%, in a situation without and with batteries, respectively. We therefore see that the general objective of obtaining up to 30% of cost reduction can be achieved partially depending on the level of PV generation. Also, with respect to the interaction between the buildings equipped with the solution and the electrical grid, it was seen that TABEDE was capable of effectively decreasing the grid's congestion level by increasing the overall rate of self-sufficiency.

9. Acknowledgements

The work in this study was carried out in the framework of the European Union's H2020 project "TowArds Building rEady for Demand rEsponse (TABEDE)" under Grant Agreement No. 766733.

CRedit authorship contribution statement

Amin Amin: Conceptualisation, Methodology, Software, Investigation, Resources, Data Curation, Writing - Original Draft, Visualisation, Writing - Reviewing and Editing. **Oudom Kem:** Conceptualisation, Methodology, Software, Investigation, Data Curation, Writing - Original Draft. **Pablo Gallegos:** Conceptualisation, Methodology, Software, Investigation, Data Curation, Validation, Writing - Original Draft, Visualisation. **Philipp Chervet:** Conceptualisation, Methodology, Software, Writing - Original Draft. **Feirouz Ksontini:** Conceptualisation, Methodology, Writing - Original Draft. **Monjur Mourshed:** Conceptualisation, Methodology, Supervision, Resources, Data Curation, Validation, Reviewing and Editing.

References

- [1] Amit Shewale, Anil Mokhadde, Nitesh Funde, and Neeraj Dhanraj Bokde. An overview of demand response in smart grid and optimization techniques for efficient residential appliance scheduling problem. *Energies*, 13(16):4266, 2020.
- [2] Kristina Orehounig, Ralph Evins, and Viktor Dorer. Integration of decentralized energy systems in neighbourhoods using the energy hub approach. *Applied Energy*, 154:277–289, 2015.
- [3] Fabiano Pallonetto, Mattia De Rosa, Francesco D'Ettorre, and Donal P Finn. On the assessment and control optimisation of demand response programs in residential buildings. *Renewable and Sustainable Energy Reviews*, 127:109861, 2020.
- [4] Johannes Meuer, Francesco Lamaro, and Nadège Vetterli. Embedding energy optimization in organizations: A case study of a swiss decentralized renewable energy system. *Energy and Buildings*, 235: 110710, 2021.
- [5] A Rezaee Jordehi. Optimisation of demand response in electric power systems, a review. *Renewable and sustainable energy reviews*, 103: 308–319, 2019.

- [6] Thomas Nuytten, Bert Claessens, Kristof Paredis, Johan Van Bael, and Daan Six. Flexibility of a combined heat and power system with thermal energy storage for district heating. *Applied Energy*, 104:583–591, 2013.
- [7] Sebastian Stinner, Kristian Huchtemann, and Dirk Müller. Quantifying the operational flexibility of building energy systems with thermal energy storages. *Applied Energy*, 181:140–154, 2016.
- [8] Yongbao Chen, Peng Xu, Jiefan Gu, Ferdinand Schmidt, and Weilin Li. Measures to improve energy demand flexibility in buildings for demand response (dr): A review. *Energy and Buildings*, 177:125–139, 2018.
- [9] QJUDE Qdr. Benefits of demand response in electricity markets and recommendations for achieving them. *US Dept. Energy, Washington, DC, USA, Tech. Rep.*, 2006, 2006.
- [10] Pierre Pinson, Henrik Madsen, et al. Benefits and challenges of electrical demand response: A critical review. *Renewable and Sustainable Energy Reviews*, 39:686–699, 2014.
- [11] Yoshiki Shimomura, Yutaro Nemoto, Fumiya Akasaka, Ryosuke Chiba, and Koji Kimita. A method for designing customer-oriented demand response aggregation service. *CIRP Annals*, 63(1):413–416, 2014.
- [12] Mehrdad Aghamohamadi, Mohammad Ebrahim Hajiabadi, and Mahdi Samadi. A novel approach to multi energy system operation in response to dr programs; an application to incentive-based and time-based schemes. *Energy*, 156:534–547, 2018.
- [13] David Fischer, Karen B Lindberg, Stine Mueller, Edo Wiemken, and Bernhard Wille-Haussmann. Potential for balancing wind and solar power using heat pump heating and cooling systems. In *Solar Integration Workshop*, pages 263–271, 2014.
- [14] Fakeha Sehar, Manisa Pipattanasomporn, and Saifur Rahman. An energy management model to study energy and peak power savings from pv and storage in demand responsive buildings. *Applied energy*, 173:406–417, 2016.
- [15] David G Infield, Joe Short, Chris Horne, and Leon L Freris. Potential for domestic dynamic demand-side management in the uk. In *2007 IEEE power engineering society general meeting*, pages 1–6. IEEE, 2007.
- [16] Sergi Rotger-Grifull, Rune Hylsberg Jacobsen, Dat Nguyen, and Gorm Sørensen. Demand response potential of ventilation systems in residential buildings. *Energy and Buildings*, 121:1–10, 2016.
- [17] Shengwei Wang, Dian-ce Gao, Rui Tang, and Fu Xiao. Cooling supply-based hvac system control for fast demand response of buildings to urgent requests of smart grids. *Energy Procedia*, 103:34–39, 2016.
- [18] Mohammad Shakeri, Mohsen Shayestegan, Hamza Abunima, SM Salim Reza, M Akhtaruzzaman, ARM Alamoud, Kamaruzzaman Sopian, and Nowshad Amin. An intelligent system architecture in home energy management systems (hems) for efficient demand response in smart grid. *Energy and Buildings*, 138:154–164, 2017.
- [19] Krystian X Perez, Michael Baldea, and Thomas F Edgar. Integrated hvac management and optimal scheduling of smart appliances for community peak load reduction. *Energy and Buildings*, 123:34–40, 2016.
- [20] Yongli Wang, Yujing Huang, Yudong Wang, Ming Zeng, Haiyang Yu, Fang Li, and Fuli Zhang. Optimal scheduling of the ries considering time-based demand response programs with energy price. *Energy*, 164:773–793, 2018.
- [21] Carlos Roldán-Blay, Guillermo Escrivá-Escrivá, and Carlos Roldán-Porta. Improving the benefits of demand response participation in facilities with distributed energy resources. *Energy*, 169:710–718, 2019.
- [22] José R Vázquez-Canteli and Zoltán Nagy. Reinforcement learning for demand response: A review of algorithms and modeling techniques. *Applied energy*, 235:1072–1089, 2019.
- [23] Fabiano Pallonetto, Mattia De Rosa, Federico Milano, and Donal P Finn. Demand response algorithms for smart-grid ready residential buildings using machine learning models. *Applied energy*, 239:1265–1282, 2019.
- [24] Meysam Razmara, GR Bharati, Drew Hanover, Mahdi Shahbakhti, Sumit Paudyal, and Rush D Robinett III. Building-to-grid predictive power flow control for demand response and demand flexibility programs. *Applied Energy*, 203:128–141, 2017.
- [25] Jason C Fuller, Kevin P Schneider, and David Chassin. Analysis of residential demand response and double-auction markets. In *2011 IEEE power and energy society general meeting*, pages 1–7. IEEE, 2011.
- [26] Virgilio Ciancio, Serena Falasca, Iacopo Golasi, Gabriele Curci, Massimo Coppi, and Ferdinando Salata. Influence of input climatic data on simulations of annual energy needs of a building: Energyplus and wrf modeling for a case study in rome (italy). *Energies*, 11(10):2835, 2018.
- [27] Matt Kraning, Eric Chu, Javad Lavaei, Stephen P Boyd, et al. *Dynamic network energy management via proximal message passing*. Now Publishers, 2014.
- [28] Michel Fortin and Roland Glowinski. Chapter iii on decomposition-coordination methods using an augmented lagrangian. In *Studies in Mathematics and Its Applications*, volume 15, pages 97–146. Elsevier, 1983.
- [29] Oudom Kem and Feirouz Ksontini. A multi-agent approach to energy optimisation for demand-response ready buildings. In *Artificial Intelligence Techniques for a Scalable Energy Transition*, pages 77–107. Springer, 2020.
- [30] Parvathy Chittur Ramaswamy, Pierre Garsoux, Christophe Del Marmol, Lorian Pellichero, and David Vangulick. A case study to assess data management and performance of optimal power flow algorithm based tool in a dso day-ahead operational planning platform. 2019.
- [31] Frederik Geth, Christophe del Marmol, David Laudy, and Christian Merckx. Mixed-integer second-order cone unit models for combined active-reactive power optimization. In *2016 IEEE International Energy Conference (ENERGYCON)*, pages 1–6. IEEE, 2016.
- [32] Victoria Aragon, Stephanie Gauthier, Peter Warren, Patrick AB James, and Ben Anderson. Developing english domestic occupancy profiles. *Building Research & Information*, 47(4):375–393, 2019.
- [33] Kunst Alexander. Household appliances ownership in the uk 2019. URL <https://www.statista.com/forecasts/997843/household-appliances-ownership-in-the-uk>.
- [34] Jonathan Gershuny. United kingdom time use survey, 2014–2015. 2017.
- [35] Kotub Uddin, Rebecca Gough, Jonathan Radcliffe, James Marco, and Paul Jennings. Techno-economic analysis of the viability of residential photovoltaic systems using lithium-ion batteries for energy storage in the united kingdom. *Applied Energy*, 206:12–21, 2017.
- [36] Intertek. Domestic battery energy storage systems: A review of safety risks. Technical report, Department for Business, Energy & Industrial Strategy and Office for Product Safety and Standards, 2020.