



**HAL**  
open science

## **Ratiometric fiber optic fluorescent pH sensor for hydroxide diffusion measurements in concrete**

Ayedah Tariq, Rasta Ghasemi, Jean Pierre Lefevre, Cédric Mongin, Alexandre Dauzères, Isabelle Leray

### ► **To cite this version:**

Ayedah Tariq, Rasta Ghasemi, Jean Pierre Lefevre, Cédric Mongin, Alexandre Dauzères, et al.. Ratiometric fiber optic fluorescent pH sensor for hydroxide diffusion measurements in concrete. *Sensors and Actuators B: Chemical*, 2024, 405, pp.135297. <10.1016/j.snb.2024.135297>. <hal-04573549>

**HAL Id: hal-04573549**

**<https://hal.science/hal-04573549v1>**

Submitted on 13 May 2024

**HAL** is a multi-disciplinary open access archive for the deposit and dissemination of scientific research documents, whether they are published or not. The documents may come from teaching and research institutions in France or abroad, or from public or private research centers.

L'archive ouverte pluridisciplinaire **HAL**, est destinée au dépôt et à la diffusion de documents scientifiques de niveau recherche, publiés ou non, émanant des établissements d'enseignement et de recherche français ou étrangers, des laboratoires publics ou privés.



HAL Authorization

# Ratiometric fiber optic fluorescent pH sensor for hydroxide diffusion measurements in concrete

Ayedah Tariq<sup>a,b</sup>, Rasta Ghasemi<sup>c</sup>, Jean Pierre Lefevre<sup>a</sup>, Cédric Mongin<sup>a</sup>, Alexandre Dauzères<sup>b\*</sup>,  
Isabelle Leray<sup>a\*</sup>

<sup>a</sup> **Université Paris-Saclay, ENS Paris-Saclay, CNRS, Photophysique et Photochimie Supramoléculaires et Macromoléculaires, 91190, Gif-sur-Yvette, France**

<sup>b</sup> **Institut de Radioprotection et de Sûreté Nucléaire (IRSN), PSE-ENV/SPDR/LETIS, Fontenay-aux-Roses, 92260, France**

<sup>c</sup> **Institut d'Alembert – FR 3242, Ecole normale supérieure Paris-Saclay, 4 avenue des Sciences, 91190 Gif-sur-Yvette**

Email : [isabelle.leray@ens-paris-saclay.fr](mailto:isabelle.leray@ens-paris-saclay.fr)

## Abstract

This article delineates the development of an advanced ratiometric pH optode designed for protracted monitoring of pH dynamics in cementitious materials—a crucial aspect of structural management. The optode features a dual-layer Hydromed™ D4 polymer pellet incorporating a pH-sensitive Naphth-AlkyneOMe fluorescent probe ( $pK_a \approx 12$ ) and CdSe quantum dots as an internal reference. The polymer matrix, optimized with diamond powder and carbon black, enhances the signal while minimizing light artifacts. Demonstrating a robust response to pH fluctuations, the optode, utilizing ratiometric measurements, enables steadfast monitoring for up to 75 days.

The experimental setup includes a Delrin® sample compartment housing a glass slide with the optode connected to an optical fiber via an SMA connector. HydroMed™ D4 films, forming the pH-sensitive layer, are deposited on the glass slide and secured. The optode configuration is fine-tuned to optimize signal intensity by reducing its length. For optode-detector coupling, a 1000  $\mu\text{m}$

core diameter optical fiber links the optode, and a 405 nm LED illuminates the sensing film. The emission signal is collected through the optical fiber, and signals are processed using computer-controlled lock-in amplifiers.

In the investigation of hydroxide ion diffusion through a concrete sample, the optode's efficacy was validated, aligning with pH electrode measurements. Addressing long-term stability, a degradation model uncovered leisurely kinetics with commendable stability. Slow degradation kinetics, with a reaction rate coefficient of  $1.6 \times 10^{-7} \text{ s}^{-1}$  and a half-life of 1180 hours, exceeded expectations.

This pH optode, showcasing an accurate and resilient response to pH variations within the 10 to 12.5 range, stands as a promising tool for monitoring pH dynamics in low-pH cementitious materials. The incorporation of a degradation model underscores fidelity over prolonged durations and offers a blueprint for enduring surveillance of concrete structures.

Keywords

Fluorescent probe, pH sensor, ratiometric optical fiber sensor, optode, concrete, ~~pH of concrete,~~

## 1. Introduction

The methods of inspection of concrete structures are quite crucial in the management and maintenance of these structures [1]. Among the parameters to be controlled, the monitoring of pH in cementitious materials is of major interest because the mechanical properties and durability of these materials are governed by hydration reactions. Currently, the most widely used methods for determining the pH value of the pore solution of concrete are the leaching method and the expression method [2]. In addition to the complexity of the procedures, these methods are destructive and not suitable for real-time monitoring of the pH value of concrete. Some studies have therefore attempted to use non-destructive methods to measure the pH of concrete using electrodes [3, 4] but they cannot be cast in concrete due to their brittleness and long-term non-stability. In this context, the development of an optode for monitoring the pH of concrete has many advantages in terms of stability, robustness, and reliability [5-9]. In short, the device consists of a sensitive fluorescent probe immobilized in a solid polymer matrix and the emission

signal is collected through an optical fiber. Indeed, optical sensors have already been developed to perform surface pH mapping of concrete samples [10]. More recently, we have developed pH optodes by immobilizing photoinduced electron transfer (PET)-based fluorescent probes, derived from perylene, in hydrogel matrices [11]. Similarly, naphthalene-derived ICT fluorescent probe (naphth-AlkyneOMe) has been physically entrapped in a polyvinyl alcohol-glutaraldehyde cross-linked hydrogel matrix to produce thin films that have been operated in an optode dedicated to pH measurement in the range of 10 to 12. Subsequently, this optode has been used to monitor the pH at the surface of low-pH cement paste samples after 4, 6, 7 and 8 days of hydration [12]. In order to obtain devices usable in situ, we have been interested in the development of systems working by ratiometric measurements[13] allowing to correct in real time an instability of the excitation source, variations of the geometry of the instrument, luminescent matrix or light artefacts. In the present work, we describe the development of a new ratiometric optode for pH measurement based on the previously described pH sensitive Naphth-AlkyneOMe molecular fluorescent probe[14]. However, the Naphth-AlkyneOMe probe has a broad and unstructured emission spectrum, requiring the addition of an additional internal reference (CdSe quantum dots) which fluorescence does not overlap with the pH probe and does not fluctuate as a function of pH. The set-up for these ratiometric measurements is described in this article, as well as its utilization for “long-time” diffusion studies through cementitious material.

## 2. Materials and methods

### 2.1. Reagents and general techniques

Hydrogel HydroMed™ D4 (ether-based hydrophilic urethane) was obtained from AdvanSource BiomaterialsCorp. Ultrapure water (over 18k $\Omega$ ) was prepared via a Milli-Q water purification system (Millipore). pH was measured with a glass electrode (calibrated in pH 4.01, 7.00 and 9.21 buffer solutions) specifically designed to reduce alkali errors (Mettler Toledo InLab Max Pro-ISM) and connected to a pH meter (Metler Toledo S220). **Naphth-AlkyneOMe** was prepared as previously reported [14]. Diamond powder was purchased from Alfa Aesar (natural diamond powder 40-60  $\mu$ m), carbon black was obtained

from Nanografi (carbon black 4  $\mu\text{m}$ ). CdSe/ZnS core-shell type oleic acid functionalized Quantum Dots (QDs) (fluorescence  $\lambda_{\text{em}} = 650 \text{ nm}$ , 5mg/L in toluene) were purchased from Sigma-Aldrich. Polystyrene (PS) beads (MW = 192 000. g/mol) were purchased from Sigma Aldrich. To compare the morphology of hydrated and dehydrated doped HydroMed D4 films, dehydrated pellets were cut and metallized (Au) on one side before their observation through a scanning electron microscope (Hitachi S-3400 N equipped with Secondary and Backscatter Electron Detectors.).

## 2.2 preparation of the films

**HydroMed™ D4 Naphth-AlkyneOMe film:** A homogeneous solution of HydroMed™ D4 at a mass concentration of 10% in THF was obtained by magnetic stirring at room temperature for one hour. The fluorescent pH probe was then added to the mixture and a hydrogel solution with a Naphth-AlkyneOMe probe concentration of 0.2  $\mu\text{mol/g}$  of HydroMed™ D4 was obtained. The polymer pellet was shaped by slow evaporation of THF in custom-made PTFE molding wells (diameter 10 mm, depth 2 mm).

**HydroMed™ D4 [diamond powder/Naphth-AlkyneOMe /carbon black] bilayer film:** The bilayer hydrogels are formed in two steps. The optical isolation layer was obtained by dispersing 1 wt% carbon black in a 10 wt% solution of HydroMed™ D4 solubilized in THF and doped with the pH probe at 0.2 $\mu\text{mol/g}$  of HydroMed™ D4. This black colored solution was shaped by drop casting according to the protocol developed for the HydroMed™ D4 Naphth-AlkyneOMe film. The second layer was then shaped by the same drop-casting process on the first layer: a solution of HydroMed™ D4 was prepared by solubilization in THF with a 10 wt% concentration. Then, the pH probe was solubilized (same concentration as before) and the micro diamond powder was dispersed with a concentration of 10% by weight of solution. Evaporation of the solvent results in a bilayer hydrogel with optical isolation. An equal concentration of pH probe in both layers prevents migration of the pH probe between the layers.

**QDs in PS film:** A polystyrene (PS) solution with a 10%wt concentration was prepared by solubilizing PS beads in THF by magnetic stirring at room temperature for 2 h. QDs are dispersed in this solution with a

concentration  $c_{\text{QDs}} = 0.45 \text{ mg/g}$  of solution. The films were obtained by slow solvent evaporation with a mean thickness of  $75 \mu\text{m}$ .

### 2.3. Optode Set-up

The sample compartment, made out of polyoxomethylene (DELRIN®), consists in a glass slide mounted in a hollowed cylinder connected to an optical fiber with an SMA (SubMiniature version A) connector. Hydrogel films were deposited on the glass slide and kept in place with a hollowed cap, allowing it to be in direct contact with the outer environment (Figure 1). The optode configuration was optimized compared to the previously reported design [15] by reducing the length of the optode to enhance the collected signal intensity.

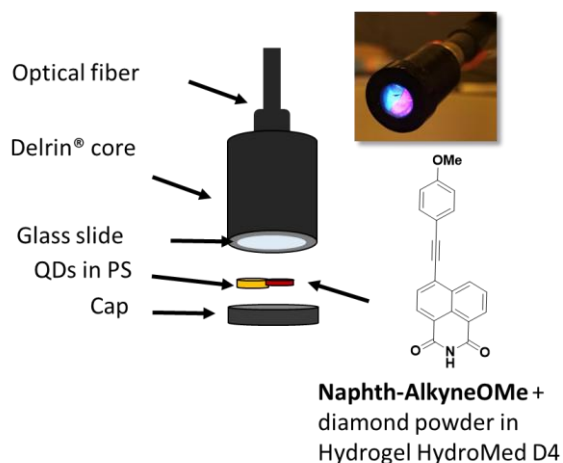
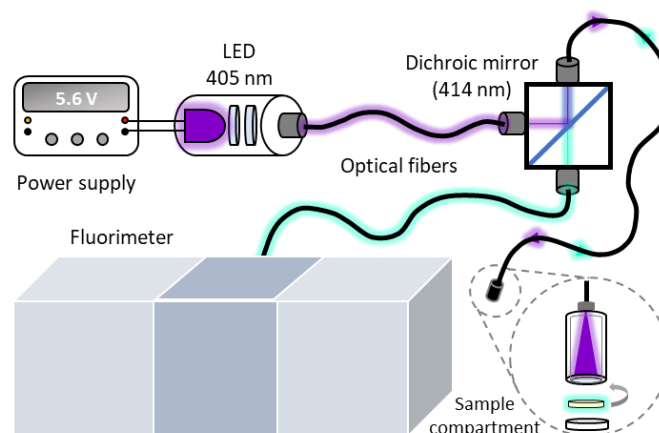

Figure 1 : optode set up (half a QDs in PS film is place on the glass slide with a HydroMed™ D4 bilayer film)

### 2.4. Optode/Fluorimeter coupling

The setup is shown in figure 2. The previously described optode is connected to a  $1000 \mu\text{m}$  core diameter optical fiber using an SMA connector, through which the excitation signal from the LED and the emission signal from the doped hydrogel are transmitted. The sensing film was illuminated with a light emitting diode (LED - Roithner LED405-30M32), emitting a spectral band of radiation which peaks at  $405 \text{ nm}$ . In order to narrow the bandwidth and to avoid artifact from the excitation, a single-band band pass filter was placed directly after the LED (Semrock FF01-405-10/25). The excitation and the emission signal are directed

to/from the optode through a dichroic mirror installed in a custom-made enclosed filter holder (Semrock FF414-Di01-22x29 - transmission band 327-409 nm; reflection band 420-950 nm; angle of incidence  $45 \pm 1.5$  degrees). The collected emission signal was then directed through an optical fiber towards the fluorimeter (Horiba Jobin-Yvon Fluoromax 4) connected using a custom-made SMA adapter to study variation in the fluorescence spectra of the probe.



*Figure 2: Diagram of the optical setup developed to study the emission of hydrogels doped with perylene based pH probes*

## 2.5. pH monitoring setup

The previously described optode and LED assembly were employed but the collection of the emission was modified as follow (Figure 3). The emission from the sensing film was collected by a 1000  $\mu\text{m}$  core diameter optical fiber through the same dichroic mirror as before (Semrock FF414-Di01-22x29). The collected signal was directed towards a secondary dichroic mirror (Semrock FF605-Di02-22x29) in order to separate the contribution from the probe to the one from the QDs. The signal from the probe was collected using a PMT (Hamamatsu Photonics PMT H10722-20) and the signal from the QDs with a secondary PMT (Hamamatsu Photonics, H10722-210). In order to limit photobleaching of the fluorescent molecular pH probe, the LED was driven using a low frequency generator set in square signal mode (pulse width: 650  $\mu\text{s}$ , period :  $T = 13$  ms, amplitude :  $A = 4$  Vpp, edge time : 5 ns). A Lock-In Amplifier (7265 Dual Phase DSP Lock-In Amplifier from Ametek Scientific Instruments) was associated with the setup to synchronize the emission acquisition

with the excitation, to increase the signal-to-noise ratio and remove the contribution from the ambient light. The Lock-In Amplifier was connected and operated from a computer and the signal intensity was directly traced using the Signal Recovery software.

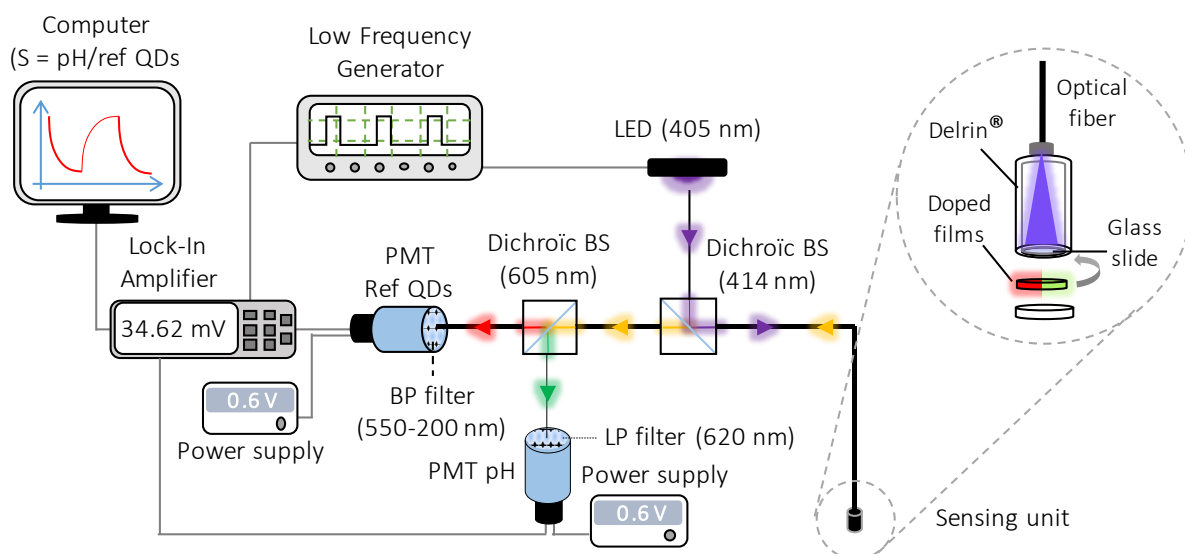

Figure 3: Optomechanical assembly of the optode including the pH and the QDs reference channels coupled to the Lock-In amplifier and connected to the control computer.

### 3. Results and discussion

#### 3.1. Optimization of the polymer layer

We have previously studied the evolution of PVA/GA polymer thin films in which the fluorophore Naphth-AlkyneOME had been incorporated [12]. A fluorescence decrease and a blue shift of the emission spectra have been observed upon deprotonation of the naphthalimide moiety because of a decrease of the charge transfer between the donor OMe and the imide moiety and a pKa value of 12 has been determined. In the present work, we evaluate the behavior of this pH probe in another widely used polymer matrix for optode design, HydroMed™ D4 [16, 17]. Figure 4 shows the change in fluorescence of the HydroMed™ D4/Naphth-

AlkyneOMe sensing material with increasing pH. The evolution of fluorescence intensity (FI) as a function of pH was fitted according to equation 1:

$$I_F = \frac{I_{F_{\text{Max}}} + I_{F_{\text{Min}}} \times 10^{\left(\frac{\text{pH} - \text{pK}_a}{\text{dpH}}\right)}}{10^{\left(\frac{\text{pH} - \text{pK}_a}{\text{dpH}}\right)} + 1} \quad (1)$$

Where  $I_{F_{\text{Max}}}$  is the fluorescence intensity of protonated form,  $I_{F_{\text{Min}}}$  is the fluorescence intensity of the deprotonated form, dpH accounts for the distribution of pKa in the matrix and pKa is the average pKa value in the matrix.

Satisfactory fits were obtained with  $\text{pK}_a = 11.82 \pm 0.02$  and  $\text{dpH} = 0.95 \pm 0.02$ . It should be noted that the dpH value is significantly higher in the case of HydroMed™ D4 than the one observed with GA/PVA (dpH 0.55) [12], which can be explained by a higher homogeneity of this polymer film. This effect is quite consistent with the SEM experiments showing a uniform profile (Figure 5).

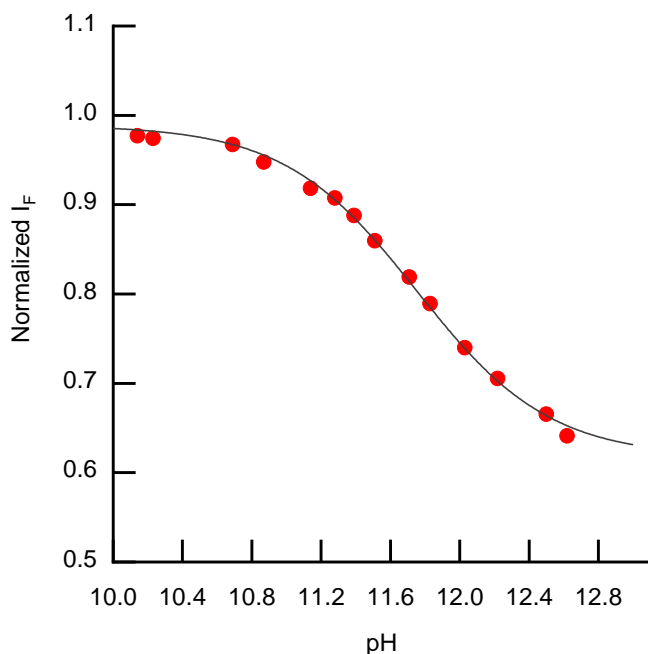
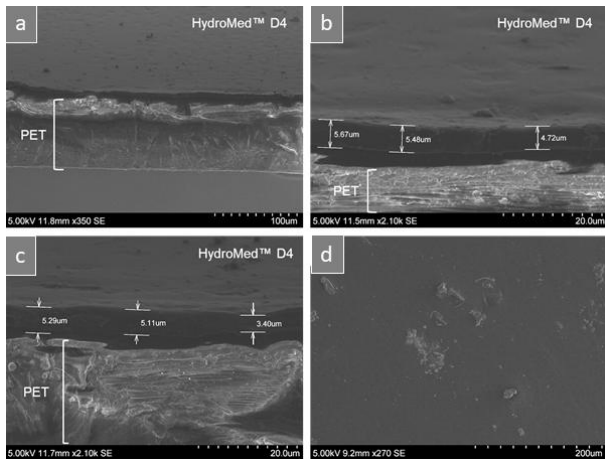

Figure 4 : Titration curve of hydromed D4 Naphth-AlkyneOMe upon pH,  $\lambda_{\text{exc}} = 405 \text{ nm}$



*Figure 5 : SEM images of HydroMed™ D4/Naphth-AlkyneOMe thin film applied in PET substrate in its hydrated state, cross-section (A, B, C) and on surface (D)*

Optimization of the fluorescence signal can be achieved by adding diamond powder into the polymer matrix following the method described Nielsen et al. [10]. Diamond powder is an inert material that does not react with the pH probe and the matrix and does not influence the pH and the composition of the solution. It is a highly reflective material which will improve light scattering across the sensing material and its utilization increases the signal amplitude by a factor close to 2. The absence of spectral shift proves the absence of interactions between the micron diamond powder and the HydroMed D4 doped with the Naphth-AlkyneOMe probe (Figure 6).

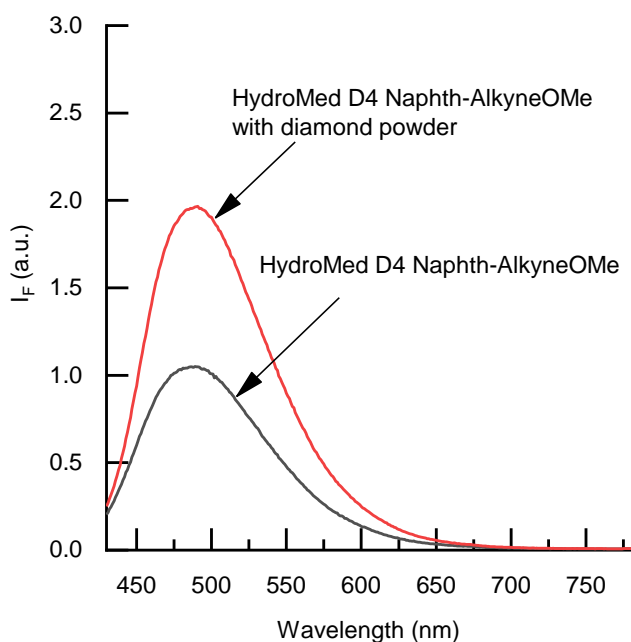

Figure 6 : Optical signal enhancement with the addition of 10%*m* diamond powder in a HydroMed™ D4 array doped with the Naphth-AlkyneOMe probe.

Light artifacts and interference may arise from the optical environment of the sensing device (light leakage, internal reflection, change of geometry, ambient light). Part of the constraint has been neutralized by the utilization of a lock-in amplifier and a reference channel. However, all measurements should be carried out in the dark to prevent ambient light from entering the system through the sensing material. In order to eliminate this limitation, two-layer hydrogels have been developed with the addition of an optical isolation. This optical isolation strategy has already been reported for the development of several pH optodes [5, 18].

The two-layer hydrogels are shaped by a two-step drop casting process. First, carbon black (1 %wt loading) is dispersed in a THF solution of HydroMed™ D4 doped with Naphth-AlkyneOMe. Then, after complete drying of this layer, a second layer, loaded with micro diamond powder and with an identical probe concentration and composition but without the carbon black, is casted on top of the first one (Figure 7). The microdiamonds tend to sediment at the bottom of the top layer, resulting in the formation of a highly reflective interface between the active layer and the insulating layer. This phenomenon, like a tapetum

lucidum, contributes to the increase of the signal. Having the same concentration and composition in both films ensures that no leaching or diffusion of the probe is expected between the two hydrogel layers.

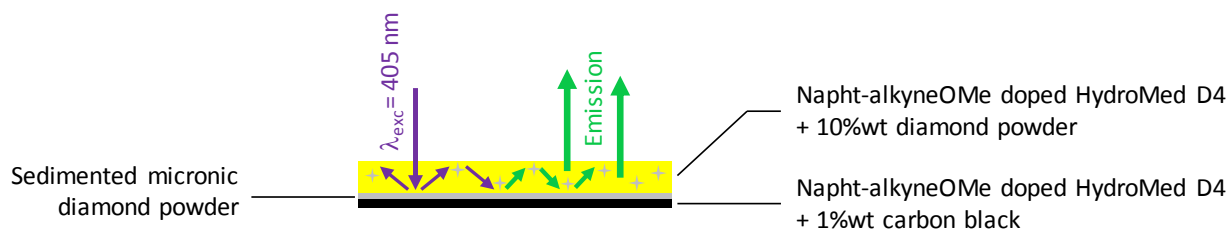

Figure7 : : HydroMed D4 bilayer hydrogel doped with Naphth-AlkyneOMe pH probe

### 3.2. Optimization of the pH optode by ratiometric measurement

In order to overcome external parameters associated with the instability of the excitation source, a variation in the instrument geometry, the background luminescence of the matrix, or the optical properties of the sample [5], we considered performing ratiometric measurements. For this purpose, we implemented an internal reference to the setup whose photoluminescence does not depend on the pH of the environment. The internal reference must present optical properties that does not depend on the pH of the environment and must show an emission distinct from the emission of the pH probe when excited at the same wavelength (*i.e.*  $\lambda_{exc} = 405 \text{ nm}$ ). CdSe/ZnS core-shell type quantum dots (QDs) were selected as they exhibit a predictable and tunable narrow photoluminescence and are photo-stable. The QDs were embedded in a water-impermeable matrix composed of polystyrene that is stable in basic media in order to avoid any influence of pH and sample composition on the QDs photophysical properties. The polystyrene/QDs thin films have been prepared by the same drop casting process as described above. QDs with a maximum wavelength emission at  $\lambda_{em} = 645 \text{ nm}$ , to avoid any spectral overlap with the fluorescence of Naphth-AlkyneOMe, have been selected and a pH optode based on ratiometric fluorescence intensity measurements was manufactured. The QDs concentration in the PS membrane ( $c_{QDs} = 4.5 \text{ mg/g}$  of PS) has been adjusted to compete with the Naphth-AlkyneOMe and to have comparable emission intensity. However, the QDs have a very high molar extinction coefficient ( $\epsilon_{645} \approx 1.1 \times 10^6 \text{ M}^{-1} \cdot \text{cm}^{-1}$ ). Thus, the doped

PS membrane has a high optical density and filters out some of the Naphth-AlkyneOMe emission, implying a decrease in the fluorescence intensity parameters in Equation 1 ( $I_{F_{min}}$  and  $I_{F_{max}}$ ) but not invalidating the concept of ratiometric measurement. Therefore, an emission band centered at  $\lambda = 645$  nm and not varying as a function of pH can be used as an internal reference for pH measurement. The configuration of the sensing unit is modified with the integration of the internal reference and the HydroMed™ D4 bilayer described previously is employed for the measurement. The optode was placed in the fluorimeter using the same configuration carried out previously and presented above [11]. The evolution of the fluorescence as a function of pH is presented in Figure 8a. A decrease of the band corresponding to naphthalimide is observed and the band centered at 650 nm corresponding to the QDs remains constant throughout the addition of hydroxide anions in the solution.

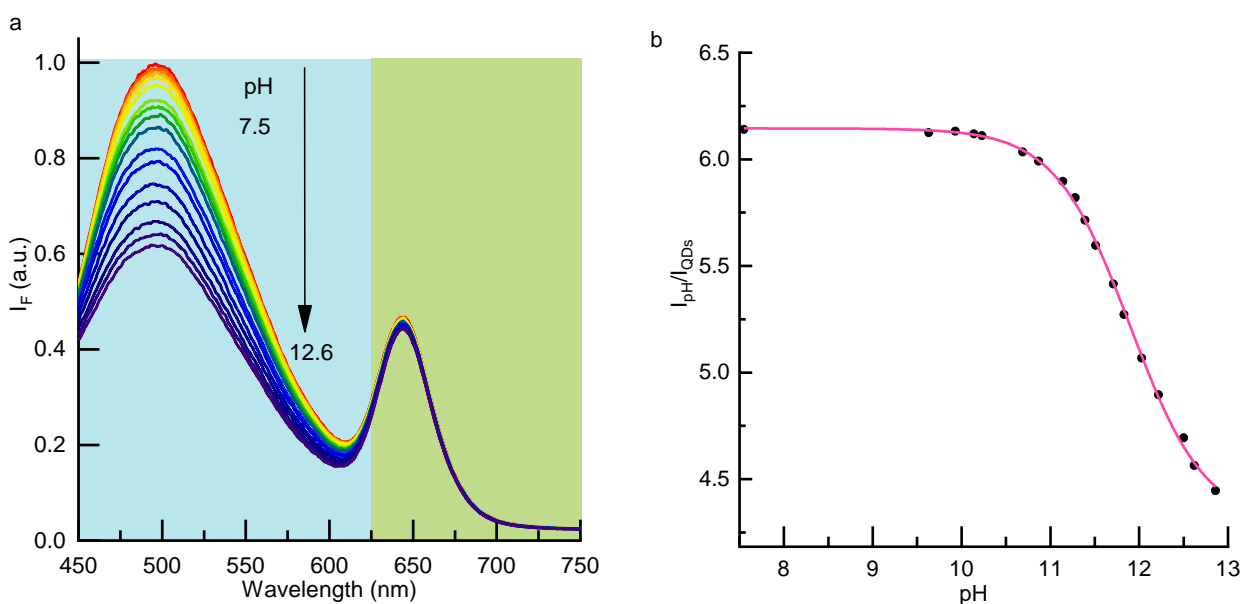

Figure 8 : a. Emission spectrum of a PS membrane doped with CdSe/ZnS QDs emitting around  $\lambda_{em} = 645$  nm superimposed with a HydroMed™ D4 bilayer hydrogel as a function of pH, b Titration curve of HydroMed™ D4 Naphth-AlkyneOMe /QD upon pH,  $\lambda_{exc} = 405$  nm

Referring to the Henderson-Hasselbalch equation, it is possible to relate the evolution of the ratio between the emission of Naphth-AlkyneOMe and the emission of QDs to the pKa (Eq. 1). To this end, three

parameters were defined:  $IF_{\text{Max}}/IQDs$  and  $IF_{\text{Min}}/IQDs$ , respectively the fluorescence intensity of the neutral form and the one of the deprotonated state, and an additional factor  $dpH$  is introduced to take into account the distribution of the  $pKa$  since the probe is distributed in a solid matrix and not dissolved in solution.[8] The evolution of the  $IF_{\text{Max}}/IQDs$  plot as a function of  $pH$  and the numerical fit of the data using Equation 1 is given in Figure 8b and a  $pKa$  value of  $11.90 \pm 0.02$  with a  $dpH$  of  $0.98 \pm 0.02$  was determined. The  $pKa$  is in good agreement with the previously determined value in solution or PVA/GA matrix. The  $dpH$  value very close to unity proves that the  $pH$  probe is in a much more homogeneous environment than in PVA/GA hydrogel.

The measurements were then carried out on the dedicated optical setup presented in Figure 3. The emission of Naphth-AlkyneOMe ( $pH$  channel) is separated from the one of the QDs using a suitable dichroic mirror (605 nm edge) and the two channels are recorded through two photomultiplier tubes. This configuration allows to carry out ratiometric measurements defined as:  $I_f(pH) / I_f(QDs)$ . The intensity plots measured as a function of  $pH$  are presented in figure 9. As shown in figure 9, the signal related to the reference (QDs) remains constant and is independent from the  $pH$  value, on the other hand we observe a decrease of the Naphth-AlkyneOMe signal when the  $pH$  increases. The three-point calibration of the optode, as already reported in the case of the PVA/GA matrix [12], provides a  $pKa$  value of 11.9 in adequate agreement with the curve (Figure 9). The ratio between  $IF_{\text{max}}$  and  $IF_{\text{min}}$  is also a constant parameter overtime, as proven by the post-experiment calibration presented in Figure 9 and was estimated to be 1.23. This is useful since it allows us to normalize all the data to  $IF_{\text{max}} = 1$  and to compare them without taking care of any degradation or variation of the  $pH$  probe signal.

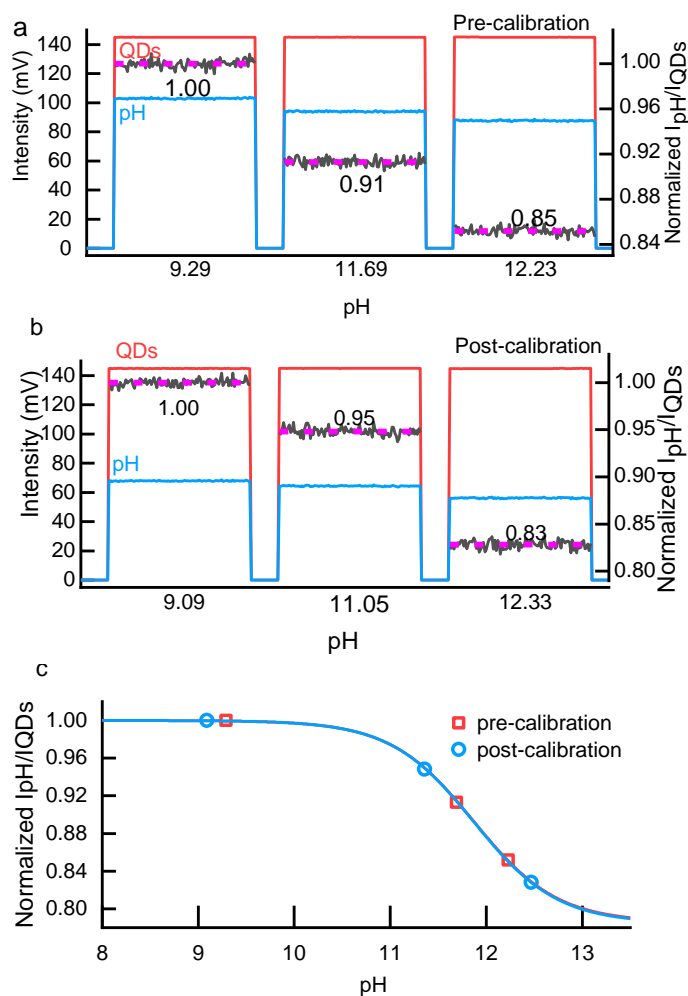
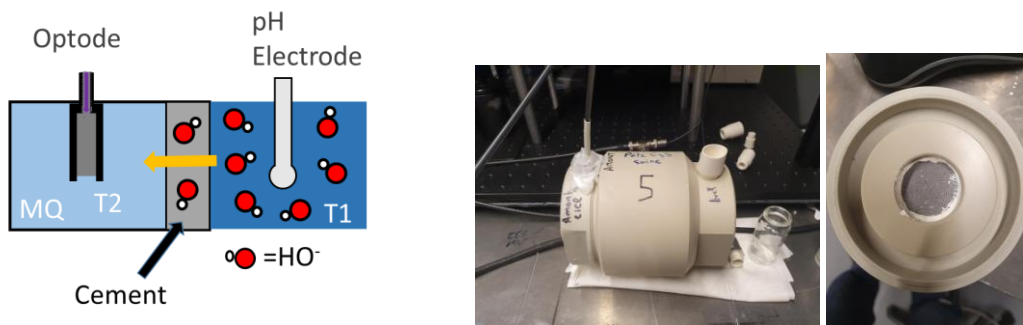

Figure 9 : a optode signal before precalibration , b optode signal before precalibration , c Three-point calibration of the optode at 20°C and the resulting fit according to Eq. 1

This set-up also allows to demonstrate the reversibility of this ratiometric pH optode by performing protonation/deprotonation cycles in buffer solutions ( $\text{NaHCO}_3/\text{Na}_2\text{CO}_3$  pH = 9.0 and  $\text{NaOH}/\text{KCl}$  pH = 12.4) (Figure S1). We observe a slight decrease throughout the cycles attributed to the known degradation of Naphth-AlkyneOMe at a higher pH value on longer time scale. Thus, this pH optode will be best suited for pH measurements below 12, which is well within the range of the target materials such as low-pH cements. No variation in the QDs channel was observed during these measurements, validating their use as a reference.

To validate the accuracy of the optode the pH of a water sample in equilibrium with low pH cement (T2 water) was measured and compared to the value obtained using a glass electrode. The glass electrode displayed a pH value of 11.20, which is well in the range of the type of material. The optode signal is presented on S2 and provides a normalized signal of 0.96. After transposing the ratiometric value on the calibration curve (Figure S2) we obtained a pH value from the optode of 11.22 which is in perfect agreement with the regular glass electrode thus validating the accuracy of our setup in this range for this kind of sample composition. No degradation of the optode has been observed in the few hundreds seconds time window.

### 3.4 Study of the monitoring of water diffusion through a concrete sample



*Figure 10 : Left Principle of the diffusion cell, T1 = water in equilibrium with the cement, T2 MiliQ water, Right picture of the cell*

In order to validate the application of the ratiometric pH optode to the monitoring of low pH cements, measurements on reasonably long time scales in a diffusion cell were performed. The schematic diagram of this cell is presented in figure 10. A sample of low-pH cement paste (5 mm thick) is placed between two isolated compartments containing ultrapure water (T2 / MQ) on one side and water in chemical equilibrium with the cement paste (T1 water) on the other side. The pH in the MQ compartment is monitored over time using the optode and a control is performed on both compartments using a glass electrode and a pH meter

(Figure 11). As shown in Figure 11, an increase in pH in the T2 compartment is observed due to the diffusion of hydroxide anions from and through the sample of cement. The chemical composition of the cement is considered constant thanks to the water and ions reservoir in the T1 compartment compensating for the leaching towards the T2 compartment, which is confirmed by the long-term stability of the pH of the T2 water around 11.20. The pH of MQ water (T2) at the beginning is around 8.1 and reaches a value close to 11 after 250 hours after what it remains stable up to 1800 hours. The initial pH of milli-Q water(T2) is not in the range of 6.5-7 due to the instantaneous leaching of surface ions from the cement. Any slight variation in the chemical composition of this ultrapure water results in dramatic pH changes.

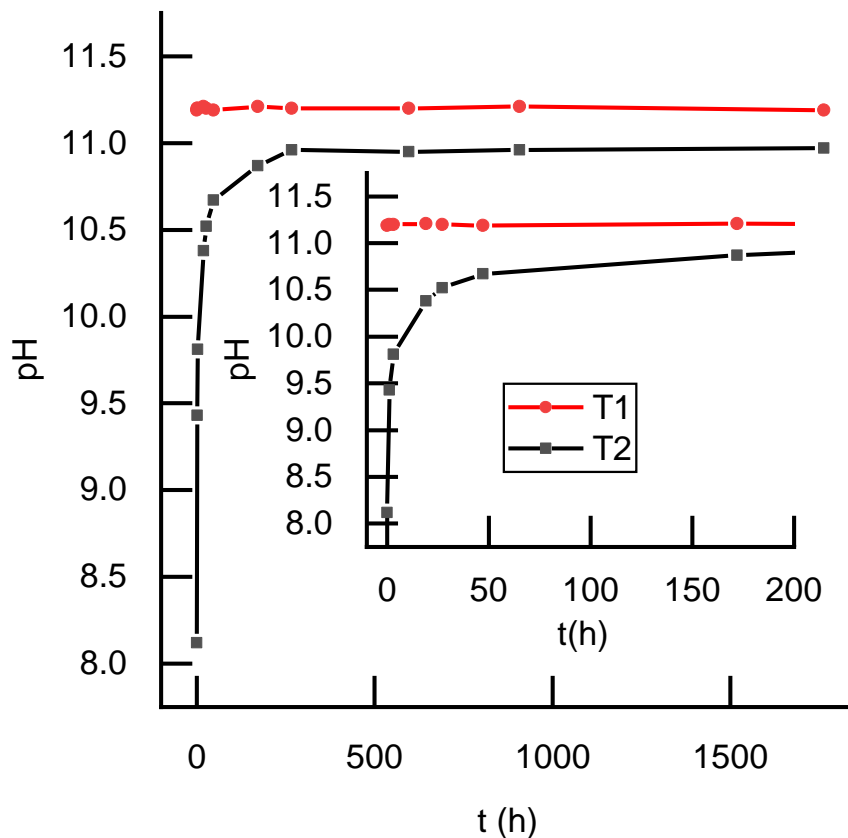

Figure 11 : pH evolution in the two compartments (T2 MQ, T1 ) monitored with a glass electrode

In parallel, measurements were made using the optode based on ratiometric signals. The results obtained with the optode are shown in Figure 12. We plotted the normalized ratiometric signal versus the pH obtained from the glass electrode and we compared the results with the calibration curve obtained above.

We can observe a very good stability up to pH 10.5 and then the signal starts to diverge from the expected trend. This behavior has been attributed to degradation under extended exposure to higher pH value. Indeed, previous experiments and most optodes reported in the literature [5] limit the acquisition time to a few hundred seconds at most and do not leave the detection material immersed in the corrosive solution for a long period. Thus, this type of degradation phenomenon usually goes unnoticed and is only revealed in extreme situations. Since this system is designed to be cast in the cementitious material and to follow the pH over long time scales (months, years), this experiment allows us to test our materials. It has already been reported that imide derivatives are subjected to slow hydrolysis at pH values above 10.5 [19-21]. In our case, this slow degradation is highly noticeable considering the extended timescale of this experiment. Since the hydroxide concentration is larger than the concentration of the probe, it is admitted that the hydrolysis follows a pseudo first order kinetic. Also, considering the very narrow pH range of the experiment where the degradation takes place, the relatively low temperature (20°C) and the data reported in the literature [19] we assumed that the degradation kinetic rate is nearly constant between pH 10.5 and 10.9. In order to validate this degradation, kinetics studies in solutions at pH = 10.8 have been carried out over almost 2000 hours. By monitoring the ratiometric signal pH/QDs of the optode, we have been able to quantify the kinetic of the degradation in conditions equivalent to the ones in the diffusion cell. The results are presented in Figure S3. As expected, it is a very slow process, that could not be noticed on previous experiments made on shorter timescale (few hundreds seconds to few hours). The first order kinetic exponential fit provides a reaction rate coefficient of  $1.6 \times 10^{-7} \text{ s}^{-1}$  and a half-life of 1180 hours. This value is at least 3 orders of magnitude slower than the value previously reported in the literature for similar compounds. The slower degradation might be attributed to two factors, the probe's naphthalimide core is functionalized by an electron donating moiety which is, as reported in the literature [14], a very impactful parameter to limit the hydrolysis of such molecules. Also, the integration of the probe into a semi-rigid polymer matrix might prevent the reorganization of the molecules to allow such reaction. This result corresponds to a very long-term stability, considering its chemical structure, compared to other compounds

under the same conditions [13] which is very promising for application involving organic fluorescent molecular probes.

The parameters extracted from the kinetic fit have been integrated to compensate for the degradation in the pH monitoring in the diffusion cell (Figure 12) at pH values above 10.5. The correction parameters allow the optode data to correspond to very satisfactory pH values and are in perfect agreement with the calibration curves obtained previously. The very long-term values are also accurately corrected and modeled to account for the physico-chemical steady state of the system with a constant pH value close to 11 over nearly 1800 hours.

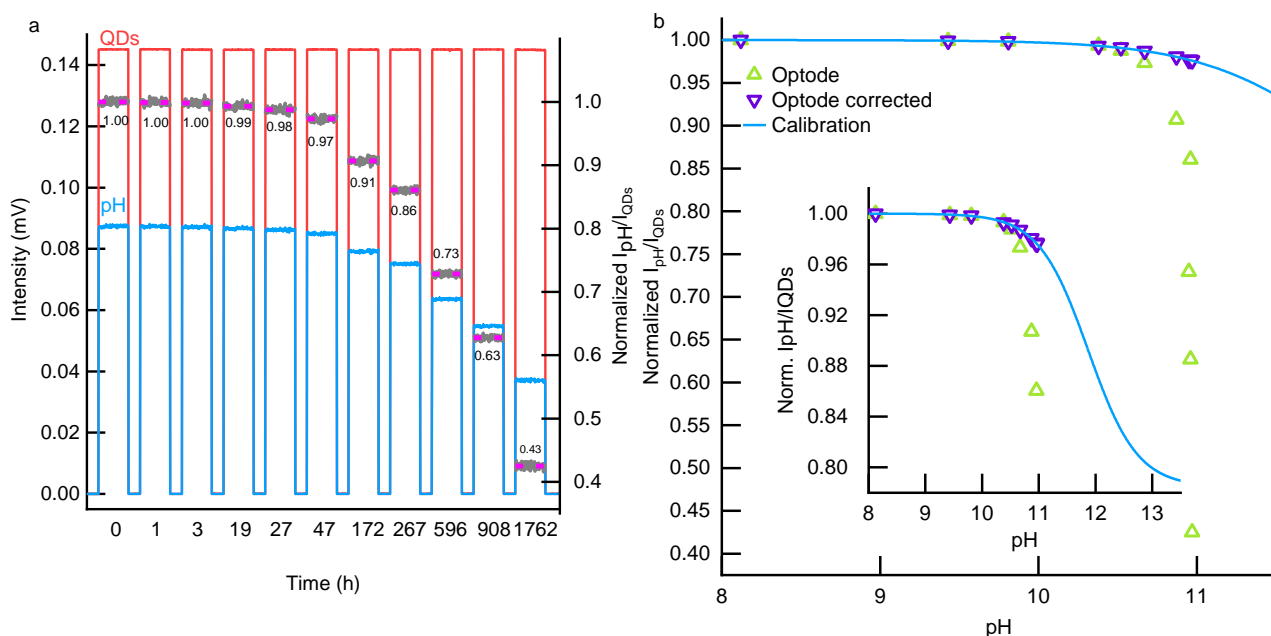

Figure 12 : a) Optode measurements in the T2 compartment ( $I_F$ ,  $I_{QDs}$ ,  $I_F/I_{QDs}$ ), b) resulting calibration curves taking into account the degradation process

To conclude the experiments and validate the proof of concept, the pH values obtained from the optode using Equation 1 have been compared and plotted against the values from the glass electrode. The results are presented in Figure 13. We obtained an astonishing fit between the pH values from the glass electrode and the ones from the optode. The value below pH 10 are less accurate due to the pKa value of the probe (11.9). Indeed, in this area there is almost no variation of fluorescence upon pH change, almost a flat line,

thus the slightest modification leads to a dramatic change. However, in the pH jump area, above 10.5, the values are very accurate compared to the glass electrode and we estimated that we have an error of 0.05 pH value, which competes with a regular pH electrode in terms of accuracy. Therefore, this setup is well adapted to low-pH cementitious material with pH value below 12 and can compete in term of accuracy and robustness with regular pH meter systems.

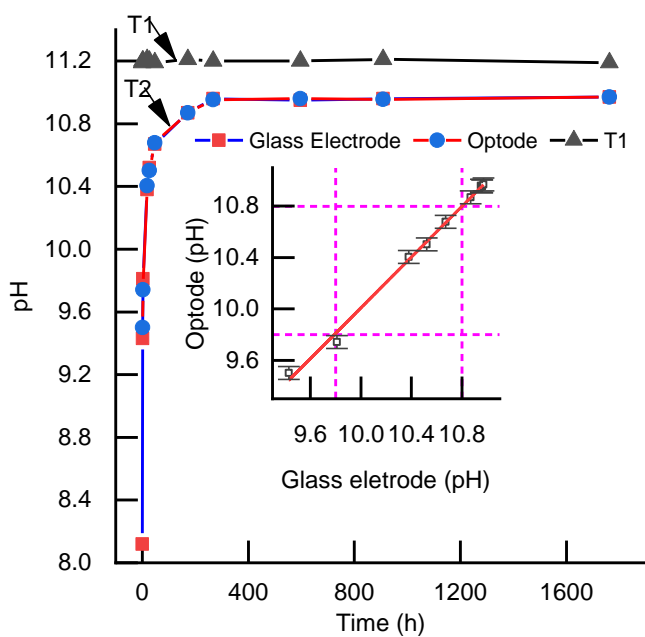

Figure 13 : Comparison between pH measured by the glass electrode and by the optode

## 4. Conclusion

In this paper, we report the development of a ratiometric pH sensor developed by using a bilayer polymer pellet doped with a pH probe and QDs. The composition of the pH-sensitive layer was optimized by adding diamond powder and carbon black to increase the signal's intensity while reducing light artefacts. The optode showed an effective response to pH changes and the ratiometric measurement allowed measurement over long time scales in a robust and sensitive manner. This optode was then applied to measure the diffusion of hydroxyl ions in solution, through a concrete pellet. A pH increase was observed in

solution and the measurements were in good agreement with the measurements taken in parallel by a pH electrode. Long-term stability of the sensor was demonstrated at least for 75 days by including a model to take into account the chemical stability. These measurement methods may be used in the future for monitoring the pH of concrete over long time scales.

## Références

- [1] D. Shevtsov, N.L. Cao, V.C. Nguyen, Q.Q. Nong, H.Q. Le, D.A. Nguyen, et al., Progress in Sensors for Monitoring Reinforcement Corrosion in Reinforced Concrete Structures-A Review, *Sensors (Basel)*, 22(2022).
- [2] G. Plusquellec, M.R. Geiker, J. Lindgård, J. Duchesne, B. Fournier, K. De Weerd, Determination of the pH and the free alkali metal content in the pore solution of concrete: Review and experimental comparison, *Cem. Concr. Res.*, 96(2017) 13-26.
- [3] A. Wiora, J. Wiora, Over One-Year Long-Term Laboratory Tests of pH Electrodes in Terms of Industrial Applications Checking Stabilities of Their Parameters and Their Influence on Uncertainties of Measurements, *Sensors (Basel)*, 18(2018).
- [4] Z. Du, P. Wang, Z. Chen, D. Cui, Z. Jin, H. Zhang, All-solid-state, long term stable, and embedded pH sensor for corrosion monitoring of concrete, *Journal of Building Engineering*, 57(2022).
- [5] A. Steinegger, O.S. Wolfbeis, S.M. Borisov, Optical Sensing and Imaging of pH Values: Spectroscopies, Materials, and Applications, *Chem Rev*, 120(2020) 12357-489.
- [6] K. Koren, S.E. Zieger, Optode Based Chemical Imaging-Possibilities, Challenges, and New Avenues in Multidimensional Optical Sensing, *ACS Sens.*, 6(2021) 1671-80.
- [7] D. Aigner, S.M. Borisov, I. Klimant, New fluorescent perylene bisimide indicators--a platform for broadband pH optodes, *Anal Bioanal Chem*, 400(2011) 2475-85.
- [8] T.H. Nguyen, T. Venugopala, S.Y. Chen, T. Sun, K.T.V. Grattan, S.E. Taylor, et al., Fluorescence based fibre optic pH sensor for the pH 10-13 range suitable for corrosion monitoring in concrete structures, *Sens. Actuators, B*, 191(2014) 498-507.
- [9] M. Blumentritt, K. Melhorn, J. Flachsbarth, M. Kroener, W. Kowalsky, H.-H. Johannes, A novel fabrication method of fiber-optical planar transmission sensors for monitoring pH in concrete structures, *Sens. Actuators, B*, 131(2008) 504-8.
- [10] S.D. Nielsen, I. Paegle, S.M. Borisov, K.U. Kjeldsen, H. Roy, J. Skibsted, et al., Optical Sensing of pH and O<sub>2</sub> in the Evaluation of Bioactive Self-Healing Cement, *ACS Omega*, 4(2019) 20237-43.
- [11] A. Tariq, U. Garnier, R. Ghasemi, J. Pierre Lefevre, C. Mongin, A. Brosseau, et al., Perylene based PET fluorescent molecular probes for pH monitoring, *J. Photochem. Photobiol., A*, 432(2022).
- [12] A. Tariq, J. Baydoun, C. Remy, R. Ghasemi, J.P. Lefevre, C. Mongin, et al., Fluorescent molecular probe based optical fiber sensor dedicated to pH measurement of concrete, *Sens. Actuators, B*, 327(2021).
- [13] J. Bartelmess, D. Zimmek, M. Bartholmai, C. Strangfeld, M. Schaferling, Fibre optic ratiometric fluorescence pH sensor for monitoring corrosion in concrete, *Analyst*, 145(2020) 2111-7.
- [14] C. Remy, C. Allain, I. Leray, Synthesis and photophysical properties of extended pi conjugated naphthalimides, *Photochem. Photobiol. Sci.*, 16(2017) 539-46.
- [15] A. Tariq, J. Baydoun, C. Remy, R. Ghasemi, J.P. Lefevre, C. Mongin, et al., Fluorescent molecular probe based optical fiber sensor dedicated to pH measurement of concrete, *Sens. Actuators, B*, 327(2021) 128906.
- [16] D. Pfeifer, I. Klimant, S.M. Borisov, Ultrabright Red-Emitting Photostable Perylene Bisimide Dyes: New Indicators for Ratiometric Sensing of High pH or Carbon Dioxide, *Chem. Eur. J.*, 24(2018) 10711-20.
- [17] C. Staudinger, J. Breininger, I. Klimant, S.M. Borisov, Near-infrared fluorescent aza-BODIPY dyes for sensing and imaging of pH from the neutral to highly alkaline range, *Analyst*, 144(2019) 2393-402.

- [18] M. Moßhammer, M. Strobl, M. Kühn, I. Klimant, S.M. Borisov, K. Koren, Design and Application of an Optical Sensor for Simultaneous Imaging of pH and Dissolved O<sub>2</sub> with Low Cross-Talk, *ACS Sensors*, 1(2016) 681-7.
- [19] M.N. Khan, Aqueous degradation of N-(hydroxymethyl)phthalimide in the presence of specific and general bases. Kinetic assessment of N-hydroxymethyl derivatives of nitrogen heterocycles as possible prodrugs, *J Pharm Biomed Anal*, 7(1989) 685-91.
- [20] R.A. McClelland, N.E. Seaman, J.M. Duff, R.E. Branston, Kinetics and equilibrium in the ammonolysis of substituted phthalimides, *Can. J. Chem.*, 63(1985) 121-8.
- [21] Y.-L. Sim, W.H. Wan Ahmad, M.Y. Cheong, A. Ariffin, M.N. Khan, Kinetics and Mechanism of Hydrolysis of N-Arylphthalimides, *Progress in Reaction Kinetics and Mechanism*, 34(2009) 347-59.