



HAL
open science

Integrable inductance measurement system for wire harness health check in electrical vehicle

Koami Kpoto, Federico Bribiesca Argomedo, Guy Clerc, André Mourrier,
Bruno Allard

► **To cite this version:**

Koami Kpoto, Federico Bribiesca Argomedo, Guy Clerc, André Mourrier, Bruno Allard. Integrable inductance measurement system for wire harness health check in electrical vehicle. IECON 2023- 49th Annual Conference of the IEEE Industrial Electronics Society, Oct 2023, Singapore, France. pp.1-6, 10.1109/IECON51785.2023.10312090 . hal-04562740

HAL Id: hal-04562740

<https://hal.science/hal-04562740>

Submitted on 29 Apr 2024

HAL is a multi-disciplinary open access archive for the deposit and dissemination of scientific research documents, whether they are published or not. The documents may come from teaching and research institutions in France or abroad, or from public or private research centers.

L'archive ouverte pluridisciplinaire **HAL**, est destinée au dépôt et à la diffusion de documents scientifiques de niveau recherche, publiés ou non, émanant des établissements d'enseignement et de recherche français ou étrangers, des laboratoires publics ou privés.

Integrable inductance measurement system for wire harness health check in electrical vehicle

Koami Kpoto

Univ Lyon, INSA Lyon, Université
Claude Bernard Lyon 1, Ecole Centrale
de Lyon, CNRS, Ampère, UMR5005,
69621 Villeurbanne, France
koami.kpoto@insa-lyon.fr

Guy Clerc

Univ Lyon, Université Claude Bernard
Lyon 1, INSA Lyon, Ecole Centrale de
Lyon, CNRS, Ampère, UMR5005,
69621 Villeurbanne, France.
guy.clerc@univ-lyon1.fr

Bruno Allard

Univ Lyon, INSA Lyon, Université
Claude Bernard Lyon 1, Ecole Centrale
de Lyon, CNRS, Ampère, UMR5005,
69621 Villeurbanne, France.
bruno.allard@insa-lyon.fr

Federico Bribiesca Argomedo

Univ Lyon, INSA Lyon, Université
Claude Bernard Lyon 1, Ecole Centrale
de Lyon, CNRS, Ampère, UMR5005,
69621 Villeurbanne, France.
federico.bribiesca-argomedo@insa-
lyon.fr

André Mourrier

Automotive Smart Power,
Infineon Technologies France,
13160 Puy Sainte Réparate, France
Andre.Mourrier@infineon.com

Abstract— During their lifetime, electrical wires and connectors in cars are ageing and can induce short-circuit or open circuit, due to the external environment or technical intentional action. It is therefore possible to see changes in the overall system behavior thus compromising the system safety and reliability. There is consequently an issue about diagnosis and maintenance. In modern cars, the electrical wire harness maintenance and diagnosis become crucial due to automated driving. Estimating the line impedance (resistance and inductance) is beneficial to the evaluation of the health state of the wire harness during their lifetime in the vehicle. It is very difficult to measure the very low line inductances through an integrated system. Moreover, the required measurement sensitivity is even harder to achieve if a very small variations of about $0.1 \mu H$ is a target over a wide range of inductance values (e.g. $6 \mu H$) This paper describes a new method for implementing an embedded measurement of the wire inductance and detect a relative variation of about $0.1 \mu H$.

Keywords— Inductance measurement, wire health check, wire diagnosis, electrical power network, predictive maintenance, impedance measurement, wire aging, connector aging, wire protection, electrical vehicle, smart fuse.

I. INTRODUCTION

Requirements for a high availability of comfort, connectivity, and safety functions in modern transport (vehicle, aircraft, etc.) leads to an increase in on-board electronics [1]. More elements (cables, connectors, fuses...) are therefore taking place in electrical wire harnesses. Electrical power distribution networks become complex and cumbersome. As a result, accumulated length of wire harness rose up in automotive systems. For instance, in modern vehicles, all these comforts are available thanks to embedded electronics into onboard network, which weight grows up toward about 50kg consisting of at least 1500 cables measuring between 1m and 10m in length, as well as relays, connectors, fuses...[2], [3]. Consequently, modern vehicles consume more energy giving rise to a huge impact on environment in term of green-house gas.

During their lifetime, wires can be damaged leading to serious issues of safety, reliability, maintenance and diagnosis. Indeed, electrical connectors suffer aging and also

short-circuit or open circuit can occur due to some technical mistake or external environment. It is therefore possible to see changes in the overall system behavior, compromising the system safety. If the latter issues are well known as critical so far for aeronautic and nuclear system, it becomes more and more significant in automotive sector.

Besides, the current protection doesn't consider the wire harness aging. Regarding a traditional fuse, the wires will appear less and less able to operate safely depending on a protection at nominal power. Even if the fuse eventually comes to blow conveniently, it should be replaced with a new one to ensure the protection [4]. Traditional relays used jointly with fuse have high internal resistance giving rise to high power dissipation. So, in a next generation, it is planned to replace the traditional fuse by a semiconductor-based fuse known as "smart fuse" [5], [6]. With a *smart fuse*, lower dissipative power may be achieved compared to the traditional one. A smart fuse allows to have less margin between supply line melting point and its own protection so the wire size is no more oversized. Interestingly, it enables a closed-loop control capability: the protection system could be controlled and adjusted off-line during the lifetime of vehicles [7]. Thus, it would be very convenient to capitalize this capability of smart fuse to improve the protection during the wire harness lifetime in a vehicle. To do that, wire health state parameters like resistance or inductance are needed to estimate the network health state so that an appropriate protection is provided.

So far, to know the health state or to detect defaults in cable, different methods have been used. It could be a technique like visual inspection, X-rays, ultrasound guided wave, infrared and thermal imaging, continuity measurement, high pot, pulse arrested spark discharge [8]–[10] or reflectometry [3], [11]–[15] depending on the application. Most of the methods are non-embeddable except reflectometry. Reflectometry consists in injecting a probe signal at one end of the cable under test. This signal propagates along the cable and each impedance discontinuity (junction or fault) returns a part of its energy towards the injection port. The analysis of the received signal provides information on the presence, localization and the type of discontinuity [14]. Various researches on reflectometry in time and frequency domain

give rise to accurate and effective methods able to be embedded for application like aeronautic sector [13]–[15]. Despite their advantages, reflectometry sensors are expensive for automotive applications [16]. In addition, sensor-based reflectometry is not yet integrable in a chip. In that way, paper [16] proposes an integrable circuit to detect open (measuring capacitance) and short circuit (measuring inductance). Even though it's a simple and integrable in chip, it is limited for diagnosis and predictive maintenance purpose.

Furthermore, for various reasons, there is a requirement for Original Equipment Manufacturers (OEMs) to provide suitable, reliable and cost-effective systems for wire diagnosis regarding aging, predictive maintenance, wire harness conformity check at manufacturing step, etc. In this perspective, providing accurate and reliable data related to the variation of the wire parameters like its inductance will be useful to monitor the wire health during the vehicle lifetime. This paper details a method suitable for subsequent integration to measure the line inductance of a wire in vehicle with an accuracy of $0.1 \mu H$.

II. GOLDEN UNIT AND HEALTH CHECKING METHOD

The goal is to build a system that can be integrated into the new upcoming semiconductor-based fuses. For instance, Infineon PROFET™ smart fuse is specifically designed to drive high current loads up to 40A in automotive applications such as heaters, glow plugs, pumps and fans, where high energy capability is required. Their ability to drive high current loads makes them well suited to replace electromechanical relays and fuses in power distribution and other applications in a 12V network [2]. So, the purpose of this work is to establish a diagnosis method able to be integrated into a smart fuse like a PROFET™ one.

To control the health state of the power network, a golden unit concept is introduced. The golden unit concept consists in a perfect and healthy power network to establish a reference wire inductance map. Initially, the developed estimation method will be used to establish the reference impedance map (e.g. inductance) of the healthy wire harness. The goal of the golden unit impedance map shown in Fig. 1 is to set the initial reference for comparison to later measurements. Therefore, it becomes possible to quantify if it exists a variation in the measured parameters of the wire harnesses. The inductance measurement method will be presented.

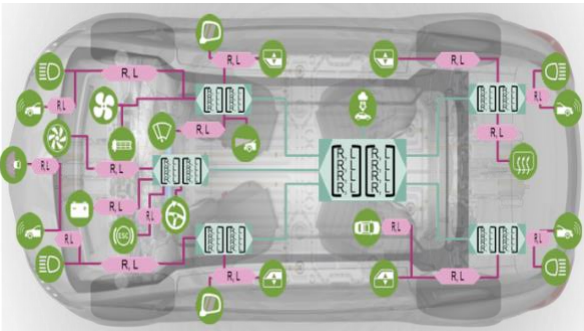

Fig. 1: Golden unit impedance map

III. LINE INDUCTANCE MEASUREMENT SYSTEM (LIMS)

The line inductance measurement system consists in charging a so-called capacitor C_{detect} during a known time t_d by the voltage source V_{bat} . When measuring the voltage V_d across the capacitor C_{detect} in the case of a step transient stimulus, the effective inductance L of the wire branch can be computed since the voltage across the capacitor and its charging time depend mainly on the inductance L which is principally related to the wire length at constant frequency and in a same environment [18]–[20]. Consequently, variation of the capacitor charging time in similar stimulus conditions means a variation in wire inductance. Fig. 2-a) shows the electrical schematic of the system where the battery supplies the load through a smart fuse and the wire-under-test, which is modeled by series of resistance and inductance. During the measurement process the smart fuse closes the circuit with the sensor capacitor C_{detect} and the related measurement circuitry as depicted in Fig. 2-b).

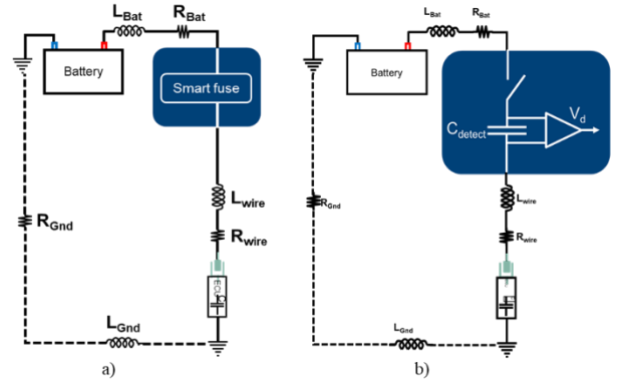

Fig. 2: LIMS Concept schematic

If R and L are respectively the equivalent resistance and inductance of the measured loop, the measured voltage across the capacitor C_{detect} is an ordinary RLC step response described by (1).

$$V_d(t) = V_{bat} \left(1 - \left(\cos(\omega_0 t) - \left(\frac{\lambda}{\omega_0} \right) * \sin(\omega_0 t) \right) e^{-\lambda t} \right) \quad (1)$$

Where:

$$\omega_0 = \frac{1}{\sqrt{LC_{detect}}} - \text{natural frequency}$$

$$\lambda = \frac{R}{2L} - \text{damping factor}$$

t - time

To identify the variation of inductance, two methods are developed based on either time or voltage measurement:

A. Time method

It consists to set a specified voltage V_L and to record the charging time t_d needed by the sensor capacitor C_{detect} to reach the voltage level, V_L . Fig. 3 depicts this measurement method.

For two different values of inductance L (L_1, L_2), Fig. 4 shows the voltage across the sensor capacitor C_{detect} clamped at maximum voltage of 10V. In fact, for a variation of inductance L (L_1 to L_2), there is a variation of the charging time $\Delta t = t_{d1} - t_{d2}$. So, based on the variation of charging time, the inductance variation could be estimated.

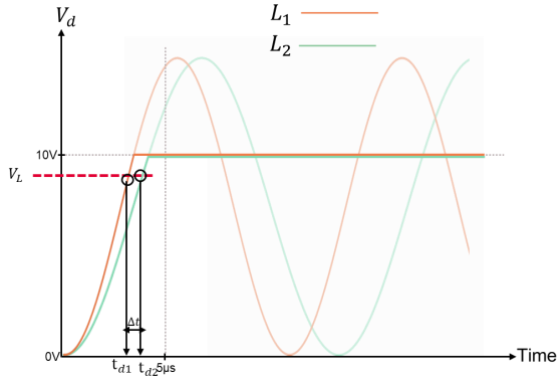

Fig. 3: Time measurement method

B. Voltage method

The second method consists to set a specified charging time (t_L). At the end of the charging time, the voltage V_d across C_{detect} is measured. So, any variation in measured voltage means a variation of inductance as shown in Fig. 4. It is therefore possible to estimate the measured inductance value based on t_L and V_d .

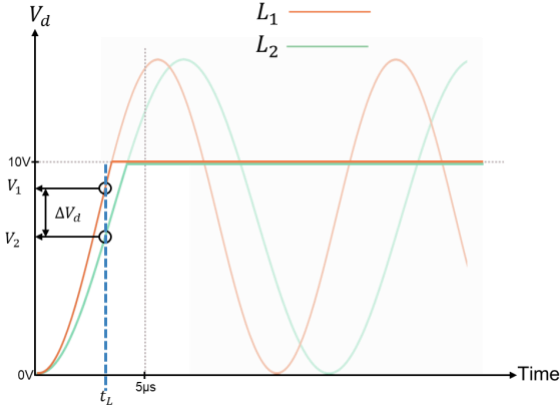

Fig. 4: Voltage measurement method

Although the above two methods are able to measure inductance variation, a high resolution over a wide voltage range is required. Consequently, high frequency clock and large size of Analog to Digital Converter (ADC) are necessary. Then, it has been found that it is possible to get a high resolution with less resources by combining the above two methods.

C. Auto-adaptive time floating method: combination of time and voltage methods

Instead of considering either time or voltage measurement method, the proposed approach consists in measuring the charging time t_d while the capacitor voltage V_d is between a predefined range. This method named as auto-adaptive time floating voltage measurement is described by the flowchart in Fig.5.

This method is interesting since it allows to get a good resolution while reasonable resources are used. Table 1 shows the comparison of described methods. When using auto-adaptive time floating voltage measurement method, for the same sensitivity, the clock frequency can be reduced from 100MHz to 10MHz as compared to time method while ADC

size is reduced from 10Bits to 4Bits compared to the voltage method.

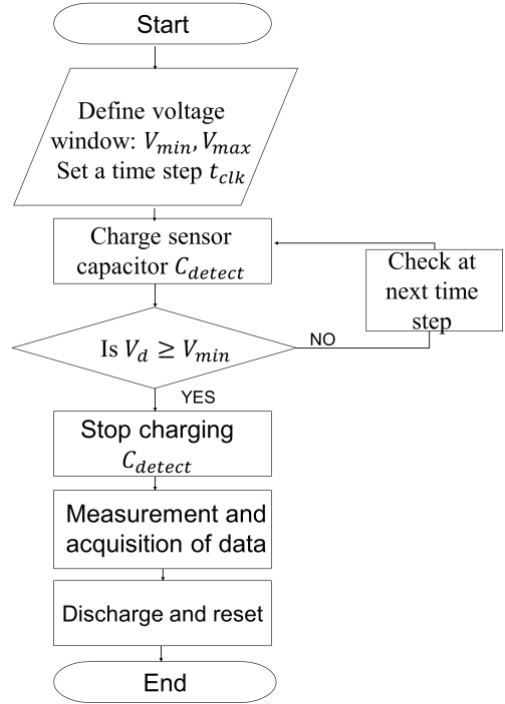

Fig. 5: Auto-adaptive time floating method flowchart

Table 1: Inductance measurement methods comparison

Method	Target sensitivity	Clock frequency	ADC size
Time measurement	$\frac{0.1\mu H}{6\mu H} = 1.67\%$	100MHz	9Bits
Voltage measurement		10MHz	10Bits
Auto-adaptive time floating voltage measurement		10MHz	4Bits

In next sections, the auto-adaptive time floating voltage measurement method is used to measure wire inductance values.

IV. RESULTS

To validate the proposed method, a discrete-device circuit board (PCB) has been made. The discrete components are wisely designed and chosen so that the measurement system could be integrated into a chip.

A. Simulation vs experimental

Firstly, the board is used to measure discrete inductances. The output experimental data (t_{dE}, V_{dE}) are compared to simulation data (t_{dS}, V_{dS}) obtained for the same values of inductance. The measurement setup is shown in Fig. 6.

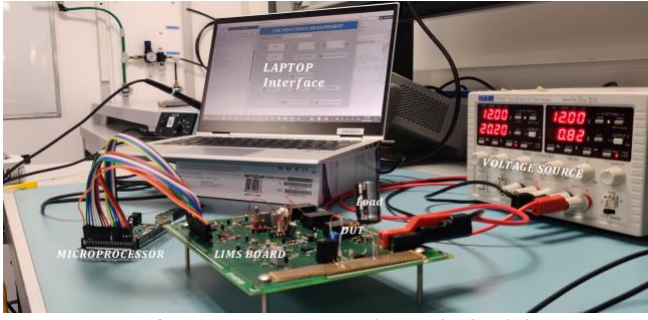

Figure 6: Measurement setup for method validation

An Arduino microprocessor is used to control the board through a suitable designed interface (with MATLAB). The device under test (i.e. measured inductance) is in series with a capacitive load of $4700\mu\text{F}$. Note that, today with the massive use of electronics which facilitates the control of loads, more loads in car have capacitive behavior. For instance, there will be more and more so-called smart loads optimizing energy consumption. In addition, for reasons of flexibility, manufacturers put electronic systems at the end of line to adapt the lines to any type of load. Then, motors will have their control electronics completely embedded [21]-[23]. Thus, the main loads (between 80 to 90%) in modern vehicles will be capacitive load type. It follows that in the context of this work, loads are considered to be capacitive between $10\mu\text{F}$ to $4700\mu\text{F}$.

Based on the aforementioned setup, the experimental measurement has been performed for reference inductances from $1\mu\text{H}$ to $6\mu\text{H}$. To ensure the robustness of data, each inductance has been measured in similar conditions over 100 times. Fig. 7 shows the result of these measurements.

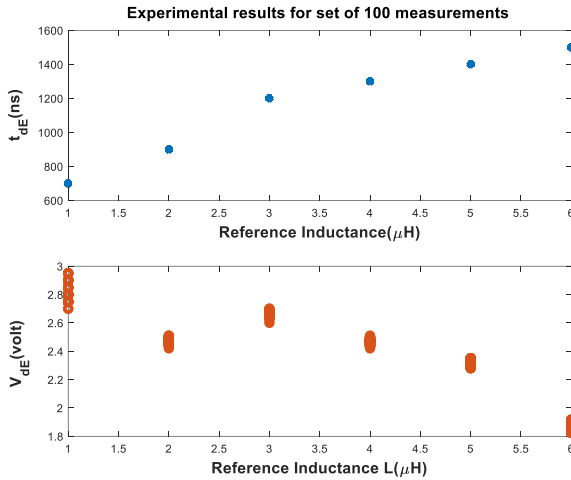

Figure 7: Experimental measurement data

It's very interesting to observe that measured experimental time is unvaried over the hundred measurement for each inductance. However, the measured voltage can face some variation with maximum value of 0.2V compared to the minimum measured voltage when the inductance value is the lowest (i.e. $1\mu\text{H}$). To evaluate the robustness of measured voltage data, Fig. 8 gives the deviation of measurements from the overall average for each inductance value.

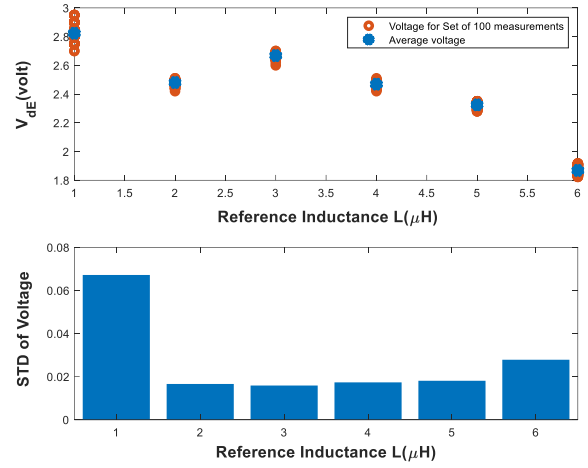

Figure 8: Robustness check using standard deviation

The voltage standard deviation (STD) is also depicted for each inductance. The maximum deviation of 6.7% is observed for $1\mu\text{H}$ inductance while for others inductance it is around 2% . It shows that the deviation in each measurement is relatively small. Consequently, one could consider the voltage measurement as sufficiently robust for inductance estimation. Moreover, since the measured time is unique for each inductance, the combination of measured time and voltage (t_{dE}, V_{dE}) gives rise to a strong and robust data to differentiate inductance variation.

Table 2 gives the comparison between the simulation and experimental data of the experimental average voltage V_d .

Table 2: Simulation and experimental measurements data

$L(\mu\text{H})$	Experimental		Simulation	
	$t_{dE}(\text{ns})$	$V_{dE}(\text{V})$	$t_{dS}(\text{ns})$	$V_{dS}(\text{V})$
1	700	2.83	700	2.21
2	900	2.43	900	1.6
3	1200	2.6	1200	2.93
4	1300	2.46	1300	2.23
5	1400	2.32	1400	1.84
6	1500	1.83	1500	1.65

Simulation and experimental time are always the same for all measured inductance between $1\mu\text{H}$ to $6\mu\text{H}$. For measured voltage V_d , there is a small difference that can be explained. In fact, this difference is due to various reason. For instance, at the end of measurement even capacitor C_{det} and load capacitor are discharged, the initial voltage across them could not be the same at the next measurement introducing some measurement deviation. In addition, ADC conversion could add some conversion errors. Moreover, the accuracy of the measurement depends also on the speed of the threshold detector and the stability of the clock frequency. Even thought, the difference between simulation and measurement remains acceptable and it does not affect the inductance estimation. Results are quite encouraging and enough to validate the method. In the next section, this method will be used to estimate a wire inductance in preparation of wire harness health check perspective.

B. Application to wire inductance estimation

Table 2 shows a good agreement between simulation results and experimental ones. Therefore, due to unavailable large amount of data for experimental measurement, to estimate the linear inductance of wire, a database has been built based on simulation data for inductance from $1\mu H$ to $10\mu H$ with a variation step of $0.1\mu H$. Then, to estimate inductance of a given wire length, the measured time t_d and voltage V_d are used to find the corresponding inductance thanks to an interpolation algorithm build upon the aforementioned database.

Inductance is estimated for wire length variation of $10cm$ from $1m$ to $6m$. Measurement setup shown in Fig. 9 is used to measure the line inductance of wires with diameter $d = 2mm$ and hold at distance of $10mm$ from the ground (metallic ground plane).

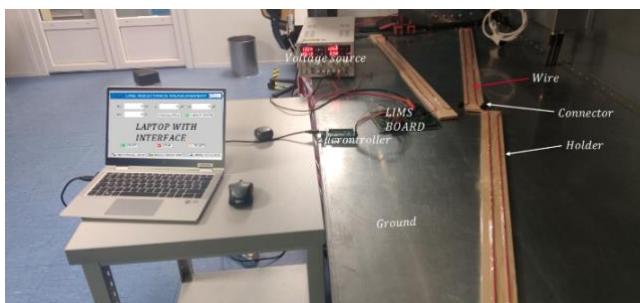

Figure 9: Measurement setup for wire inductance estimation

By using above setup and considering capacitive loads of $4700\mu F$, measurement results for $1m$ to $6m$ wire are given in Fig. 10.

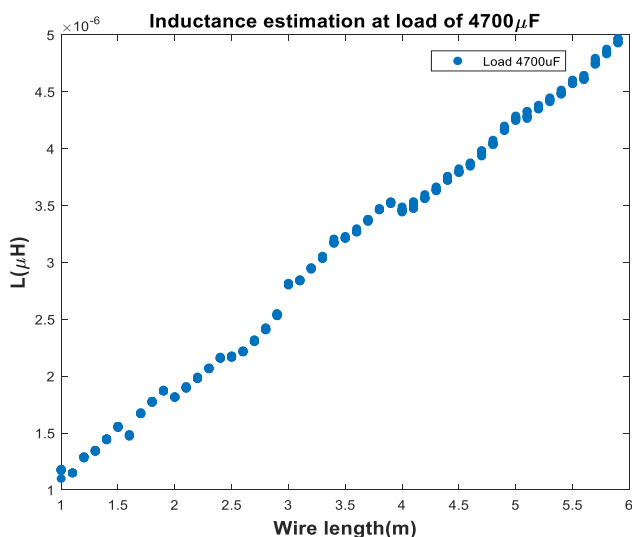

Figure 10: Wire inductance estimation

Experimental results of line inductance validate the auto-adaptive floating time measurement method. As it is shown in Fig. 10, by using raw data (t_d, V_d), the wire inductance can be estimated. For instance, the inductance value estimated for $1m$ wire length is about $1.1\mu H$ while it is estimated to be $5.2\mu H$ for $6m$ wire length considering the defined setup in Fig. 9. Note that, due to lack of space on the testbench, for wire length above $2m$, $1m$ wires are connected in series to get

the desired wire length as shown in Fig. 9. The distance between two wires is approximately $3cm$ when two wires come to be on the same holder. This changes in setup configuration from one desired wire length to another can explain some deviation. Consequently, it could explain the fact that the estimated inductance is not strictly linear from $1m$ to $6m$ since wires become parallel and the environment conditions of one specific wire change. Despite, it proves that the developed method is sensitive enough to be able to detect geometric abnormality in wire harness. Importantly, it's possible to detect a variation of $10cm$ in wire length which is approximately $0.1\mu H$ leading to promising application. To see how a change in capacitive load could affect the measurement results, Fig. 11 depicts a comparison of estimated inductance ($1m$ to $6m$) with a $10\mu F$ and $4700\mu F$ load respectively and under short circuit.

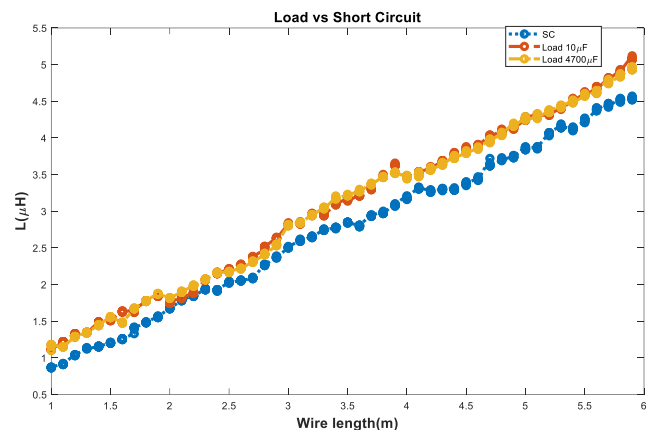

Figure 11: Effect of load capacitor variation on inductance estimation: short circuit, $10\mu F$ and $4700\mu F$ loads

As depicted in Fig. 11, there is no significant difference in the inductance value estimation for a capacitive load variation between null and $4700\mu F$. It means that the measurement scheme is robust enough. Oppositely, when load becomes short circuited, auto-adaptive time floating voltage measurement, helps to detect that fault since estimated inductance get changed.

V. CONCLUSION

The experimental results confirm the validation of the Auto-adaptive time floating voltage measurement for estimation of wire inductance. This method helps to measure inductance variation down to $0.1\mu H$ leading to promising application for modern car diagnosis and predictive maintenance. That makes it is possible to detect a variation of $10cm$ in wire length. Then, an inductance map of the vehicle could be established to check health state of wire harness at manufacturing step and during its lifetime. As further development, a resistance measurement method should be developed as a global to map wire impedance.

REFERENCES

- [1] A. Pradhan, Current Trends in Automotive Wire Harness Design. 2011.
- [2] C. Gamelon and J.-L. Prensier, "Annexe : Le problème du câblage électrique d'une automobile," p. 3.

- [3] M. Oumri, "Diagnostic des défauts de réseaux électriques filaires par la réflectométrie," These de doctorat, Paris 11, 2014. Accessed: Mar. 12, 2021. Available: <http://www.theses.fr/2014PA112090>
- [4] V.-S. Duong, "Etude de l'intégration d'une protection par fusible dans les convertisseurs à IGBT," p. 224.
- [5] R. Letor and R. Crisafulli, "Smart Power devices and new electronic fuses compliant with new E/E architecture for autonomous driving," in 2019 AEIT International Conference of Electrical and Electronic Technologies for Automotive (AEIT AUTOMOTIVE), Jul. 2019, pp. 1–6. doi: 10.23919/EETA.2019.8804538.
- [6] M. Gerten, S. Frei, M. Kiffmeier, and O. Bettgens, "Voltage Stability of Automotive Power Supplies During Tripping Events of Melting and Electronic Fuses," in 2022 IEEE 95th Vehicular Technology Conference: (VTC2022-Spring), Jun. 2022, pp. 1–6. doi: 10.1109/VTC2022-Spring54318.2022.9860939.
- [7] F. Auzanneau, "Wire troubleshooting and diagnosis: Review and perspectives," *Progress In Electromagnetics Research B*, vol. 49, pp. 253–279, Jan. 2013, doi: 10.2528/PIERB13020115.
- [8] T. Denton, *Advanced Automotive Fault Diagnosis: Automotive Technology: Vehicle Maintenance and Repair*. Routledge, 2016.
- [10] J. Cheng, J. Qiu, H. Ji, E. Wang, T. Takagi, and T. Uchimoto, "High precision ultrasonic guided wave technique for inspection of power transmission line," *Chin. J. Mech. Eng.*, vol. 30, no. 1, pp. 170–179, Jan. 2017, doi: 10.3901/CJME.2016.1019.122.
- [11] A. Lelong and M. O. Carrion, "On line wire diagnosis using Multicarrier Time Domain Reflectometry for fault location," in 2009 IEEE SENSORS, Oct. 2009, pp. 751–754. doi: 10.1109/ICSENS.2009.5398542.
- [12] L. E. Sahmarany, "Méthodes d'amélioration pour le diagnostic de câble par réflectométrie," p. 196.
- [13] F. Auzanneau, *Embedded aeronautic harness monitoring and reliability*. 2014. doi: 10.13140/2.1.3175.2324.
- [14] F. Auzanneau, M. Olivas Carrion, and N. Ravot, "A Simple and Accurate Model for Wire Diagnosis Using Reflectometry," Jan. 2007.
- [15] F. Auzanneau, L. Incarbone, W. Ben Hassen, and evain, *OMTDR Based Integrated Cable Health Monitoring System SmartCo: An embedded reflectometry system to ensure harness auto-test*. 2015. doi: 10.1109/ICIEA.2015.7334396.
- [16] You Chung Chung, N. N. Amarnath, and C. M. Furse, "Capacitance and Inductance Sensor Circuits for Detecting the Lengths of Open- and Short-Circuited Wires," *IEEE Trans. Instrum. Meas.*, vol. 58, no. 8, pp. 2495–2502, Aug. 2009, doi: 10.1109/TIM.2009.2014617.
- [17] I. T. AG, "PROFETTM +2 12V | Automotive Smart High-Side Switch - Infineon Technologies." <https://www.infineon.com/cms/en/product/power/smart-low-side-high-side-switches/high-side-switches/profet-plus-2-12v-automotive-smart-high-side-switch/> (accessed Mar. 10, 2022).
- [18] E. B. Rosa, "The self and mutual-inductances of linear conductors," *BULL. NATL. BUR. STAND.*, vol. 4, no. 2, p. 301, Jan. 1908, doi: 10.6028/bulletin.088.
- [19] M. Raven, "Experimental measurements of the skin effect and internal inductance at low frequencies," *Acta Technica CSAV (Ceskoslovensk Akademie Ved)*, vol. 60, pp. 51–69, Jan. 2015.
- [20] "Inductance: Loop and Partial | Wiley," Wiley.com. <https://www.wiley.com/en-us/Inductance%3A+Loop+and+Partial-p-9780470461884> (accessed May 05, 2021).
- [21] C. Feng, J. Wu, Q. Sun, H. Wu, and L. Zhang, "An Integrated BLIL Boost Converter-based Switched Reluctance Motor Drive for PEV Applications with PFC Charging Function," in 2019 22nd International Conference on Electrical Machines and Systems (ICEMS), Aug. 2019, pp. 1–5. doi: 10.1109/ICEMS.2019.8921510.
- [22] W. Zhang, H. Sun, and S. Wang, "optimization of Integrated Power Converter with Multiple Operating Modes for Switched Reluctance Motor," in 2022 IEEE 5th International Electrical and Energy Conference (CIEEC), May 2022, pp. 3530–3535. doi: 10.1109/CIEEC54735.2022.9846712.
- [23] Z. Nie and A. Emadi, "Integrated converters for switched reluctance motor drives," in *The 4th International Power Electronics and Motion Control Conference, 2004. IPEMC 2004.*, Aug. 2004, pp. 487-490 Vol.2.