



**HAL**  
open science

# Wireless Powered Sensors for Battery-Free IoT Through Multi-Stage Rectifier

Xiaoqiang Gu, Simon Hemour, Ke Wu

► **To cite this version:**

Xiaoqiang Gu, Simon Hemour, Ke Wu. Wireless Powered Sensors for Battery-Free IoT Through Multi-Stage Rectifier. 2020 XXXIIIrd General Assembly and Scientific Symposium of the International Union of Radio Science (URSI GASS), Aug 2020, Rome, France. pp.1-4, 10.23919/URSI-GASS49373.2020.9232143 . hal-04559970

**HAL Id: hal-04559970**

**<https://hal.science/hal-04559970>**

Submitted on 25 Apr 2024

**HAL** is a multi-disciplinary open access archive for the deposit and dissemination of scientific research documents, whether they are published or not. The documents may come from teaching and research institutions in France or abroad, or from public or private research centers.

L'archive ouverte pluridisciplinaire **HAL**, est destinée au dépôt et à la diffusion de documents scientifiques de niveau recherche, publiés ou non, émanant des établissements d'enseignement et de recherche français ou étrangers, des laboratoires publics ou privés.

## Wireless Powered Sensors for Battery-Free IoT Through Multi-Stage Rectifier

Xiaoqiang Gu<sup>\*(1)</sup>, Simon Hemour<sup>(2)</sup>, and Ke Wu<sup>(1)</sup>

(1) Poly-GRAMES Research Center, Polytechnique Montreal, Montreal, Canada

(2) IMS Laboratory, CNRS UMR 5218, University of Bordeaux, Talence, France

### Abstract

Wireless Power Transfer (WPT) technology has paved the way to energize numerous sensor nodes for the Internet of Things (IoT) applications. This work theoretically and experimentally shows how a commercial multi-function sensor board can be energized by an ultra-high-frequency (UHF) multi-stage rectifier at low RF input power levels. Firstly, an analytical model characterizing multi-stage rectifiers is derived. Good accuracy of modeling results is observed in the low input power range of interest, compared with results obtained from the ADS Harmonic Balance simulator. Then, a 5-stage rectifier is employed to power the multi-function sensor board that can acquire the information of temperature, humidity, and light. This sensor board further transmits packets to an access point connected to a laptop for data visualization, making the power consumption of the sensor board relatively large. Hence, a 50-mF supercapacitor is required to drive such a power-hungry sensor board. The final demonstration shows that the multi-function sensor board works adequately in a low-duty cycle powered by a 5-stage rectifier with an input power of  $-10$  dBm.

### 1 Introduction

Collecting/recycling ambient radiofrequency (RF) power in the free space is an effective way to energize numerous sensor nodes for the Internet of Things (IoT) applications, eliminating the need for batteries [1]. Although ambient RF power density is relatively low compared with other energy sources, like vibration, solar, and thermal power, RF power is pervasive and more stable [2],[3]. Moreover, some sensing applications do not necessarily require continuous data acquisition but work in a low-duty cycle, such as temperature, humidity, and light sensing in an office room. Also, omnipresent ambient electromagnetic power is particularly suitable for geographically scattered and wirelessly connected sensor nodes as powering distance and range can be flexibly managed very well. For such applications, ambient RF power harvesting offers an attractive solution.

Figure 1 depicts a typical self-sustainable sensor board based on RF power harvesting via a multi-stage rectifier. Driving voltages of sensors are generally larger than the voltage level that a single-diode rectifier can achieve, although the single-diode topology has a better efficiency in the practical ambient power range ( $\leq -10$  dBm) [4]. To

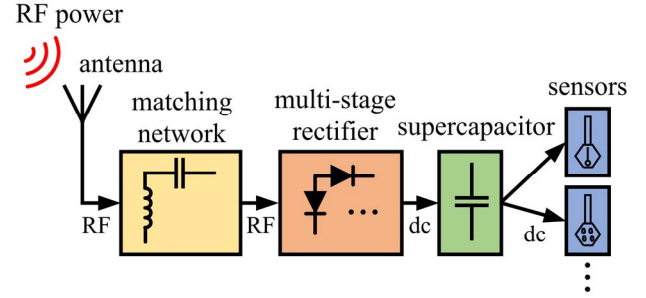

**Figure 1.** Diagram of a typical RF-dc multi-stage rectifier-based self-sustainable sensor platform. The energy flow of either RF or dc power is labeled.

leverage the dc output voltage of a single-diode rectifier, one solution is to use a dc-dc converter [5]. In this work, a multi-stage RF-dc rectifier is introduced as an alternative to improve the dc output voltage. For analyzing the multi-stage rectifier, a closed-form model is studied and developed with satisfying accuracy, compared with the ADS Harmonic Balance simulator. Then, with an input power of  $-10$  dBm, a 5-stage rectifier is designed and developed to energize a power-hungry multi-function sensor board in a low-duty-cycle mode.

### 2 Analytical model

Figure 2 illustrates the diagram of an  $N$ -stage rectifier, which is transformed from Dickson's charge pump. Thus, this topology has  $2N$  diodes and capacitors. This work employs widely used Schottky diodes, which can be characterized by the well-known Shockley model (Figure 2). In the Shockley model, a Schottky diode has nonlinear junction capacitance ( $C_j$ ), nonlinear junction resistance ( $R_j$ ), series resistance ( $R_s$ ), and packaging parasitics ( $L_p$  &  $C_p$ ), respectively. In the schematic shown in Figure 2, assuming the RF input signal has a magnitude of  $V_{RF}$  and a frequency of  $f_0$ , the voltage across the diode junction  $V_{diode}$  can be expressed by:

$$\begin{aligned} V_{diode} &= V_{RF} \cdot \cos(2\pi f_0 t) - \frac{V_{dc}}{2N} - I_{dc} \cdot R_s \\ &= V_{RF} \cdot \cos(2\pi f_0 t) - I_{dc} \cdot \left( \frac{R_l}{2N} + R_s \right) \end{aligned} \quad (1)$$

where  $V_{dc}$  and  $I_{dc}$  are dc output voltage and current, respectively.  $R_l$  is the load resistance. Thus,  $V_{dc}$  can be obtained by  $I_{dc} \cdot R_l$ . The exponential expression describing

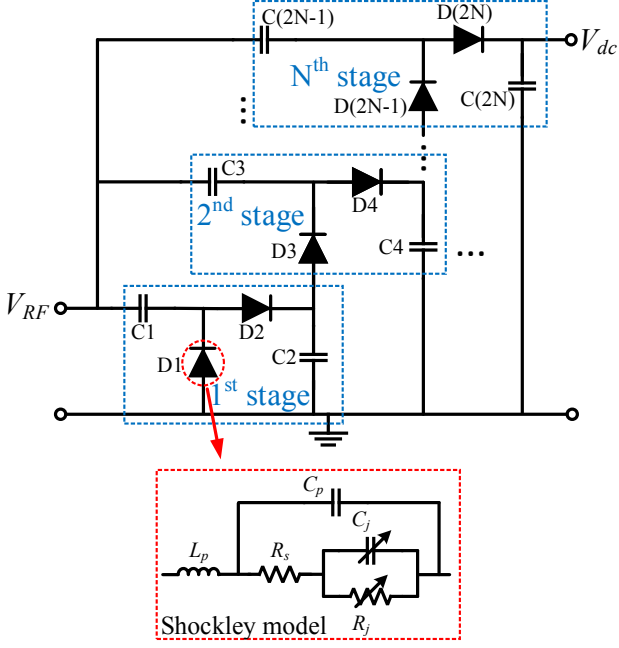

**Figure 2.** Schematic of an  $N$ -stage rectifier converting RF input power ( $V_{RF}$ ) into dc output ( $V_{dc}$ ).

the  $I$ - $V$  relationship of Schottky diodes is applied to calculate the current passing through nonlinear junction resistance  $I_{diode}$ :

$$I_{diode} = I_s \cdot \left[ e^{\frac{V_{diode}}{n \cdot V_t}} - 1 \right] = I_s \cdot \left[ e^{\frac{V_{RF} \cdot \cos(2\pi f_0 t) - I_{dc} \left( \frac{R_L}{2N} + R_s \right)}{n \cdot V_t}} - 1 \right] \quad (2)$$

where  $I_s$  and  $n$  are the saturation current and ideality factor of diodes.  $V_t = k \cdot T / q$  is the thermal voltage.  $k$ ,  $T$ ,  $q$  are Boltzmann constant, operating temperature (in Kelvin), and electron charge, respectively. The deployment of Bessel functions is perfect for separating harmonics in this case:

$$e^{\frac{V_{RF} \cdot \cos(2\pi f_0 t)}{n \cdot V_t}} = J_0 \left( -i \frac{V_{RF}}{n \cdot V_t} \right) + 2 \sum_{v=1}^{\infty} i^v J_v \left( -i \frac{V_{RF}}{n \cdot V_t} \right) \cos[v \cdot (2\pi f_0 t)] \quad (3)$$

in which  $J_v(x)$  is the Bessel function of the first kind of  $v$ , and  $i$  is the imaginary unit. Then, the dc output current can be expressed as:

$$I_{dc} = I_s \cdot \left[ J_0 \left( -i \frac{V_{RF}}{n \cdot V_t} \right) \cdot e^{\frac{-I_{dc} \left( \frac{R_L}{2N} + R_s \right)}{n \cdot V_t}} - 1 \right] \quad (4)$$

With the aid of the Lambert  $W$  function, the analytical solution of  $I_{dc}$  can be obtained:

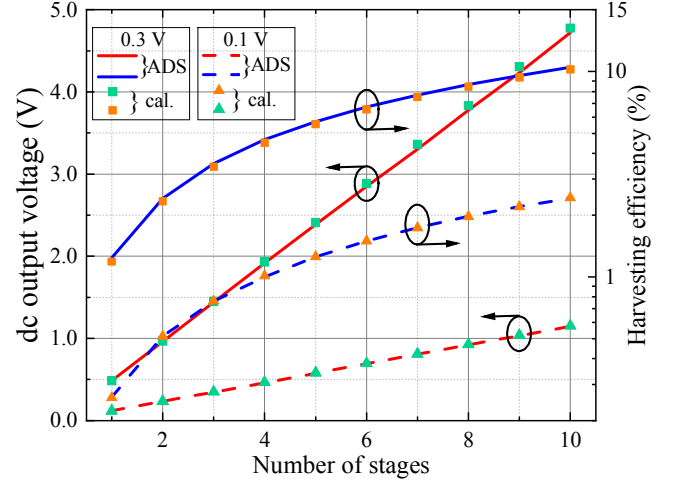

**Figure 3.** Comparison of dc output voltage and harvesting efficiency versus the number of stages based on the proposed model and ADS simulation. Input voltage amplitudes are set at 0.1 V and 0.3 V. The losses due to lumped components, matching network and substrate are de-embedded.

$$I_{dc} = I_s \cdot \left( \frac{w_0(G \cdot J_0 \left( -i \frac{V_{RF}}{n \cdot V_t} \right) \cdot e^G)}{G} - 1 \right) \quad (5)$$

where  $G$  is defined as:

$$G = \frac{R_L + R_s}{R_{j0}} \quad (6)$$

in which  $R_{j0} = n \cdot V_t / I_s$  is zero bias junction resistance. The magnitude of fundamental current passing through the junction resistance  $I_{junc}$  can also be calculated based on (3):

$$I_{junc} = I_s \cdot \left[ 2i \cdot J_0 \left( -i \frac{V_{RF}}{n \cdot V_t} \right) \cdot e^{\frac{-I_{dc} \left( \frac{R_L}{2N} + R_s \right)}{n \cdot V_t}} \right] \quad (7)$$

Thus, the RF input power can be obtained by:

$$P_{in} = 2N \cdot \frac{Re(V_{tot} \cdot I_{tot}^*)}{2} \quad (8)$$

where  $I_{tot}$  and  $V_{tot}$  are calculated through:

$$I_{tot} = V_{diode} \cdot i2\pi f_0 C_{j0} + I_{junc} \quad (9a)$$

$$V_{tot} = V_{diode} + (V_{diode} \cdot i2\pi f_0 C_{j0} + I_{junc}) \cdot R_s \quad (9b)$$

in which  $C_{j0}$  is zero bias junction capacitance. Rectifying efficiency  $\eta$  then can be defined as:

$$\eta = \frac{I_{dc} \cdot V_{dc}}{P_{in}} \times 100\% \quad (10)$$

For verification, the proposed analytical model is compared with a commercial simulation tool, ADS

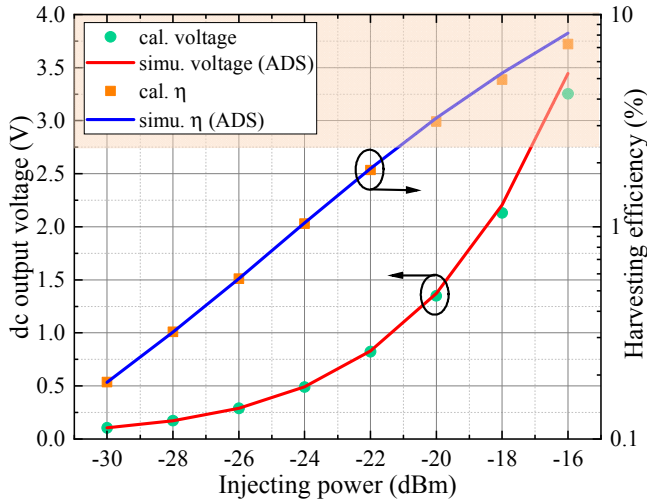

**Figure 4.** Comparison of dc output voltage and harvesting efficiency based on the proposed model and ADS simulation for a 5-stage rectifier. The region filled by light orange color marks voltage level that is enough to drive the

Harmonic Balance simulator. The load resistance is chosen to be 5.8 M $\Omega$ , which corresponds to the resistance when the sensor board is in sleep mode. The calculated dc output voltage and harvesting efficiency results are presented in Figure 3, together with those obtained by ADS simulation. Input voltage amplitudes are selected to be 0.1 V and 0.3 V. A good agreement between calculated and simulated results can be observed in Figure 3.

Considering the sensor board requires at least 2.7 V to trigger its working cycle together with the practical ambient power levels in our environment, a 5-stage rectifier is selected for further experimental verification. Operating frequency is set at 600 MHz (digital TV broadcasting band in Canada). Both dc output voltage and harvesting efficiency are predicted using the proposed model as depicted in Figure 4. ADS simulation results are also attached for comparison. A satisfying accuracy of results has been observed based on the comparison in Figure 4.

### 3 Experimental Demonstration

This 5-stage rectifier is fabricated on a Rogers RT/duroid 6002 substrate with a dielectric constant of 2.94 and a thickness of 0.508 mm (Figure 5 (a)). Measured dc output voltage together with simulated values through ADS EM co-simulation are presented in Figure 5 (b). Due to the losses of the matching network, diodes, and lumped components, the measured dc output voltages are lower than the simulated counterparts. However, the obtained values are at a comparable level as those reported in [6], which is also a 5-stage rectifier based on Schottky diodes.

For the final demonstration of the wireless powered sensor application, the fabricated 5-stage rectifier is used as a power source for the multi-function sensor board (WSN-EVAL-01) from Powercast [7]. The complete experimental

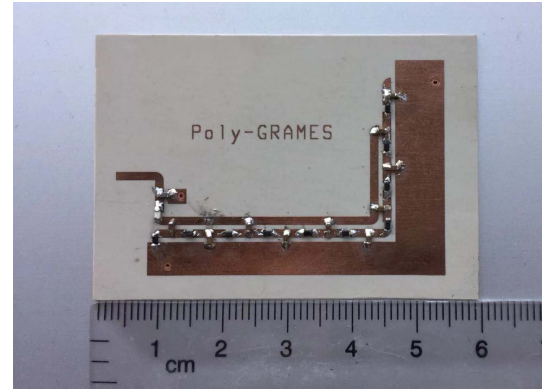

(a)

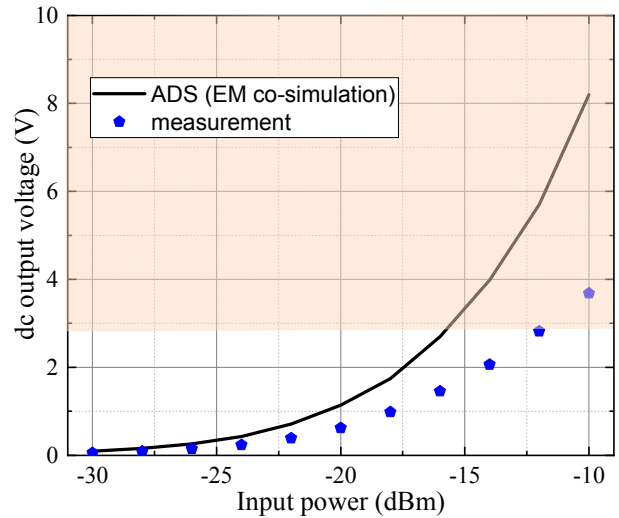

(b)

**Figure 5.** (a) Experimental prototype of a 5-stage rectifier. (b) Comparison of dc output voltage obtained by measurement and ADS EM co-simulation, respectively.

setup is illustrated in Figure 6. A signal generator acts as the external RF power supply. A multimeter is adopted to monitor the dc output voltage level of the rectifier. When RF power injects, the dc output voltage across the supercapacitor rises, and charge accumulates. In this demonstration, the RF input power is -10 dBm. To ensure

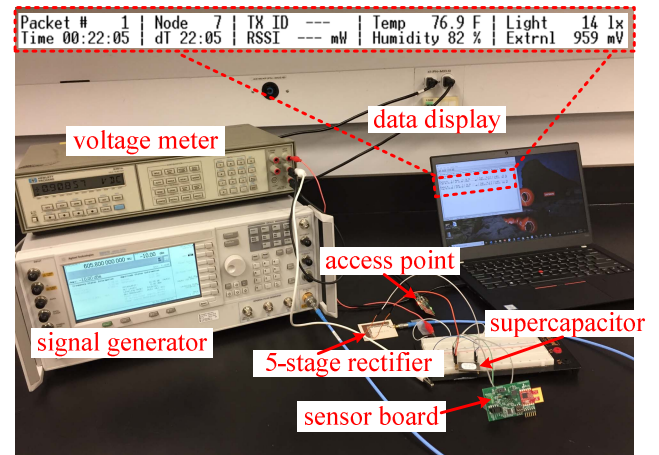

**Figure 6.** Measurement setup of wireless powered multi-function sensor board through a 5-stage rectifier.

enough power to drive the sensor, the above supercapacitor is selected to be 50-mF. Once the dc voltage exceeds the threshold of 2.7 V, this sensor board conducts sensing tasks and then transmits packets to an access point. Received data are then decoded and displayed on a laptop connected with the access point. Note that this sensor board consumes certain power in the sleep mode. Hence, dc supply to the sensor board is isolated until the driving voltage threshold is reached to trigger a working cycle of the sensor board. As an example, the data displayed on the laptop is shown on the top of Figure 6, including temperature, humidity, and light information.

## 4 Summary

This work first derives a closed-form model for an  $N$ -stage rectifier based on off-the-shelf Schottky diodes. Compared with the commercial ADS Harmonic Balance simulator, good accuracy of modeling results is obtained in the power range of interest. Then, a 5-stage rectifier is designed and prototyped as an ambient RF power scavenger. Experimental demonstration is finally presented, showing that the designed 5-stage rectifier can support a multi-function sensor board to work in a low-duty-cycle mode.

## 5 Acknowledgements

The authors would like to acknowledge the financial support of the Natural Science and Engineering Research Council of Canada. X. Gu thanks for the support of the IEEE MTT-S Graduate Fellowship.

## 6 References

- [1] A. Costanzo and D. Masotti, "Energizing 5G: Near- and far-field wireless energy and data transfer as an enabling technology for the 5G IoT," *IEEE Microw. Mag.*, vol. 18, no. 3, pp. 125-136, Apr. 2017.
- [2] S. Hemour, X. Gu, and K. Wu, "Efficiency of Rectenna," in *Recent Wireless Power Transfer Technologies via Radio Waves*, N. Shinohara, Ed., ed: River Publishers, 2018, pp. 95-132.
- [3] X. Gu *et al.*, "Hybridization of Integrated Microwave and Mechanical Power Harvester," *IEEE Access*, vol. 6, pp. 13921-13930, Mar. 2018.
- [4] X. Gu, S. Hemour, L. Guo, and K. Wu, "Integrated Cooperative Ambient Power Harvester Collecting Ubiquitous Radio Frequency and Kinetic Energy," *IEEE Trans. Microw. Theory Techn.*, vol. 66, no. 9, pp. 4178-4190, Jun. 2018.
- [5] Y. Huang, T. Mitani, T. Ishikawa, and N. Shinohara, "Experiments on driving a low-power DC motor by microwave power transfer," in *Proc. IEEE Wireless Power Transf. Conf.*, Boulder, CO, USA, May 2015, pp. 1-3.
- [6] R. Shigeta *et al.*, "Ambient RF energy harvesting sensor device with capacitor-leakage-aware duty cycle control," *IEEE Sensors J.*, vol. 13, no. 8, pp. 2973-2983, Aug. 2013.

- [7] Powercast, wsn-eval-01, [Online]. Available: <https://www.powercastco.com/documentation/wsn-eval-01-schematic/>.