



HAL
open science

Solving Harmonic Elimination Equations in Multi-Level Inverters by Using Neural Networks

Omar Bouhali, Fatiha Bouaziz, Nassim Rizoug, Abdelaziz Talha

► To cite this version:

Omar Bouhali, Fatiha Bouaziz, Nassim Rizoug, Abdelaziz Talha. Solving Harmonic Elimination Equations in Multi-Level Inverters by Using Neural Networks. *International Journal of Information and Electronics Engineering*, 2013, 3 (2), pp.191. 10.7763/ijee.2013.v3.296 . hal-04554590

HAL Id: hal-04554590

<https://hal.science/hal-04554590>

Submitted on 22 Apr 2024

HAL is a multi-disciplinary open access archive for the deposit and dissemination of scientific research documents, whether they are published or not. The documents may come from teaching and research institutions in France or abroad, or from public or private research centers.

L'archive ouverte pluridisciplinaire **HAL**, est destinée au dépôt et à la diffusion de documents scientifiques de niveau recherche, publiés ou non, émanant des établissements d'enseignement et de recherche français ou étrangers, des laboratoires publics ou privés.



Distributed under a Creative Commons Attribution 4.0 International License

See discussions, stats, and author profiles for this publication at: <https://www.researchgate.net/publication/264045049>

Solving Harmonic Elimination Equations in Multi-Level Inverters by Using Neural Networks

Article · January 2013

DOI: 10.7763/IJIEE.2013.V3.296

CITATIONS

22

READS

818

4 authors:



Omar Bouhali

University of Jijel

74 PUBLICATIONS 855 CITATIONS

[SEE PROFILE](#)



Bouaziz Fatiha

11 PUBLICATIONS 150 CITATIONS

[SEE PROFILE](#)



Nassim Rizoug

Ecole Supérieure des Techniques Aéronautiques et de Construction Automobile

34 PUBLICATIONS 449 CITATIONS

[SEE PROFILE](#)



Abdelaziz Talha

University of Science and Technology Houari Boumediene

82 PUBLICATIONS 502 CITATIONS

[SEE PROFILE](#)

Solving Harmonic Elimination Equations in Multi-level Inverters by using Neural Networks

O. Bouhali, F Bouaziz, N. Rizoug and A. Talha

Abstract—Pulse Width Modulation (PWM) using the harmonic elimination technique needs the solving of a nonlinear transcendental equations system. Conventionally, due to their high complexity, these equations have to be solved off-line and the calculated optimal switching angles are stored in look-up tables or interpolated by simple functions for real-time operation. System flexibility is very limited, especially for applications which require both amplitude and frequency control. A new implementation scheme based on real-time solving of the nonlinear harmonic elimination equations using feed forward Artificial Neural Networks (ANNs) is reported in this paper. Based on the well known Back-propagation Algorithm (BPA), two training schemes for the ANN are presented. In the first one, the ANN is trained using the desired switching angles given by the classical method. The second training scheme is developed using only the harmonic elimination equation systems. Some simulation results are given to show the feasibility, performances and technical advantages of the proposed method.

Index Terms—Artificial neural networks, solving algorithm, harmonic elimination algorithm, multilevel inverter.

I. INTRODUCTION

A fundamental issue in the control of a multilevel inverter is to determine the switching angles so that the inverter produces the required fundamental voltage and eliminate the lower order dominant harmonics [1]-[3]. One frequently applied optimized Pulse Width Modulation is the harmonic elimination technique which aims at complete elimination of same low-order harmonics from a PWM waveform while maintaining the amplitude of the fundamental component at a desired value. The harmonic elimination approach given in [4] produces a system of nonlinear transcendental equations that requires the Newton Raphson method for its solutions. This algorithm requires starting values for the angles and does not always converge to the required solution. To give a solution to this problem, power electronics researches have always studied many novel control techniques to reduce harmonics in such waveforms [1]-[2].

For any chosen objective function, the optimal switching pattern depends on the desired modulation index. In the existing practice, the switching patterns are pre-computed for all the required values of this index, and stored in look-up tables of a microprocessor-based modulator. This requires a

large memory. Computation of the switching angles in real time is, as yet, impossible. To overcome this problem, attempts were made to use approximate formulas, at the expense of reduced quality of the inverter voltage [1].

Recently, an alternate method of implementing these chops has been developed. An ANN is trained to output the switching angles in response to a given output voltage [5-6]. The most disadvantages of these applications is the use of the desired switching angles given by the solving of the harmonic elimination equation by the classical method i.e. Newton Raphson method.

In this paper, a general approach is presented to solve the harmonic elimination equations using a new training scheme of ANN. The approach demonstrated here is accomplished by first transforming the nonlinear transcendental harmonic elimination equations for all possible switching schemes into a one input (index modulation) multi-output (switching angles) three layers ANN. Then, the complete set of solutions of the equations is found using the back propagation of the errors between the desired harmonic elimination and the non-linear equation systems output using the switching angle given by the ANN. The rest of paper is organized as follows. In section 2, a brief review of harmonic contents in the electrical system. Section 3 presents a cascaded H-Bridge inverter. The detailed explanation of the Selective Harmonic Elimination strategy (SHE) is given in section 4. In section 5, the direct supervised training of ANN by SHE is presented. The proposed indirect supervised training of ANN is detailed in section 6 followed by ANN control inverter. Section 8 describes the results and discussion. The conclusions are summed up in section 9.

II. HARMONICS IN ELECTRICAL SYSTEMS

One of the biggest problems in power quality aspects is the harmonic contents in the electrical system. Generally, harmonics may be divided into two types: 1) voltage harmonics, and 2) current harmonics. A current harmonic are usually generated by harmonics contained in voltage supply and depends on the type of the load such as resistive load, capacitive load, and inductive load. Both harmonics can be generated by either the source or the load side. Harmonics generated by load are caused by nonlinear operation of device, including power converters, arc-furnaces, gas discharge lighting devices, etc. Load harmonics can cause the overheating of the magnetic cores of transformer and motors. On the other hand, source harmonics are mainly generated by power supply with non-sinusoidal voltage and/or non-sinusoidal current waveforms. Voltage and current source harmonics imply power losses, Electro-Magnetic

Manuscript received August 15, 2012; revised October 12, 2012.

O. Bouhali and F. Fatiha are with Mecatronic Laboratory, Jijel University, Algeria (email : bouhali_omar@univ-jijel.dz).

N. Rizoug is with the Ecole Supérieure des Techniques Aéronautiques et de Construction Automobile (ESTACA) (e-mail: nassim.rizoug@estaca.fr).

A. Talha is with the Electrical Engineering Department of University of Science and Technology Houari Boumediene (e-mail: abtalha@gmail.com).

Interference (EMI) and pulsating torque in AC motor drives [3]. Any periodic waveform can be shown to be the superposition of a fundamental and a set of harmonic components. By applying Fourier transformation, these components can be extracted. The frequency of each harmonic component is an integral multiple of its fundamental [2]. There are several methods to indicate the quantity of harmonics contents. The most widely used measure is the total harmonics distortion (THD), which is defined in terms of the magnitudes of the harmonics, H_n at pulsation $n\omega$, where ω is pulsation of the fundamental component whose amplitude is H_1 and n is an integer [5]. The THD is mathematically given by

$$THD = \sqrt{\sum_{n=2}^{\infty} H_n^2} / H_1 \quad (1)$$

III. CASCADE H-BRIDGES

Each SDCS is associated with a single-phase full-bridge inverter [1]. The AC terminal voltages of different level inverters are connected in series (Fig. 1a). By different combinations of the four switches, S_1 - S_4 , each inverter level can generate three different levels of full-bridge inverters connected in series. The synthesized voltage waveform is the sum of the inverter outputs (Fig. 1b).

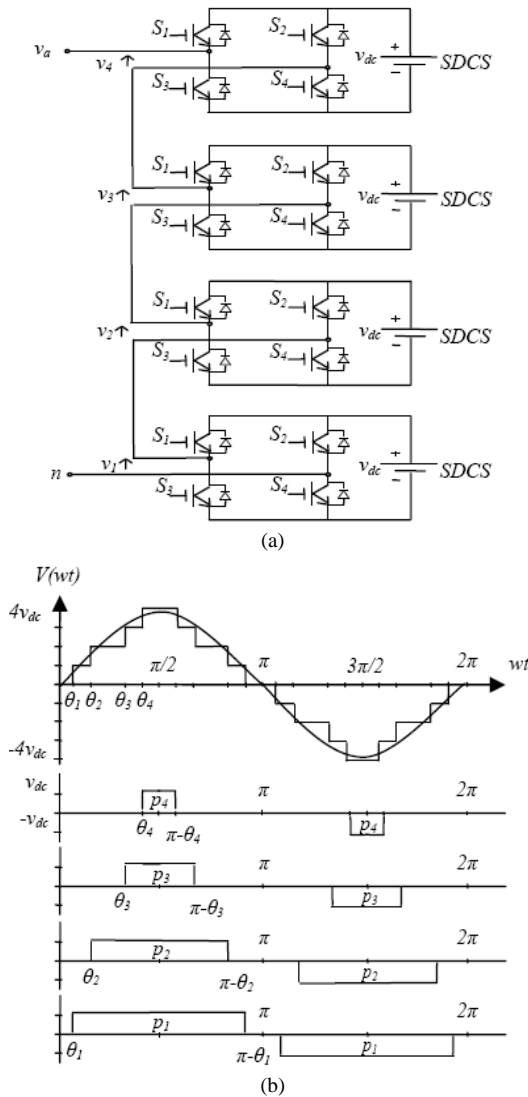

Fig. 1. Single-phase structure of a nine-level cascaded inverter.

IV. SELECTIVE HARMONIC ELIMINATION (SHE) STRATEGY

TABLE I: POSSIBILITY SWITCHING SCHEMES

Scheme	$l=(l_1, l_2, l_3, l_4)$	Inequality Condition
Fig. 2 (a)	(+1,+1,+1,+1)	$0 \leq \theta_1' \leq \theta_2' \leq \theta_3' \leq \theta_4' \leq \pi/2$
Fig. 2 (b)	(+1,-1,+1,-1)	$0 \leq \theta_1' \leq \pi - \theta_2' \leq \theta_3' \leq \pi - \theta_4' \leq \pi/2$
Fig. 2 (c)	(+1,+1,+1,-1)	$0 \leq \theta_1' \leq \theta_2' \leq \theta_3' \leq \theta_4' \leq \pi - \theta_5' \leq \pi/2$
Fig. 2 (d)	(+1,+1,-1,-1)	$0 \leq \theta_1' \leq \theta_2' \leq \pi - \theta_3' \leq \pi - \theta_4' \leq \pi/2$
Fig. 2 (e)	(+1,-1,+1,+1)	$0 \leq \theta_1' \leq \pi - \theta_2' \leq \theta_3' \leq \theta_4' \leq \pi/2$
Fig. 2 (f)	(+1,+1,-1,+1)	$0 \leq \theta_1' \leq \theta_2' \leq \pi - \theta_3' \leq \theta_4' \leq \pi/2$

Various objective functions can be used in the optimal control of an inverter. For the described study, the classic harmonic elimination strategy was selected. It consists in determining N optimal switching angles, the so-called primary ones [1]-[2]. The primary angles are limited to the first quarter of the cycle of output voltage and to phase (a) of the multilevel inverter. Switching angles in the remaining three quarters are referred to as secondary angles. The full-cycle switching pattern must have the half-wave and quarter-wave symmetry in order to eliminate even harmonics. Hence, the secondary angles are linearly dependent on their primary counterparts (Fig. 1b). The resultant optimal switching pattern yields a fundamental voltage corresponds to a given value of the modulation index, whereas $N-1$ low-order, odd, and triple harmonics are absent in the output voltage. The scheme shown in Fig. 1 is the possible switching schemes for a 4 DC source multilevel-inverter.

To proceed, note that each of the waveforms have a Fourier series expansion of the form

$$V(wt) = \frac{4V_{dc}}{\pi} \sin(nwt) \times \sum_{n=1,3,5,\dots} \frac{1}{n} (l_1 \cos(n\theta_1) + l_2 \cos(n\theta_2) + l_3 \cos(n\theta_3) + l_4 \cos(n\theta_4)) \quad (2)$$

where $0 \leq \theta_1 \leq \theta_2 \leq \theta_3 \leq \theta_4 \leq \pi/4$ and $l_i = \pm 1$ depending on the switching scheme as shown in the Table I. For each of these schemes, the Fourier series is summed over only the odd harmonics, and as $\cos(n(\pi - \theta_i)) = -\cos(n\theta_i)$ for n odd, (2) may be rewritten in the form

$$V(wt) = \frac{4V_{dc}}{\pi} \sin(nwt) \times \sum_{n=1,3,5,\dots} \frac{1}{n} (\cos(n\theta_1') + \cos(n\theta_2') + \cos(n\theta_3') + \cos(n\theta_4')) \quad (3)$$

where $\theta_i' = \theta_i$ if $l_i = 1$ and $\theta_i' = \pi - \theta_i$ if $l_i = -1$. In terms of the angles θ_i' , the conditions $0 \leq \theta_1 \leq \theta_2 \leq \theta_3 \leq \theta_4 \leq \pi/2$ become those in the right-most column of the Table I.

Again, the desired here is to use these switching schemes to achieve the fundamental voltage and eliminate the fifth, seventh and 11th harmonics for those values of the

modulation index m_a ($m_a = m/s$ with s (=4 here) is the number of DC sources and $m = V_1/(4V_{dc}/\pi)$).

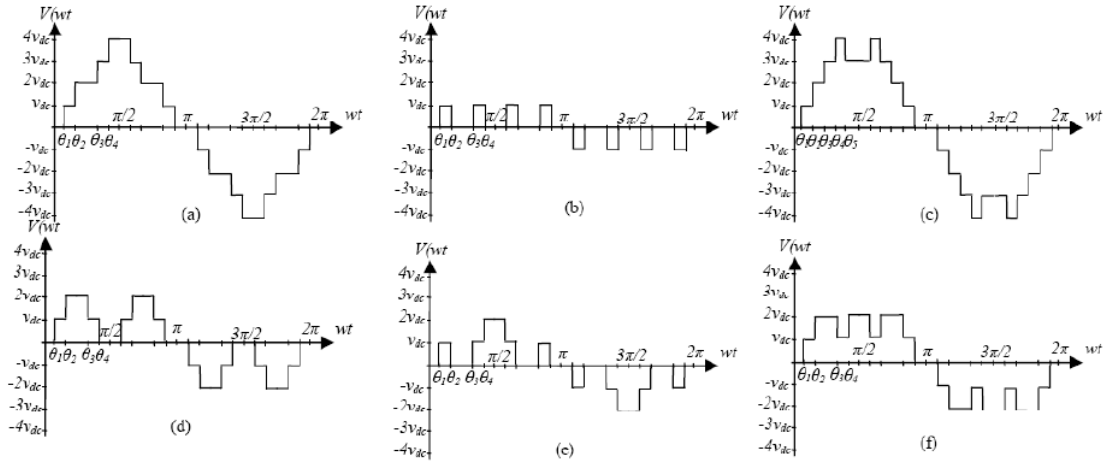

Fig. 2. Nine-level possible output waveform

The harmonic elimination technique is very suitable for a multilevel inverters control. By employing this technique along with the multilevel topology, the low THD output waveform without any filter circuit is possible. Switching devices, in addition, turn on and off only one time per cycle. Fig. 2 shows a general quarter symmetric nine-level inverter waveform.

With the equal-magnitude of all DC source, the magnitude expression of the fundamental and all harmonic content are given as:

$$H_n(\theta) = \begin{cases} 4v_{dc} h_n & \text{for odd } n \\ 0 & \text{for even } n \end{cases} \text{ with } h_n = \sum_{k=1}^s \cos(n\theta_k) \quad (4)$$

where: v_{dc} is the DC voltage supply, s is the number of DC sources (equal to a number of switching angle) and θ_k is the optimized harmonic switching angles.

In nine-level cascade inverter with 4 SDCS, we use this switching schemes to achieve the fundamental voltage and eliminate the fifth, seventh and 11th harmonics for those values of the modulation index m_a . The switching angles $\theta_1, \theta_2, \theta_3, \theta_4$ are chosen to satisfy:

$$\begin{aligned} h_1 &= \cos(\theta_1) + \cos(\theta_2) + \cos(\theta_3) + \cos(\theta_4) = 4m_a \\ h_2 &= \cos(5\theta_1) + \cos(5\theta_2) + \cos(5\theta_3) + \cos(5\theta_4) = 0 \\ h_3 &= \cos(7\theta_1) + \cos(7\theta_2) + \cos(7\theta_3) + \cos(7\theta_4) = 0 \\ h_4 &= \cos(11\theta_1) + \cos(11\theta_2) + \cos(11\theta_3) + \cos(11\theta_4) = 0 \end{aligned} \quad (5)$$

These equations are nonlinear, contain trigonometric terms and are transcendental in nature. Consequently, multiple solutions are possible. A Newton Raphson method has to be first applied to obtain a linearized set of equations. The solution of these equations is achieved by means of the Gauss-Jordan iterative method. In order to obtain convergence with this resolution method, the starting values must be chosen near to the optimal solution. A great deal of effort has been spent in this technique. However after a great computational time and efforts, no optimal solution is usually reached and convergence problem are highly arising especially when the number of equations is increased. To overcome the aforementioned difficulties, ANNs [6] can be

used to obtain the switching angles.

V. DIRECT SUPERVISED TRAINING OF ANNs FOR SHE

The ANN used to solve the harmonics elimination nonlinear equations has a single input neuron fed by the modulation index, 1 hidden neurons and s outputs; where each output represents a switching angle (Fig. 3). The outputs of the ANN are given by:

$$\theta_i = \sigma_1 \left(\sum_{j=1}^l v_{ij} \sigma_2(m, w_j) \right), i = 1, \dots, s \quad (6)$$

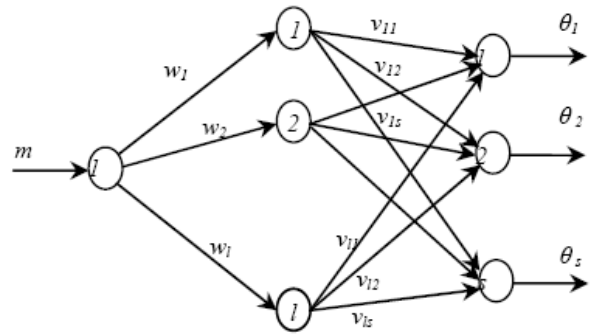

Fig. 3. ANN set for the selective harmonic elimination

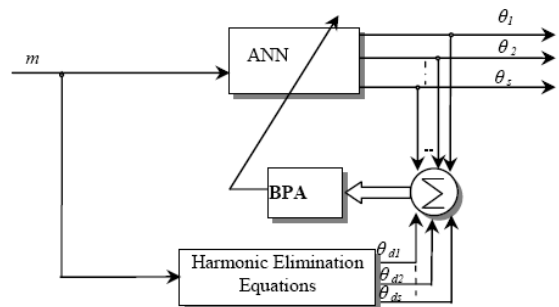

Fig. 4. Direct Supervised Training of ANN for SHE.

The ANN is trained by using the BPA with a teacher that implement the Newton Raphson method to solve the harmonics elimination nonlinear equations (eq. (5)), i.e., the Newton Raphson method is used to compute, from eq. (5) and for each value of m , the desired switching angles denoted

here by $\theta_{d1}, \dots, \theta_{ds}$. In the present section, the problem becomes how to modify the weights of the ANN so that the outputs of the ANN are close enough to the desired angles. The used training scheme is shown in Fig. 4.

The training procedure is performed with the total error $E = \theta_d - \theta_{nor}$, and $E_2 = (\theta_d - \theta_{nor})^T (\theta_d - \theta_{nor})$, where θ_d is supplied by the Newton Raphson Algorithm. Back propagate this error on the network and adapt the weights according to the BPA.

VI. INDIRECT SUPERVISED TRAINING OF ANN FOR SHE

In the previous section, the Newton Raphson method was used as the teacher for the ANN, which arise the question of the purpose of using a complex mapping as ANNs to solve the SHE problem since a conventionnel solving method, is still needed. Besides, the performances of the obtained ANN are limited by those of the teacher, i.e., by those of the Newton Raphson method.

In this section, we propose a novel training scheme for the ANN, called here the indirect supervised training scheme. In this scheme, the desired switching angles are not needed and, therefore, no conventional solving method for the SHE problem is required. The key idea of this scheme is to use the fact that, for each value of the modulation index m , the desired values of the harmonics h_i given by eq. (5) are known; the first desired harmonic is equal to the desired output voltage and the other desired harmonics are equal to zero. Based on this fact, we insert in series with the ANN the harmonic elimination equations given by eq. (5) as shown in Fig. 5. The error at the output of the harmonic elimination equations, which is computable, will be back-propagated through the harmonic elimination equations to obtain the error at the ANN outputs. And adapt the weights of the ANN according to the BPA of the error $E = H_d(\theta) - H(\theta)$, and $E_2 = (H_d(\theta) - H(\theta))^T (H_d(\theta) - H(\theta))$. Back propagate this error on the nonlinear equation system and the ANN using gradient descent algorithm, and adapt the weights recursively by

$$V^{new} = V^{old} + \eta_v E \frac{\partial H}{\partial \theta} \frac{\partial \theta}{\partial V} \tag{8}$$

$$\frac{\partial H}{\partial \theta} = - \begin{bmatrix} \sin(\theta_1) & \sin(\theta_2) & \dots & \sin(\theta_s) \\ \sin(5\theta_1) & \sin(5\theta_2) & \dots & \sin(5\theta_s) \\ \vdots & \vdots & \ddots & \vdots \\ \sin(n\theta_1) & \sin(n\theta_2) & \dots & \sin(n\theta_s) \end{bmatrix} \tag{9}$$

$$V_{i,j}^{new} = V_{i,j}^{old} + \eta_v \cdot \delta_i^1 \cdot \sigma_2(m, W_j), \text{ with } \begin{cases} \delta_i^0 = \sum_{k=1}^s (-1)^{k+1} \cdot E(i) \cdot n(k) \cdot \sin(n(k) \cdot \theta(i)) \\ \delta_i^1 = \delta_i^0 \sigma_1 \left(\sum_{k=1}^l V_{i,k} \cdot \sigma_2(m, W_k) \right) \end{cases}, \text{ and } \begin{cases} i = 1, \dots, s \\ j = 1, \dots, l \end{cases} \tag{10}$$

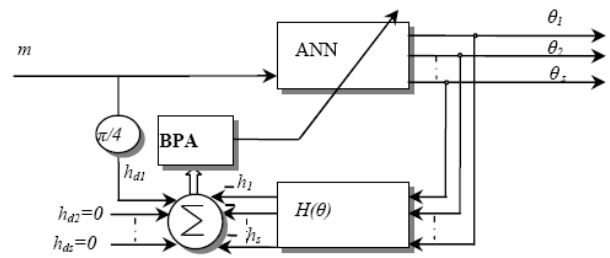

Fig. 5. Indirect training of Ann for selective elimination harmonic

ANN Control inverter with SHE

When the training step achieved, the obtained ANN can be used to generate the control sequence of the inverter depending of the modulation index m (Fig. 6).

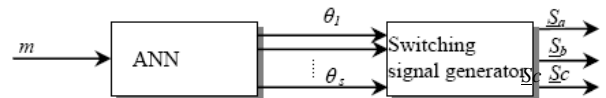

Fig. 6. Generating switching angles by using an ANN

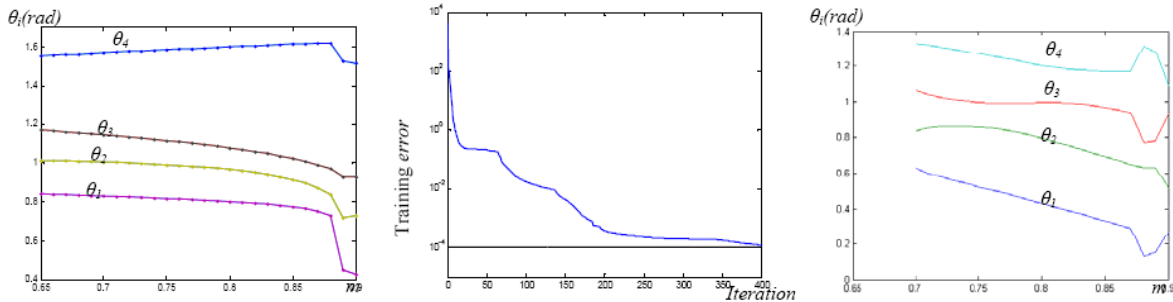

Fig. 7. a) The desired (solid line) and the ANN output (dotted line) switching angles after training step, b) Training error in learning step, c) Switching angles after training phase.

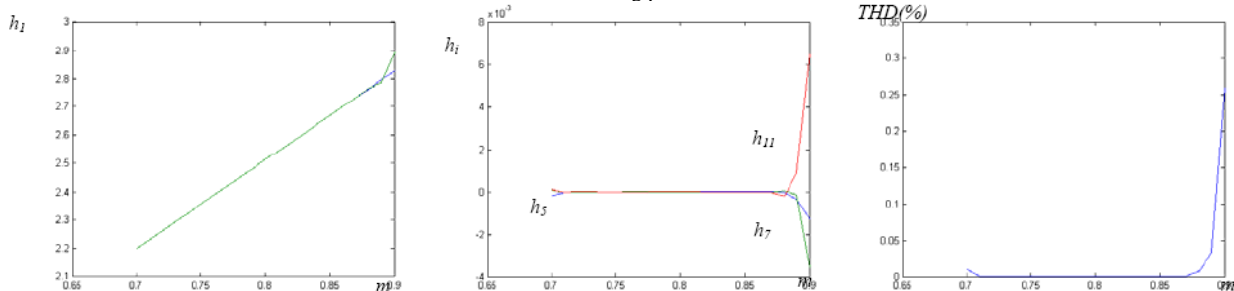

Fig. 8. a) Fundamental load voltage (h_1) versus modulation index (m) in a three-level three phase inverter with the proposed modulation scheme (Fig. 1a), b) Harmonic contents for various values of modulation index, c) Load voltage THD for different modulation index.

VII. SIMULATION RESULTS

The direct supervised of ANN was trained (400 iterations) using the desired switching angles given by Newton Raphson method. Fig. 7a shows the desired angles and the ANN output for various values of modulation index ($m \in [0.7, 0.9]$ with $\Delta m = 0.01$). The sum squares errors between the desired angle and the output of the neural network is showed in Fig. 7b. This error has reached the value 0.0001 in 400 iterations.

The indirect supervised of ANN (with $l=101$, $\sigma_v=1/100$, $\eta_v=0.2$ and $\Delta W=0.005$) for SHE (with $s=5$) was evaluated for range of modulation index values, with excellent results in all cases. Fig 7c shows the obtained switching angles after training step for various values of modulation index ($m \in [0.7, 0.9]$ with $\Delta m = 0.01$).

It is clear that the 5th, 7th, 11th and 13th harmonics are strongly suppressed and their magnitudes are negligible relatively to the fundamental component (Fig. 8a and 8b). The higher harmonics are also low which contributes to a high quality of the output voltage.

Fig. 8a represents the relationship between the amplitude of the fundamental load voltage h_1 and the modulation index, which must be linear for a good modulation method. It can be observed that the proposed method after training step has a better relationship between h_1 and m . Another important aspect to consider in the evaluation of this modulation method is the total harmonic distortion (THD) of the load voltage (Fig 8c).

The simulation results prove the feasibility of using ANNs to the selective harmonics elimination problem in multi-level inverters. This technique allows successful voltage control of the fundamental as well as suppression of a set of selective harmonics. Some problems occurring at lower modulation index values can be eliminated, if necessary, with a more complex ANN design which takes in consideration the different diagram possible waveforms of a multilevel output voltage (Fig. 2).

VIII. CONCLUSION

In this paper, we have presented a novel approach to solve harmonic elimination equations for multi-level inverters. The proposed approach is built with Artificial Neural Networks which are trained, by using the back-propagation algorithm, to approximate, in some way, the inverse of the harmonic elimination equations. Two training schemes for the used ANN are presented, namely, the direct supervised training scheme and the indirect one. In the direct scheme, the Newton Raphson algorithm is used as a teacher for the ANN. On the other hand, in the indirect supervised scheme, the need for the Newton Raphson algorithm as a teacher is removed. The ANN is trained by adding in series the harmonic elimination equations and using the fact that the desired output of these equations are equal to zero only the first one corresponding to the fundamental harmonic and he is equal to the modulation index m . After training step the ANN output follows the desired switching angle in the direct supervised scheme. In indirect supervised scheme the SHE is obtained directly without using the results of the classical methods. This highlights the performances of the ANN to

SHE i.e. to solve the nonlinear equations.

REFERENCES

- [1] J. N. Chaisson, L. M. Tolbert, K. J. Mckenzie, and Z. Du, "A Unified Approach to Solving the Harmonic Elimination Equations in Multilevel Converters," *IEEE Transactions on Power Electronics*, vol. 19, no. 2, March 2004, pp. 478-490.
- [2] S. Sirisukprasert, J. S. Lai, and T. H. Liu, "Optimum Harmonic Reduction with a Wide Range of Modulation Indexes for Multilevel Converters," *IEEE Transactions on Industrial Electronics*, vol. 49, no. 4, August 2002, pp. 875-881.
- [3] O. Bouhali, E. M. Berkouk, C. Saudemont, and B. François, "A Five level Diode Clamped Inverter with self-stabilization of the DC-Link Voltage for Grid Connection of Distributed Generators," *IEEE International Symposium on Industrial Electronics : ISIE 2004*, May 3-7, 2004, Ajaccio, France, CD.
- [4] S. Jian, S. Beineke, and H. Grotstollen, "Optimal PWM based on real-time solution of harmonic elimination equations," *IEEE Transactions on Power Electronics*, vol. 11, no. 4, July 1996, pp. 612-621
- [5] D. Daniolos, M. K. Darwish, and P. Mehta, "Optimised PWM inverter Control using Artificial Neural Networks," *IEEE 1995 Electronics Letters Online*, 1995, pp. 1739-1740.
- [6] J. Namikawa and J. Tani, "Building Recurrent Neural Networks to Implement Multiple Attractor Dynamics Using the Gradient Descent Method," *Advances in Artificial Neural Systems*, vol. 2009, pp. 1-11.



O. Bouhali was born in Chekfa, Algeria, 1974. He received the engineer degree and the master degree in automatic from national polytechnic school of Algeria, in 1996 and 1998 respectively. He received the Ph. D. degree from the Central School of Lille, France and National Polytechnic School of Algeria in 2007. Since 1998, he has been a lecturer in the automatic department of Jijel University, Algeria.

And he is a researcher in electrical system study and modeling laboratory (LAMEL). He is working in the development of renewable energy based power systems with inertial storage using multilevel converters. Jijel Automatic Laboratory (LAJ) Jijel University, Box 98, Ouled Aissa, Jijel.



F. Bouazizi was born in Jijel, Algeria, 1984. She received the engineer degree and the master degree in Electronic from Jijel university of Algeria, in 2007 and 2010 respectively. She is working in the signal processing, wavelet and artificial neural network. Electronic department, Jijel University, Box 98, Ouled Aissa, Jijel,

Algeria, Fax +213 34 50 11 89

E_mail : bouhali.fatiha@yahoo.fr



N. Rizoug received the Engineering degree from the E.N.P. (Ecole Polytechnique d'Alger), Algeria in 1998 and the Ph. D. in Electrical Engineering from the Ecole Centrale de Lille, France, in 2006. He is currently Assistant Professor at the Ecole Supérieure des Techniques Aéronautiques et de Construction Automobile (ESTACA), France since 2007. His research interest includes specially the field of energy management and the characterization of the storage component for the power electronic applications.



A. Talha was born in Algiers, Algeria, in 1963. He received the Engineer degree in 1989 and the Magister degree in electrical engineering in 1999 from University of Science and Technology Houari Boumediene, Algiers, Algeria. In 2004, he obtained the PhD in electrical engineering in from the Polytechnic National High School of Algiers, Algeria. In 1993, he joined the Electrical Engineering Department of University of Science and Technology

Houari Boumediene. He is Associate Professor, Leader Team of the Systems Conversion and Storage of Energy, Instrumentation laboratory. His current research interests are in the area of renewable energy, power electronics, electrical drives and process control Laboratory of Instrumentation (LINS), University of Science and Technology Houari Boumediene, Box 32, El-Alia, Bab-Ezzouar, Algiers,