



**HAL**  
open science

## Control of nonlinear gas turbine system using strategies of multidisciplinary design optimization

Nadji Hadroug, Ahmed Hafaifa, Guemana Mouloud, Abdellah Kouzou,  
Ahmed Chaibet

► **To cite this version:**

Nadji Hadroug, Ahmed Hafaifa, Guemana Mouloud, Abdellah Kouzou, Ahmed Chaibet. Control of nonlinear gas turbine system using strategies of multidisciplinary design optimization. Journal of the Technical University at Plovdiv. Fundamental Sciences and Applications, 1314-5258, 2016, 22, pp.17-24. hal-04552927

**HAL Id: hal-04552927**

**<https://hal.science/hal-04552927>**

Submitted on 19 Apr 2024

**HAL** is a multi-disciplinary open access archive for the deposit and dissemination of scientific research documents, whether they are published or not. The documents may come from teaching and research institutions in France or abroad, or from public or private research centers.

L'archive ouverte pluridisciplinaire **HAL**, est destinée au dépôt et à la diffusion de documents scientifiques de niveau recherche, publiés ou non, émanant des établissements d'enseignement et de recherche français ou étrangers, des laboratoires publics ou privés.



Distributed under a Creative Commons Attribution 4.0 International License

See discussions, stats, and author profiles for this publication at: <https://www.researchgate.net/publication/311702528>

# Control of nonlinear gas turbine system using strategies of multidisciplinary design optimization

Article · May 2016

CITATIONS

2

READS

144

5 authors, including:



**Nadji hadroug nadji hadroug**

Ziane Achour University of Djelfa

59 PUBLICATIONS 350 CITATIONS

[SEE PROFILE](#)



**Ahmed Hafaifa**

Ziane Achour University of Djelfa

344 PUBLICATIONS 1,968 CITATIONS

[SEE PROFILE](#)



**Kouzou Abdellah**

Ziane Achour University of Djelfa

458 PUBLICATIONS 1,871 CITATIONS

[SEE PROFILE](#)



**Guemana Mouloud**

Dr. Yahia Fares University of Médéa

126 PUBLICATIONS 802 CITATIONS

[SEE PROFILE](#)



## CONTROL OF NONLINEAR GAS TURBINE SYSTEM USING STRATEGIES OF MULTIDISCIPLINARY DESIGN OPTIMIZATION

NADJI HADROUG <sup>(1)</sup>, AHMED HAFIFA <sup>(1)</sup>, ABDELLAH KOUZOU <sup>(1)</sup>, MOULOUD GUEMANA <sup>(2)</sup>  
AND AHMED CHAIBET <sup>(3)</sup>

**Abstract:** Gas turbines are known in recent years over a considerable development in many industrial applications. Especially in the field of transportation and reinjection of gaz. Despite their many advantages, their high sensitivity to accentual defects is very important because the influence of these defects can be critical to the proper functioning of these rotating machines. This paper is a contribution to the study of a gas turbine compressor station Type Titan 130, where this study proposes the analysis of the output parameter control strategy of the studied gas turbine, based on the multidisciplinary optimization of their operating variables, to meet the operating constraints and to maximize the life of this machine. The obtained results are satisfying and reliable for performing economic contributions to the studied system.

**Keywords:** Gas turbine, Multidisciplinary optimization, configuration control, power turbine.

### 1. Introduction

The study of the complex industrial systems have become a modern industrial challenge to analyze the sustainability of the operation of industrial systems. This certainly reduces the intervention costs and allows better meeting the objectives a priori for optimal system operation. For this purpose, this work proposes the study of the output parameters control strategy of a gas turbine based on optimizing their output variables to meet the operating constraints, to maximize the duration life of this machine, to prevent the aerodynamic limitations caused by the dropout problem and to ensure correct conduct of this system.

In general, the control problem consists of obtaining dynamic models of systems, then using these models to determine the control laws or the strategies to achieve the desired system response and performance. Indeed, the gas turbine system is made by sensitive organs to accidental faults that can be critical and costly for both sides, the humanly and the financially sides on the correct operation of the gas turbine used in pipeline. In order to build a predictive system capable of estimating the state of operation degradation of gas

turbines in operation even under severe degraded mode. However, the complexity of the design optimization depends on the complexity of the relevant disciplines, the sizing problem and the nature of objectives and constraints. In the case of the considered gas turbine, multidisciplinary optimization is proposed to the multivariable control of the studied gas turbine output variable.

### 2. Strategies of Multidisciplinary Optimization

Several multidisciplinary optimization strategies have been presented literature [1, 7, 9, 15, 16]. This optimization can facilitate the control of variables in interaction between system elements and can be used as decision support in regulation. In the case of the studied gas turbine, the choice of the parameters and the modeling and implementation of a control strategy and decision making are obviously important regarding the supervisory system configurations eligible for the gas turbine. The optimization problem can be presented by the minimization of the function  $f(x, y, z)$  with respect to constraint functions, given by:

$$\begin{aligned}
& f(x, y, z) \\
& x, y, z \\
& g(x, y, z) \leq 0 \\
& h(x, y, z) = 0 \\
& \forall i, R_i(x_i, y_i, z_i) = 0 \\
& \forall j \neq i, y_{ij} = c_{ij}(x_j, y_j, z_j)
\end{aligned} \tag{1}$$

where  $x$  is the state variables,  $y$  are the coupling variables,  $z$  are the design variables,  $c$  is a function of coupling,  $f$  is an objective function,  $g$  is the inequality constraints,  $h$  are the equality constraints and  $R$  is residues function.

In this work, a more particular interest will be also transmitted to the defect detection phase which affect the system output variables of the studied gas turbine. Indeed, fault detection through the generation of a fault indicator called residue, this indicator is defined by a consistency relationship. It is designed to be zero on average in a case of operation. In contrast, in a case with default, the residue takes value away from its mean value and it is used to indicate the presence of a defect. The generation of residues characteristic of how the system, is the fundamental problem of diagnosis model based. This technique relies on the use of a correct assumed system model and generates residues that are the differences between the measured output signals and the estimated ones, as shown in Figure 1.

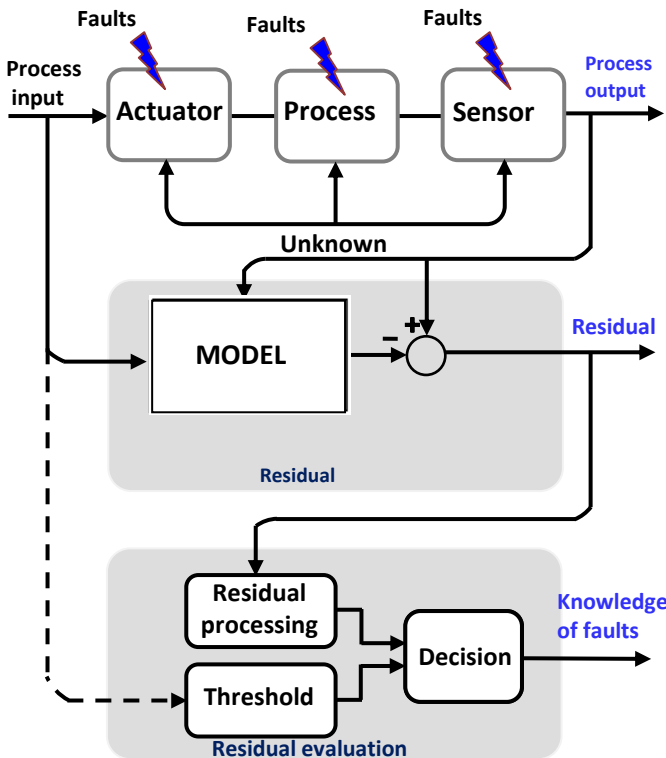


Fig. 1. Residual generation

For minimizing the equation error, the process model is written as:

$$y(k) = \Psi^T \theta \tag{2}$$

With  $\theta$  and  $\Psi$  designating the parameters and regression vectors given by:

$$\theta^T = [a_1 \dots a_n, b_1 \dots b_n], \quad \Psi^T = [y(k-1) \dots y(k-n) \quad u(k-1) \dots u(k-n)]$$

The equation error  $\varepsilon(\cdot)$  is introduced to the parameter estimation defining discrete transfer function of the system using the flowing formula:

$$\frac{y(z)}{u(z)} = \frac{B(z)}{A(z)} = \frac{\sum_{i=1}^{n_b} b_i z^{-i}}{1 - \sum_{i=1}^{n_a} a_i z^{-i}} \tag{3}$$

The error is defined by equation:

$$e(z) = \hat{B}(z)u(z) - \hat{A}(z)y(z) \tag{4}$$

Where  $\hat{A}(z)$  and  $\hat{B}(z)$  are the estimates of  $A(z)$  and  $B(z)$ .

May provide a recursive form of estimated  $\hat{\theta}$  using the recursive least squares algorithm [12]:

$$\hat{\theta}(k+1) = \hat{\theta}(k) + \gamma(k)e(k+1) \tag{5}$$

with :

$$\begin{cases}
\gamma(k) = \frac{1}{\Psi^T(k+1)P(k)\Psi(k+1) + 1} P(k)\Psi(k+1) \\
P(k+1) = [I - \gamma(k)\Psi^T(k+1)]P(k) \\
e(k) = y(k) - \Psi^T(k)\hat{\theta}(k-1)
\end{cases}$$

For the minimization of the output error, instead of as previously calculate the error equation, rather evaluates the output error, given by:

$$e(k) = y(k) - \hat{y}(\theta, k) \tag{6}$$

Where:  $\hat{y}(\theta, z) = \frac{\hat{B}(z)}{\hat{A}(z)}u(z)$  and  $\hat{y}(\theta, z)$  is

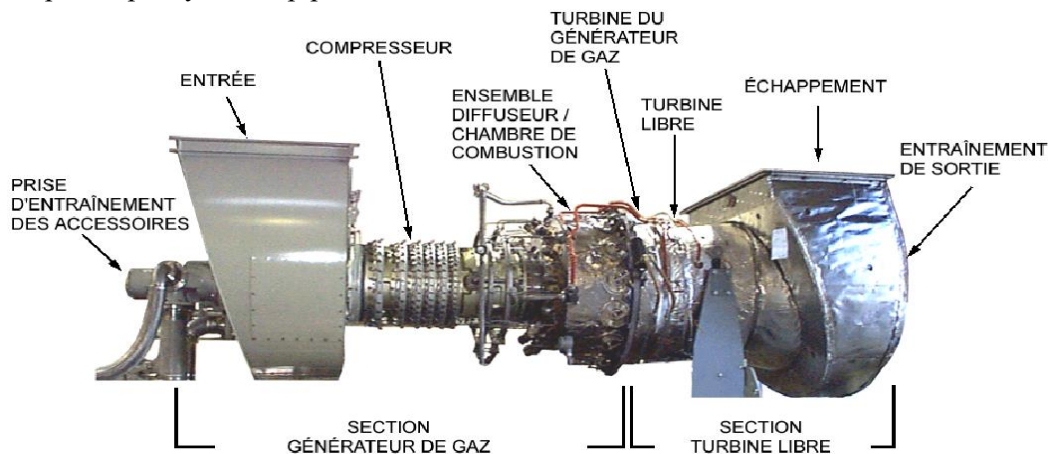
the model output.

The output of error  $e(\cdot)$  in this case is being a nonlinear function of the parameters to be estimated, then numerical optimization methods are used to minimize the error  $e(k)$  with respect to  $\theta$  parameters. From the modeling of these residues, a strategy of the output control of the studied gas turbine parameters, based on the optimization of their operating variables which will be introduced in the implementation section, which are typically zero mean and a variance determined in the absence of malfunctions.

### 3. Industrial Application

A gas turbine is a combustion engine that can convert natural gas or other liquid fuels to mechanical energy, this energy then drives a generator. As part of this work, a gas turbine type two shafts TITAN 130 is studied, this gas turbine is installed at the gas compression station of Sonatrach SC3 in Djelfa, central Algeria. This gas compressor station is located on the pipeline of the GG1 line at a distance of 182 KM from the starting point to Hassi R'Mel southern Algeria, this station will enhance the transport capacity of the pipeline 07 to

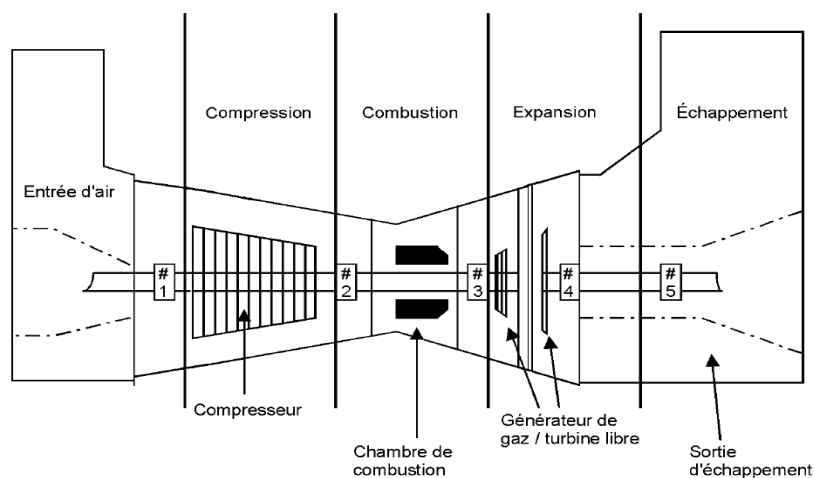
13 billion m<sup>3</sup> per year. It also has three turbochargers and a turbine generator, a control building equipped with DCS (Digital Control System). The *Titan 130* two-shaft is rated at 20,500 hp with 36.2% efficiency and its single shaft configuration is rated at 15.0 MWe with 35.2% at ISO operating conditions [17]. The turbomachinery comprises a turbine engine and a compressor mounted on a steel frame, with the support systems and ancillary anti-slip material, this turbomachinery is means; (Compressor Set / Mechanical Drive: All Compressor / Drive Mechanical), as shown in Figures 2.



*Fig. 2. Diagram of Titan 130 Two-Shaft Gas Turbine*

The gas turbine provides the power to drive the compressor, has two main parts: the gas generator (GP) and the power turbine (PT). The gas generator (GP) converts the energy of the fuel gas at high temperature that takes the power turbine and

converts rotational energy. The fundamental principle of a gas turbine is converted fuel energy to mechanical energy by the application of a thermodynamic process known by the Brayton cycle, as shown in Figures 3.A and 3. B.



*Fig. 3. A: States air flow of Brayton cycle*

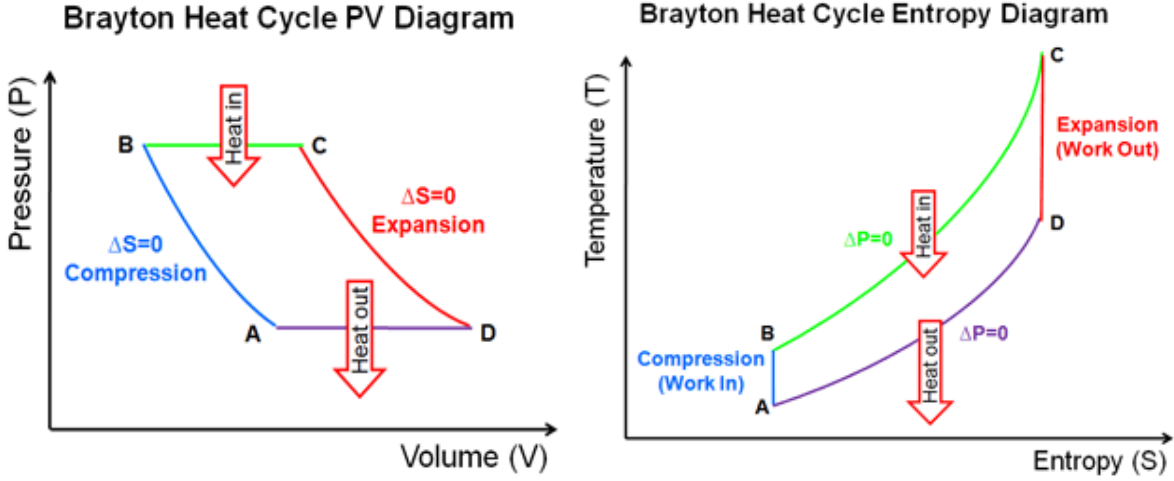


Fig. 3. B: Curves of Brayton cycle

### 3.1. A gas turbine control

The model of the turbine discussed in this work has two entries: room temperature ( $T_1$ ) and mass flow rate of fuel flow ( $\dot{m}_c$ ), sensors supplied from the turbine outputs include: the speed of HP high pressure shaft (NGP), the low pressure shaft (NPT) and the temperature of the blades ( $T_3$ ). These measurements can be used to provide different pairs of input / output for the closed loop control. There are other important variables such as;

The air mass flow ( $\dot{m}_a$ ), the pressure ratio at the outlet of the axial compressor (PCD) and the fuel / air ratio ( $f$ ).

The proposed control configuration is shown in Figure 4, with the nonlinear model used for PI control configuration (proportional / integral). This closed loop control strategy is chosen for parameter optimization of a PI controller structure is designed for a nominal operating point of the discussed gas turbine.

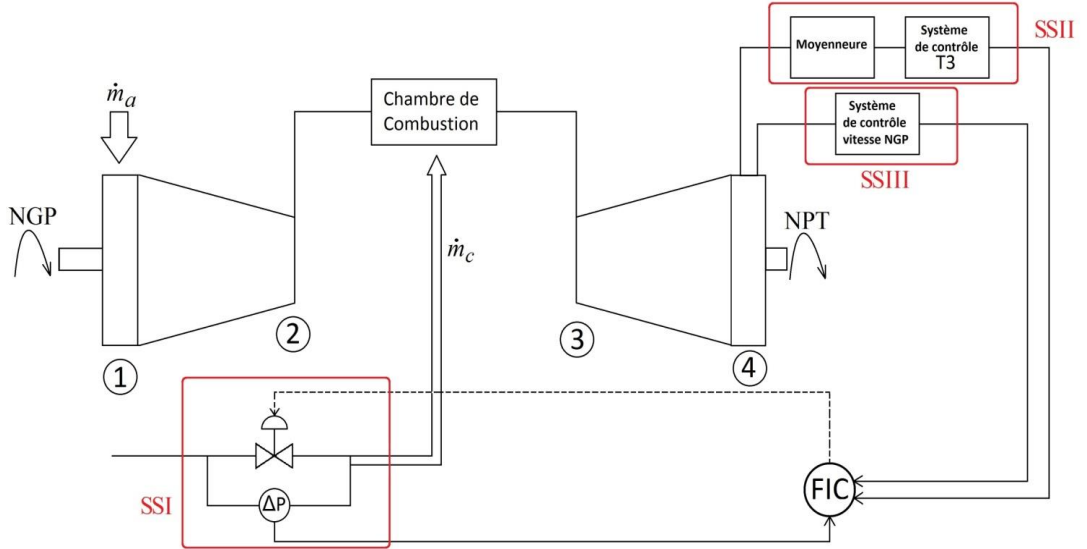


Fig. 4. Control setting of different subsystem of the TITAN 130 turbine

The mass flow rate of fuel flow ( $\dot{m}_c$ ) is given by:

$$\dot{m}_c = \sqrt{\Delta P} \cdot \frac{1}{2} \rho \mu^2 = \frac{\sqrt{\Delta P}}{k} \quad (8)$$

The air mass flow ( $\dot{m}_a$ ) is given by:

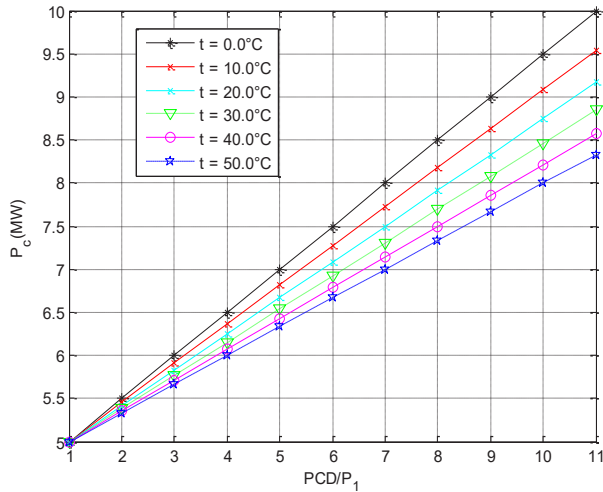
$$\begin{aligned} \dot{m}_a &= k'(P_2 - P_1) \\ \dot{m}_a &= k'(PVD - P_{atm}) \end{aligned} \quad (9)$$

The fuel / air ratio is calculated to ensure the control of the ratio  $f$  which is given by:

$$f = \frac{(T_3 - T_2)}{\eta_b \cdot CV + T_3} \quad (10)$$

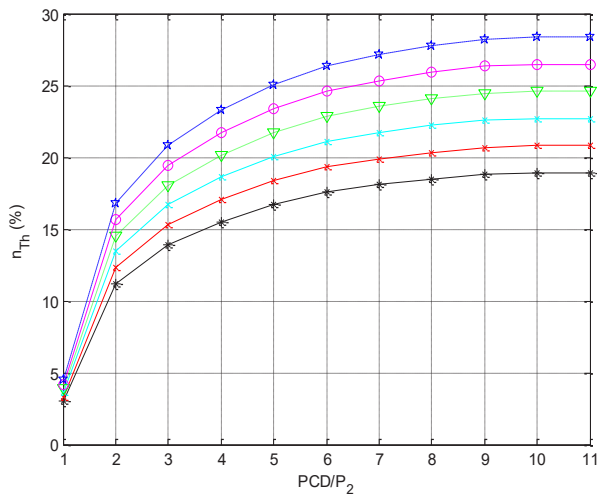
### 3.2. Application results

The multidisciplinary optimization results developed in this work allows the control of gas turbine output variables. Figure 5 shows that the power absorbed by the compressor is proportional to the pressure ratio for an ambient temperature range ( $0^\circ\text{C} < T_{\text{amb}} < 50^\circ\text{C}$ ).



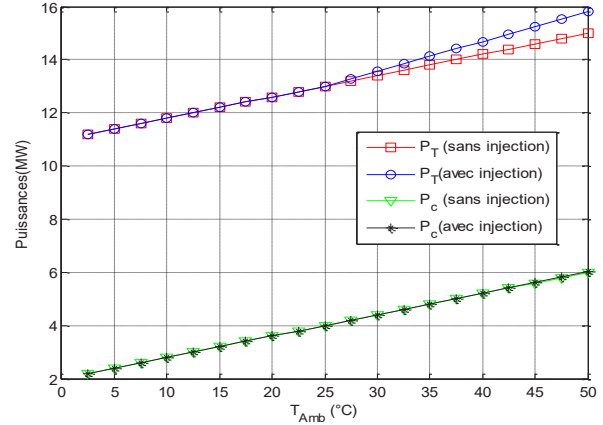
**Fig. 5.** Gas turbine power at different operating temperature

In Figure 6, when the ambient temperature is high ( $> 30^\circ\text{C}$ ), it is noted that the performance of the profile tends to a maximum value of 7. Every time, it is not possible to exceed the value ( $\varepsilon \approx 8.7091$ ) given by the manufacturer, because of the limitations imposed by the resistance of materials.

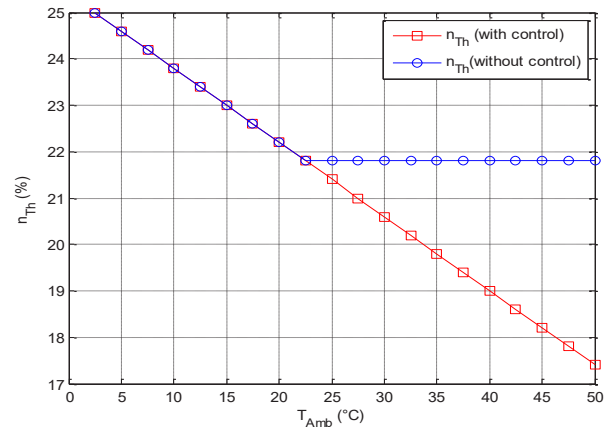


**Fig. 6.** Gas turbine efficiency at different operating temperature

On Figure 7 and 8, the power absorbed by the compressor and that supplied by the turbine will vary proportionally with the ambient temperature and the PT remains almost constant because the combustion temperature limit (given by the manufacturer).



**Fig. 7.** Gas turbine power at different operating pressure



**Fig. 8.** Yield control of the examined gas turbine

Figure 9.A shows the discharge pressure variation of the fuel gas valve in the combustion chamber, and the variation of its residue is shown in Figure 9.B. Figure 10.A shows the discharge pressure change axial compressor and the variation of its residue is given in Figure 10.B, the control of the position of the fuel valve to the gas inlet of the combustion chamber is shown in Figure 11.

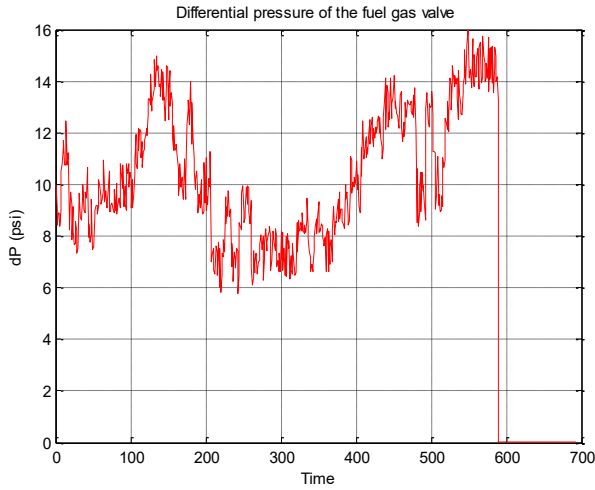


Fig. 9. A: Differential pressure of the fuel gas valve

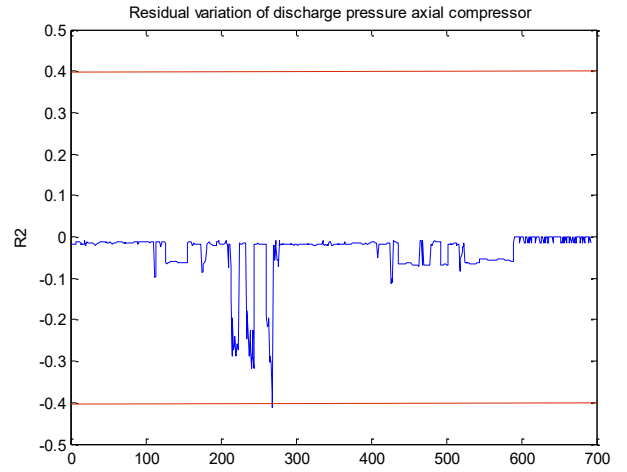


Fig.10. B: Residual variation of discharge pressure axial compressor

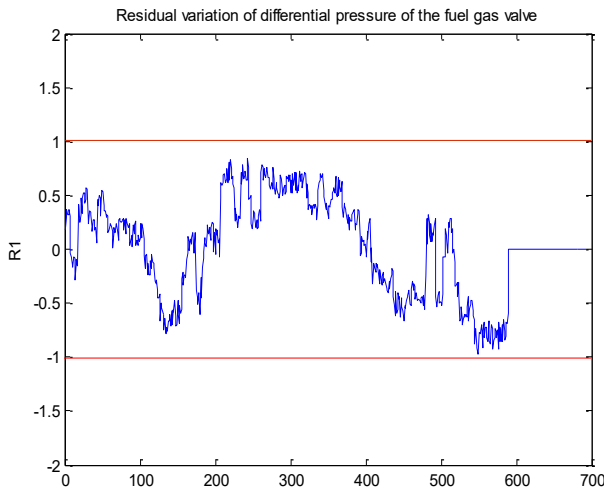


Fig. 9. B: Residual variation of differential pressure of the fuel gas valve

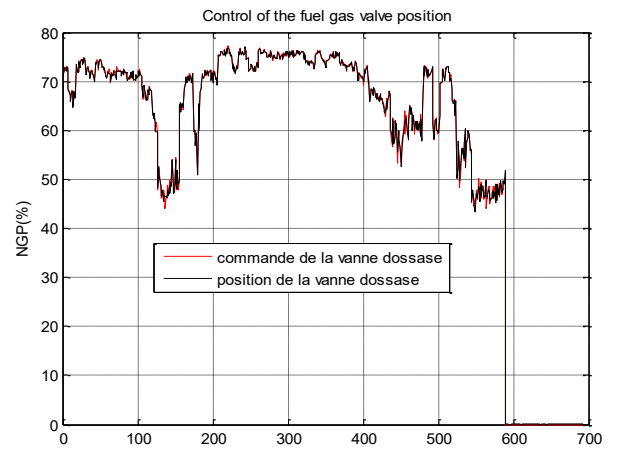


Fig. 11. Control of the fuel gas valve position

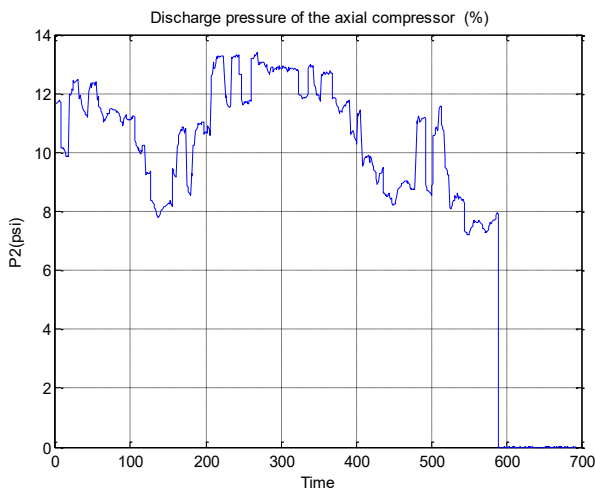


Fig. 10. A: Discharge pressure axial compressor

The turbine rotational speed variation NGP are controlled, after optimizing the manipulated variables pressure and mass flow rate suction and gas turbine system of delivery is given in Figure 8, the speed sensor is used in order to measure the speed of rotation of the HP shaft of the axial compressor, where the target value recommended by the manufacturer is 100%.

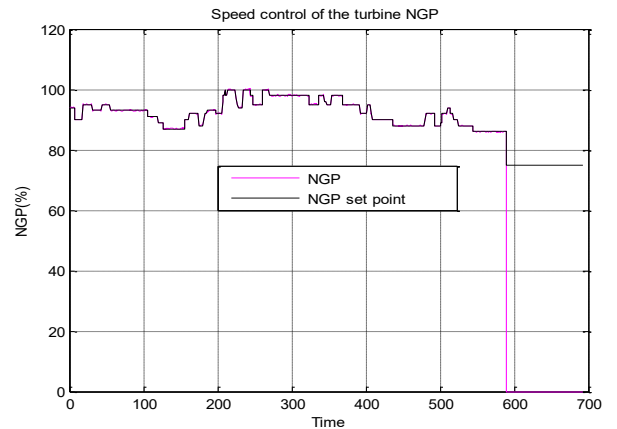
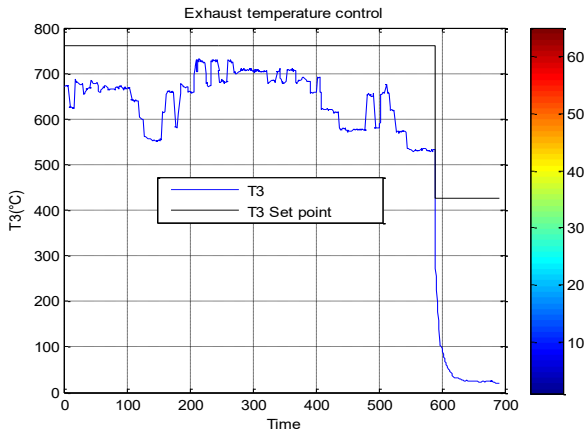


Fig. 12. Speed control of the turbine NGP

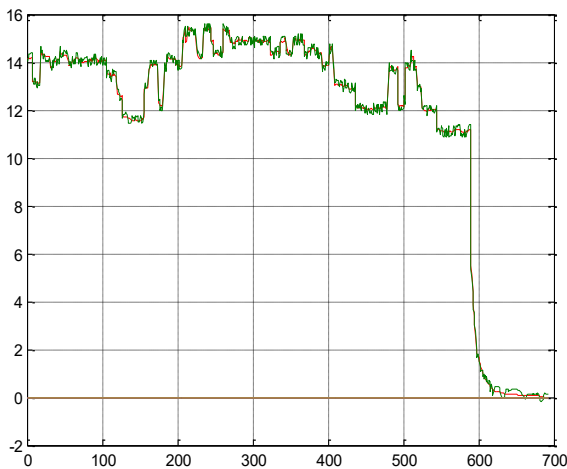


To confirm the control performance in more detail, validation tests were performed on the considered gas turbine, Figure 13 shows the variation of exhaust temperature of the examined turbine.



**Fig. 13.** Exhaust temperature control

This method leads to an improvement of the efficiency of a gas turbine, Figure 14 shows the variation of combustion efficiency. For normal operation of the studied gas turbine, when the ambient temperature rises above the reference machine performance decreases. The reduction becomes large when the room temperature is maximum, as shown in Figure 14.

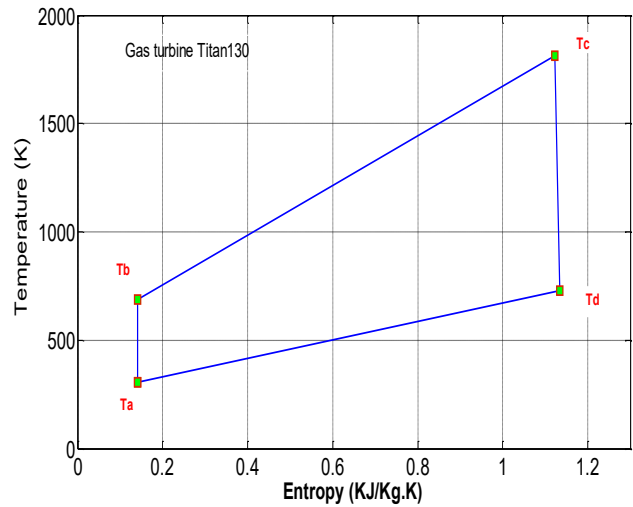


**Fig. 14.** Combustion efficiency

Figure 15 shows converted fuel energy to mechanical energy by the application of a thermodynamic process known by the Brayton cycle.

The results of multidisciplinary optimization, applied to the control of the gas turbine output variable are satisfactory. They are used to solve some problems of supervision of this type of rotating machine. This allows the improvements in terms of studied gas turbine cost oversight, and the control configuration proposed

also led to the improvements in the operation of the studied gas turbine.



**Fig. 15.** T-S diagram of the real process in the studied gas turbine

#### 4. Conclusion

The gas turbine system is composed of sensitive organs to accidental defects that can be critical and costly humanly and financially at the same time during the continuous operation of this system, especially in the gas transportation pipeline. Indeed, the complexity of the supervision in gas turbine plants is due to the strong interaction of the control loops in these industrial systems. For this purpose, the present paper presents the development of a multidisciplinary optimization which allows an efficient data representation of the studied gas turbine variables by integrating a control configuration for these variables. The improvements that have been obtained by using the optimized gas turbine output variables to simplify their control. These improvements are reflected in the performance of the power quality and output of the studied gas turbine.

#### REFERENCES

1. Abdelhafid Benyounes, Ahmed Hafaiifa and Mouloud Guemana, (2016). Gas turbine modelling based on fuzzy clustering algorithm using experimental data. *Journal of Applied Artificial Intelligence*, Taylor & Francis, vol. 30, no. 1, pp. 29-51.
2. Abdelhafid Benyounes, Ahmed Hafaiifa and Mouloud Guemana, (2016). Fuzzy logic addresses turbine vibration on Algerian gas line. *Oil & Gas Journal* | Jan. 4, pp. 22-28
3. Ahmed Hafaiifa, Guemana Mouloud and Saadat Boulanouar, (2016). Monitoring system based on real data acquisition for vibrations control

- in gas turbine system. *Revue de Nature & Technologie: A- Sciences fondamentales et Engineering*, vol. Jan. n° 14, pp. 13 – 18.
4. Boulanour Saadat, Ahmed Hafaifa and Mouloud Guemana, (2016). Vibration analysis and measurement based on defect signal evaluation: Gas turbine investigation. *Journal of Advanced Research in Science and Technology*, vol. 3, no 1, pp.271-280
  5. Benrabeh Djaidir, Ahmed Hafaifa and Kouzou Abdallaha, Vibration detection in gas turbine rotor using artificial neural network. Proceedings of the International Conference on Acoustics and Vibration ATAVI'16, March 21-23, 2016, Hammamet -Tunisia
  6. Mohamed Ben Rahmoune, Ahmed Hafaifa, Mouloud Guemana, Fault diagnosis in gas turbine based on neural networks: Vibrations speed application. Proceedings of the International Conference on Acoustics and Vibration ATAVI'16, March 21-23, 2016, Hammamet -Tunisia
  7. Djamel Halimi, Ahmed Hafaifa and Elahmoune Bouali (2014). Maintenance actions planning in industrial centrifugal compressor based on failure analysis. *The quarterly Journal of Maintenance and Reliability*. Maintenance and Reliability, Vol. 16, no. 1, pp. 17–21
  8. Bindi Chen, Peter C. Matthews, Peter J. Tavner, (2013). Wind turbine pitch faults prognosis using a-priori knowledge-based ANFIS. *Expert Systems with Applications*, vol. 40, no. 17, pp. 6863-6876.
  9. Forbes G.L. and R.B. Randall, Simulated gas turbine casing response to rotor blade pressure excitation. Proceeding of the 5th Australasian Congress on Applied Mechanics, ACAM 2007, 2007, Brisbane, Australia.
  10. Grondahl C.M., M.E. Guiler, G.E. Jurczynski and R. Zell (1990), Performance and reliability improvements for MS3002 and MS5001 turbines in pipeline applications. Proceeding of the Petroleum and Chemical Industry Conference: Industry Applications Society 37th Annual, Houston, TX , USA, pp. 135 – 144.
  11. Gwo-Chung Tsai (2004), Rotating vibration behavior of the turbine blades with different groups of blades. *Journal of Sound and Vibration*, vol. 271, no. 3-5, 6, pp. 547-575.
  12. Hector Sanchez, Teresa Escobet, Vicenç Puig, Peter Fogh Odgaard, (2015). Health-aware Model Predictive Control of Wind Turbines using Fatigue Prognosis. *IFAC-PapersOnLine*, vol. 48, no. 21, pp. 1363-1368.
  13. Martha A. Zaidan, Andrew R. Mills, Robert F. Harrison, Peter J. Fleming, (2016). Gas turbine engine prognostics using Bayesian hierarchical models: A variational approach. *Mechanical Systems and Signal Processing*, vol. 70–71, pp. 120-140.
  14. Qinming Liu, Ming Dong, Wenyuan Lv, Xiuli Geng, Yupeng Li, (2015). A novel method using adaptive hidden semi-Markov model for multi-sensor monitoring equipment health prognosis. *Mechanical Systems and Signal Processing*, vol. 64–65, pp. 217-232.
  15. Ren-Jieh Kuo, Man-Hsin Huang, Wei-Che Cheng, Chih-Chieh Lin, Yung-Hung Wu, (2015). Application of a two-stage fuzzy neural network to a prostate cancer prognosis system. *Artificial Intelligence in Medicine*, vol. 63, no. 2, pp. 119-133.
  16. Yang Chen, Guobiao Cai, Zhenpeng Zhang, Yulong Huang, (2014). Multi-field coupling dynamic modeling and simulation of turbine test rig gas system. *Simulation Modelling Practice and Theory*, vol. 44, pp. 95-118.
  17. Saadatmand, M. R., Rocha, G., 1999, Design and Development of the Solar Turbines Single Shaft Titan 130 Industrial Gas Turbine” Power Gen Europe 1999.

#### Authors' contacts

**Nadji Hadroug**<sup>(1)</sup>, **Ahmed Hafaifa**<sup>(1)</sup>,  
**Kouzou Abdellah**<sup>(1)</sup>, **Mouloud Guemana**<sup>(2)</sup>  
**and Ahmed Chaibet**<sup>(3)</sup>

<sup>(1)</sup> Applied Automation and Industrial Diagnostics Laboratory, Faculty of Science and Technology, University of Djelfa 17000 DZ, Algeria

<sup>(2)</sup> Faculty of Science and Technology, University of Medea, Algeria

<sup>(3)</sup> Aeronautical Aerospace Automotive Railway Engineering school, ESTACA Paris, France

**Nadji Hadroug**<sup>(1)</sup>

E-mail: [N\\_Hadroug@univ-djelfa.dz](mailto:N_Hadroug@univ-djelfa.dz)

**Ahmed Hafaifa**<sup>(1)</sup>

E-mail: [hafaifa.ahmed.dz@ieee.org](mailto:hafaifa.ahmed.dz@ieee.org)

**Kouzou Abdellah**<sup>(1)</sup>

E-mail: [kouzouabdellah@ieee.org](mailto:kouzouabdellah@ieee.org)

**Mouloud Guemana**<sup>(2)</sup>

E-mail: [guemana\\_m@yahoo.fr](mailto:guemana_m@yahoo.fr)

**Ahmed Chaibet**<sup>(3)</sup>

E-mail: [ahmed.chaibet@estaca.fr](mailto:ahmed.chaibet@estaca.fr)