



HAL
open science

Faults detection in gas turbine using hybrid adaptive network based fuzzy inference systems

Nadji Hadroug, Ahmed Hafaifa, Abdellah Kouzou, Ahmed Chaibet

► To cite this version:

Nadji Hadroug, Ahmed Hafaifa, Abdellah Kouzou, Ahmed Chaibet. Faults detection in gas turbine using hybrid adaptive network based fuzzy inference systems. *Diagnostyka*, 2016, 17 (4), pp.3-17. hal-04552727

HAL Id: hal-04552727

<https://hal.science/hal-04552727>

Submitted on 19 Apr 2024

HAL is a multi-disciplinary open access archive for the deposit and dissemination of scientific research documents, whether they are published or not. The documents may come from teaching and research institutions in France or abroad, or from public or private research centers.

L'archive ouverte pluridisciplinaire **HAL**, est destinée au dépôt et à la diffusion de documents scientifiques de niveau recherche, publiés ou non, émanant des établissements d'enseignement et de recherche français ou étrangers, des laboratoires publics ou privés.



Distributed under a Creative Commons Attribution 4.0 International License

See discussions, stats, and author profiles for this publication at: <https://www.researchgate.net/publication/310843123>

Faults detection in gas turbine using hybrid adaptive network based fuzzy inference systems to controlling there dynamic behavior

Article in *Diagnostyka* · January 2016

CITATIONS

26

READS

552

4 authors:



Nadji hadroug nadji hadroug

Ziane Achour University of Djelfa

59 PUBLICATIONS 350 CITATIONS

[SEE PROFILE](#)



Ahmed Hafaifa

Ziane Achour University of Djelfa

344 PUBLICATIONS 1,968 CITATIONS

[SEE PROFILE](#)



Kouzou Abdellah

Ziane Achour University of Djelfa

458 PUBLICATIONS 1,871 CITATIONS

[SEE PROFILE](#)



Ahmed Chaibet

Institut Supérieur de l'Automobile et des Transports

92 PUBLICATIONS 587 CITATIONS

[SEE PROFILE](#)



FAULTS DETECTION IN GAS TURBINE USING HYBRID ADAPTIVE NETWORK BASED FUZZY INFERENCE SYSTEMS

Nadji HADROUG*, Ahmed HAFIFA*, Abdellah KOUZOU*, Ahmed CHAIBET**

* Applied Automation and Industrial Diagnostics Laboratory, Faculty of Sciences and Technology, University of Djelfa 17000 DZ, Algeria, N.hadroug@univ-djelfa.dz, hafaifa.ahmed.dz@ieee.org, kouzouabdellah@ieee.org

** Aeronautical Aerospace Automotive Railway Engineering school, ESTACA Paris, France. Ahmed.CHAIBET@estaca.fr

Abstract

The main aim of the present paper is the implementation of a fault detection strategy to ensure the fault detection in a gas turbine which is presenting a complex system. This strategy is based on an adaptive hybrid neuro fuzzy inference technique which combines the advantages of both techniques of neuron networks and fuzzy logic, where, the objective is to maintain the desired performance of the studied gas turbine system in the presence of faults. On the other side, the representation of fuzzy knowledge in the learning neural networks has to be accurate to provide significant improvements for modeling of the studied system dynamic behavior. The results presented in this paper proves clearly that the proposed detection technique allows the perfect detection of the studied gas turbine malfunctions, furthermore it shows that the use of the proposed technique based on the Adaptive Neuro-Fuzzy Interference System (ANFIS) approach which uses the adaptive learning mechanism of neuron networks and fuzzy inference techniques, can be a promising technique to be applied in several industrial application for faults detection.

Key words: Faults detection, gas turbine, dynamic behavior, adaptive network based fuzzy inference systems (ANFIS).

1. INTRODUCTION

Taking into account the diagnosis impacts on a life cycle of industrial system, the decisions taken during the operation of such system affect profoundly the cost of their life cycle. In fact, the diagnosis system proposed in this work takes into account all operation phases of the studied gas turbine, allows to detect the occurred faults of this complex system and provides the various diagnostic functions required to ensure maximum operating availability this system. Practically, most industrial systems are nonlinear and are characterized by uncertain parameters and / or variable over time, this issue can complicate their control task and involves difficulties in achieving good performance of these systems. Indeed, in the industrial literatures, several solutions have been proposed for solving such problems. some of these researches are presented in this paper briefly.

Recently in 2016, Seixas M. et al. in [38] have proposed a variables modeling and a simulation of the wind turbine installed in an offshore, Hamid Asgari et al. in [11] have realized NARX type models for simulating the startup phase of a gas turbine with a single shaft, Samet E. Arda et al. in

[36] have presented the non-linear dynamic modeling of a modular reactor cooled passively, Houman Hanachi et al. in [14] have tested this last nonlinear modeling to estimate the state of non-Gaussian stochastic system with input for the degradation analysis of a gas turbine.

Other studies have tested the effectiveness of diagnostic approaches based on artificial intelligence; In 2016, Bahareh Pourbabaee et al. in [2] have made a robust approach of detection with isolation for faults sensors in gas turbine subject to variable parameters uncertainties in time, Amozegar M. et al. in [1] have realize the fault detection and isolation applied to a gas turbine using dynamic neural networks identifiers. Also, Cristiano Hora Fontes Pereira and Otacilio in [8] have propose a detection and isolation strategy of faults in gas turbine based on pattern recognition techniques and Ehsan Mohammadi and Morteza Montazeri Gh-have in [9] have study the active faults tolerant control applied to a gas turbine. Mohamed Ben Rahmoune et al. in [28] have realize fault diagnosis in gas turbine based on neural networks applied to the monitoring of speed vibrations and Benrabeh Djaidir et al. in [5] have present a combined approach to the

supervision and the detection of vibrations in a gas turbine using artificial neural networks with wavelet.

In 2015, Jiandong Duan et al. in [15] have realized a nonlinear modeling of a micro gas turbine, Sina Tayarani-Bathaie S. and Khorasani K in [39] have realized the detection of faults in a gas turbine using neural networks, Barsali S. et al. in [3] have presented the dynamic modeling of a biomass plant using micro gas turbine, Soheil Ghabraei et al. [40] have studied an industrial turbine boiler in the presence of modeling inaccuracies and external disturbance using adaptive multivariate approach for their control.

In 2014, Nikpey H. et al. in [30] have presented a modeling and an experimental evaluation of a turbine variable for its control and supervision, Sadough Vanini Z.N. et al. in [34] have made the fault detection and isolation of a dual rotor gas turbine using dynamic neural networks with a multi-model approach.

Although other works were realized in the industrial literature showing the effectiveness of artificial intelligence-based approaches using artificial neural networks and fuzzy logic, for modeling the gas turbine variables used in different industrial sectors.

Recently, the diagnostic systems have been widely adapted to several industrial applications in order to find predictive solutions for the problems of exploitation and operation of industrial processes. However, the need to improve the ability of a diagnostic system in industrial processes, obliges industrial operators to use the predictive approaches in real time to quickly detect potential faults even before their appearances. It is obvious that the use of anticipate accurate diagnosis actions will predict the faults at its birth before it can be significant faults that can degrade or destroy the whole system.

Hence, a reliable failure diagnostic system is required, especially for the heavy equipments installed in vital industrial plants. It is in this context that this work proposes the development of a malfunction detection approach of a gas turbine based on a hybrid adaptive neuro fuzzy inference system approach (ANFIS), where the main aim is to detect accurately the faults and hence to avoid the degradation of the gas turbine system, further more to increase its safety and to decide future decisions affecting the state of operation of this industrial equipment. This work is based on real data collected from onsite of the studied gas turbine plant. Several simulation results are presented based on these obtained data to show the effectiveness and the validity of the proposed strategy.

2. DETECTION OF GAS TURBINE MALFUNCTIONS

In many industrial sectors, especially in the oil industry, the monitoring activity in the rotating machines is a very complex task which requires a lot of information and data concerning the operation of these complex industrial equipment [4, 10, 32 and 33]. Indeed, the current development of new technologies has enabled the improvement of the performances that are expressed through different devices, and has contributed to the development of the monitoring and the control of the industrial systems facilities. This work falls within the framework of malfunction detection of a gas turbine faults using an adaptive hybrid approach with a neuro fuzzy inference system. The proposed technique presented in this paper allows the access to the diagnosis of this kind of rotating machine.

2.1. GAS TURBINE MODELING

In this work, a two shafts gas turbine type GE MS5002C is studied Fig. 1. This gas turbine is being installed in a gas compression station which is located at Hassi Messaoud in south Algeria. The operating parameters of this gas turbine are presented in Table 1. To start up the presented two shafts gas turbine, a mechanical torque is necessary at the mechanical input side of the axial compressor (AC). This turbine is mechanically separated into two sections; the high pressure section (HP) and the low pressure section (LP). The (HP) section operates at a constant speed within a defined power range and it continues in the same time driving the axial compressor after the disconnection of the mechanical torque which is unnecessary in this stage. The (LP) section works with a variable speed and it can change its rotational speed independently of the (HP) section.

Tab 1. Gas turbine GE MS5002C characteristics

Series gas turbine model	Ms- 5002C LHE
Number of compressor stages	16
Compressor type	Axial flow, large capacity
Number of turbine stages	Twin-Shafts
Cycle	5100 rpm Haute-P et 4903
Shaft speed	rpm Base-P
Command	Mark VI SPEEDTRONIC
Operation type	Continuous
R- combustion chamber	98%
Basic performance	38000 hp- condition ISO
Inlet temperature.	59F
Exhaust pressure	14.7 PSI

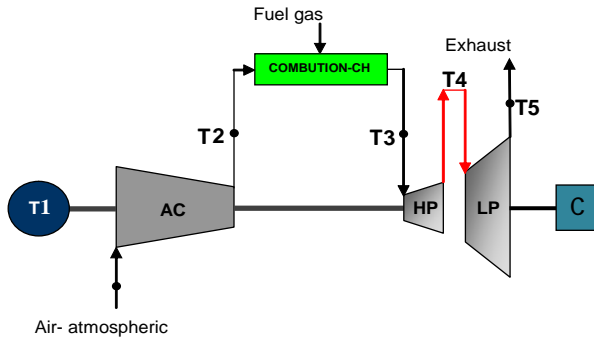

Fig. 1. Examined two shafts gas turbine system

The ideal thermal process of the studied gas turbine is represented in the T-S digraph as shown in Fig. 2.

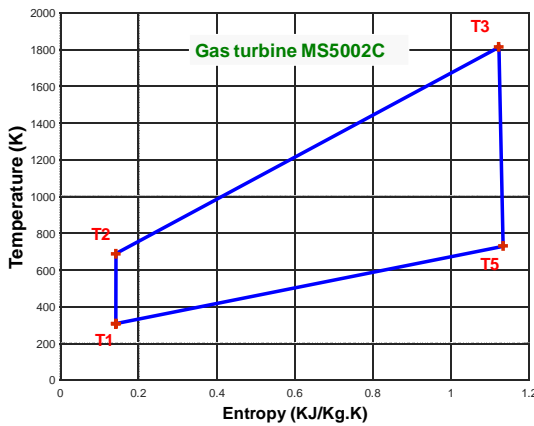

Fig. 2. Gas turbine cycle diagram with two trees MS5002C

In this T-S digraph the compressor temperature is calculated by the following equation:

$$T_2 = T_1 \left(1 + \frac{r_p^{\frac{\gamma_a - 1}{\gamma_a}} - 1}{\eta_c} \right) \quad (1)$$

Where T_1 and T_2 are the ambient temperature and the inside compressor temperature respectively, r_p is the pressure ratio, γ_a is the specific heat ratio, where $\gamma_a = C_{p_a} / C_{v_a} = 1.4$, η_c is the efficiency of the compressor expressed by $\eta_c = (T_{2s} - T_1) / (T_2 - T_1)$. The temperature of the exhaust gas of the gas turbine (LP) section T_5 is expressed as follows:

$$T_5 = T_4 \left(1 - \eta_t \left(1 - \frac{T_{5s}}{T_4} \right) \right) \quad (2)$$

Where T_4 is the wheel space temperature, η_t is the efficiency $\eta_t = \frac{T_4 - T_5}{T_4 - T_{5s}}$.

The temperature of the exhaust gas of the gas turbine (HP) section is expressed as follows:

$$T_4 = T_3 \left(1 - \eta_t \left(1 - \frac{1}{r_p^{\frac{\gamma_g - 1}{\gamma_g}}} \right) \right) \quad (3)$$

Where T_3 is the combustion chamber temperature, with $\gamma_g = 1.333$.

The compressor input power which is the output power of the gas turbine (HP) section is given as follows:

$$\begin{aligned} \text{Power} &= \dot{m}_a \times C_{pa} (T_2 - T_1) \\ &= \dot{m}_g \times C_{pg} (T_3 - T_4) \end{aligned} \quad (4)$$

Where \dot{m}_a is the air mass flow, \dot{m}_g is the gas mass flow, C_{pg} is the specific heat at constant gas pressure, C_{pa} is the specific heat at constant air pressure, with $C_{pa} = 1.005$ and $C_{pg} = 1.149$.

In addition, the thermal efficiency of the T-S cycle is expressed as follows:

$$\eta_{th} = \frac{T_4 - T_5}{T_3 - T_2} \quad (5)$$

2.2. ADAPTIVE APPROACH BASED ON A NEURO FUZZY INFERENCE SYSTEM

The fuzzy modeling is based on more sophisticated tools using the concepts of the theory of fuzzy sets that require sometimes new theoretical developments for the representation of the nonlinear systems behavior [6, 7, 12, 16, 23 and 29]. This representation characterizes the relationship between the input and output variables of the system [13, 27, 31 and 42]. The adaptive neuro-fuzzy inference systems ANFIS have been used in several industrial applications, to improve their effectiveness in modeling, in control and in industrial diagnosis [17, 18, 19, 20, 21, 22, 35, 37 and 41]. The main objective of this paper is to ensure the gas turbine fault detection system using a hybrid approach based on adaptive neuro fuzzy inference mechanism, and to design observers (residues) based on neuro-fuzzy model within a wider operation range of the studied gas turbine.

To explore this adaptive approach with a neuro fuzzy inference system on the case of the studied gas turbine, a construction of fuzzy model is proposed as an identification process of type Takagi-Sugeno-Kang of this system as shown in Fig. 3. Indeed, this process consists of five phases, to describe the behavior of the various input-output variables of this complex system. The base of fuzzy rules is of the following form:

Rule 1: If x_1 is A_1 and x_2 is B_1

$$\text{Then } y_1 = f_1(x, y) = p_1x + q_1y + r_1 \quad (6)$$

Rule 2: If x_1 is A_2 and x_2 is B_2

$$\text{Then } y_2 = f_2(x, y) = p_2x + q_2y + r_2$$

Where x_1 and x_2 are the inputs, A_1 and B_2 are the fuzzy sets, y_1 and y_2 are the outputs of all defuzzification of neurons, p_i , r_i and q_i are the parameters of the i^{th} rule determined during the learning process.

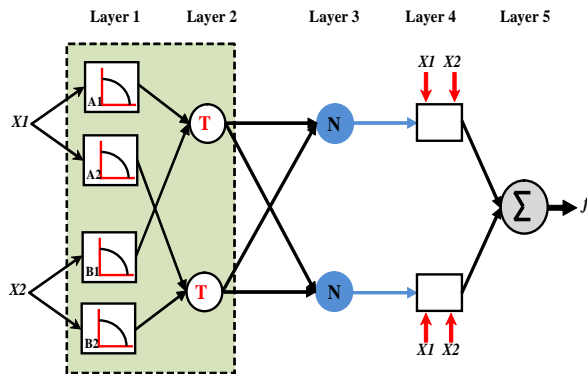

Fig. 3. Adaptive neuro-fuzzy inference system

The outputs of the first layer represent the degrees of membership of the input variables x_1 and x_2 given by:

$$O_i^1 = \mu_{A_i}(x) \quad i = 1, 2 \quad (7)$$

with $\mu_{A_i}(x)$ is the membership function.

Each node in the second layer is a fixed node type noted Π and each of them includes in the output the product (AND operator fuzzy logic) of its inputs which corresponds to the degree of membership of the concerned rule:

$$O_i^2 = w_i = \mu_{A_i}(x) \times \mu_{B_i}(x) \quad i = 1, 2 \quad (8)$$

with $\mu_{B_i}(x)$ is the membership function.

According to equation (9), each of the third node layer is also of fixed type and carries out the normalization of the weights of the fuzzy rules, it is expressed as follows:

$$O_i^3 = \bar{w}_i = \frac{w_i}{w_1 + w_2} \quad i = 1, 2 \quad (9)$$

where w_i this is the degree of membership.

In the fourth layer, each node is adaptive and calculates the outputs of the rules by performing the following function:

$$O_i^4 = \bar{w}_i \times f_i = \bar{w}_i(p_i x + q_i y + r_i) \quad (10)$$

for $i = 1, 2$

The fifth layer comprises a single neuron providing the output ANFIS by calculating the sum of the outputs of the previous layer. This output, which is also the output of the network, is determined by the following expression:

$$O_i^5 = f = \sum_i \bar{w}_i \times f_i \quad (11)$$

2.2.1. LEARNING ALGORITHM

The learning ANFIS system is achieved from a data set for the identification of the premises and consequences parameters as shown in Fig. 4, where the ANFIS structure is fixed. In the case of the studied gas turbine modeling, a hybrid learning rule which combines a gradient descent algorithm with a least squares estimation is proposed. Hence the following expressions are obtained:

$$f = \bar{W}_1 f_1 + \bar{W}_2 f_2 \quad (12)$$

with

$$\begin{cases} f_1 = p_1 x_1 + q_1 x_2 + r \\ f_2 = p_2 x_1 + q_2 x_2 + r_2 \end{cases}$$

So :

$$f = (\bar{W}_1 x_1) p_1 + (\bar{W}_1 x_2) q_1 + \bar{W}_1 r_1 + (\bar{W}_2 x_1) p_2 + (\bar{W}_2 x_2) q_2 + \bar{W}_2 r_2 \quad (13)$$

This is a linear combination of consistent modifiable parameters $\{p_1, q_1, r_1, p_2, q_2 \text{ and } r_2\}$. It is important to note that in this algorithm, the parameters of the premises as well as the consequence parameters are optimized.

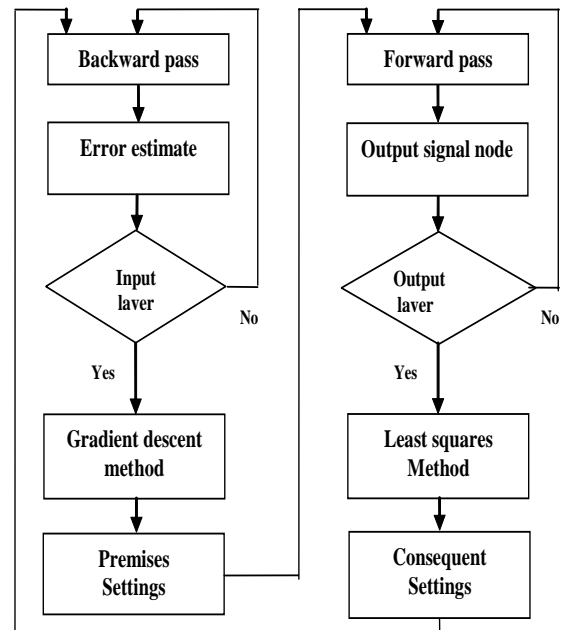

Fig. 4. Learning of the ANFIS algorithm

The MS5002C gas turbine modeling is performed by choosing seven input-output variables, these models allow to approach the behavior of this system by a collection of local models. They have a very important representative capacity [24, 25 and 26]. Indeed, the number of necessary rules to approach a system to a certain degree of accuracy is generally reduced:

$$\begin{aligned}
 \Delta T_{comb} &= ANFIS_1(\Delta W_f, \Delta W_a, \Delta T_c, \Delta F) \\
 \Delta T_t &= ANFIS_2(\Delta W_f, \Delta T_{comb}, \Delta P_c, \Delta T_c, \Delta W_a) \\
 \Delta P_t &= ANFIS_3(\Delta W_f, \Delta P_c, \Delta T_t, \Delta W_a, \Delta F) \\
 \Delta P_{c,HP} &= ANFIS_4(\Delta W_f, \Delta T_c, \Delta W_a, \Delta F) \\
 \Delta T_c &= ANFIS_5(\Delta W_f, \Delta P_c, \Delta W_a, \Delta F) \\
 \Delta W_a &= ANFIS_6(\Delta W_f, \Delta F, P_{c,HP}) \\
 \Delta F &= ANFIS_7(\Delta W_f, \Delta W_a, \Delta P_t, \Delta P_{c,HP})
 \end{aligned}
 \tag{14}$$

Where T_c is the inside compressor temperature, T_t is the inside temperature of the turbine, T_{comb} is the combustion chamber temperature, W_a is the mass flow of air, F is the force, P_t is the pressure of the turbine, $P_{c,HP}$ is the compressor pressure and ΔW_f is fuel flow.

For each studied gas turbine variable, a series of data were used for its identification obtained from operating measurements data of the studied gas turbine. For example, for mass air flow variable, the network ANFIS model used is composed of three inputs and one output as shown in Fig. 5, and each input is fuzzified by three fuzzy sets of Gaussian type.

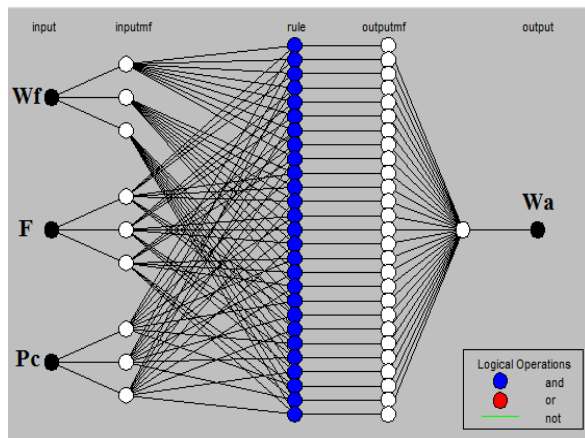

Fig. 5. Network of mass air flow variable ΔW_a model

2.3. NEURO FUZZY MODEL-BASED GENERATION OF RESIDUE

The design of the proposed novel approach for detecting faults in a gas turbine system is carried out in this section as shown in Fig. 6. This approach is proposed in the framework of a gas turbine which is a nonlinear systems to determine the severity of a the detected faults. The idea is based on the quantitative analysis of the residues in the presence of faults in order to establish fault signatures. It is obvious that the use of fuzzy techniques will further characterize the correlation symptoms - faults.

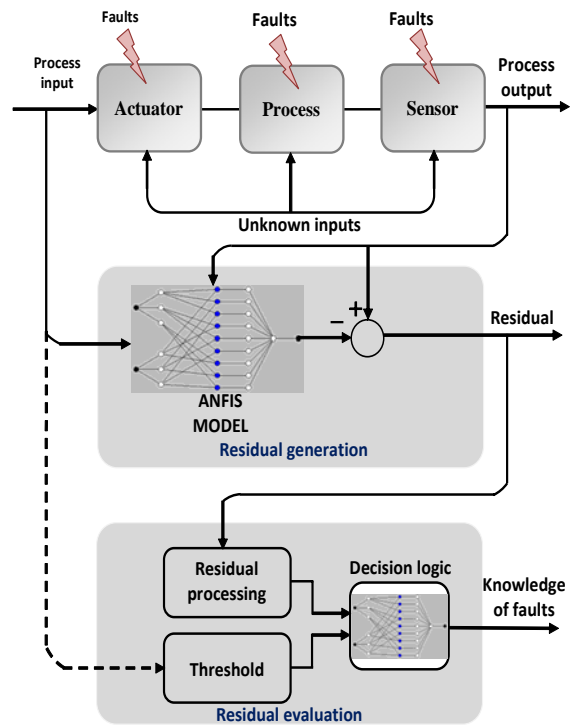

Fig. 6. Diagnostic system based on the proposed model

The basic principle of the proposed system is shown in Fig. 7. It consists of establishing the diagnosis based on the process measured values and the modeled process values.

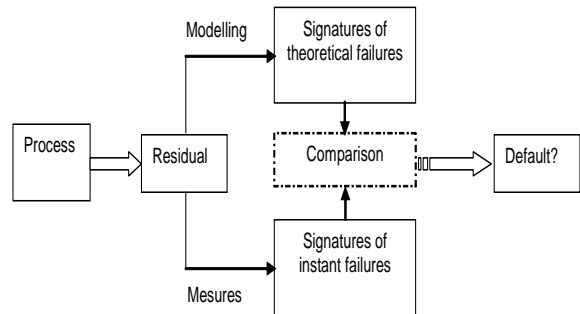

Fig. 7. Residuals generation system

The detection process aims to determine the appearance and the time of fault occurrence. To achieve this goal, the residues that are obtained by comparing the behavior of the system model to the real system are used. It is clear that the residues are representative of differences between the observed behavior of the system and the expected reference behavior when the system operates normally. These residues have generally a zero mean and a determined variance in the absence of malfunctions. A generic way to build a residue is to estimate the system output vector $\hat{y}(\cdot)$. The estimated $\hat{y}(\cdot)$ is then subtracted from the output signal $y(\cdot)$ to form the following residue vector $r(\cdot)$:

$$r(k) = y(k) - \hat{y}(k) \tag{15}$$

In the presence of faults, the signal $r(\cdot)$ differs remarkably from zero, and when the system is operating normally it will be equal to zero.

In practice, the residue has not exactly zero value in the absence of faults because during the modeling phase, several simplifying assumptions are introduced leading to a model that does not accurately reflect the real system. In addition, the measurements obtained from the system are often including noise measurements. The residue vector is then expressed as follows:

$$r(k) = y_m(k) - \hat{y}(k) \quad (16)$$

Where $y_m(\cdot)$ is the measured output of the system which is composed in addition to the actual output $y(\cdot)$, the noise of various kinds relating to instrumentation and the modeling uncertainties. In this situation, a simple detection method involves in comparing the value of the residue to a predefined threshold ε (function modeling errors). An alarm is triggered at each crossing of this threshold:

$$\begin{cases} r(k) \leq \varepsilon \Leftrightarrow d(k) = 0 \\ r(k) > \varepsilon \Leftrightarrow d(k) \neq 0 \end{cases} \quad (17)$$

Where $d(\cdot)$ represents the vector of faults.

In the studied case, a set of residues $r_i(\cdot)$ is firstly built and which is depending on the studied gas turbine faults. It presents the difference between the reference model output and the output of the actual model. Based on this results of residues, a more advanced residues are formed making basic residues insensitive to certain faults. To achieve this, a structuring of the generated residues set is performed to ensure the fault location from the residues of seven chosen variables of the studied gas turbine. These variables are :

$$R_{\Delta T^*_{comb}}, R_{\Delta T^*_t}, R_{\Delta P^*_t}, R_{\Delta P^*_{c.HP}}, R_{\Delta T^*_c}, R_{\Delta W_a} \text{ and } R_{\Delta F}$$

3. APPLICATION RESULTS

For the investigation and tests of the proposed approach, the actual operating data of the studied gas turbine was used in adaptive neuro-fuzzy interference system modeling, to present the dynamics of the turbine in operational mode. Figure 8 shows the fuel flow variations W_f , Figure 9 shows the variations of the force output F and the Fig. 10 shows the variations of compressor pressure $\Delta P_{C.HP}$. These three variables are used as inputs in the proposed adaptive neuro-fuzzy interference system ANFIS.

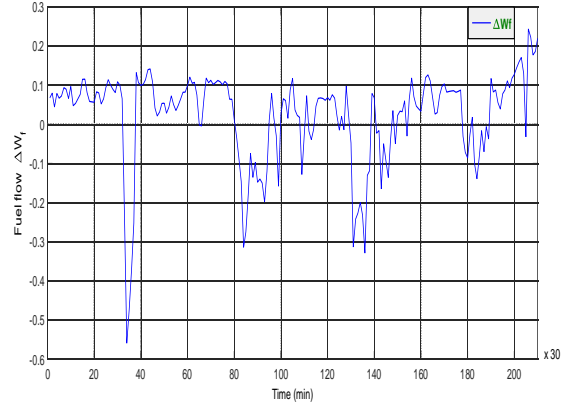

Fig. 8. Fuel flow variations W_f

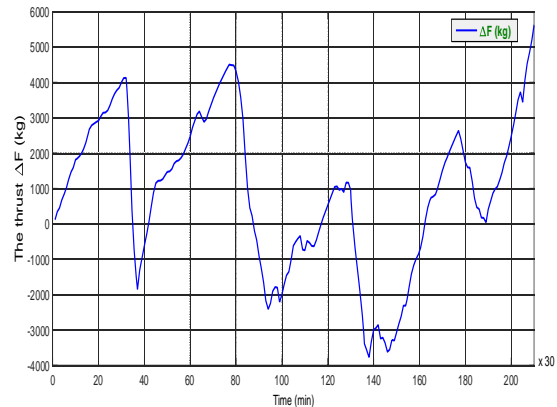

Fig. 9. Force output variation F

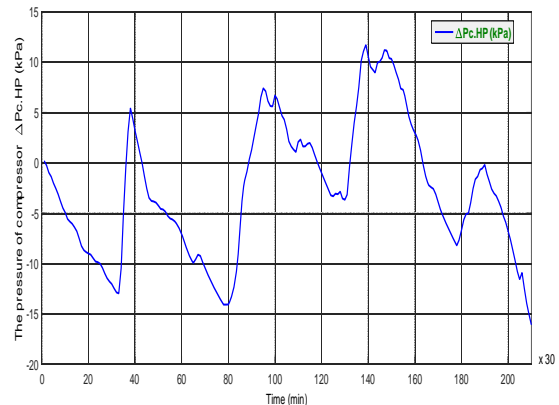

Fig. 10. Compressor pressure variations $\Delta P_{C.HP}$

These three inputs (W_f , F and $\Delta P_{C.HP}$) are used to generate the output W_a of the proposed adaptive neuro-fuzzy interference system ANFIS, each entry is fuzzified by three Gaussian fuzzy sets (Small, Medium and Large) that are shown in Fig. 11. To get the ANFIS model. The fuzzy-neuro model contains the following parameters:

- Gaussian membership functions,
- 27 fuzzy rules;
- 100 Iteration learning;
- 05 layers;
- 09 neurons in the first hidden layer (fuzzification);

- 27 neurons in the second hidden layer (fuzzy rules);
- 27 neurons in the third hidden layer (normalization);
- 27 neurons in the fourth concealed layer (linearization);
- A neuron single in the fifth layer (F).

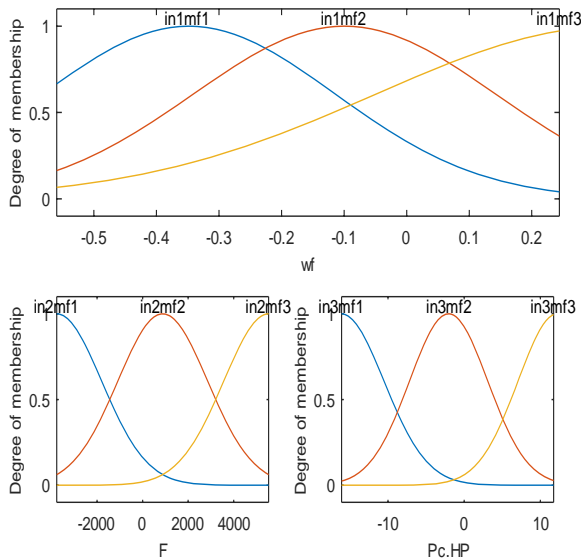

Fig. 11. Gaussian fuzzy membership function

In this case, the behavior of the examined gas turbine system are analyzed. This scenario is often used to ensure that the instantaneous values of residues do not exceed in any case the limits defined by the detection thresholds, as shown in Figures 12 to 18. In these Figures, no symptom should be found, because a false alarms was detected by the proposed diagnostic system.

Figures 12, 13, 14, 15, 16, 17 and 18 respectively, present the variation of the actual output of the combustion chamber temperature ($R_{T_{comb}}$), the variation of the turbine temperature (R_{T_t}), the variation of the turbine pressure (R_{P_t}), the variation of compressor pressure (R_{P_c}), the variation of the compressor temperature (R_{T_c}), the mass air flow (R_{W_a}) and the force ($R_{\Delta F}$). The associated residue to each output variable is compared to the reference fuzzy model.

Other fault detection tests in the studied gas turbine have been carried out, Figure 19 shows the appearance of a fault at the combustion chamber with the associate residues. This fault is depending on the temperature increase, which is due to the malfunction of the combustion chamber cooling system. The proposed technique ANFIS proposed in this paper allow to detect accurately the mentioned increase of the temperature T_{comb} in the combustion chamber, where the fault is in this case can be perfectly detected and localised with high accuracy. On the other side, at the instant 2250 min a fault is detected based on the detection of the residue value which exceeds the threshold range value of ± 0.42 .

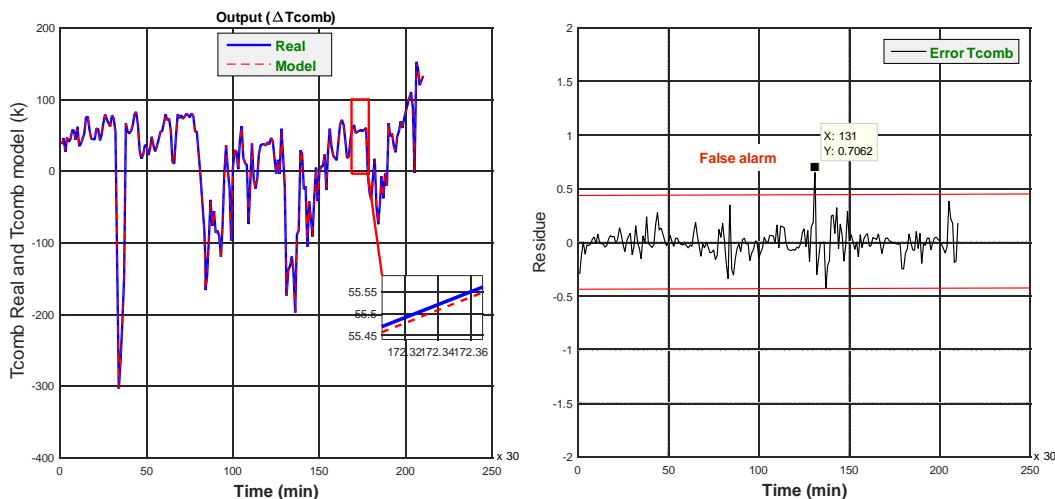

Fig. 12. Output of the combustion chamber temperature compared by the fuzzy model with their associated residue ($R_{T_{comb}}$)

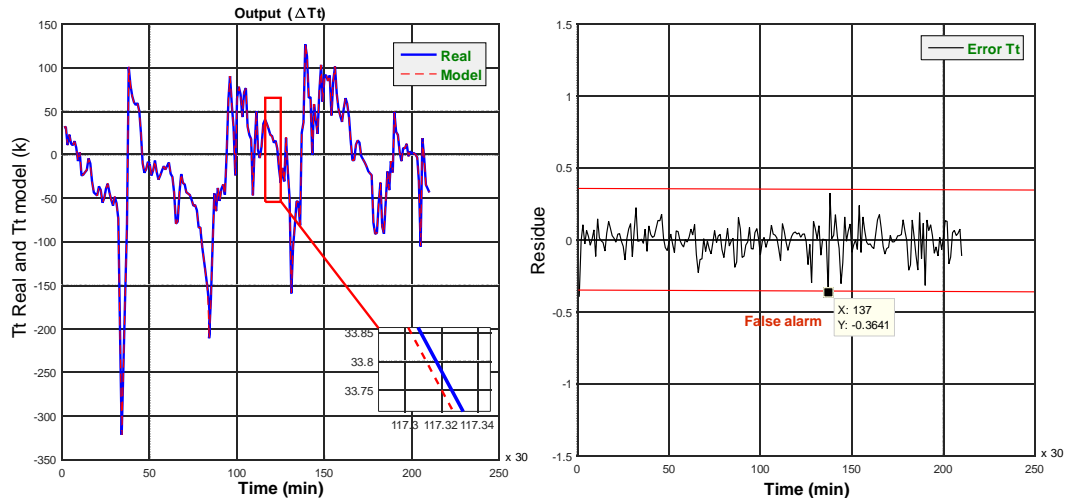

Fig. 13. Output of the temperature of the turbine compared by the fuzzy model with their associated residue (R_{Tt})

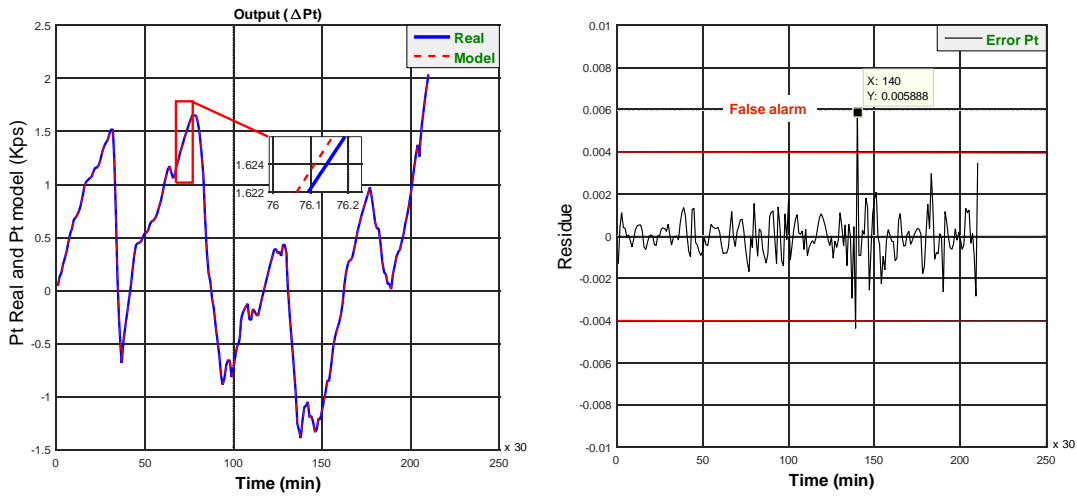

Fig. 14. Turbine pressure output compared by the fuzzy model with their associated residue (R_{Pt})

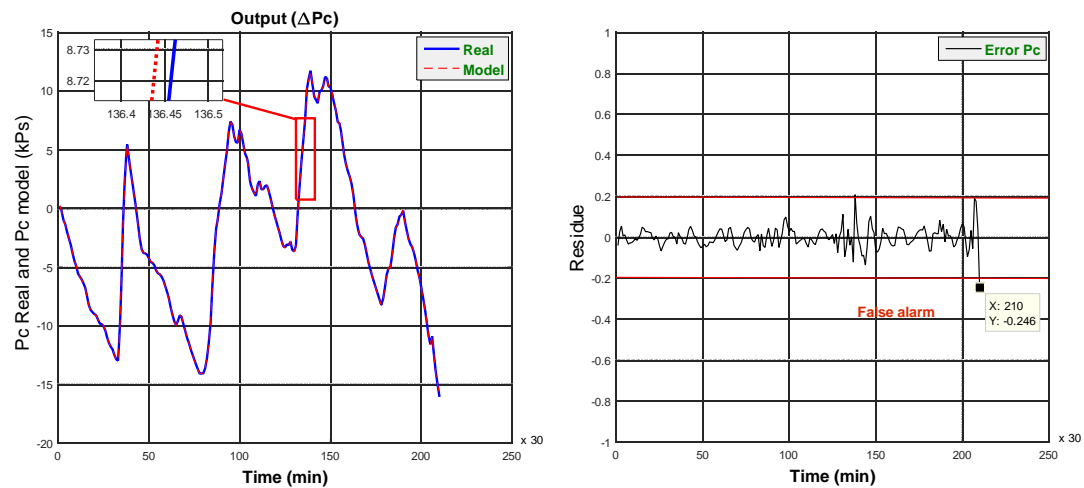

Fig. 15. Pressure compressor output compared by the fuzzy model with their associated residue (R_{Pc})

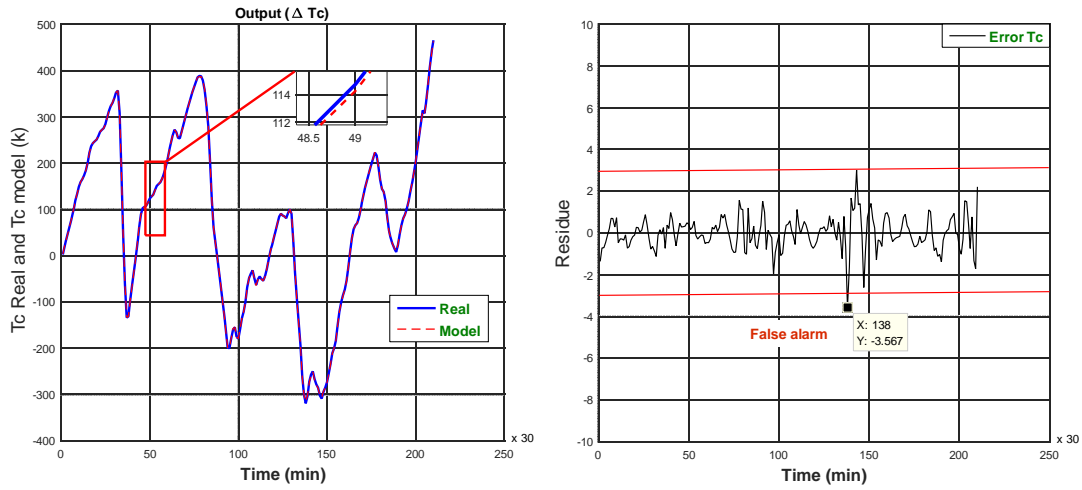

Fig. 16. Compressor temperature output compared by the fuzzy model with their associated residue (R_{Tc})

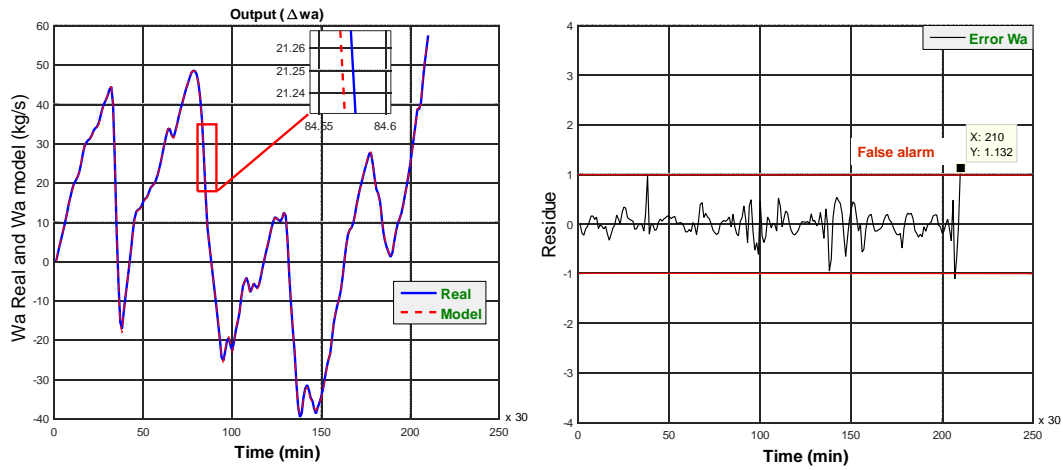

Fig. 17. Output of the mass flow of air compared by the fuzzy model with their associated residue (R_{Wa})

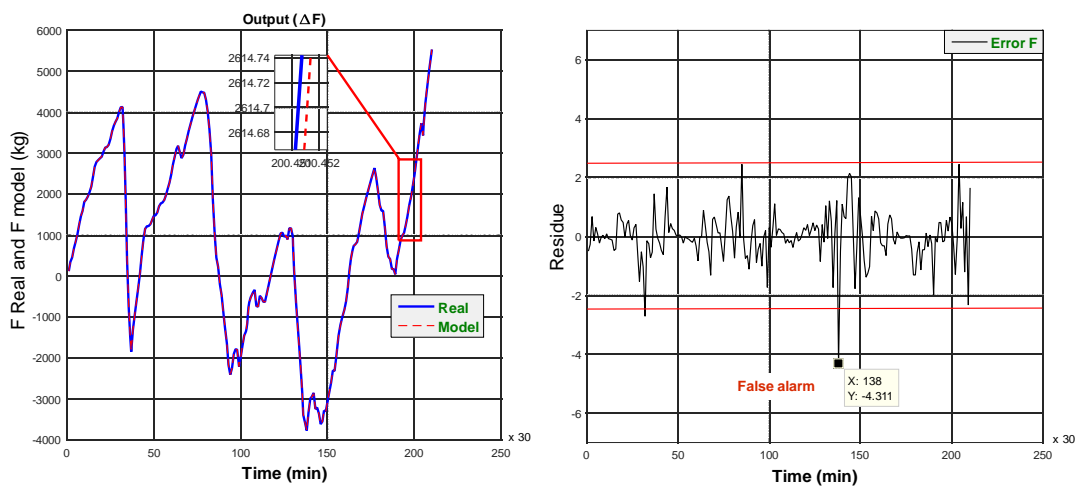

Fig. 18. Output of force compared by the fuzzy model with their associated residue (R_F)

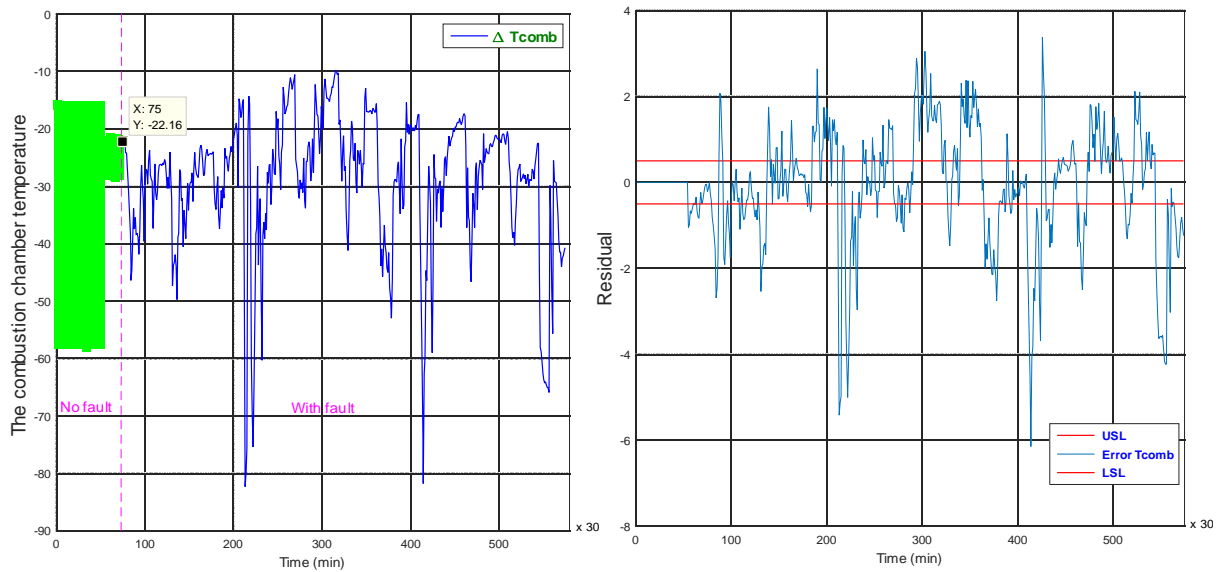

Fig. 19. Appearance of a fault in gas turbine combustion chamber with there associate residues

The evaluation of the obtained residue of the temperature variations in the combustion chamber is performed. Figure 20 shows the output of the second ANFIS model which is used to identify the presence of fault period. Depending on the output of the ANFIS, the zero value means that there is no fault, whereas when this output is equal to one, a fault is occurred and detected. In the same time, Figure 20 presents more details of the fault appearance based on the three dimension (3D) heat maps technique which can visualize clearly the degree of the fault, as the more concentrated red color is approaching, the alarm systems can be activated for the detection of the fault.

Finally, the obtained results show clearly the robustness and the flexibility of the proposed

ANFIS technique used in this paper which is applied for the fault detection in a gas turbine system.

3.1. RESIDUALS EVALUATIONS

The method of Shewhart mean technique is used for the evaluation of the obtained residues to achieve the detection of the abrupt change of a statistical characteristic of a signal using the principle of the control graph which is divided into three lines: the first line is presenting the centre, the other two lines are presenting the two boundaries that are named "upper control limit (UCL)" and "Lower control limit (LCL)". This method uses the normal distribution for the calculation of the standard deviation.

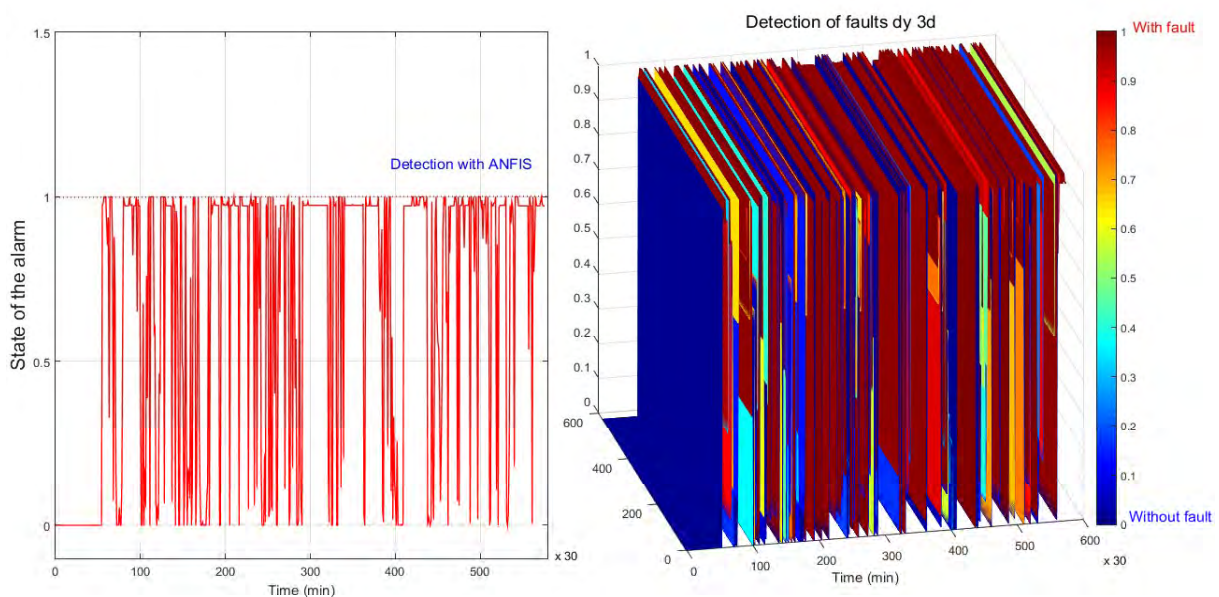

Fig. 20. Output of the ANFIS model used to identify the presence of default with technical heat maps three dimension

In the general case when the number of samples $N > 100$, the mean value and the standard deviation values can be calculated respectively by the following expressions:

$$\begin{cases} \mu = \sum X / N \\ \sigma = \sqrt{\sum (x - \mu)^2 / N} \end{cases} \quad (18)$$

For a special samples size of n the mean value and the standard deviation values can be calculated respectively as follows:

$$\begin{cases} m = \sum X_i / n \\ s = \sqrt{\sum (x_i - m)^2 / (n - 1)} \end{cases} \quad (19)$$

The process is centred and it follows the normal distribution (mean m and standard deviation μ) or sample follows a normal distribution (mean m and standard deviation s / \sqrt{n}), hence:

$$(UCL, LCL) = \pm K_1 * \text{Standard deviation} \quad (20)$$

where K_1 is the number standard deviation.

The following table 2 summarizes the mean m and standard deviation of each output.

Tabl. 2 Fault detection threshold

The error	m	S	(UCL,LCL)
e_{Tcomb}	$-2 * 10^{-5}$	1.14	0.42
e_{Tt}	$-4 * 10^{-5}$	1.11	0.33
e_{Pt}	$-9 * 10^{-8}$	$\frac{0.001}{3}$	0.004
$e_{Pc.HP}$	$-9.42 * 10^{-7}$	0.07	0.2
e_{Tc}	$3.11 * 10^{-5}$	1	3
e_{Wa}	$2 * 10^{-6}$	0.33	1
e_F	$1.01 * 10^{-4}$	1	3

This part of the work is dedicated to the evaluation of obtained residues. The experimental study presented in this paper is based on the proposed ANFIS approach, which is used for the evaluation of the obtained residues. Indeed, the data collected from inputs / outputs measurements of the studied gas turbine system, allows to apply the ANFIS based diagnostic algorithm in real time. Figures 21, 22, 23, 24, 25 and 26 respectively show the variation of the obtained residues, that are compared with detection tests of the Shewhart mean of each variable of the studied gas turbine system.

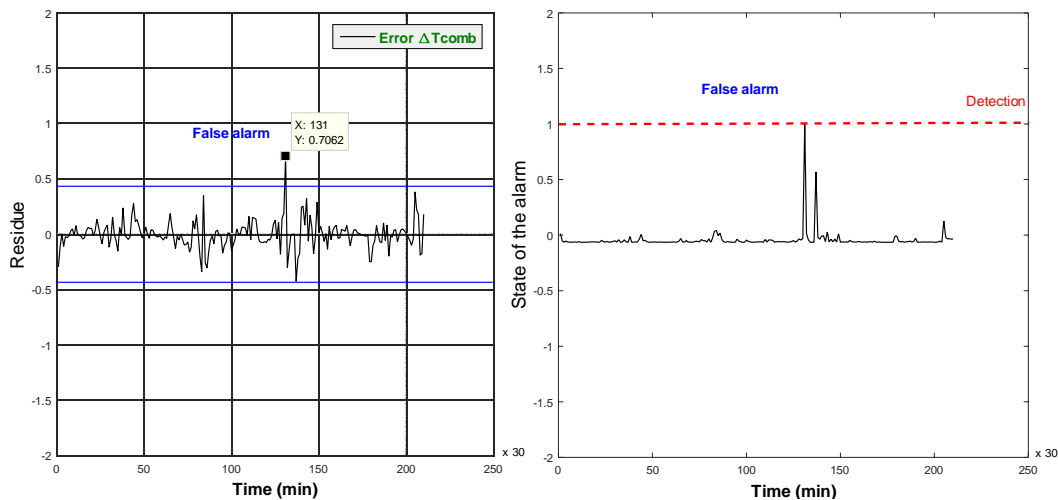

Fig. 21. Residual variation of the combustion chamber temperature (R_{Tcomb}) with the test detection Shewhart

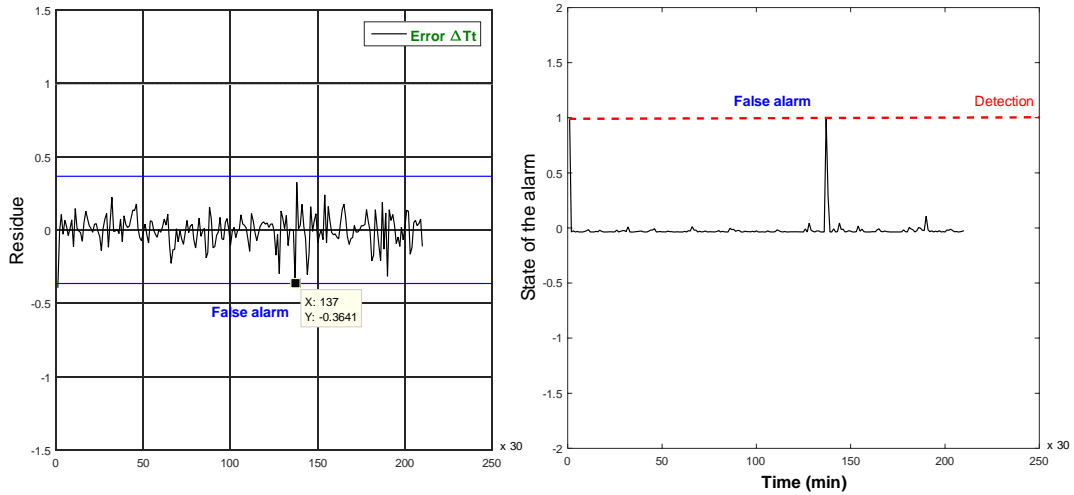

Fig. 22. Residual variation of the temperature of the turbine (R_{T_t}) with the test detection Shewhart

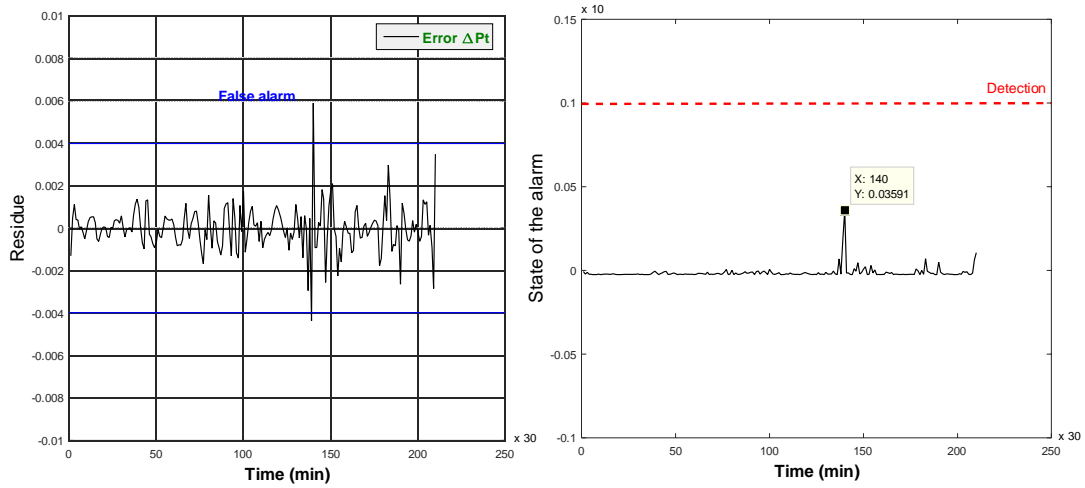

Fig. 23. Residual variation of turbine pressure (R_{P_t}) with the test detection Shewhart

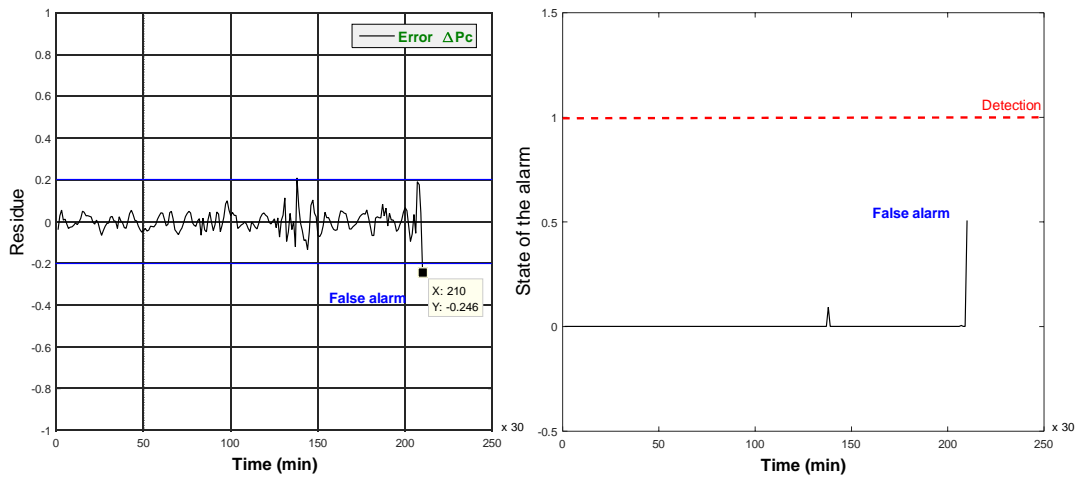

Fig. 24. Residual variation of compressor pressure (R_{P_c}) with the test detection Shewhart

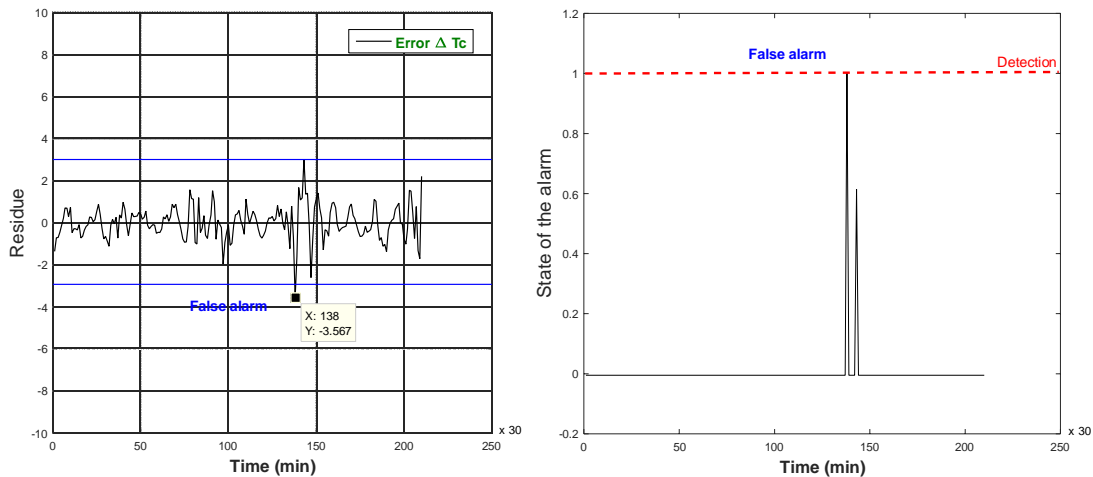

Fig. 25. Residual variation of compressor temperature (R_{Tc}) with the test detection Shewhart

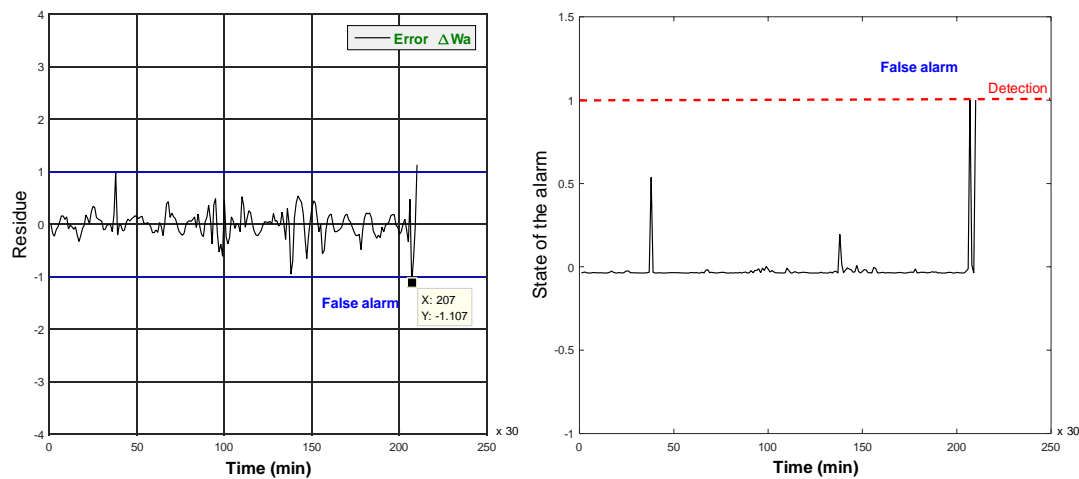

Fig. 26. Residual variation of the mass air flow (R_{Wa}) with the test detection Shewhart

After the step of generating the residues that are presented in Figures 21, 22, 23, 24, 25 and 26, the next task is their evaluation for fault detection. For this, the neuro-fuzzy model of type ANFIS have been proposed to determine and to localize the type of faults which affects the gas turbine system based on the residues generated previously. Indeed, the method of maps of the Shewhart mean was used to detected the sudden change of studied system statistical characteristics. The results presented in this work show the effectiveness of the proposed diagnostic system.

4. CONCLUSION

This paper presents the implementation of a hybrid approach based on ANFIS models for fault detection. It is proved in the present paper that the ANFIS system can be a very suitable tool for the design of an intelligent controllers, because it is able to ensure the inference with learning capacity of neural networks. The proposed approach is applied to detect the faults of a gas turbine GE MS5002C. The obtained simulation results show clearly the

effectiveness of the proposed fault detection approach, where the validation is performed on real data obtained from onsite. On the other side, this proposed approach allows to integrate partial knowledge obtained from the expertise and data knowledge. This expert knowledge can be expressed in the form of fuzzy rules and constraints on the input fuzzification, while the training phase adjusts the undefined parameters (parameters consistent) using the obtained data. It is important to clarify that the ANFIS learning capacity allows to overcome the loss of accuracy issues from the expertise. So it is a beneficent system where the two sources of knowledge (rules and data) are used together to overcome the gaps of each other. This adaptive inference system is highly efficient and can be widely used in practical diagnostic application of a gas turbine system.

REFERENCES

1. Amozegar M, Khorasani K. An ensemble of dynamic neural network identifiers for fault detection and isolation of gas turbine engines. *Neural Networks* 2016; 76: 106-121.

2. Pourbabae B, Meskin N, Khorasani K. Robust sensor fault detection and isolation of gas turbine engines subjected to time-varying parameter uncertainties. *Mechanical Systems and Signal Processing* 2016; 76-77: 136-156.
3. Barsali S, De Marco A, Giglioli R, Ludovici G, Possenti A. Dynamic modelling of biomass power plant using micro gas turbine. *Renewable Energy* 2015; 80: 806-818.
4. Bartolini CM, Caresana F, Comodi G, Pelagalli L, Renzi M, Vagni S. Application of artificial neural networks to micro gas turbines. *Energy Conversion and Management* 2011; 52(1): 781-788.
5. Djaidir B, Hafifa A, Kouzou A. Vibration detection in gas turbine rotor using artificial neural network combined with continuous wavelet. Book Chapter in *Advances in acoustics and vibration, Volume 5 of the series Applied Condition Monitoring* 2016:101-113.
6. Dandil B, Gokbulut M, Ata F. A PI Type Fuzzy-neural Network Controller for Induction Motor Drives. *Journal of Applied Sciences* 2005; 5(7): 1286-1291.
7. Chow EY, Willsky AS. Analytical redundancy and the design of robust failure detection systems, *IEEE Transaction on Automatic Control* 1984; 29: 603-614.
8. Fontes CH, Pereira O. Pattern recognition in multivariate time series – A case study applied to fault detection in a gas turbine. *Engineering Applications of Artificial Intelligence* 2016; 49: 10-18.
9. Mohammadi E, Montazeri-Gh M. Active fault tolerant control with self-enrichment capability for gas turbine engines. *Aerospace Science and Technology* 2016; 56: 70-89.
10. Ablay G. A modeling and control approach to advanced nuclear power plants with gas turbines. *Energy Conversion and Management* 2013; 76:899-909.
11. Asgari H, Chen XQ, Morini M, Pinelli M, Sainudiin R, Spina PR, Venturini M. NARX models for simulation of the start-up operation of a single-shaft gas turbine. *Applied Thermal Engineering* 2016; 93: 368-376.
12. Pendar H, Salehi MM, Kharrat R, Zarezadeh S. Numerical and ANFIS modeling of the effect of fracture parameters on the performance of VAPEX process. *Journal of Petroleum Science and Engineering*, 2016, vol. 143, pp. 128-140.
13. Shayeghi H, Sobhani B, Shahryari E, Akbarimajd A. Optimal neuro-fuzzy based islanding detection method for Distributed Generation. *Neurocomputing* 2016; 77: 478-488.
14. Hanachi H, Liu J, Banerjee A, Chen Y. Sequential state estimation of nonlinear/non-Gaussian systems with stochastic input for turbine degradation estimation. *Mechanical Systems and Signal Processing* 2016; 72-73: 32-45.
15. Duan Y, Sun L, Wang G, Wu F. Nonlinear modeling of regenerative cycle micro gas turbine. *Energy* 2015; 91: 168-175.
16. Jang JSR. ANFIS: adaptive-network-based fuzzy inference system. *IEEE Transactions on Systems, Man, and Cybernetics* 1993; 23(3): 665-685.
17. Jang JSR, Sun CT, Mizutani E. Neuro-fuzzy and soft computing: a computational approach to learning and machine intelligence. Book edited by Prentice Hall, 1997.
18. Jang JSR, Sun CT. Functional equivalence between radial basis function networks and fuzzy inference systems. *IEEE Transactions on Neural Networks* 1993; 4(1): 156-159.
19. Jang JSR. Neuro-fuzzy modeling for dynamic system identification. *Fuzzy Systems Symposium* 1996: 320-325
20. Jang JSR. Input selection for ANFIS learning. *Proceedings of the fifth IEEE international conference on fuzzy systems* 1996; 2: 1493-1499
21. Jang JSR, Sun CT. Neuro-fuzzy modeling and control. *Proceedings of the IEEE* 1995; 83(3): 378-406.
22. Salahshoor K, Khoshro MS, Kordestani M. Fault detection and diagnosis of an industrial steam turbine using a distributed configuration of adaptive neuro-fuzzy inference systems. *Simulation Modelling Practice and Theory* 2011; 19(5):1280-1293.
23. Salahshoor K, Khoshro MS, Kordestani M. Fault detection and diagnosis of an industrial steam turbine using fusion of SVM (support vector machine) and ANFIS (adaptive neuro-fuzzy inference system) classifiers. *Energy* 2010; 35(12): 5472-5482.
24. Kulikov GG, Thompson HA. Dynamic Modelling of Gas Turbines: Identification, Simulation, Condition Monitoring and Optimal Control, Book chapter, Series: *Advances in Industrial Control*, (Eds.) Springer 2004.
25. Kulikov GG. Dynamic characteristic of gas turbine engine. In: Shevyakov AA, Martyanova TS, editors. *Optimisation of multivariable control systems of aero gas turbine engines*. Moscow, Book edited by Mashinostroenie 1989: 35-41. Russian.
26. Kulikov GG. Methods for creation of linear mathematical models of gas turbine engines, In: Shevyakov AA, Martyanova TS, editors. *Optimisation of Multivariable Control Systems of Aero Gas Turbine Engines*. Moscow, Book edited by Mashinostroenie 1989: 41-81. Russian.
27. Wie LY. A hybrid ANFIS model based on empirical mode decomposition for stock time series forecasting. *Applied Soft Computing* 2016, vol. 42, pp. 368-376.
28. Rahmoune MB, Hafifa A, Guemana M. Fault diagnosis in gas turbine based on neural networks: Vibrations Speed Application. Book Chapter in *Advances in Acoustics and Vibration, Volume 5 of the series Applied Condition Monitoring* 2016: 1-11.
29. Mohamed IM, Fawzan S. LFC based adaptive PID controller using ANN and ANFIS techniques. *Journal of Electrical Systems and Information Technology* 2014; 1(3): 212-222.
30. Nikpey H, Assadi M, Breuhaus P. Development of an optimized artificial neural network model for combined heat and power micro gas turbines. *Applied Energy* 2013; 108: 137-148.
31. Nikpey H, Assadi M, Breuhaus P, Mørkved PT. Experimental evaluation and ANN modeling of a recuperative micro gas turbine burning mixtures of natural gas and biogas. *Applied Energy* 2014; 117: 30-41.
32. Turney P, Halasz M. Contextual normalization applied to aircraft gas turbine engine diagnosis. *Applied Intelligence* 1993; 3(2): 109-129.
33. Ringwood JV, Simani S. Overview of modelling and control strategies for wind turbines and wave energy devices: Comparisons and contrasts. *Annual Reviews in Control* 2015; 40: 27-49.

34. Sadough Vanini ZN, Khorasani K, Meskin N. Fault detection and isolation of a dual spool gas turbine engine using dynamic neural networks and multiple model approach. *Information Sciences* 2014; 259: 234-251.
35. Saeed RA, Galybin AN, Popov V. 3D fluid–structure modelling and vibration analysis for fault diagnosis of Francis turbine using multiple ANN and multiple ANFIS. *Mechanical Systems and Signal Processing* 2013; 34(1–2): 259-276.
36. Samet EA, Keith EH. Nonlinear dynamic modeling and simulation of a passively cooled small modular reactor. *Progress in Nuclear Energy* 2016; 91: 116-131.
37. Sasan B, Saedeheh SS. Forecasting energy consumption using ensemble ARIMA–ANFIS hybrid algorithm. *International Journal of Electrical Power & Energy Systems* 2016; 82: 92-104.
38. Seixas M, Melicio R, Mendes VMF. Simulation by discrete mass modeling of offshore wind turbine system with DC link. *International Journal of Marine Energy* 2016; 14: 80-100.
39. Tayarani-Bathaie SS, Khorasani K. Fault detection and isolation of gas turbine engines using a bank of neural networks. *Journal of Process Control* 2015; 36: 22-41.
40. Ghabraei S, Moradi H, Vossoughi G. Multivariable robust adaptive sliding mode control of an industrial boiler–turbine in the presence of modeling imprecisions and external disturbances: A comparison with type-I servo controller. *ISA Transactions* 2015; 58: 398-408.
41. Yang L, Entchev E. Performance prediction of a hybrid microgeneration system using Adaptive Neuro-Fuzzy Inference System (ANFIS) technique. *Applied Energy* 2014; 134: 197-203.
42. Oğuz Y, Üstün SV, Yabanova I, Yumurtaci M, Güney İ. Adaptive neuro-fuzzy inference system to improve the power quality of a split shaft microturbine power generation system. *Journal of Power Sources* 2012: 196-209.

Received 2016-10-15

Accepted 2016-11-12

Available online 2016-11-21



Mr Naji HADROUG

was born on 18/12/1989 in Hassi bahbah, Djelfa, Algeria. He is a member of the Applied Automation and industrial diagnostics laboratory, university Djelfa. he is actual working toward his PhD thesis. His main researches are on the Neuro-Fuzzy fault tolerant control applied on a gas turbine. His thesis focuses on the development of new methods and tools in control fault tolerant for industrial systems. He is author and co-author of several publications and conference papers.



Dr Ahmed HAFIFA is the founder of the Applied Automation and Industrial Diagnostic Laboratory at the University of Djelfa. He is the supervisor of many PhD Students and he is the coordinator of several industrial research

projects within the applied automatic diagnostics and reliability of industrial systems. His research area of interests includes the modelling and control in industrial systems, the diagnosis and new reliability engineering, fault detection and isolation in industrial process, intelligent system based on fuzzy logic and neural networks.

He is active as an expert in several national and international committees and collaboration research activities. He has participated in several international research projects and has led several national research projects.



Dr Abdellah KOUZOU

(IEEE Senior member & IACSIT Senior member, IFAC, IAENG & IISRO member, IEEE-HKN Alumni Member) was born in Djelfa, Algeria in 1964. He received the State Engineer degree, the Magister, the PhD, and the Habilitation from

University of Tiaret, Algeria, University of Boumerdes, Polytechnics Superior National School respectively. He has been a researcher with Technische Universität of Muenchen in Germany from 2010, 2011 and 2012. He is a collaborator researcher at Texas A&M University at Qatar. He is an associate professor with the faculty of Sciences and Technology at Djelfa university in Algeria, where he was the president of the Scientific council of the faculty since June 2014. Dr. Kouzou has participated in several research projects and has led several research projects. Currently he is the Dean of the faculty of Sciences and Technology at Djelfa university in Algeria.



Dr. Ahmed CHAIBET

Hi received the M.Sc. degree in virtual reality and control of the complex systems from Versailles Saint-Quentin-en-Yvelines

University, Versailles,

France, in 2002 and the Ph.D. degree in automatics from the University of Evry Val-d'Essonne, Evry, France, in 2006. He is currently an Associate Professor at ESTACA Engineering School, Levallois-Perret, France. His main research interests include design, modeling, robust, and fault-tolerant control with its applications to power electronics and electrical drives.