

INRAE

➤ Stochastic closures for real-time fluid applications

Talla M., Caville C., Moneyron A., Lepape G.,  
Jacquet P., Wallian L., **Resseguier V.**, Stabile G.



## > Context

# Observer for wind turbine application

*Application:* Real-time estimation and prediction of 3D turbulent flow using strongly-limited computational resources & few sensors

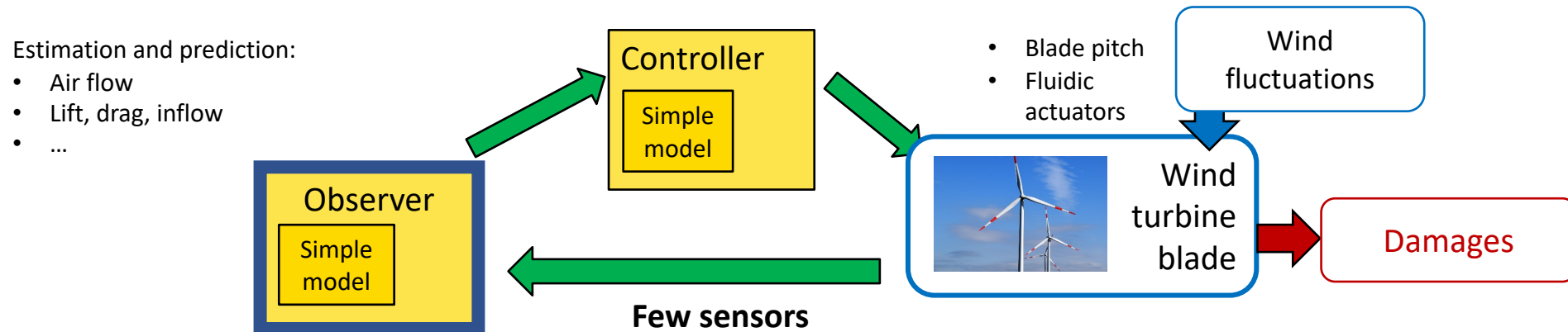

Which simple model? How to combine model & measurements?

**Scientific problem :**

**Simulation & data assimilation under severe dimensional reduction**

typically,  $10^7 \rightarrow O(10)$  degrees of freedom

## ➤ Content

### I. State of the art

- Intrusive reduced order model (ROM)
- Large Eddy Simulation (LES) & hyperreduction
- Data assimilation

### II. Stochastic closure

- Location uncertainty models (LUM)
- Stochastic ROM for turbulent flows

### III. Numerical results

- Test cases
- Deterministic hyperreduction could be improved
- But data assimilation does the job!



## ➤ I. State of the art

- Intrusive reduced order model (ROM)
- LES and hyperreduction
- Data assimilation



## ➤ Intrusive reduced order model (ROM)

Combine physical models and learning approaches

- Principal Component Analysis (PCA) on a *dataset* to reduce the dimensionality:

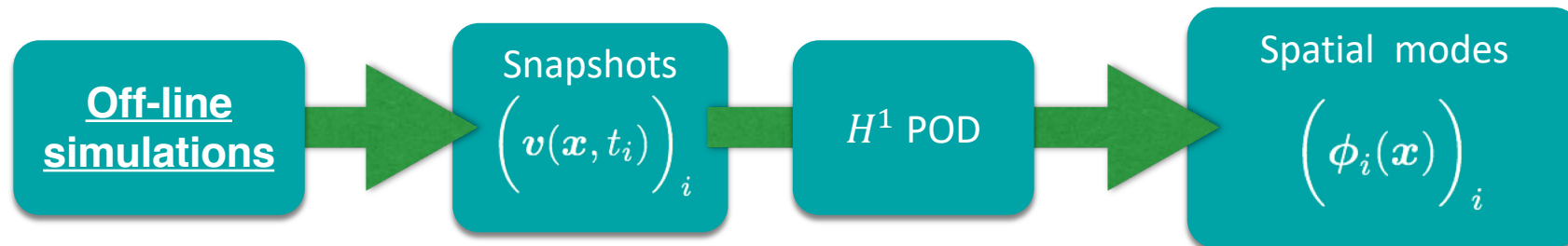

- Approximation:

$$v(x, t) \approx \sum_{i=0}^n \underbrace{b_i(t)}_{\text{Resolved modes}} \phi_i(x)$$

Don't work in extrapolation for advection-dominated problem

- Projection of the "physics" onto the spatial modes (POD-Galerkin)

$$\int_{\Omega} dx \phi_i(x) \cdot (\text{Physical equation (e.g. Navier-Stokes)})$$

→ ROM for very fast simulation of temporal modes

## ➤ Intrusive reduced order model (ROM)

Combine physical models and learning approaches

- Principal Component Analysis (PCA) on a *dataset* to reduce the dimensionality:

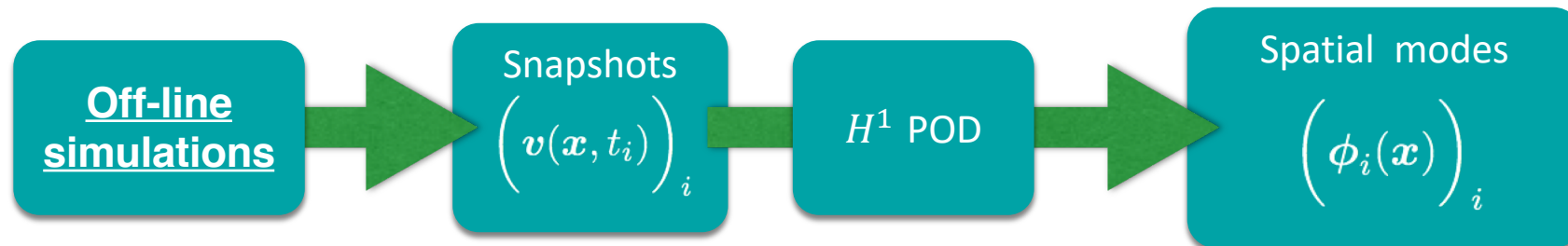

- Approximation:

$$v(x, t) \approx \sum_{i=0}^n \text{Resolved modes } b_i(t) \phi_i(x)$$

Don't work in extrapolation for advection-dominated problem

- Projection of the "physics" onto the spatial modes (POD-Galerkin)

$$\int_{\Omega} dx \phi_i(x) \cdot \text{(Randomized Navier-Stokes)}$$

→ ROM for very fast simulation of temporal modes p. 6

## ➤ Large Eddy Simulation (LES) & hyperreduction

How to deal with turbulent unsteady flows ?

- DNS cannot generate large amount of 3D turbulent flow data
- Possible with turbulence models > Smagorinsky LES

$$\underbrace{\partial_t v + C(v, v)}_{\text{Advection}} = \underbrace{-\nabla p}_{\text{Pressure}} + \underbrace{D(v)}_{\text{Viscous term}} + \underbrace{F(v)}_{\text{Smagorinsky term}}$$

with  $F$  a **non-polynomial** differential operator

- **Issue** for Galerkin projection / ROM
- **Solution** : Hyperreduction > Discrete Empirical Interpolation Method (DEIM)

$$F(x, t) \approx \hat{F}(x, t) = \sum_{i=0}^m r_i(t) \psi_i(x) = \bar{F}(x) + \sum_{k=1}^m \left( \sum_{i=1}^m G_{ik} \psi_i(x) \right) F(x_k, t)$$

## ➤ Large Eddy Simulation (LES) & hyperreduction

How to deal with turbulent unsteady flows ?

$$F(x, t) \approx \hat{F}(x, t) = \sum_{i=0}^m r_i(t) \psi_i(x) = \bar{F}(x) + \sum_{k=1}^m \left( \sum_{i=1}^m G_{ik} \psi_i(x) \right) F(x_k, t)$$

- Error decomposition for DEIM

$$\text{Error} = F - \hat{F} = \underbrace{(\Pi_\psi F - \hat{F})}_{\in V_\psi} + \underbrace{(I - \Pi_\psi)F}_{= F' \in V_\psi^\perp}$$

Projection error

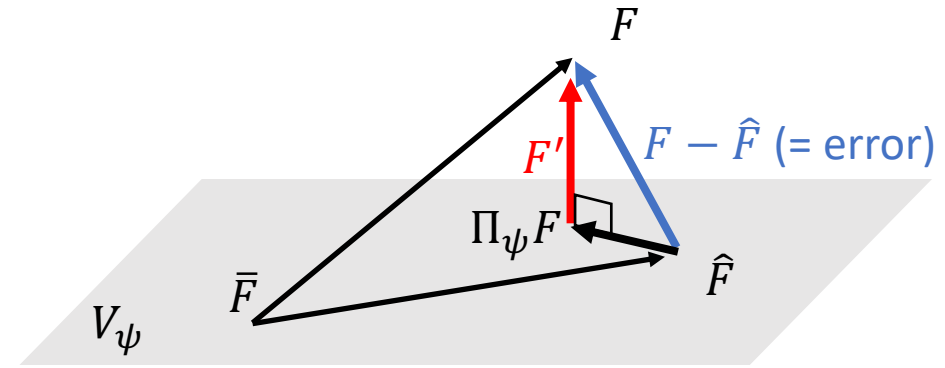

$$\frac{\mathcal{E}_*(F)}{\|F\|} \leq \frac{\|F - \hat{F}\|}{\|F\|} \leq C \cdot \frac{\mathcal{E}_*(F)}{\|F\|}$$

$$\bar{f} = \frac{1}{T} \int_0^T f$$

$$\Pi_\psi F = \bar{F} + \sum_{j=1}^m \langle F - \bar{F}, \psi_j \rangle \psi_j$$

$$V_\psi = \text{Span}(\psi_i)$$

$$\mathcal{E}_*(F) = \|(I - \Pi_\psi)F\|$$

- **Data assimilation**  
= Coupling simulations and measurements  $y$

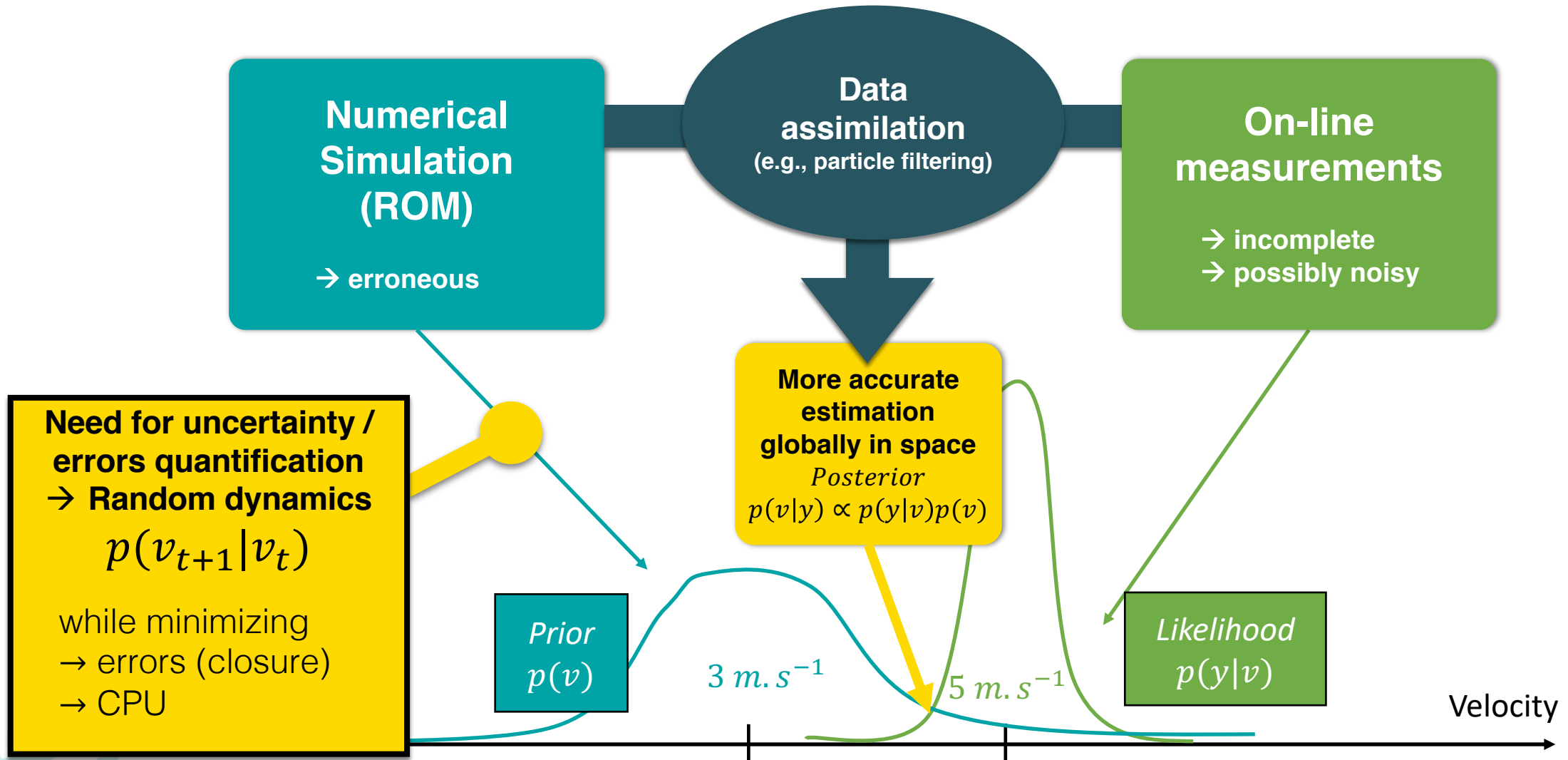

## ➤ II. Stochastic closure

- Location uncertainty models (LUM)
- Stochastic ROM for turbulent flows

## ➤ Location uncertainty models (LUM)

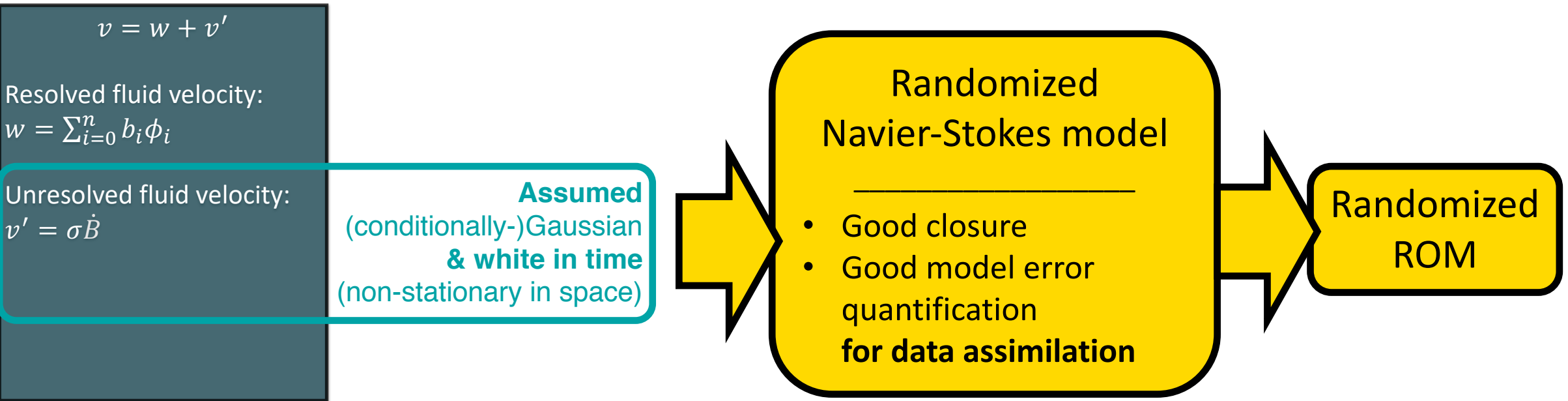

References :

Mikulevicius & Rozovskii, 2004  
 Flandoli, 2011

### LUM

Memin, 2014  
 Resseguier et al. 2017 a, b, c, d  
 Cai et al. 2017  
 Chapron et al. 2018  
 Yang & Memin 2019  
 ...

### SALT

Holm, 2015  
 Holm and Tyranowski, 2016  
 Arnaudon et al. 2017

Crisan et al., 2017  
 Gay-Balmaz & Holm 2017  
 Cotter and al. 2018 a, b  
 Cotter and al. 2019  
 ...

Cotter and al. 2017, Resseguier et al. 2020, 2021, Zhen et al. (2023), ...

➤ Location uncertainty models (LUM)  
Randomized DNS

From Ito-Wentzell  
formula (Kunita 1990)  
with Ito notations

$v = w + v'$

Resolved fields:  
 $w$

Unresolved fields:  
 $v' = \sigma \dot{B}$   
(Gaussian, white wrt  $t$ )

Momentum conservation

$$\frac{d}{dt} \left( w(t, X_t) \right) = F \text{ (Forces)}$$

Positions of fluid parcels  $X_t$  :

$$\frac{d}{dt} X_t = w(t, X_t) + \underbrace{\sigma(t, X_t) \frac{dB_t}{dt}}_{\text{Gaussian process white in time}}$$

Gaussian  
process  
white in time







# ➤ Location uncertainty models (LUM) Randomized LES

$v = w + v'$   
 $F = \hat{F} + F'$

Resolved fields:  
 $w$   
 $\hat{F}$

Unresolved fields:  
 $v' = \sigma \dot{B}$   
 $F' = \sigma_F \dot{B}$   
 (Gaussian, white wrt  $t$ )

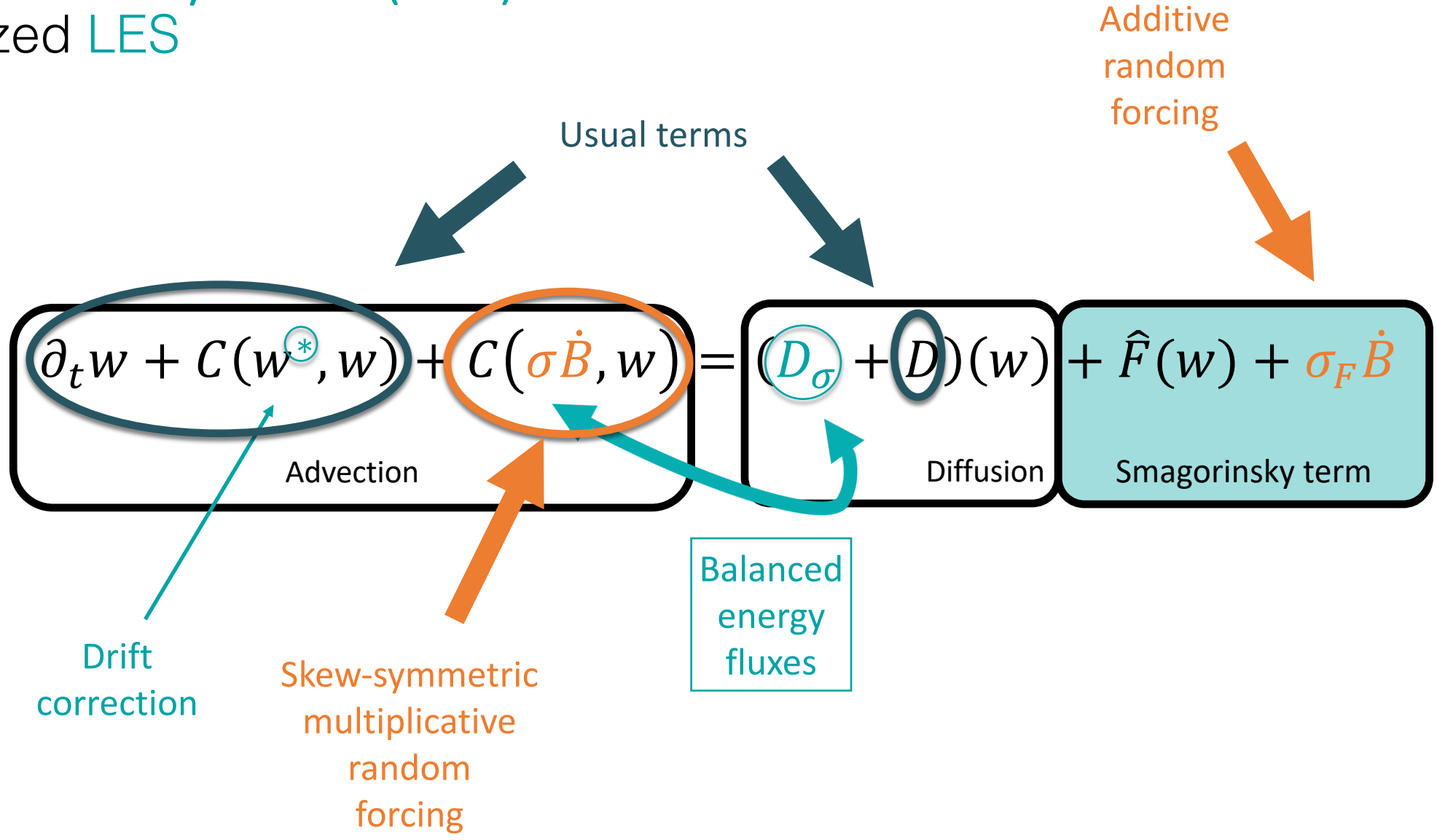

# Stochastic ROM for turbulent flows (Red LUM)

POD-Galerkin gives SDEs for resolved modes

Full order :  $M \sim 10^7$   
 Reduced order :  $n, m \sim 10$

$v = w + v'$   
 $F = \hat{F} + F'$

Resolved fields :

$w(x, t) = \sum_{i=0}^n b_i(t) \phi_i(x)$   
 $\hat{F}(x, t) = \sum_{i=0}^m r_i(t) \psi_i(x)$

Unresolved fields :

$v' = \sigma \dot{B}$   
 $F' = \sigma_F \dot{B}$   
 (Gaussian, white wrt  $t$ )

$$\int_{\Omega} \phi_i(x) \cdot (-\partial_t w - C(w^*, w) - C(\sigma \dot{B}, w) + (D_{\sigma} + D)(w) + \hat{F}(w) + \sigma_F \dot{B}) dx$$

$\Pi_{\phi}$

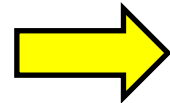

$$M \frac{d}{dt} b(t) = H(\tilde{b}(t)) + K(\sigma \dot{B}, \sigma_F \dot{B}) \tilde{b}(t)$$

Projected additive & multiplicative noises

$$\tilde{b} = \begin{pmatrix} 1 \\ b \end{pmatrix} : n + 1$$

$$\Pi_{\phi} g = \sum_{j=1}^m \langle g, \phi_j \rangle \phi_j$$

2<sup>nd</sup> order polynomial

$$K_{jq}[\xi, \xi^F] = \int_{\Omega} \phi_j \cdot (-C(\xi, \phi_q) + \delta_{0q} \xi^F)$$

# Stochastic ROM for turbulent flows (Red LUM)

POD-Galerkin gives SDEs for resolved modes

Full order :  $M \sim 10^7$   
 Reduced order :  $n, m \sim 10$

Resolved fields :

$$v = w + v'$$

$$F = \hat{F} + F'$$

$$w(x, t) = \sum_{i=0}^n b_i(t) \phi_i(x)$$

$$\hat{F}(x, t) = \sum_{i=0}^m r_i(t) \psi_i(x)$$

Unresolved fields :

$$v' = \sigma \dot{B}$$

$$F' = \sigma_F \dot{B}$$

(Gaussian, white wrt  $t$ )

$$\int_{\Omega} \phi_i(x) \cdot (-\partial_t w - C(w^*, w) - C(\sigma \dot{B}, w) + (D_{\sigma} + D)(w) + \hat{F}(w) + \sigma_F \dot{B}) dx$$

$$M \frac{d}{dt} b(t) = H(\tilde{b}(t)) + K(\sigma \dot{B}, \sigma_F \dot{B}) \tilde{b}(t)$$

$n \times (n+1)$        $(n+1) \times 1$   
 $2M \times 1$

Projected additive & multiplicative noises

**Covariance to estimate**

$$\mathbb{E} \left( K_{jq}(\dots) K_{ip}(\dots) \right) / dt \approx \Delta t K_{jq} \left[ \frac{b_p}{b_p^2} \frac{\Delta b_i}{\Delta t} (v', F') \right]$$

2<sup>nd</sup> order polynomial

Coefficients given by :

- Randomized Navier-Stokes
- $(\phi_j)_j, (\psi_j)_j$
- $a(x) \approx \Delta t v' (v')^T$

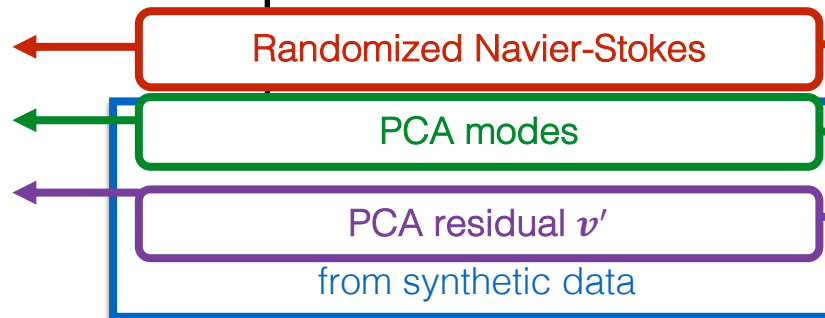

## New estimator

- Consistency proven ( $\Delta t \rightarrow 0$ )
- Numerically efficient
- Physically-based
- Robustness in extrapolation

$$K_{jq}[\xi, \xi^F] = \int_{\Omega} \phi_j \cdot (-C(\xi, \phi_q) + \delta_{0q} \xi^F)$$

$$\bar{f} = \frac{1}{T} \int_0^T f$$

$$\tilde{b} = \begin{pmatrix} 1 \\ b \end{pmatrix}$$

$$a(x, x) = \mathbb{E}\{(\sigma dB_t)(\sigma dB_t)^T\} / dt$$

➤ **Summary**  
Stochastic ROM + Data assimilation

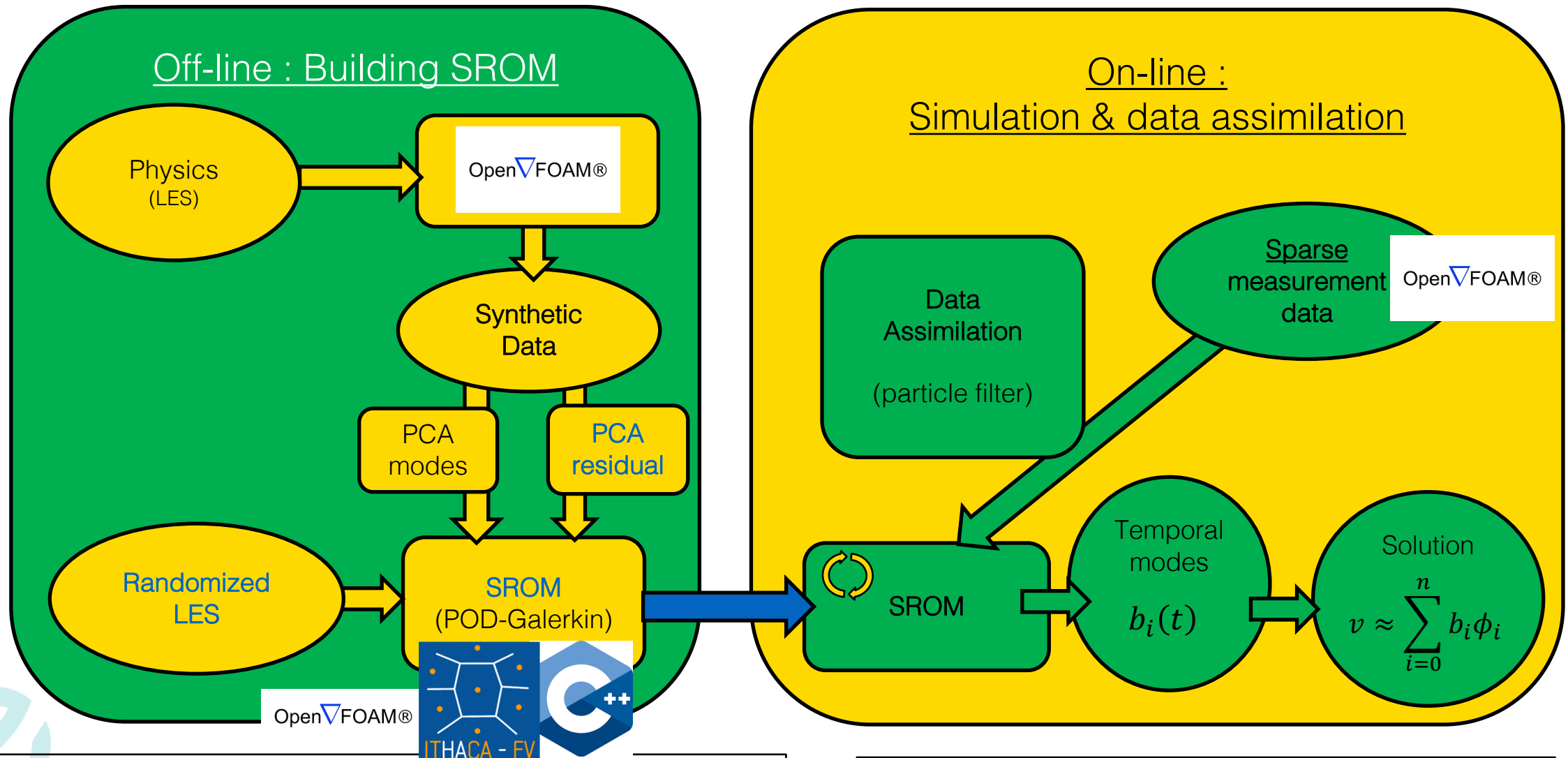

## ➤ III. Numerical results

- Test cases
- Deterministic hyperreduction could be improved
- But data assimilation does the job!

# ➤ Test cases

## Wake flow past a cylinder

OpenFOAM®

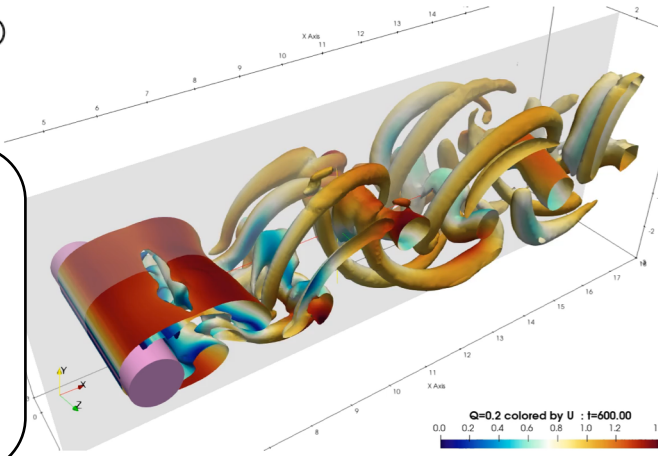

**DNS**  
“true” simulation  
(Re 300,  $10^7$  degrees of freedom)

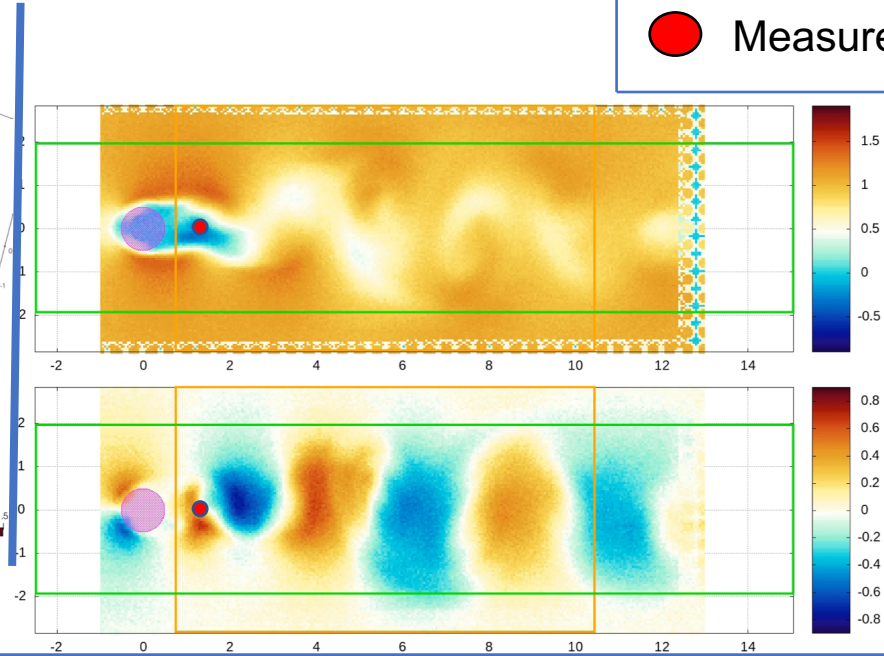

● Measurement point (blurred & noisy velocity)

**LES**  
“true” simulation  
(Re 3900,  $10^7$  degrees of freedom)

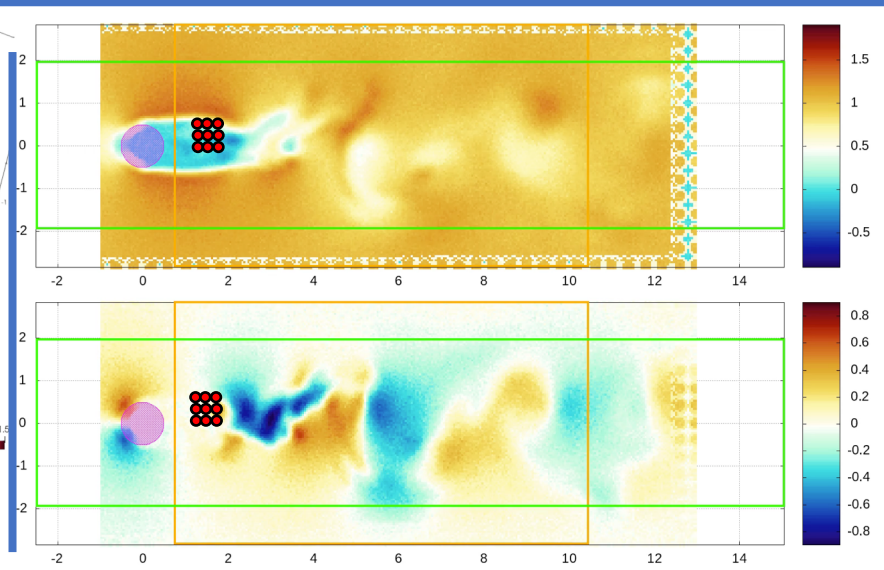
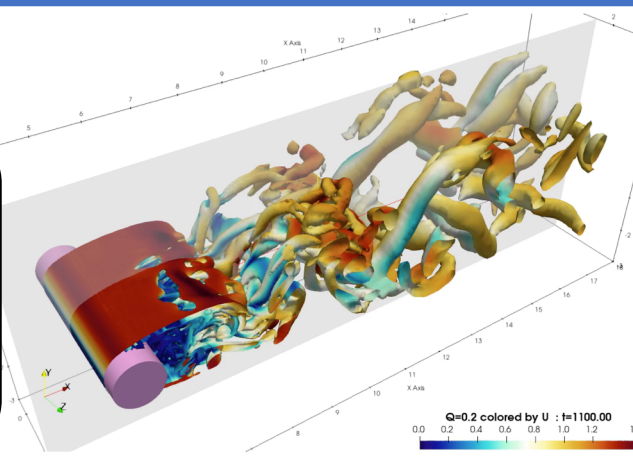

**Synthetic PIV**  
blurred & noisy  
2D velocity



# ➤ Deterministic hyperreduction of $F$

Relative error for the Smagorinsky term  $F$   
(Re=3900)

$$F - \hat{F} = \underbrace{(\Pi_\psi F - \hat{F})}_{\in V_\psi} + \underbrace{F'}_{\in V_\psi^\perp}$$

$$\frac{\|F'\|}{\|F\|} \leq \frac{\|F - \hat{F}\|}{\|F\|} \leq C \cdot \frac{\|F'\|}{\|F\|}$$

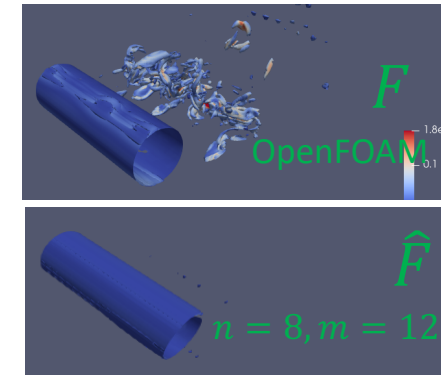
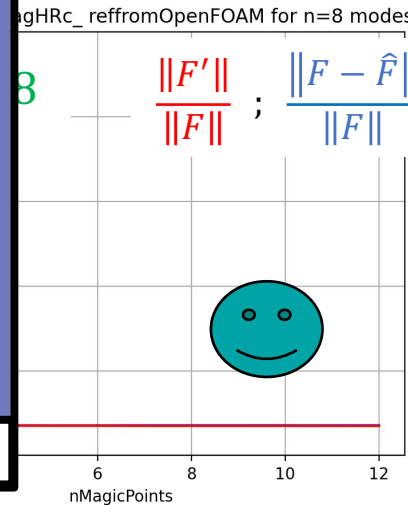
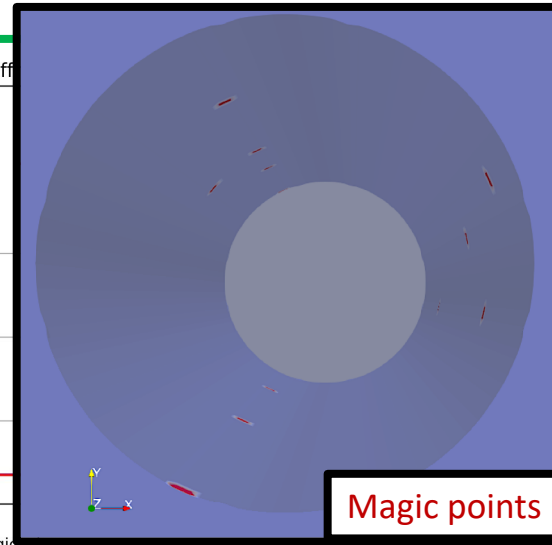
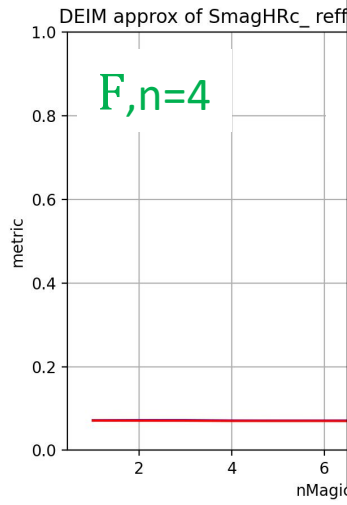
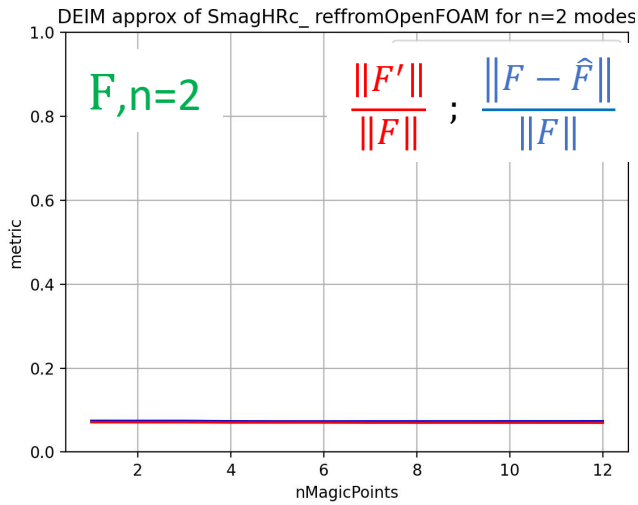

- Small  $\|\cdot\|_{L^2}$  error
- BUT what about its Galerkin projection  $\Pi_\phi F$

$$\frac{\|\Pi_\phi F - \Pi_\phi \hat{F}\|}{\|\Pi_\phi F\|} = \frac{\|\Pi_\phi (F - \hat{F})\|}{\|\Pi_\phi F\|} \leq \frac{\|F - \hat{F}\|}{\|\Pi_\phi F\|} \sim \underbrace{\left(\frac{\|F\|}{\|\Pi_\phi F\|}\right)}_{\sim 100} \underbrace{\left(\frac{\|F - \hat{F}\|}{\|F\|}\right)}_{\ll 1}$$



# ➤ Deterministic hyperreduction of $F$ could be improved

$$F - \hat{F} = \underbrace{(\Pi_\psi F - \hat{F})}_{\in V_\psi} + \underbrace{F'}_{\in V_\psi^\perp}$$

Relative error for the Smagorinsky term  $F$   
 & its Galerkin projection  $\Pi_\phi F = \sum_{j=1}^m \langle F, \phi_j \rangle \phi_j$   
 (Re=3900)

$$\Pi_\phi F - \Pi_\phi \hat{F} = \Pi_\phi (\Pi_\psi F - \hat{F}) + \Pi_\phi F'$$

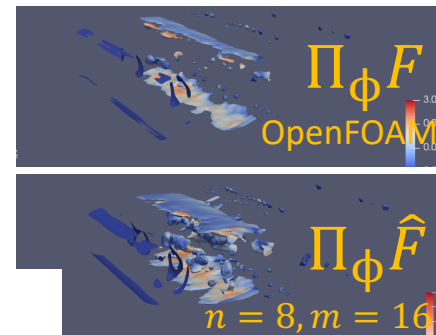
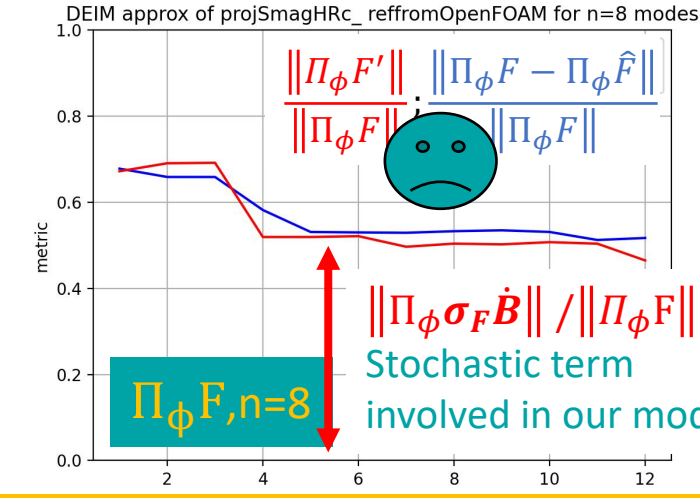
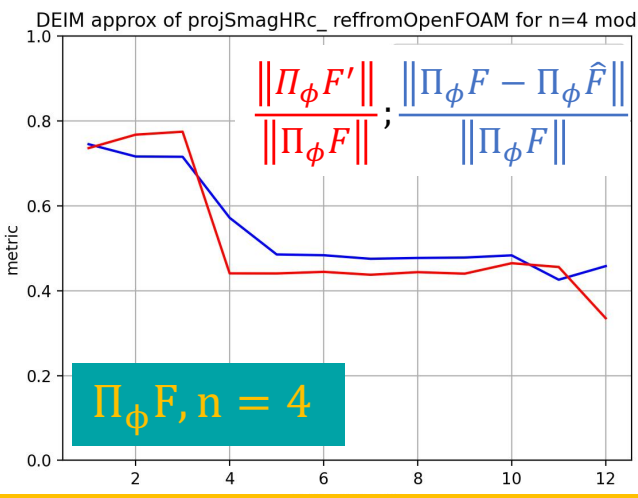
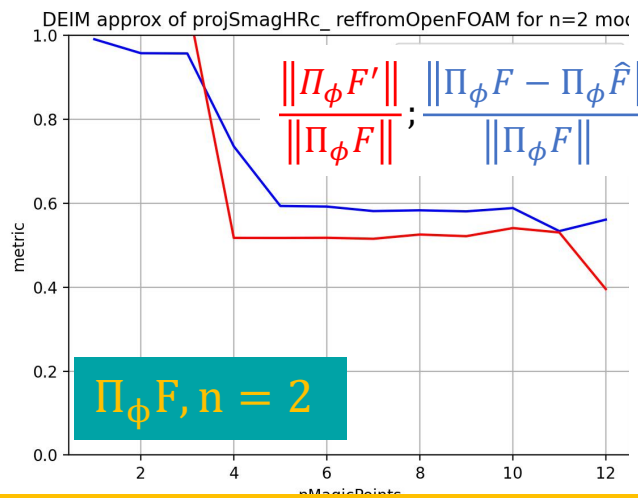
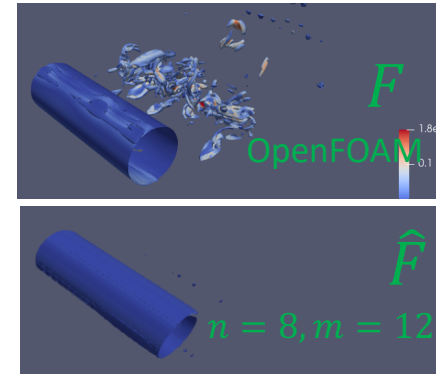
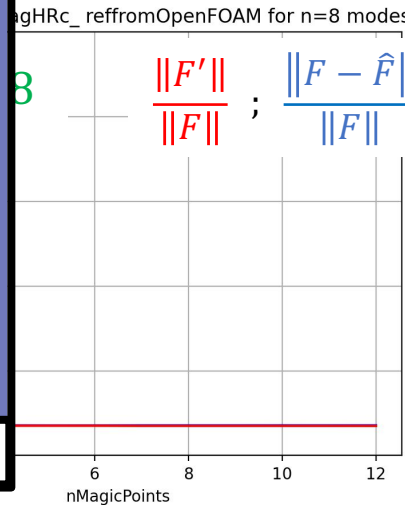
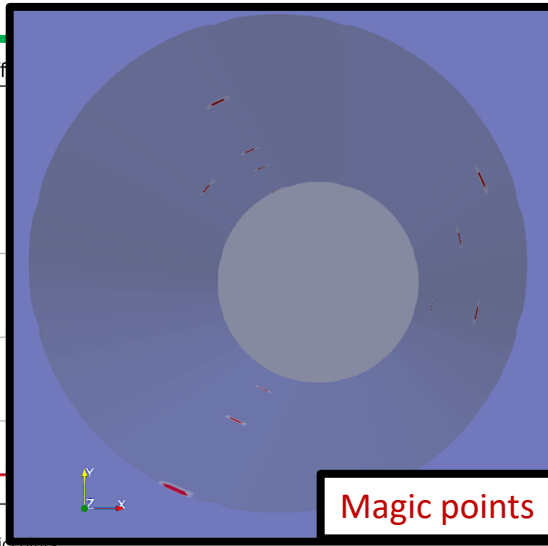
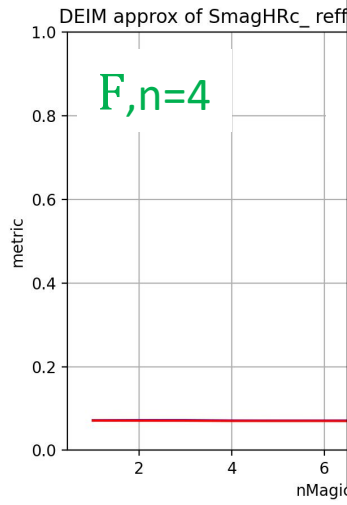
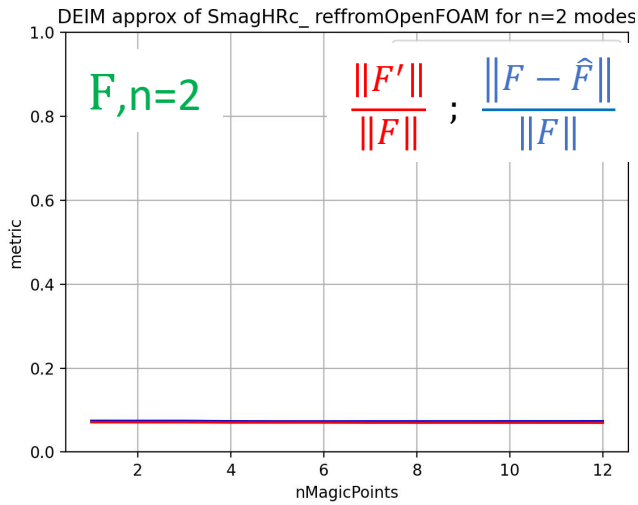

# ➤ But data assimilation does the job!

DNS, Re 300,  $n = 4$  modes

From  $10^7$  to 4 degrees of freedom  
● Single measurement point (blurred & noisy velocity)

**DNS**  
“true” simulation  
(Re 300,  $10^7$  degrees of freedom)

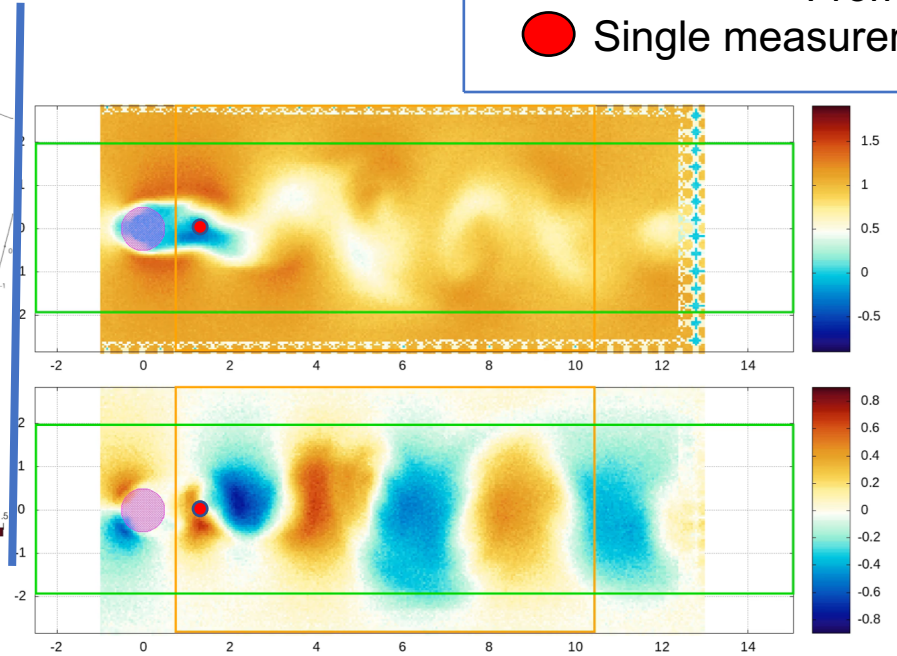
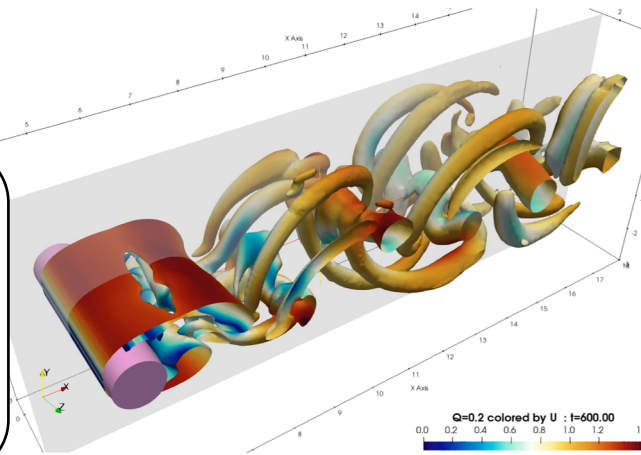

**Synthetic PIV**  
blurred & noisy  
2D velocity

**Reference :**  
POD-projection of the  
“true” simulation  
(DNS)  
( $H^1$  optimal from 4-  
degrees of freedom  
linear decomposition)

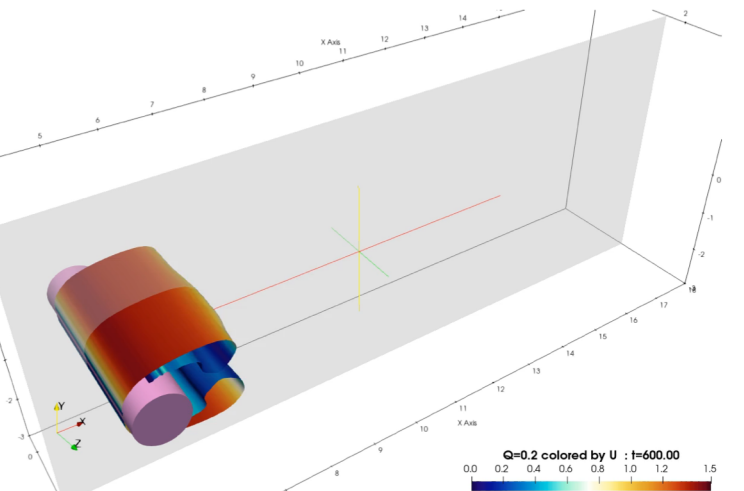
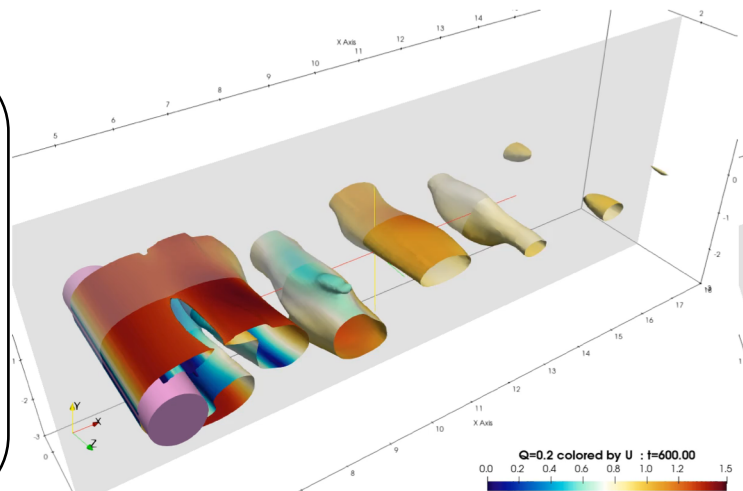

**Our method :**  
Data assimilation  
with  
POD-Galerkin of  
randomized DNS  
  
(4 degrees of freedom)

# ➤ But data assimilation does the job!

DNS, Re 300,  $n = 8$  modes

From  $10^7$  to 8 degrees of freedom  
● Single measurement point (blurred & noisy velocity)

**DNS**  
“true” simulation  
(Re 300,  $10^7$  degrees of freedom)

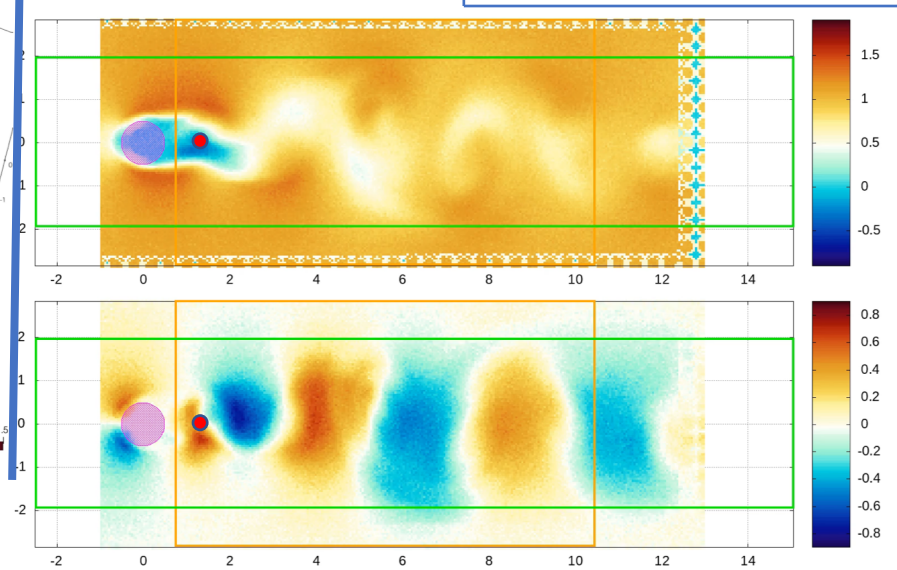
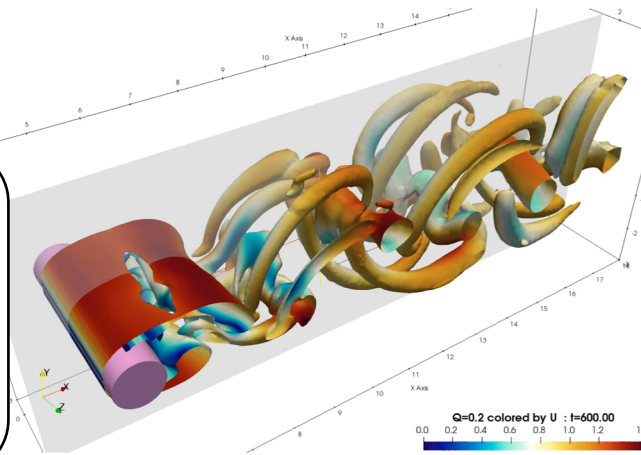

**Synthetic PIV**  
blurred & noisy  
2D velocity

**Reference :**  
POD-projection of the  
“true” simulation  
(DNS)  
( $H^1$  optimal from 8-  
degrees of freedom  
linear decomposition)

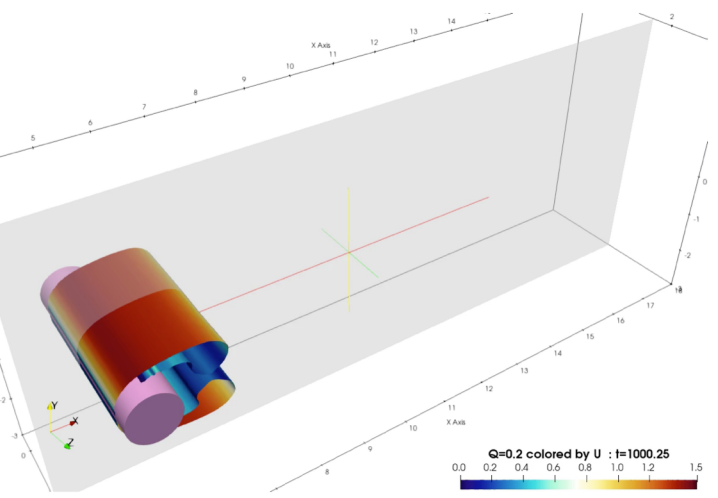
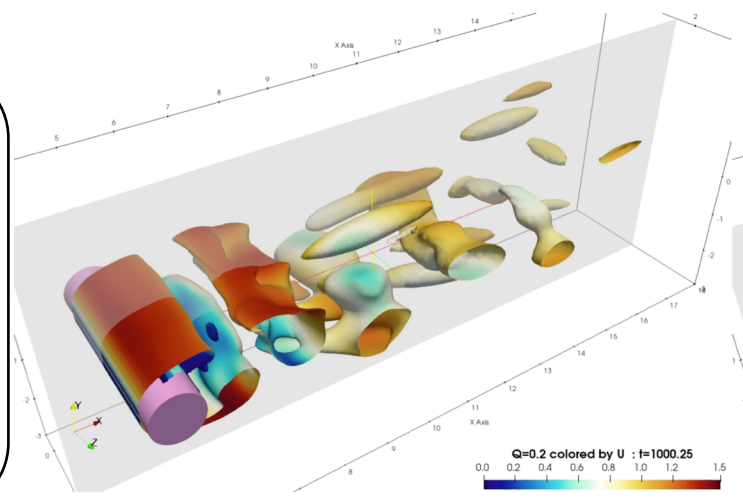

**Our method :**  
Data assimilation  
with  
POD-Galerkin of  
randomized DNS  
  
(8 degrees of freedom)

# ➤ But data assimilation does the job!

LES, Re 3900,  $n = 4$  modes

From  $10^7$  to 4 degrees of freedom  
9 measurement points (blurred & noisy velocity)

**LES**  
“true” simulation  
(Re 3900,  $10^7$  degrees of freedom)

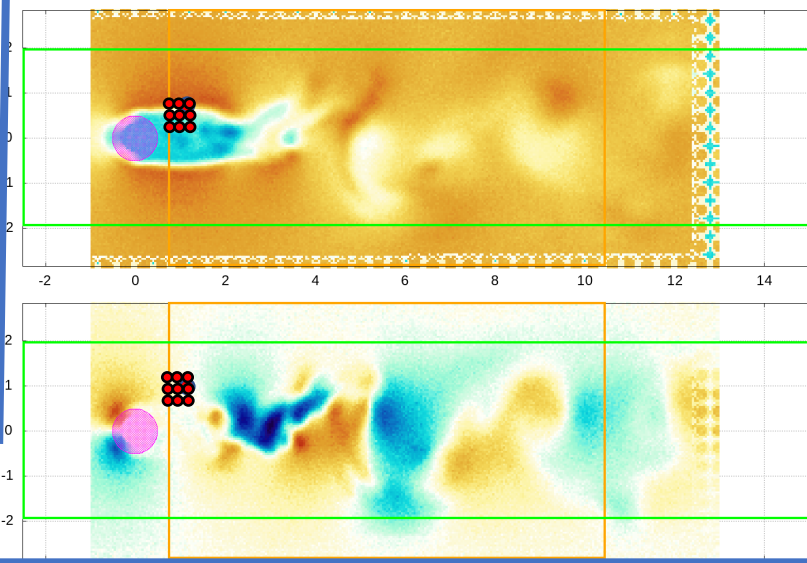
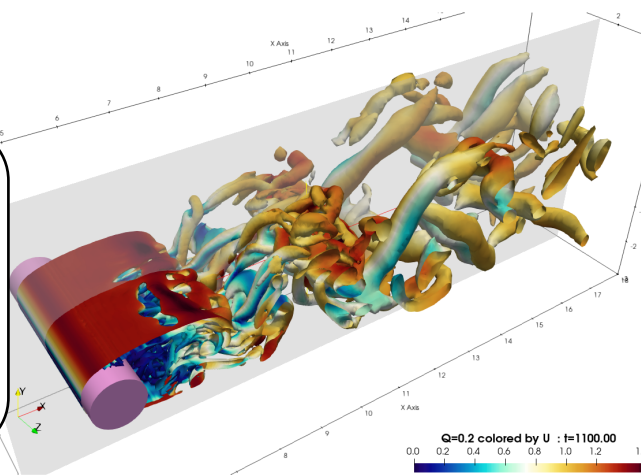

**Synthetic PIV**  
blurred & noisy  
2D velocity

**Reference :**  
POD-projection of the  
“true” simulation  
(LES)  
( $H^1$  optimal from 4-  
degrees of freedom  
linear decomposition)

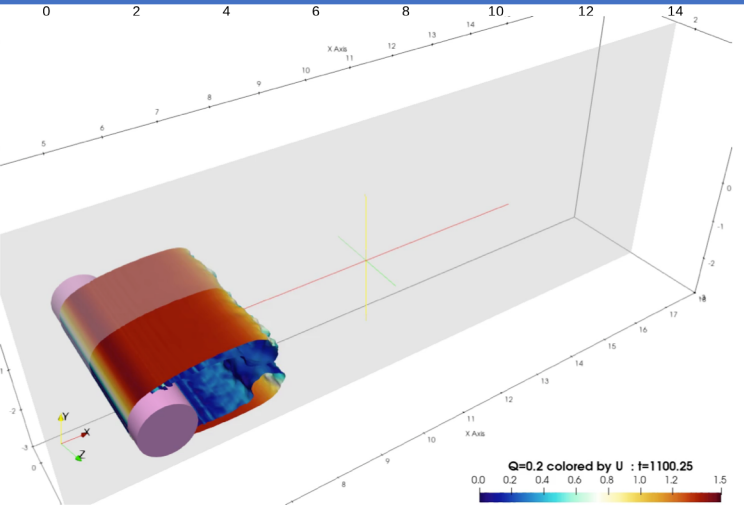
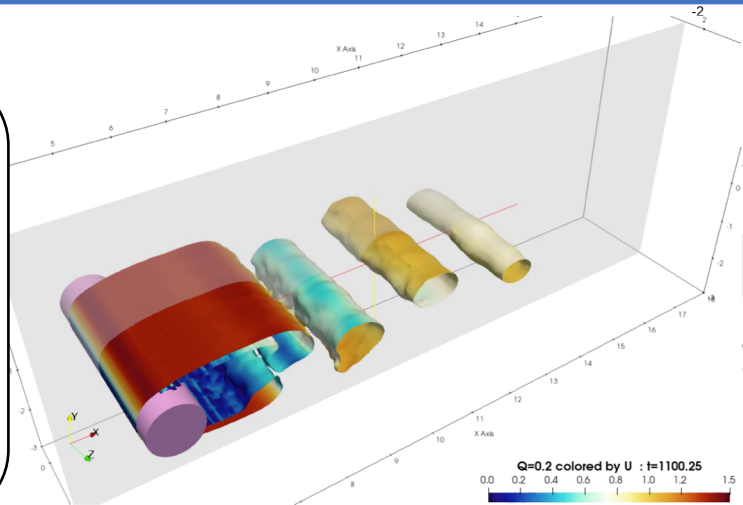

**Our method :**  
Data assimilation  
with  
POD-Galerkin of  
randomized LES  
(4 degrees of freedom)





➤ Conclusion

## > Conclusion



### ➤ Intrusive ROM : for very fast and robust CFD ( $10^7 \rightarrow 4$ degrees of freedom)

- Smagorinsky LES term handled by randomized DEIM
- Closure problems handled by LU-like models
- Efficient estimator for correlated additive & multiplicative noises
- Provide a “generative model” for prior / Model error quantification

### ➤ Data assimilation (Bayesian inverse problem) : to correct the fast simulation on-line

- **Unsteady 3D turbulent flow** estimation/prediction in the whole spatial domain (large-scale structures)
- From sparse & noisy measurements
- Robust far outside the training set

## > Next steps

- Better (deterministic & stochastic) hyperreduction
- Along-spanwise measurements
- Non-Markovian closure
- Real measurements