



HAL
open science

Spontaneous dark fermentation in a pre-seeded liquid-gas membrane bioreactor: Impact of wine and coffee biowaste microflora on continuous biohydrogen production

Marie Renaudie, Christine Dumas, Stéphane Vuilleumier, Barbara Ernst

► To cite this version:

Marie Renaudie, Christine Dumas, Stéphane Vuilleumier, Barbara Ernst. Spontaneous dark fermentation in a pre-seeded liquid-gas membrane bioreactor: Impact of wine and coffee biowaste microflora on continuous biohydrogen production. *Journal of Cleaner Production*, 2024, 437, pp.140759. 10.1016/j.jclepro.2024.140759 . hal-04544639

HAL Id: hal-04544639

<https://hal.science/hal-04544639>

Submitted on 12 Apr 2024

HAL is a multi-disciplinary open access archive for the deposit and dissemination of scientific research documents, whether they are published or not. The documents may come from teaching and research institutions in France or abroad, or from public or private research centers.

L'archive ouverte pluridisciplinaire **HAL**, est destinée au dépôt et à la diffusion de documents scientifiques de niveau recherche, publiés ou non, émanant des établissements d'enseignement et de recherche français ou étrangers, des laboratoires publics ou privés.



Spontaneous dark fermentation in a pre-seeded liquid-gas membrane bioreactor: Impact of wine and coffee biowaste microflora on continuous biohydrogen production

Marie Renaudie^{a,b}, Christine Dumas^a, Stéphane Vuilleumier^c, Barbara Ernst^{a,*}

^a Université de Strasbourg, CNRS, IPHC UMR7178, Laboratoire de Reconnaissance et Procédés de Séparation Moléculaire (RePSeM), ECPM, Strasbourg, France

^b French Environment and Energy Management Agency, Angers, France

^c Université de Strasbourg, CNRS, Génétique Moléculaire, Génomique, Microbiologie (GMGM), UMR 7156, Strasbourg, France

ARTICLE INFO

Handling Editor: Panos Seferlis

Keywords:

Hydrogen
Dark fermentation
Membrane bioreactor
Biomass
Vitivinicultural byproduct
Coffee silverskin

ABSTRACT

One of the challenges of continuous bioproduction of hydrogen by dark fermentation is to extract the gases produced and efficiently maintain the active bacterial consortium in the bioreactor. In this study, the process of hydrogen production was intensified by coupling dark fermentation to *in situ* gas extraction using a hollow fiber membrane module working as liquid-gas contactor. The value of this continuous liquid-gas membrane bioreactor (L/G MBR) was previously proved with a model substrate and the stabilization of a bacterial consortium deposited on the fibers. This work in an original way attempts to answer the question of the impact of feeding the bioreactor with unhygienized biomass having its own bacterial microflora capable of producing hydrogen. A new L/G MBR was inoculated with digestate from endogeneous dark fermentation of grape must deposits, mainly composed of hydrogen-producing bacteria. It was subsequently operated as a continuous liquid-gas membrane bioreactor (L/G MBR) without additional bacterial seeding, using different biomasses. The feasibility of spontaneous biohydrogen production in the L/G MBR was demonstrated for several organic byproducts originated from agriculture or the food industry (grape must deposits (same biomass for feeding), grape pomace, and coffee silverskin), chosen for their potential to ensure year-round availability. Production performances of 0.9–4.1 L H₂/L/d and 18–86 L H₂/kg COD were obtained from the different waste liquid fractions. The bacterial and metabolic profiles of biomass digestates, produced by endogenous fermentation in a semi-batch bioreactor or by spontaneous fermentation in the L/G MBR were compared and showed that the bacterial consortium found in the digestate was linked either to the biomass' indigenous flora or to the L/G MBR seeding. Thus, H₂ production from coffee silverskin (a biomass that did not impose its own microflora) could be enhanced by seeding the L/G MBR with selected bacteria, implanted in the bioreactor. This offers exciting perspectives for the further development of efficient low-tech processes for producing biohydrogen from biomass.

1. Introduction

Among the various processes developed to produce hydrogen from biomass, dark fermentation stands out for its remarkable hydrogen production rate, low energy requirements and ease of implementation and could be considered as an environmentally sustainable solution for bioenergy production (Camacho et al., 2022) based on life cycle analysis. Simplifying the process and limiting inputs will play a key role in its development on a larger scale.

In most dark fermentation processes, an exogenous inoculum of

hydrogen-producing bacteria is typically added as either a pure culture, a co-culture (Elsharnouby et al., 2013) or a mixed culture (Gottardo et al., 2023). While using a mixed culture eliminates the need for sterile operating conditions, it also brings the risk of other bacteria emerging as competitors to hydrogen-producing bacteria, thereby potentially reducing the final hydrogen yield. On the other hand, spontaneous fermentation with a long history in the production of fermented foods and beverages relies on either the indigenous microflora of the biomass or, more broadly, the microbial community present in the fermentation process environment, including the equipment (Anagnostopoulos and

* Corresponding author. Laboratoire de Reconnaissance et Procédés de Séparation Moléculaire (RePSeM), IPHC, UMR CNRS 7178, ECPM 25 rue Becquerel, 67087, Strasbourg, Cedex 2, France.

E-mail address: Barbara.Ernst@unistra.fr (B. Ernst).

<https://doi.org/10.1016/j.jclepro.2024.140759>

Received 24 October 2023; Received in revised form 8 January 2024; Accepted 12 January 2024

Available online 14 January 2024

0959-6526/© 2024 The Authors. Published by Elsevier Ltd. This is an open access article under the CC BY license (<http://creativecommons.org/licenses/by/4.0/>).

Tsaltas, 2019). Advancements in next-generation sequencing tools have facilitated in-depth studies aimed at characterizing bacterial communities and their role in the generation of biomolecules of interest during the production of products like cocoa (Herrera-Rocha et al., 2022), wine (Chen et al., 2022) and cheese (Asunis et al., 2019), to mention a few examples. Some studies have explored the implementation of dark fermentation through spontaneous fermentation, without the addition of an external inoculum (Kim et al., 2009; Favaro et al., 2013; Marone et al., 2014; Noblecourt et al., 2018; Asunis et al., 2019; Dauptain et al., 2020; François et al., 2021; Renaudie et al., 2022). However, to the best of our knowledge, no studies have been conducted on biohydrogen production by spontaneous fermentation in continuous mode.

In continuous fermentation, there are significant challenges to overcome, such as preventing the washout of hydrogen-producing bacteria (HPB) from the reactive medium (Li and Fang, 2007) and managing potential changes in microbial composition (Badiei et al., 2011). Additionally, continuous extraction of hydrogen from the reactive medium is a crucial parameter for maintaining a high hydrogen production rate (Clion et al., 2015). To address these requirements in a single device, a continuous liquid/gas hollow fiber membrane bioreactor (L/G MBR) was developed (Ernst et al., 2015). This innovative system allows *in situ* extraction of the produced hydrogen, and a prior study demonstrated the successful immobilization of a HPB biofilm at the surface of the fibers (Renaudie et al., 2021a). This process was further optimized using a model substrate (glucose) (Renaudie et al., 2021b).

Until now, only a few studies have combined dark fermentation of biomass with Membrane BioReactor (MBR) technology. Kim et al. (2011) and Lee et al. (2014) demonstrated that solid/liquid separation methods could effectively maintain HPB within the bioreactor. Trad et al. (2015) and Akca et al. (2021) specifically employed a liquid/liquid membrane for the separation of organic acids. These studies focused on the valorization of various organic wastes, such as food waste (Lee et al., 2014; Akca et al., 2021), tofu processing water (Kim et al., 2011) and whey straw (Trad et al., 2015). Notably, the application of liquid/gas separation techniques in this context has not been previously reported. Building on this, the present study aims to assess the feasibility of the L/G MBR approach under near life-like operating conditions, using biomass as substrates.

The most suitable biomass candidates for producing hydrogen from renewable resources are to be selected for their carbohydrate content, abundance/availability and cost-effectiveness. In this context, the by-products include vine and wine residues, rich in easily metabolizable hexoses, such as grape pomace (Guo et al., 2014), winery wastewater (Buitrón et al., 2019), grape must deposits (François et al., 2021), lees or filtration cake (Ernst et al., 2014)), as well as coffee by-products, containing substantial amounts of cellulose, hemicelluloses, lignin and proteins (Ballesteros et al., 2014), like coffee pulp (Miñón-Fuentes and Aguilar-Juárez, 2019), spent coffee grounds (Petrosyan et al., 2020), coffee mucilage (Cardenas et al., 2019) and coffee silverskin (Renaudie et al., 2022) have been tested for hydrogen production through dark fermentation, exhibiting varying levels of efficiency. The selected biomasses: grape must deposits, grape pomace and coffee silverskin were tested in a semi-batch bioreactor without added inoculum (endogenous dark fermentation) in our laboratory, proving the existence of active microflora for hydrogen production. Thus, the challenge of the present study is to implement them in L/G MBR to achieve continuous hydrogen production.

The primary objective of this study was to evaluate whether the membrane module seeded with a digestate rich in HPB (from endogenous fermentation of biomass in a Semi-Batch BioReactor (SBBR)) could be employed for continuous biohydrogen production in the L/G MBR through spontaneous dark fermentation using various biomasses, with minimal washing between each production phase. Additionally, we sought to establish whether the biohydrogen production performances achieved in a SBBR through endogenous fermentation could be maintained or, ideally, improved in the continuous L/G MBR. Specifically, we

investigated whether the metabolic and microbiological signature of the L/G MBR digestate would resemble that of the SBBR digestate, resulting from the endogenous fermentation of the substrate used, or if the signature of the consortium used to seed the L/G MBR would predominate.

2. Materials and methods

2.1. Organic wastes

2.1.1. Sampling

Grape must deposits and grape pomace were obtained from an Alsatian wine producer located in Dahlenheim, France. Coffee silverskins were collected from a coffee roasting factory known as Les Cafés Sati, also located in France.

2.1.2. Pretreatments before fermentation tests

Before fermentation in the SBBR, 50 mL of grape must deposits, or 50 g of grape pomace or coffee silverskins were diluted in 650 mL of tap water.

For practical implementation in the lab scale L/G MBR, solid grape pomace and coffee silverskin were pretreated to extract metabolizable substrates into an aqueous phase. Samples of each biomass were ground and briefly (in order to prevent the occurrence of fermentation) soaked in tap water at ambient temperature. The resulting solutions were then filtered on a metallic grid (pore diameter 1 mm) to remove the larger particles, followed by filtration through a Büchner funnel (pore diameter 40 µm, VWR) to prevent clogging of the lab-scale bioreactor. It is worth noting that these filtration steps may be eliminated after scale-up into a larger system.

To standardize the Chemical Oxygen Demand (COD) concentration, all mixtures of liquid biomass (grape must deposits, grape pomace, and coffee silverskin extracts) were diluted to adjust the COD concentration to a similar value of 15.7 ± 0.3 g/L. COD and total carbohydrates were measured according to the protocol used by Renaudie et al. (2022).

2.2. Bioreactors setup and operation

Fig. 1 illustrates schematic diagrams of the bioreactors' setup.

2.2.1. Semi-batch bioreactor (SBBR)

The fermentations of biomasses were conducted in a 1 L SBBR (semi-batch bioreactor) as described by Renaudie et al. (2022), equipped with a jacket coupled with a thermostated bath set at 37 °C. The bioreactor's tank was filled with 700 mL of diluted biomass.

To maintain the pH at a level above 5.5 during fermentation, NaOH was added using a pH regulator. The reactor was continuously swept with N₂ bubbles, with the flow rate regulated by a mass flow meter set at 50 mL/min. Collected liquid samples were centrifuged at 4500 rpm for 30 min, separating the supernatant from the pellet, and both fractions were stored at -18 °C for further use. In addition, the liquid outlet of the SBBR during the grape must deposit fermentation (at 24 h) will be used to seed the L/G MBR for the first experiment.

2.2.2. Liquid-gas membrane bioreactor (L/G MBR) for continuous production

The L/G MBR had a working volume of 0.5 L and consisted of a cylindrical-shaped hollow-fiber membrane module. The hollow fibers, with a pore diameter of 0.1 µm, were made of polytetrafluoroethylene and sealed at each end of the membrane module and was working as described previously by Renaudie et al. (2021a). To maintain the liquid outlet's pH at 5.0 ± 0.2 , a continuous addition of 0.5 M NaOH solution into the liquid medium was accomplished through a peristaltic pump. The membrane module's temperature was regulated at 37 °C by circulating heated water within a heating coil placed around it. After each test, the bioreactor was emptied and thoroughly rinsed with water. The

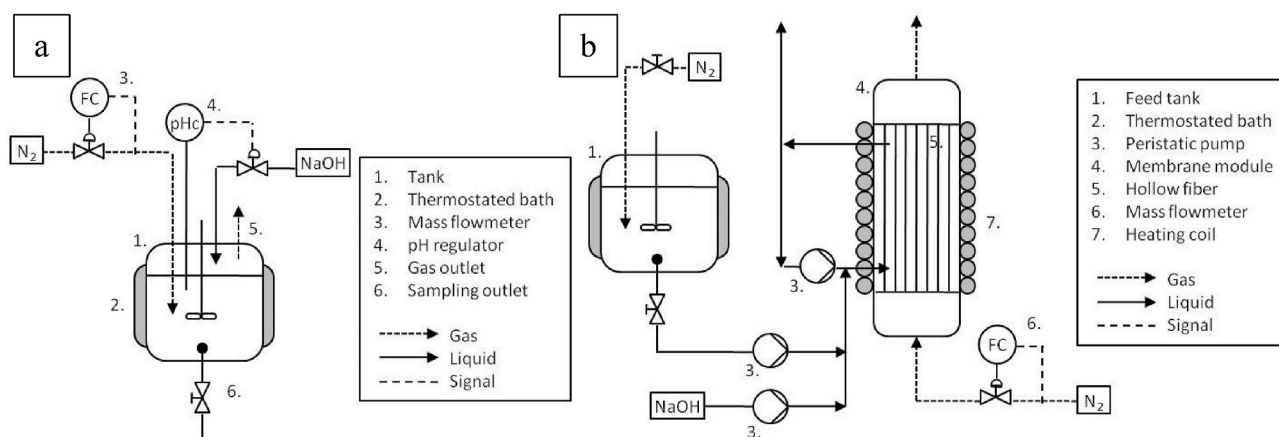

Fig. 1. Schematic diagrams of the SBBR (a) and the L/G MBR (b).

first test was performed with inoculation of the membrane module, and then several subsequent tests were conducted under the same protocol with no further inoculation.

To avoid damaging the membrane module, 3 additional fibers were added to analyze the profile of the biofilm growing on the surface of the hollow fibers. The L/G MBR was then operated as described earlier by Renaudie et al. (2021b). At the end of the fermentation test, the bioreactor was purged, and microbial granules were collected, while the added fibers were removed.

Throughout the fermentation, liquid samples were taken from the outlet, underwent the treatment explained in 2.2.1 part.

2.3. Chemical analysis

Gas analysis was carried out using a gas microchromatograph (μ GC) (T3000, SRA, France) equipped with two modules and thermal conductivity detectors (TCD), as clarified in Renaudie et al. (2021a).

For the analysis of the reactive medium, the supernatant was thawed, followed by centrifugation (15,000 rpm, 15 min) and filtration through a 0.2 μ m filter before being used.

Organic acids, alcohols and carbohydrates were analyzed following Renaudie et al. (2021a) methodology.

2.4. Microbiological analysis

2.4.1. Scanning electron microscopy (SEM)

After fermentation, samples of hollow fiber and microbial granules were extracted from the membrane module. To collect the granule sediments from the liquid fraction, 7 mL of liquid outlet was taken, and the membrane module was completely emptied through the bottom liquid outlet. Additional hollow fibers were cut at both potting extremities and removed from the module via the top liquid outlet. These fibers were then sectioned into three 6 cm-segments. All samples were immediately placed in a fixating agent (cacodylate buffer 0.2 M, H₂O, osmium tetroxide 4% (w/v)) in the dark at 4 °C. Subsequently, the samples were dehydrated using ethanol with increasing concentrations (50%–100%). Hexamethyldisilazane was added to the samples, and after evaporation, the samples were deposited on metallic plots covered with carbonated scotch and a fine layer of palladium using a metalizer for 6 min. The images were acquired using a scanning electron microscope (FEI Sirion FEG).

2.4.2. 16S DNA sequencing

DNA extraction from the centrifugation pellets, previously stored at -18 °C, was carried out using a Fast DNA Spin Kit for Soil (MP) following the manufacturer's recommended protocol. The concentration of the extracted DNA was determined using a Qubit kit (Invitrogen), and

the extracted DNA was subsequently stored at -18 °C.

Sequencing was performed using a MiSeq sequencer (Illumina) from total extracted DNA as described previously (Renaudie et al., 2021b).

3. Results

In this study, our aim was to assess the feasibility of utilizing organic waste (grape must deposits, grape pomace extract, and coffee silverskin extract) to feed a biohydrogen-producing L/G MBR process under realistic operating conditions. To initiate the process, the membrane module was first inoculated with grape must deposits digestate, which was produced as reported in our previous study (François et al., 2021). Our previous work demonstrated that after 24 h of endogenous fermentation in a SBBR, the grape must deposits' bacterial community primarily comprised hydrogen-producing bacteria, particularly *Clostridium*. These results were consistently validated through triplicate experiments and on grape must deposits collected over two consecutive years.

Following the inoculation, the L/G MBR was operated for biohydrogen production using fresh grape must deposits as the substrate. After this phase, the membrane module was rinsed with water, and no further inoculation was performed.

Subsequently, we employed grape must deposits, grape pomace extract, and coffee silverskin extract as sequential substrates for biohydrogen production, while analyzing the impact of each substrate on gas and metabolite production, as well as the microbial consortium. To facilitate comparison, we also conducted endogenous fermentation of the same waste in the SBBR. This allowed us to investigate whether the initial HPB-rich inoculum would persist in the membrane module over an extended operating period with different biomass substrates or if it would be replaced by the endogenous inoculum of each specific biomass used.

3.1. Implementation of dark fermentation in the L/G MBR using grape must deposits

A fermentation test was initiated in the SBBR. After 24 h ($t = 24$ h), the liquid outlet of the SBBR was connected to the liquid inlet of the L/G MBR. The culture medium was then transferred into the membrane module under anaerobic conditions, utilizing a peristaltic pump. Subsequently, grape must deposits were diluted in water at a ratio of 1:20 to achieve a COD concentration of 15.7 ± 0.3 g/L. This diluted mixture was stored in the feeding tank at 4 °C and swept with nitrogen gas to deoxygenate the substrate. Upon completion of the transfer, the feeding of the L/G MBR with the diluted grape must deposits commenced, marking the beginning of the test. No further bacterial inoculation or thermal treatment was performed during this process. The L/G MBR system was operated maintaining a consistent Hydraulic Retention Time

(HRT) of 8 h and Organic Loading Rate (OLR) of 1.4 $g_{COD}/L/h$.

3.1.1. Gas analysis

Fig. 2 present the gas production at the outlet of the hollow fibers when the grape must deposits were used as the substrate and fed to the bioreactor.

The rates of H_2 and CO_2 production were relatively similar, gradually increasing from 0h to 120h, and then stabilizing at around 3 $mL_{H_2}/L/min$ until 188h (Fig. 2). Significant variations in the hydrogen production rate (HPR) were observed between 100h and 118h. HPR was not measured from 124h to 152h due to unexpected equipment shut down. There was a sharp decline in HPR between 188h and 192h, caused by an obstruction in the substrate feed pipe (suspended matter accumulation). After unclogging and restarting the feeding system, HPR recovered to 3 $mL_{H_2}/L/min$ until 216h. A second drop happened between 219h and 224h. After clearing the obstruction and restarting the feeding system, the HPR increased to 2.3 $mL_{H_2}/L/min$ but did not reach the previous HPR levels.

Hexose consumption significantly increased during the initial phase of gas production (<80h) and reached near-complete utilization during the steady production phase. An average hydrogen yield (HY) of 1.3 mol_{H_2}/mol_{hexose} and HPR of 189 $mL_{H_2}/L/h$ were achieved during the pseudo steady state (Table 1). The molar ratio H_2/CO_2 remained constant and relatively high (>1).

3.1.2. Soluble metabolites analysis

In the liquid outlet, the flow rates of glucose and fructose gradually decreased over time (Fig. 3), with almost complete hexose conversion observed at 164 h (steady state). Initially, tartrate was present in the grape must deposits, and since it remained constant in the liquid outlet analysis, it was not consumed under these conditions.

At the beginning of the test, the liquid outlet showed the presence of acetate, butyrate, formate, and propanol (approximately 0.8 $mmol/L/h$), along with smaller quantities of lactate, ethanol, and succinate. This was expected, as the SBBR digestate used for inoculation in the L/G MBR contained these metabolites. As the fermentation proceeded in the L/G

MBR, the dominant metabolites produced were butyrate, acetate, and lactate, with ethanol production starting at 125h. The production of lactate decreased from 148h and eventually ceased at 188h. Minor metabolites were also detected at levels below 0.5 $mmol/L/h$, including formate, succinate, isovalerate, propanol and butanol. Notably, the production of butanol began simultaneously with ethanol production at 116h, indicating a metabolic shift towards solventogenic pathways.

3.1.3. Bacterial community analysis

Once the L/G MBR reactor has been seeded and is operating with grape must deposits as a substrate, it is interesting to visualize the implantation of the bacterial consortium on the fibers, using a methodology established on model substrates (Renaudie et al., 2021a), thanks to the installation of removable fibers in the module.

SEM analysis revealed the formation of a bacterial biofilm on the surface of the hollow fibers (Fig. 4).

On the upper part of the hollow fiber (Fig. 4a), a bacterial biofilm was observed only on the length of the left external surface (Figs. 4a–1). On the left side of the fiber, a thin layer of bacteria was observed, while on the right side, no microorganisms were present, and the surface pores of the fiber were visible. Additionally, aggregates of a thin bacterial biofilm were observed at different levels of the fiber, partially detached from its surface. Figs. 4a–2, zooming in on the same zone (x5000), revealed various bacterial morphologies (cocci and rods) entrapped in an extracellular polymer substance.

Moving to the middle part of the fibers (Fig. 4b) and the bottom part (Fig. 4c), a higher density of the bacterial population was observed. In Figs. 4b–1 and 4c–1, two aggregates were seen detached from the surface of the fiber at low zoom. Further magnification (Figs. 4b–2 and 4c–2) revealed the presence of rod-shaped microorganisms, varying in length, as well as a few larger-sized spherical microorganisms.

These images confirm the existence of a heterogeneously distributed biofilm along the fibers of the bioreactor.

Fig. 5 presents SEM micrographs of several flocs found at the bottom of the L/G MBR at the end of the test. These flocs exhibited different appearances to the naked eye, with some being black and compact

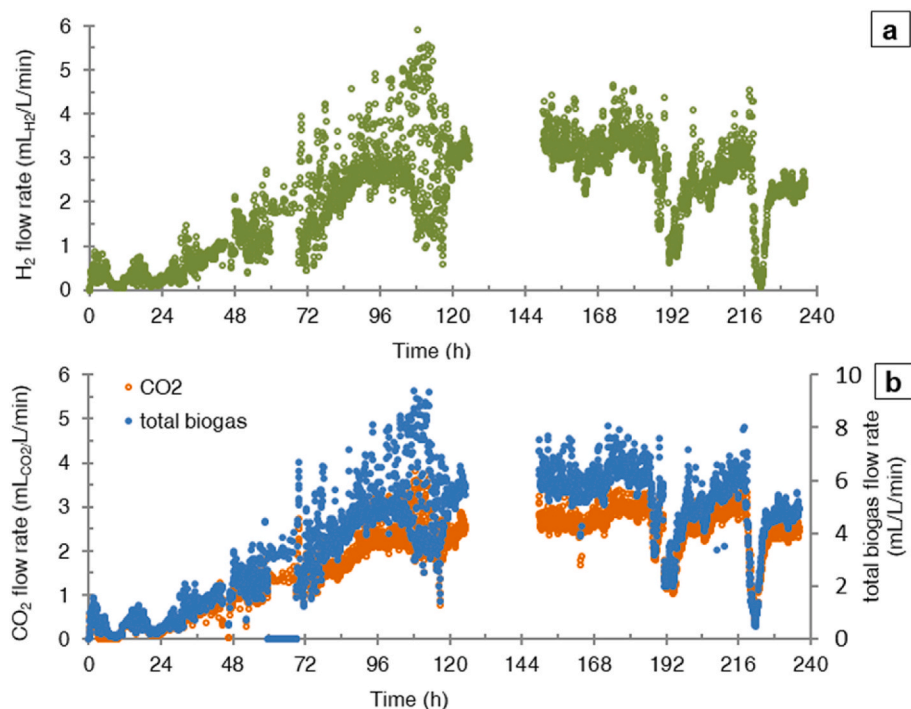

Fig. 2. Evolution of hydrogen production rate (a) and carbon dioxide production rate and total flow rate (b) in the liquid outlet of the L/G MBR that was inoculated and fed with grape must deposits.

Table 1
Hydrogen production performances for the L/G MBR inoculated and fed with grape must deposits.

Time range (h)	Hexose consumption (%)	HY (mol _{H₂} /mol _{hexose}) (hexose added ^a)	HY (mol _{H₂} /mol _{hexose}) (consumed hexose ^a)	HY (mL _{H₂} /g _{COD}) (initial COD)	HPR (mL _{H₂} /L/h)	H ₂ /CO ₂
0–96	43.9	0.4	0.9	35.5	71	1.3
96–188	98.7	1.3	1.3	94.3	189	1.2

^a hexose = glucose + fructose, HY: hydrogen yield, HPR: hydrogen production rate.

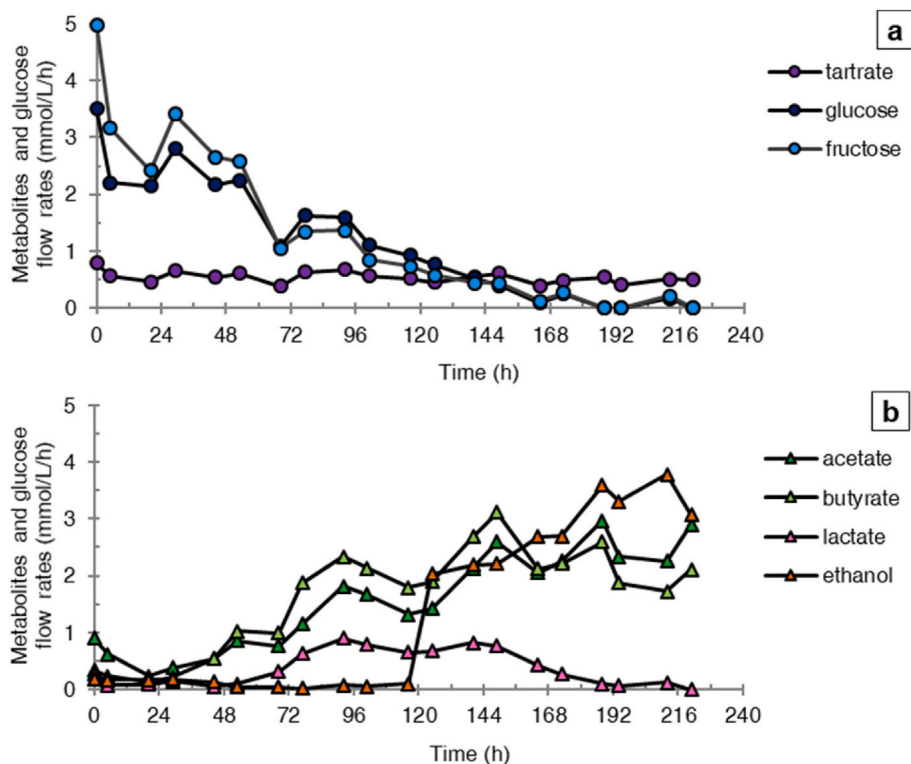

Fig. 3. Evolution of glucose, fructose and tartrate flow rates (a) and main organic acids and alcohols flow rates (b) in the liquid outlet of the L/G MBR fed with grape must deposits.

(Fig. 5a), while others appeared yellowish and sparse (Fig. 5b). The sampled structures slightly dissociated when placed in the fixing agent, and their sizes were larger than those visible in the SEM images obtained.

Figs. 5a–1 displays several compact structures (appearing black to the naked eye) of various sizes, with grainy surfaces. Upon closer examination of the structure in the center of the micrograph (Figs. 5a–2) bacteria were observed within extracellular polymer substances in abundance.

Figs. 5b–1 exhibits several porous structures (appearing yellow to the naked eye) of different sizes. Zooming in on the structure in the center of the micrograph (Figs. 5b–2) revealed a multitude of bacterial cells with diverse morphologies, primarily rod-shaped and with limited or no extracellular polymer substance.

Characterization of the bacterial consortia (bacterial diversity) is useful to see how they evolve over time, and to detect any differences in the bacterial communities present on the fibers and those leaving the reactor in the liquid phase. Thus, the bacterial consortium was sequenced, and bacterial diversity was assessed using Simpson's index and taxa abundance in the effluent of the L/G MBR at different fermentation phases (Fig. 6a). From 96h to 253h, Simpson's index decreased from 0.20 to 0.18, indicating a slight increase in bacterial diversity.

A 96h and 149h, *Sporolactobacillus laevolacticus* emerged as the dominant taxon (Fig. 6a), accounting for 35.5% of the bacterial

community at 96h, followed by 33.7% at 149h. It declined to 11.6% at 235h. *Sporolactobacillus laevolacticus* is a homofermentative bacterium known for its ability to completely convert glucose into lactate. Notably, in a previous study, *Sporolactobacillus laevolacticus* was employed to produce lactate from cotton seed hydrolysate in a fed-batch bioreactor at 37 °C and pH 5, resulting in a lactate productivity of up to 4.1 g_{lactate}/L/h (Li et al., 2013).

The *Clostridiaceae* family exhibited both abundance and diversity, with the presence of at least 9 taxa. Among them, the abundance of a first group consisting of *Anaerobacter polyendosporus*, *Clostridium saccharobutyricum*, and *Clostridium beijerinckii* declined, while the abundance of a second group, comprising *Clostridium kogasensis*, *Clostridium pasteurianum*, and *Clostridium* sp., increased over time. *Anaerobacter polyendosporus* is known for its capacity to produce hydrogen and butyrate through glucose fermentation and is notable for its ability to form endogenous spores. This species has been previously identified in hydrogen-producing granules in a UASB system (Jung et al., 2013). Additionally, *Ethanoligenens harbinense* also emerged over time, accounting for 6.5% of the bacterial community at 235h.

Bacterial diversity was assessed at various locations within the L/G MBR at the end of the test (235h). The highest bacterial diversity was observed in the microbial granules (Simpson index: 0.14), followed by slightly higher diversity on the hollow fiber (0.15–0.16) compared to the liquid outlet (0.18).

Fig. 6b presents the abundances of the main taxa in the different

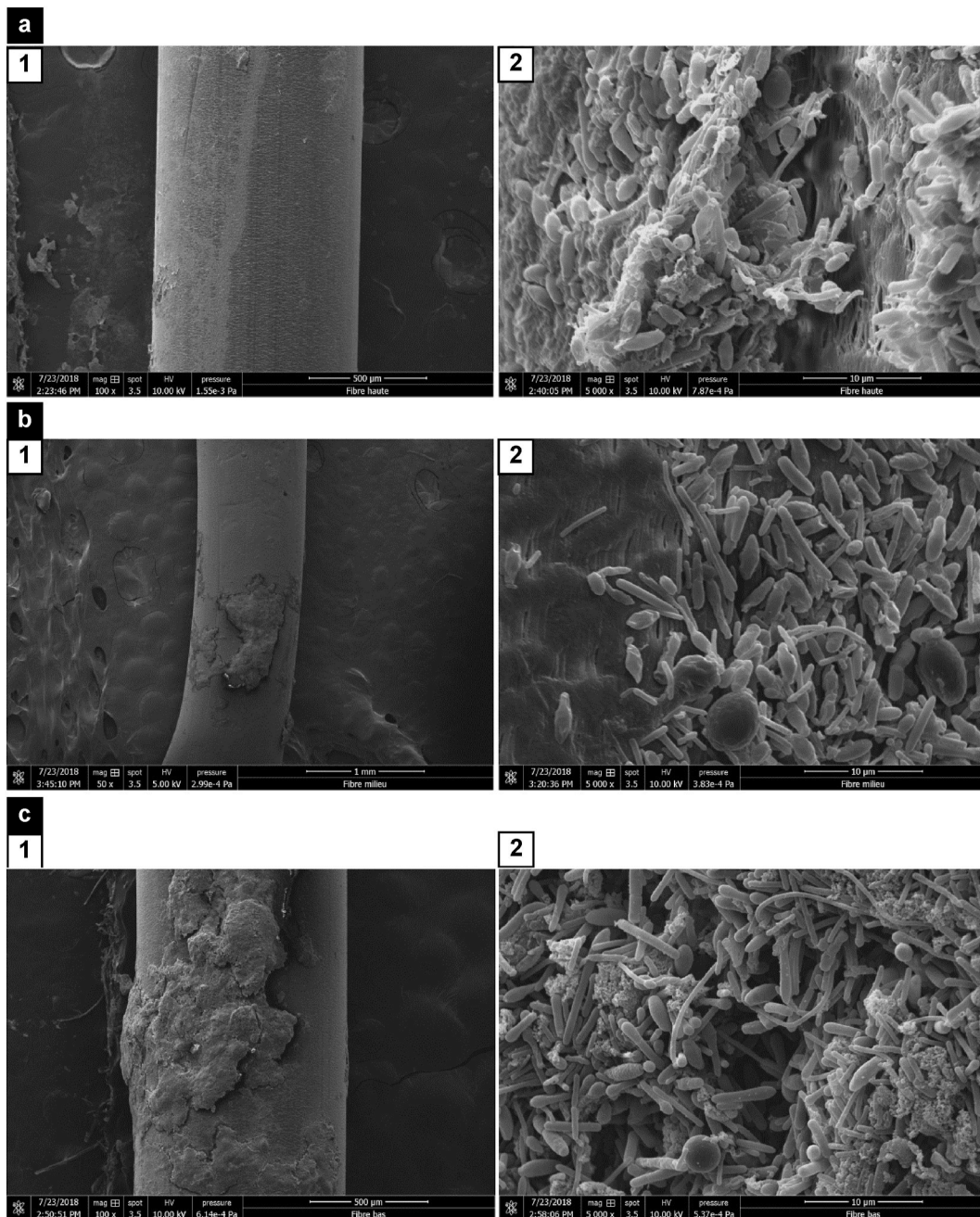

Fig. 4. SEM micrographs of the additional fibers used in the L/G MBR test with grape must deposits: top of the fiber (a): $\times 100$ (1), $\times 5000$ (2); middle of the fiber (b): $\times 50$ (1), $\times 5000$ (2); bottom of the fiber (c): $\times 100$ (1), $\times 5000$ (2).

locations.

The abundance profiles of the biofilm present on the surface of the hollow fibers are similar at the top and bottom of the module. *Ethanoligenens harbinense* was the dominant taxon, accounting for 29.8% and 26.0% of the biofilm at the top and bottom, respectively, followed by *Sporolactobacillus laevolacticus* (17.2% and 18.9%) and *Clostridium pasteurianum* (14.9% and 13.3%) (Fig. 6b). The abundance of minor taxa was also close, notably for *Clostridium* sp. (12.2% and 9.3%), *Clostridium beijerinckii* (3.4% and 2.5%), and *Clostridium saccharobutylicum* (2.5% and 1.4%). Interestingly, *Enterobacter* sp. was 3.4 times more abundant at the bottom of the membrane module compared to the top (34.0% and 11.7%). The abundance of *Clostridium pasteurianum* was comparable in the effluent and in the granules, accounting for 25.7% and 21.0% of the respective communities, which is 1.5–2 times higher than on the fiber surface. *Clostridium kogasensis* and *Clostridium* sp. were strongly

represented in the effluent, with abundances of 18.8% and 22.4%, respectively. *Sporolactobacillus laevolacticus* was present in all zones of the module considered, mainly in the granules (22.5%), followed by the surface of the fiber (18%) and then in the effluent (12%). Saraphirom and Reungsang (2011) reported that *Sporolactobacillus* produces bacteriocins, which could have a negative effect on HPB. *Enterobacter* sp. emerged only in the lower part of the module, constituting 11.7% of the microbial community in the granules and at the bottom of the hollow fibers.

A set of taxa from the phylum *Firmicutes* (*Clostridiaceae* and *Enterococcaceae*) had a ubiquitous and minor presence (<6%) at $t = 235$ h in both the granules and on the surface of the hollow fibers. These taxa included *Anaerobacter polyendosporus*, *Caloramator quimbayensis*, *Clostridium saccharobutylicum*, *Clostridium kogasensis*, *Clostridium saccharobutylicum*, *Clostridium beijerinckii/diolis*, and *Clostridium*

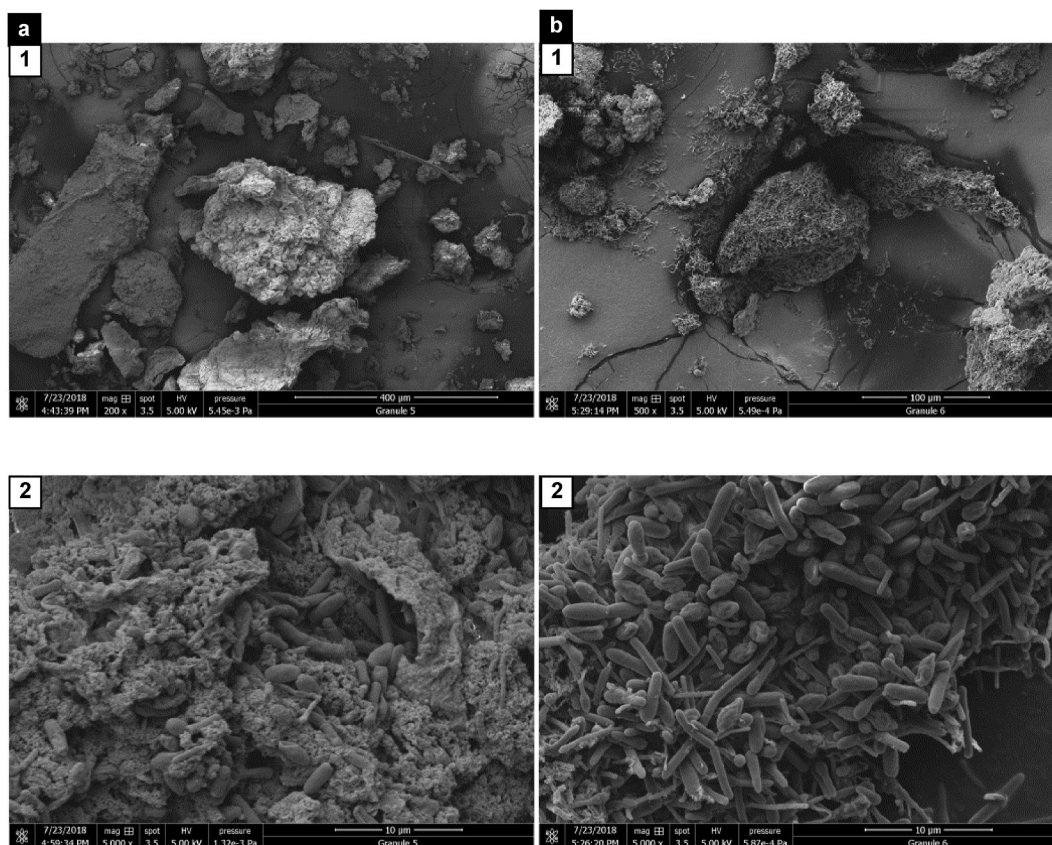

Fig. 5. SEM micrographs of the granules collected at the end of the L/G BRM test fed with grape must deposits: compact structure (a) 200x (1) and 5000x (2), sparse structure (b) 500x (1) and 5000x (2).

carboxidivorans/drakei. In addition to bacteria of the genus *Clostridium* and *Anaerobacter polyendosporus*, which produce hydrogen, *Caloramator quimbayensis* is an anaerobic, motile, moderately thermophilic, sporulating, and carbohydrate-fermenting bacterium that mainly produces formate, acetate, ethanol, and lactate (Rubiano-Labrador et al., 2013).

In summary, the results show a similar diversity profile with variability in taxa abundance between the liquid outlet consortium and the consortia located on the fiber surface.

3.1.4. Comparison of membrane-integrated bioreactors tested with complex biomasses

Until now, only a limited number of studies have explored hydrogen production by dark fermentation using biomass instead of model substrates in continuous MBR. These studies focused on the valorization of waste from tofu production (Kim et al., 2011), food waste (Lee et al., 2014; Akca et al., 2021) and wheat straw (Trad et al., 2015). Table 2 provides a comparison of the production performances from our study with those obtained in these tests.

To the best of our knowledge, this study represents the first instance of dark fermentation of biomass using a liquid/gas membrane extraction approach. Other studies have utilized submerged solid/liquid membranes to concentrate bacterial biomass or employed external liquid/liquid membranes to efficiently extract organic acids produced during fermentation. In our investigation, the HY achieved in the L/G MBR is comparable to HY values obtained using solid/liquid MBRs with an extended solid residence time (SRT) (Kim et al., 2011; Lee et al., 2014). Notably, after optimization, these prior studies achieved substantial increases in HY. The highest HY values (ranging from 1.9 to 2.2 mol/mol) were attained with HRT of 8 h and an OLR of 5.4 $g_{COD}/L/h$ (2.3 $g_{carbohydrates}/L/h$) (Kim et al., 2011), and an HRT of 10.5 h and an OLR of 5.2 $g_{COD}/L/h$ (1.7 $g_{carbohydrates}/L/h$) (Lee et al., 2014). While our

study used a similar HRT, the OLR was relatively lower. Moreover, the bacterial concentration in the solid/liquid MBRs was higher, leading to improved substrate degradation and organic acid consumption, thus resulting in enhanced H_2 production.

With the exception of the study by Trad et al. (2015), which achieved lower productivities, our results fall within the same range of hydrogen productivity compared to configurations aiming to increase the SRT as described in the literature. The highest HPR values reported in studies by Kim et al. (2011), Lee et al. (2014) and Akca et al. (2021) were achieved using higher OLRs and/or at higher fermentation temperatures ($>55^\circ C$).

Utilizing membranes for separation in S/L or L/L configurations introduced additional energy costs due to the need for membrane backwashing (Kim et al., 2011; Trad et al., 2015; Akca et al., 2021), or when a vacuum pump was employed (Lee et al., 2014) to mitigate membrane fouling. These configurations allowed for the application of low HRTs (2h) (Kim et al., 2011). However, membrane fouling restricted the establishment of a steady state with high OLRs or high densities of solid particles (bacterial granules or suspended matter) (Lee et al., 2014). Conversely, our L/G MBR configuration allowed for the application of a low HRT (2h) (Renaudie et al., 2021b).

A future perspective of this study involves enhancing the development of H_2 -producing granules to increase the concentration of HBP while minimizing HBP washout without the need for an S/L membrane. This could facilitate increasing the OLR closer to the values used in the literature.

Lastly, our study achieved comparable performances to the ones reported in the literature using a mixed culture, without the need for thermal treatment of the inoculum, unlike the studies by Akca et al. (2021), Trad et al. (2015) and Kim et al. (2011). In the work of Lee et al. (2014), the bacterial inoculum was sampled from a continuous stirred

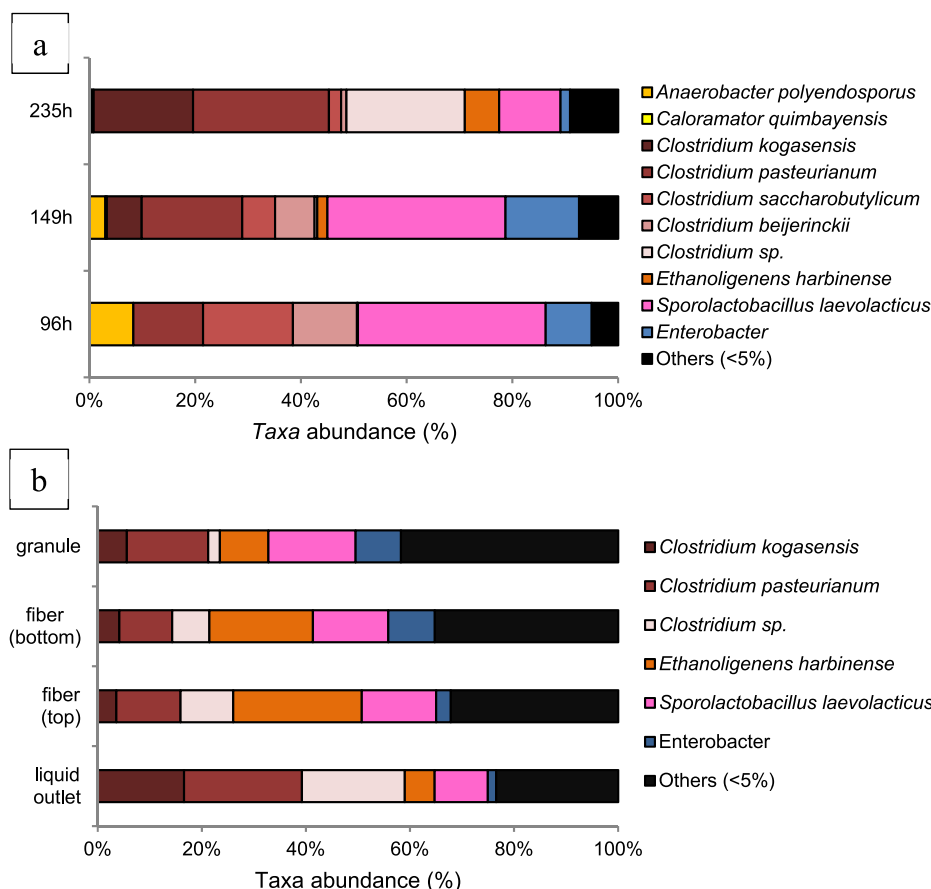

Fig. 6. Abundances of the main taxa (>5%) in the liquid outlet of the L/G MBR at different time points during fermentation (96h, 149h, and 235h) (a) and at 235h of fermentation in different locations within the L/G MBR (liquid outlet, surface of the fiber (top and bottom), granules) (b).

Table 2

Production systems integrating membranes with complex biomass.

Membrane configuration, material	Aim	Substrate	T°C	OLR (g/L/h)	HRT (h)	HY (mol _{H₂} /mol _{CH₄}) (carbohydrates (CH) added)	HPR (L _{H₂} /L/d)	Ref.
Hollow fibers, PTFE	Extract H ₂ <i>in situ</i>	Diluted grape must deposits	37	1.4 ^a 2.0 ^b	8.0	1.3	4.5	This work
Hollow fibers, n.a. submerged	Increase SRT of substrates and of HPB	Tofu processing waste	60	0.9–3.6 ^a 3.3–13.3 ^b	2.0–8.0	1.0–1.9	8.1–19.9	Kim et al. (2011)
Flat sheet, PE submerged	Increase SRT of substrates and of HPB	Food waste	55	1.0–1.7 ^a 2.9–5.2 ^b	10.5–18.7	1.2–2.2	3.4–10.7	Lee et al. (2014)
Hollow fibers PVDF externally-submerged	Acid extraction	Wheat straw + nutrients	35	n.a.	n.a.	n.a.	0.20–0.25 L/g _{substrate} /d	Trad et al. (2015)
Hollow fibers, PVDF externally-submerged	Acid extraction	Food waste	55	0.2–1.1 ^b	28.8–240	n.a.	0.1–11.8	Akca et al., 2021

PTFE: PolyTetraFluoroEthylene, PVDF: PolyVinylidene Fluoride n.a.: not available, SRT: solid residence time, HPB: hydrogen producing bacteria, OLR: organic loading rate, HRT: hydraulic retention time.

^a g_{carbohydrates}.

^b g_{COD}.

tank reactor that had been functioning for over 2 years, while in our test, H₂ was generated right after the seeding phase, and a steady state was reached quickly.

3.1.5. Outcomes on the implementation of dark fermentation in the L/G MBR using grape must deposits

The feasibility of hydrogen production using the L/G MBR inoculated with grape must deposits digestate in near-life operating conditions was successfully demonstrated. This study represents the first continuous mode experiment where the biomass was utilized both as a substrate and a source of hydrogen-producing bacteria. Moving forward, additional

biomasses were examined using the inoculated L/G MBR in order to expand the scope of this research.

3.2. Implementation of dark fermentation in the L/G MBR using various biomass sources without further bacterial seeding

The implementation of dark fermentation in the L/G MBR was examined using extracts from coffee silverskin then grape pomace. The L/G MBR system was operated with different biomass sources while maintaining a consistent HRT of 8 h and OLR of 1.4 g_{COD}/L/h, as previously employed.

3.2.1. Gas analysis

The highest HPR was achieved when utilizing grape must deposits, reaching 3.0 mL_{H₂}/L/min (Fig. 7). For coffee silverskin, the maximum HPR observed was 1.0 mL_{H₂}/L/min and for grape pomace, it was 0.6 mL_{H₂}/L/min. Regarding the H₂/CO₂ molar ratio, the CO₂ production rate from grape pomace was nearly double the hydrogen production rate, whereas when using coffee silverskin and grape must deposits, their respective productivities were comparable.

Using grape pomace and coffee silverskin as substrates, the pH of the liquid outlet remained within the range of 5.0–5.5, while the Oxydo Reduction Potential (ORP) stabilized at –400 mV and –350 mV, respectively. When grape must deposits were used, the pH initially started at 9, subsequently settled between 4.5 and 6.0, and the ORP ranged from –400 to –500 mV. Notably, during this particular test, an increase in pH from 4.5 to 5.5, accompanied by a decrease in ORP from –400 mV to –500 mV, resulted in a rise in the HPR from 1.5 to 3 mL-H₂/L/min.

As a result, the maximum HPR, HY, and H₂/CO₂ molar ratio were achieved when utilizing grape must deposits (Table 3). Although similar HPRs were attained using coffee silverskin and grape pomace as substrates, the H₂/CO₂ molar ratio was higher when using coffee silverskin. Throughout all the conducted tests, the average pH remained relatively consistent, ranging from 5.2 to 5.4. Notably, no alkaline additives were required to regulate the pH when coffee silverskin was used as a substrate.

Hydrogen was generated using various substrates in the L/G MBR, which had been previously seeded with digestate collected from dark fermentation production using grape must deposits. However, lower HY were observed when grape pomace and coffee silverskin were utilized as substrates.

3.2.2. Soluble metabolites analysis

When grape must deposits were employed, glucose was completely metabolized by 44h, followed by fructose at 68h (Fig. 8a-1). However, with coffee silverskin extract, the total consumption of both carbohydrates was slower and occurred at 77h (Figs. 8b-1). The initial glucose and fructose concentrations were higher when using grape pomace compared to grape must deposits or coffee silverskin extracts, leading to

a partial consumption of these sugars (Figs. 8c-1).

Similar to hydrogen production, a steady-state condition was not achieved for metabolite production.

When grape must deposits were utilized as a substrate (Figs. 8a-2), both acetate and butyrate were predominantly produced, in similar proportions. Additionally, ethanol, formate, and lactate were also generated as byproducts.

Coffee silverskin extract as a substrate primarily resulted in the production of butyrate, followed by propionate and acetate, with their production levels showing an increase over time (Figs. 8b-2). Formate was detected in the liquid outlet right from the start of the test, and its concentration remained constant throughout the experiment. Valerate production commenced after 40 h. Lactate and succinate were also generated but in minor quantities (<0.2 mmol/L/h).

When grape pomace was used as a substrate (Figs. 8c-2), ethanol emerged as the primary metabolite, present from the test's inception. Its production nearly ceased at 68 h, but then exhibited a resurgence from 77 h onwards. Notably, the decline in ethanol production coincided with an increase in acetate, butyrate, and succinate production. Furthermore, the elevation in ethanol production corresponded to an upsurge in lactate production towards the test's conclusion. Isovalerate production began at 24 h, while the production of other metabolites (butanol, citrate, propanol) remained minimal (<0.2 mmol/L/h).

To conclude, in spite of a carbohydrate consumption much higher, the test using grape pomace extract as a substrate generated few metabolites associated to hydrogen production, potentially due to the presence of inhibitors. Tests using coffee silverskin extract and grape must deposits generated essentially metabolites associated to hydrogen production.

3.2.3. Bacterial community analysis

The Simpson's indexes for the tests with grape pomace and coffee silverskin extracts were close, measuring 0.54 and 0.55, respectively. These values indicated similar bacterial diversity in the liquid medium in these two cases. However, in the test conducted with grape must deposits, the Simpson's index was 0.20, signifying a higher bacterial diversity in the liquid medium compared to the other two substrates.

The genus *Clostridium* was a common presence in all samples and

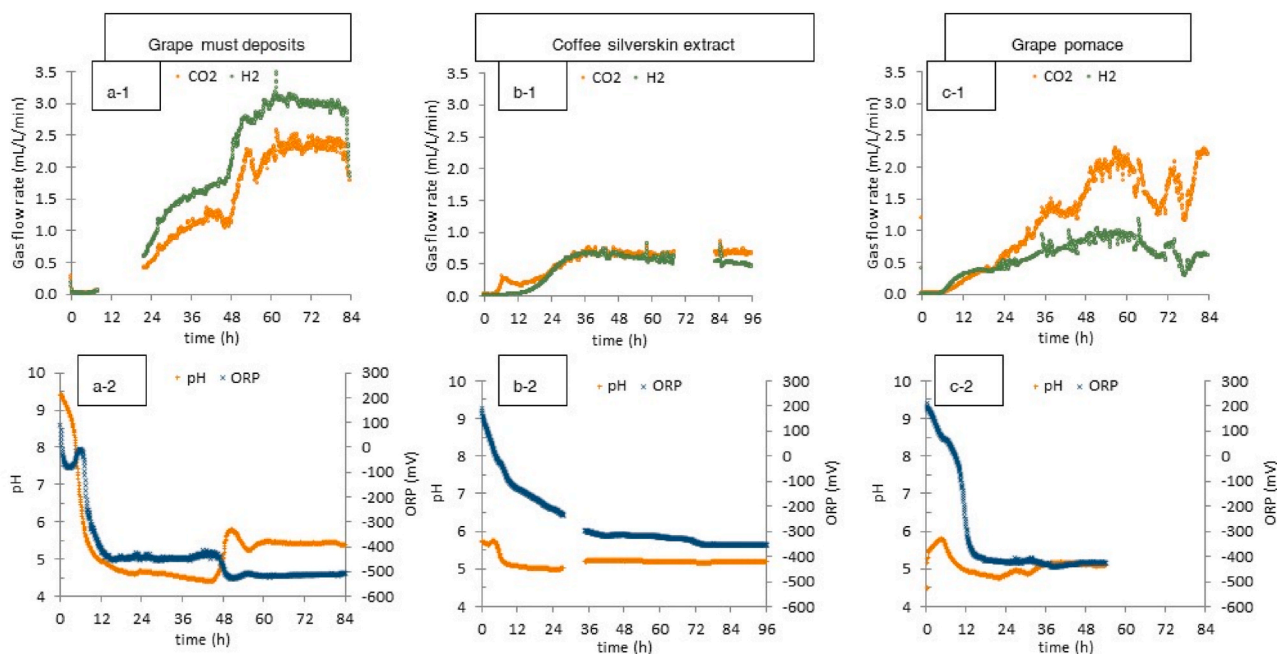

Fig. 7. Evolution of H₂ and CO₂ production rates (1) and pH and Oxydo Reduction Potential (ORP) (2) in the liquid outlet of the L/G MBR during fermentation tests with grape must deposits (a), coffee silverskin extract (b) and grape pomace (c).

Table 3

Comparative production performance in the L/G MBR using various substrates: ground grape pomace extract, coffee silverskin extract and diluted grape must deposits.

Biomass	Calculation phase	CODi (g _{COD} /L/h)	pH	HPR (mL _{H₂} /L/h)	HY (mL/g _{COD}) (added COD)	H ₂ /CO ₂ molar ratio
Grape pomace	24–96h	2.0	5.0	39.9 ± 10.7	20.0	0.43
Coffee silverskin	36–96h	2.0	5.2	36.5 ± 2.8	18.3	0.94
Grape must deposits	48–84h	2.0	5.4	171.6 ± 15.7	85.8	1.33

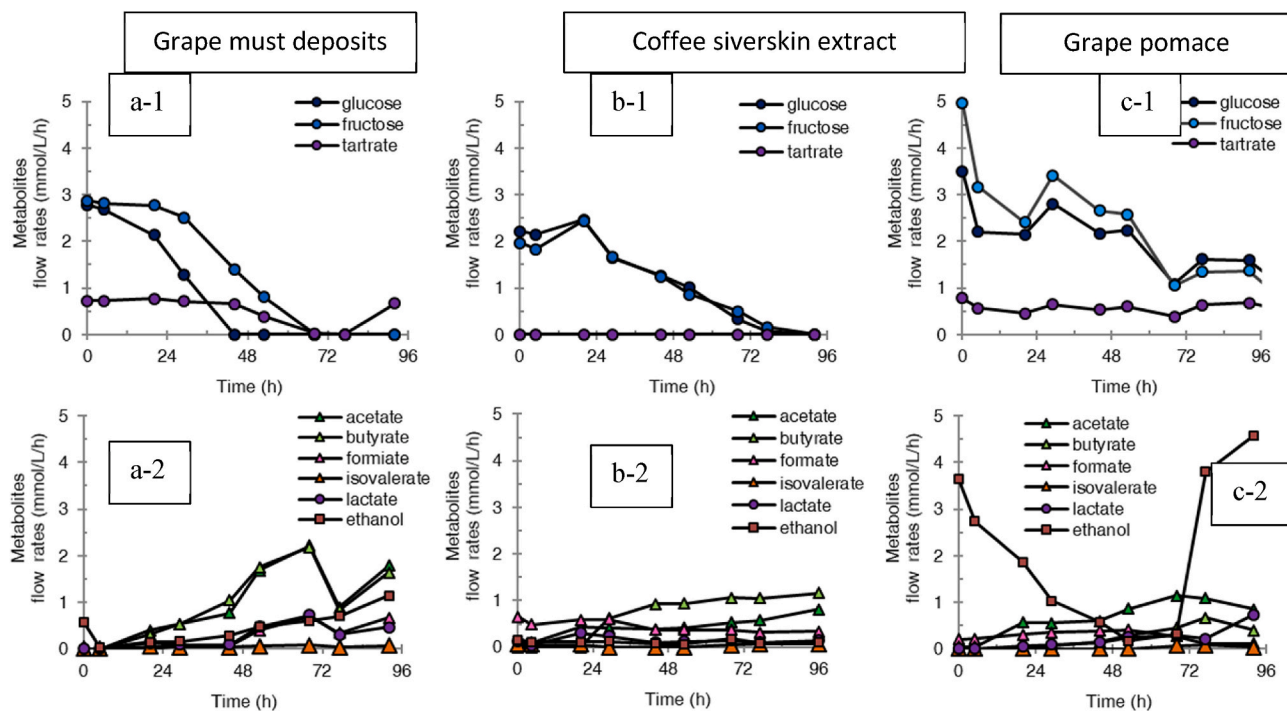

Fig. 8. Evolution of glucose, fructose and tartrate (specifically for grape pomace) and main organic acids and alcohols flow rates in the liquid outlet of the L/G MBR for fermentation test with grape must deposits (a1 and a2), coffee silverskin extract (b1 and b2) and grape pomace extract (c1 and c2).

displayed notably high abundance (60%) when coffee silverskin extract was utilized as a substrate (Fig. 9). *Enterobacter* sp. was consistently present and dominated in samples where grape pomace was used as a substrate (53%). Additionally, significant proportions of *Sporolactobacillus laevolacticus* (35%), *Clostridium saccharobutylicum* (17%), *Clostridium pasteurianum* (13%), and *Clostridium beijerinckii* (12%) were observed in samples where grape must deposits were employed as a substrate.

3.3. Comparative biohydrogen production performances using the L/G MBR with various substrates and using the SBBR with raw biomass

This paragraph will answer the question on the preservation of

metabolic and microbiological signature of the different biomass.

Table 4 provides a comparison of the HPR and HY obtained from tests conducted in both the L/G MBR and the SBBR, using grape must deposits, grape pomace, or coffee silverskin as substrates. This table also presents the main metabolites and associated bacterial genera. It should be noted that for grape pomace and coffee silverskin, the comparison is made between the whole biomass, which was diluted and implemented in the SBBR, and the extracts obtained through the grinding, soaking, and filtration of the biomass, which were implemented in the L/G MBR. The metabolic footprint and microbial consortium of each test were analyzed (Fig. 10) to assess which bacterial consortium would prevail: the one established on the surface of the fibers in the bioreactor or the one indigenous to the biomass.

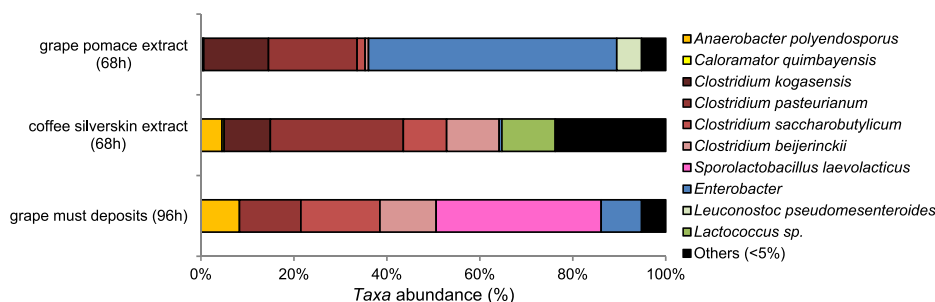

Fig. 9. Abundances of the dominant taxa (>5%) at the conclusion of fermentation test with grape must deposits (96h), coffee silverskin extract (68h) and grape pomace extract (68h).

Table 4

Comparative biohydrogen production performances by dark fermentation using the L/G MBR with various substrates (ground grape pomace extract, coffee silverskin extract and diluted grape must deposits) and using the SBBR with raw biomass.

Bioreactor	Biomass	HPR (L _{H2} /L/d)	HY (mL _{H2} /g _{COD})	H ₂ /CO ₂
L/G MBR	Grape must deposits	4.1 ± 0.4	86 ± 8	1.2
SBBR	Grape must deposits	1.9 ± 0.5	283 ± 56	1.0 ± 0.1
L/G MBR	Coffee silverskin extract	1.0 ± 0.1	18 ± 1	1.33
SBBR	Raw coffee silverskin	0.3 ± 0.1	21 ± 2	0.7 ± 0.0
L/G MBR	Grape pomace extract	0.9 ± 0.3	20 ± 5	0.43
SBBR	Raw grape pomace	1.2 ± 0.5	41 ± 9	0.6 ± 0.1

The test performed using grape must deposits as a substrate yielded the best HPR and HY. These superior performances were associated with a metabolic pathway favoring hydrogen production (acetate-butyrate), likely due to the presence of diverse *Clostridium* species in the fermentative medium.

In the case of the test performed with a coffee silverskin extract, promising production results were achieved despite lower initial glucose and fructose concentrations. This could be attributed to the solubilization of more complex carbohydrates during extract preparation,

followed by hydrolysis by extracellular bacterial enzymes during fermentation. *Clostridium* dominance and a butyrate-acetate-formate metabolic pathway in the L/G MBR favored hydrogen production. In contrast, the SBBR exhibited a dominant acetate pathway, associated with a higher presence of *Enterococcus* and *Lactococcus*, which might inhibit *Clostridium* growth, as previously reported (Liu et al., 2011; Egan et al., 2016). Thus, in this case, it appears that the biomass did not significantly influence bacterial development but primarily acted as a substrate.

When grape pomace was used as a substrate, the HPR was lower despite the initial glucose and fructose concentrations in the liquid feed being similar to those of grape must deposits. Both metabolic and microbiological profiles in the L/G MBR closely resembled those observed in the SBBR, featuring an ethanol-acetate metabolic pathway and a prevalence of *Enterobacter* in the liquid medium. The bacterial consortium in the L/G MBR was, therefore, influenced by the biomass, potentially suppressing the consortium present in the membrane module. Compounds released from grape pomace into the liquid medium might have inhibited *Clostridium* growth and favored the growth of *Enterobacter*, as grape pomace is rich in polyphenols (Beres et al., 2017), known to inhibit *Clostridium* growth (Duda-Chodak et al., 2015).

Overall, the HY values were lower in the L/G MBR compared to the SBBR. This difference could be attributed to higher lactate, succinate, and formate levels and non-consumption of tartrate in the L/G MBR, especially when using grape must deposits. Tartrate consumption in the SBBR has been reported to increase hydrogen production (Tabachnick

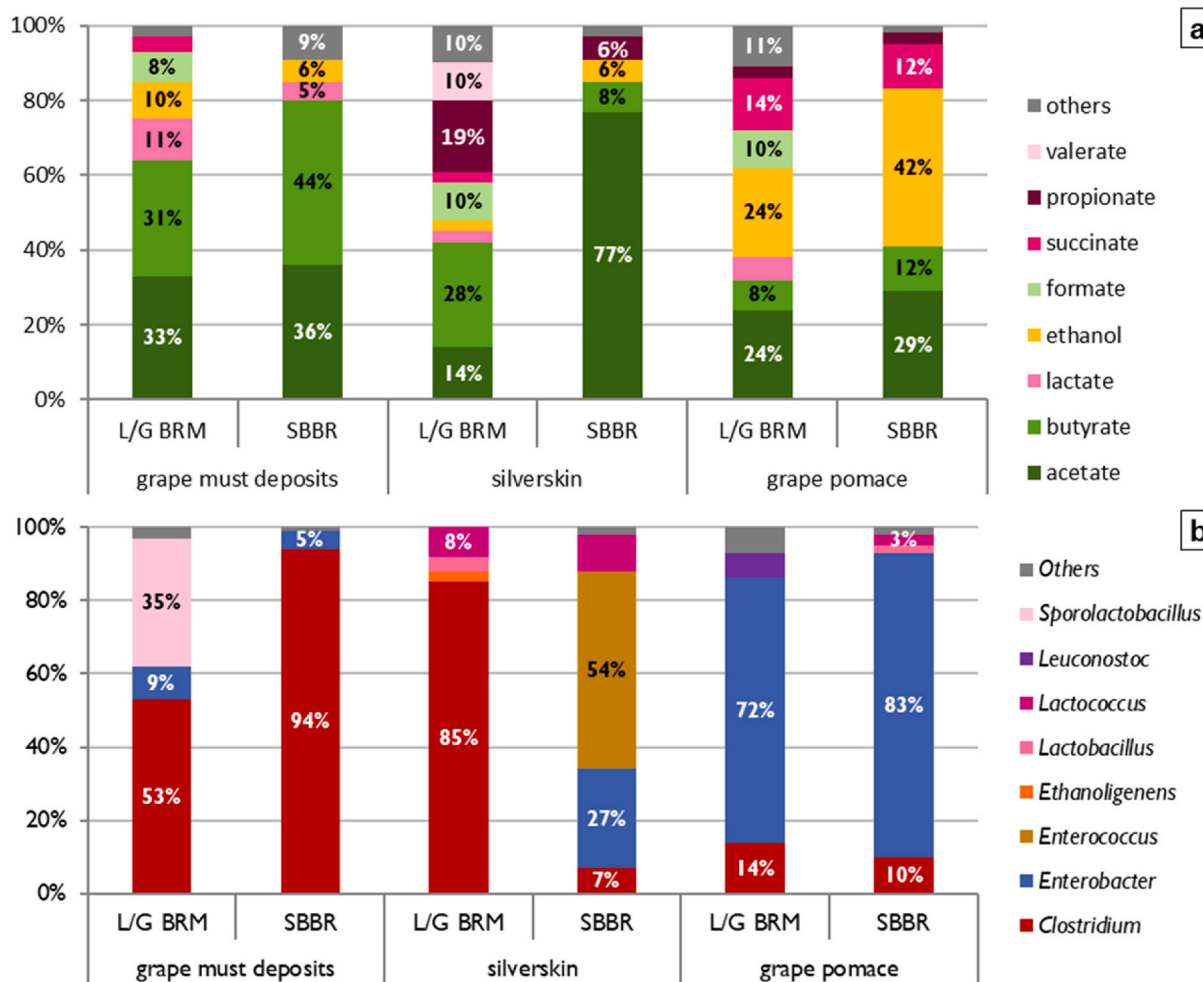

Fig. 10. Comparative analysis of dark fermentation digestate composition: metabolite production (a) and relative abundance of dominant taxa (>5%) (b) using the LG/MBR with various substrates (ground grape pomace extract, coffee silverskin extract and diluted grape must deposits) and using the SBBR with raw biomass.

and Vaughn, 1948). In the L/G MBR, when using grape pomace as a substrate, the percentage of metabolites that could be consumed as such represented 30% of the analyzed metabolites, whereas in the SBBR, it was only 12%. Additionally, a lower butyrate production was observed when grape must deposits were used as a substrate, likely due to a higher presence of *Sporolactobacillus* compared to the SBBR, which may partially inhibit *Clostridium* growth (Saraphirom and Reungsang, 2011). Only in the tests conducted using coffee silverskin, similar HY values were obtained, primarily due to *Clostridium* being favored over *Enterococcus*.

Based on the HPR comparison (maximal HPR in the SBBR versus average HPR reached in the steady state in the L/G MBR), implementing dark fermentation in the L/G MBR is favorable, except when using grape pomace. With grape must deposits, the HPR was doubled, and with coffee silverskin, it was tripled.

This study highlights that although the seeding step is crucial, the operation of the L/G MBR with a particular biomass may promote the development of an indigenous bacterial consortium adapted to the substrate. For such biomass that exhibits this behavior, seeding the membrane module with pure or co-cultures might not be necessary, as the endogenous bacterial populations could potentially dominate. However, for biomass that mainly acts as a substrate, this operating mode could be considered.

4. Conclusion and perspectives

A simple and versatile biohydrogen production process from biomass was successfully designed using a liquid-gas membrane bioreactor (L/G MBR). The system operated based on spontaneous fermentation, without the need for bacterial reseeded of the bioreactor, using several organic byproducts, typically treated as waste, from agriculture or the food industry, such as grape must deposits, grape pomace, and coffee silverskin. This approach resulted in hydrogen productivities ranging from 0.9 to 4.1 L_{H2}/L/d and hydrogen yields of 18–86 L_{H2}/kg_{COD}.

The study also investigated the origin of the bacterial consortium that developed in the cultivation medium of the L/G MBR. To do so, the bacterial and metabolic signatures of biomass digestates produced through endogenous fermentation in a semibatch bioreactor were compared to those generated by spontaneous fermentation in the L/G MBR. The analysis revealed that the digestate's bacterial consortium was linked either to the biomass's indigenous flora or to the initial seeding of the L/G MBR, which opens up exciting possibilities for further development of efficient low-tech biohydrogen production processes from biomass.

An area for potential improvement is to optimize the seeding of the membrane module using highly efficient hydrogen-producing bacteria. However, the interest of such manipulation will only be preserved if the biomass does not exert an action of selection of its native bacteria, to the detriment of the inoculum of the membrane module. Thus, variations in bacterial consortia can be a limitation to the process, and the option of hygienizing the biomass input can be a possibility, as this pre-treatment can lead to the risk of releasing bacterial growth inhibitors into the biomass used solely as a substrate.

Finally, the economic viability of the dark fermentation process needs to be considered in conjunction with other bioprocesses for consuming the organic acids present in the dark fermentation digestate: photofermentation (Özgür and Peksel, 2013), microbial electrolysis for hydrogen production, or anaerobic digestion for methane production and total degradation of biomass.

CRediT authorship contribution statement

Marie Renaudie: Writing – original draft, Investigation. **Christine Dumas:** Writing – review & editing, Validation. **Stéphane Vuilleumier:** Writing – review & editing. **Barbara Ernst:** Writing – review & editing, Supervision, Conceptualization.

Declaration of competing interest

The authors declare that they have no known competing financial interests or personal relationships that could have influenced the work reported in this paper.

Data availability

No data was used for the research described in the article.

Acknowledgements

We express our sincere gratitude to Les Cafés SATI (Strasbourg, France) and Mélanie Pfister winery estate for generously providing samples of coffee silverskin and Pinot Gris grape must deposits and grape pomace, respectively. We also extend our thanks to ADEME and Université de Strasbourg for supporting this research and fruitful discussion with Olivier Théobald. Thanks go to Christelle Gruffaz (GMGM, Université de Strasbourg-CNRS) for her assistance in DNA extraction, Anne-Clémence Aun (IPHC, Université de Strasbourg-CNRS) for her assistance with HPLC/GC analysis and Jean-Luc Weickert and Nadia Messaddeq (IGBMC, Université de Strasbourg-CNRS-INSERM) for the SEM images.

References

- Akca, M.S., et al., 2021. BioH₂ production from food waste by anaerobic membrane bioreactor. *Int. J. Hydrogen Energy* 46, 27941–27955. <https://doi.org/10.1016/j.ijhydene.2021.06.042>.
- Anagnostopoulos, D.A., Tsaltas, D., 2019. In: Galanakis, Charis M. (Ed.), *Innovations in Traditional Foods, Chapter 10 - Fermented Foods and Beverages*. Woodhead Publishing, pp. 257–291. <https://doi.org/10.1016/C2017-0-02480-1>.
- Asunis, F., et al., 2019. Control of fermentation duration and pH to orient biochemicals and biofuels production from cheese whey. *Bioresour. Technol.* 289, 121722. <https://doi.org/10.1016/j.biortech.2019.121722>.
- Badié, M., et al., 2011. Effect of hydraulic retention time on biohydrogen production from palm oil mill effluent in anaerobic sequencing batch reactor. *Int. J. Hydrogen Energy* 36, 5912–5919. <https://doi.org/10.1016/j.ijhydene.2011.02.054>.
- Ballesteros, L.F., et al., 2014. Chemical, functional, and structural properties of spent coffee grounds and coffee silverskin. *Food Bioprocess Technol.* 7, 3493–3503. <https://doi.org/10.1007/s11947-014-1349-z>.
- Beres, C., et al., 2017. Towards integral utilization of grape pomace from winemaking process: a review. *Waste Manag.* 68, 581–594. <https://doi.org/10.1016/j.wasman.2017.07.017>.
- Buitrón, G., et al., 2019. Biohydrogen production from winery effluents: control of the homoacetogenesis through the headspace gas recirculation. *J. Chem. Technol. Biotechnol.* 95, 544–552. <https://doi.org/10.1002/jctb.6263>.
- Camacho, C.I., et al., 2022. Dark fermentation as an environmentally sustainable WIN-WIN solution for bioenergy production. *J. Clean. Prod.* 374, 134026. <https://doi.org/10.1016/j.jclepro.2022.134026>.
- Cardenas, E.L.M., et al., 2019. Hydrogen production from coffee mucilage in dark fermentation with organic wastes. *Energies* 12, 71. <https://doi.org/10.3390/en12010071>.
- Chen, Y., et al., 2022. Yeast diversity during spontaneous fermentations and oenological characterisation of indigenous *Saccharomyces cerevisiae* for potential as wine starter cultures. *Microorganisms* 10, 1455. <https://doi.org/10.3390/microorganisms10071455>.
- Clon, V., et al., 2015. Key factors for biohydrogen production by dark fermentation. *Canadian Journal of Chemical Engineering* 93, 309–316. <https://doi.org/10.1002/cjce.22083>.
- Dauplain, K., et al., 2020. Role of indigenous bacteria in dark fermentation of organic substrates. *Bioresour. Technol.* 313, 123665. <https://doi.org/10.1016/j.biortech.2020.123665>.
- Duda-Chodak, A., et al., 2015. Interaction of dietary compounds, especially polyphenols, with the intestinal microbiota: a review. *Eur. J. Nutr.* 54, 325–341. <https://doi.org/10.1007/s00394-015-0852-y>.
- Egan, K., et al., 2016. Bacteriocins: novel solutions to age old spore-related problems. *Front. Microbiol.* 7, 461. <https://doi.org/10.3389/fmicb.2016.00461>.
- Elsharnouby, O., et al., 2013. A critical literature review on biohydrogen production by pure cultures. *Int. J. Hydrogen Energy* 38, 4945–4966. <https://doi.org/10.1016/j.ijhydene.2013.02.032>.
- Ernst, B., et al., 2014. Method for producing hydrogen by means of dark fermentation from biomass from the wine-producing industry, without using a microbial consortium. Patent, EP3186359B1.
- Ernst, B., et al., 2015. Dispositif de production d'hydrogène. Patent FR, 3041657.
- Favaro, L., et al., 2013. Effects of inoculum and indigenous microflora on hydrogen production from the organic fraction of municipal solid waste. *Int. J. Hydrogen Energy* 38, 11774–11779. <https://doi.org/10.1016/j.ijhydene.2013.06.137>.

- François, E., et al., 2021. Unexpected high production of biohydrogen from grape residues endogenous fermentation. *Bioresour. Technol.* 320, 124334 <https://doi.org/10.1016/j.biortech.2020.124334>.
- Gottardo, M., et al., 2023. Boosting butyrate and hydrogen production in acidogenic fermentation of food waste and sewage sludge mixture: a pilot scale demonstration. *J. Clean. Prod.* 404, 136919 <https://doi.org/10.1016/j.jclepro.2023.136919>.
- Guo, X.M., et al., 2014. Predictive and explicative models of fermentative hydrogen production from solid organic waste: role of butyrate and lactate pathways. *Int. J. Hydrogen Energy* 39, 7476–7485. <https://doi.org/10.1016/j.ijhydene.2013.08.079>.
- Herrera-Rocha, F., et al., 2022. Lipidomic profiling of bioactive lipids during spontaneous fermentations of fine-flavor cocoa. *Food Chem.* 397, 133845 <https://doi.org/10.1016/j.foodchem.2022.133845>.
- Jung, K.-W., et al., 2013. Rapid formation of hydrogen-producing granules in an up-flow anaerobic sludge blanket reactor coupled with high-rate recirculation. *Int. J. Hydrogen Energy* 38, 9097–9103. <https://doi.org/10.1016/j.ijhydene.2013.05.059>.
- Kim, D.-H., et al., 2009. Hydrogen fermentation of food waste without inoculum addition. *Enzym. Microb. Technol.* 45, 181–187. <https://doi.org/10.1016/j.enzmictec.2009.06.013>, 2009.
- Kim, M.-S., et al., 2011. Continuous hydrogen production from tofu processing waste using anaerobic mixed microflora under thermophilic conditions. *Int. J. Hydrogen Energy* 36, 8712–8718. <https://doi.org/10.1016/j.ijhydene.2010.06.040>, 2011.
- Lee, D.Y., et al., 2014. Effect of organic loading rate on continuous hydrogen production from food waste in submerged anaerobic membrane bioreactor. *Int. J. Hydrogen Energy* 39, 16863–16871. <https://doi.org/10.1016/j.ijhydene.2014.08.022>.
- Li, C., Fang, H.H.P., 2007. Fermentative hydrogen production from wastewater and solid wastes by mixed cultures. *Rev. Environ. Sci. Biotechnol.* 37, 1–39. <https://doi.org/10.1080/10643380600729071>.
- Li, Y., et al., 2013. Efficient production of polymer-grade D-lactate by *Sporolactobacillus laevolacticus* DSM442 with agricultural waste cottonseed as the sole nitrogen source. *Bioresour. Technol.* 142, 186–191. <https://doi.org/10.1016/j.biortech.2013.04.124>.
- Liu, X., et al., 2011. Identification of a N-terminal formylated, two-peptide bacteriocin from *Enterococcus faecalis* 710C. *J. Agric. Food Chem.* 59, 5602–5608. <https://doi.org/10.1021/jf104751v>.
- Marone, A., et al., 2014. Vegetable waste as substrate and source of suitable microflora for bio-hydrogen production. *Renew. Energy* 68, 6–13. <https://doi.org/10.1016/j.renene.2014.01.013>.
- Minón-Fuentes, R., Aguilar-Juárez, O., 2019. Hydrogen production from coffee pulp by dark fermentation. *Water Sci. Technol.* 80, 1692–1701. <https://doi.org/10.2166/wst.2019.416>.
- Noblecourt, A., et al., 2018. Hydrogen production by dark fermentation from pre-fermented depackaging food wastes. *Bioresour. Technol.* 247, 864–870. <https://doi.org/10.1016/j.biortech.2017.09.199>.
- Özgür, E., Peksel, B., 2013. Biohydrogen production from barley straw hydrolysate through sequential dark and photofermentation. *J. Clean. Prod.* 52, 14–20. <https://doi.org/10.1016/j.jclepro.2013.02.035>.
- Petrosyan, H., et al., 2020. Roasted coffee wastes as a substrate for *Escherichia coli* to grow and produce hydrogen. *FEMS (Fed. Eur. Microbiol. Soc.) Microbiol. Lett.* 367, fnaa088 <https://doi.org/10.1093/femsle/fnaa088>.
- Renaudie, M., et al., 2020. Biohydrogen production in a continuous liquid/gas hollow fiber membrane bioreactor: efficient retention of hydrogen producing bacteria via granule and biofilm formation. *Bioresour. Technol.* 319, 124203 <https://doi.org/10.1016/j.biortech.2020.124203>.
- Renaudie, M., et al., 2021b. Intensification and optimization of continuous hydrogen production by dark fermentation in a new design liquid/gas hollow fiber membrane bioreactor. *Chem. Eng. J.* 416, 129068 <https://doi.org/10.1016/j.cej.2021.129068>.
- Renaudie, M., et al., 2022. New way of valorization of raw coffee silverskin: biohydrogen and acetate production by dark fermentation without exogenous inoculum. *Bioresour. Technol. Rep.* 17, 100918 <https://doi.org/10.1016/j.biteb.2021.100918>.
- Rubiano-Labrador, C., et al., 2013. *Caloramator quimbayensis* sp. nov., an anerobic, moderately thermophilic bacterium isolated from a terrestrial hot spring. *Int. J. Syst. Evol. Microbiol.* 63, 1396–1402. <https://doi.org/10.1099/ijs.0.037937-0>.
- Saraphirom, P., Reungsang, A., 2011. Biological hydrogen production from sweet sorghum syrup by mixed cultures using an anaerobic sequencing batch reactor (ASBR). *Int. J. Hydrogen Energy* 36, 8765–8773. <https://doi.org/10.1016/j.ijhydene.2010.08.058>.
- Tabachnick, J., Vaughn, R.H., 1948. Characteristics of tartrate-fermenting species of *Clostridium*. *J. Bacteriol.* 56, 435–443. <https://doi.org/10.1128/jb.56.4.435-443.1948>.
- Trad, Z., et al., 2015. Development of a submerged anaerobic membrane bioreactor for concurrent extraction of volatile fatty acids and biohydrogen production. *Bioresour. Technol.* 196, 290–300. <https://doi.org/10.1016/j.biortech.2015.07.095>.