



HAL
open science

Hands-on Techno Economic Assessment: HTS cable system

Andrea Musso, Loïc Quéval

► **To cite this version:**

Andrea Musso, Loïc Quéval. Hands-on Techno Economic Assessment: HTS cable system. École thématique. 3rd Training School of the Hi-SCALE COST Action 19108, Belgrade, Serbia. 2024. hal-04543739

HAL Id: hal-04543739

<https://hal.science/hal-04543739v1>

Submitted on 12 Apr 2024

HAL is a multi-disciplinary open access archive for the deposit and dissemination of scientific research documents, whether they are published or not. The documents may come from teaching and research institutions in France or abroad, or from public or private research centers.

L'archive ouverte pluridisciplinaire **HAL**, est destinée au dépôt et à la diffusion de documents scientifiques de niveau recherche, publiés ou non, émanant des établissements d'enseignement et de recherche français ou étrangers, des laboratoires publics ou privés.

Hands-on Techno Economic Assessment: HTS cable system

Andrea Musso³, Lo c Qu eval^{1,2}

¹ University of Paris-Saclay, CentraleSup lec, CNRS, Group of electrical engineering - Paris, 91192, Gif-sur-Yvette, France

² Sorbonne University, CNRS, Group of electrical engineering - Paris, 75252, Paris, France

³ Ricerca Sistema Energetico – RSE S.p.A., 20134 Milan, Italy



Hi-SCALE



cost
EUROPEAN COOPERATION
IN SCIENCE & TECHNOLOGY

Content

- I. Case study
- II. TEA of conventional cable system
- III. TEA of HTS cable system
 1. Phase 1
 2. Phase 2
 3. Phase 3
 4. Phase 4
- IV. To go further

I. Case study

TEA on HTS cables → Line main features (case study)

Proposal: connect *Al Dhafra* photovoltaic plant with Abu Dhabi (e.g. its international airport).

Completed in 2023, *Al Dhafra* is the largest single-site solar PV power plant in the world (and the 3^o in the world overall). More than 4 million PV modules involved



TEA on HTS cables → Line main features (case study)

Proposal: connect *Al Dhafra* photovoltaic plant with Abu Dhabi (e.g. its international airport).

Al Dhafra Solar Project:

- **2 GW** produced.
- The plant is located about 30 km south of Abu Dhabi.
- The project includes 33/400 kV substations to connect the plant with 400 kV "conventional" overhead cables.
- **Could part of these conventional connections be replaced with a 33 kV HTS underground cable not requiring transformers and overhead cables into the highly urbanized area of Abu Dhabi?**



TEA on HTS cables → Line main features (case study)

Proposal: connect *Al Dhafra* photovoltaic plant with Abu Dhabi (e.g. its international airport).

Al Dhafra Solar Project:

- **2 GW** produced.
- The plant is located about 30 km south of Abu Dhabi.
- The project includes 33/400 kV substations to connect the plant with 400 kV "conventional" overhead cables.
- **Could part of these conventional connections be replaced with a 33 kV HTS underground cable not requiring transformers and overhead cables into the highly urbanized area of Abu Dhabi?**



Let's suppose we are going to substitute conventional cables for 1.5 GW, using HTS cables (2 HTS cables of 750 MW each).



TEA on HTS cables → Line main features (case study)

Technical model – Main features		
<i>Property</i>	<i>Symbol</i>	<i>Value</i>
Total power	P_{tot}	1.5 GW
Voltage rms	V_{rms}	33 kV
Load factor	$\cos\varphi$	0.95
Line length	L_{line}	32 km

II. TEA of conventional cable system

Hands-on !

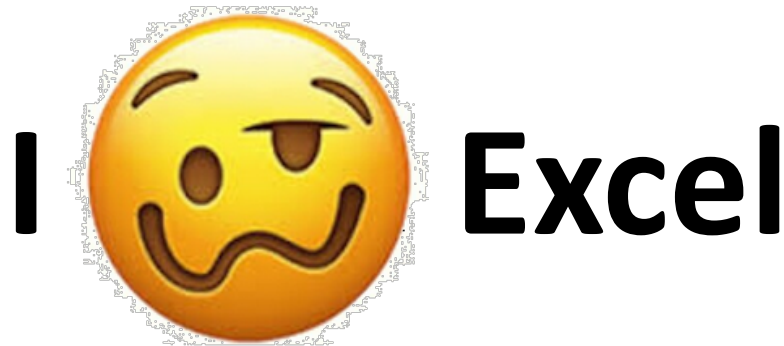

III. TEA of HTS cable system

Content

- ❑ Overview of HTS cable architectures
- ❑ The selected architecture
- ❑ HTS cable system components
- ❑ **Hands-on TEA for HTS cables**
 - The approach
 - Computing cable design
 - Computing losses
 - Computing constraints
 - **Computing the economic parameters**
 - Interpreting the results

Overview of HTS cable architectures

Warm Dielectric (WD) vs Cold Dielectric (CD)

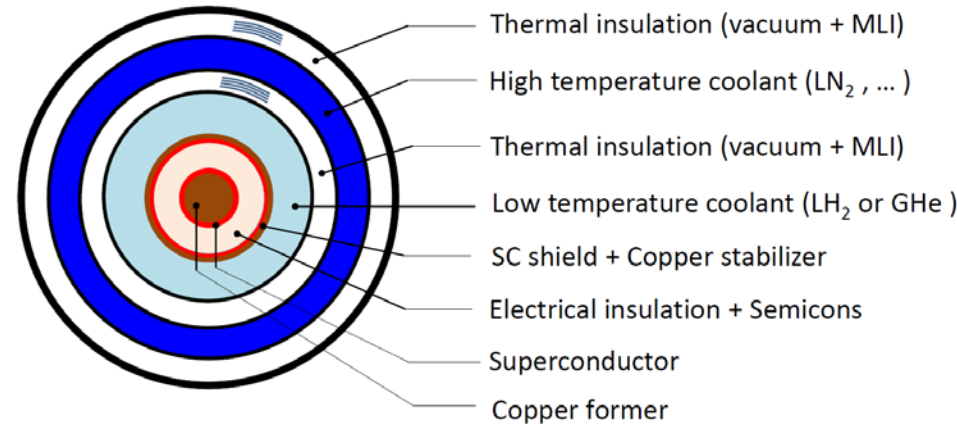
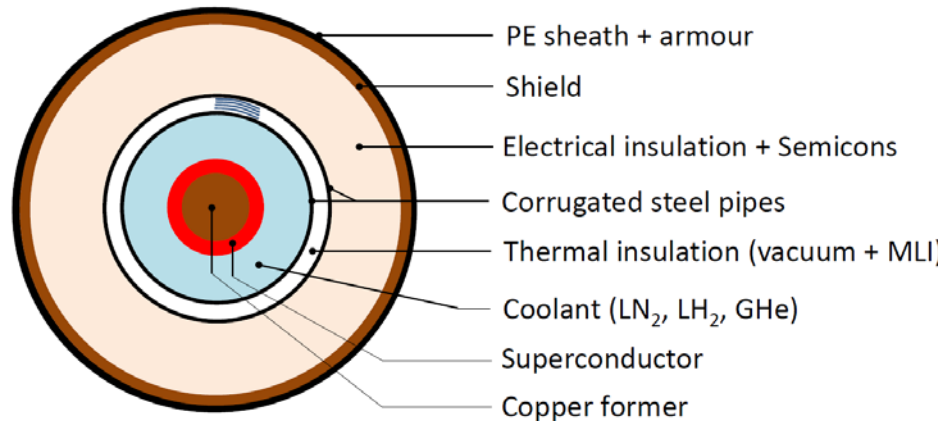

- ❑ The CD configuration makes it easier to access the cryostat, as it is electrically insulated from the conductive phases.
- ❑ Designing a CD cable is a complex task due to the number of components at cryogenic temperatures (terminations, joints, electrical insulation, etc.).
- ❑ Most superconducting cable prototypes proposed in the last years were designed using the CD configuration.

Overview of HTS cable architectures

Single core vs 3-in-1 cores vs Concentric

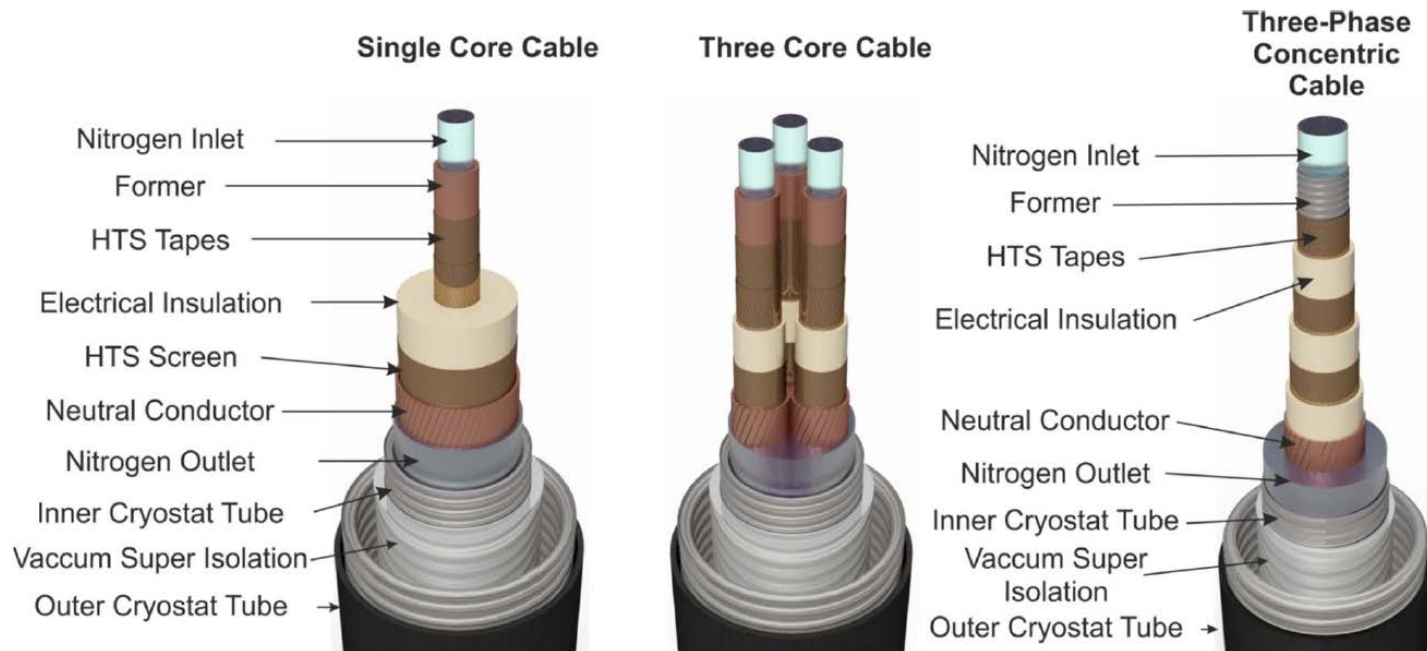

- ❑ If the 3 phases of the concentric configuration are balanced, the magnetic field outside the phases can be greatly reduced without the need of a superconducting shield [3, 23]. The amount of superconductor needed is thus reduced.
- ❑ The concentric configuration is more compact and thus suited to be contained in the tunnels made for conventional lines, thus facilitating their retrofitting.

phases

cryogenic envelope

Source: Nexans

Over architectures

Single

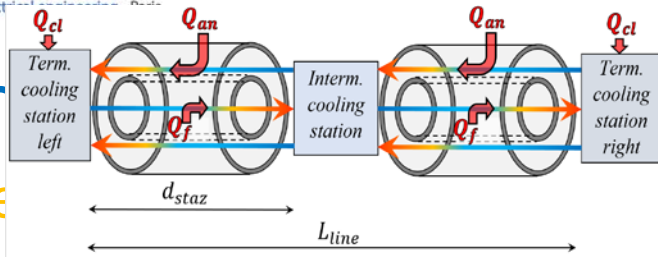

ds

- ❑ Managing 2 coolant flows introduces more complexity in cable manufacturing/design.
- ❑ Considering 2 flows improves the capability of uniformly cooling the superconductor.
- ❑ A forward and a return flows of coolant (*Both-sided cooling option*) do not require any external return → more compact system, but each cooling/pumping station has to manage 2 coolant flows in opposite directions.
- ❑ Potentially, the 2 different coolants could be involved (e.g. GHe in the inner channel and LN2 in the outer channel).

Cooling option 1 single-sided cooling with internal coolant return flow

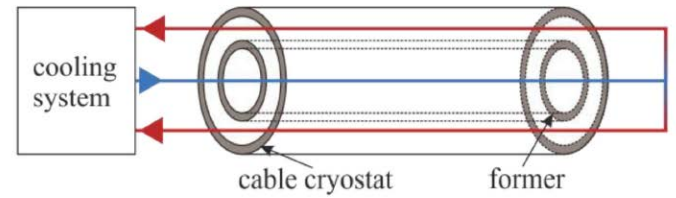

Cooling option 2 single-sided cooling with external coolant return flow with annular gap cooling

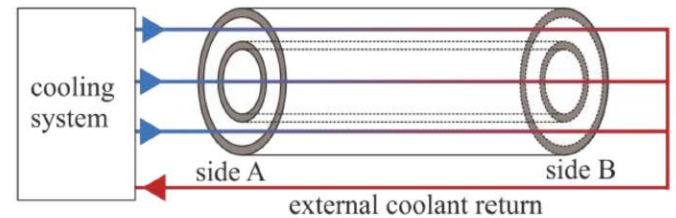

Cooling option 3 single-sided cooling with external coolant return flow without annular gap cooling

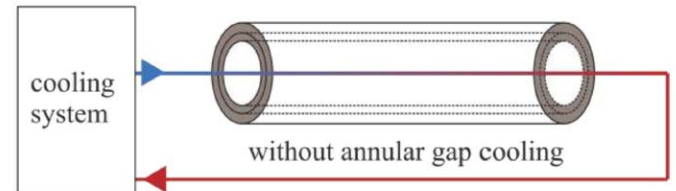

Cooling option 4 both-sided cooling

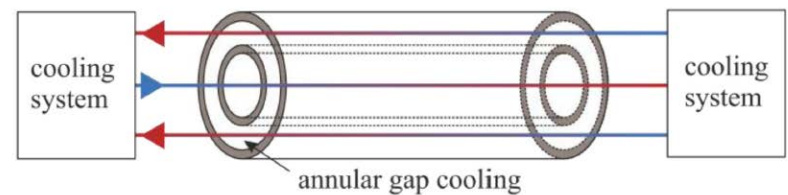

HTS

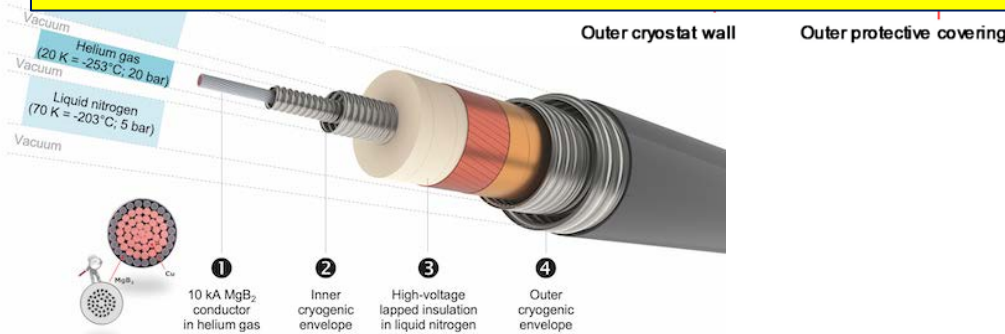

Overview of HTS cable architectures

HTS (AC) vs MgB₂ (DC)

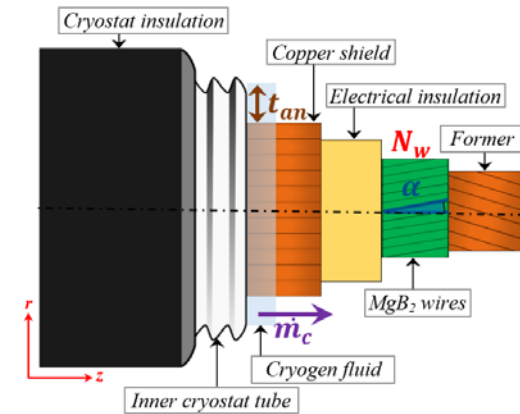
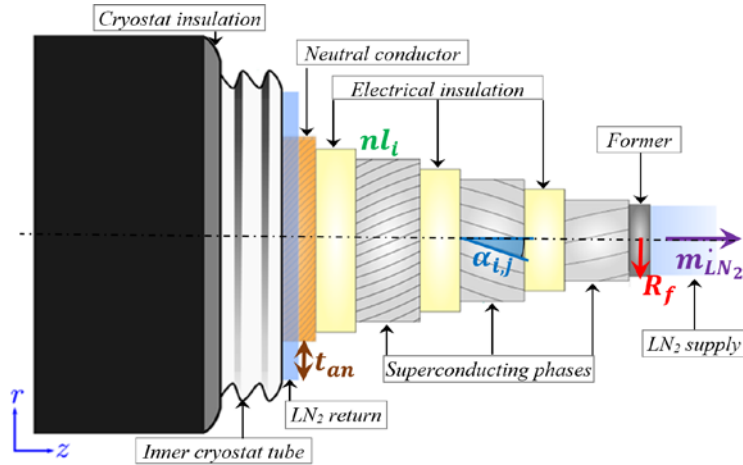

Q_{cl} Q_{coun} Q_{cryo} n_{stat} Q_{coun} Q_{cryo} Q_{cl}

- ❑ MgB₂ manufacturing costs are relatively low compared to HTS tapes (10 – 15 times cheaper).
- ❑ MgB₂ wires are notoriously more subject to high AC losses, and thus their use is almost always limited to DC applications (DC cables).

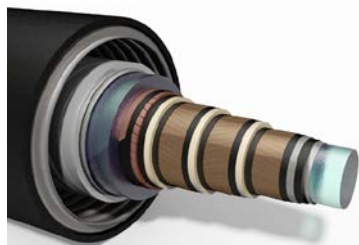

Source: Metox



Source: Kiswire-KAT

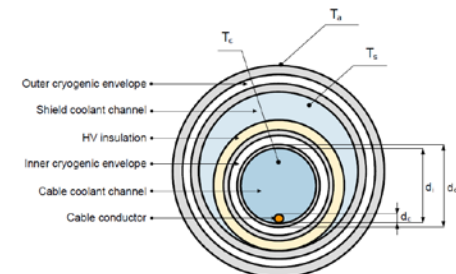

Overview of HTS cable architectures

In the last 20 years, over 20 prototypes have been developed and installed around the world, with:

- ☐ 30 m < lengths < 1.5 km
- ☐ 10 MW < powers < 1 GW
- ☐ 10 kV < voltages < 275 kV

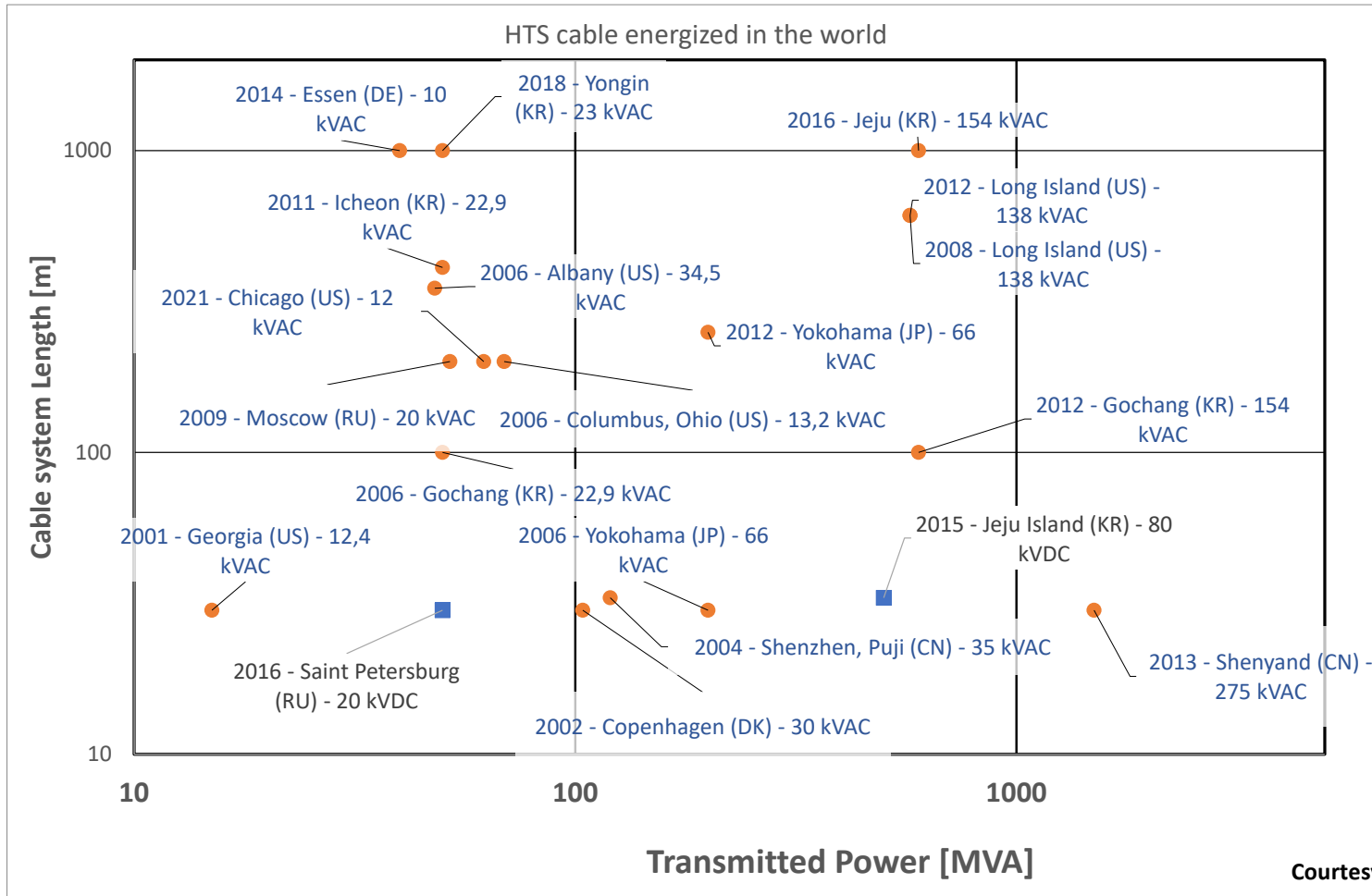

Architecture selected

- CD configuration
- Coaxial configuration
- HTS AC cable
- Double-sided cooling option

Assumption → the cable is **modular**

- The configuration/geometry of each conductor segment included between adjacent cooling stations is the same.
- Even the thermodynamic properties of the coolants at the ends of each segment are the same (note that there are 2 counter-flows)

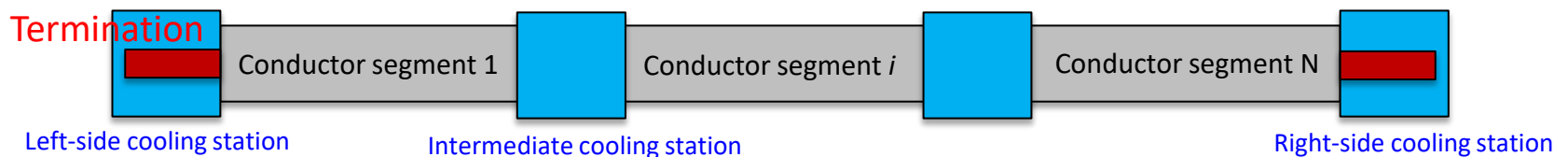

Architecture selected



Superconducting Cables

Prof. Dr.-Ing. Mathias Noe, Karlsruhe Institute of Technology

Institute for Technical Physics

EUCAS Short Course Power Applications, September 17th 2017, Geneva

KIT-ZENTRUM ENERGIE



KIT – Die Forschungsuniversität in der Helmholtz Gemeinschaft

www.kit.edu

[4]

Architecture selected

General Setup - Former

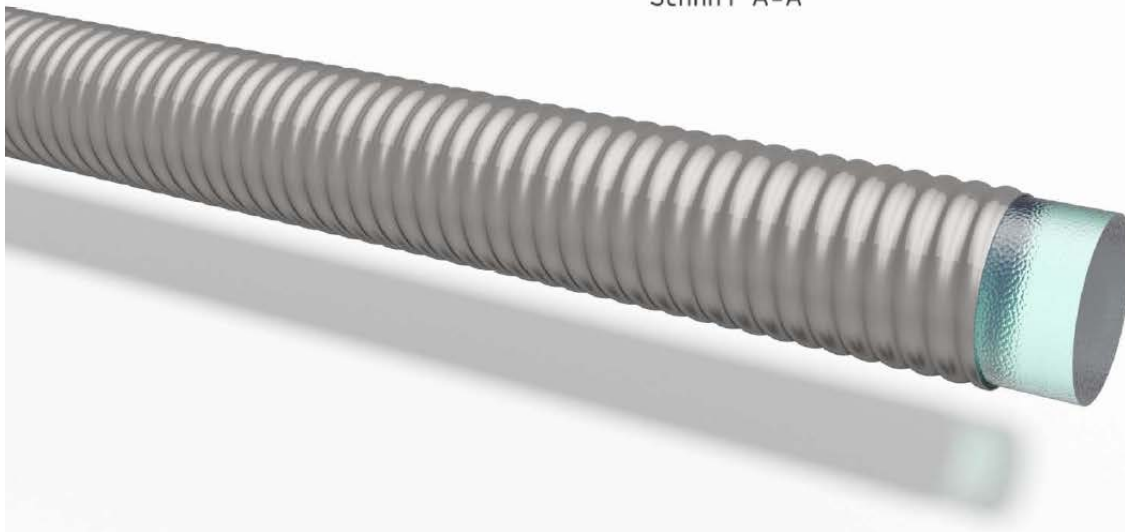
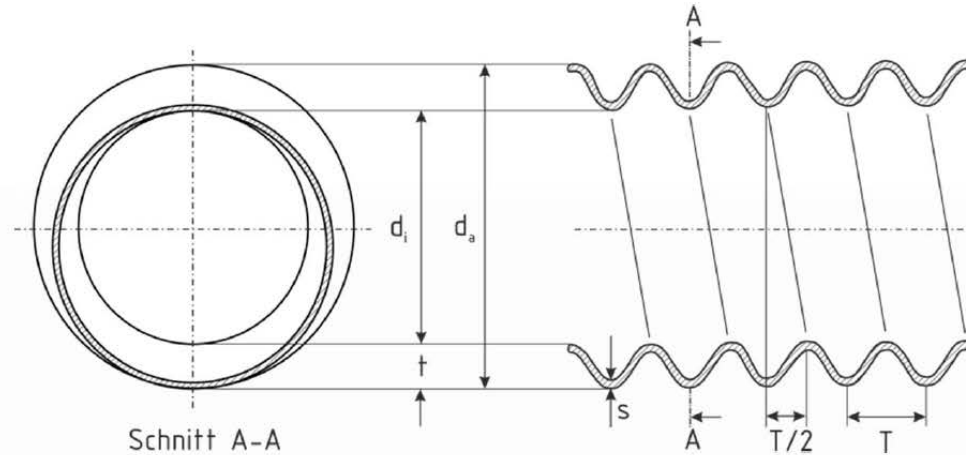

Architecture selected

General Setup – HTS Conductor



Architecture selected

General Setup – Dielectric Insulation

Polypropylene Laminated Paper (PPLP)

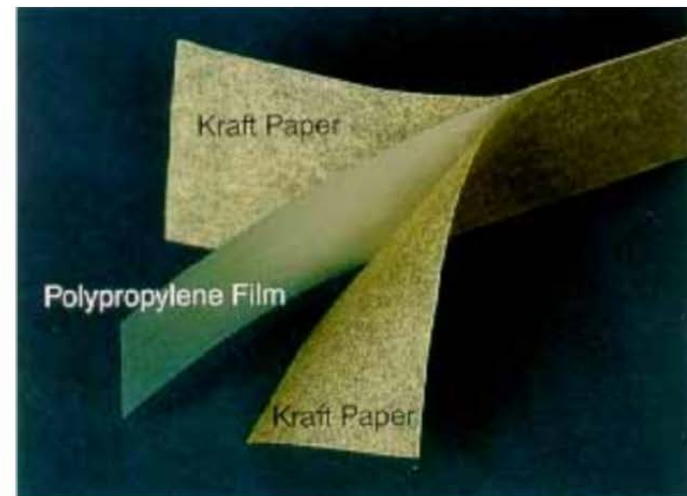

Architecture selected

General Setup – Three coaxial phases



Architecture selected

General Setup – Copper Neutral Conductor

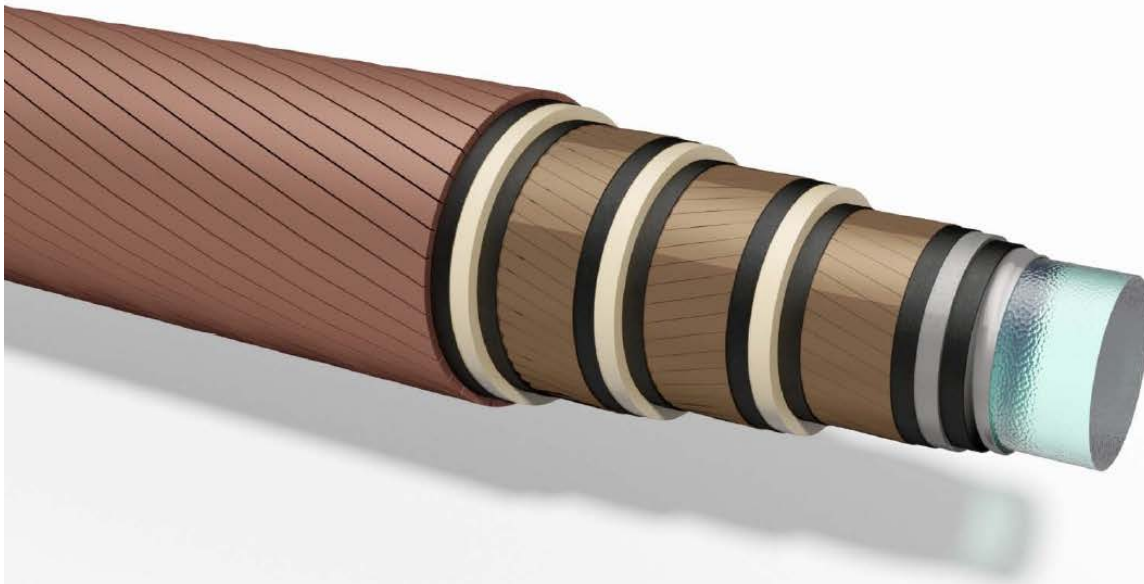

Architecture selected

General Setup – Cryostat

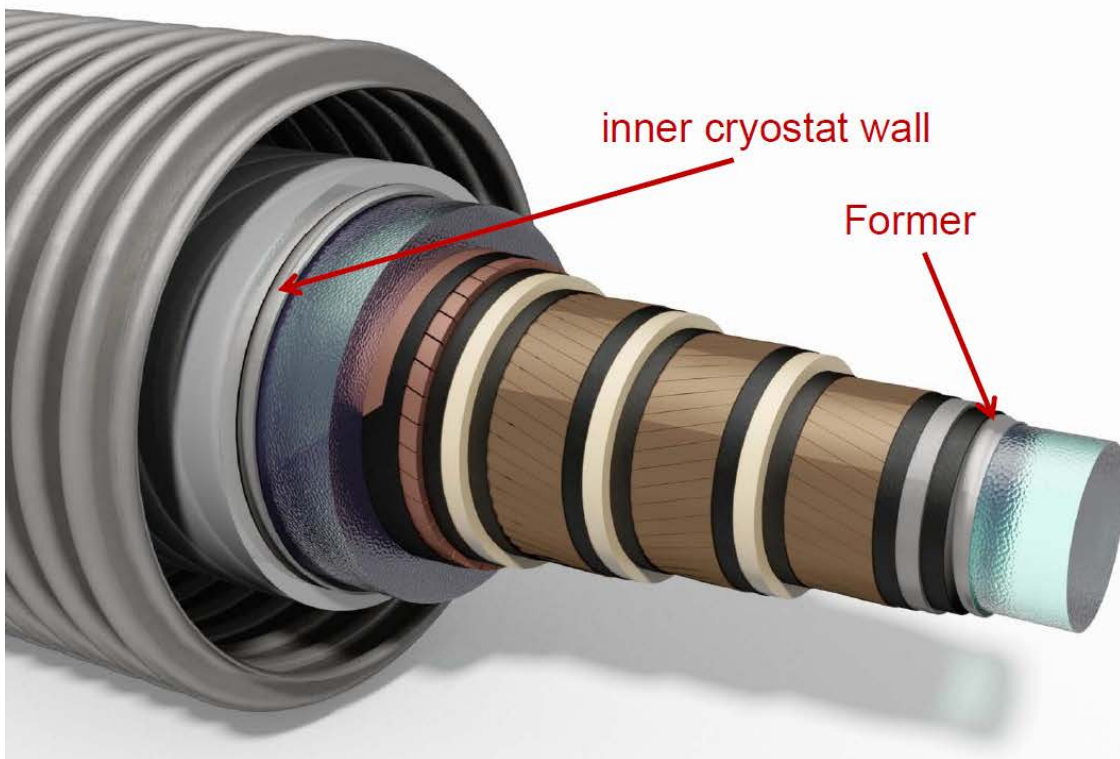

Architecture selected

General Setup – Outer Protection, extruded PE

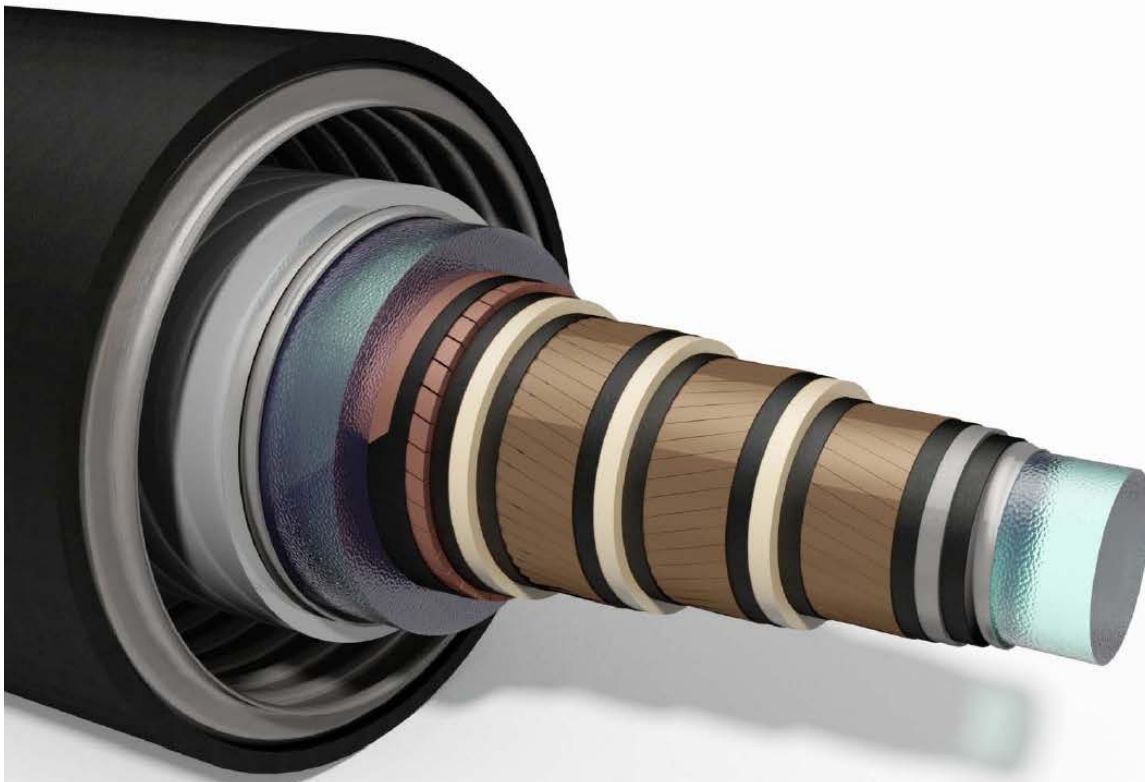

HTS system components - conductor

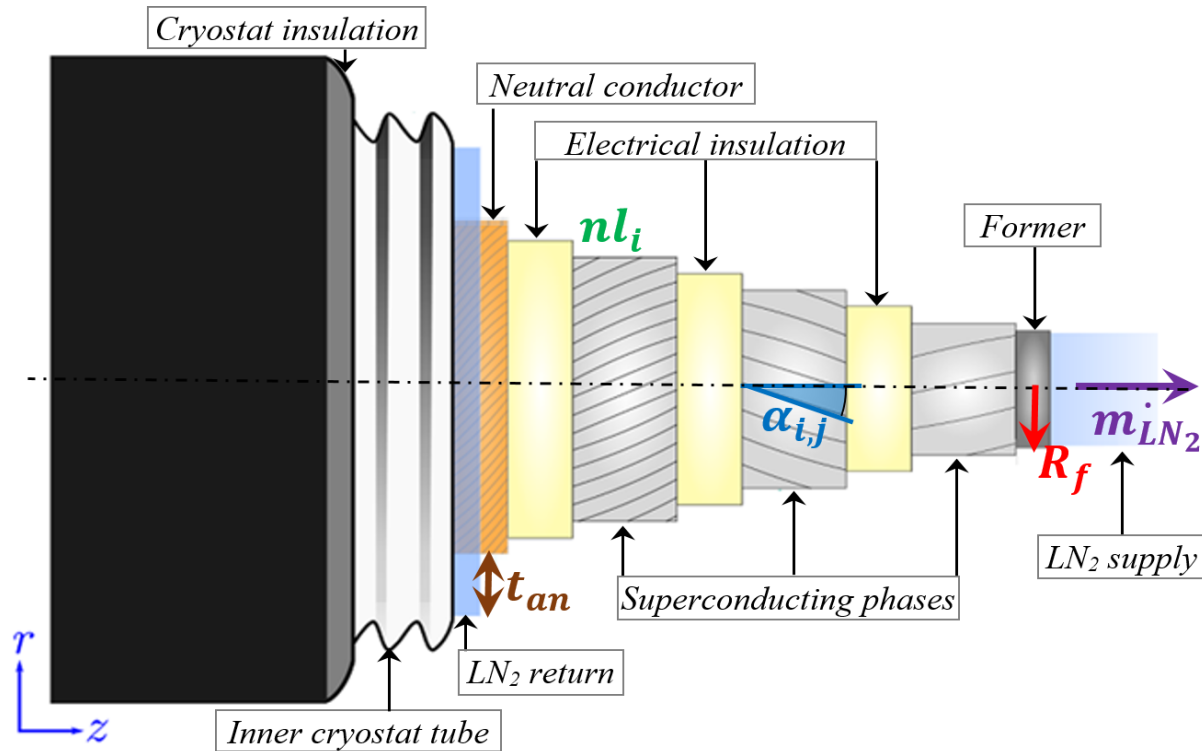

[5]

HTS system components - conductor

HTS tapes

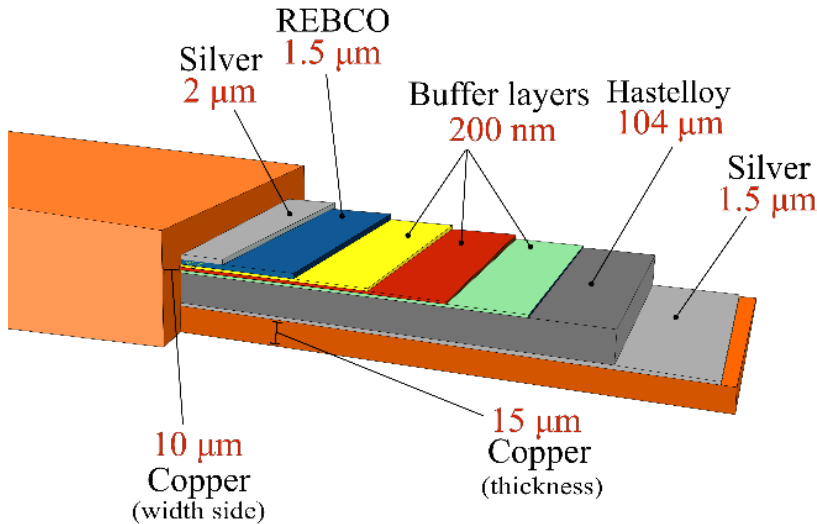

Tape selected for this study: **SuNAM SCN04150 tape**

- Very high current carrying capacity with minimal losses.
- Very high cost compared to traditional conductors.
- Electrical properties strongly dependent on temperature/magnetic field.
- Mechanical properties makes their handling complex (not considered in today's study).

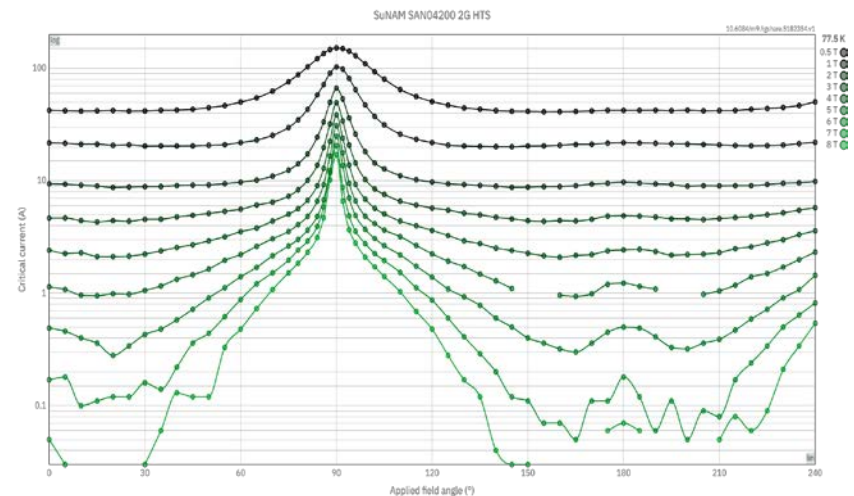
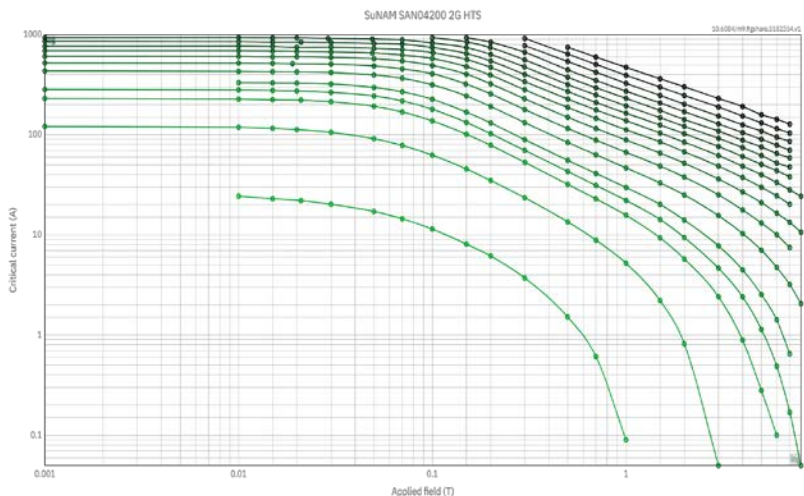

HTS system components - conductor

Cryogenic insulation (CD)

❑ DC cables

- Kraft paper → Dielectric strength = 25 ~ 50 kV/mm and $\epsilon_r = 2 \sim 5$

❑ AC cables

- PolyPropylene Laminated Paper → Dielectric strength = 40 ~ 50 kV/mm and $\epsilon_r = 2.2$

- ❑ LN2 under 5 ~ 10 bar → Dielectric strength 40 ~ 80 kV/mm (pressure dependant) and $\epsilon_r = 1.4$. Avoid bubbles: in GN2 the dielectric strength is only 2 ~ 3 kV/mm.

- ❑ Other dielectric materials have been considered in different publications: Kapton, XLPE, Cryoflex (by ULTERA), Tyvek/PE, Teflon.



Condition: LN ₂ (T = 77 K)	PPLP	Tyvek/PE
ϵ_r	1.90	1.73
$\tan\delta$	0.00058	0.00013

[3]

[2]

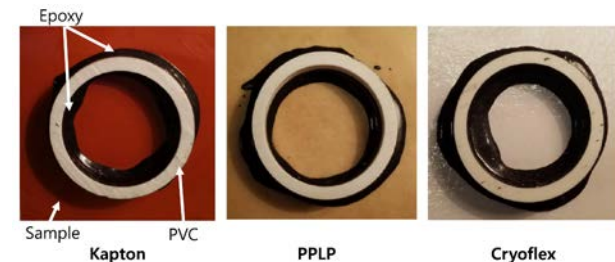

HTS system components - conductor

Cryogenic insulation (CD)

- ❑ **PolyPropylene Laminated Paper (PPLP)** has been widely used for HV power cables due to its excellent electrical and mechanical performances.
- ❑ Its use for power cable insulation can be traced back to 1970's, initially for HVAC cables but extended to HVDC cables and superconducting.

[1]

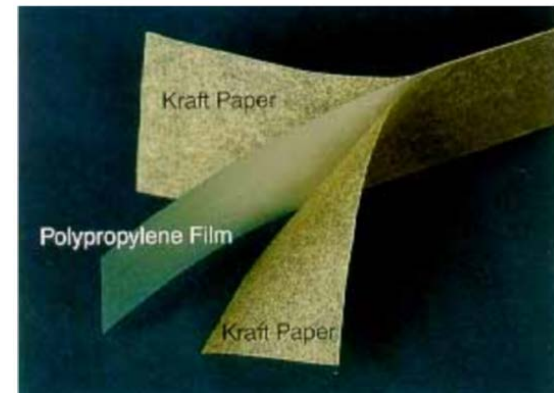
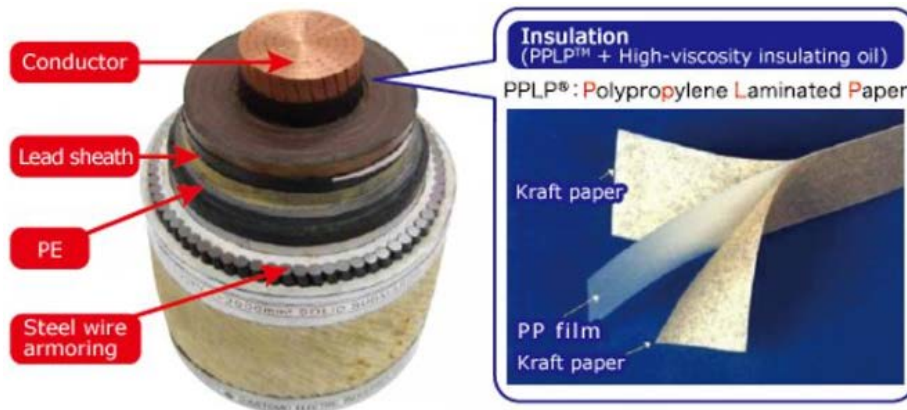

- ❑ Reliable hybrid insulation systems based on pressurized liquid nitrogen and polypropylene laminate paper (PPLP).

HTS system components - conductor

Cryostat

The cryostat contains the cable and (above all) the coolant, reducing the heat exchange with the outside.

It includes (inner to outer): **Inner cryogenic tube** → **Vacuum space** → **MLI** → **Outer cryostat** → **Jacket**

Single envelope vs **double envelope** (2 different fluids/temperatures) cryostat



Simple envelope

1. Corrugated inner tube
2. Low-loss spacer
3. Vacuum space
4. Multilayer superinsulation
5. Corrugated outer tube
6. PE jacket (optional)



Double envelope with thermal shield for MgB₂



Laying of the AC HTS cable into its flexible cryostat for the Ampacity project.

Flexible (easier to transport/laying) vs **rigid** (lower thermal losses) cryostat

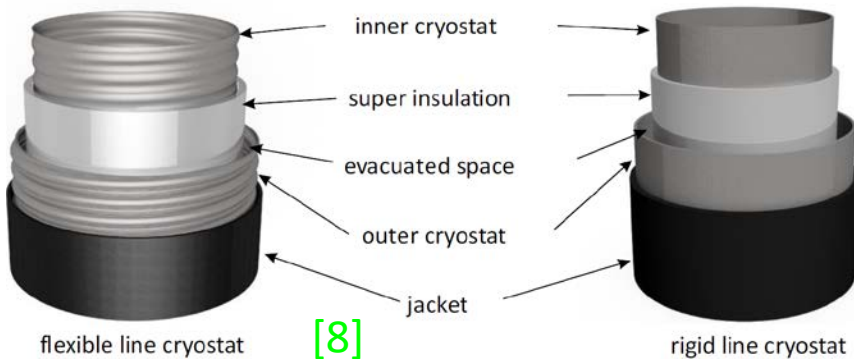

flexible line cryostat

[8]

rigid line cryostat

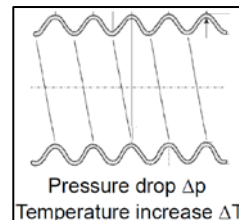

[7]

HTS system components - conductor

Cryostat

The cryostat contains the cable and (above all) the coolant, reducing the heat exchange with the outside.

It includes (inner to outer): **Inner cryogenic tube** → **Vacuum space** → **MLI** → **Outer cryostat** → **Jacket**

Single envelope vs **double envelope** (2 different fluids/temperatures) cryostat



Simple envelope

1. Corrugated inner tube
2. Low-loss spacer
3. Vacuum space
4. Multilayer superinsulation
5. Corrugated outer tube
6. PE jacket (optional)



Double envelope with thermal shield for MgB₂



HTS coaxial cable installation for the AEP Bixby project. The white cable on the drum is the superconductor and dielectric portion being fed into the black cryostat and outer jacket.

Flexible (easier to transport/laying) vs **rigid** (lower thermal losses) cryostat

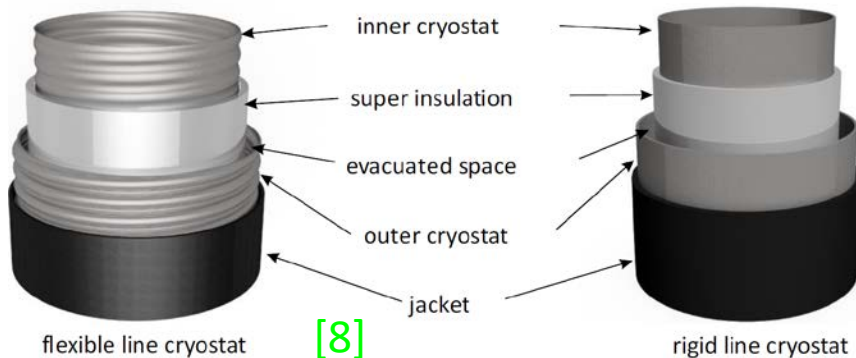

flexible line cryostat

[8]

rigid line cryostat

[7]

HTS system components - conductor

Cryostat

Corrugation of tubes (Flexibility)

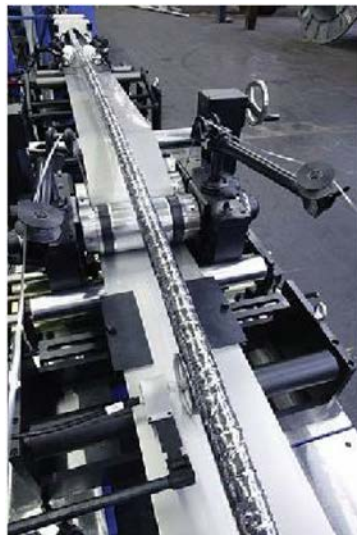
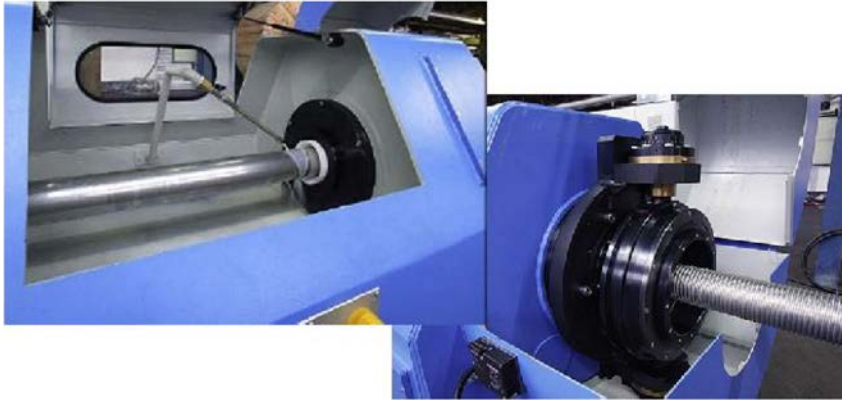

Outer tube shaping and welding process



Thermal insulation process



Ultra-sonic cleaning



Super insulation laying

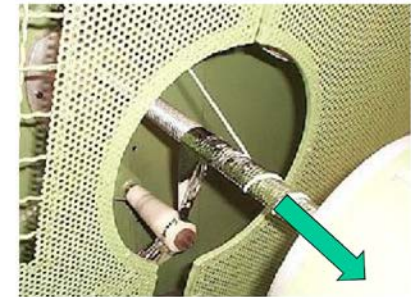

Spacer

Nexans

Introduction to superconducting power cable systems

CE BRUZEK
Nexans France

ESAS Summer school - 8-14 June 2016

HTS system components – cooling system

Purpose of the cooling system:

- ❑ Ensure that the temperature of the HTS tapes is kept within the design limits by fluid cooling;
- ❑ Restore the temperature and pressure conditions of the coolants to their initial levels after their rise/drop occurring in each cable section (**avoid phase transition!**);
- ❑ Handle the coolants circulation at a given mass flow rate.

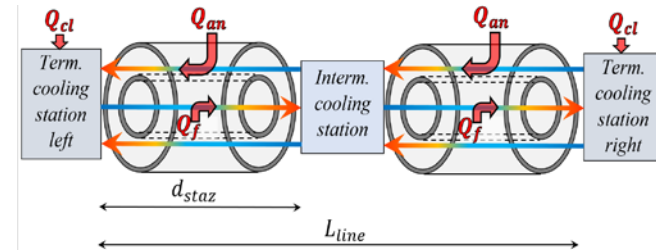

Refrigeration system: Typical cooling system for an HTS power cable system

- ❑ Cooling machines and pumps have their own efficiency.
- ❑ The ideal efficiency of cooling machines (Carnot) depends on the operating temperature. To extract the same amount of power but at lower temperatures, more electrical power is required.
- ❑ The real efficiency of cooling machines is significantly lower than the ideal one (7 ~ 10 times lower).



T_{out}, P_{out}

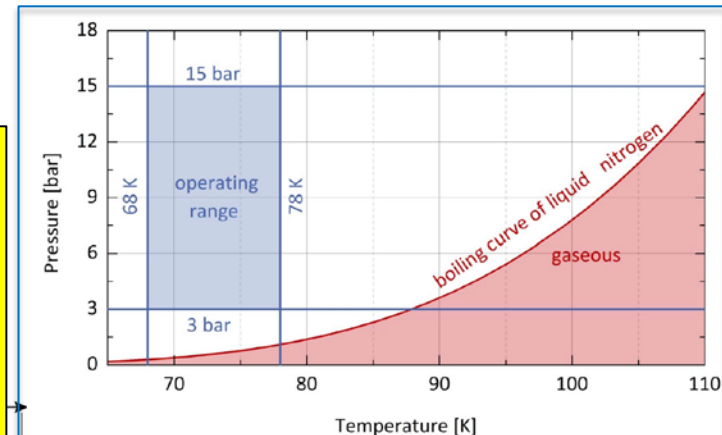

For LN2, the transition to gas phase would greatly affect its heat exchange efficiency and its dielectric properties. To ensure that no boiling phenomena occur in the whole cable length, the LN2 usually enters the cable in subcooled conditions (T & P).

HTS system components – cooling system

An HTS cable cooling system is a combination of two separate loops:

- One closed-loop consisting of LN2 circulated inside the cable cryostat and terminations to cool the cable system.
- One loop is part of the refrigerator itself (open or **closed**)



Turbo-Brayton machines: from 5kW to 30 kW at 70K and up to 5 kW at 20K

Gifford Mc-Mahon machines: up to 500W at 70K and 60W at 20K

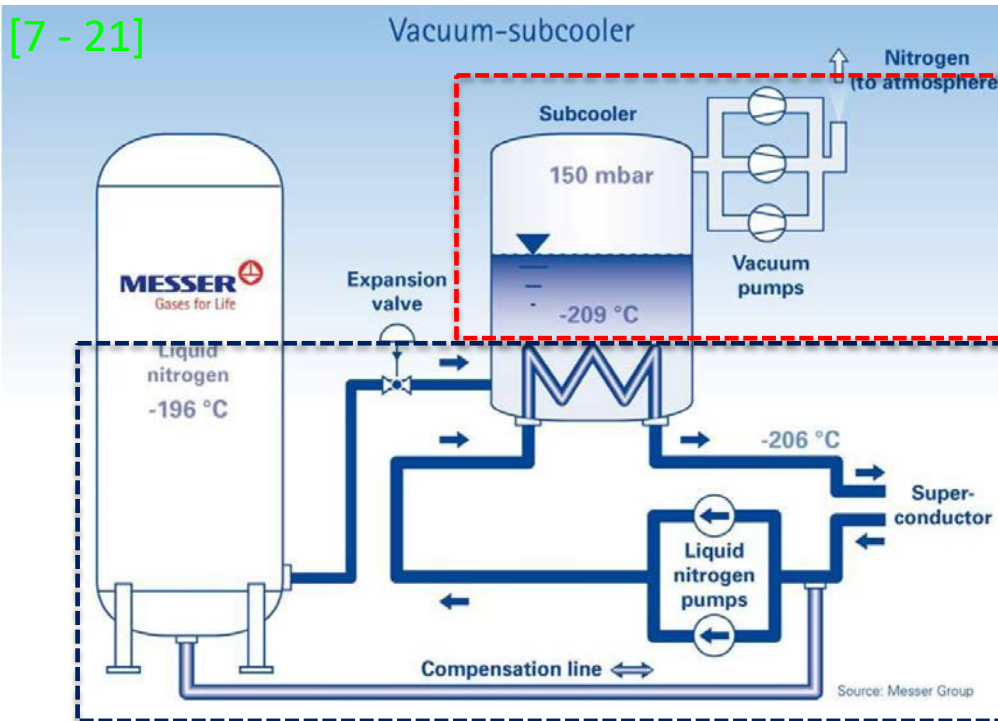

Cooling unit for the AmpaCity project

Comparison among different cryogenic refrigeration technologies

	Reverse-Brayton	Turbo-Brayton	Stirling cryogenerator
Technology	Existing and proven technology	To be developed	Proven but old technology
Power consumption per cold watts	1 W _{cold} /23.2 W _{electric}	1 W _{cold} /11.6 W _{electric}	1 W _{cold} /18.3 W _{electric}
Carnot efficiency	~ 15%	>30%	~ 19%
Capital cost	High	High	Medium
Availability	High	Very high	High
Chilled water	Not required	Required	Required
Redundancy	Component level	System level	Component level
Maintenance	Medium (annual)	Low (several years)	High (6000 h)
Footprint	Medium	Small	Large

HTS system components – terminations

HTS cable terminations are the links between the conventional power grid at T_{amb} and a superconducting cable at cryogenic temperature.

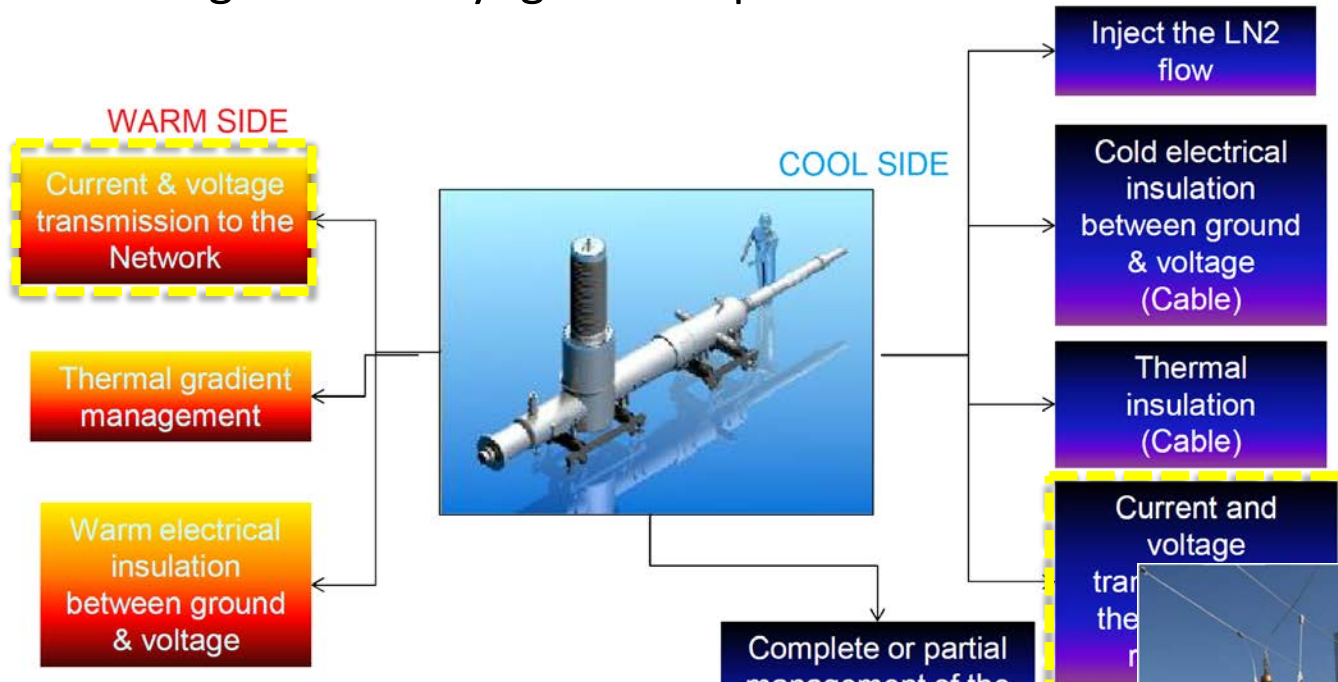

Rollers along the termination for Albany project

[7]

Nexans
Introduction to superconducting power cable systems
CE BRUZEK
Nexans France
ESAS Summer school – 8-14 June 2016

Once cooled, the core of a 1 km HTS cable contracts by about 3 m compared to its outer room-temperature jacket → movable terminations are adopted to handle such contraction.

HTS system components – terminations

1-stage terminations:

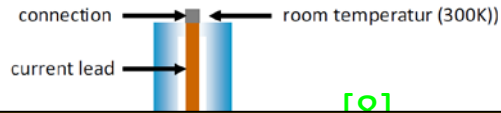

The termination cryostat is very similar to a conventional horizontal cryogen storage tank (vacuum + MLI).

- For a single-core AC HTS cable configuration, each termination has its own cryostat (as the 3 phases).
- For a 3-in-1 or coaxial cable design all three terminations share one cryostat.



[7]

III. TEA of HTS cable system

Phase 1 – Goal and scope definition

III. TEA of HTS cable system

Phase 2 – Inventory analysis

TEA on HTS cables → The approach

The cable system is addressed as an **economic model** and a **technical model**.

Different levels of detail can be applied.

VERY broad

Economic model

LCC (€ or €/km)

Little (optional) extra step:
total CAPEX and OPEX (or OPEX_{year})



From manufacturer or literature, once the characteristics of the line are set (e.g. length, size, cable type).

$$LCC = CAPEX + \sum_{t=1}^{years} \frac{OPEX_{year}}{(1+r)^t}$$



Technical model

Basic data for the cable representation in an equivalent circuit of the grid (e.g. voltage level and power selected, AC or DC?, equivalent resistance...)

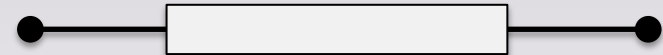

TEA on HTS cables → The approach

The cable system is addressed as an **economic model** and a **technical model**.

Different levels of detail can be applied.

A little more specific

Economic model

Distinguish different CAPEX and OPEX terms

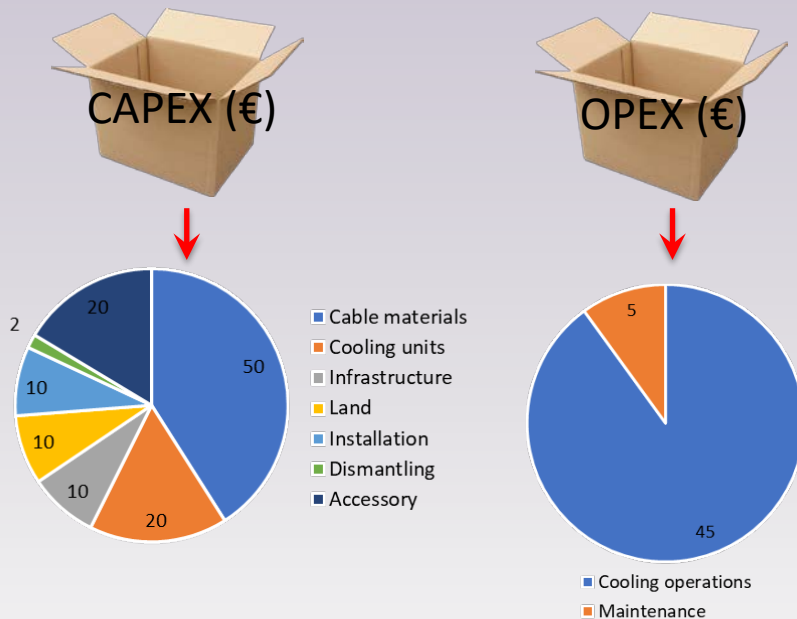

Technical model

- Evaluate substituting one components with another (*e.g.* conductor, cooling station...) based on their technical properties and costs.
- Some terms may be available from the literature as parameterized functions depending on the line's features (*e.g.*, cooling costs based on cable power, land costs contingent upon the installation site...).

The terms are in € or €/km, from manufacturer or literature.

TEA on HTS cables → The approach

The cable system is addressed as an **economic model** and a **technical model**.

Different levels of detail can be applied.

Thoroughly detailed

Economic model

The single CAPEX and OPEX terms are expanded
(not necessarily all of them)

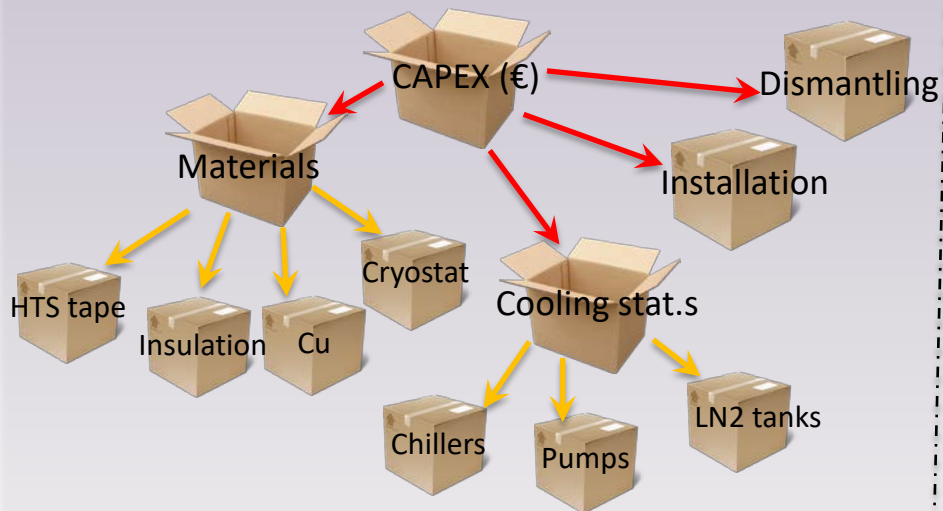

Some cost terms are "simply" parameterized to the main cable features, others are based on the cable design (in combination with the technical model).



Technical model

For each term to expand, it is required to know:

- Properties of the materials/components involved;
- Relationships between the properties and the line features to compute the necessary quantities (simplifying assumptions are generally applied);
- Eventual operating constraints establishing the limits for each material/component quantity.

e.g. HTS tapes)

- HTS tape properties → $I_c(T, |B|, \vartheta)$, geometry...
- Quantity → cable length, cable current...

- Constraints → $\begin{cases} [I_{tape}/I_c]_{min}^{max} \\ \text{Geometrical (cable layers dimensions, twist angle...)} \\ \text{Economic (reduce AC losses to reduce OPEX ...)} \end{cases}$

TEA on HTS cables → The approach

The cable system is addressed as an **economic model** and a **technical model**.

Different levels of detail can be applied.



When should we stop going further in detailing (term by term)?

- When specific data, such as costs and properties of sub-components, are no longer accessible.
- When we recognize that a greater detail would not produce a significant change in the results.
- When we assess that the effort or calculation time are no longer comparable with our aims. For instance: are we grid managers seeking to evaluate multiple cable technologies for broad applications? Or are we manufacturers aiming to optimize costs for a particular case study involving a specific cable architecture?

TEA on HTS cables → The workflow

Inventory analysis phase

1) Collect INPUT Data:

- Select the case study
- Have the equations for economic and technical models available
- Select the constraints

2) Set some (or all) parameters of the cable design
(e.g. R_{former} , n_{stat} , m_{LN2} , $t_{annulus}$, n_{l_i} , $\alpha_{i,j}$)

Cable design phase

3) Compute the cable design in cascade

4) Compute the cable system losses

3-bis) Alternatively, the full design complying with the constraints, as well as the losses, are provided to you without calculations.

5) Verify if the cable design complies with the constraints

no

Change the parameters originally selected

yes

Calculation of indicators phase

6) Compute CAPEX, OPEX and LCC

Interpretation phase

Interpreting the results

Interested to parametric analyzes?

yes

Phase 3

TEA on HTS cables → The workflow in our Excel file

Inventory analysis phase

Look at the Excel sheet called:
1-Goal and scope definition

Use the Excel sheet called:
2-Inventory analysis-HTS

Cable design phase

Calculate cable design, losses and constraints using the Excel sheet called:
3.0-HTS Cable design

Use the Excel sheet called:
3-Calculation of indicators-HTS

Calculation of indicators phase

Interpretation phase

Use the Excel sheet called:
4-Interpretation

Interested to
parametric analyzes?

yes

Change the
parameters originally
selected

Phase 3

TEA on HTS cables → Input data

What we need to know to start the study:

➤ Line main features

- Voltage level and power to be transferred
- Line length
- Cable architecture (DC or AC? Coaxial? Cold dielectric?)

➤ A clear idea of the terms composing CAPEX and OPEX

- Materials/sub-components properties (technical and economic)

➤ What are the constraints

TEA on HTS cables → Where to find information

Industrial Consultant

Literature

Specialists

TEA on HTS cables → Line main features (case study)

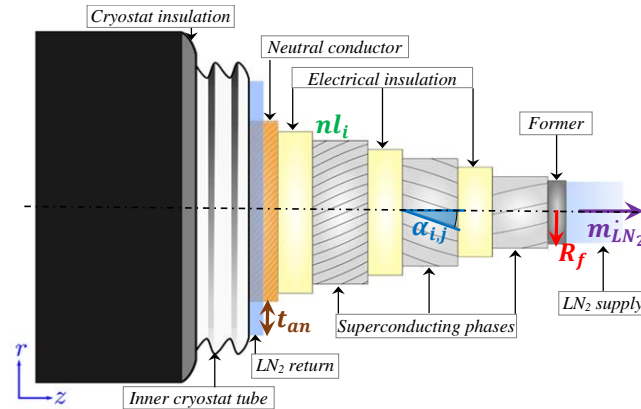

Technical model – Main features

Property	Symbol	Value
Total power	P_{tot}	1.5 GW
Cable power	P	750 MW
N° of HTS cables running in parallel	n_{cables}	2
Voltage rms	V_{rms}	33 kV
Load factor	$\cos\varphi$	0.95
rms value of the total AC current in each phase	I_{rms}	$I_{rms} = \frac{P}{\sqrt{3} V_{rms} \cos\varphi} = 13.81 \text{ kA}$
Line length	L_{line}	32 km

TEA on HTS cables → Line main features (case study)

The case study is set in the **Inventory analysis – HTS** sheet of our Excel file.

Transmission link between solar plant and substation

Phase 2: Inventory analysis

HTS system MAIN FEATURES

Technical parameter	Symbol	HTS system	Units	Comment
Line length	L_{line}	3.20E+04	m	
Power delivered by each cable	P	7.50E+08	W	Maximum Power for 1 cable = 750 MW
Voltage level rms of each cable	V_{rms}	3.30E+04	V	Phase-to-phase voltage
Load factor	$cos\varphi$	0.95		
Mean ambient temperature in the installation site	T_a	303.15	K	30° C
Frequency	f	50	Hz	

HTS tapes

Technical parameter	Symbol	HTS system	Units	Comment
Tape width	w_{HTS}	4.00E-03	m	
Mean HTS temperature in the cable, for all phases (tentative)	T_{HTS}	70.1	K	
Critical current of the tape at 77 K and s.f.	$I_{c_HTS_77K}$	293.7	A	
Safety value of I_{tape}/I_{c_HTS} not to be passed	$safety_{HTS}$	0.8		80%
N° of HTS layers in phase 1	n_{l_1}	2		
N° of HTS layers in phase 2	n_{l_2}	1		
N° of HTS layers in phase 3	n_{l_3}	1		
Inner radius of HTS layer 1 - phase 1	$R_{HTS_1_1}$	3.39E-02	m	
Inner radius of HTS layer 2 - phase 1	$R_{HTS_2_1}$	3.41E-02	m	
Inner radius of HTS layer 1 - phase 2	$R_{HTS_1_2}$	4.86E-02	m	
Inner radius of HTS layer 1 - phase 3	$R_{HTS_1_3}$	6.24E-02	m	
Twist angle of HTS layer 1 - phase 1	α_{1_1}	11	°	
Twist angle of HTS layer 2 - phase 1	α_{2_1}	15	°	
Twist angle of HTS layer 1 - phase 2	α_{1_2}	-13	°	
Twist angle of HTS layer 1 - phase 3	α_{1_3}	-14	°	

1-Goal and scope definition | 2-Inventory analysis-Benchmark | **2-Inventory analysis-HTS** | 3.0-HTS Cable design | 3-Calculation of indicators-HTS | 4-Int ...

III. TEA of HTS cable system

Phase 3 – Calculation of indicators

Set some cable design parameters

TEA on HTS cables → Set some cable design parameters

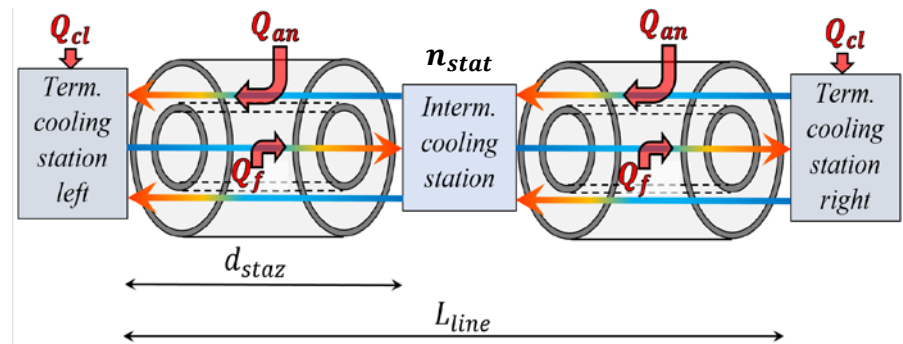
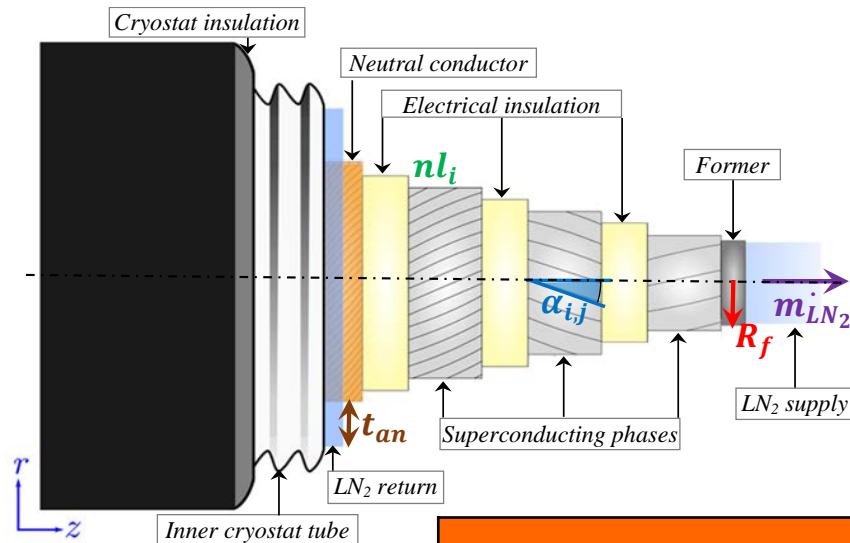

Technical model		
Property	Symbol	Value
Former radius (inner)	R_{former}	30 mm
LN2 mass flow rate	\dot{m}_{LN2}	2.15 kg/s
Twist angle for each layer of phase 1	$\alpha_{1,1}, \alpha_{2,1}$	11°, 15°
Twist angle for each layer of phase 2	$\alpha_{1,2}$	-13°
Twist angle for each layer of phase 3	$\alpha_{1,3}$	-14°
N° of HTS layers for phase 1	n_{l_1}	2
N° of HTS layers for phase 2	n_{l_2}	1
N° of HTS layers for phase 3	n_{l_3}	1
Thickness of the annular gap	$t_{annulus}$	27.8 mm
N° of intermediate cooling stations	n_{stat}	5

TEA on HTS cables → Set some cable design parameters

The parameters set are colored in red in the **Inventory analysis - HTS** sheet of our Excel file.

Transmission link between solar plant and substation
Phase 2: Inventory analysis

HTS system MAIN FEATURES				
Technical parameter	Symbol	HTS system	Units	Comment
Line length	L_{line}	3.20E+04	m	
Power delivered by each cable	P	7.50E+08	W	Maximum Power for 1 cable = 750 MW
Voltage level rms of each cable	V_{rms}	3.30E+04	V	Phase-to-phase voltage
Load factor	$cos\varphi$	0.95		
Mean ambient temperature in the installation site	T_a	303.15	K	30° C
Frequency	f	50	Hz	

HTS tapes				
Technical parameter	Symbol	HTS system	Units	Comment
Tape width	w_{HTS}	4.00E-03	m	
Mean HTS temperature in the cable, for all phases (tentative)	T_{HTS}	70.1	K	
Critical current of the tape at 77 K and s.f.	$I_{c_HTS_77K}$	293.7	A	
Safety value of I_{tape}/I_{c_HTS} not to be passed	$safety_{HTS}$	0.8		80%
N° of HTS layers in phase 1	n_{l_1}	2		
N° of HTS layers in phase 2	n_{l_2}	1		
N° of HTS layers in phase 3	n_{l_3}	1		
Inner radius of HTS layer 1 - phase 1	$R_{HTS_1_1}$	3.39E-02	m	
Inner radius of HTS layer 2 - phase 1	$R_{HTS_2_1}$	3.41E-02	m	
Inner radius of HTS layer 1 - phase 2	$R_{HTS_1_2}$	4.86E-02	m	
Inner radius of HTS layer 1 - phase 3	$R_{HTS_1_3}$	6.24E-02	m	
Twist angle of HTS layer 1 - phase 1	α_{1_1}	11	°	
Twist angle of HTS layer 2 - phase 1	α_{2_1}	15	°	
Twist angle of HTS layer 1 - phase 2	α_{1_2}	3	°	
Twist angle of HTS layer 1 - phase 3	α_{1_3}	-14	°	

The full cable design is provided

TEA on HTS cables → Cable design for the case study

If you are lucky enough, you can find the whole design of your device at the operating conditions you selected from manufacturer' or literature' data.

TEA on HTS cables → Cable design for the case study

Technical model – Main Features		
Property	Symbol	Value
Cable power	P	1 GW
Voltage rms	V_{rms}	25 kV
Load factor	$\cos\varphi$	0.95
Line length	L_{line}	32 km

Technical model – Set design parameters		
Property	Symbol	Value
Former radius	R_{former}	30 mm
LN2 mass flow rate	\dot{m}_{LN2}	2.15 kg/s
Twist angle for each layer of each phase	$\alpha_{1,1}, \alpha_{2,1}$	11°, 15°
	$\alpha_{1,2}$	-13°
	$\alpha_{1,3}$	-14°
N° of HTS layers for each phase	n_{l_1}	2
	n_{l_2}	1
	n_{l_3}	1
Thickness of the annular gap	$t_{annulus}$	27.8 mm
N° of intermediate cooling stations	n_{stat}	5

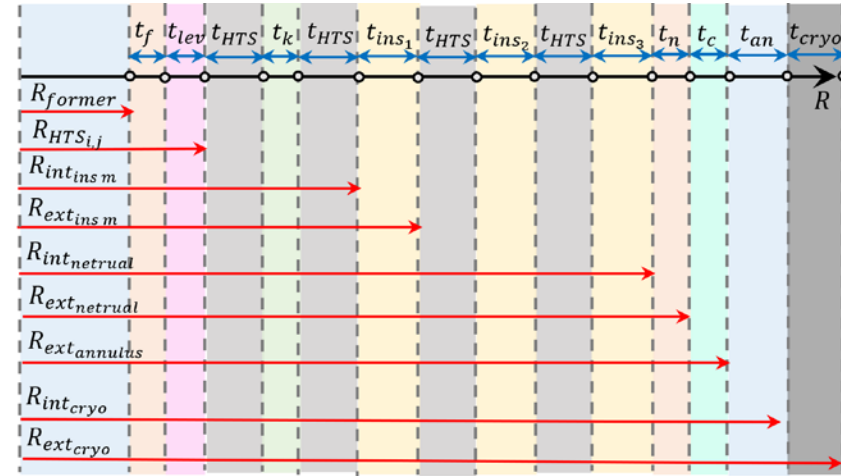
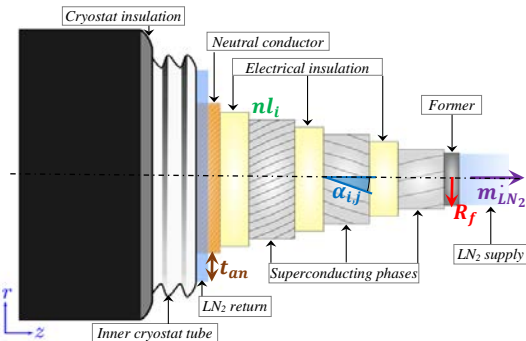

Technical model – Remaining design parameters		
Property	Symbol	Value
Radius of the HTS layers of phase 1 (inner)	$R_{HTS_{1,1}}, R_{HTS_{2,1}}$	33.9 mm , 34.1 mm
Radius of the HTS layers of phase 1 (inner)	$R_{HTS_{1,2}}$	48.6 mm
Radius of the HTS layers of phase 1 (inner)	$R_{HTS_{1,3}}$	62.4 mm
N° of HTS tapes in the layers of phase 1	$Tapes_{1,1}, Tapes_{2,1}$	52 , 52
N° of HTS tapes in the layers of phase 2	$Tapes_{1,2}$	74
N° of HTS tapes in the layers of phase 3	$Tapes_{1,3}$	95
Inner radius of the 3 insulating layers	$R_{int_{ins_1}}, R_{int_{ins_2}}, R_{int_{ins_3}}$	34.3 mm , 48.8 mm, 62.5 mm
Outer radius of the 3 insulating layers	$R_{ext_{ins_1}}, R_{ext_{ins_2}}, R_{ext_{ins_3}}$	48.6 mm, 62.4 mm , 75.8 mm
Inner radius of the copper neutral layer	$R_{int_{neutral}}$	75.8 mm
Outer radius of the copper neutral layer	$R_{ext_{neutral}}$	77.8 mm
Inner radius of the annular gap for LN2	$R_{int_{annulus}}$	78.6 mm
Outer radius of the annular gap for LN2	$R_{ext_{annulus}}$	106.0 mm
Inner radius of the cryostat	$R_{int_{cryo}}$	106.0 mm
Outer radius of the cryostat	$R_{ext_{cryo}}$	137.8 mm

TEA on HTS cables → Losses and cooling stations for the case study

Technical model – Main Features		
Property	Symbol	Value
Cable power	P	1 GW
Voltage rms	V_{rms}	25 kV
Load factor	$\cos\varphi$	0.95
Line length	L_{line}	32 km

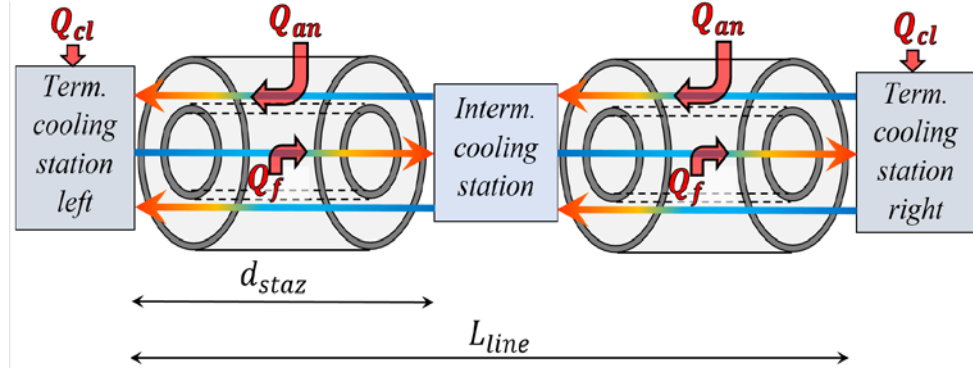

Technical model – Set design parameters		
Property	Symbol	Value
Former radius	R_{former}	30 mm
LN2 mass flow rate	\dot{m}_{LN2}	2.15 kg/s
Twist angle for each layer of each phase	$\alpha_{1,1}, \alpha_{2,1}$	11°, 15°
	$\alpha_{1,2}$	-13°
	$\alpha_{1,3}$	-14°
N° of HTS layers for each phase	n_{l1}	2
	n_{l2}	1
	n_{l3}	1
Thickness of the annular gap	$t_{annulus}$	27.8 mm
N° of intermediate cooling stations	n_{stat}	5

Technical model – Losses and fluid dynamics parameters		
Property	Symbol	Value
Total AC losses by HTS tapes in the cable	$LOSS_{AC\ HTS}$	423.2 kW
Total losses by the insulating layers in the cable	$LOSS_{ins}$	98.0 kW
Total heat inputs from the cryostat in the cable	$LOSS_{cryo}$	71.6 kW
Total eddy currents losses in the cable	$LOSS_{eddy}$	31.2 kW
Total losses by cable terminations	$LOSS_{term}$	5.3 kW
Thermal inputs into the LN2 in the former in a single cable segment	Q_f	38.7
Thermal inputs into the LN2 in the annular gap in a single cable segment	Q_{an}	50.6
Losses by terminations in a single side of the cable	Q_{cl}	2.6
Temperature rise in the LN2 in the former in a single cable segment	ΔT_{former}	3.5 K
Temperature rise in the LN2 in the annular gap in a single cable segment	$\Delta T_{annulus}$	4.6 K
Pressure drop in the LN2 in the former in a single cable segment	ΔP_{former}	3.1 bar
Pressure drop in the LN2 in the annular gap in a single cable segment	$\Delta P_{annulus}$	4.6 bar
Mean HTS temperature in a single cable segment	T_{HTS}	70 K

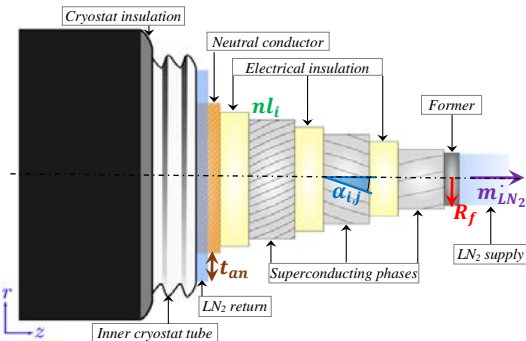

Compute the cable design in cascade

TEA on HTS cables → Compute the cable design in cascade

If you want to calculate the cable design yourself (because the data are not available under the conditions you have chosen) you can look at the **HTS Cable design** sheet of our Excel file.

This sheet is for consultation only, do not to modify the equations in the cells, for the moment.

Descriptions of all the equations inserted are provided in the next slides.

Transmission link between solar plant and substation
Phase 2.5: Compute cable design, losses and constraints

HTS system MAIN FEATURES				
Technical parameter	Symbol	HTS system	Units	Comment
Length	L	1.87E+02	m	
Current delivered by each cable	I_{cable}	1.05E+02	A	
Voltage level of each cable	V_{cable}	3.3E+02	V	
Fill factor	FF	0.7		
Load factor	LF	0.9		
Mean ambient temperature in the installation site	T_{amb}	301.15	K	
Base value of the total current in each phase	$I_{base, phase}$	1.93E+02	A	$I_{base, phase} = I_{cable} * 3 * FF$
Base value of the current in HTS layer 1-phase 1	$I_{base, L1}$	6.4E+01	A	$I_{base, L1} = I_{base, phase} / 3$
Base value of the current in HTS layer 1-phase 2	$I_{base, L2}$	6.4E+01	A	$I_{base, L2} = I_{base, phase} / 3$
Base value of the current in HTS layer 1-phase 3	$I_{base, L3}$	6.4E+01	A	$I_{base, L3} = I_{base, phase} / 3$
Base value of the current in HTS layer 2-phase 4	$I_{base, L2}$	1.93E+02	A	$I_{base, L2} = I_{base, phase}$

Constants				
Technical parameter	Symbol	HTS system	Units	Comment
Permeability	μ_0	1.257E-06	Wb/A.m	
Dielectric constant	ϵ_r	4.9	nm ² /m ²	
Dielectric constant	ϵ_0	8.85E-12	C ² /Nm	

Cable design in cascade				
Technical parameter	Symbol	HTS system	Units	Comment
Former radius	R_{former}	3.00E+02	m	
Thickness of the former	t_f	1.00E+02	m	
Thickness of the insulating layer between former and HTS layer 1	R_{ins1}	1.00E+02	m	
Inner radius of HTS layer 1-phase 1	$R_{HTS, L1}$	3.34E+02	m	$R_{HTS, L1} = R_{former} + t_f + R_{ins1}$
Thickness of HTS layer 1	$t_{HTS, L1}$	1.50E+02	m	
Thickness of insulating layer between HTS layer 1 and HTS layer 2	R_{ins2}	5.00E+02	m	
Inner radius of HTS layer 2-phase 1	$R_{HTS, L2}$	1.25E+02	m	$R_{HTS, L2} = R_{ins1} + t_{HTS, L1} + R_{ins2}$
Inner radius of HTS layer 2-phase 2	$R_{HTS, L2}$	3.48E+02	m	$R_{HTS, L2} = R_{HTS, L2} + t_{HTS, L2}$
Thickness of insulating layer between phase 1 and phase 2	R_{ins3}	1.00E+02	m	
Outer radius of insulation layer outside phase 1	$R_{out, ins3}$	4.48E+02	m	$R_{out, ins3} = R_{HTS, L2} + t_{ins3}$
Inner radius of HTS layer 1-phase 2	$R_{HTS, L1}$	4.48E+02	m	$R_{HTS, L1} = R_{out, ins3} + t_{HTS, L1}$
Inner radius of insulation layer between phase 2 and phase 3	R_{ins4}	1.00E+02	m	
Outer radius of insulation layer between phase 1 and phase 3	$R_{out, ins4}$	5.48E+02	m	$R_{out, ins4} = R_{HTS, L2} + R_{ins3} + R_{ins4}$
Inner radius of insulation layer outside phase 3	$R_{out, ins4}$	5.48E+02	m	$R_{out, ins4} = R_{HTS, L2} + R_{ins3} + R_{ins4}$
Thickness of insulation layer outside phase 3	R_{ins5}	1.50E+02	m	
Outer radius of insulation layer outside phase 3	$R_{out, ins5}$	7.98E+02	m	$R_{out, ins5} = R_{out, ins4} + R_{ins5}$
Copper layer inner radius	$R_{copper, inner}$	7.98E+02	m	
Thickness of copper central layer	$R_{copper, central}$	2.00E+02	m	
Outer radius of copper central layer	$R_{copper, outer}$	7.98E+02	m	
Thickness of copper insulation layer	$R_{copper, ins}$	1.00E+02	m	
Inner radius of the insulator cap	$R_{cap, inner}$	7.98E+02	m	$R_{cap, inner} = R_{copper, outer} + R_{copper, ins}$
Outer radius of the insulator cap	$R_{cap, outer}$	1.04E+03	m	$R_{cap, outer} = R_{cap, inner} + R_{HTS, L1} * LF$
Inner radius of the cryostat	$R_{cryo, inner}$	1.04E+03	m	$R_{cryo, inner} = R_{cap, outer}$
Thickness of the cryostat wall	t_{cryo}	1.00E+02	m	
Outer radius of the cryostat	$R_{cryo, outer}$	1.14E+03	m	$R_{cryo, outer} = R_{cryo, inner} + t_{cryo}$

Insulation thickness parameters				
Technical parameter	Symbol	HTS system	Units	Comment
$h1$	$h1$	1		
$h2$	$h2$	1		
$h3$	$h3$	1.5		
$h4$	$h4$	1.5		
$h5$	$h5$	1.5		
$h6$	$h6$	1.5		
$h7$	$h7$	1.5		
$h8$	$h8$	1.5		
$h9$	$h9$	1.5		
$h10$	$h10$	1.5		

Losses				
Technical parameter	Symbol	HTS system	Units	Comment
Q_{HTS}	Q_{HTS}	1.25E+02	W	
Q_{ins}	Q_{ins}	1.25E+02	W	
Q_{copper}	Q_{copper}	1.25E+02	W	
Q_{cryo}	Q_{cryo}	1.25E+02	W	
$Q_{HTS, L1}$	$Q_{HTS, L1}$	1.25E+02	W	
$Q_{HTS, L2}$	$Q_{HTS, L2}$	1.25E+02	W	
$Q_{HTS, L3}$	$Q_{HTS, L3}$	1.25E+02	W	
$Q_{HTS, L4}$	$Q_{HTS, L4}$	1.25E+02	W	
$Q_{HTS, L5}$	$Q_{HTS, L5}$	1.25E+02	W	
$Q_{HTS, L6}$	$Q_{HTS, L6}$	1.25E+02	W	
$Q_{HTS, L7}$	$Q_{HTS, L7}$	1.25E+02	W	
$Q_{HTS, L8}$	$Q_{HTS, L8}$	1.25E+02	W	
$Q_{HTS, L9}$	$Q_{HTS, L9}$	1.25E+02	W	
$Q_{HTS, L10}$	$Q_{HTS, L10}$	1.25E+02	W	
$Q_{HTS, L11}$	$Q_{HTS, L11}$	1.25E+02	W	
$Q_{HTS, L12}$	$Q_{HTS, L12}$	1.25E+02	W	
$Q_{HTS, L13}$	$Q_{HTS, L13}$	1.25E+02	W	
$Q_{HTS, L14}$	$Q_{HTS, L14}$	1.25E+02	W	
$Q_{HTS, L15}$	$Q_{HTS, L15}$	1.25E+02	W	
$Q_{HTS, L16}$	$Q_{HTS, L16}$	1.25E+02	W	
$Q_{HTS, L17}$	$Q_{HTS, L17}$	1.25E+02	W	
$Q_{HTS, L18}$	$Q_{HTS, L18}$	1.25E+02	W	
$Q_{HTS, L19}$	$Q_{HTS, L19}$	1.25E+02	W	
$Q_{HTS, L20}$	$Q_{HTS, L20}$	1.25E+02	W	

Constraints calculation				
Technical parameter	Symbol	HTS system	Units	Comment
Velocity of LRM into the former	$v_{LRM, former}$	0.501	m/s	
Velocity of LRM into the insulator cap	$v_{LRM, cap}$	0.501	m/s	
Phase shift number for LRM in the former	$R_{LRM, former}$	1.13E+02		
Phase shift number for LRM in the insulator cap	$R_{LRM, cap}$	1.13E+02		
Friction factor for LRM in the former	$f_{LRM, former}$	9.78E-02		
Friction factor for LRM in the insulator cap	$f_{LRM, cap}$	1.09E-02		
Temperature rise for LRM in the former	$\Delta T_{LRM, former}$	3.5	K	
Temperature rise for LRM in the insulator cap	$\Delta T_{LRM, cap}$	4.6	K	
Maximum temperature for LRM in the former, max. LRM, former	$T_{max, LRM, former}$	718	K	
Maximum temperature for LRM in the insulator cap, max. LRM, cap	$T_{max, LRM, cap}$	72.4	K	
Mean temperature for LRM in the former	$T_{mean, LRM, former}$	4.9	K	
Mean temperature for LRM in the insulator cap	$T_{mean, LRM, cap}$	70.3	K	
Temperature rise for LRM at left side of L1	$\Delta T_{LRM, left}$	49.3	K	
Temperature for LRM at right side of L1	$T_{LRM, right}$	70.3	K	
Mean HTS temperature in the cable, for all	T_{HTS}	79.0	K	
Pressure drop for LRM in the former (Pa)	$\Delta P_{LRM, former}$	3.07E+05	Pa	
Pressure drop for LRM in the insulator cap (Pa)	$\Delta P_{LRM, cap}$	4.95E+05	Pa	

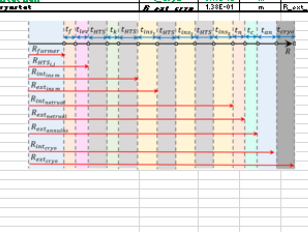

TEA on HTS cables → Compute the cable design in cascade

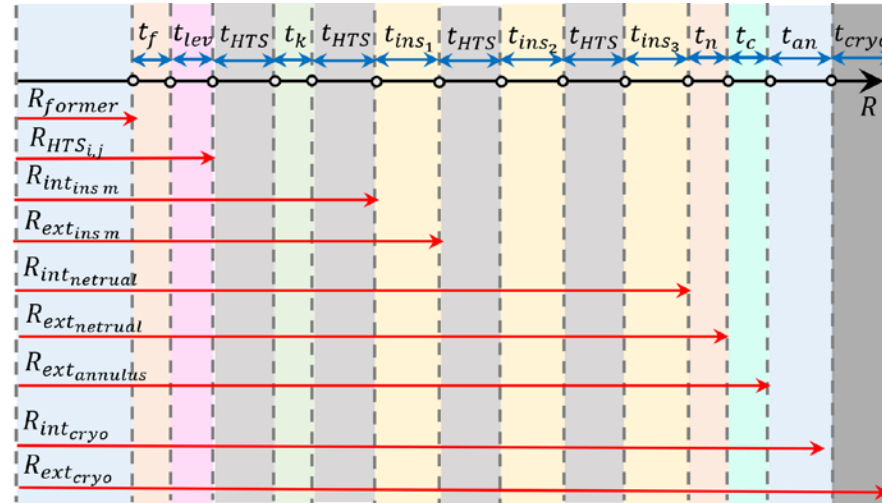

Technical model		
Property	Symbol	Value
Former thickness	R_{former}	30 mm
Thickness of the former	t_f	2 mm
Thickness of the levelling layer between former and innermost HTS layer	t_{lev}	1.9 mm
Thickness of HTS tapes	t_{HTS}	0.15 mm
Thickness of layer between HTS layers of the same phase	t_k	0.05 mm
Thickness of insulating layers	$t_{ins_1}, t_{ins_2}, t_{ins_3}$	See next slides
Thickness of copper neutral layer	t_n	3 mm
Thickness of core fixture layer between neutral and annular gap	t_c	0.8 mm
Thickness of the annular gap	$t_{annulus}$	27.8 mm
Cryostat wall thickness	t_{cryo}	31.8 mm

[8]

[6]

[5]

[6]

[5]

TEA on HTS cables → Compute the cable design in cascade

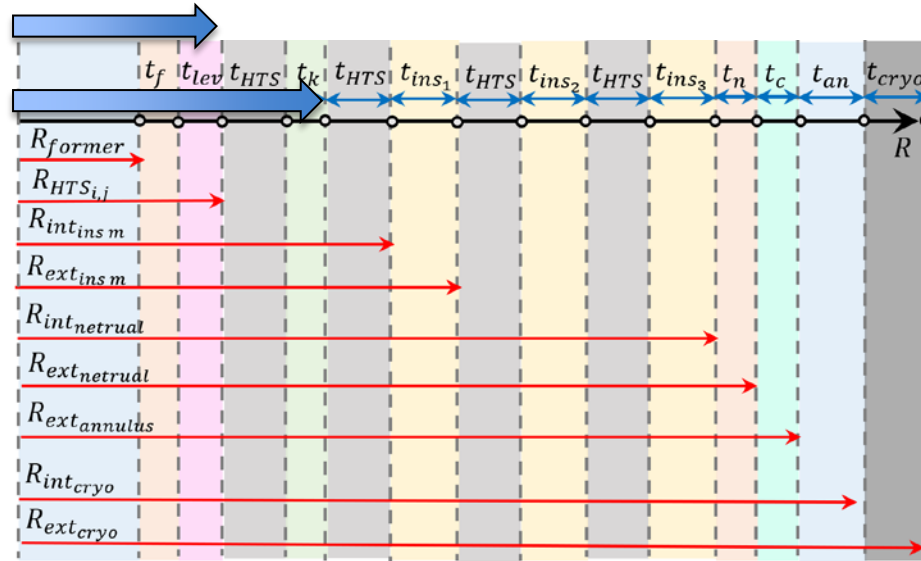

$$R_{HTS_{1,1}} = R_{former} + t_f + t_{lev}$$

$$R_{HTS_{k,1}} = [t_{HTS}(n_{l_1} - 1)] + [t_k(n_{l_1} - 1)]$$

TEA on HTS cables → Compute the cable design in cascade

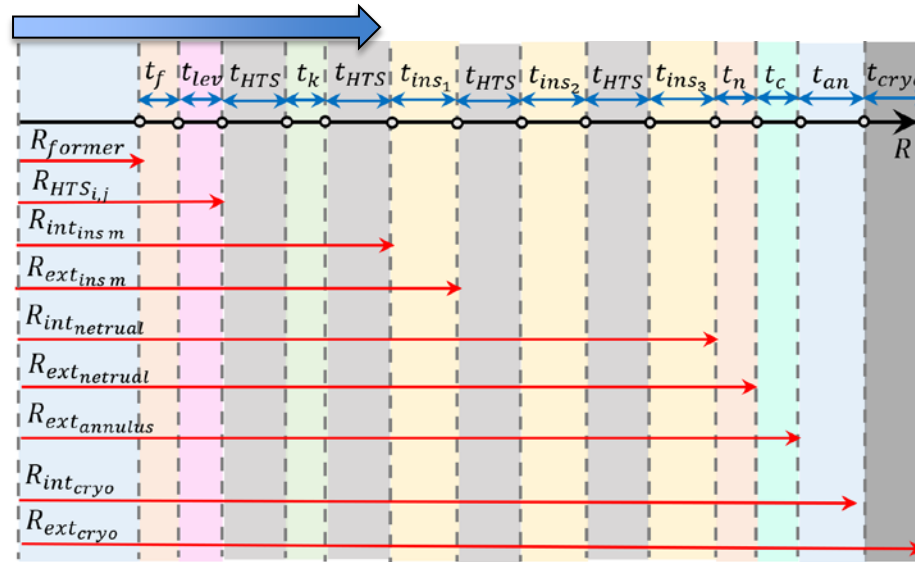

$$R_{int_{ins_1}} = R_{HTS_{1_1}} + (t_{HTS} n_{l_1}) + [t_k (n_{l_1} - 1)]$$

TEA on HTS cables → Compute the cable design in cascade

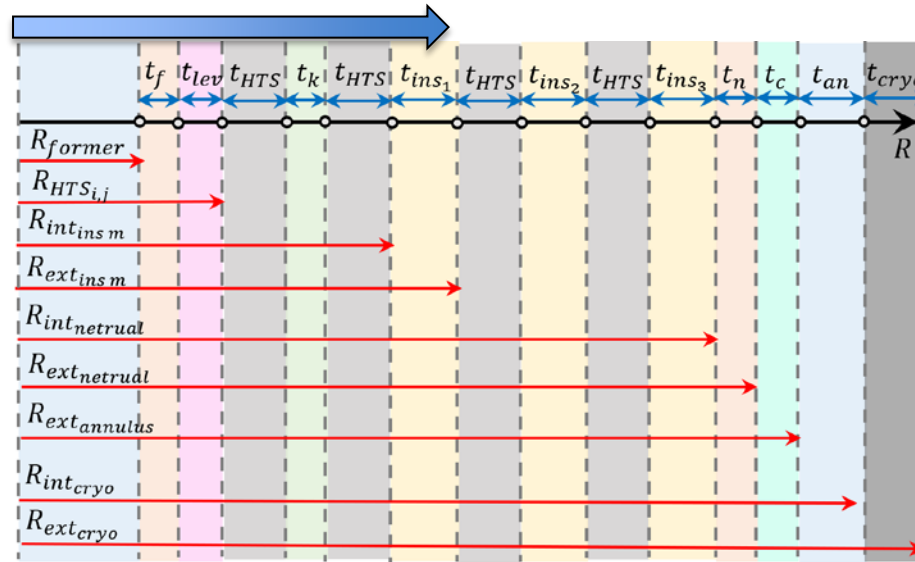

[9 - 13]

Technical model	
Symbol	Value
k_{1im}	1.32
k_{2im}	1
k_{3im}	1
V_{im}	150 kV
E_{im}	76 MV/m
k_{1AC}	1.59
k_{2AC}	1
k_{3AC}	1.45
V_{AC}	$2.5 (\sqrt{2}V_{rms})/\sqrt{3}$
E_{AC}	52 MV/m

$$R_{ext_{ins_1}} = R_{int_{ins_1}} + \max(t_{ins_{im_1}}, t_{ins_{AC_1}})$$

withstand voltage
under lighting impulse

$$t_{ins_{im_1}} = R_{int_{ins_1}} \left[\exp \left(\frac{k_{1im} k_{2im} k_{3im} V_{im}}{R_{int_{ins_1}} E_{im}} \right) - 1 \right]$$

withstand voltage
under the operating
frequency

$$t_{ins_{AC_1}} = R_{int_{ins_1}} \left[\exp \left(\frac{k_{1AC} k_{2AC} k_{3AC} V_{AC}}{R_{int_{ins_1}} E_{AC}} \right) - 1 \right]$$

TEA on HTS cables → Compute the cable design in cascade

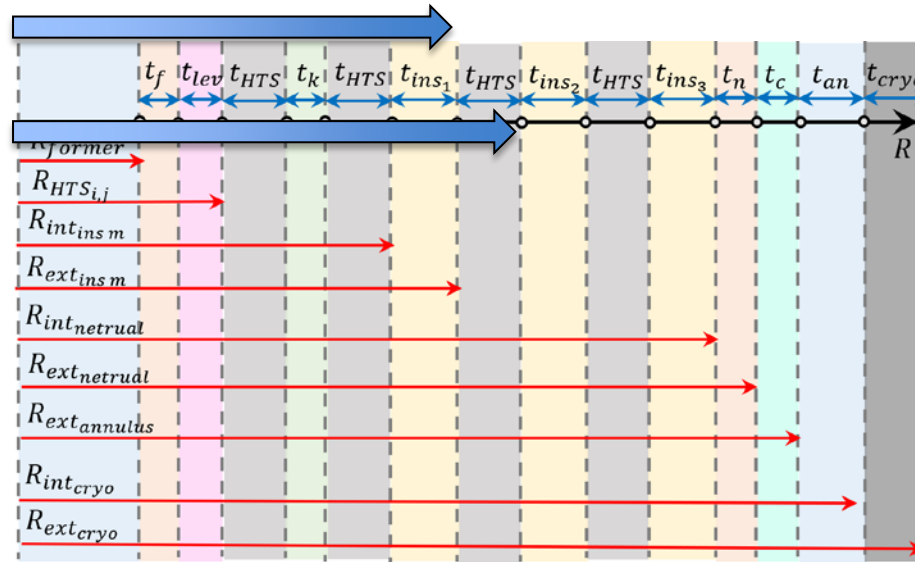

$$R_{HTS_2} = R_{ext_{ins_1}}$$

$$R_{int_{ins_2}} = R_{HTS_2} + (t_{HTS} n_{l_2}) + [t_k (n_{l_2} - 1)]$$

TEA on HTS cables → Compute the cable design in cascade

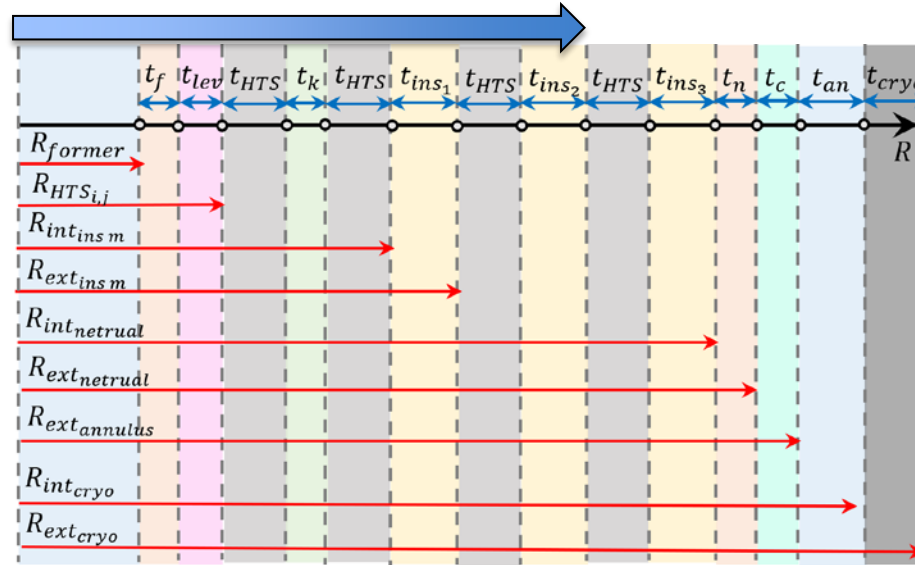

[9 - 13]

Technical model	
Symbol	Value
k_{1im}	1.32
k_{2im}	1
k_{3im}	1
V_{im}	150 kV
E_{im}	76 MV/m
k_{1AC}	1.59
k_{2AC}	1
k_{3AC}	1.45
V_{AC}	$2.5 (\sqrt{2}V_{rms})/\sqrt{3}$
E_{AC}	52 MV/m

$$R_{ext_{ins_2}} = R_{int_{ins_2}} + \max(t_{ins_{im_2}}, t_{ins_{AC_2}})$$

$$t_{ins_{im_2}} = R_{int_{ins_2}} \left[\exp \left(\frac{k_{1im} k_{2im} k_{3im} V_{im}}{R_{int_{ins_2}} E_{im}} \right) - 1 \right]$$

$$t_{ins_{AC_2}} = R_{int_{ins_2}} \left[\exp \left(\frac{k_{1AC} k_{2AC} k_{3AC} V_{AC}}{R_{int_{ins_2}} E_{AC}} \right) - 1 \right]$$

TEA on HTS cables → Compute the cable design in cascade

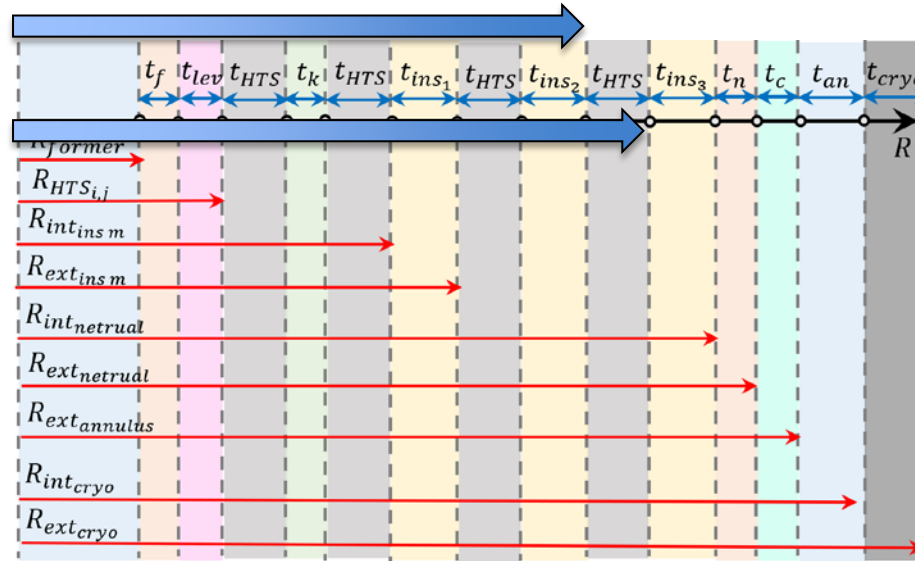

$$R_{HTS_3} = R_{ext_{ins_2}}$$

$$R_{int_{ins_3}} = R_{HTS_3} + (t_{HTS} n_{l_3}) + [t_k (n_{l_3} - 1)]$$

TEA on HTS cables → Compute the cable design in cascade

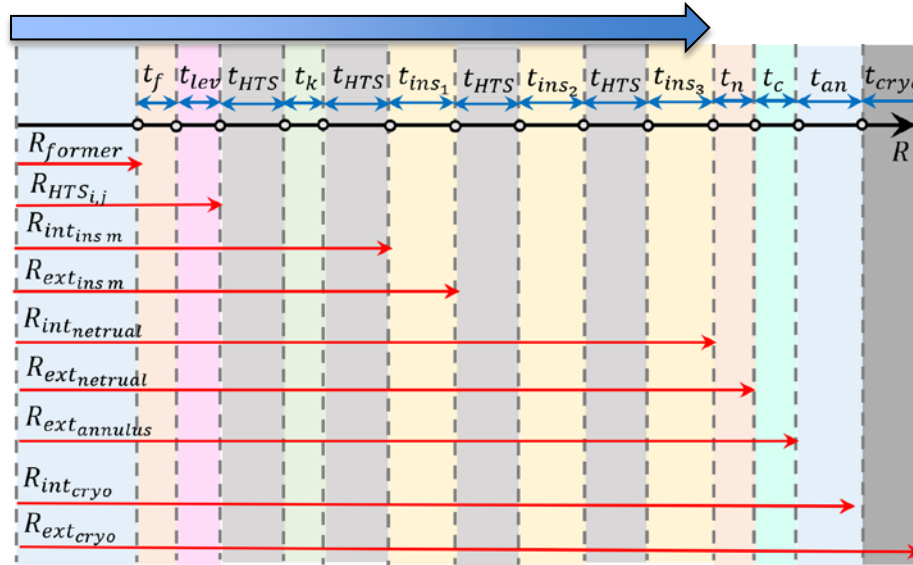

[9 - 13]

$$R_{extins_3} = R_{intins_3} + \max(t_{ins_{im_3}}, t_{ins_{AC_3}})$$

$$t_{ins_{im_3}} = R_{intins_3} \left[\exp \left(\frac{k_{1im} k_{2im} k_{3im} V_{im}}{R_{intins_3} E_{im}} \right) - 1 \right]$$

$$t_{ins_{AC_3}} = R_{intins_3} \left[\exp \left(\frac{k_{1AC} k_{2AC} k_{3AC} V_{AC}}{R_{intins_3} E_{AC}} \right) - 1 \right]$$

Technical model	
Symbol	Value
k_{1im}	1.32
k_{2im}	1
k_{3im}	1
V_{im}	150 kV
E_{im}	76 MV/m
k_{1AC}	1.59
k_{2AC}	1
k_{3AC}	1.45
V_{AC}	$2.5 (\sqrt{2} V_{rms}) / \sqrt{3}$
E_{AC}	52 MV/m

TEA on HTS cables → Compute the cable design in cascade

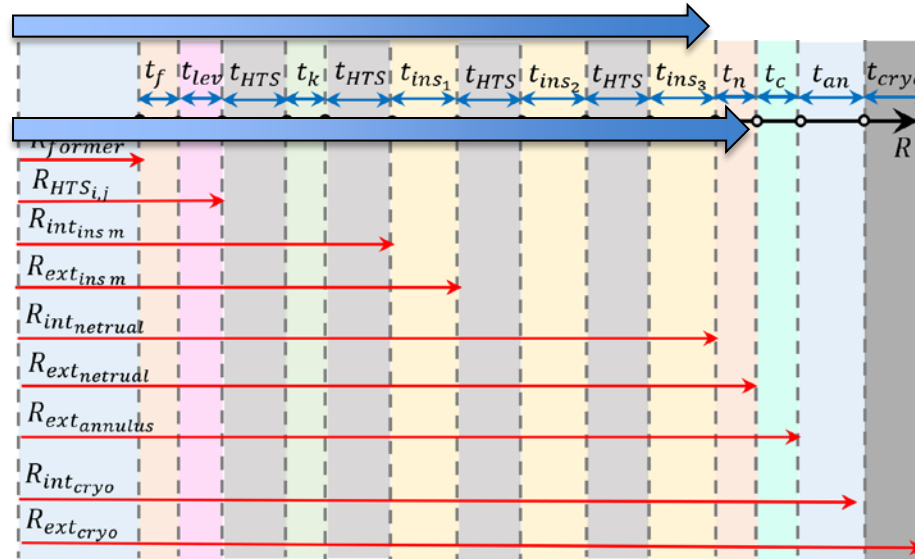

$$R_{int_{neutral}} = R_{ext_{ins_3}}$$

$$R_{ext_{neutral}} = R_{int_{neutral}} + t_n$$

TEA on HTS cables → Compute the cable design in cascade



$$R_{int_{annulus}} = R_{ext_{neutral}} + t_c$$

$$R_{int_{annulus}} = R_{int_{annulus}} + t_{annulus}$$

TEA on HTS cables → Compute the cable design in cascade



$$R_{int_{cryo}} = R_{ext_{annulus}}$$

$$R_{ext_{cryo}} = R_{int_{cryo}} + t_{cryo}$$

Compute losses

TEA on HTS cables → Compute the cable system losses

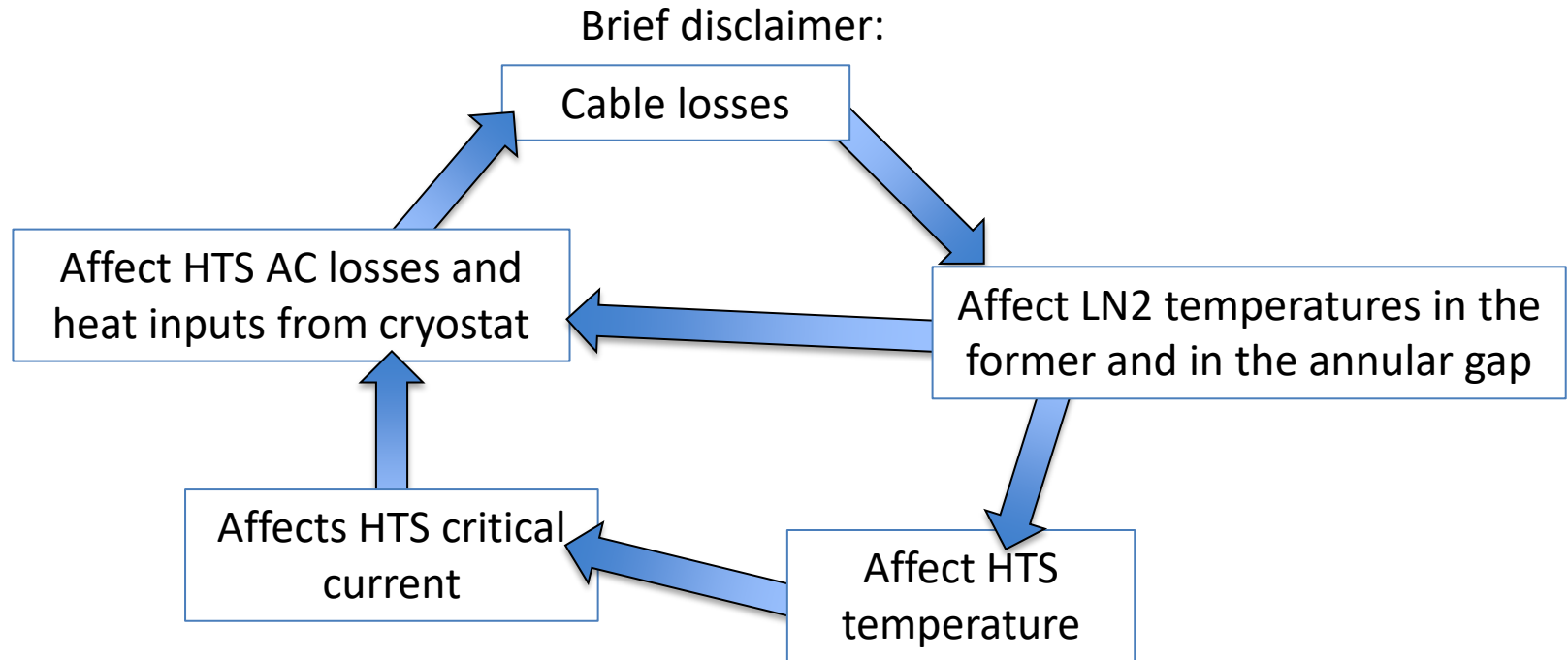

This loop can be solved numerically via a constrained minimization operation (losses, cable cost).
 In this analysis, we set a tentative value of the mean temperature of HTS (T_{HTS}) and the mean temperature of the LN2 in the annular gap ($T_{annulus}$).
 Then, we could adjust them once we get the results.

Technical model – Tentative temperatures	
T_{HTS}	70.1 K
$T_{annulus}$	70.4 K

TEA on HTS cables \rightarrow Losses

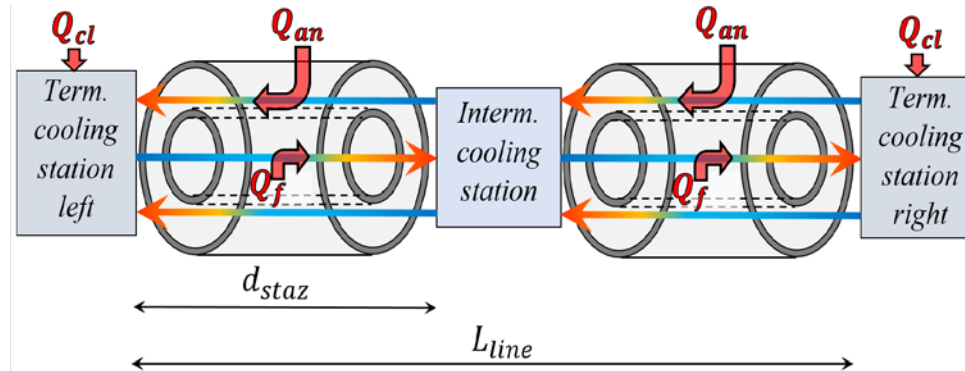

Losses =

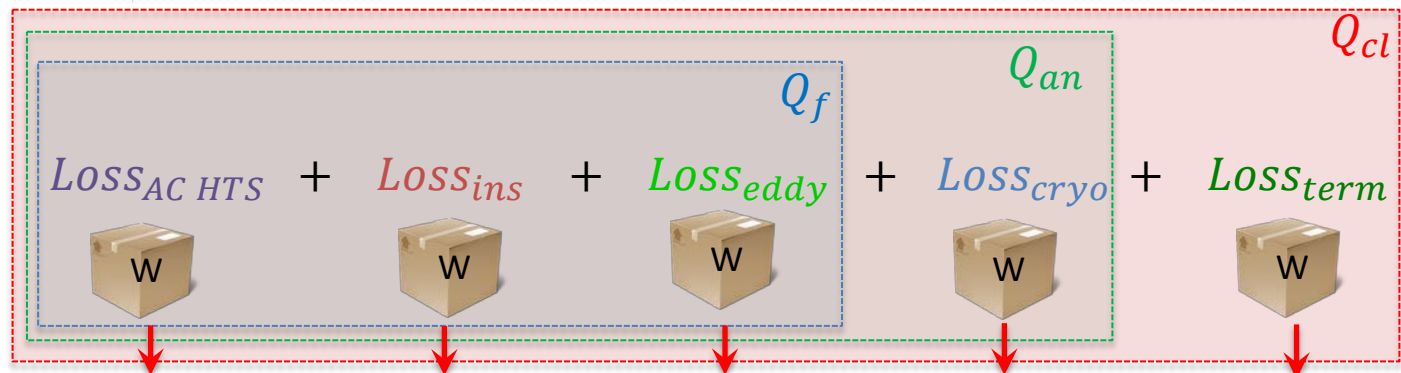

cable design
(HTS length,
 I_{tape}/I_c) + tape
properties ($I_c(T)$)

Line main
features (cable
length, voltage) +
cable design
(insulation
dimensions)

Line main
features (cable
current) + normal
conductors
properties model
(W/kA)

Line main features
(cable length) + **cable
design** (cryostat
dimensions, T_{LN2}) +
cryostat properties (λ)

Line main
features (cable
current) +
terminations
properties (W/kA)

Each term will be detailed in the next slides...

TEA on HTS cables → Losses → $LOSS_{AC\ HTS}$

$$Losses = \boxed{LOSS_{AC\ HTS}} + LOSS_{ins} + LOSS_{eddy} + LOSS_{cryo} + LOSS_{term}$$

$$LOSS_{AC\ HTS} = \sum_i^3 \left[\sum_j^{nl_i} Tapes_{i,j} \frac{L_{line}}{|\cos(\alpha_{i,j})|} \frac{\mu_0 f}{\pi} I_c^2(T_{HTS}) \xi_{i,j} \right] \quad [14]$$

$$\xi_{i,j} = (1 - F_{i,j}) \ln(1 - F_{i,j}) + (1 + F_{i,j}) \ln(1 + F_{i,j}) - F_{i,j}^2$$

$$F_{i,j} = \frac{I_{M_{i,j}}}{I_c(T)} = \frac{\sqrt{2} I_{rms_{i,j}}}{Tapes_{i,j} I_c(T_{HTS})}$$

$$Tapes_{i,j} = \text{round} \left(\frac{2\pi R_{HTS_{i,j}} |\cos(\alpha_{i,j})|}{w_{HTS}} \right)$$

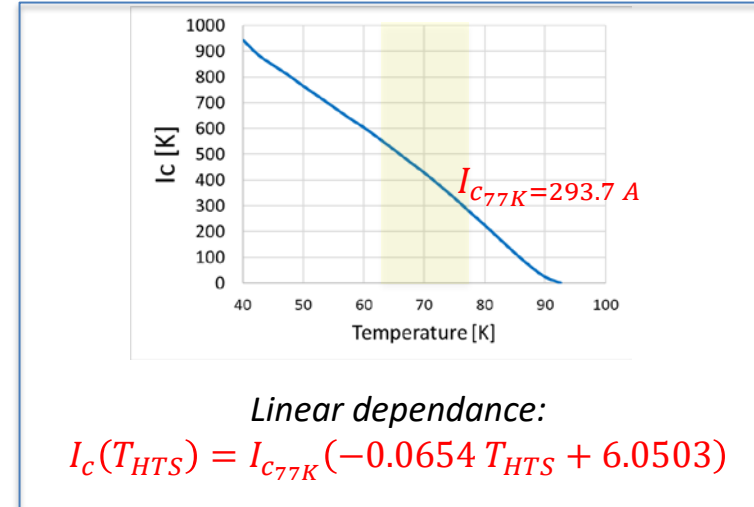

Technical model		
Property	Symbol	Value
AC current frequency	f	50 Hz
N° of intermediate cooling stations	n_{stat}	5
N° of HTS layers for each layer	nl_i	2, 1, 1
Twist angle for each HTS layer/phase	$\alpha_{i,j}$	11°, 15°, -13°, -14°
rms value of the AC current in each layer of phase 1	$I_{rms_{1,1}}, I_{rms_{2,1}}$	6.9 kA , 6.9 kA
rms value of the AC current in each layer of phase 2	$I_{rms_{1,2}}$	13. 81 kA
rms value of the AC current in each layer of phase 3	$I_{rms_{1,3}}$	13. 81 kA
HTS tape critical depending on its mean temperature	$I_c(T_{HTS})$	
Line length	L_{line}	32 km
Tape width	w_{HTS}	4 mm

Reference material :
SuNAM SCN04 4mm tape

[15]

TEA on HTS cables \rightarrow *Losses* \rightarrow *LOSS_{ins}*

$$Losses = LOSS_{AC\ HTS} + \boxed{LOSS_{ins}} + LOSS_{eddy} + LOSS_{cryo} + LOSS_{term}$$

$$LOSS_{ins} = \sum_w^3 [2 \pi f L_{line} \tan \delta_{ins} Capac_w V_{rms}^2]$$

$$Capac_w = \frac{2 \pi \varepsilon_{ins} \varepsilon_0}{\ln \left(\frac{R_{ext_{ins\ w}}}{R_{int_{ins\ w}}} \right)}$$

[16, 17, 18]

Reference material : PPLP

Technical model		
Property	Symbol	Value
AC current frequency	f	50 Hz
N° of intermediate cooling stations	n_{stat}	5
Loss tangent of insulation	$\tan \delta_{ins}$	6e-4
Permittivity of insulation	ε_{ins}	2.21
Voltage level of the cable	V_{rms}	33 kV
Inner radius for each insulating layer	$R_{int_{ins_1}}, R_{int_{ins_2}}, R_{int_{ins_3}}$	34.3 mm , 48.8 mm, 62.5 mm
Outer radius for each insulating layer	$R_{ext_{ins_1}}, R_{ext_{ins_2}}, R_{ext_{ins_3}}$	48.6 mm, 62.4 mm , 75.8 mm
Line length	L_{line}	32 km

TEA on HTS cables \rightarrow Losses \rightarrow $LOSS_{cryo}$

$$Losses = LOSS_{AC\ HTS} + LOSS_{ins} + LOSS_{eddy} + \boxed{LOSS_{cryo}} + LOSS_{term}$$

$$LOSS_{cryo} = L_{line} \frac{2\pi \lambda [T_a - T_{annulus}]}{\ln(R_{ext\ cryo}/R_{int\ cryo})}$$

Technical model		
Property	Symbol	Value
N° of intermediate cooling stations	n_{stat}	5
Effective thermal conductivity of the cryostat	λ	0.4 mW/(m K)
Ambient temperature (outside the cable)	T_a	300 K
T_{LN2} in the annulus (mean - tentative)	$T_{annulus}$	70.4 K
Inner radius of the cryostat	$R_{int\ cryo}$	106.0 mm
Outer radius of the cryostat	$R_{ext\ cryo}$	137.8 mm
Cryostat wall thickness	t_{cryo}	3.18 cm
Line length	L_{line}	32 km

[19]

TEA on HTS cables → Losses → $LOSS_{eddy}$, $LOSS_{term}$

$$Losses = LOSS_{AC\ HTS} + LOSS_{ins} + \boxed{LOSS_{eddy}} + LOSS_{cryo} + \boxed{LOSS_{term}}$$

$$\left\{ \begin{array}{l} LOSS_{eddy} = L_{line} Q_{eddy} I_{max} \\ LOSS_{term} = n_{term} Q_{term} I_{max} \end{array} \right.$$

Technical model		
Property	Symbol	Value
Eddy current loss per unit of length and unit of current	Q_{eddy}	50 mW/(kA*m)
Amplitude of the AC current in each phase	I_{max}	19.53 kA
N° of terminations (both ends)	n_{term}	6
Loss for each termination per unit of current	Q_{term}	45 W/kA
Line length	L_{line}	32 km

[7]

Verify constraints

TEA on HTS cables → Losses

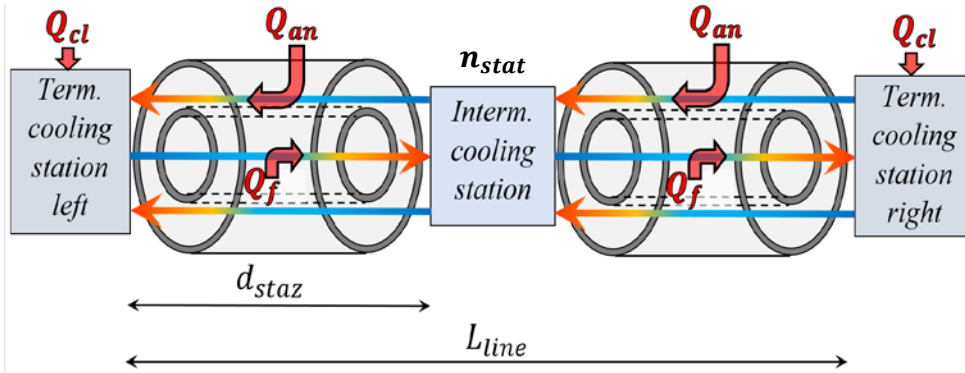

Note: the losses are conveniently divided based on which fluid will be affected into a cable segment (LN2 in the former or LN2 in the annular gap).

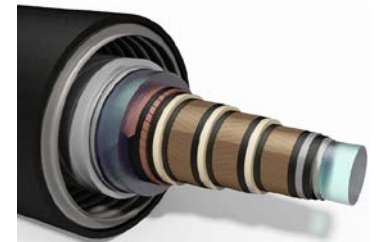

$$\left\{ \begin{aligned} Q_f &= \left(\frac{LOSS_{AC\ HTS} + LOSS_{ins} + LOSS_{eddy}}{2} \right) \left(\frac{1}{n_{stat} + 1} \right) \\ Q_{an} &= \left(\frac{LOSS_{AC\ HTS} + LOSS_{ins} + LOSS_{eddy}}{2} + LOSS_{cryo} \right) \left(\frac{1}{n_{stat} + 1} \right) \\ Q_{cl} &= \frac{LOSS_{term}}{2} \end{aligned} \right.$$

intermediate station → $Q_f + Q_{an}$
left termination station → $Q_{an} + Q_{cl}$
right termination station → $Q_f + Q_{cl}$

TEA on HTS cables → Constraints → ΔT_{LN2} and ΔP_{LN2}

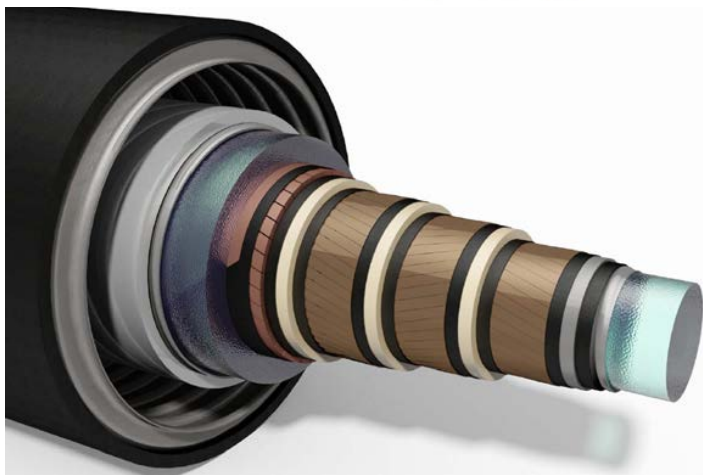
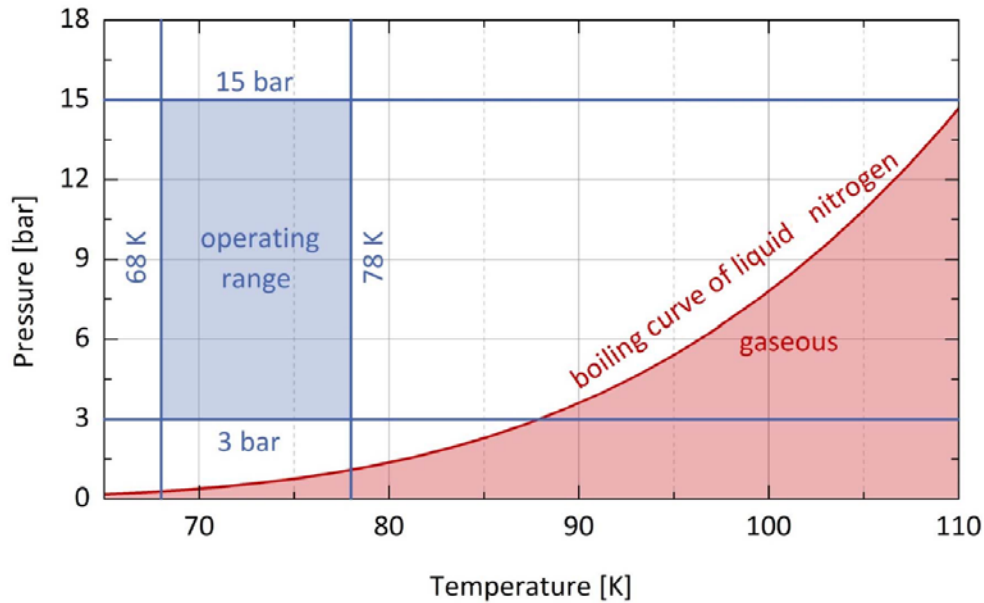

$$\left\{ \begin{array}{l} \Delta T_{former} \leq \Delta T_{LN2_{max}} \\ \Delta T_{annulus} \leq \Delta T_{LN2_{max}} \\ \Delta P_{former} \leq \Delta P_{LN2_{max}} \\ \Delta P_{annulus} \leq \Delta P_{LN2_{max}} \end{array} \right.$$

Technical model		
Property	Symbol	Value
Inlet temperature	T_{0LN2}	68 K
Maximum temperature rise	$\Delta T_{LN2_{max}}$	10 K
Inlet pressure	P_{0LN2}	3 bar
Maximum pressure drop	$\Delta P_{LN2_{max}}$	12 bar

[5]

TEA on HTS cables → Constraints → ΔT_{LN2} and ΔP_{LN2}

$$\left\{ \begin{array}{l} \Delta T_{former} \leq \Delta T_{LN2max} \Rightarrow \Delta T_{former} = d_{stat} \left(\frac{v_{LN2former}^2 f_{LN2former}}{4 R_{former} c_{pLN2}} \right) + \frac{Q_f}{2 \dot{m}_{LN2} c_{pLN2}} \\ \Delta T_{annulus} \leq \Delta T_{LN2max} \Rightarrow \Delta T_{annulus} = d_{stat} \left(\frac{v_{LN2annulus}^2 f_{LN2annulus}}{4 t_{annulus} c_{pLN2}} \right) + \frac{Q_{an}}{2 \dot{m}_{LN2} c_{pLN2}} \end{array} \right.$$

$$\left\{ \begin{array}{l} \Delta P_{former} \leq \Delta P_{LN2max} \Rightarrow \Delta P_{former} = \left(d_{stat} \frac{\rho_{LN2} v_{LN2former}^2 f_{LN2former}}{4 R_{former}} \right) + (g \rho_{LN2} \Delta h) \\ \Delta P_{annulus} \leq \Delta P_{LN2max} \Rightarrow \Delta P_{annulus} = \left(d_{stat} \frac{\rho_{LN2} v_{LN2annulus}^2 f_{LN2annulus}}{4 t_{annulus}} \right) + (g \rho_{LN2} \Delta h) \end{array} \right.$$

$$\left\{ \begin{array}{l} f_{LN2former} = \left\{ -1.8 \ln \left[\left(\frac{\varepsilon_{former}}{7.4 R_{former}} \right)^{1.11} + \left(\frac{6.9}{Re_{former}} \right)^{1.11} \right] \right\}^{-2} \\ Re_{former} = \frac{2 R_{former} v_{LN2former} \rho_{LN2}}{\mu_{LN2}} \\ v_{LN2former} = \frac{\dot{m}_{LN2}}{\rho_{LN2} \pi R_{former}^2} \end{array} \right.$$

$$\left\{ \begin{array}{l} f_{LN2annulus} = \left\{ -1.8 \ln \left[\left(\frac{\varepsilon_{annulus}}{7.4 t_{annulus}} \right)^{1.11} + \left(\frac{6.9}{Re_{annulus}} \right)^{1.11} \right] \right\}^{-2} \\ v_{LN2annulus} = \frac{\dot{m}_{LN2}}{\rho_{LN2} \pi t_{annulus}^2} \end{array} \right.$$

Friction with the ducts walls causes both:

- heating of the fluid ☹️
- pressure drop ☹️

TEA on HTS cables → Constraints → ΔT_{LN2} and ΔP_{LN2}

$$\Delta T_{former} \leq \Delta T_{LN2max} \Rightarrow \Delta T_{former} = d_{stat} \left(\frac{v_{LN2_{former}}^2 f_{LN2_{former}}}{4 t_{annulus}} \right) + \frac{Q_f}{m_{LN2} \dot{c} p_{LN2}}$$

[8] Technical model

Property	Symbol	Value
LN2 dynamic viscosity	μ_{LN2}	25.08 $\mu Pa \cdot s$
LN2 density	ρ_{LN2}	839 kg/m^3
LN2 heat capacity	$c p_{LN2}$	2662 $J/kg \cdot K$
roughness of the pipe	ϵ	1.4 mm
Height difference between the two cable ends	Δh	1 m

$$\Delta T_{annulus} \leq \Delta T_{former} \Rightarrow \Delta T_{annulus} = \left(d_{stat} \frac{\rho_{LN2} v_{LN2_{annulus}}^2 f_{LN2_{annulus}}}{4 t_{annulus}} \right) + (g \rho_{LN2} \Delta h)$$

$$\Delta P_{former} \leq \Delta P_{LN2max} \Rightarrow \Delta P_{former} = \left(d_{stat} \frac{\rho_{LN2} v_{LN2_{annulus}}^2 f_{LN2_{annulus}}}{4 t_{annulus}} \right) + (g \rho_{LN2} \Delta h)$$

$$\Delta P_{annulus} \leq \Delta P_{LN2max} \Rightarrow \Delta P_{annulus} = \left(d_{stat} \frac{\rho_{LN2} v_{LN2_{annulus}}^2 f_{LN2_{annulus}}}{4 t_{annulus}} \right) + (g \rho_{LN2} \Delta h)$$

- ❑ The number of cooling stations must prevent ΔT_{LN2} and ΔP_{LN2} from exceeding the maximum limits set.
- ❑ This does not mean that it is always economically convenient to use the minimum number of stations (spacing them as much as possible).
- ❑ Designing the cable system to have more cooling stations than the minimum can allow working with higher pressure and temperature margins → it **could** be more cost-effective!

TEA on HTS cables \rightarrow Constraints $\rightarrow \Delta T_{LN2}$ and ΔP_{LN2}

We can verify whether the hypotheses on T_{HTS} and $T_{annulus}$ were acceptable.

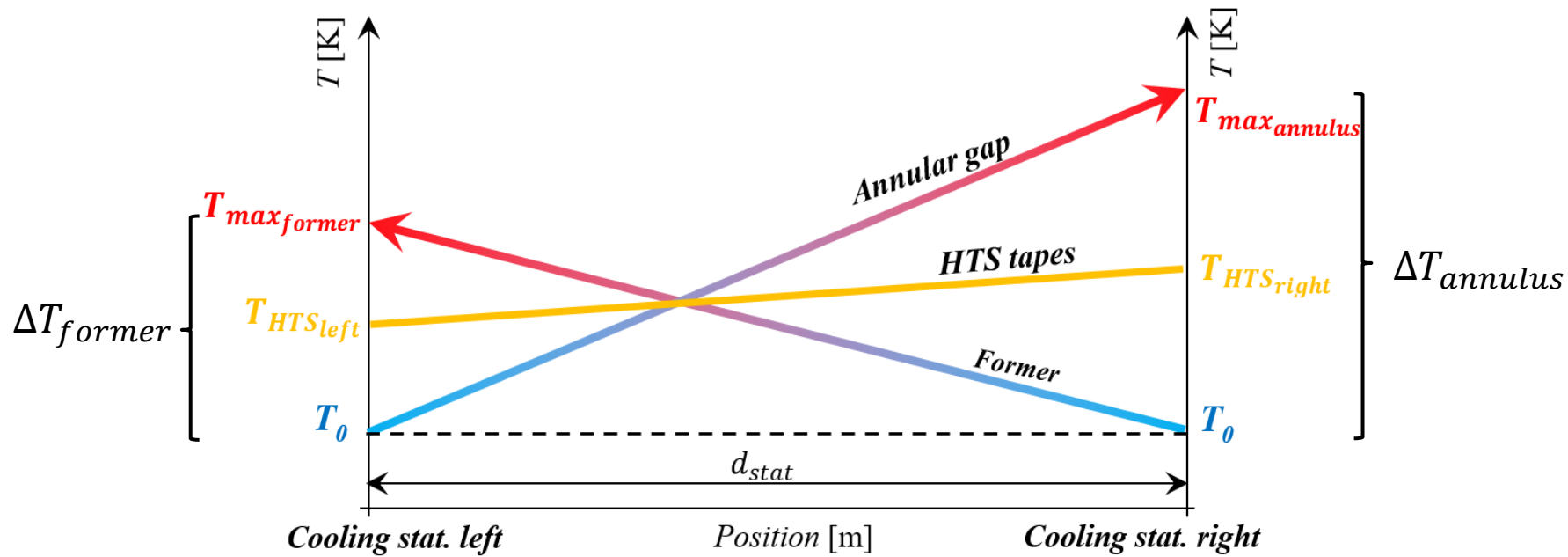

Relevant simplifying assumption:

the temperature of all HTS layers/phases is constant for each cable cross-section.

Otherwise, we should use 3D models to estimate the real distribution.

$T_{annulus}$ 2 $T_{HTS_{right}}$

TEA on HTS cables → Constraints → I_{HTS}/I_c

The maximum current flowing in each tape have to stay below a safety margin of the I_c .
 This has to be valid for all layers in all phases.

$$\left[\begin{array}{l} \frac{\sqrt{2} I_{rms}}{Tapes_{i,j}} / I_c \left(\max \left[T_{HTS_{left}}, T_{HTS_{right}} \right] \right) \leq safety_{HTS} \\ Tapes_{i,j} = \text{round} \left(\frac{2\pi R_{HTS_{i,j}} |\cos(\alpha_{i,j})|}{W_{HTS}} \right) \end{array} \right.$$

Technical model		
Property	Symbol	Value
Twist angle for each layer/phase	$\alpha_{i,j}$	11°, 15°, -13°, -14°
rms value of the total AC current in each phase	I_{rms}	13.81 kA
HTS tape critical current depending on its max temperature	$I_c \left(\max \left[T_{HTS_{left}}, T_{HTS_{right}} \right] \right)$	424 A
Safety marging for the I_{HTS}/I_c ratio	$safety_{HTS}$	80%
Tape width	W_{HTS}	4 mm

TEA on HTS cables → Constraints

In this section of the sheet **Calculation of indicators – HTS** you can verify if the computed values comply with the constraints that you have selected.

VERIFY CONSTRAINTS AND CHECK QUALITY OF TENTATIVE TEMP.S				
Temperature rise in the LN2 flowing in the former	ΔT_{LN2_former}	3.5	K	
Temperature rise in the LN2 flowing in the annular gap	$\Delta T_{LN2_annulus}$	4.6	K	
Maximum temperature rise allowed for the LN2 in both ducts	ΔT_{LN2_max}	10.0	K	
Pressure drop in the LN2 flowing in the annular gap [bar]	$\Delta P_{LN2_annulus}$	3.1	bar	
Pressure drop in the LN2 flowing in the annular gap [bar]	$\Delta P_{LN2_annulus}$	4.6	bar	
Maximum pressure drop allowed for the LN2 in both ducts	ΔP_{LN2_max}	12.0	bar	
Mean LN2 temperature in the annular gap (TENTATIVE)	$T_{annulus}$	70.4	K	
Mean LN2 temperature in the annular gap (COMPUTED)	$T_{annulus}$	70.3	K	
Mean HTS temperature in the cable (TENTATIVE)	T_{HTS}	70.1	K	
Mean HTS temperature in the cable (COMPUTED)	T_{HTS}	70.0	K	
Critical current of HTS tapes at maximum temperature	$I_{c_HTS_T_HTS_max}$	426.5	A	
Ratio between I_{max} in HTS tapes and their I_c in layer 1 - phase 1	$I_{max_1_1}/I_{c_HTS_T_HTS_max}$	0.440		I_{max}
Ratio between I_{max} in HTS tapes and their I_c in layer 2 - phase 1	$I_{max_2_1}/I_{c_HTS_T_HTS_max}$	0.440		I_{max}
Ratio between I_{max} in HTS tapes and their I_c in layer 1 - phase 2	$I_{max_1_2}/I_{c_HTS_T_HTS_max}$	0.619		I_{max}
Ratio between I_{max} in HTS tapes and their I_c in layer 1 - phase 3	$I_{max_1_3}/I_{c_HTS_T_HTS_max}$	0.482		I_{max}
Safety value of I_{tape}/I_{c_HTS} not to be passed	$safety_{HTS}$	0.80		

Variable	Symbol	HTS system	Units
-Goal and scope definition	2-Inventory analysis-Benchmark	2-Inventory analysis-HTS	3.0-HTS Cable design

3-**Calculation of indicators-HTS** 4-Int ... (+)

Compute CAPEX and OPEX

TEA on HTS cables → CAPEX and OPEX for conventional power cables



CAPEX

- Conductor
- Terminations and joints
- Installation and civil
- Land
- Dismantling
- Management, regulation, commissioning, studies, consents...

OPEX

- Conductor resistive losses
↓
energy loss along the line
- Maintenance

TEA on HTS cables → CAPEX and OPEX for HTS system costs

CAPEX

- Conductor components (HTS, insulation, Cu...)
- Cabling
- Vacuum system
- Cooling stations
- Cryogenic fluid
- Land
- Dismantling
- Terminations
- Cryostat
- Civil eng., Management, Commissioning, Studies...

OPEX

- Heat inputs along the line

energy to operate the cooling stations
- Maintenance

LCC

$$LCC = \sum_{t=1}^L \frac{CAPEX_t + OPEX_t}{(1+r)^t}$$

TEA on HTS cables → Costs for the case study

Again, by searching appropriate databases (... and being lucky), the economic data you need may already be available, without doing any calculations.

TEA on HTS cables → Costs for the case study

Technical model – Main Features		
Property	Symbol	Value
Cable power	P	1 GW
Voltage rms	V_{rms}	25 kV
Load factor	$\cos\varphi$	0.95
Line length	L_{line}	32 km

Technical model – Set design parameters		
Property	Symbol	Value
Former radius	R_{former}	30 mm
LN2 mass flow rate	\dot{m}_{LN2}	2.15 kg/s
Twist angle for each layer of each phase	$\alpha_{1,1}, \alpha_{2,1}$ $\alpha_{1,2}$ $\alpha_{1,3}$	11°, 15° -13° -14°
N° of HTS layers for each phase	n_{l_1} n_{l_2} n_{l_3}	2 1 1
Thickness of the annular gap	$t_{annulus}$	27.8 mm
N° of intermediate cooling stations	n_{stat}	5

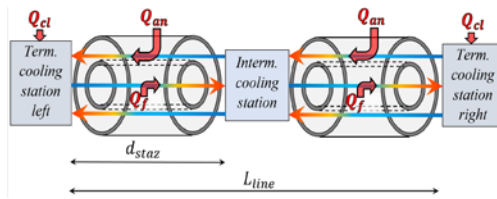
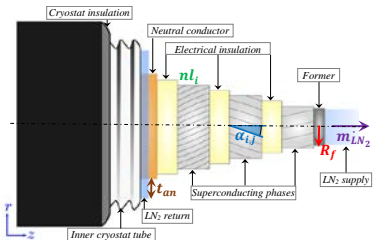
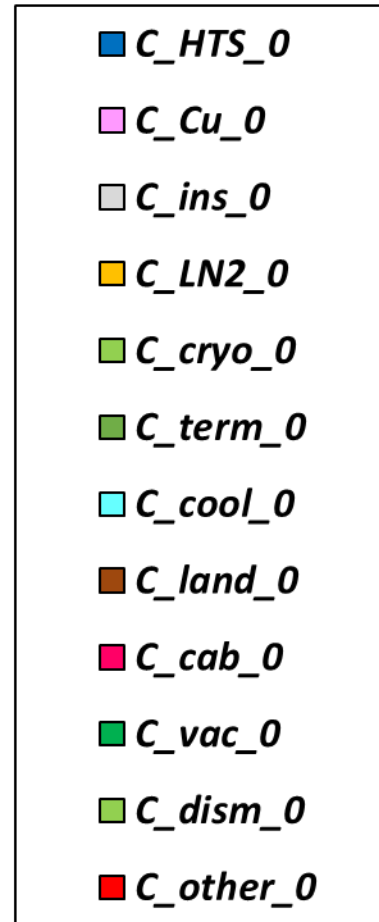
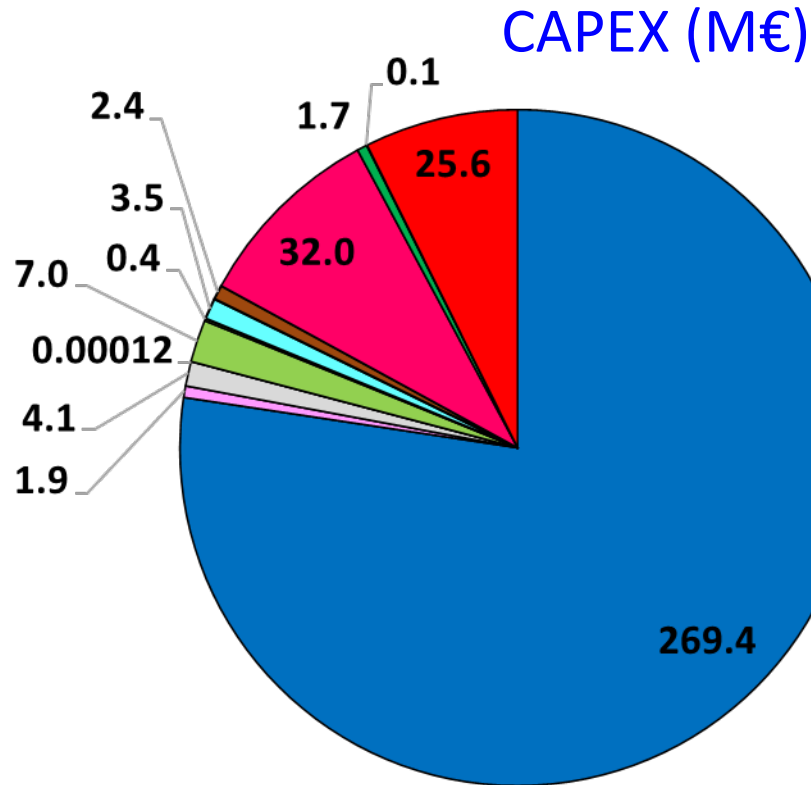

TEA on HTS cables → Costs for the case study

Technical model – Main Features		
Property	Symbol	Value
Cable power	P	1 GW
Voltage rms	V_{rms}	25 kV
Load factor	$\cos\varphi$	0.95
Line length	L_{line}	32 km

Technical model – Set design parameters		
Property	Symbol	Value
Former radius	R_{former}	30 mm
LN2 mass flow rate	\dot{m}_{LN2}	2.15 kg/s
Twist angle for each layer of each phase	$\alpha_{1,1}, \alpha_{2,1}$ $\alpha_{1,2}$ $\alpha_{1,3}$	11°, 15° -13° -14°
N° of HTS layers for each phase	n_{l_1} n_{l_2} n_{l_3}	2 1 1
Thickness of the annular gap	$t_{annulus}$	27.8 mm
N° of intermediate cooling stations	n_{stat}	5

OPEX (M€)

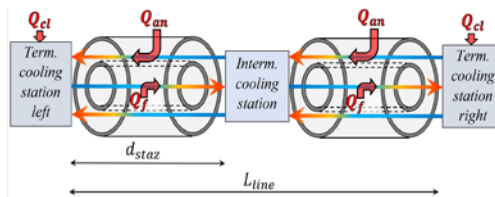
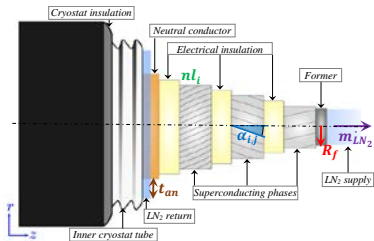
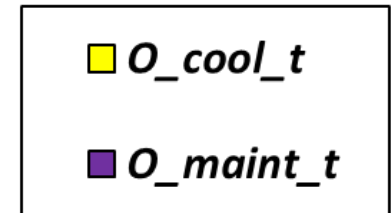
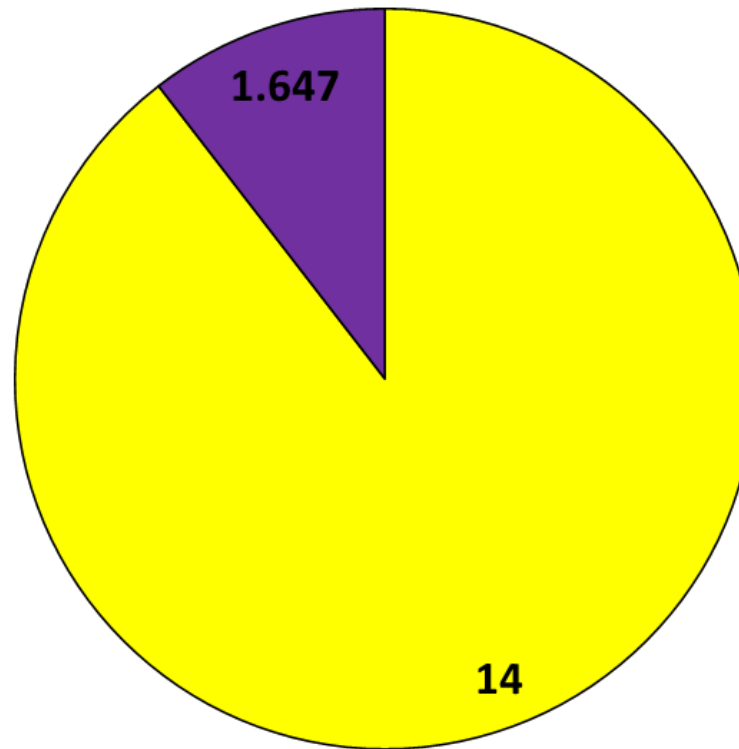

TEA on HTS cables → Costs for the case study

...however, in this lecture we will provide the equations to calculate the costs ourselves, so you can have more control on the outputs at different conditions and a better understanding.

We will do this in the sheet **Calculation of indicators – HTS** of our Excel file.

Variable	Symbol	ITS system	Units	Economic model	Comment
MATERIALS					
HTS tape CAPEX	C_{HTS_0}	269.4	MI	$C_{HTS_0} \cdot C_{HTS_VL_HTS_t+L_HTS_0} + L_HTS_0$	
Copper CAPEX	C_{Cu_0}	1.9	MI	$C_{Cu_0} \cdot C_{Cu_t} \cdot C_{Cu_t} \cdot C_{Cu_t}$	
Insulation CAPEX	C_{ins_0}	4.1	MI	$C_{ins_0} \cdot C_{ins_t} \cdot C_{ins_t} \cdot C_{ins_t}$	
LN2 CAPEX	C_{LN2_0}	0.00012	MI	$C_{LN2_0} \cdot C_{LN2_t} \cdot C_{LN2_t} \cdot C_{LN2_t}$	
Cryostat CAPEX	C_{cryo_0}	7.0	MI	$C_{cryo_0} \cdot C_{cryo_t} \cdot C_{cryo_t} \cdot C_{cryo_t}$	
Terminator CAPEX	C_{term_0}	0.4	MI	C_{term_0}	
COOLING STATIONS					
Cooling station CAPEX	C_{cool_t}	3.5	MI	$C_{cool_t} \cdot C_{cool_t} \cdot C_{cool_t} \cdot C_{cool_t}$	
Yearly cooling station OPEX	O_{cool_t}	14.1	MI/year	$O_{cool_t} \cdot C_{cool_t} \cdot C_{cool_t} \cdot C_{cool_t}$	
Total cooling station OPEX discounted at t=0	O_{cool_t}	14.1	MI	$O_{cool_t} \cdot C_{cool_t} \cdot C_{cool_t} \cdot C_{cool_t}$	
LAND					
Land CAPEX	C_{land_0}	2.4	MI	$C_{land_0} \cdot C_{land_t} \cdot C_{land_t} \cdot C_{land_t}$	
CABLING					
Cabling CAPEX	C_{cab_0}	32.0	MI	$C_{cab_0} \cdot C_{cab_t} \cdot C_{cab_t} \cdot C_{cab_t}$	
VACUUM SYSTEM					
Vacuum system CAPEX	C_{vac_0}	1.7	MI	$C_{vac_0} \cdot C_{vac_t} \cdot C_{vac_t} \cdot C_{vac_t}$	
DISMANTLING					
Dismantling CAPEX	C_{dism_0}	0.1	MI	$C_{dism_0} \cdot C_{dism_t} \cdot C_{dism_t} \cdot C_{dism_t}$	
OTHER COSTS					
Other costs CAPEX	C_{other_0}	25.6	MI	$C_{other_0} \cdot C_{other_t} \cdot C_{other_t} \cdot C_{other_t}$	
MAINTENANCE					
Yearly maintenance OPEX	O_{maint_t}	1.6	MI/year	$O_{maint_t} \cdot C_{maint_t} \cdot C_{maint_t} \cdot C_{maint_t}$	
Total maintenance OPEX discounted at t=0	O_{maint_t}	1.6	MI	$O_{maint_t} \cdot C_{maint_t} \cdot C_{maint_t} \cdot C_{maint_t}$	
TOTAL					
Capital expenditure (increased at t=0)	$CAPEX_0$	348.2	MI	$CAPEX_0 \cdot C_{HTS_0} + C_{Cu_0} + C_{ins_0} + C_{LN2_0} + C_{cryo_0} + C_{term_0} + C_{cool_t} + C_{land_0} + C_{cab_0} + C_{vac_0} + C_{dism_0} + C_{other_0}$	
Yearly operational expenditure	$OPEX_t$	18.7	MI/year	$OPEX_t \cdot C_{cool_t} + O_{maint_t}$	
Total operational expenditure discounted at t=0	$OPEX_0$	18.7	MI	$OPEX_t \cdot C_{cool_t} + O_{maint_t}$	
Life cycle cost (LCC) (t=0.85)	$LCC(t=0.85)$	365.8	MI	$CAPEX_0 + OPEX_0$	

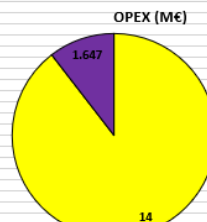
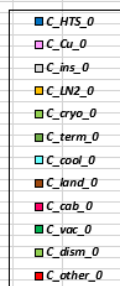
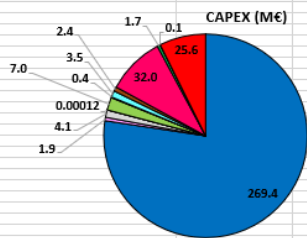

Year	O_{cool_t}	O_{maint_t}	$OPEX_t$	Units
1	0.5	0.091	0.572	MI
2	0.7	0.087	0.521	MI
3	0.7	0.083	0.792	MI
4	0.7	0.079	0.754	MI
5	0.6	0.075	0.718	MI
6	0.6	0.072	0.684	MI
7	0.6	0.068	0.651	MI
8	0.6	0.065	0.620	MI
9	0.5	0.062	0.591	MI
10	0.5	0.059	0.563	MI
11	0.5	0.056	0.536	MI
12	0.5	0.053	0.510	MI
13	0.4	0.051	0.486	MI
14	0.4	0.048	0.463	MI
15	0.4	0.045	0.441	MI
16	0.4	0.044	0.420	MI
17	0.4	0.042	0.400	MI
18	0.3	0.040	0.381	MI
19	0.3	0.038	0.363	MI
20	0.3	0.036	0.346	MI
21	0.3	0.034	0.329	MI
22	0.3	0.032	0.313	MI
23	0.3	0.031	0.296	MI
24	0.3	0.030	0.284	MI
25	0.2	0.028	0.271	MI
26	0.2	0.027	0.258	MI
27	0.2	0.026	0.246	MI
28	0.2	0.024	0.234	MI
29	0.2	0.023	0.223	MI
30	0.2	0.022	0.212	MI
31	0.2	0.021	0.202	MI
32	0.2	0.020	0.192	MI
33	0.2	0.019	0.183	MI
34	0.2	0.018	0.174	MI
35	0.1	0.017	0.166	MI
36	0.1	0.017	0.165	MI

TEA on HTS cables → CAPEX

$$CAPEX = CAPEX_{mat} + CAPEX_{cool} + CAPEX_{land} + CAPEX_{cab} + CAPEX_{vac} + CAPEX_{dism} + CAPEX_{other}$$

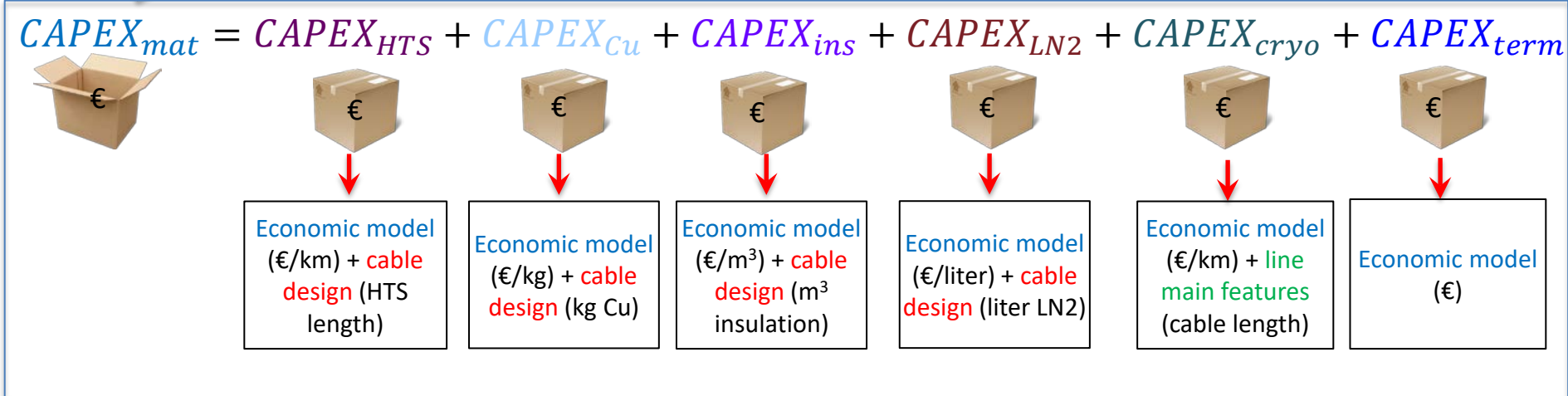
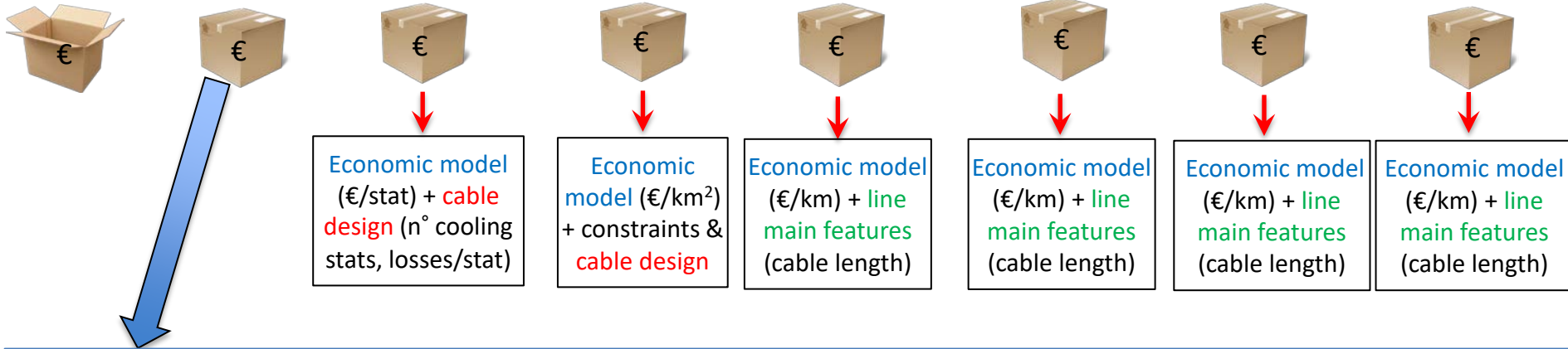

Each term will be detailed in the next slides...

TEA on HTS cables \rightarrow CAPEX \rightarrow $CAPEX_{mat}$ \rightarrow $CAPEX_{HTS}$

$$CAPEX_{mat} = \boxed{CAPEX_{HTS}} + CAPEX_{Cu} + CAPEX_{ins} + CAPEX_{LN2} + CAPEX_{cryo} + CAPEX_{term}$$

$$\left\{ \begin{aligned} CAPEX_{HTS} &= n_{cables} c_{HTS} \sum_i^3 \sum_j^{nl_i} Tapes_{i,j} \frac{L_{line}}{|\cos(\alpha_{i,j})|} \\ Tapes_{i,j} &= \text{round} \left(\frac{2\pi R_{HTS_{i,j}} |\cos(\alpha_{i,j})|}{w_{HTS}} \right) \end{aligned} \right.$$

Economic model

Property	Symbol	Value
HTS tape cost per unit length	c_{HTS}	30 €/m

Reference material : SuNAM SCN04 4mm tape

Technical model

Property	Symbol	Value
Tape width	w_{HTS}	4 mm
HTS layers radius in phase 1	$R_{HTS_{1,1}}$ $R_{HTS_{2,1}}$	33.9 mm 34.1 mm
HTS layer radius in phase 2	$R_{HTS_{1,2}}$	48.6 mm
HTS layer radius in phase 3	$R_{HTS_{1,3}}$	62.4 mm
Twist angle for each layer/phase	$\alpha_{i,j}$	11°, 15°, -13°, -14°
Line length	L_{line}	32 km

TEA on HTS cables \rightarrow CAPEX \rightarrow $CAPEX_{mat}$ \rightarrow $CAPEX_{Cu}$

$$CAPEX_{mat} = CAPEX_{HTS} + CAPEX_{Cu} + CAPEX_{ins} + CAPEX_{LN2} + CAPEX_{cryo} + CAPEX_{term}$$

$$\left\{ \begin{aligned} CAPEX_{Cu} &= n_{cables} c_{Cu} \rho_{Cu} Volume_{Cu} \\ Volume_{Cu} &= L_{line} \pi (R_{ext_{neutral}}^2 - R_{int_{neutral}}^2) \end{aligned} \right.$$

Economic model

Property	Symbol	Value
Copper cost per unit of weight	c_{Cu}	7 €/kg

Technical model

Property	Symbol	Value
Copper density	ρ_{Cu}	8850 kg/m ³
Inner radius of Cu neutral	$R_{int_{neutral}}$	75.8 mm
Outer radius of Cu neutral	$R_{ext_{neutral}}$	77.8 mm
Line length	L_{line}	32 km

TEA on HTS cables \rightarrow CAPEX \rightarrow CAPEX_{mat} \rightarrow CAPEX_{ins}

$$CAPEX_{mat} = CAPEX_{HTS} + CAPEX_{Cu} + CAPEX_{ins} + CAPEX_{LN2} + CAPEX_{cryo} + CAPEX_{term}$$

$$CAPEX_{ins} = n_{cables} c_{ins} \rho_{ins} Volume_{ins}$$

$$Volume_{ins} = L_{line} \pi \sum_w^3 (R_{ext_{ins}w}^2 - R_{int_{ins}w}^2)$$

Economic model

Property	Symbol	Value
Insulation cost per unit of weight	c_{ins}	10 €/kg

[20]

Reference material : PPLP

Technical model

Property	Symbol	Value
Insulation density	ρ_{ins}	0.9 ton/m ³
Inner radius for each insulating layer	$R_{int_{ins}1}$ $R_{int_{ins}2}$ $R_{int_{ins}3}$	34.3 mm 48.8 mm 62.5 mm
Outer radius for each insulating layer	$R_{ext_{ins}1}$ $R_{ext_{ins}2}$ $R_{ext_{ins}3}$	48.6 mm 62.4 mm 75.8 mm
Line length	L_{line}	32 km

TEA on HTS cables \rightarrow CAPEX \rightarrow CAPEX_{mat} \rightarrow CAPEX_{LN2}

$$CAPEX_{mat} = CAPEX_{HTS} + CAPEX_{Cu} + CAPEX_{ins} + CAPEX_{LN2} + CAPEX_{cryo} + CAPEX_{term}$$

$$\left\{ \begin{aligned} CAPEX_{LN2} &= n_{cables} c_{LN2} \left(\frac{kg}{l} \right)_{LN2} Volume_{LN2} \\ Volume_{LN2} &= L_{line} \pi \left(R_{ext_{annulus}}^2 - R_{int_{annulus}}^2 + R_{former}^2 \right) \end{aligned} \right.$$

Economic model		
Property	Symbol	Value
LN2 cost per liter	c_{LN2}	0.16 €/liter

Technical model		
Property	Symbol	Value
Kg on liter ratio for LN2	$\left(\frac{kg}{l} \right)_{LN2}$	1.235 kg/liter
Inner radius of the annular gap	$R_{int_{annulus}}$	78.6 mm
Outer radius of the annular gap	$R_{ext_{annulus}}$	106.0 mm
Former radius (inner)	R_{former}	30 mm
Line length	L_{line}	32 km

TEA on HTS cables \rightarrow CAPEX \rightarrow $CAPEX_{mat}$ \rightarrow $CAPEX_{cryo}$, $CAPEX_{term}$

$$CAPEX_{mat} = CAPEX_{HTS} + CAPEX_{Cu} + CAPEX_{ins} + CAPEX_{LN2} + CAPEX_{cryo} + CAPEX_{term}$$

$$\left\{ \begin{array}{l} CAPEX_{cryo} = n_{cables} c_{cryo} L_{line} \\ n_{cables} CAPEX_{term} \end{array} \right.$$

Economic model

Property	Symbol	Value
Cryostat cost per unit length	c_{cryo}	220 k€/km
Terminations cost for a single cable	$CAPEX_{term}$	400 k€

Technical model

Property	Symbol	Value
Line length	L_{line}	32 km

TEA on HTS cables → CAPEX → CAPEX_{cool}

$$CAPEX = CAPEX_{mat} + CAPEX_{cool} + CAPEX_{land} + CAPEX_{cab} + CAPEX_{vac} + CAPEX_{dism} + CAPEX_{other}$$

$$CAPEX_{cool} = n_{cables} \sum_k^{n_{stat}+2} \left\{ C_{cool_{fixed}} + [(c_{cryocooler} Q_{c_k}) \beta_Q] \beta_r \right\}$$

$$Q_{c_k} = \begin{cases} Q_f + Q_{an} & \text{if } k = \text{intermediate stat.} \\ Q_{an} + Q_{cl} & \text{if } k = \text{left termination stat.} \\ Q_f + Q_{cl} & \text{if } k = \text{right termination stat.} \end{cases}$$

Economic model		
Property	Symbol	Value
Fixed costs for each cooling station besides the device cost (installation, maintenance, disposal...)	$C_{cool_{fixed}}$	500 k€/km
Cryocoolers cost per unit of power	$c_{cryocooler}$	25 €/W
Mark-up to consider possible heat peaks	β_Q	1.1
Mark-up for the devices where no parametric cost function has been found (circulation pumps, LN ₂ tank...)	β_r	1.1

Technical model		
Property	Symbol	Value
N° of intermediate cooling stations	n_{stat}	5
Heat to be extracted from LN2 by k^{th} cryocoolers	Q_{c_k}	Cable design
Hydraulic power delivered by the k^{th} pumps to LN2	Q_{p_k}	Cable design

TEA on HTS cables \rightarrow CAPEX \rightarrow CAPEX_{cool} \rightarrow Losses

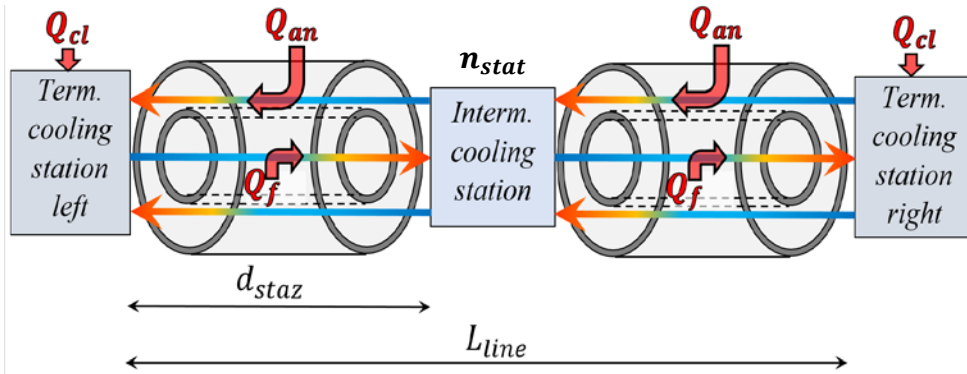

Note: the losses are conveniently divided based on which fluid will be affected into a cable segment (LN2 in the former or LN2 in the annular gap).

$$\left\{ \begin{aligned} Q_f &= \left(\frac{LOSS_{AC\ HTS} + LOSS_{ins} + LOSS_{eddy}}{2} \right) \left(\frac{1}{n_{stat} + 1} \right) \\ Q_{an} &= \left(\frac{LOSS_{AC\ HTS} + LOSS_{ins} + LOSS_{eddy}}{2} + LOSS_{cryo} \right) \left(\frac{1}{n_{stat} + 1} \right) \\ Q_{cl} &= \frac{LOSS_{term}}{2} \end{aligned} \right.$$

$\left\{ \begin{aligned} \text{intermediate station} &\rightarrow Q_f + Q_{an} \\ \text{left termination station} &\rightarrow Q_{an} + Q_{cl} \\ \text{right termination station} &\rightarrow Q_f + Q_{cl} \end{aligned} \right.$

TEA on HTS cables \rightarrow CAPEX \rightarrow $CAPEX_{land}$

$$CAPEX = CAPEX_{mat} + CAPEX_{cool} + CAPEX_{land} + CAPEX_{cab} + CAPEX_{vac} + CAPEX_{dism} + CAPEX_{other}$$

$$CAPEX_{land} = n_{cables} c_{land} L_{line} (2 R_{Blimit})$$

Economic model

Property	Symbol	Value
Land cost per unit of surface	c_{land}	20 €/km ²

Technical model

Property	Symbol	Value
Radial distance from the cable where the magnetic field is still greater than the limit (6 μT)	R_{Blimit}	0.3 m
Line length	L_{line}	32 km

TEA on HTS cables → CAPEX → $CAPEX_{cab}, CAPEX_{vac}, CAPEX_{dism}, CAPEX_{other}$

$$CAPEX = CAPEX_{mat} + CAPEX_{cool} + CAPEX_{land} + CAPEX_{cab} + CAPEX_{vac} + CAPEX_{dism} + CAPEX_{other}$$

$$\left\{ \begin{array}{l} CAPEX_{cab} = n_{cables} c_{cab} L_{line} \\ CAPEX_{vac} = n_{cables} c_{vac} L_{line} \\ CAPEX_{dism} = n_{cables} c_{dism} L_{line} \frac{1}{(1+r)^{years}} \\ CAPEX_{other} = n_{cables} c_{other} L_{line} \end{array} \right.$$

Economic model		
Property	Symbol	Value
Cabling cost per unit of length	c_{cab}	1 M€/km
Vacuum system cost per unit of length	c_{vac} [21]	52 k€/km
Dismantling cost per unit of length	c_{dism} [22]	20 k€/km
Other costs (commissioning, installation, civil eng., regulation, accessories) per unit of length	c_{other}	800 k€/km

Technical model		
Property	Symbol	Value
Annual interest ratio	r	5%
Total n° of years of operations	$years$	40
Line length	L_{line}	32 km

TEA on HTS cables → OPEX (total)

$$OPEX = OPEX_{cool} + OPEX_{maintenance}$$

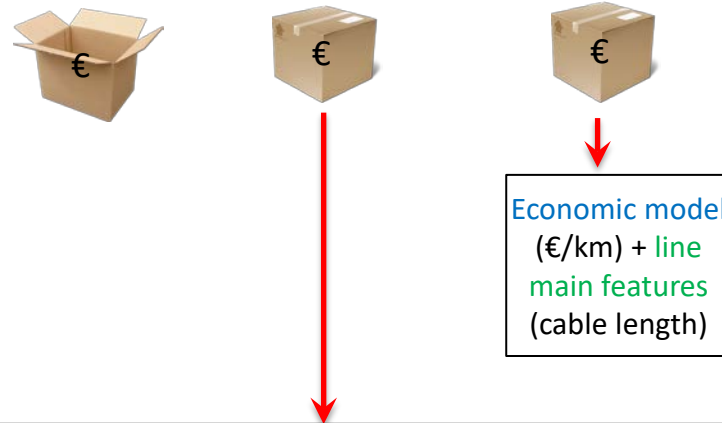

Economic model
(€/km) + line
main features
(cable length)

Economic model (energy cost)

+

Technical model:

- loss calculation
- estimate of ΔT_{LN2} , ΔP_{LN2} in each cable segment

Each term will be detailed in the next slides...

TEA on HTS cables \rightarrow OPEX \rightarrow $OPEX_{cool}$

$$OPEX = OPEX_{cool} + OPEX_{maintenance}$$

$$OPEX_{cool} = n_{cables} \sum_k^{n_{stat}+2} \left\{ \sum_{t=1}^{years} c_{kWh} h_y \left[\left(\frac{Q_{ck}}{\eta_{cry}} \frac{(T_a - T_0)}{T_0} \right) + \frac{Q_{pk}}{\eta_p} \right] \frac{1}{(1+r)^t} \right\}$$

Economic model		
Property	Symbol	Value
Actual energy cost	C_{kWh}	0.015 €/kWh

Technical model		
Property	Symbol	Value
N° of intermediate cooling stations	n_{stat}	5
Hours of operation in a year	h_y	8760
Total n° of years of operations	$years$	40
Annual interest ratio	r	5%
Ambient temperature (outside the cable)	T_a	300 K
T_{LN2} at the beginning of each cable section (both in the former and in the annulus)	T_0	68 K
Heat to be extracted from LN2 by the cryocoolers of intermediate cooling stations	$Q_f + Q_{an}$	89.3 kW
Heat to be extracted from LN2 by the cryocoolers of left side cooling station	$Q_{an} + Q_{cl}$	53.3 kW
Heat to be extracted from LN2 by the cryocoolers of right side cooling station	$Q_f + Q_{cl}$	41.3 kW
Hydraulic power delivered by the pumps of intermediate cooling stations to LN2	$m_{LN2} \frac{\Delta P_f + \Delta P_{an}}{\rho_{LN2}}$	2 kW
Hydraulic power delivered by the pumps of left side cooling stations to LN2	$\frac{m_{LN2} \Delta P_{an}}{\rho_{LN2}}$	1.2 kW
Hydraulic power delivered by the pumps of right side cooling stations to LN2	$\frac{m_{LN2} \Delta P_f}{\rho_{LN2}}$	0.8
Cryocoolers efficiency	η_{cry}	10%
Pumps efficiency	η_p	70%

TEA on HTS cables \rightarrow OPEX \rightarrow $OPEX_{cool}$ \rightarrow Losses & ΔP

$$OPEX_{cool} = \sum_k^{n_{stat}+2} \left\{ \sum_{t=1}^{years} c_{kWh} h_y \left[\left(\frac{Q_{ck}}{\eta_{cry}} (T_a - T_{ann}) \right) + \frac{Q_{pk}}{\eta_p} \right] \frac{1}{(1+r)^t} \right\}$$

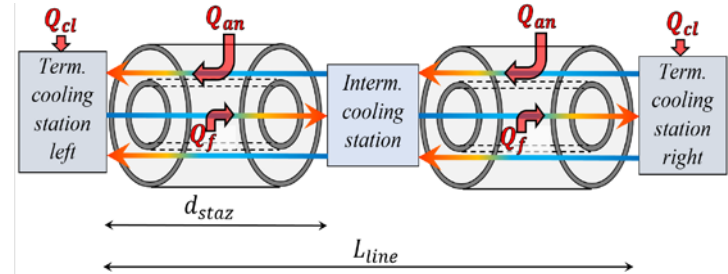

$$Q_{ck} = \begin{cases} Q_f + Q_{an} & \text{if } k = \text{intermediate stat.} \\ Q_{an} + Q_{cl} & \text{if } k = \text{left termination stat.} \\ Q_f + Q_{cl} & \text{if } k = \text{right termination stat.} \end{cases}$$



Losses to be managed by each cooling /pumping station.

$$Q_{pk} = \begin{cases} m_{LN2} \frac{\Delta P_f + \Delta P_{an}}{\rho_{LN2}} & \text{if } k = \text{intermediate stat.} \\ \frac{m_{LN2} \Delta P_{an}}{\rho_{LN2}} & \text{if } k = \text{left termination stat.} \\ \frac{m_{LN2} \Delta P_f}{\rho_{LN2}} & \text{if } k = \text{right termination stat.} \end{cases}$$



Hydraulic power to be managed by each cooling/pumping station to restore LN2 pressure.

Note: these losses and these ΔP are computed in single cable segments between 2 adjacent cooling stations.

Technical model		
Property	Symbol	Value
LN2 mass flow rate	m_{LN2}	2.15 kg/s
LN2 density	ρ_{LN2}	839 kg/m ³

TEA on HTS cables \rightarrow OPEX \rightarrow $OPEX_{maintenance}$

$$OPEX = OPEX_{cool} + OPEX_{maintenance}$$

$$OPEX_{maintenance} = n_{cables} \sum_{t=1}^{years} \frac{L_{line} C_{maint}}{(1+r)^t}$$

Economic model

Property	Symbol	Value
Maintenance cost per unit of length per year	C_{maint}	3 k€/km/year

[8]

Technical model

Property	Symbol	Value
Total n° of years of operations	$years$	40
Annual interest ratio	r	5%
Line length	L_{line}	32 km

III. TEA of HTS cable system

Phase 4 – Interpretation

TEA on HTS cables → Interpretation

Lastly, we can use our TEA model to interpret the results obtained and understand whether certain decisions/changes to our project could make it more or less convenient.

To do this, we will modify some input data of our **Inventory Analysis** sheet and compare the results of proposed parametric studies in the **Interpretation sheet** of our Excel file.

Transmission link between solar plant and substation							
Phase 4: Interpretation							
Sensitivity analysis							
Case	Conventional cable			HTS busbar			Units
	LCC	CAPEX_0	OPEX_0	LCC	CAPEX_0	OPEX_0	
T = 40 y ; r = 0.05 ; c_en = 0.015 €/kWh ; nhpy = 8h/day ; c_HTS = 30 €/m ; c_land = 20 €/m2 ; Ic_HTS_77K = 293.7 A (REFERENCE)							€
T = 40 y ; r = 0.0							€
T = 25 y ; r = 0.05							€
c_en = 0.05 €/kWh							€
nhpy = 24h/day							€
c_HTS = 10 €/m							€
c_land = 120 €/m2 (and maybe also Bfield < 0.5 μT, so you have to increase R_field?)							€
Ic_HTS_77K = 250 A							€
w_HTS = 12 mm (and then multiply by 3 also the critical current and the cost, accordingly)							€

IV. To go further...

Cable optimization modelling

You will have noticed that by modifying the **input design parameters** of our Excel file, the constraints imposed may no longer be respected. Furthermore, even if we could change those values freely, it is not immediately clear how these affect costs.

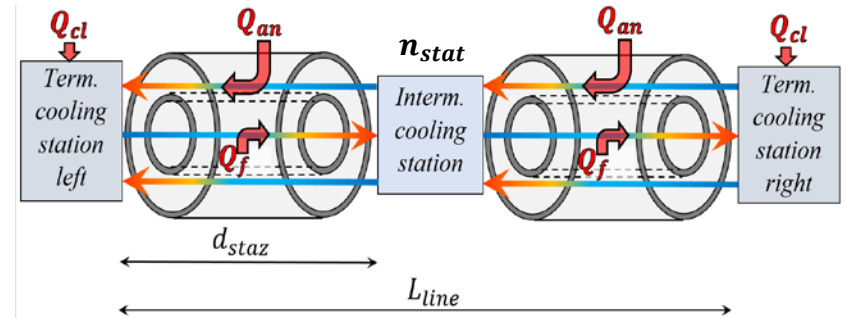
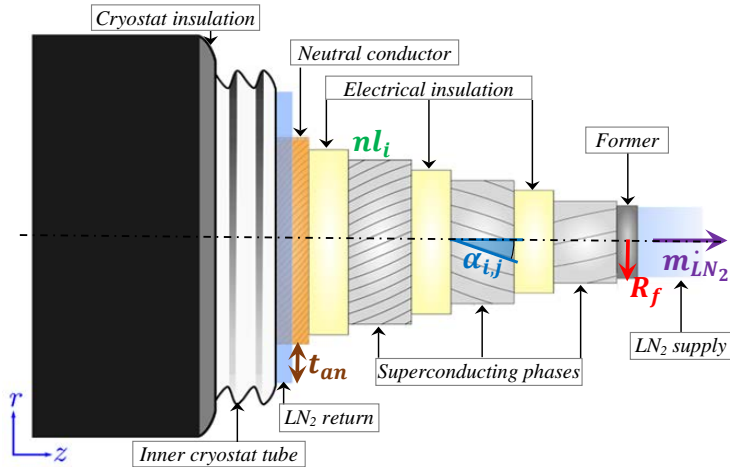

Technical model – Main features

Property	Symbol	Value
Cable power	P	750 MW
Voltage rms	V_{rms}	33 kV L-L RMS
Load factor	$\cos\varphi$	0.95
rms value of the total AC current in each phase	I_{rms}	$I_{rms} = \frac{P}{\sqrt{3} V_{rms} \cos\varphi} = 13.81 \text{ kA}$
Line length	L_{line}	32 km

Technical model

Property	Symbol	Value
Former radius (inner)	R_{former}	30 mm
LN2 mass flow rate	m_{LN2}	2.15 kg/s
Twist angle for each layer of phase 1	$\alpha_{1,1}, \alpha_{2,1}$	11°, 15°
Twist angle for each layer of phase 2	$\alpha_{1,2}$	-13°
Twist angle for each layer of phase 3	$\alpha_{1,3}$	-14°
N° of HTS layers for phase 1	n_{l_1}	2
N° of HTS layers for phase 2	n_{l_2}	1
N° of HTS layers for phase 3	n_{l_3}	1
Thickness of the annular gap	$t_{annulus}$	27.8 mm
N° of intermediate cooling stations	n_{stat}	5

Cable optimization modelling

Indeed, we cannot perform a fine optimization of the cable design with our Excel.

The “suggested” input parameters that we have used are the outputs coming from another optimization tool, computed for a specific combination of operating parameters.

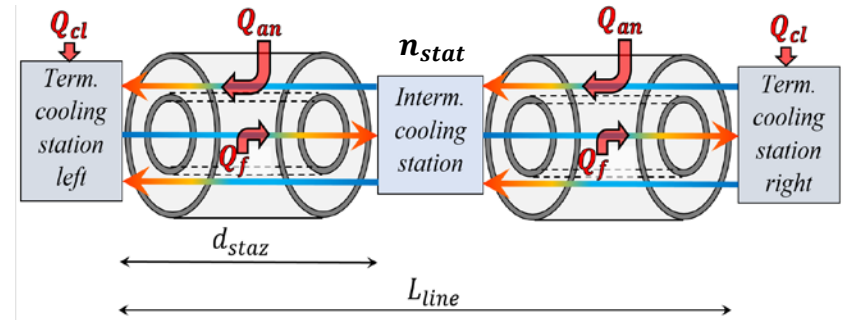
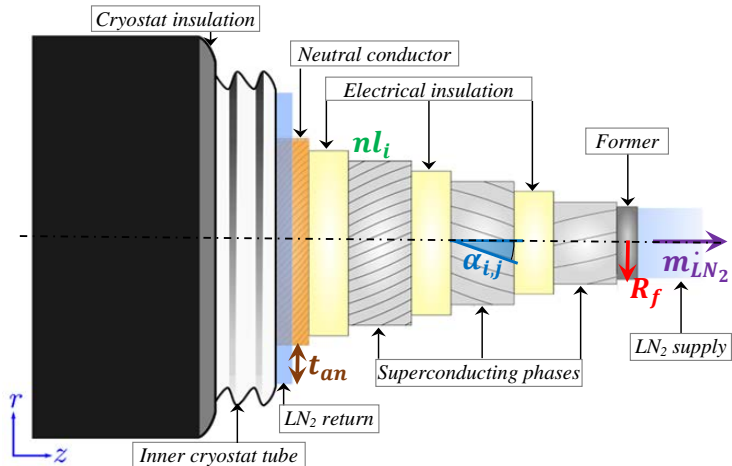

Technical model – Main features

Property	Symbol	Value
Cable power	P	750 MW
Voltage rms	V_{rms}	33 kV L-L RMS
Load factor	$\cos\varphi$	0.95
rms value of the total AC current in each phase	I_{rms}	$I_{rms} = \frac{P}{\sqrt{3} V_{rms} \cos\varphi} = 13.81 \text{ kA}$
Line length	L_{line}	32 km

Technical model

Property	Symbol	Value
Former radius (inner)	R_{former}	30 mm
LN2 mass flow rate	m_{LN2}	2.15 kg/s
Twist angle for each layer of phase 1	$\alpha_{1,1}, \alpha_{2,1}$	11°, 15°
Twist angle for each layer of phase 2	$\alpha_{1,2}$	-13°
Twist angle for each layer of phase 3	$\alpha_{1,3}$	-14°
N° of HTS layers for phase 1	n_{l_1}	2
N° of HTS layers for phase 2	n_{l_2}	1
N° of HTS layers for phase 3	n_{l_3}	1
Thickness of the annular gap	$t_{annulus}$	27.8 mm
N° of intermediate cooling stations	n_{staz}	5

Cable optimization modelling

We would like to have a tool that automatically computes the combination of design parameters optimized for a given criteria (e.g., minimum cost while complying with constraints).

The one developed by RSE is presented here, but there are numerous options available, and everyone can create their own



What matters most is to grasp the approach!

Technical model – Main features

Property	Symbol	Value
Cable power	P	750 MW
Voltage rms	V_{rms}	33 kV L-L RMS
Load factor	$\cos\varphi$	0.95
rms value of the total AC current in each phase	I_{rms}	$I_{rms} = \frac{P}{\sqrt{3} V_{rms} \cos\varphi} = 13.81 \text{ kA}$
Line length	L_{line}	32 km

Technical model

Property	Symbol	Value
Former radius (inner)	R_{former}	30 mm
LN2 mass flow rate	m_{LN2}	2.15 kg/s
Twist angle for each layer of phase 1	$\alpha_{1,1}, \alpha_{2,1}$	11°, 15°
Twist angle for each layer of phase 2	$\alpha_{1,2}$	-13°
Twist angle for each layer of phase 3	$\alpha_{1,3}$	-14°
N° of HTS layers for phase 1	n_{l_1}	2
N° of HTS layers for phase 2	n_{l_2}	1
N° of HTS layers for phase 3	n_{l_3}	1
Thickness of the annular gap	$t_{annulus}$	27.8 mm
N° of intermediate cooling stations	n_{stat}	5

Cable optimization modelling

OSCaR: a tool for techno-economic assessment of superconducting power cables [1, 2]

Optimization tool for **S**uperconducting **C**able **R**esearch

- ❑ **Scope of the tool:** determine the optimized cable design according to the operating parameters selected by the user (e.g. active power, voltage level, line length).
- ❑ A **constrained minimization problem** for a multi-variable function (the **cable system cost**) is solved using a **genetic algorithm** in MATLAB.
- ❑ The first version of the code refers to the so-called **coaxial configuration** of AC HTS cables. The cooling configuration adopted is the so-called **both-sided cooling option**, with 2 counter-flows of liquid nitrogen.
- ❑ **Multiple constraints are imposed** (e.g. currents balancing between phases and layers, maximum current in the tapes, coolant temperature and pressure).

Activity carried out in collaboration with the University of Bologna



[1] A. Musso et al., IEEE Trans. On Appl. Supercond., vol. 32, no. 9, p. 4803516, 2022.
 [2] A. Musso et al., IEEE Trans. On Appl. Supercond., vol. 33, no. 5, p. 5401105, 2023.
 [3] M. Noe, EUCAS Short Course, 2017.

Cable optimization modelling

OSCaR: a tool for techno-economic assessment of superconducting power cables

- ❑ The capital and operating cost indexes and the heat inputs calculations are parameterized to the cable design features.
- ❑ The optimized cable parameters considered are:
 - the n° of layers per phase (n_{l_i});
 - the winding angle in each layer ($\alpha_{i,j}$);
 - the former radius (R_f);
 - the annular gap thickness (t_{an});
 - the LN₂ mass flow rate (m_{LN2});
 - the n° of cooling stations (n_{stat}).

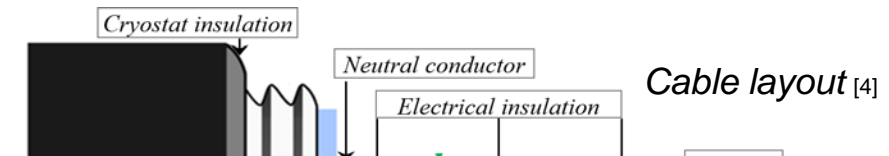

The same technical and economic models that we set in our Excel file are implemented in the code. What changes is the numerical approach to the problem, making the PC do numerous iterations to reach a certain goal.

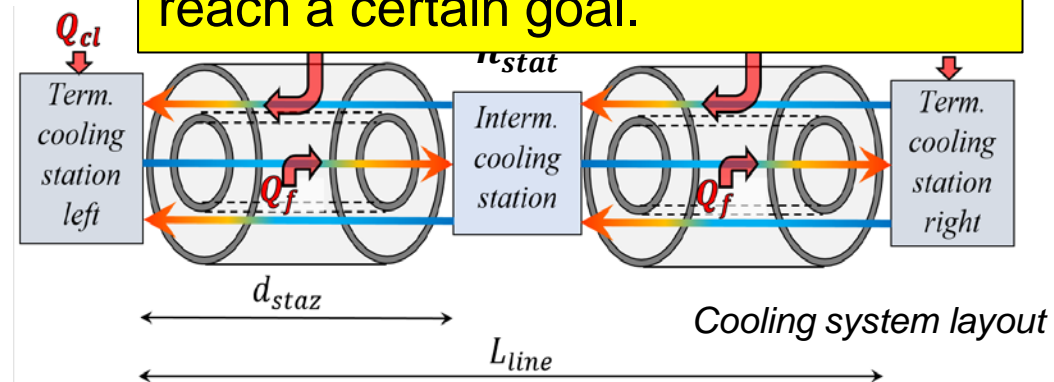

[4] W. T. B. de Sousa et al., Supercond. Sci. Technol, vol. 34, 2021.

Cable optimization modelling

OSCaR: a tool for techno-economic assessment of superconducting power cables

The cable system cost is the function to be minimized (we want to most economically convenient cable). The “genes”/”design parameters” have been parametrized to this cost, in the same way we have done in our Excel file.

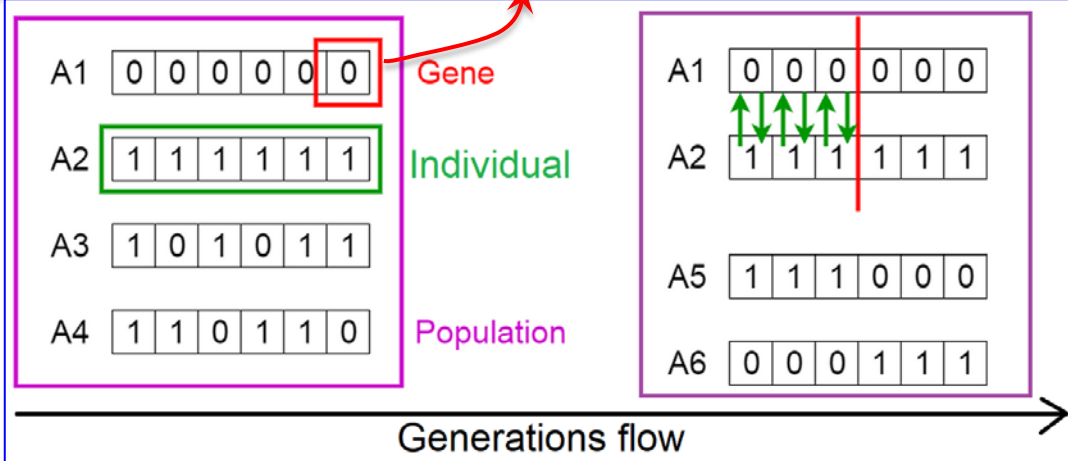
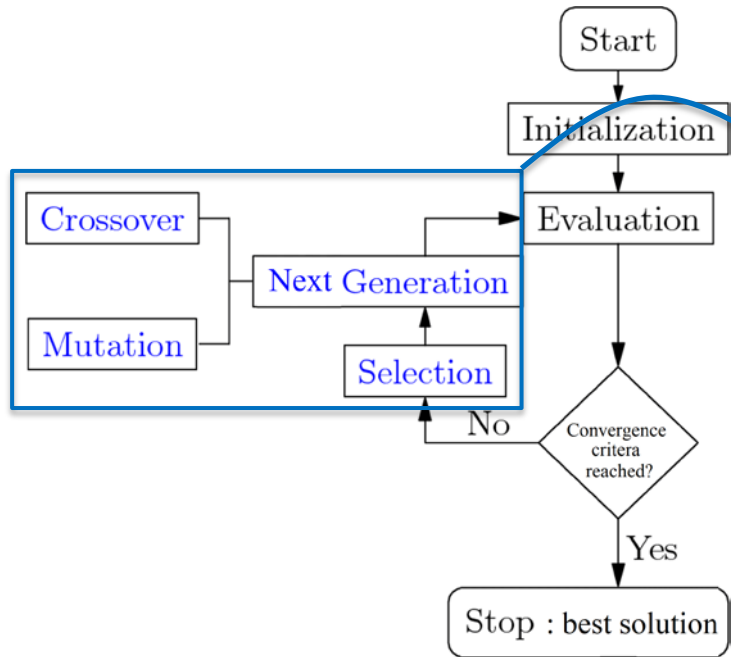
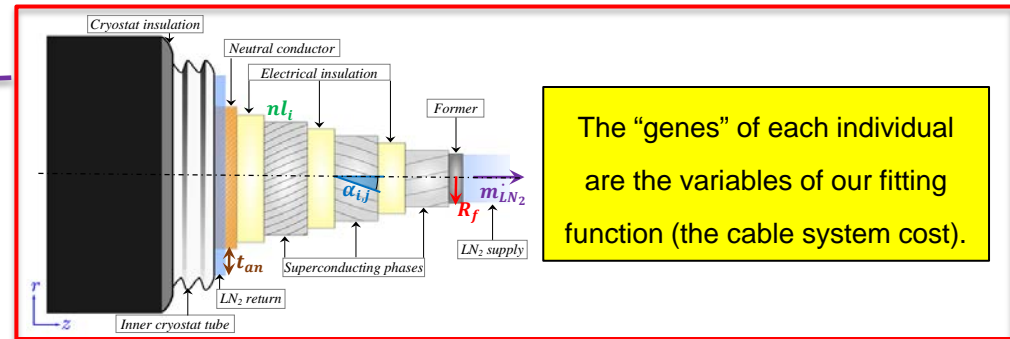

Cable optimization modelling

OSCaR: a tool for techno-economic assessment of superconducting power cables

- ❑ The capital and operating cost indexes and the heat inputs calculations are parameterized to the cable design features.
- ❑ The optimized cable parameters considered are:
 - the n° of layers per phase (n_{l_i});
 - the winding angle in each layer ($\alpha_{i,j}$);
 - the former radius (R_f);
 - the annular gap thickness (t_{an});
 - the LN₂ mass flow rate (\dot{m}_{LN_2});
 - the n° of cooling stations (n_{stat}).

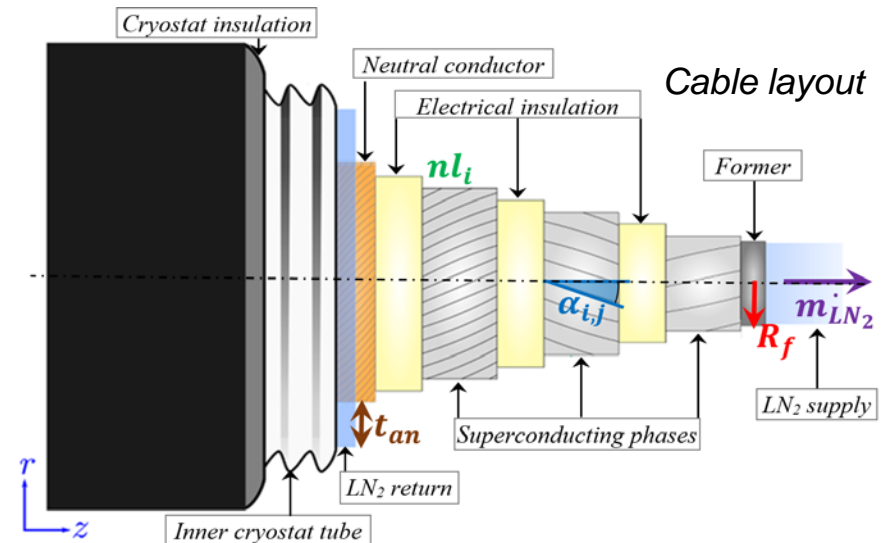

The algorithm selects only the individuals who comply with the imposed constraints. Furthermore, we can "facilitate" its task by suggesting upper and lower boundaries for each variable (e.g. include the radius of the former between a certain minimum and maximum values) and/or a sensible initial solution.

Cable optimization modelling

OSCaR: a tool for techno-economic assessment of superconducting power cables

The main **constraints** applied regards:

- the **currents balancing** between phases and layers;

You can tune the radius of each layer (if allowed) and the winding angle to obtain a balance of their inductances (inductances play a fundamental role in the current distribution in superconducting windings).

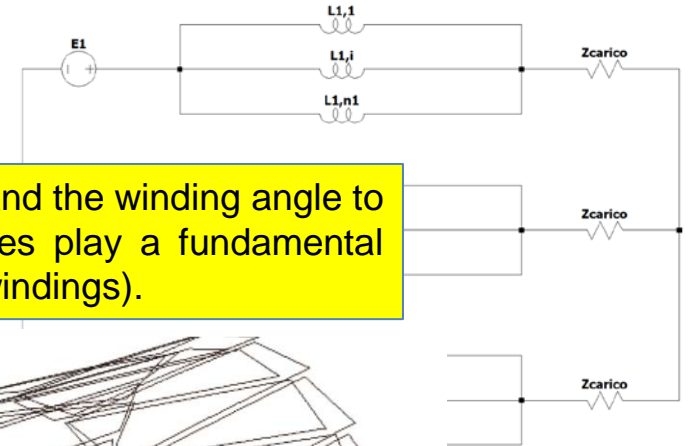

$$\begin{cases} \underline{E}_1 = \frac{V_{rms}}{\sqrt{3}} = \sum_{j=1}^{3 \text{ n}^\circ \text{ layers } p} \\ \underline{E}_2 = \frac{V_{rms}}{\sqrt{3}} e^{-j\frac{2}{3}\pi} \\ \underline{E}_3 = \frac{V_{rms}}{\sqrt{3}} e^{j\frac{2}{3}\pi} \end{cases}$$

$$\sum_j^{3 \text{ n}^\circ \text{ layers } pha} \sum_h$$

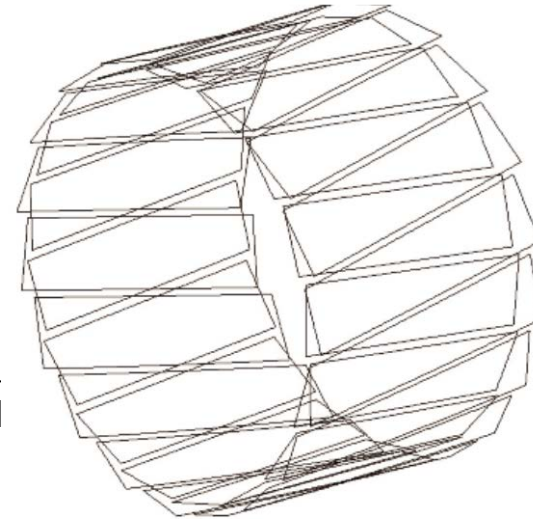
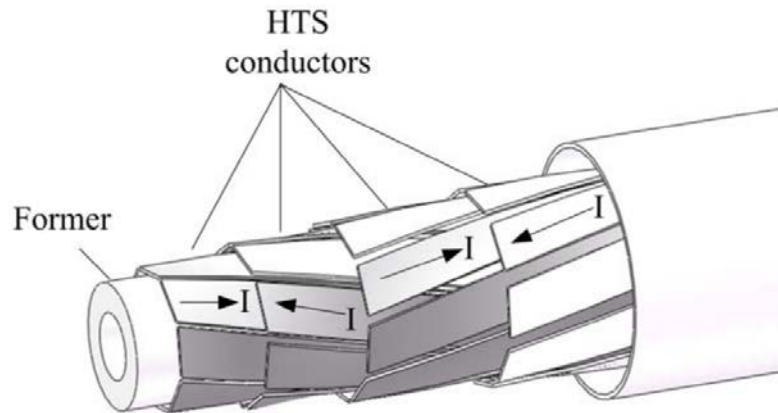

$$\frac{r_{i,k}}{r_{j,h}} \tan(\alpha_{i,k}) \tan(\alpha_{j,h}) e^{j\varphi}$$

e system → a modules and on

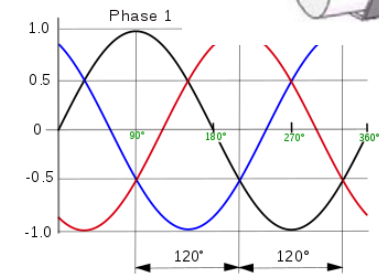

maximum tolerance is imposed their phase shift.

- if some phases are composed of more than 1 layer, "it makes sense" that the current is distributed uniformly between them → a maximum tolerance is imposed on the difference between the modules of the layers currents.

Cable optimization modelling

OSCaR: a tool for techno-economic assessment of superconducting power cables

The main **constraints** applied regards:

- ❑ the **currents balancing** between phases and layers;
- ❑ the **maximum current** in the HTS tapes;

The same we applied in our Excel file.

$$\left\{ \begin{array}{l} \frac{\sqrt{2} I_{rms}}{Tapes_{i,j}} / I_c \left(\max [T_{HTS_{left}}, T_{HTS_{right}}] \right) \leq safety_{HTS} \\ Tapes_{i,j} = round \left(\frac{2\pi R_{HTS_{i,j}} |\cos(\alpha_{i,j})|}{w_{HTS}} \right) \end{array} \right.$$

Cable optimization modelling

OSCaR: a tool for techno-economic assessment of superconducting power cables

The main **constraints** applied regards:

- ❑ the **currents balancing** between phases and layers;
- ❑ the **maximum current** in the HTS tapes;
- ❑ the **coolant temperature and pressure**;

We may apply the same equations as in our Excel file.

$$\Delta T_{former} \leq \Delta T_{LN2max} \Rightarrow \Delta T_{former} = d_{stat} \left(\frac{v_{LN2former}^2 f_{LN2former}}{4 R_{former} c_{pLN2}} \right) + \frac{Q_f}{2 m_{LN2} c_{pLN2}}$$

$$\Delta T_{annulus} \leq \Delta T_{LN2max} \Rightarrow \Delta T_{annulus} = d_{stat} \left(\frac{v_{LN2annulus}^2 f_{LN2annulus}}{4 t_{annulus} c_{pLN2}} \right) + \frac{Q_{an}}{2 m_{LN2} c_{pLN2}}$$

$$\Delta P_{former} \leq \Delta P_{LN2max} \Rightarrow \Delta P_{former} = \left(d_{stat} \frac{\rho_{LN2} v_{LN2former}^2 f_{LN2former}}{4 R_{former}} \right) + (g \rho_{LN2} \Delta h)$$

$$\Delta P_{annulus} \leq \Delta P_{LN2max} \Rightarrow \Delta P_{annulus} = \left(d_{stat} \frac{\rho_{LN2} v_{LN2annulus}^2 f_{LN2annulus}}{4 t_{annulus}} \right) + (g \rho_{LN2} \Delta h)$$

Cable optimization modelling

OSCaR: a tool for techno-economic assessment of superconducting power cables

The main **constraints** applied regards:

- ❑ the **currents balancing** between phases and layers;
- ❑ the **maximum current** in the HTS tapes;
- ❑ the **coolant temperature and pressure**;

Or we may consider more complex fluid-dynamics models.

$$\begin{bmatrix} \frac{\partial T}{\partial x} \\ \frac{\partial \rho}{\partial x} \end{bmatrix} = [Q_{\delta T \delta \rho}(\rho, T)]^{-1} \begin{bmatrix} - \int_0^{d_{stat}} [Q_{f/an}(T)] a_c dx - \frac{\dot{m}_c \tau_c P_c}{a_c^2 \rho} \\ \dot{m}_c g \sin \beta + \frac{\dot{m}_c \tau_c P_c}{a_c^2 \rho} \end{bmatrix}$$

$$[Q_{\delta T \delta \rho}(\rho, T)]^{-1} = \frac{1}{\Delta Q_{\delta T \delta \rho}(\rho, T)} \begin{bmatrix} G_{\delta \rho}(\rho, T) & -H_{\delta \rho}(\rho, T) \\ -G_{\delta T}(\rho, T) & H_{\delta T}(\rho, T) \end{bmatrix}$$

$$\Delta Q_{\delta T \delta \rho}(\rho, T) = H_{\delta T}(\rho, T)G_{\delta \rho}(\rho, T) - G_{\delta T}(\rho, T)H_{\delta \rho}(\rho, T)$$

$$H_{\delta T} = \frac{\dot{m}_c}{a_c \rho} \left(\frac{\partial P}{\partial T} - \rho \frac{\partial h}{\partial T} \right) ; \quad H_{\delta \rho} = \frac{\dot{m}_c}{a_c \rho} \left(\frac{\partial P}{\partial \rho} - \rho \frac{\partial h}{\partial \rho} \right)$$

$$G_{\delta T} = - \frac{\dot{m}_c}{a_c \rho} \frac{\partial P}{\partial T} ; \quad G_{\delta \rho} = \frac{\dot{m}_c}{a_c \rho} \left(\frac{\dot{m}_c^2}{\rho^2} - \frac{\partial P}{\partial \rho} \right)$$

System of non-linear differential equations obtained from the equations of energy and momentum conservation and the continuity equation, considering stationary conditions, and applying a 1-dimensional (the cable length x) approximation.

The system needs to be solved numerically. It is more accurate as it mathematically models all the thermodynamic and thermo-physic properties of the cryogenic fluid considered.

Double these equations for the LN2 in the former and in the annular gap

[6] G. Angeli et al., IEEE Trans. Appl. Supercond., vol. 27, no. 4, 2017, p. 5600406.

Cable optimization modelling

OSCaR: a tool for techno-economic assessment of superconducting power cables

The main **constraints** applied regards:

- ❑ the **currents balancing** between phases and layers;
- ❑ the **maximum current** in the HTS tapes;
- ❑ the **coolant temperature and pressure**;
- ❑ the **distance between adjacent tapes** in each layer;
- ❑ the **line voltage drop**.

To ensure that the loads connected to the cable can operate at a voltage level close to their design value, the voltage drop across L_{line} has to be lower than a certain maximum percentage of the design voltage V_{rms} , imposed by the user and generally dependent on grid regulations.

$$\frac{\omega \left| [M] \cdot [I_{i,j}] \right|}{V_{rms}} \leq 4\% \quad \begin{cases} \text{for } i = 1, 2, 3 \\ \text{for } j = 1, \dots, nl_i - 1 \end{cases}$$

If the tapes are too far apart (gap > 3 w_{HTS}), their applied transverse magnetic fields do not cancel out and this impacts both their critical current and AC losses.

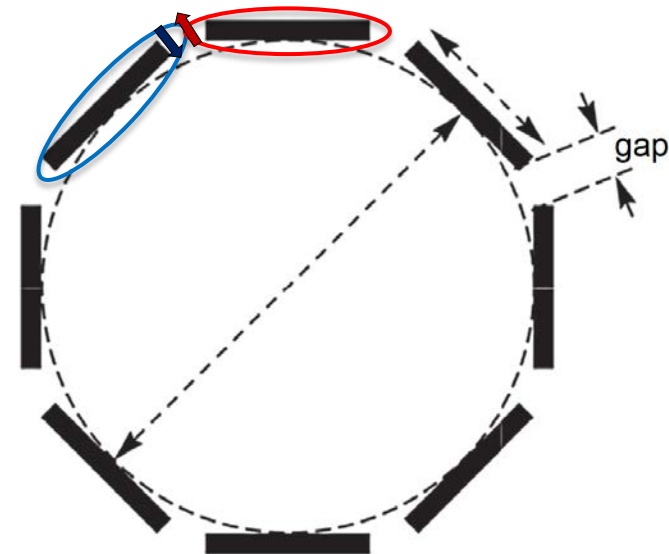

Cable optimization modelling

OSCaR: a tool for techno-economic assessment of superconducting power cables

The main **constraints** applied regards:

- the **currents balancing** between phases and layers;
- the **maximum current** in the HTS tapes;
- the **coolant temperature and pressure**;
- the **distance between adjacent tapes** in each layer;
- the **line voltage drop**.

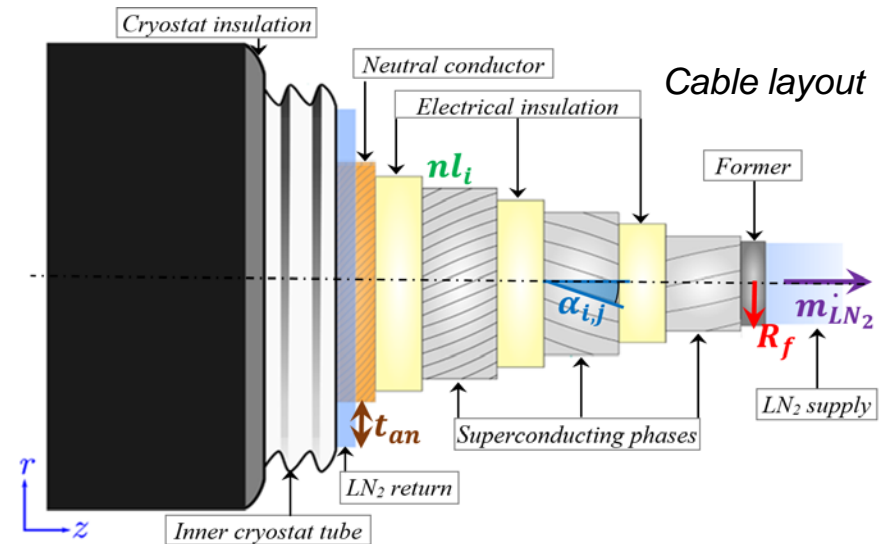

The user can select the **operating conditions**:

- the **active power** to be transferred through the line (P);
- the **voltage level**, in the medium voltage range (V_{rms});
- the **line length** (L_{line});
- the **load factor** ($\cos\phi$);



Technical model – Main features		
Property	Symbol	Value
Cable power	P	?
Voltage rms	V_{rms}	?
Load factor	$\cos\phi$?
Line length	L_{line}	?

Cable optimization modelling

OSCaR: a tool for techno-economic assessment of superconducting power cables

The main objective is to size the cable design for the maximum power it can reach.

- the number of layers;
- the **maximum current** in the HTS;
- the **coolant temperature and pressure** in each layer;
- the **distance between adjacent layers** in each layer;
- the **line voltage drop**.

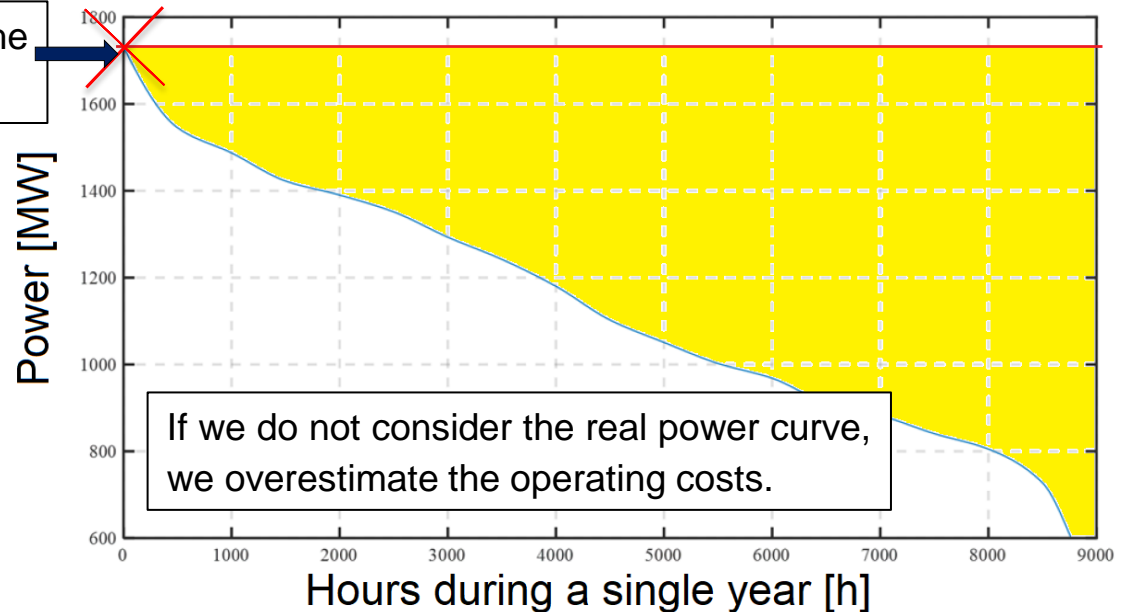

The user can select the **operating conditions**:

- the **active power** to be transferred through the line (P);
- the **voltage level**, in the medium voltage range (V_{rms});
- the **line length** (L_{line});
- the **load factor** ($\cos\phi$);

A cable might not always carry the maximum current/power all year round.

Cable optimization modelling

OSCaR: a tool for techno-economic assessment of superconducting power cables

In the end, for each combination of operating parameters selected by the user, the tool returns:

- ❑ The cost of the cable system (which has to be minimized), with details of the single cost indexes.
- ❑ The optimized design parameters corresponding to that cable cost.
- ❑ All the other cable design parameters calculated in cascade from the optimized parameters.
- ❑ A quantification of compliance with the various constraints



This "automated" approach is well suited to perform various parametric analyses.

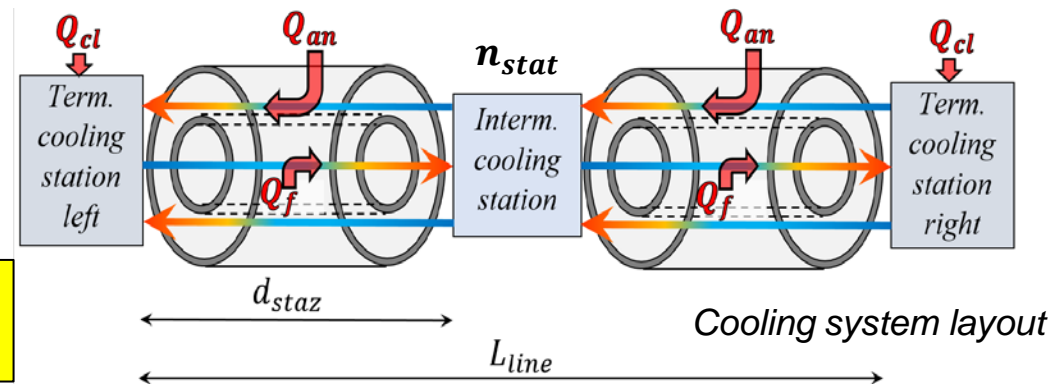
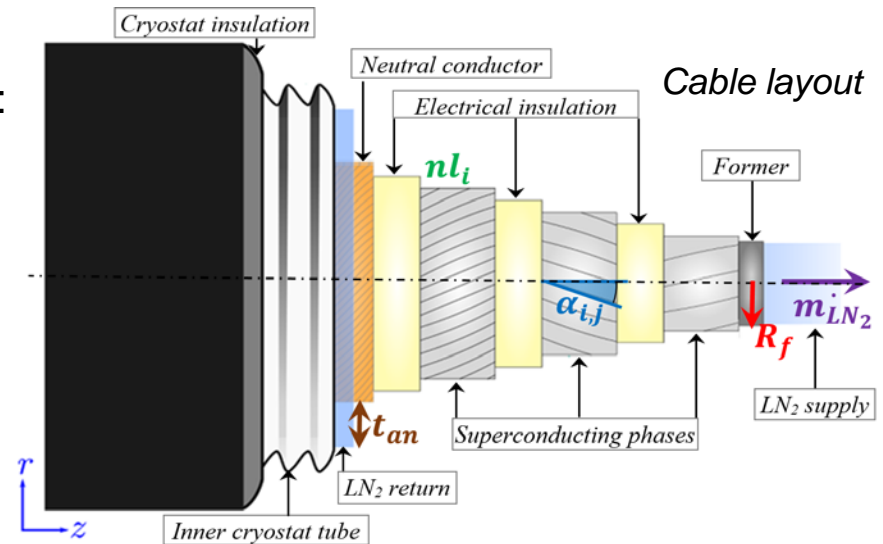

OSCaR: examples of parametric analyses

CASE STUDY : Line length = 5 km ; $V_{rms} = 15$ kV ; $\cos\phi = 0.9$

Active power

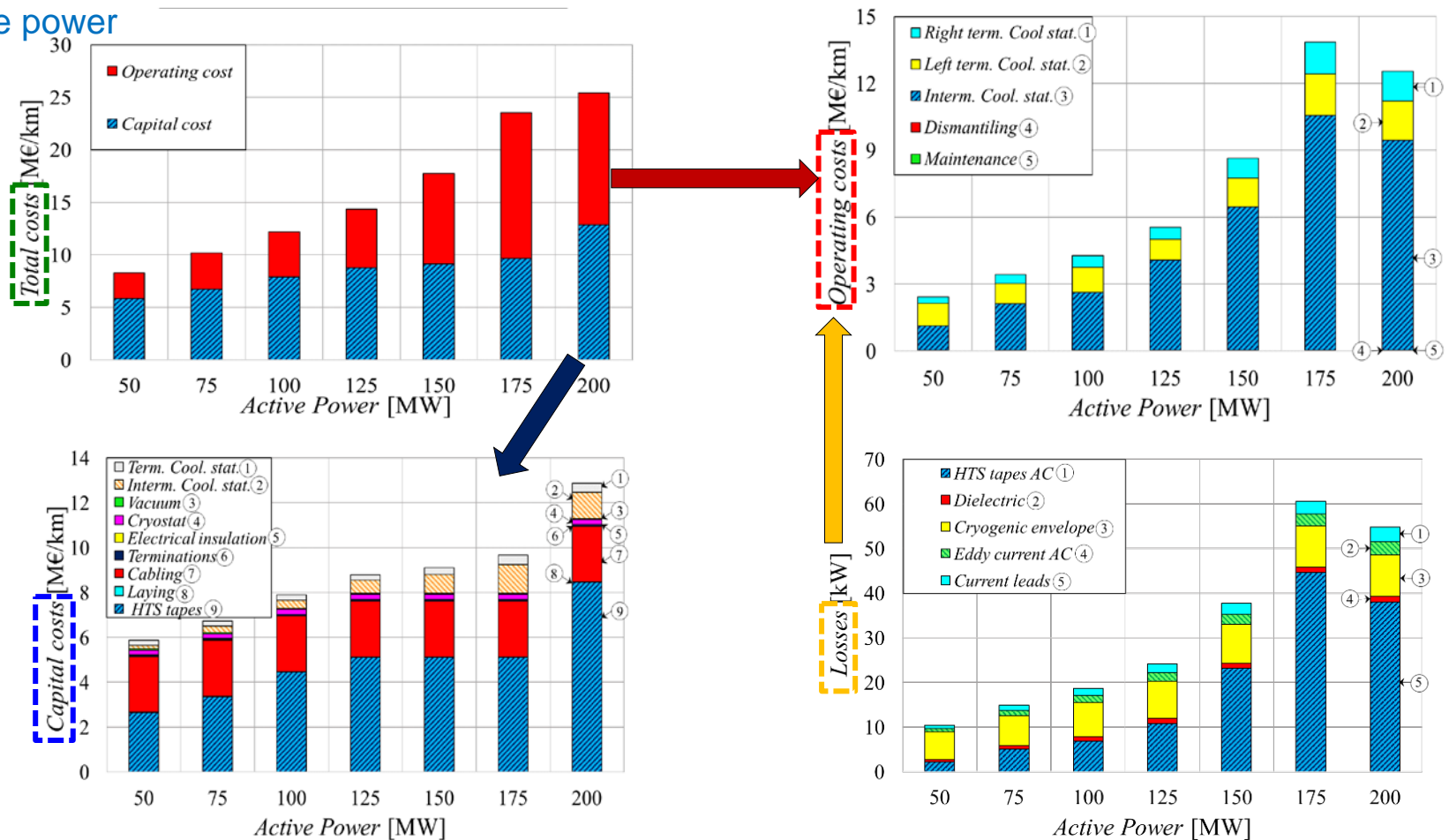

OSCaR: examples of parametric analyses

Voltage

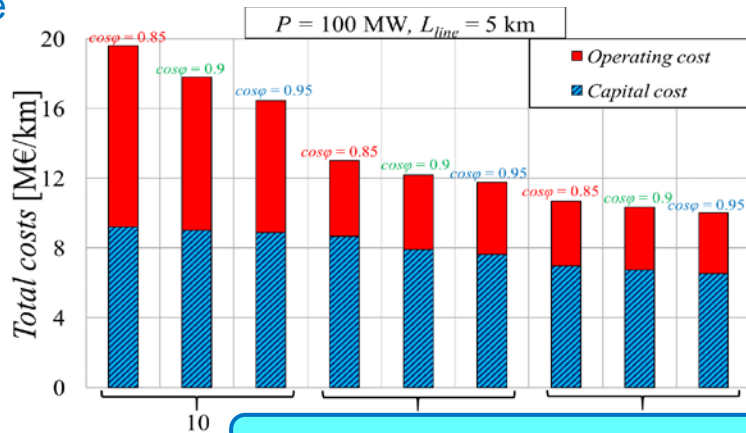

AC losses

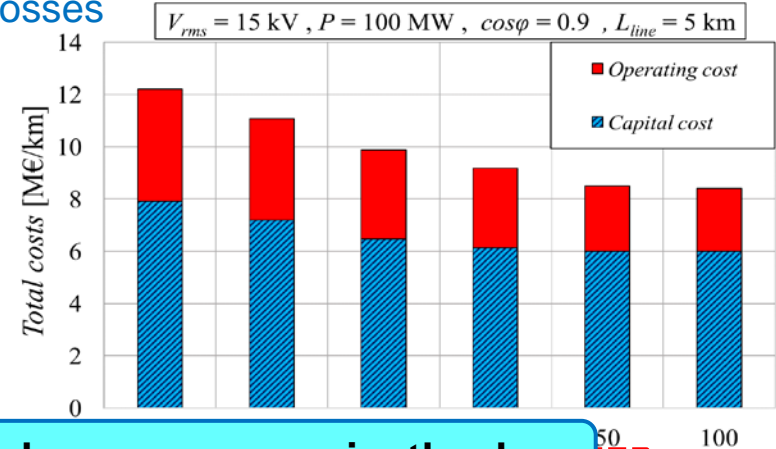

The methodological approach can conveniently be adapted to other superconducting cable configurations.

Tape cost

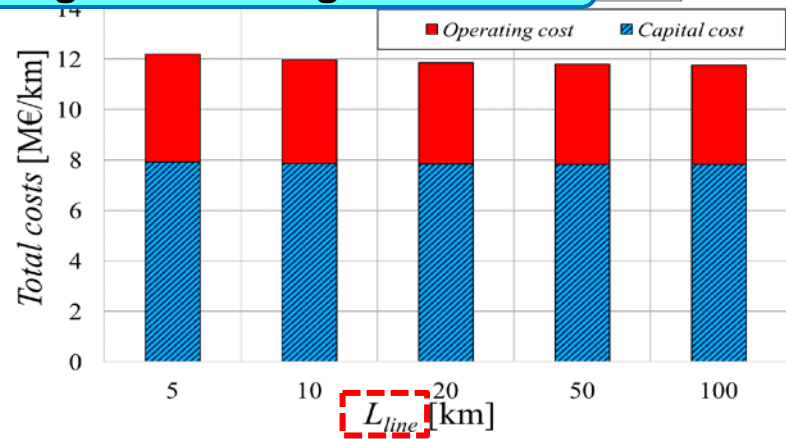
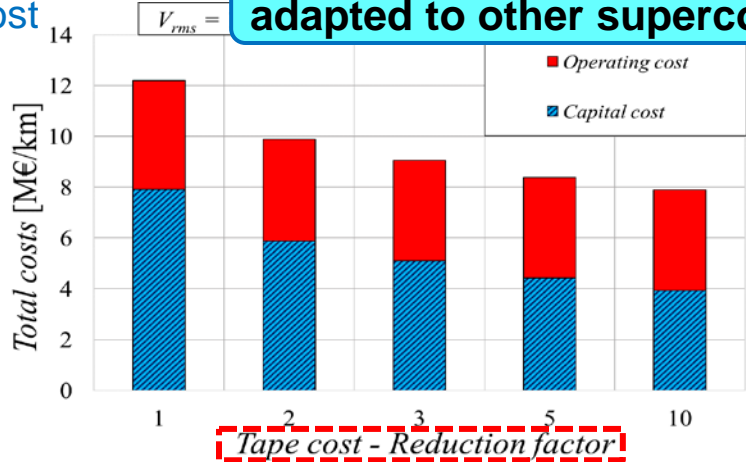

OSCaR: application to MgB₂ DC cables

New cable architecture → adequate update of the cost indexes, constraints and losses terms.



The methodology remains the same.

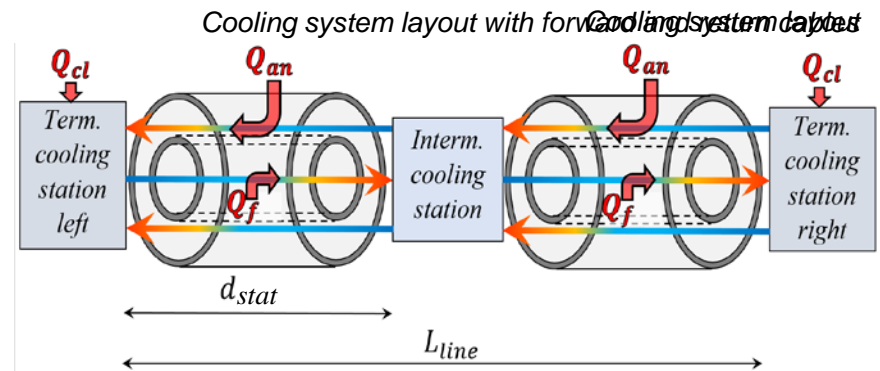
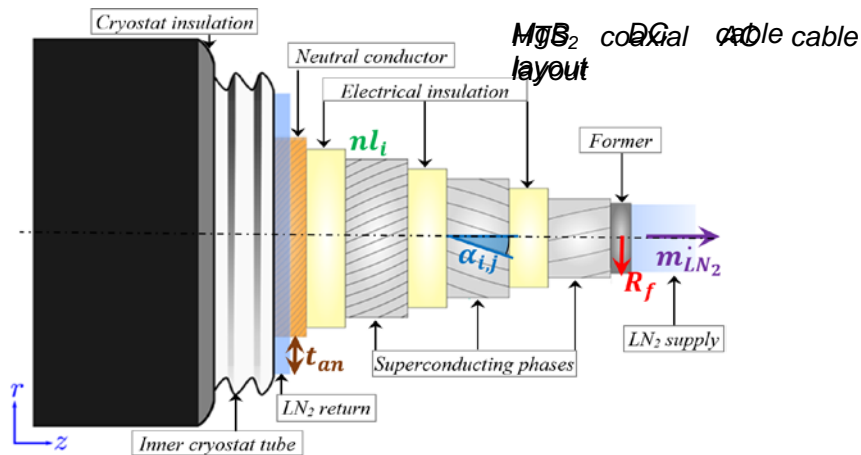

$$C_{tot} = \underbrace{C_{MgB_2} + C_{ins} + C_{cool} + C_{Cu} + C_{stat_cap} + C_{cryo} + C_{vac} + C_{ter} + C_{cab} + C_{lay}}_{\text{Capital costs}} + \underbrace{C_{stat_op} + C_{man} + C_{dis}}_{\text{Operating costs}}$$

- C_{MgB_2} = cost for the total length of MgB₂ wires;
- C_{ins} = cost for the insulator;
- C_{cool} = cost for the cryogenic fluid (closed cycle);
- C_{Cu} = cost for copper (neglecting other materials);
- C_{stat_op} = capital cost for all the cooling stations;

- C_{vac} = cost for the vacuum system;
- C_{ter} = cost for terminations at the cable ends;
- C_{cab} = cost for cabling;
- C_{lay} = cost for cable laying into the tunnel;
- C_{cryo} = cost for the cryostat.

- C_{stat} = cost for the electricity needed to operate all the cooling stations;
- C_{man} = cost for cable maintenance over its life-time (40 years);
- C_{dis} = cost for cable dismantling.

[5] A. Musso et al., IEEE Trans. On Appl. Supercond., vol. 34, no. 3, p. 6200607, 2024.

OSCaR: application to MgB₂ DC cables

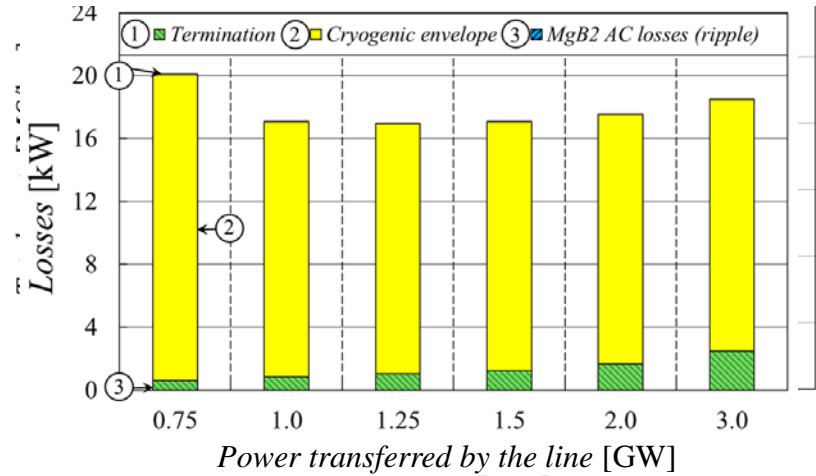
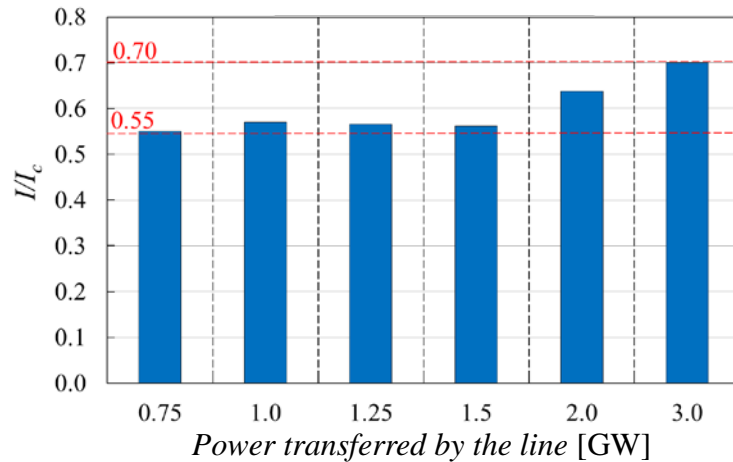
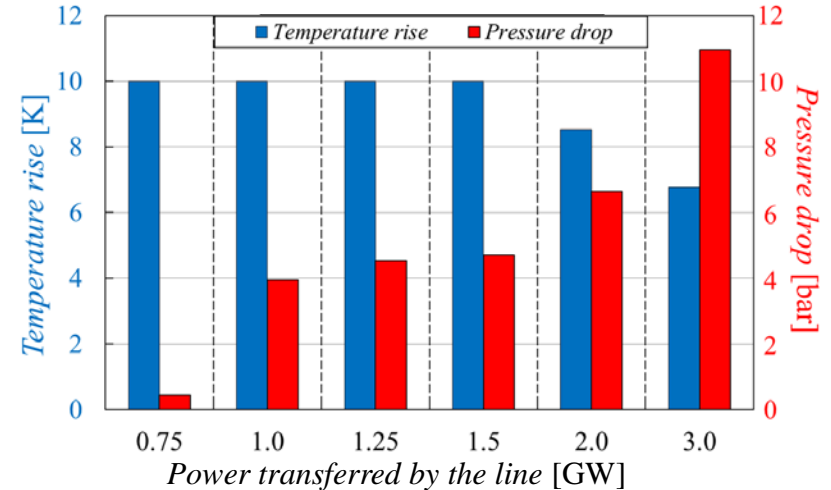
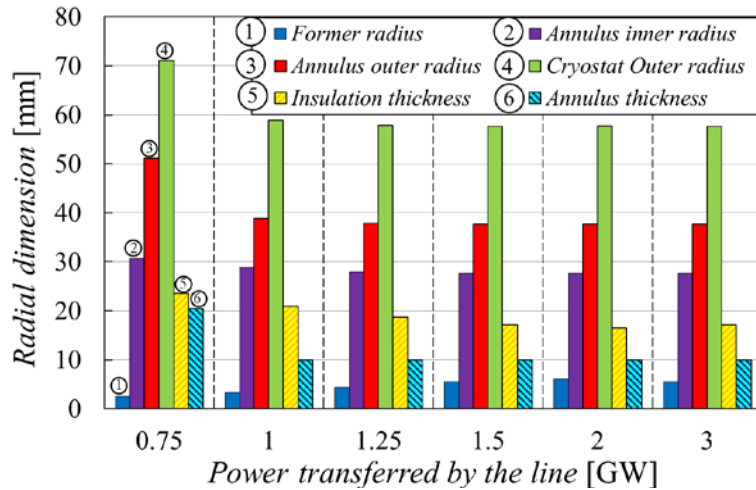

CASE STUDY : Line length = 10 km ; V_{rms} = 220 kV

Thank you for the attention!

Further questions:
andrea.musso@rse-web.it

References

[1]	G. Chen et al., «Polypropylene Laminated Paper (PPLP) Insulation for HVDC Power Cables,” 12th IEEE International Conference on the Properties and Applications of Dielectric Materials, 2018.
[2]	W. Kim et al., “Comparative Study of Cryogenic Dielectric and Mechanical Properties of Insulation Materials for Helium Gas Cooled HTS Power Devices”, IEEE Trans. On Appl. Supercond., vol. 17, no.4, p. 7700605, 2017.
[3]	N Hayakawa et al., 2014 J. Phys.: Conf. Ser.,507, 032021.
[4]	“Superconducting Cables”, Prof. Dr.-Ing. Mathias Noe, Karlsruhe Institute of Technology Institute for Technical Physics, EUCAS Short Course Power Applications, September 17th 2017, Geneva
[5]	W. T. B. de Sousa et al., “An open-source 2D finite difference based transient electro-thermal simulation model for three-phase concentric superconducting power cables,” Supercond. Sci. Technol, vol. 34, 2021.
[6]	D. Kottonau et al., “Design Comparisons of Concentric Three-Phase HTS Cables,” IEEE Trans. On Appl. Supercond., vol. 29, no. 6, Sept. 2019.
[7]	A. P. Malozemoff et al., “High-temperature superconducting (HTS) AC cables for power grid applications,” Superconductors in the Power Grid Materials and Applications, Woodhead Publishing Series in Energy, pp. 133-188, 2015.
[8]	D. Kottonau et al., “Evaluation of the Use of Superconducting 380 kV Cable,” KIT Scientific publishing, 2020.
[9]	J. Choi et al. “A Study on Insulation Characteristics of Laminated Poly-propylene Paper for an HTS Cable,” IEEE Trans. On Appl. Supercond., vol. 20, no. 3, 2010.
[10]	D. S. Kwag et al. “A Study on the Composite Dielectric Properties for an HTS Cable,” IEEE Trans. On Appl. Supercond., vol. 15, no. 2, 2005.
[11]	W. Pi et al., “Insulation Design and Simulation for Three-Phase Concentric High-Temperature Superconducting Cable Under 10-kV Power System”, IEEE Trans. On Appl. Supercond., vol. 29, 2019.
[12]	A. Morandi, “HTS dc transmission and distribution: concepts, applications and benefits,” Supercond. Sci. Technol., vol. 28, p. 123001, 2015.
[13]	N. Hayakawa, “Insulation technologies for HTS apparatus,” ESAS Summer School on HTS Technology for Sustainable Energy and Transport Systems, Bologna-Italy, Jun. 2016.
[14]	W. T. Norris, “Calculation of hysteresis losses in hard superconductors carrying AC isolated conductors and edges of thin sheets,” J. Phys. Appl. Phys., vol. 3, no. 4, pp. 489–507, Apr. 1970.
[15]	S. Wimbush and N. Strickland, “Critical current characterisation of SuNAM SAN04200 2G HTS superconducting wire,” Figshare Dataset, https://doi.org/10.6084/m9.figshare.5182354.v1 , 2017.
[16]	T. Takahashi et al., “Dielectric Properties of 500 m Long HTS Power Cable”, IEEE Trans. On Appl. Supercond., vol. 15, 2005.
[17]	H. Suzuki et al., “Electrical insulation characteristics of liquid nitrogen impregnated laminated paper insulated cable”, IEEE Transactions on Power Delivery, vol. 7, 1992.
[18]	G. Wypych, “HDPE high density polyethylene, Handbook of Polymers,” Elsevier, ISBN 9781895198478, pp. 150-156, 2012.
[19]	L. Trevisani, “Design and simulation of a large scale energy storage and power transmission system for remote renewable energy sources exploitation,” Ph.D. Dissertation, University of Bologna, Italy, 2006.
[20]	D. S. Kwag et al. “A Study on the Composite Dielectric Properties for an HTS Cable,” IEEE Trans. On Appl. Supercond., vol. 15, no. 2, 2005.
[21]	F. Herzog, “Cooling unit for the AmpaCity project – One year successful operation”, Cryogenics, vol. 80, 2016.
[22]	Roy Zuijderduin, “Integration of High-Tc Superconducting Cables in the Dutch Power Grid of the Future,” Ph.D. Thesis, Delft University of Technology, The Netherlands, 2016.