

# Laboratoire Commun ST-IEMN 20 ans

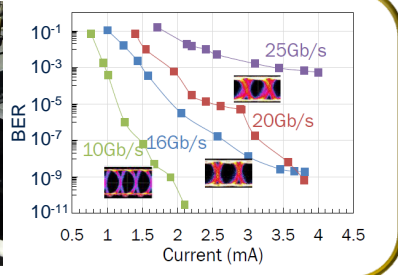

**Millimeter-wave datacoms and photonics**

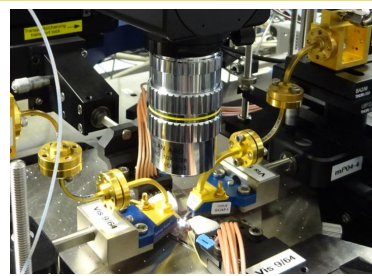

**Communication systems and AI hardware**

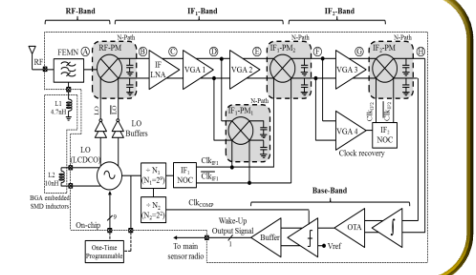
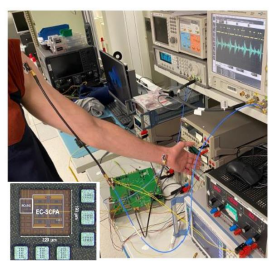

**Metrology using high frequency acoustics**

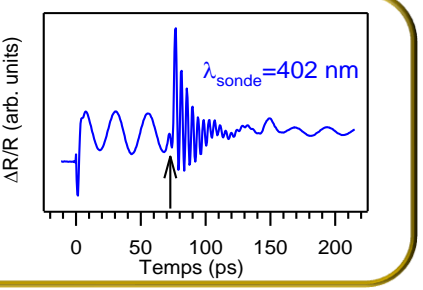
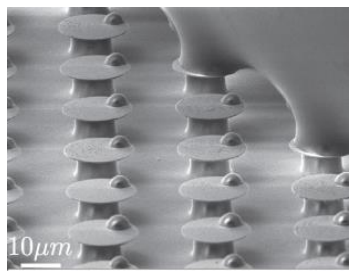

**Functional packaging and integrated thermics**

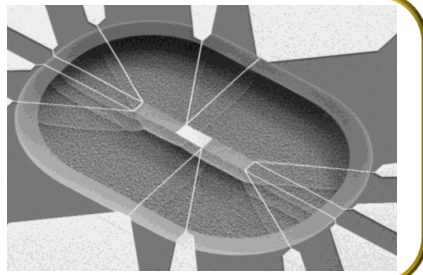
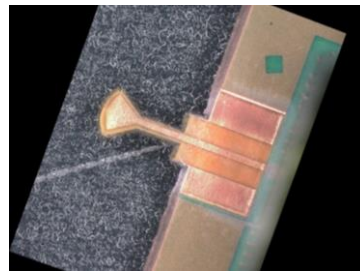



life.augmented

# Laboratoire Commun ST-IEMN 20 ans



- IEMN en bref
- Les 4 thèmes du LabCom (Réalisations, Visions)
  - T1: Millimeter-wave datacoms and photonics
  - T2: Communication systems and AI hardware
  - T3: Metrology using high frequency acoustics
  - T4: Functional packaging and integrated thermics
- L'écosystème du LabCom et son impact
  - Projets Collaboratifs
  - Production Scientifique et Brevets
  - Doctorants





# IEMN at a glance

Neuromorphic Technologies  
 Technologies for Health  
 Transportation  
 Telecom UHD  
 IoT Make Sense  
 Smart Energy

Materials  
 Micro & Nano Devices  
 Nano Characterization

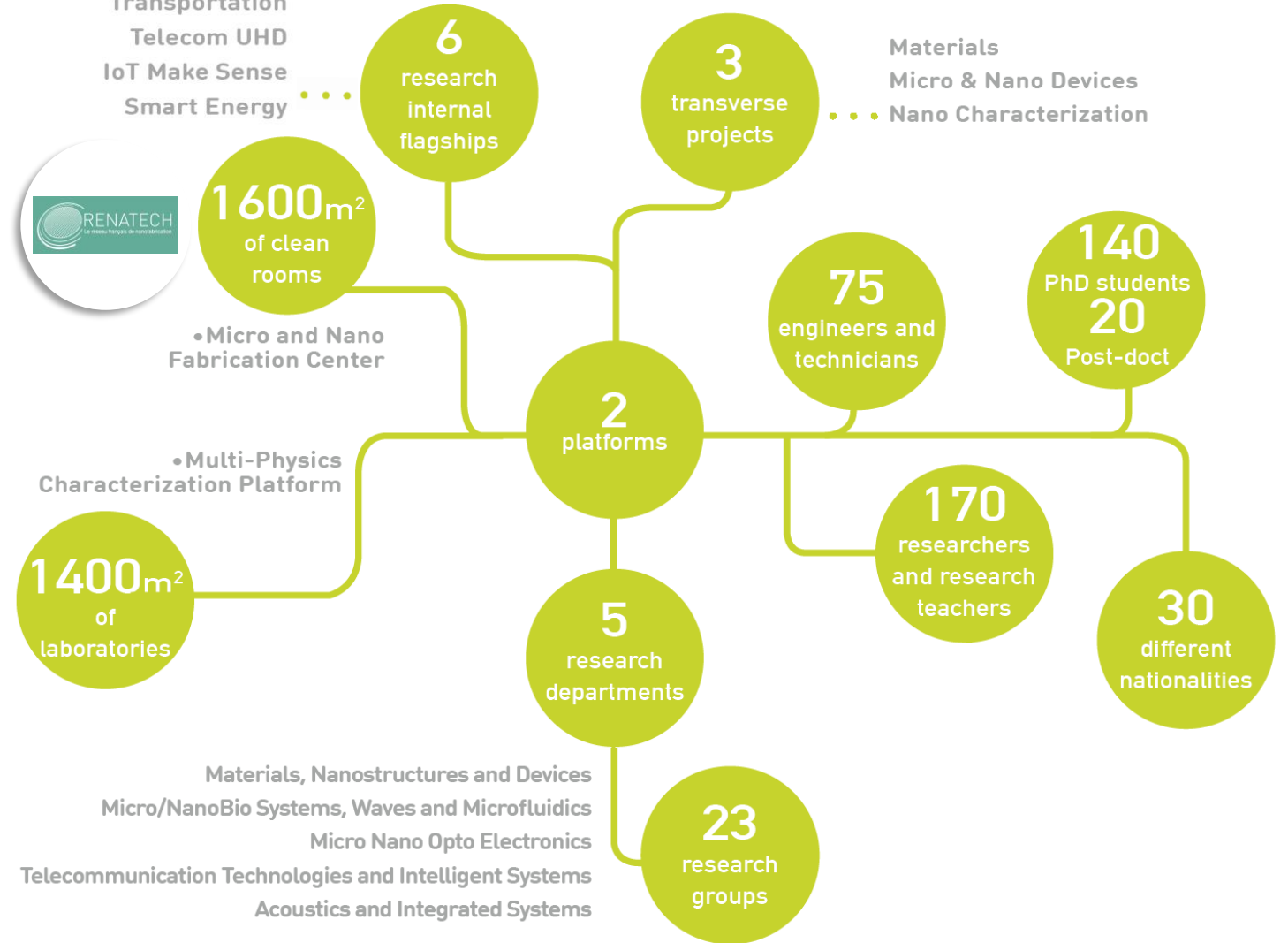



# Contrats Plan Etat Région 2021-2027



Ondes et  
Matières  
pour le  
Deep Tech

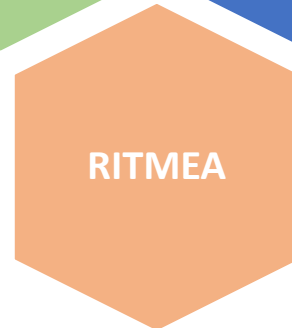
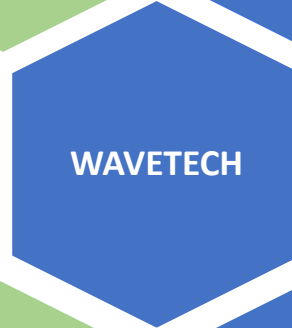
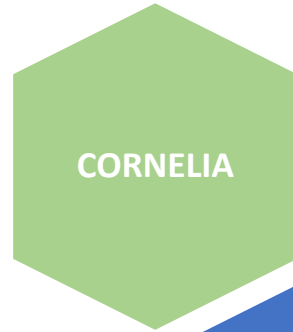

Transports et  
Mobilités Eco-  
Responsables  
et Autonomes

Micro-dispositifs à faible  
consommation d'énergie  
pour une société  
connectée et durable

Technologies  
pour la santé









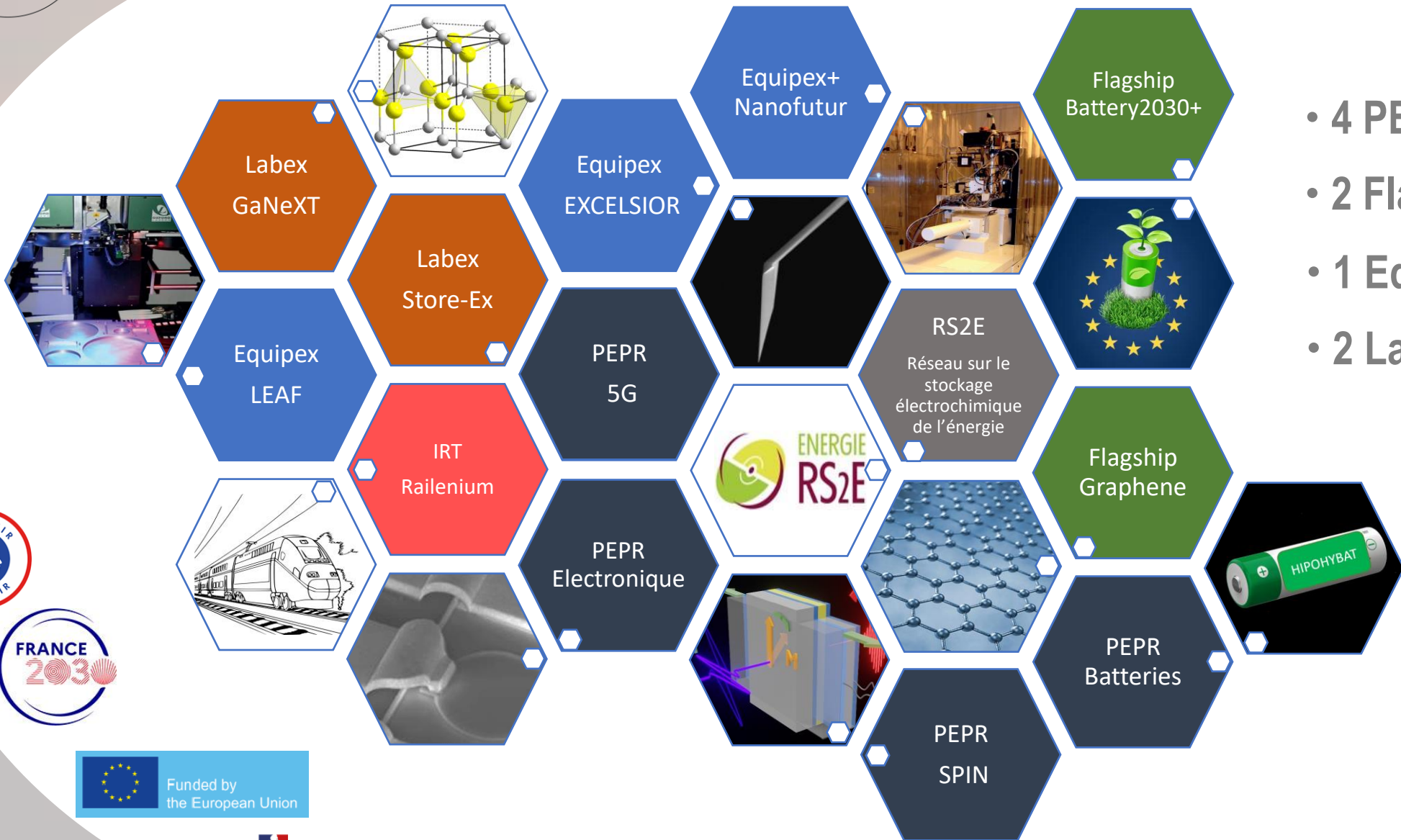

# Projets structurants nationaux & européens



- 4 PEPR
- 2 Flagships EU
- 1 Equipex+
- 2 Labex





- Laboratoire commun avec STMicroelectronics (2003)  life.augmented
- Chaire industrielle TERIL-WAVES avec MC2 Technologies 
- Laboratoires communs avec HCS Pharma  et HORIBA 
- Equipe Commune LEOST – IEMN 
- **Startups issues des activités de l'IEMN depuis 2015 :**

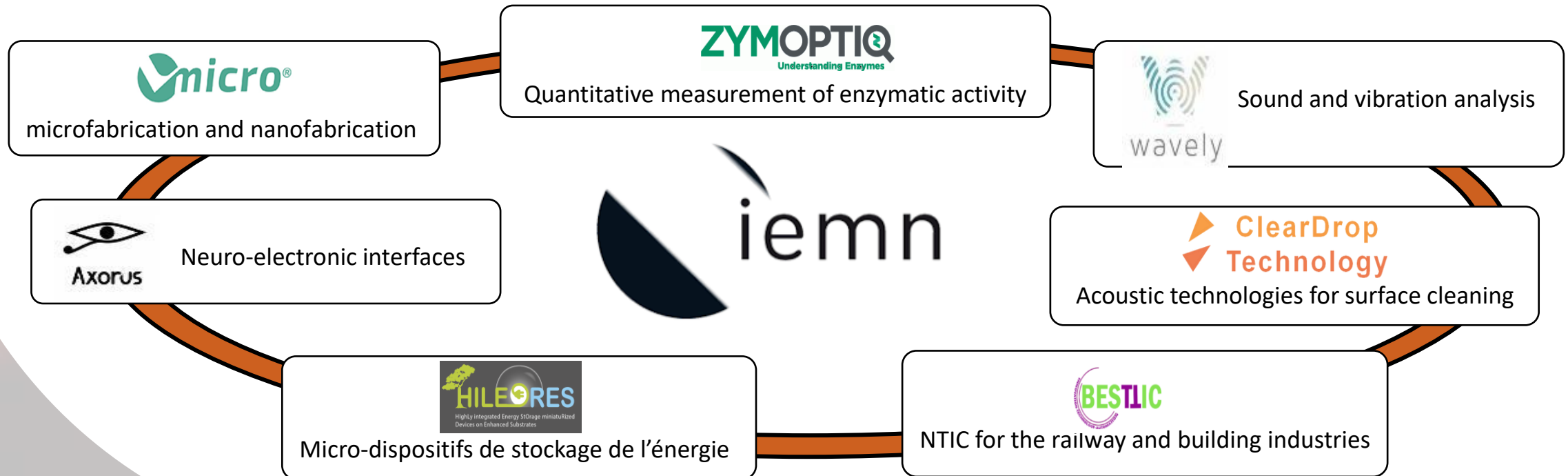



life.augmented

# Laboratoire Commun ST-IEMN 20 ans



- IEMN en bref
- Les 4 thèmes du LabCom (Réalisations, Visions)
  - T1: Millimeter-wave datacoms and photonics
  - T2: Communication systems and AI hardware
  - T3: Metrology using high frequency acoustics
  - T4: Functional packaging and integrated thermics
- Ecosystème du LabCom
  - Projets Collaboratifs
  - Production Scientifique et Brevets
  - Doctorants



# ST-IEMN Joint Laboratory



- 4 Topics
- Since 2003
- 936 Publication products
- 155 Journals
- 445 Conferences
- 49 Inv. Talks
- 65 patents+ 135 ext
- 91 PhD Thesis defended
- 25 PhD/Post-docs on-going
- 2 Start-up Menapic, MC2
- National Programs NANO 2008/2012/2017/2022
- IPCEI 2026
- 2 EQUIPEX (LEAF, EXCELSIOR)
- 30 Projects shared of which 20 European projects
- 59 Permanent research staff involved (23 IEMN, 36 ST)

T1

Millimeter-wave datacoms and photonics

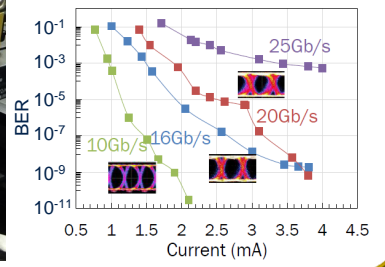
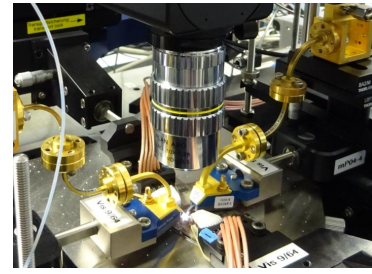

T2

Communication systems and AI hardware

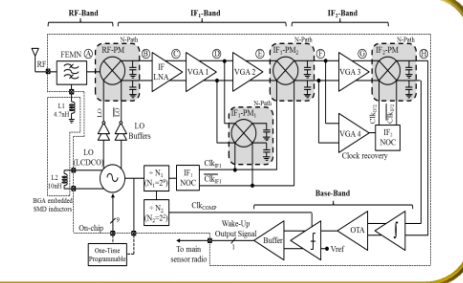
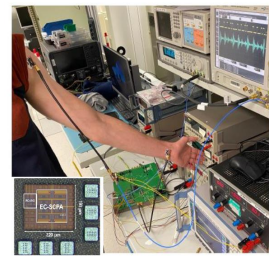

T3

Metrology using high frequency acoustics

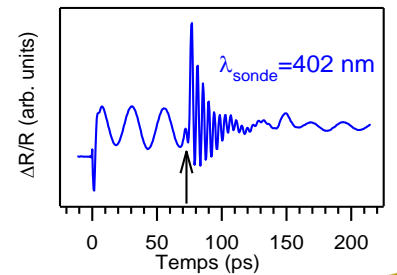
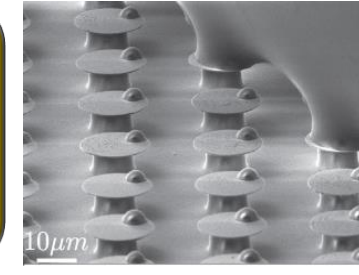

T4

Functional packaging and integrated thermics

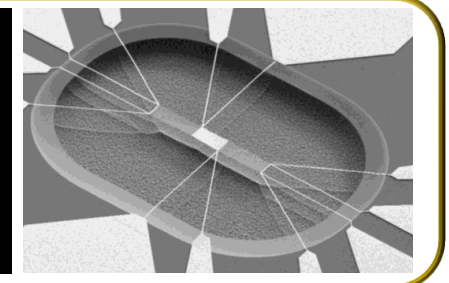
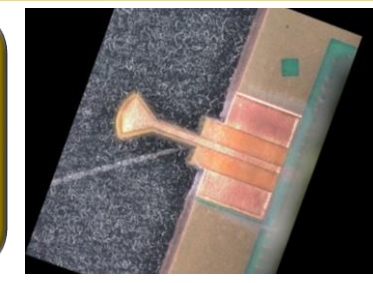



# ST-IEMN Joint Laboratory



## Gouvernance

Co-direction IEMN/ST  
E. Dubois/A. Cathelin

T1: G. Ducournau  
D. Gloria

T2: A. Frappé, A. Kaiser  
A. Cathelin

T3: A. Devos, J. Carlier  
D. Le Cunff, L. Broussous

T4: E. Dubois, J.F. Robillard  
S. Monfray, S. Jeannot, D. Gloria

### T1

Millimeter-wave datacoms and photonics

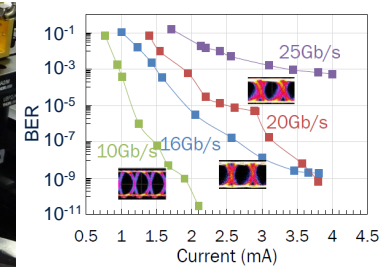
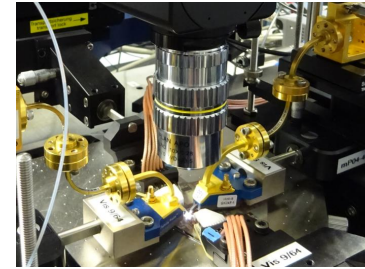

### T2

Communication systems and AI hardware

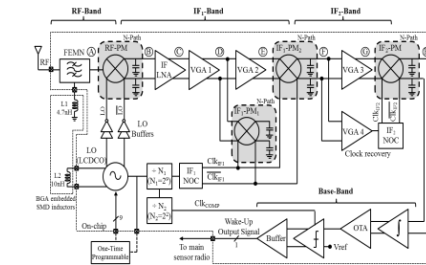
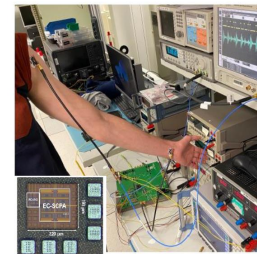

### T3

Metrology using high frequency acoustics

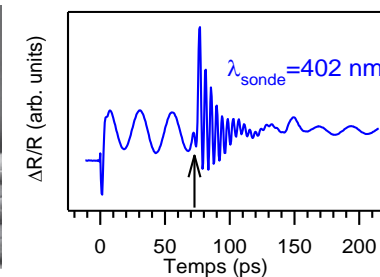
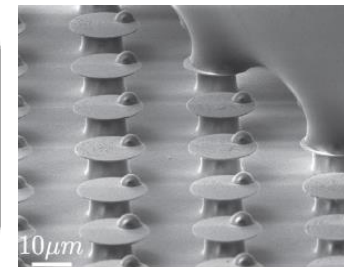

### T4

Functional packaging and integrated thermics

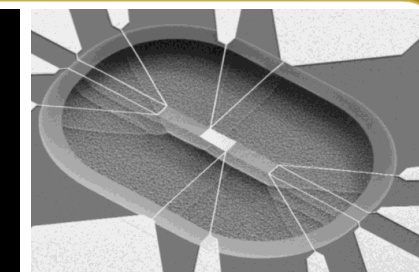
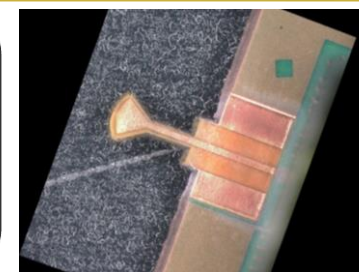

# 11

## Groups involved in the Joint Lab

- EPIPHY: EPItaxy and PHYSics of heterostructures
- NCM: Nanostructures, nanoComponents & Molecules
- PHYSICS: Nano materials physical properties
- SILPHYDE : PHYsical SIMuLation of Electronic and optoelectronic Devices
- SUBLAMBDA: Opto and Micro Electronic Devices
- THZ PHOTONICS
- PUISSANCE: Microwave Power Devices
- ANODE: Advanced NanOmeter Devices
- CARBON: Graphene based devices
- OPTO: Optoelectronics
- MITEC: Microtechnology and Instrumentation for Thermal and Electromagnetic Characterization
- ACOUSTICS

- TPIA: Transduction, Propagation and Acoustic Imaging
- MAMINA: Materials and Acoustics for Micro and NANO integrated systems
- BIOMEMS
- AIMAN-FILMS: Magneto-Nano-Electronics - Active structures, MEMS and flexible structures Ultrasonic thermography - Micro-Fluidics
- NANOBIOINTERFACES
- NAM6: The Micro and Nano Systems
- COMNUM: Digital Communications
- CSAM: Circuits systems and Application of Microwaves
- TELICE: Telecommunication, Interference and Electromagnetic Compatibility
- MICROELEC SI
- WIND group: Wide Bandgap Semiconductor devices

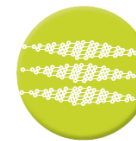

# Topic 1

## Millimeter-wave datacoms and photonics

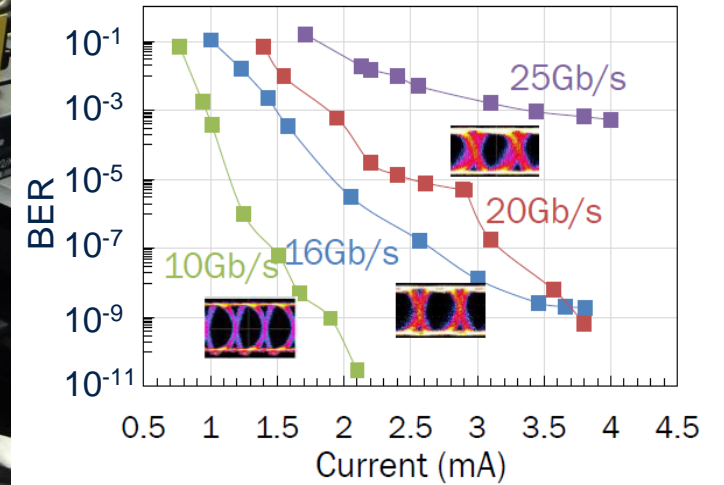
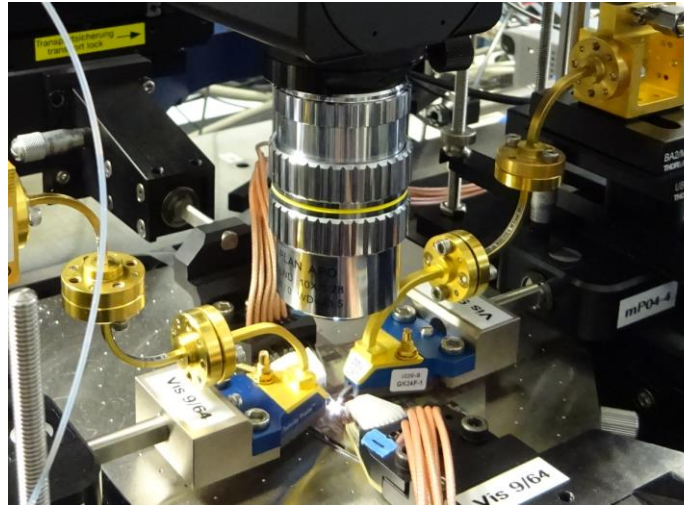

### IEMN

G. Ducournau  
N. Defrance  
J.C. Dejaeger  
K. Haddadi  
F. Danneville

Y. Roelens  
M. Zaknourne  
E. Okada  
S. Lépilliet

### ST

D. Gloria  
C. Belem  
S. Bouvot  
R. Debroucke  
P. Chevalier  
C. Durand  
A. Yvon

F. Giancesello  
O. Foissey  
S. Jan  
S. Cremer  
J. Azevedo  
E. Bouyssou

### PhD/PDoc

D. Ovalle-Taylor  
C. Mokhtari  
M. Doublet  
T. Bordignon  
B. Badin  
E. Brezza

# Technology capability evaluation for RF&mmW: WHY?

- ST technologies targetable applications in the field of RF&mmW

## Connectivity, 5G&6G Wireless Communications

- 5G Backhauling in D band
- 5G mmW modular Phase Array transceivers
- 6G transceivers systems D-J bands&bey. 100Gb/s
- IoT, ....

~GHZ-300GHz



## Radar Sensing

- Broadband radar sensor
- THz imaging
- Medical
- Security
- ...

60 to 600GHz



## Satellite Communications

- LEO apps
- In flight to Satellite
- Data center to Satellite
- SATCom
- ...

10 to 30GHz



➔ Need to develop, optimize and model technologies including packaging in

Small Signal  
Noise  
Power  
Pattern Rad. up to THz

➔ Evaluate devices FOM and demonstrate their capabilities through elementary demonstrators included in system test platform with functionalized package



# WHY and HOW in ST-IEMN Common Lab?

- Commercial characterization tools & methodologies limited to 110GHz

- Need to develop IN (BIST) and OFF Situ up to 1THz:

Noise Sources

RF sources

Tuners

Noise Receivers

Power Detectors

Smart MicroProbes

- Synergy between 2 IEMN competence centers: RF Lab & Technology: T1&T4

- **Characterization Bench Development up to THz IN /OFF situ**
  - S
  - Noise
  - Power
  - 3D radiation pattern
- **Smart THz MicroProbing**

- **Technology device evaluation to enable perf. Improvement**
  - Si Transistors
  - Wide Gap devices
  - Passives
- **Microstructuration enabling perf. detractor understanding and optimization**

- **Technology capability demonstration through elementary blocs in system test platform**
- **Integration with functionalized package**

# Our Vision: All in situ first and in Micro Probe later up to THz

**Smart Test in MicroProbe**

*All in probe*



**Noise source**

- 7 mA
- 6 mA
- 5 mA
- 4 mA
- 3 mA
- 2 mA
- 1 mA
- 0.5 mA
- 0.25 mA



**PNA**



**Impedance Synthesizer**



**Power measurement**

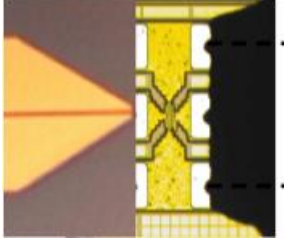

200µm

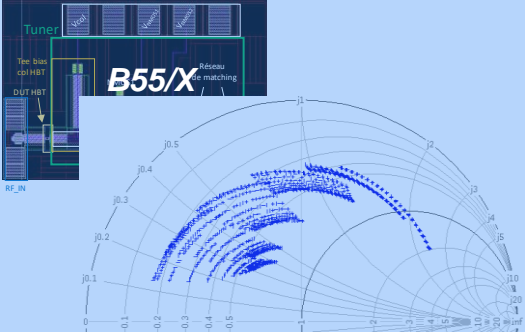

Simulation of S11\_tuner1

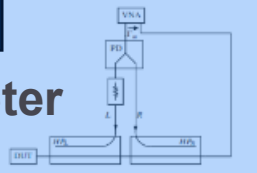

**Interferometer For HZ**

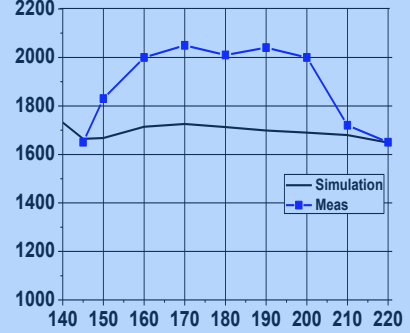

Sensitivity (V/VW) vs Frequency (GHz)

Frequency (GHz)	Simulation (V/VW)	Meas (V/VW)
145	170	165
155	175	180
165	175	200
175	175	205
185	175	200
195	175	205
205	175	200
215	175	170
220	175	165

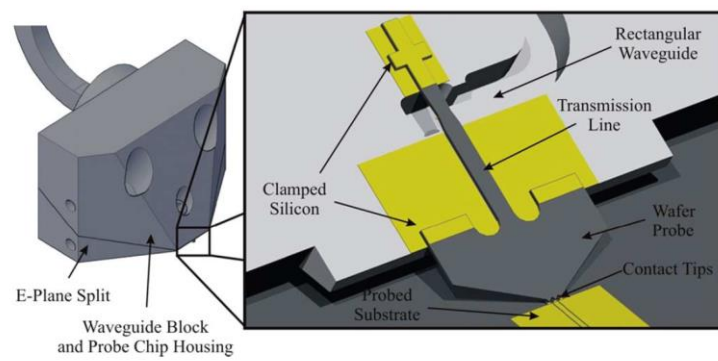
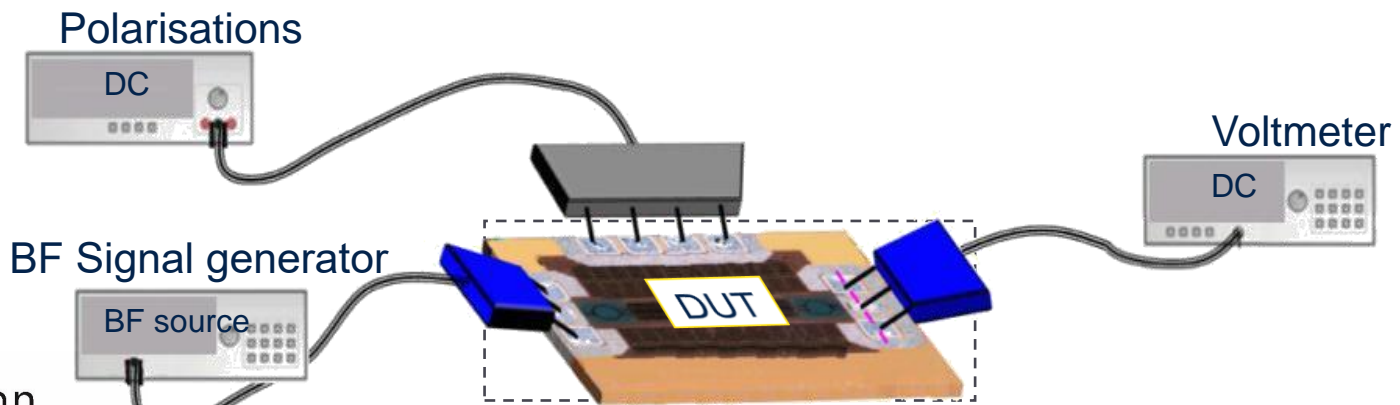
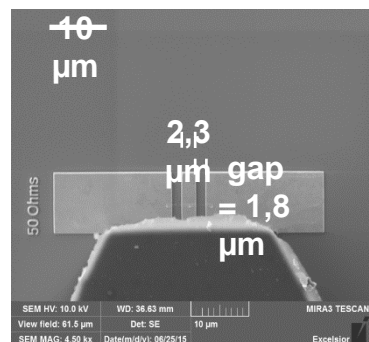

# Our Vision: Building blocks validation at system-level

Enabling Beyond 5G/6G wireless core networks evolution:  
We are going towards THz between antennas...

Frequencies > 250 GHz expected at horizon 2030

**Key dates:** 2017: new standard IEEE 802.15.3d (100 Gbit/s)  
2019: discussions @ WRC 2019: frequencies 'allocated'

➔ 252-296 GHz / 318-356 GHz

=> Future markets: silicon-based technologies will enable mass developments

➔ Enabling technologies/chipsets towards 2025-2030 markets

## Recent steps towards objectives

**2020:**  
210 GHz LNA stage – 6 dB  
qualified in 5 Gbps system

BiCMOS 55nm

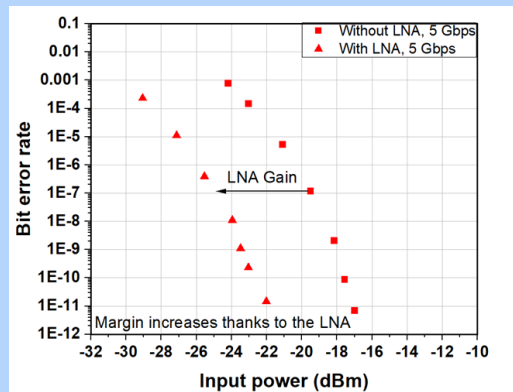
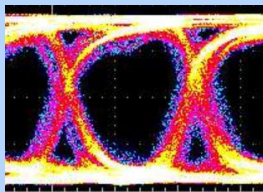

**2020:**  
106 GHz Sub-Harmonic  
Mixer 20 dB Conv losses

Up 40 Gbit/s qualified

BiCMOS 55nm /  
Schottky diode based

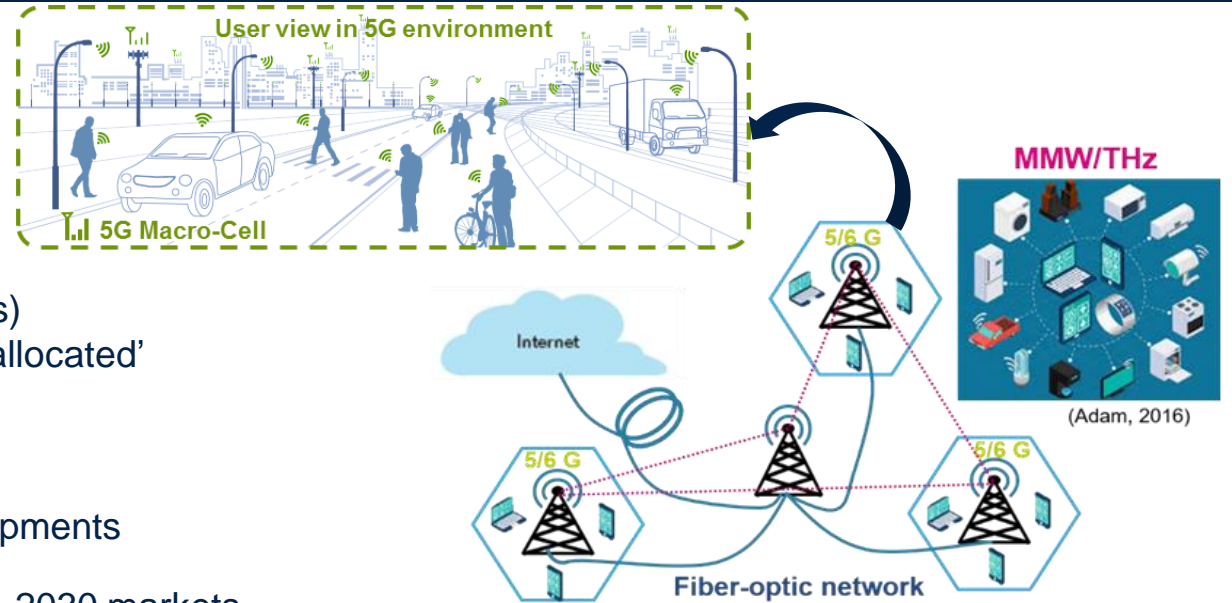
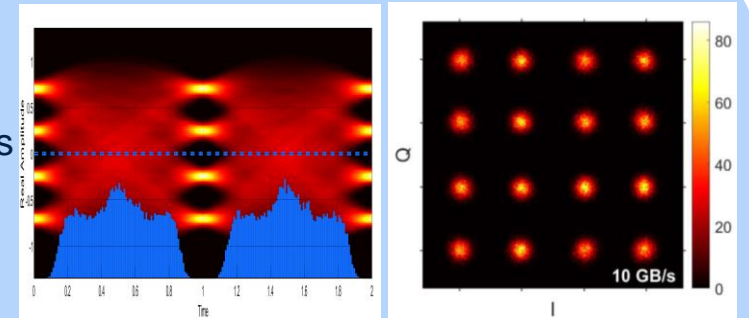

# Where we are & Where we go

57 publications, 168 international communications, 18 conferences invitees, 14 priority patents, 32 PhD

➤ Leveraging on several recent key developments (2018-2022) + timeline for next 4-5 years

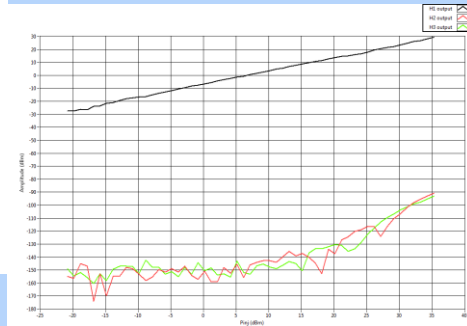
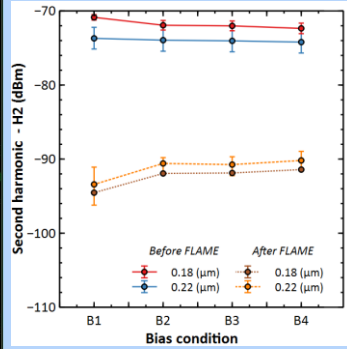
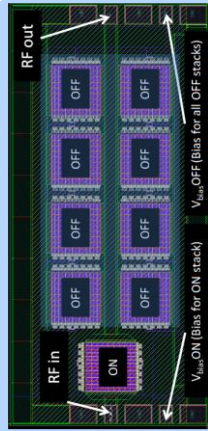

H9SOI SP9T fs laser milling and linearity characterization

- HR substrate
- H2 reduces by 22.7 dB
- H3 reduces by 5.6 dB

Ron/Coff, Hx Factor quality improvement

Microwave nanoprobe development for nano devices characterization

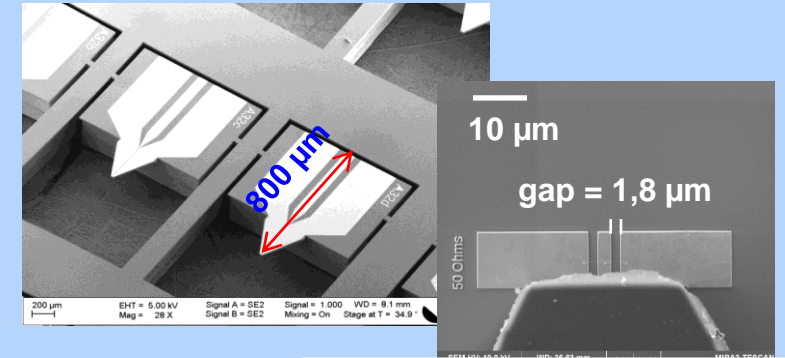

Large signal characterization

HBT device	$G_p$ max. (dB)	PAE max. (%)	$P_{OUT}$ @ 1 dB (dBm)	Power density (mW / $\mu m^2$ )
BiCMOS055	5,10	22,2	8,2	16,1
IC standard	4,25	16,3	11,0	30,1
IC 5 crenels	4,80	22,2	11,0	30,1

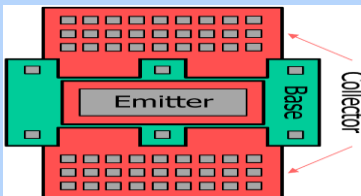

State-of-the-art power density HBT @ 94 GHz (BiCMOS 55 nm)

Up to 180 GHz silicon-based power characterization

Process evaluation

Increase  $F_t$  and  $F_{max}$  NPN B55X 9ML.

Complementary PNP development

Characterization of MOS/Diode & aF varactor (AdvCMOS/ BiCMOS)

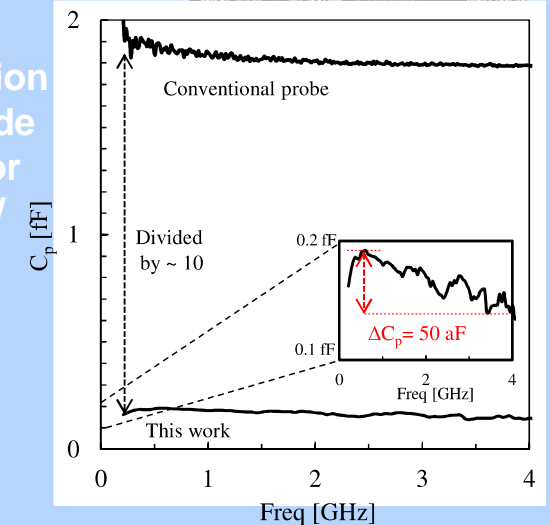

Up to THz range and circuits integration micro functionalized probes



# Where we are & Where we go

➤ Leveraging on several recent key developments (2018-2022) + timeline for next 4-5 years

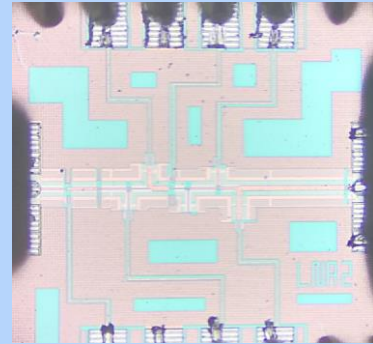
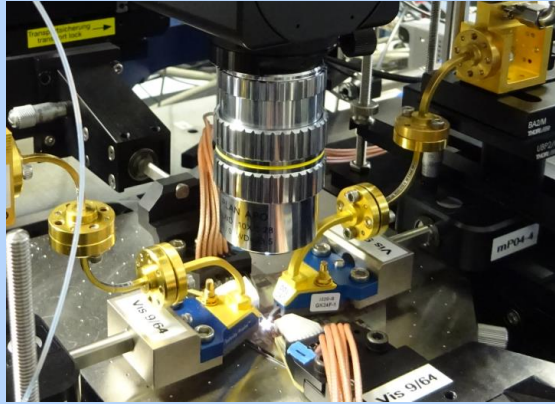

Integration of LNAs in 210 GHz communication 5 Gbps testbed

BiCMOS 55nm

Increase bandwidth/carrier frequency (IPCEI)

Antenna measurement testbed up to 330 GHz

2020:

650 GHz development

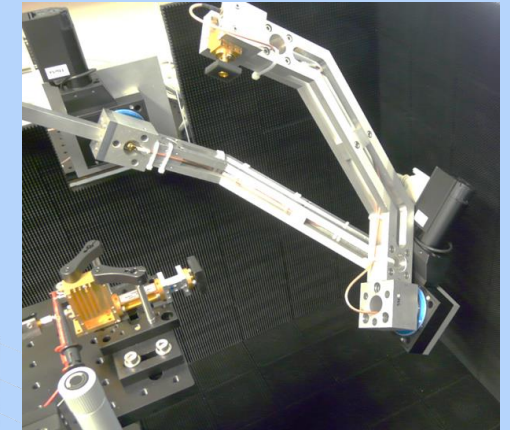

State-of-the-art Noise/IP3 measurements in the 300 GHz bands

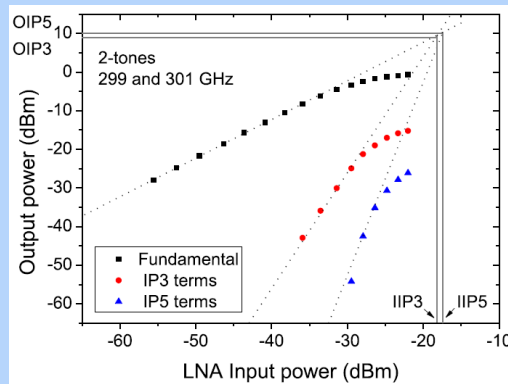
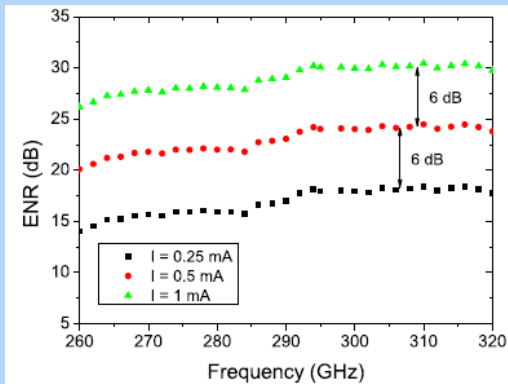

Up to 300 GHz silicon-based noise sources (BiCMOS 55 nm)

300 GHz band noise/power benches

Sustain and Increase > 350 GHz / Power/Noise benches

300 GHz measurement

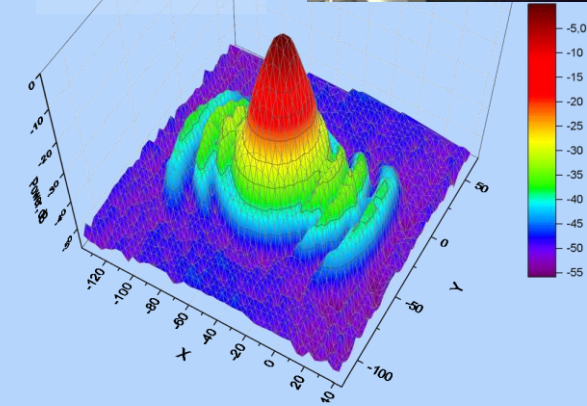

Up to THz range (Silicium based THz rectennas qualification)

# T1-Scientific ecosystem

National level: PIAs

## Equipex LEAF infrastructure



Laser procEssing pLATFORM  
for multiFunctional  
packaging

Micro-nano  
structuration

Functional packaging for  
high-frequency & THz

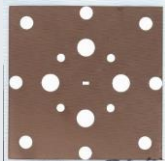

## Equipex Excelsior infrastructure



Nanoprobing / high Z

Very small size  
measurement

THz characterization

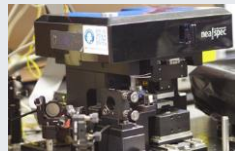
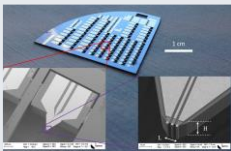

E.U. funded projects  
**(finished)**

## ECSEL TARANTO 2017 2021

TowARds Advanced bicomos  
NanoTechnology platforms for  
rf and thz applicatiOns

Follow-up: KDT 'SHIFT'

## KDT-JU SHIFT 2023-2025



Sustainable technologies  
enabling Future Telecom  
applications



ST-IEMN  
Common Lab



## IPCEI-ME-CT 'Nano 2026'

- SP03: Development of charac bench for IR sensors
- SP04: Heterogeneous integration InP/Si
- SP05: Linear, NL charac and enabling functions using mm-wave technologies
- SP10: Methods for the characterization of ST's GaN devices

## PEPR 5G & Electronics

### PEPR 5G

Methods & characterizations for telecom-oriented beyond 5G / Atmospheric studies (propagation)

### PEPR Electronics

- THz converters
- THz HBT (III-V, InPoSi)
- THz imaging

## H2020 ICT THOR 2018-2022

System-level characterization @ THz

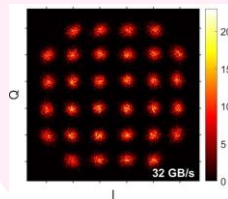

Outdoor demo:  
300 GHz  
645 m (July 22)

## Euramet TEMMT 2019 2021

Metrology for high frequency S-parameters (up to 750 GHz), 1.1 THz (2021)

## TERAOPTICS ITN Marie-Curie on THz science & technology

THz sensors measurements, metrology

New for 2023: PEPR (PIA4) / IPCEI-ME-CT/ KDT SHIFT



# Topic 2

## Communication systems and AI hardware

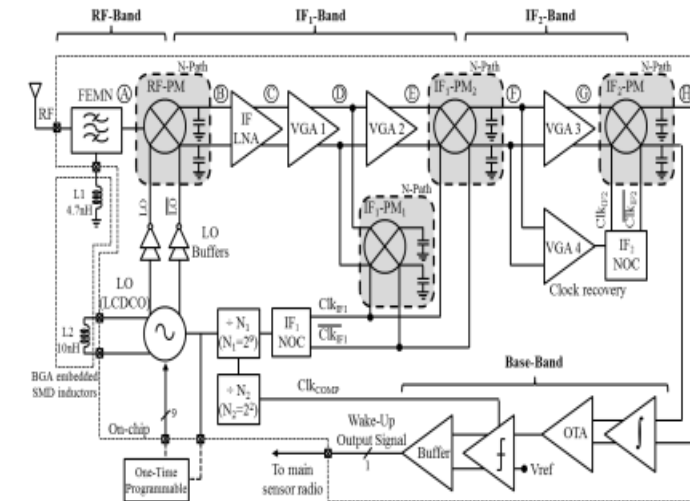
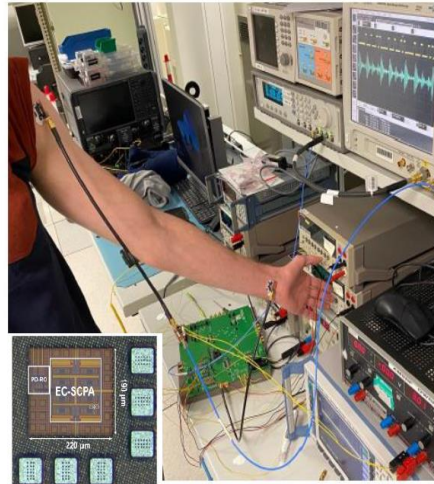

### IEMN

A. Frappé  
B. Larras  
A. Kaiser  
B. Stefanelli  
L. Clavier

### ST

A. Cathelin  
D. Duperray  
P. Cathelin  
S. Nicolas  
D. Perrin  
F. Paillardet  
S. Clerc

### PhD/PDoc

J.B. Casanova  
C. Beauquier  
S. Richardson  
S. Mourrane  
J. Cornejo  
K. Hérissé  
J. Duforest  
M. Chene  
A. Gautier



# Context and global objectives: WHY?

## Integrated Communication Systems

- ULP TX/RX for On-Body Communications Chips
- High-speed TX for SatCom chip
- Ultra-low power ADC for STM32 Connectivity

## Near-sensor computing / AI



Demonstrate FDSOI technology opportunities for real-life ultra-low power AIoT chips and systems

## Real-life IoT demonstration platform

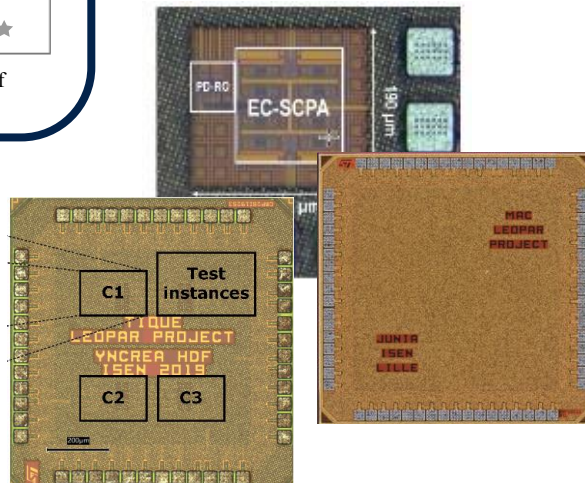
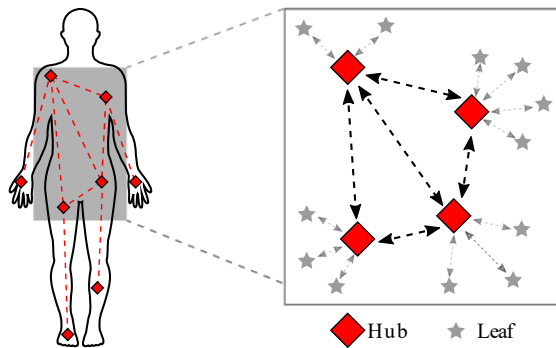



# Communication systems and AI Hardware HOW?

## Ultra-low power AIoT devices and systems and demonstration in 28nm and 18nm FDSOI

- Bringing system-level and circuit-level **unconventional design techniques** (examples: event-driven processing, mixed-signal processing, fully-digital RF architectures...)
- Leveraging **FDSOI technologies** through circuit design innovations
- From the concept to IC prototyping and demonstration

### Illustration for On-Body Communications project

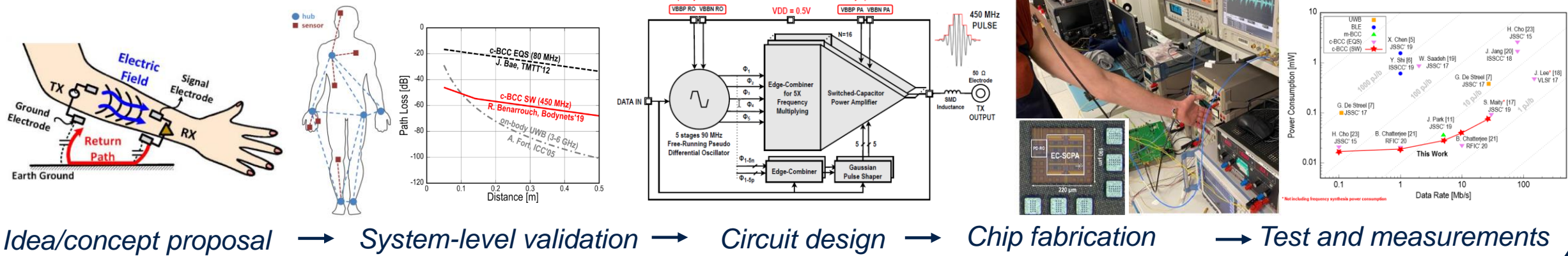

# Communication systems and AI Hardware - WHAT?

## Integrated Communication Systems

### On-Body ULP Communications

- Channel characterization for Capacitive Body Coupled Communications (IEEE std)

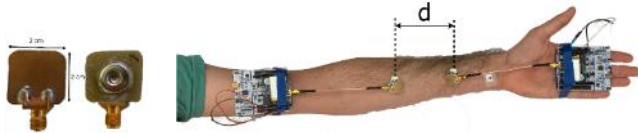

- Network MAC protocols based on heartbeat synchronization

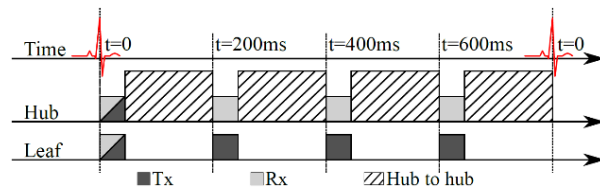

- Design of energy-efficient TX/RX for C-BCC in 28nm FDSOI

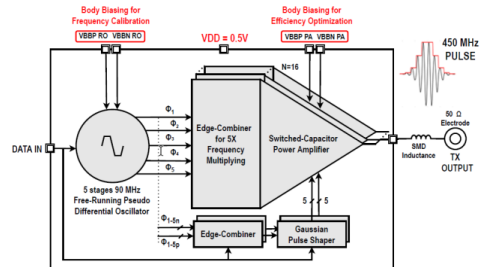
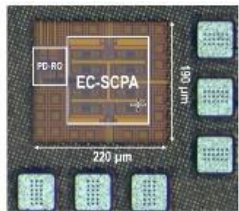

### High-speed Digital TX

- Digital-RF 5G TX in 28nm FDSOI, MDG/RFC specs
- High-speed RF DACs / Switched-Capacitor PA / Digital delta-sigma modulation

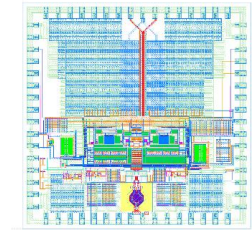

### Low-power ADC

- Hybrid ADC architectures for ultra-low power receivers
- MCD/GPM/WBL specs

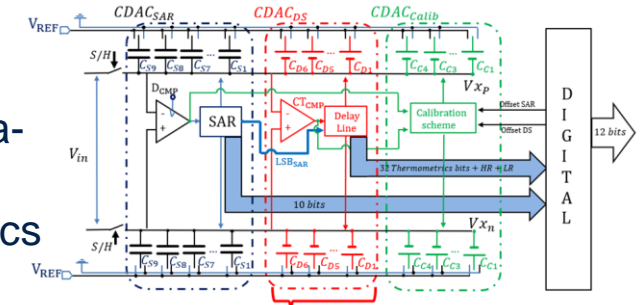

- Bidirectional Digital slope stage
- Conversion time and power consumption divided by 2

# Communication systems and AI Hardware - WHAT?

## Near-Sensor Computing / AI

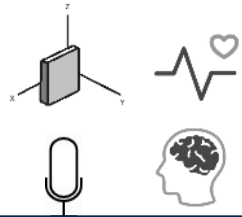

Event-driven  
feature extraction

Mixed-signal  
classification

Wake-up  
signal



- Level-crossing ADCs
- Event-driven signal processing
  - CT FIR filters
  - CT delay elements
  - Energy extraction (audio spectrogram)
  - Slope extraction for ECG signals

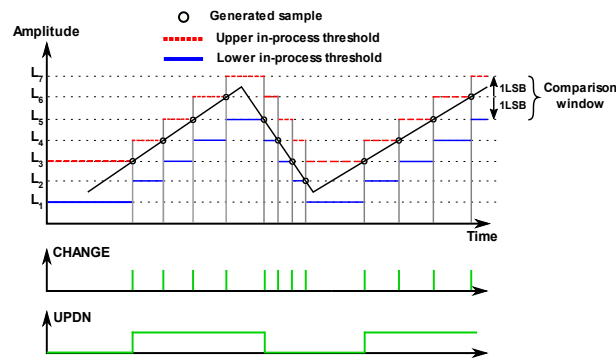

- Antidictionary-based classification
- ULP Compute-in-Memory
  - Mixed-signal current-based MVM
  - Log-quantized Digital CIM
  - In-memory learning
- Clique-based Neural Networks

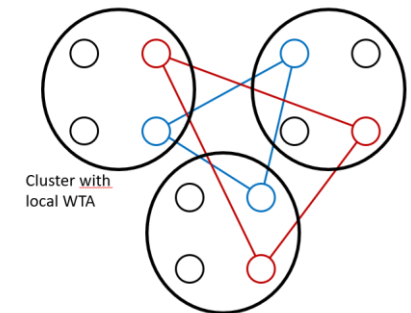
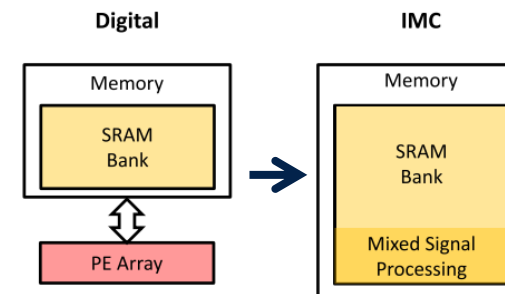

Applications: Keyword spotting, Arrhythmia classification, Sleep apnea detection, Movement detection

# Integrated Communication Systems – Recent Achievements

## Digital RF Transmitters

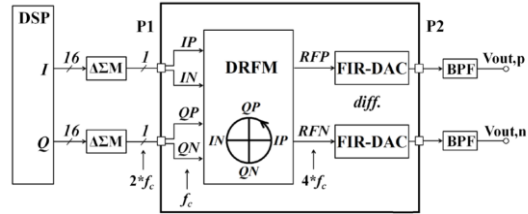

Digital RF Transmitter with switched-cap RF DAC and embedded Band Filter in 28nm FDSOI

- Lowest reported active area (circuit under pad integration)
- <10 mW front-end consumption (0dBm output power)
- Tunable for carrier freq <1GHz (ex: 900MHz LTE20)
- Best-in-class image rejection and LO feedthrough reduction via body-bias tuning

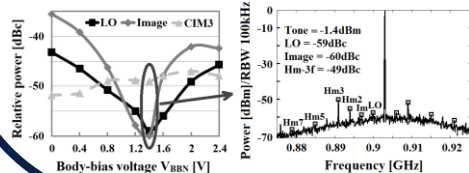
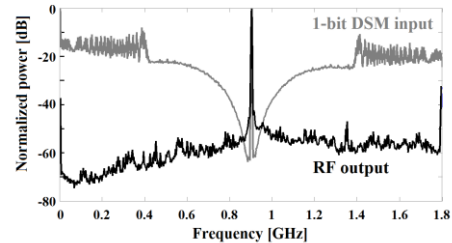
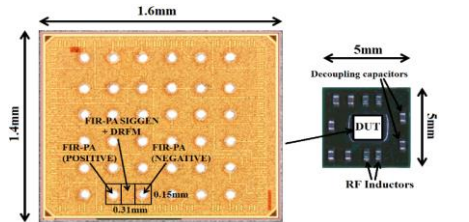

R.C. Marin (PhD ST - Région HDF)  
TCAS-I 18 + T-MTT 19

## On-Body ULP Communications

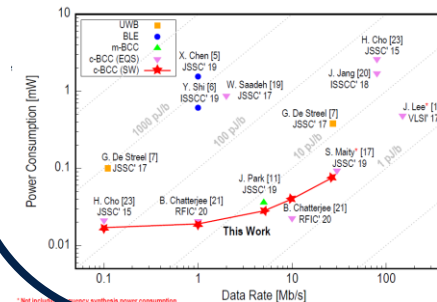
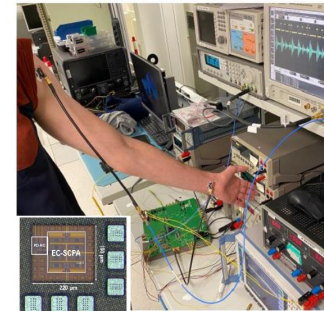
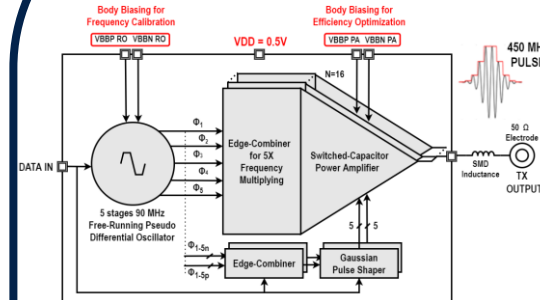

28nm FDSOI Ultra-Low Power Transmitter for HBI Nodes

- Highly Duty-cycled transmitter with pulse-based communication
- Ultra-Low Voltage (0.5V) operation
- Flexible data rate (100kb/s to 27 Mb/s) with 17 to 80  $\mu$ W power consumption
- Body biasing for RO tuning and SCPA efficiency optimization

PhD G. Tochou (CIFRE ST)  
RFIC 2021 Best Industrial Paper Award  
T-CAS-I 2021 + JSSC 2022

## Theme 2 Scientific Production

24 Journals  
112 Conferences

11 Invited  
6 Book chapters

25 patents & 19 ext.  
26 PhD defended



# Near-sensor Computing / AI – Recent Achievements

## Clique-based Networks

Clique-based Associative Memory in 28nm FDSOI

- 43pJ per inference (x6.5 improvement over SoA)
- Best memory density for associative memories (16kb memory within 27,600 $\mu\text{m}^2$ )

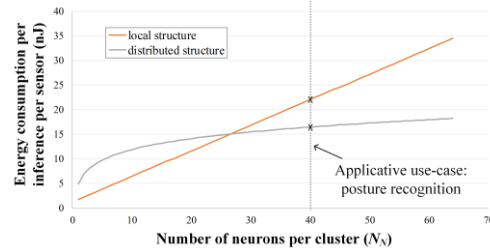
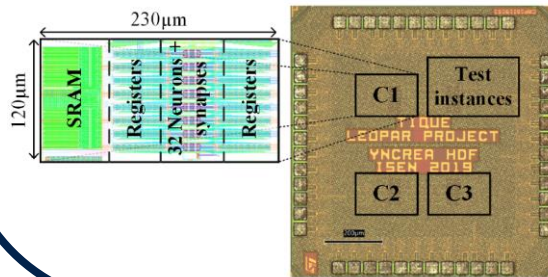
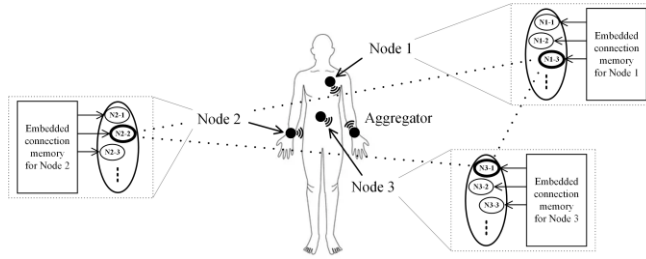
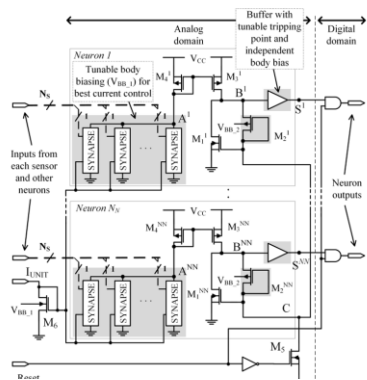

AICAS 2020 Best paper award  
JETCAS 2020  
ESSCIRC 2021

## Event-driven feature extraction for audio applications

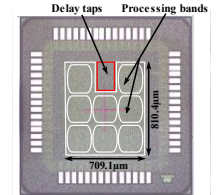
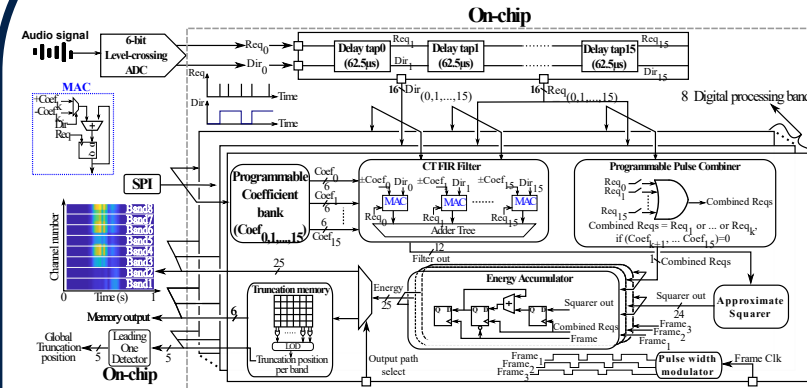

Mixed-signal 28nm FDSOI  
Full custom analog delay taps  
Semi-custom P&R flow for processing bands  
400k logic gates (>6MTors)

Ultra-low power event-driven spectrogram extractor for keyword spotting:

- 291nW activity dependent power consumption.
- >90% recognition accuracy for 10keywords.
- Programmable device for different applications

AICAS 2021  
NEWCAS 2023  
Patent  
ESSCIRC 2023  
(Nominated for best paper award)

Feature	This work	JSSC'23 [2]	ISSCC'22 [3]	TCAS'21 [4]
Extractor type	Time-based CT FIR filters	Analog Filters	Ring-Oscillator based BPF	Switched-Capacitor filters
Technology	28nm FD-SOI	65nm	65nm	130nm
Supply voltage (V)	0.7 for Delays 0.61 for Digital	0.4	0.5 for Analog 0.75 for Digital	1.2
Area (mm <sup>2</sup> )	0.151 w/o Mem 0.57 w/ Mem	0.53	1.6	0.79
Scalability <sup>a</sup> /Programmability	Yes/Yes	No/No	Yes/No	No/No
Event-Driven	Yes	No	No	No
Idle Power (nW)	270.7	—	—	—
Energy/keyword (nJ)	1.74	—	—	—
Total Power <sup>b</sup> (nW)	291.6 <sup>c</sup>	80	9300	800
Frequency range (Hz)	840-6.25k	100-4k	111-10.4k	30-8k
Nb of channels	8	31	16	32
Feature rate (Hz)	100	100	62.5	100
#Classes(keywords)	11(10)	11(10)	12(10)	12(10)
Accuracy (%)	90.08	91.5	86.03	82.4-87.4 <sup>d</sup>
Classifier	Off-chip software CNN	Off-chip software CNN	On-chip RNN	Off-chip software RNN

<sup>a</sup>Scalability : Technology nodes scalable <sup>b</sup>Total Power = Idle power + Speech rate x Energy/keyword  
<sup>c</sup>Power calculated for a speech rate of 12 keywords/minute, without including the truncation memory  
<sup>d</sup>Considering 5-10% degradation from excluding the off-chip logarithm [3]

## Theme 2 Scientific Production

24 Journals  
112 Conferences

11 Invited  
6 Book chapters

25 patents & 19 ext.  
26 PhD defended

# Ecosystem

On-Body ULP Comms Project  
Collaboration with 



ST-IEMN  
Pascal Ancey  
Common Lab



ULP In-Memory Computing  
Collaboration with 

High speed TX for SatCom  
Collaboration with 

## European Projects

## National support

IPCEI-NANO2022 SP02  
Event-driven neuro-inspired circuits



IPCEI-NANO2022 SP03  
Large-scale IoT experimentation

IPCEI ME-CT 2026  
Ultra-low-power distributed artificial intelligence  
circuits for autonomous sensors

## National projects



Low-Energy On-chip  
Pre-processing for Activity  
Recognition

## Audio domain



JEDAI



Event Driven Artificial Intelligence  
Hardware for Biomedical Sensors

## Biomedical domain

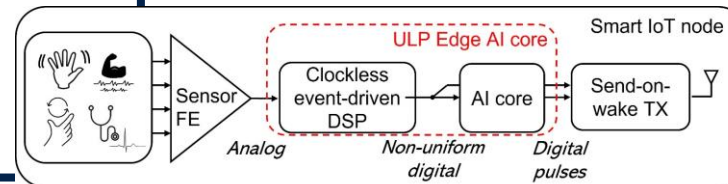

FE = front-end  
DSP = Digital Signal Processing  
AI = Artificial Intelligence  
TX = Transmitter  
ULP = Ultra-low power  
IoT = Internet of Things

# Perspectives

## Integrated communication systems

- ➔ ultra-low-power Rx design for enabling the On-Body ULP Comms, collab with SRA
- ➔ Future digital 5G TX architectures (mMIMO, dMIMO)

COMMUNICATE

THINK

## Near-sensor computing / AI

- ➔ Demonstration of event-driven concepts for audio, ECG and bioZ feature extraction
- ➔ Efficient on-chip mixed-signal AI engine (IMC, antidictionary, distributed NN)
- ➔ Complete integration of an edge-AI pre-processor

- ➔ Deployment of smart IoT nodes in the learning center
- ➔ Demonstration of intelligent wake-up (sensor and radio-based)

Real-life demonstration platform

# Topic 3

## Metrology using high frequency acoustics

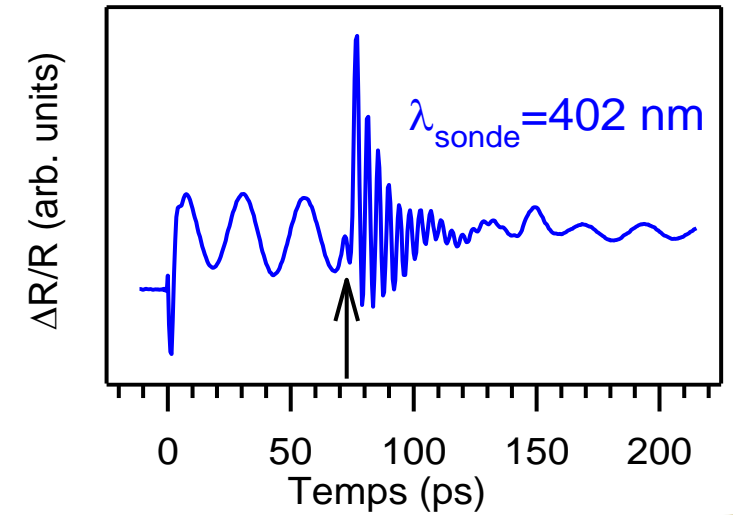
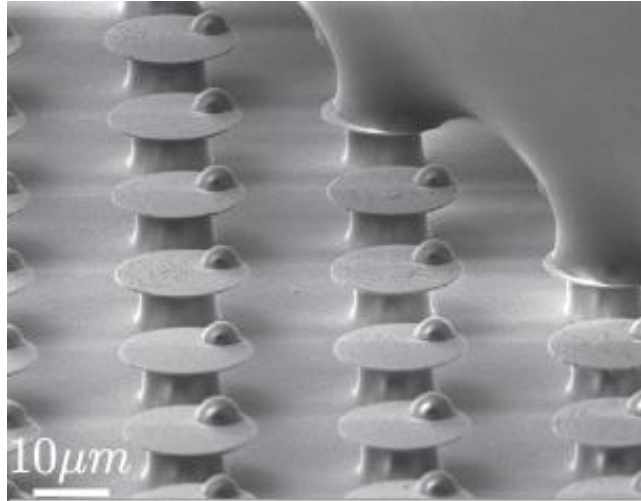

### IEMN

A. Devos  
J. Carlier  
V. Thomy

### ST

L. Broussous  
D. Le Cunff  
P. Garnier

### PhD/PDdoc

F. Chevreux  
A. Chargui  
A. Salhab



# Context and global objectives: WHY

## Thin Film Characterization

- Elastic properties more and more important
- New soft materials
- New applications with known materials

## Interfaces / Defects

- Interfaces : Bonding / Adhesion / Delaminations
- Voids detection at  $t_0$  or after thermal stress / humidity
- High Aspect ratio structures : wetting / filling / voids

New characterization techniques are needed

### 3D integration Wafer to wafer bonding

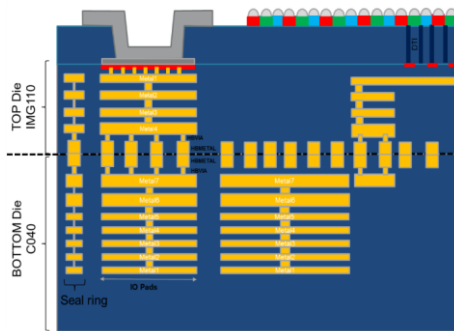

### Deep Trench Isolation Wetting & drying

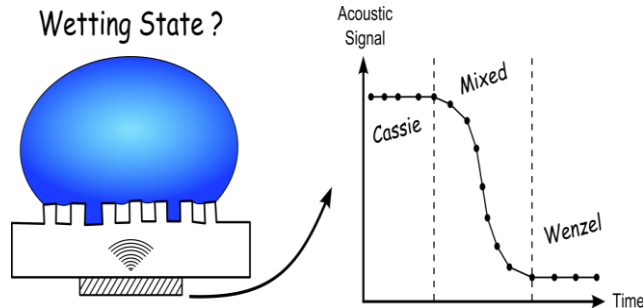

### Imagers Micro-lenses covered by dielectrics

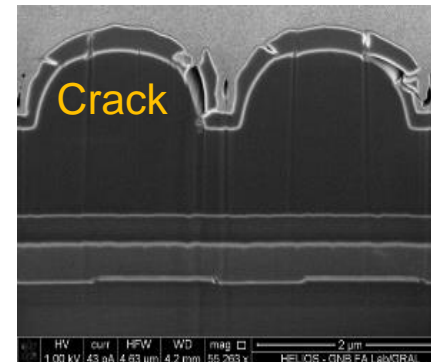

# HOW ? Using high-frequency acoustic waves

High Frequency Acoustic waves provides high resolution for very thin films, small defects detection

## High frequency Acoustic Reflectometry

- Thin-film piezoelectric transducer
- Analysis of reflected acoustic waves at top and bottom of the structure (at different delays)
- Reflection is affected by filling of high aspect ratio structures.

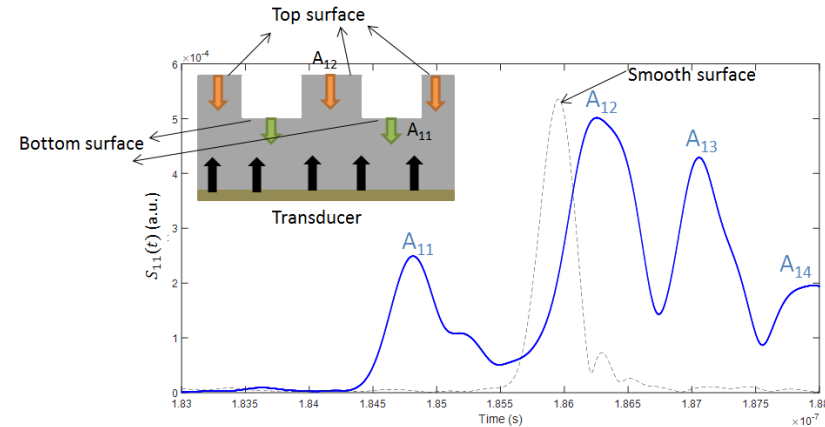

## Colored Picosecond Acoustics

- Femtosecond laser to excite (pump) and detect (probe) short acoustic pulses in the wafer itself
- By tuning the laser-wavelength, we enrich the measured signal and multiply the applications.

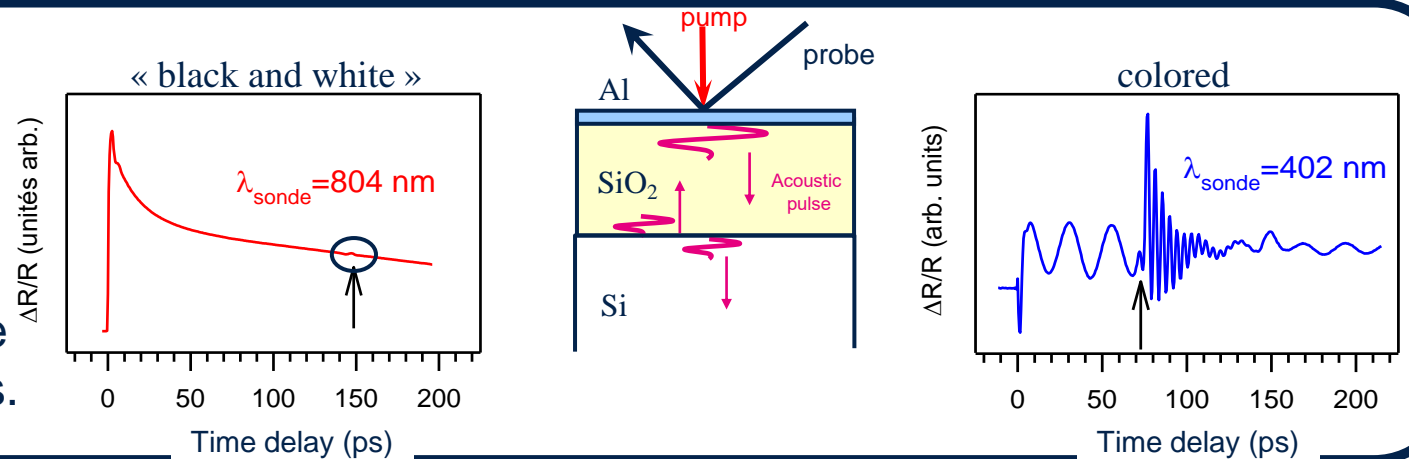

# High frequency acoustic reflectometry - WHAT?

## Thin-film ZnO transducer fabricated on the back of the wafer

### Principle

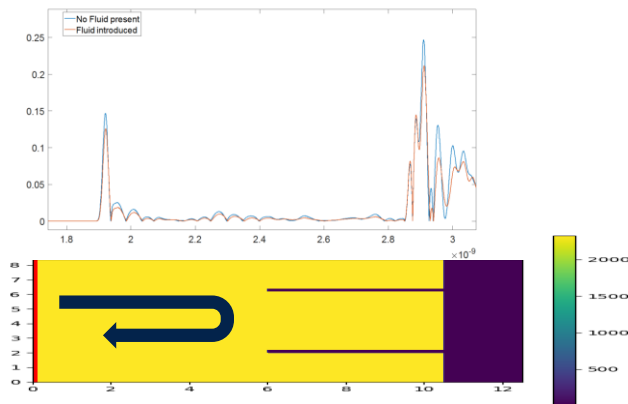
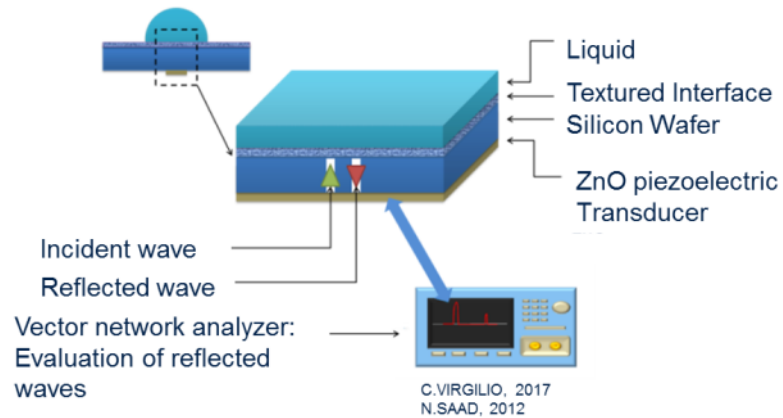

### Measurement Bench

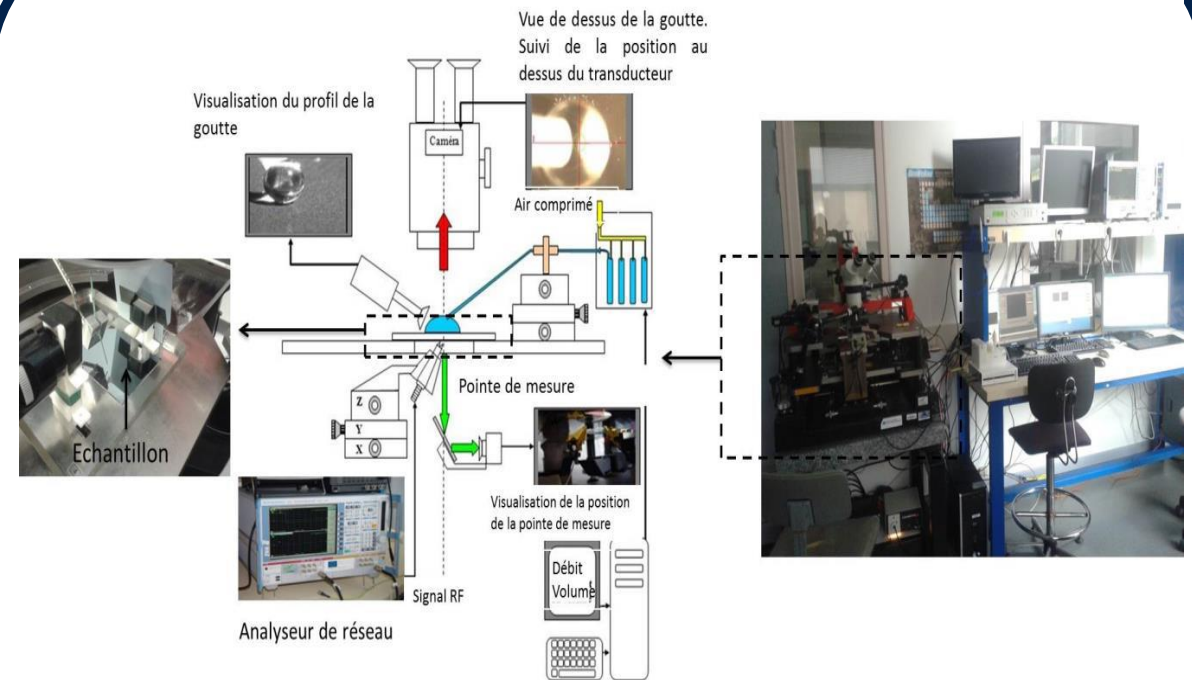

# Colored Picosecond Acoustics - WHAT?

A femtosecond laser to excite and detect hypersonic waves

 **SONAR**

**@Nanoscale**

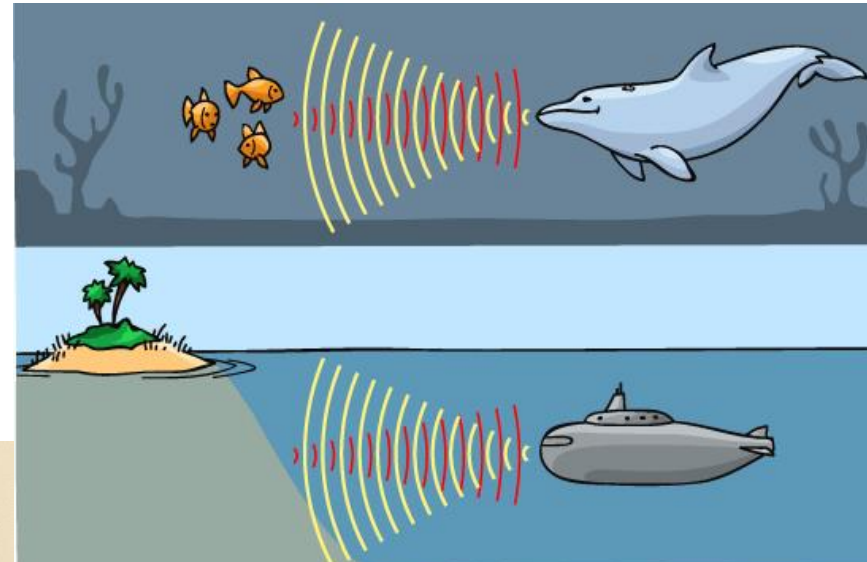

1000000X

Substrate

Thin film



**Picosecond Acoustics**

*That « hypersonic » technique is perfect for thin-film thickness range from a few nm to a few  $\mu\text{m}$*



# High freq. acoustic reflectometry – Past Achievements

## Wetting in Micro-channel

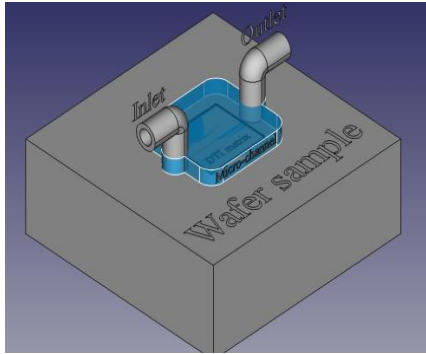

- Micro-channel to simulate industrial cleaning conditions
- Dimensions chosen according to the DTI matrix size: [40 – 80]  $\mu\text{m}$  in height and 3 mm<sup>2</sup> in length  $\times$  width

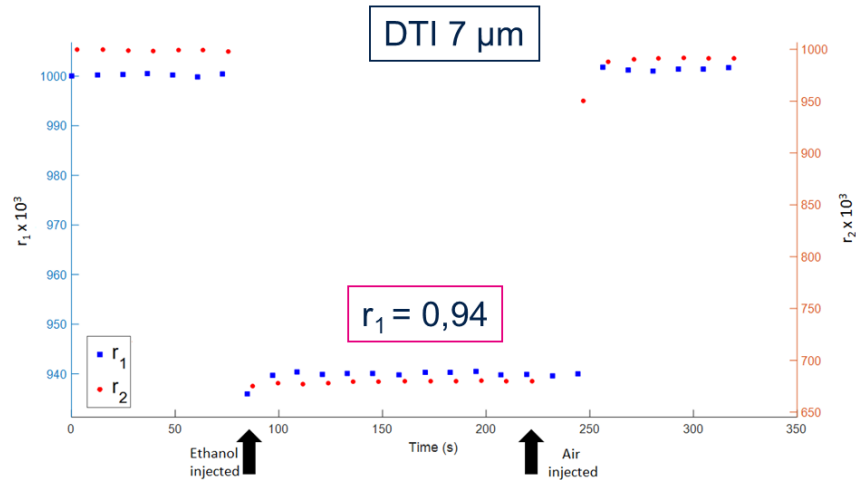

Partial wetting across the DTI samples

## Polymer Wetting Characterization

- Use of NOA61 (Norland Optical Adhesive)
- NOA61 solidifies under UV radiation then the structure shape in the liquid state is preserved and can be observed using FIB & SEM
- Two DTI sample wafers, deposition of NOA61 droplets then
  - 1) Acoustic characterization
  - 2) UV lamp + FIB
- The % wetting of the NOA 61 corresponds well with the results obtained with the DI water / ethanol mixtures

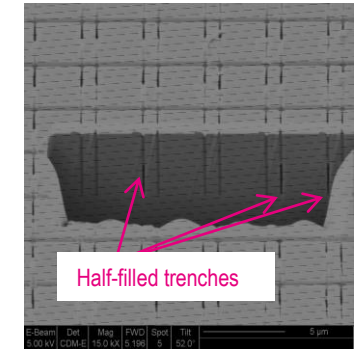
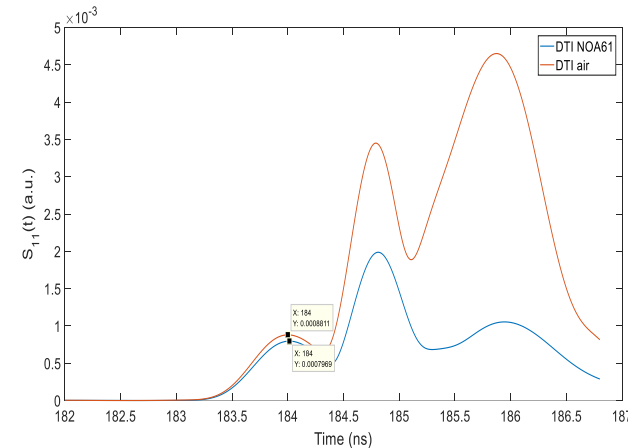

Heterogeneous filling of trenches with apparent wetting defects

# Colored Picosecond Acoustics – Past Achievements

## Wafer to wafer bonding

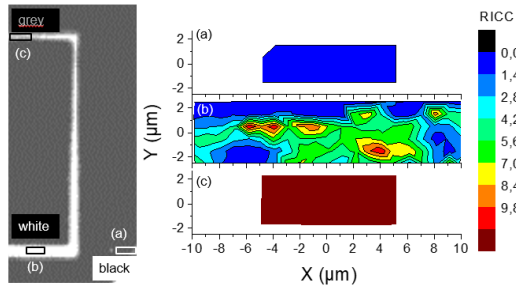

- Comparison between Scanning Acoustic Microscope (SAM) and Colored Picosecond Acoustics (APiC)
- Same acoustic waves but higher in frequency in APiC than SAM
- Adhesion fluctuations are detected along the copper line

S. Bossut (PhD CIFRE)

APiC as a high resolution Scanning Acoustic Microscope

## Ultra-thin SiGe stressed layer

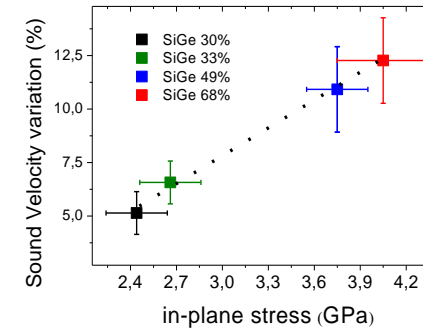

- Sound velocity is measured on SGOI wafers made of ultra-thin SiGe layers.
- According to the in-plane stress, sound velocity is found to deviate from the expected value.

A. Chargui (Postdoc)

A new application of APiC is demonstrated to measure in-plane stress

## Dielectric/Resin interface for imagers

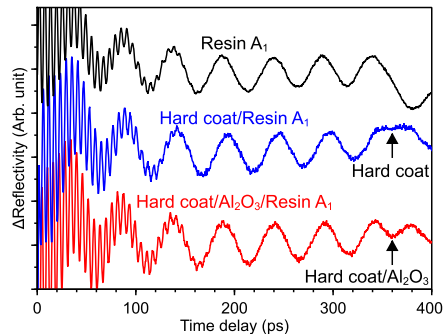

- Elasticity of Various thin-film resins used in imagers is measured using APiC
- The interface between top coat and resin is identified thanks to the time-resolved character of the measurement

F. Chevreux (PhD CIFRE)

Various dielectric/resin interfaces are investigated using APiC

## Elasticity at Different Temperatures

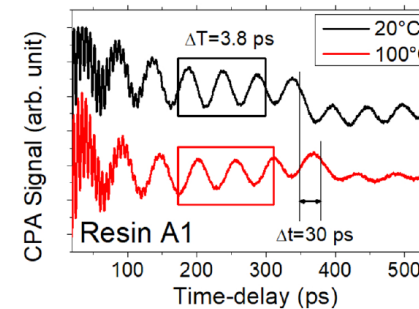

- As the sample is heated, both thickness and elasticity change.
- Both variations are extracted separately by combining Colored Picosecond Acoustics and Ellipsometry

F. Chevreux (PhD CIFRE)

Elasticity and thermal expansion of thin-film resins

# Topic 4

## Functional packaging and integrated thermics

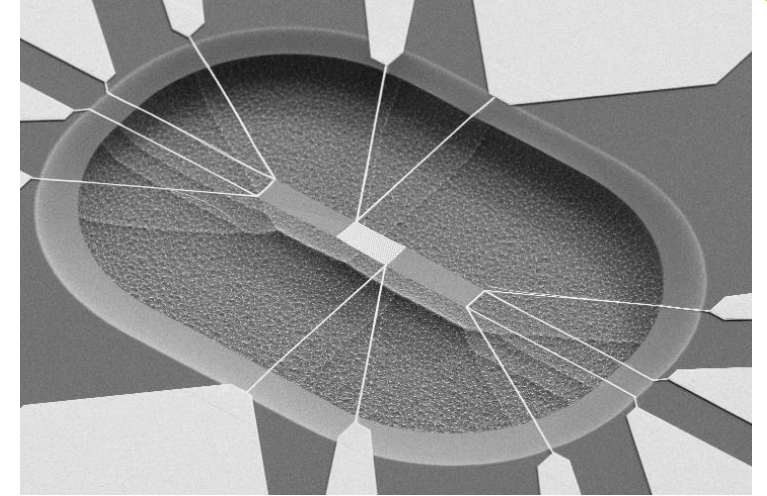
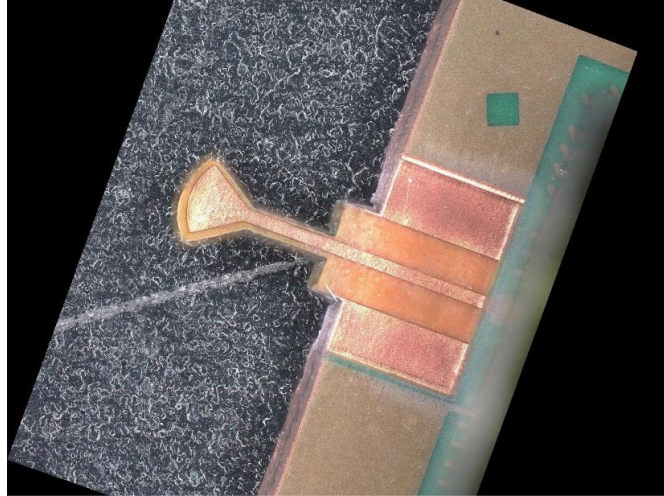

### IEMN

J.-F. Robillard  
E. Dubois  
E. Blandre  
J. Philippe  
E. Okada  
S. Lépilliet

### ST

S. Monfray  
A. Fleury  
S. Jeannot  
R. Simola  
J. Sandrini  
Y. LeFric

### PhD/PDoc

J. Canosa  
M. Brouillard  
H. Ikzibane  
A. Patil  
V. Fiorese  
M. Alawar  
D. Gheysens  
C. Mercier





# Functional Packaging and Thermal Management HOW?

Electro-thermal analysis of complex functions (PCM, RF switch, mmW-THz functions-in-the-guide....)

- Metrology of electro-thermal systems (PCRam, RF Switch, Thermoelectric)
- Thermal management at Device/Component/System level

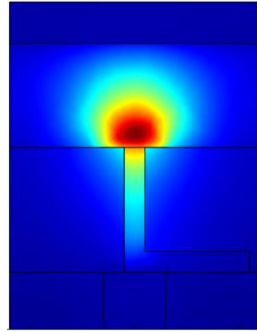

Modeling

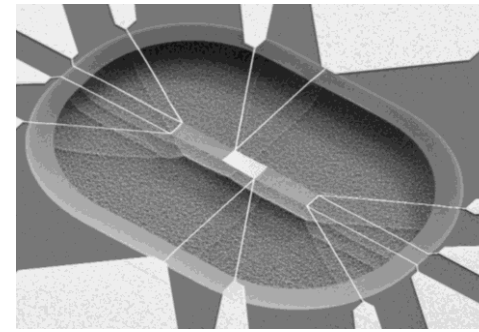

Fabrication of test structures

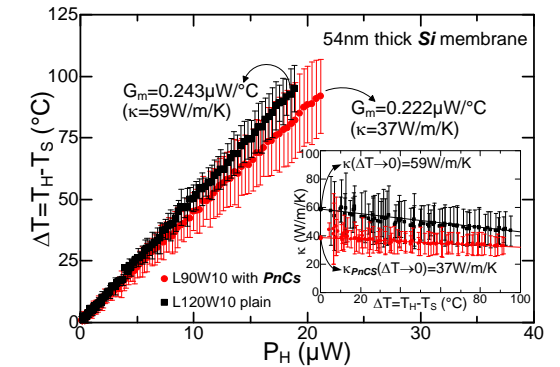

Thermal characterization

- Femtosecond laser-based  $\mu$ -structuring to fill the 1 $\mu\text{m}$ -1mm fabrication gap
- Enhancement of intrinsic performance, efficiency and reliability
- Thermal management at device/circuit/system level

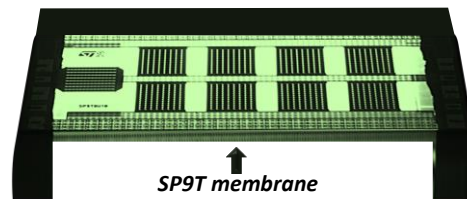

Microfabrication

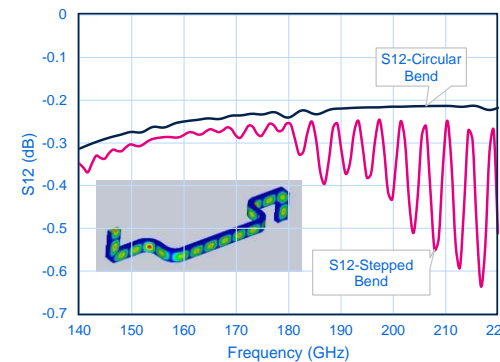

Design/modeling

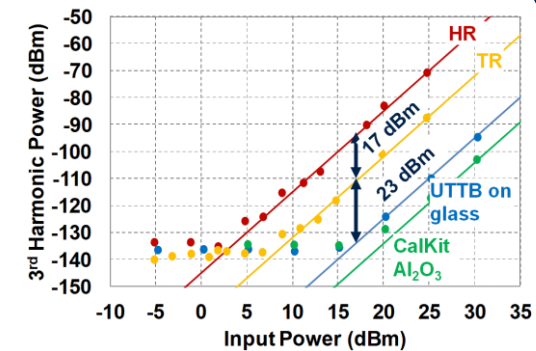

HF characterization

# Functional Packaging VISION WHAT?

Bridge the 1 $\mu$ m-1mm fabrication gap using new process tools (laser)

## Local substrate engineering

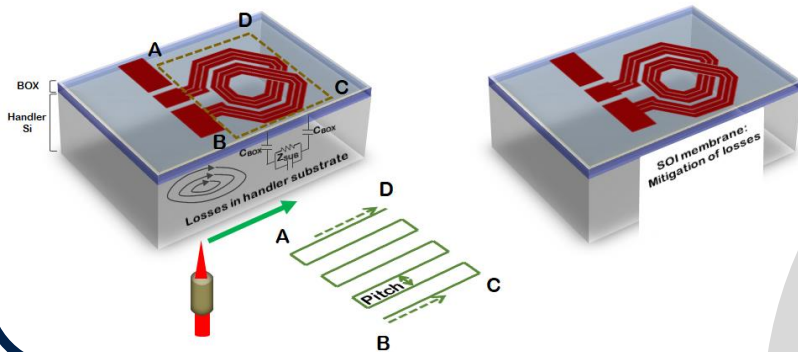

## Femtosecond

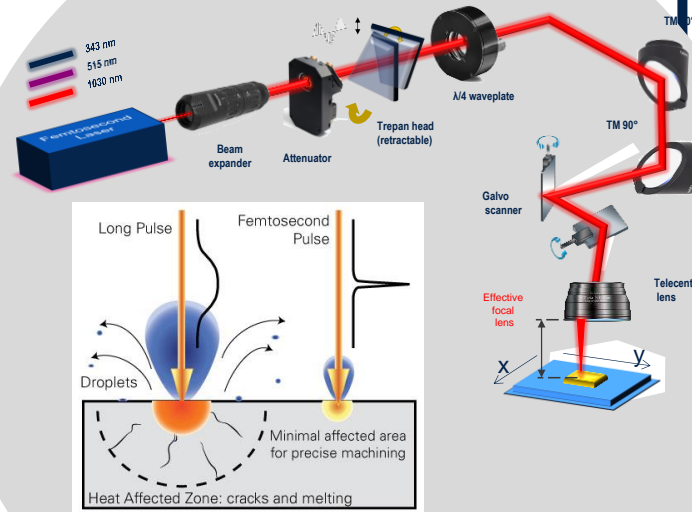

## laser $\mu$ machining

RF device/circuit ultimate perf  
( $R_{on}$ - $C_{off}$ , loss factor, linearity, power handling)

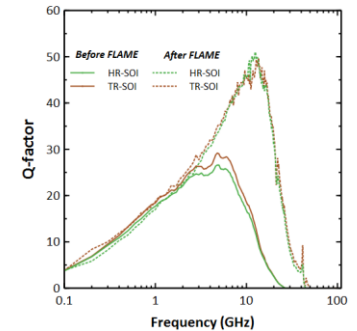
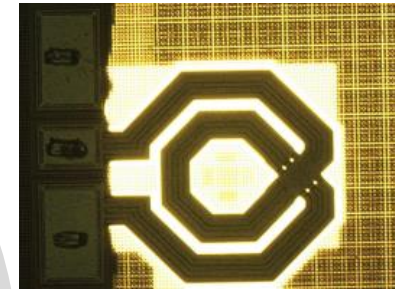

## Embedded Si chips in compact mmW/THz waveguides

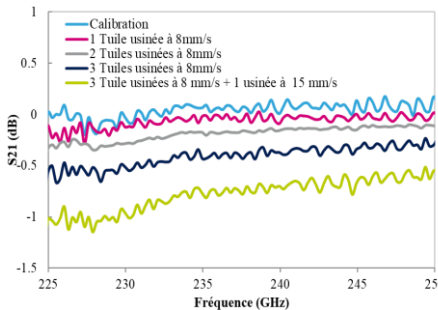
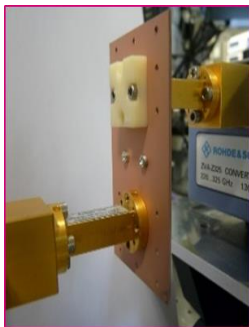

## Smart Test-in-MicroProbe

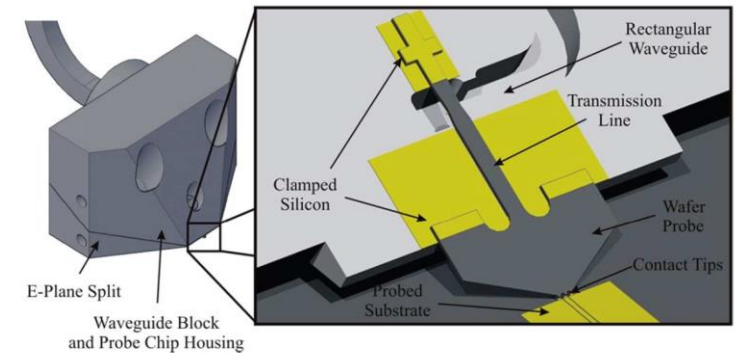

Shared Vision with Theme 1

# Thermal Management VISION WHAT?

Converging techniques towards versatile and swift metrology

## $\mu$ - Raman Thermometry



## 3-omega and electro-thermal

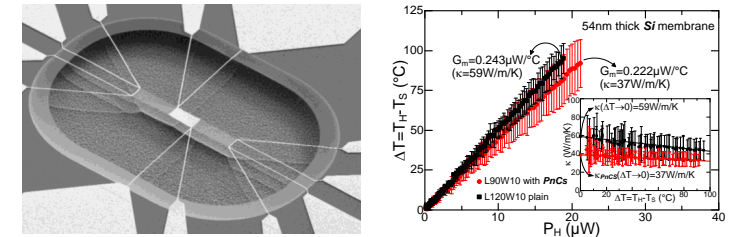

## Built-In Thermal Test

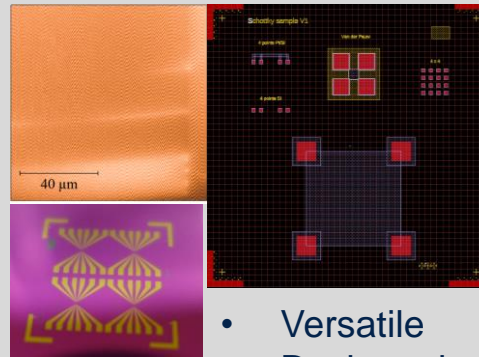

- Versatile
- Device-mimetic
- Quantitative

## Structures

## Scanning Thermal Microscopy

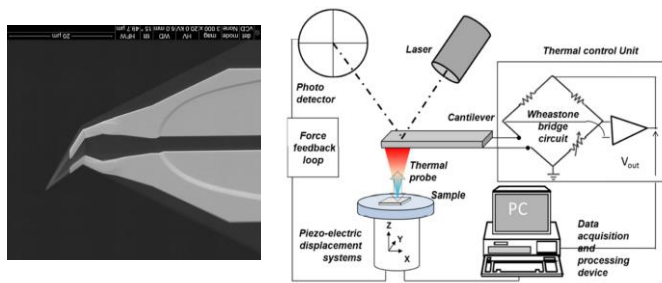

## Time-Domain Thermo Reflectance

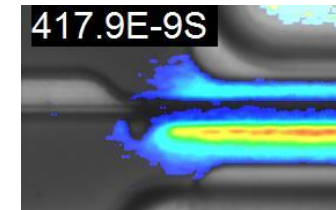



# Functional Packaging – Past Achievements

## Electro(-Optical) Interposer

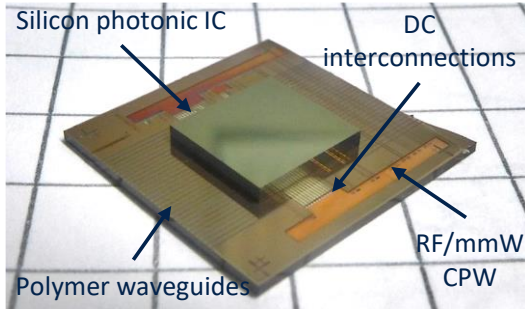

- Single mode polymer waveguides
- RF transmission lines
  - 50 Gb/s signals over a few millimeters
  - Insertion losses < 3 dB/mm at 75 GHz.
- Slanted mirror for optical signal redirection
- Demonstration of optical coupling with a flip-chip bonded PIC25G IC

J.M. Boucaud (PhD CIFRE), Q. Hivin (PhD Univ)

Electrical interposer for Si chip coupling to mmW/THz waveguide

## Local Substrate Engineering

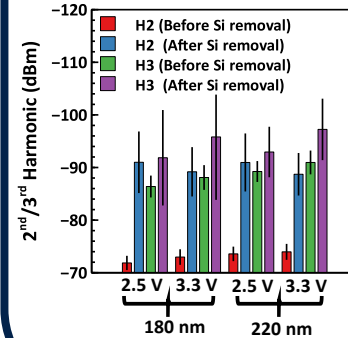

- Probe ultimate performance of devices/circuits by local, removal of substrate handler
- Applied to H9SOI technology
  - substrate coupling in test structures
  - RF switch: mitigation of non linear effects (harmonics)
  - Inductance: boost Q factor and decrease of loss factor
  - LNA: improvement of noise figure

A. Bhaskar (PhD CIFRE), J. Philippe (PhD Univ)

Application to 65 nm RF-PDSOI to boost  $R_{on}-C_{off}$  figure-of-merit

## mmW Guide & Chip-to-Guide Transition

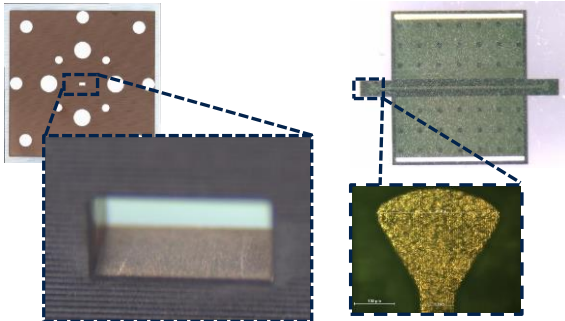

- Compact low loss guides
- Coupling mmW Si chips to rectangular waveguides
- Laser  $\mu$ machining for low cost and fast prototyping

A. Alves (PDoc NANO2022)  
C. Belem (PhD CIFRE)

Building blocks to assess Si tech. at system level and smart test-in- $\mu$ probe

## Packaged Noise Source

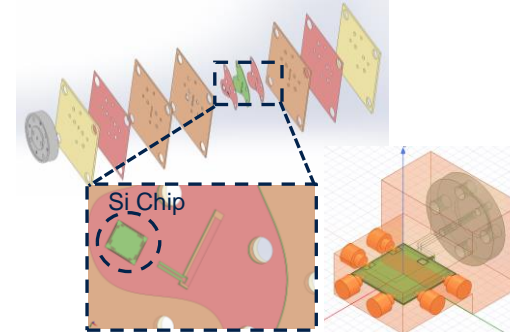

- Tools and methodology to characterize 500 GHz devices (B55): SS, noise, power
- Go beyond successfully developed in-situ measurement approach (BIST)
- Develop compact and loss-less source 'as close as possible to the tip' for on-wafer measurements

V. Fiorese (PhD CIFRE), M. Alawar (PhD NANO2022)

From test in-situ > smart test-in-flange > smart test-in- $\mu$ probe

Interdisciplinary with Theme 1



### Theme 4 Scientific Production

42 Journals	11 Invited	15 patents & 38 ext.
88 Conferences	3 Book chapters	20 PhD defended

Interdisciplinary with Theme 1



# Thermal Management – Past Achievements

## Integrated Silicon Thermoelectrics

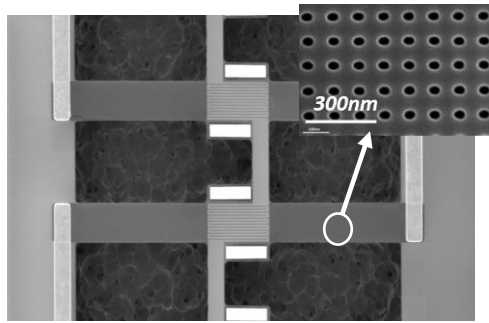

- Demonstration of crystalline silicon Thermoelectric generation
- Use of innovative Phonon Engineering methodology
- State-of-Art mW/cm<sup>2</sup>/K<sup>2</sup> results
- CMOS compatibility

T. M. Bah (PhD CIFRE)  
V. Lacatena (PhD CIFRE)

Alternative thermoelectric materials for IoT

## Thermal conductivity metrology

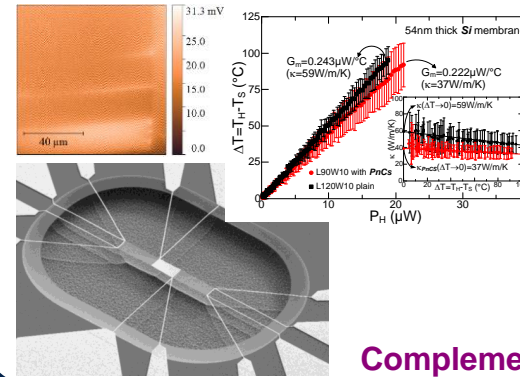

- Fabrication of thermal test structures
- Thermal conductivity measurement
- Raman thermometry
- Scanning Thermal μscope
- Electro-thermal methods

M. Haras (PhD CIFRE)  
J. Yin (PDoc TIPTOP)

Complementary techniques for characterization

## Thermal Engineering

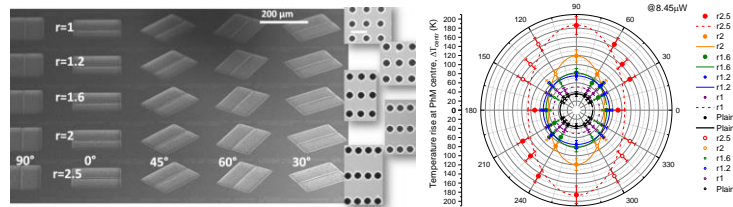

S. Didenko (PhD ERC)

- Direction-dependent thermal conductivity modulation
- Use of innovative Phonon Engineering methodology
- Raman μ Thermometry

Leveraging nanoscale effects for thermics

## Thermal Management

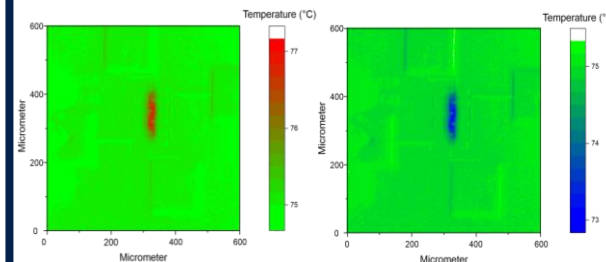

- Local Peltier cooling
- Local Joule heating
- Fully CMOS compatible
- Applications: Lidar (thermo-optics), SPAD (noise reduction), PCRam (efficiency enhancement), RF switches

Integrating cooling devices for performance enhancement

### Theme 4 Scientific Production

42 Journals  
88 Conferences

11 Invited  
3 Book chapters

15 patents & 38 ext.  
20 PhD defended

# T4-Ecosystem

## LEAF EQUIPEX infrastructure



*Laser procEssing pLAtform  
for multiFunctional  
packaging*

Micro-nano structuration



Functional packaging for high-frequency & THz

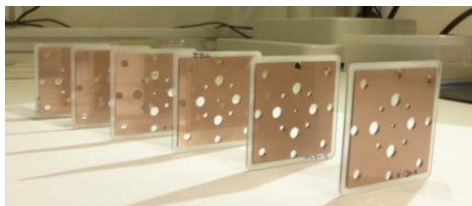

## LEAF Project outcome

- 46 PhD/PDOC Users
- Support to 60 collaborative projects (ANR, H2020, DGE, ERC...)
- 30 academic partnerships
- 25 industrial partnerships
- > 600 micromachining operations
- > 100 journal/conf. publications



## ERC UPTEG Project

*Unconventional Principles  
of Thermoelectric Generation*

Leveraging results from:

- 3 PhD
- 2 PDoc
- 10 RICL
- 1 patent
- 22 oral com. (IEDM, SSDM...)



**ST-IEMN**  
*Pascal Ancy*  
**Common Lab**



## Projects



- IPCEI-NANO2022 'Fonctional Packaging'
- IPCEI ME-CT 2026 'Fonctional Packaging mmW-THz'
- TIPTOP
- 'High sensitivity thermal probes' HANIBAL
- 'Heat transport in the quantum limit' EFFICACE Heat transfer at Si-Metal'

## Networks

GDR NAME  
'Nanomaterials for Energy'  
49 Labs, 402 Researchers



RENATECH  
μ/nano fab  
network



## IEMN Tech. facilities

- Short development loops
- Arbitrary sample/wafer size
- Wide range of materials

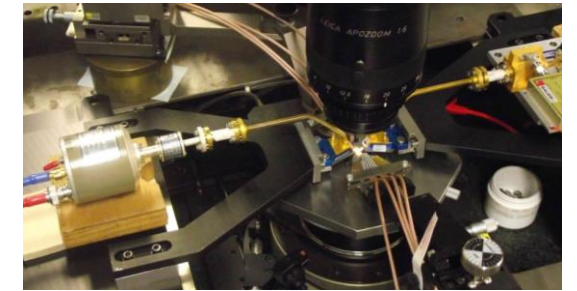

1400m² characterization facility



1600m² clean room facility



life.augmented

# Laboratoire Commun ST-IEMN 20 ans



- IEMN en bref
- Les 4 thèmes du LabCom (Réalisations, Visions)
  - T1: Millimeter-wave datacoms and photonics
  - T2: Communication systems and AI hardware
  - T3: Metrology using high frequency acoustics
  - T4: Functional packaging and integrated thermics
- Ecosystème du LabCom
  - Projets Collaboratifs
  - Production Scientifique et Brevets
  - Doctorants



# 30 Collaborative projects

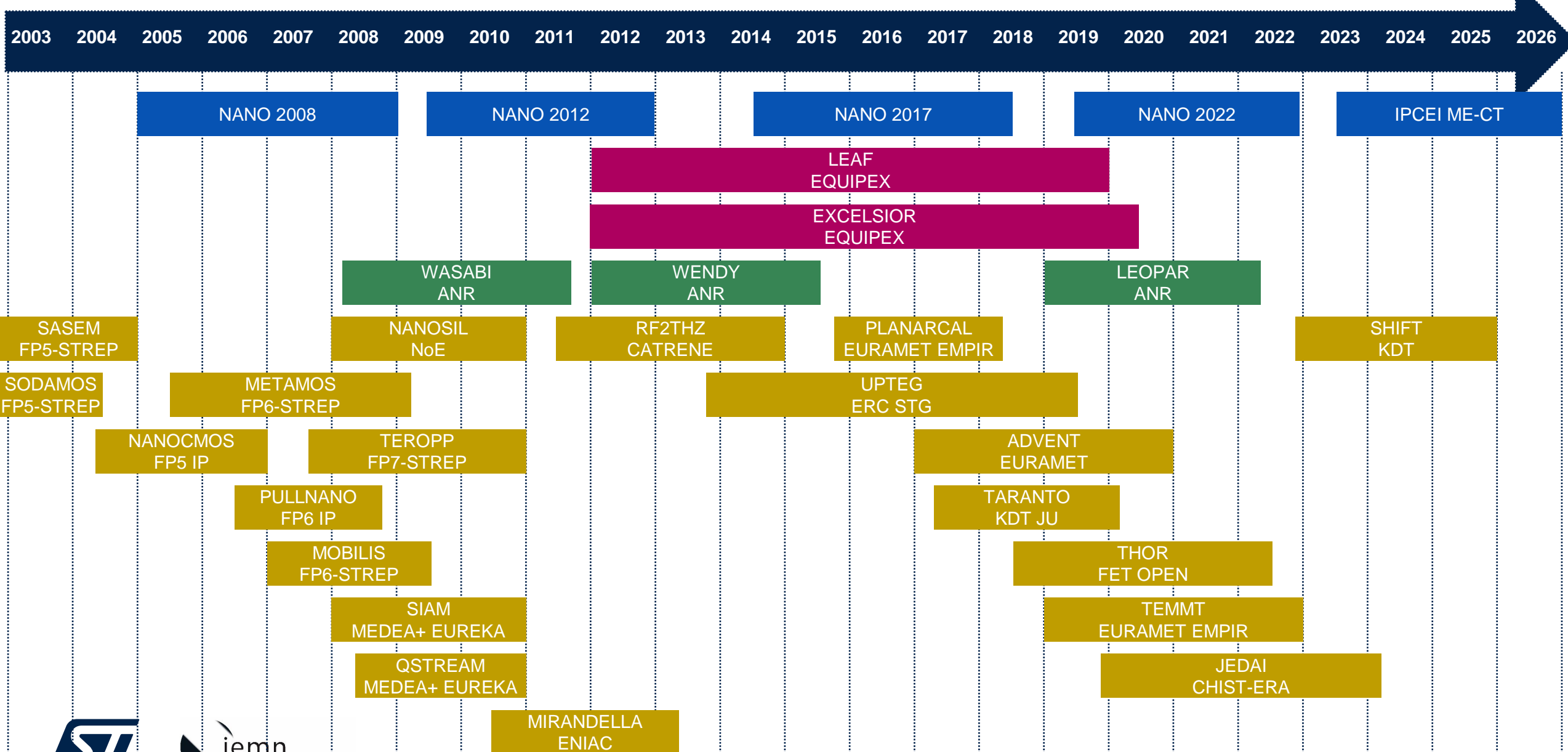



# Production

Jan 2003 - Dec 2022 (936 produits de publication)

- 155 journaux
- 494 conférences (incl. invitées) } 649

T1: Millimeter-wave datacoms and photonics  
 T2: AI hardware and communication systems  
 T3: Metrology using high frequency acoustics  
 T4: Functional packaging and integrated thermics

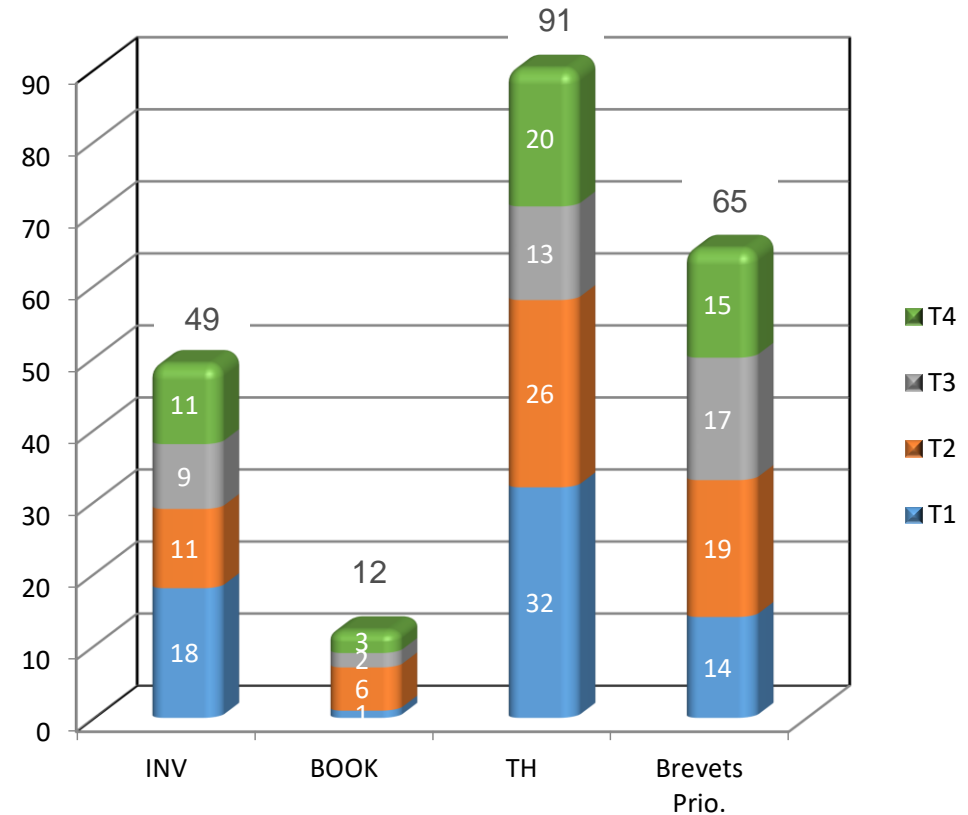
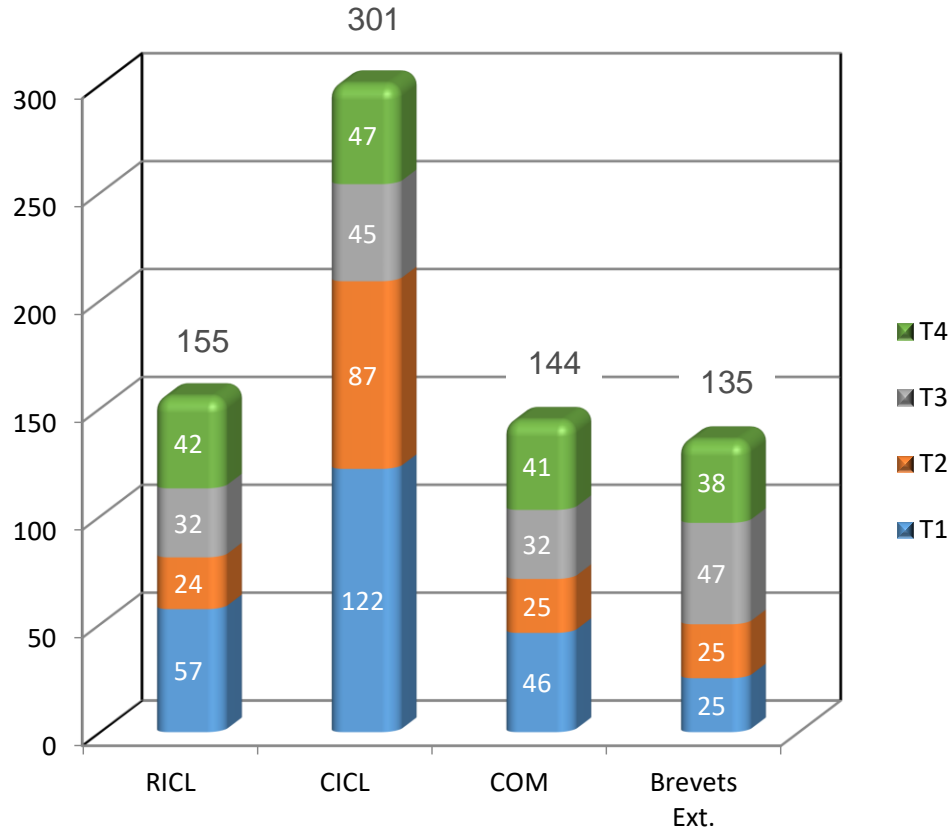

RICL= Articles dans une revue internationale à comité de lecture  
 CICL= Communications internationales avec actes  
 COM= Communications internationales sans actes  
 Brevets Ext.= Extensions internationales brevets

INV= Conférences invitées  
 BOOK= Direction ou chapitres d'ouvrages  
 TH= Thèses soutenues  
 Brevets Prio.= Brevets prioritaires

# Bilan Thèses

<b>Thèses</b>	<b>ALL</b>	<b>T1</b>	<b>T2</b>	<b>T3</b>	<b>T4</b>
<b>Soutenues</b>	91	32	26	13	20
<b>En cours</b>	18	6	5	1	6
<b>Total (sout. / en cours)</b>	109	38	31	14	26
<b>CIFRE / Total</b>	67	25	18	9	15
<b>CIFRE / Total (%)</b>	62%	65.8%	58.1%	69.2%	57.7%
<b>Poursuite carrière ST</b>	24	11	7	1	5
<b>Poursuite carrière aca.</b>	10	3	2	1	4

# Carrière des doctorants (1/2)

Thème	Nom	Prénom	Date Soutenance	Carrière post-Thèse
T1	VANMACKELBERG	Matthieu	oct.-01	MMJ Services
T1	SILIGARIS	Alexandre	déc.-04	CEA
T1	PAVAGEAU	Christophe	déc.-05	INCIZE
T1	PAILLONCY	Guillaume	nov.-05	National Instruments
T1	PRUVOST	Sébastien	nov.-05	ST
T1	BOUHANA	Emmanuel	oct.-07	Patent Examiner, European Commission
T1	MARTINEAU	Baudouin	mai-08	CEA-LETI
T1	VALENTIN	Raphaël	déc.-08	XYTECH Consulting
T1	MORANDINI	Yvan	oct.-08	ST
T1	GEYNET	Baudouin	déc.-08	-
T1	WALDHOFF	Nicolas	déc.-10	MCF EIL Cote d'Opale
T1	TAGRO	Yohann	avr.-10	IC Design, Los Angeles
T1	FOURNIER	David	juin-10	ATOS
T1	POTTRAIN	Alexandre	nov.-12	ST
T1	POULAIN	Laurent	nov.-12	ICRF Normandie
T1	DORMIEU	Benjamin	déc.-12	ST
T1	DEBROUCKE	Romain	nov.-11	ST
T1	LACAVE	Thomas	déc.-11	ALEDIA
T1	CANDERLE	Elodie	déc.-14	ST
T1	OEUVRARD	Sandrine	nov.-14	LYNRED IR products
T1	DENG	Marina	déc.-14	E/C IMS Bordeaux
T1	BOSSUET	Alice	mars-17	NXP

Thème	Nom	Prénom	Date Soutenance	Carrière post-Thèse
T1	BOUVOT	Simon	mars-18	ST
T1	DAFFE	Khadim	nov.-18	CAT-AMANIA
T1	GAUTHIER	Alexis	mai-19	ST
T1	GONCALVES	Joao Azevedo	mars-19	ST
T1	BELEM GONCALVES	Cybelle	janv.-20	ST
T1	GIDEL	Vincent	oct.-20	MC2
T1	BREZZA	Eduardo	déc.-22	ST
T1	GHANEM	Haitham	déc.-20-	NXP
T1	MAYE	Caroline	sept.-21	LEOS Univ Gustave Eiffel
T1	ALAJI	Issa	nov.-20	NXP
T2	CHAMLA	David	mai-06	ST
T2	FRAPPE	Antoine	dec.-07	JUNIA
T2	RAZAFIMANDIMBY	Stéphane	dec.-07	ST
T2	FLAMENT	Axel	juin-08	JUNIA
T2	GORISSE	Jean	nov.-10	SWATCH (CH)
T2	EGOT	Matthieu	dec.-11	MIRION Technologies
T2	MULLER	Jonathan	sept.-11	E-Peas SA (CH)
T2	CRUNELLE	Romain	dec.-11	Decathlon
T2	ZELENY	Jan	oct.-11	TAE Power solution (CZ)
T2	IZQUIERDO	Cristian	mai-11	NXP (D)
T2	WERQUIN	Arnaud	juin-13	MediTek (UK)
T2	GRAVE	Baptiste	déc.-13	Qualcom (IRL)

Thèse CIFRE  
Thèse Autre financement

Carrière ST  
Carrière académique

# Carrière des doctorants (2/2)

Thème	Nom	Prénom	Date Soutenance	Carrière post-Thèse
T2	SHERRY	Hani	déc.-12	TiHive
T2	FOULON	Samuel	mai-13	ST
T2	SALAZAR	Camilo	mar.-15	CSEM (CH)
T2	SOURIKOPOULOS	Ilias	déc.-15	LEO Space Photonics (GR)
T2	GEBREYOHANNES	Fikre	déc.-16	Qualcom (IRL)
T2	MARIN	Cristian	nov.-17	Nordic Semiconductor (SE)
T2	CAUSO	Matteo	Jan.-17	Schindler Group (D)
T2	GONZALEZ	Angel	sept.-20	ST
T2	BENARROUCH	Robin	jan.-21	ST
T2	TOCHOU	Guillaume	fév.-22	ST
T2	HERISSE	Kévin	déc.-22	SATT Nord
T2	MOURRANE	Soufiane	sept.-23	ST
T3	AGACHE	Vincent	oct.-03	CEA
T3	CARUYER	Grégory	nov.05	QORVO
T3	VOLATIER	Alexandre	mars-07	QORVO
T3	EMERY	Patrick	juin-08	MENAPIC
T3	DURAND	Cédric	jan.-09	ST
T3	KONE	Issiaka	avr-10	GENERALI
T3	ROBILLARD	Jean-François	juil-08	JUNIA-ISEN
T3	MANTE	Pierre-Adrien	nov. 10	Ingénieur R&D
T3	CASSET	Fabrice	juin-14	CEA-LETI
T3	VIRGILIO	Christophe	mai-17	Ariane Group

Thème	Nom	Prénom	Date Soutenance	Carrière post-Thèse
T3	SALHAB	Abbas	fev.-22	CEA
T3	CHEVREUX	Fabien	sept.-23	INFINEON
T4	LARRIEU	Guilhem	avr.-04	LAAS-CNRS
T4	PENAUD	Julien	oct.-06	TOTAL PV
T4	CHARBUILLET	Clément	juin-07	ST
T4	FRULEUX	Frédérique	juin-07	THALES
T4	BREIL	Nicolas	mai-09	Applied Materials US
T4	LECESTRE	Aurélie	jui-10	LAAS-CNRS
T4	LECAVELIER	Aurélien	mars-13	THALES
T4	MORINI	François	jun-15	Wootzano (UK)
T4	HARAS	Maciej	jan.-16	CEZAMAT
T4	LACATENA	Valéria	juin-16	XFAB Corbeil
T4	PHILIPPE	Justine	sept.-17	JUNIA-ISEN
T4	NIEBOWJESKI	Heimanu	nov.-14	CEA-LETI
T4	BORREL	Julien	mar.-17	ST
T4	ZHU	Tianqi	déc.-19	BELIMO (CH)
T4	DIDENKO	Stanislav	juin-19	JSC IT Labs
T4	BHASKAR	Arun	oct.-19	QUALCOMM
T4	HIVIN	Quentin	juin-19	KEOPSYS-LUMIBIRD
T4	BAH	Thierno	jui.-19	ST
T4	BOUCAUD	Jean-Marc	juin-20	ST
T4	FIGRESE	Victor	sept.-22	ST

Thèse CIFRE
Thèse Autre financement

Carrière ST
Carrière académique



# Comité de Pilotage et Workshop annuel PhD & Pdocs



# 2023

ST-IEMN Joint Laboratory - PhD Workshop Program  
Tuesday 13 Feb. 2024  
Room Mont Blanc

## Agenda

08:30 Welcome Coffee

- 25 Présentations

- > 200 participants avec l'ouverture du Workshop en visioconférence

Topic 3	Small-scale elastic metrology using high-frequency acoustic waves
08:45 (LS)	<b>Compatibility study of silicon-based films with lithography resists for imaging applications</b> Fabien CHEVREUX CIFRE PhD defended on 11 Dec. 2023 (Remote presentation) – Supervision A. Devos, L.L. Chapelon
09:05 (RS)	<b>Evaluation of Polymer wetting in high aspect ratio nanostructures using FIB and acoustic characterization</b> Abbas SALHAB Post-doc funded under NANO2022 research program (Remote presentation) – Supervision J. Carlier, P. Garnier

LS=Long Slot (16' presentation + 4' questions) RS=Regular Slot (12' presentation + 3' questions) SS=Short Slot (8' presentation + 2' questions)

Topic 1	Potential of advanced technologies in the millimeter wave and photonic domains
09:20 (LS)	<b>Automated and robotic on-wafer probe station for precision Ground-Signal-Ground (GSG) probing</b> Cerine MOKHTARI PhD funded under NANO2022 and defended on 05 Dec. 2023 (Remote presentation) – Supervision K. Haddadi, D. Gloria
09:40 (LS)	<b>Characterization &amp; modeling of 650V GaN diodes for high frequency power conversion</b> Martin DOUBLET PhD funded under NANO2022 and defended on 28 Jun. 2023 – Supervision J.C. de Jaeger, N. Defrance, E. Bouyssou
10:00 (RS)	<b>Contribution to the development of THz Sub-Harmonic Mixers in RF-SOI &amp; BiCMOS technologies targeting high-speed communications</b> David OVALLE TAYLOR 3 <sup>rd</sup> year – CIFRE PhD ST-Univ. Nice-IEMN – Supervision G. Ducournau, C. Luxey, F. Gianesello
10:15 (RS)	<b>Development of InP DHBT technology for sub-THz power amplification in 6G telecoms</b> Abdelmalek ZEMOUR 1 <sup>st</sup> year – CIFRE PhD ST-IEMN – Supervision M. Zaknoun, P. Chevalier
10:30 (SS)	<b>InP-on-Si Heterojunction bipolar transistor for low noise sub-THz power amplification for 6G telecoms</b> Jihed DEROUICHE 1 <sup>st</sup> year – PhD funded under IEMN-IPCEI-04 program (Remote presentation) – Supervision M. Zaknoun, P. Chevalier
10:40 (RS)	<b>Topology solutions for Agile Front-End Module at mmW frequencies (140-170GHz) using in situ calibration: D-band phase shifters design, comparison between active and passive approach</b> Larbi BOUKHEZAR 2 <sup>nd</sup> year – CIFRE PhD ST-TIMA-IEMN – Supervision V. Knopik, M. Margaleff, C. Durand, P. Ferrari, G. Ducournau

LS=Long Slot (16' presentation + 4' questions) RS=Regular Slot (12' presentation + 3' questions) SS=Short Slot (8' presentation + 2' questions)

10:55 – 11:15 Break

11:15 (SS)	<b>Contribution to circuit design and advanced characterization for D-band communications applications</b> Yewulsew MANALE 1 <sup>st</sup> year – PhD funded under KDT SHIFT/ANR (Remote presentation) – Supervision G. Ducournau, F. Danneville, D. Gloria
11:25 (SS)	<b>Linear, non-linear, noise and power characterisation of components and realisation of functions in advanced mmW technology</b> Bachar BARIDI 1 <sup>st</sup> year – PhD funded under IEMN-IPCEI-05 (Remote presentation) – Supervision G. Ducournau, F. Danneville, D. Gloria
11:35 (RS)	<b>RF50I Technology Development for 5G Applications</b> Thomas BORDIGNON 3 <sup>rd</sup> year – CIFRE PhD ST – IEMN – Supervision F. Danneville, Y. Roelens, S. Cremer

LS=Long Slots are allocated to PhD thesis defended in 2023 SS= Short Slots are allocated to freshly started PhD thesis for subject presentation

1/2

Topic 4	RF/mmW functional packaging and microthermics
11:50 (LS)	<b>Integrated metrology devices for the study of transport properties in silicon nanostructures</b> Hafsa IKZIBANE PhD funded by Univ. Lille and defended on 29 Nov. 2023 (Remote presentation) – Supervision J.F Robillard, E. Dubois
12:10 (LS)	<b>Thermal characterization of GeSbTe alloys by Raman thermometry for phase-change memories</b> Akash PATIL CIFRE PhD ST-IEMN defended on 27 Nov. 2023 – Supervision J.F Robillard, E. Dubois, S. Jeannot, P. Boivin
12:30 (RS)	<b>Low-temperature heat transfer in SiN and Si: Quantum nanophonics</b> Jon CANOSA-DIAZ 3 <sup>rd</sup> year – PhD funded under ANR HANIBAL project – Supervision J.F Robillard
12:45 (SS)	<b>Thermal characterization of emerging materials for PCM non-volatile memories.</b> Tushar CHAKRABARTY 1 <sup>st</sup> year – CIFRE PhD ST-IEMN – Supervision J.F Robillard, S. Jeannot

12:55 – 14:30 Lunch

14:30 (RS)	<b>Micromachining and packaging of smart probes for sub-mmW on-wafer measurements</b> Maya ALAWAR 4 <sup>th</sup> year – PhD funded under IEMN-IPCEI-08 research program – Supervision E. Dubois, G. Ducournau, D. Gloria
14:45 (RS)	<b>Microcavities engineering applied to ultra-fast SOI-RFCMOS devices and circuits for 5G and beyond</b> Daniel GHEYSENS 3 <sup>rd</sup> year – CIFRE PhD ST-IEMN – Supervision E. Dubois, J.F Robillard, A. Fleury, S. Monfray
15:00 (RS)	<b>Ultra-fast RF-PCM switches for 5G and beyond</b> Corentin MERCIER 3 <sup>rd</sup> year – CIFRE PhD ST-IEMN-CEA – Supervision J.F Robillard, E. Dubois, S. Monfray, A. Fleury, B. Reig

LS=Long Slot (16' presentation + 4' questions) RS=Regular Slot (12' presentation + 3' questions) SS=Short Slot (8' presentation + 2' questions)

Topic 2	Communicating systems and AI hardware
15:15 (LS)	<b>2-Step SAR-assisted digital-slope ADC for ultra-low power radio frequency receivers</b> Jean-Baptiste CASANOVA CIFRE PhD defended on 08 Dec. 2023 – Supervision A. Kaiser, S. Nicolas, D. Perrin
15:35 (LS)	<b>Low power event-driven feature extraction unit for audio keyword spotting in 28nm FD-SOI</b> Soufiane MOURRANE CIFRE PhD defended on 11 Dec. 2023 – Supervision – Supervision A. Frappé, B. Larras, A. Cathelin
15:55 (RS)	<b>Event-driven antidictionary-based ECG classification</b> Julien DUFOREST 4 <sup>th</sup> year – PhD funded under CHIST-ERA JEDA1 program – Supervision A. Frappé, B. Larras – Sponsor: A. Cathelin, S. Clerc
16:10 (RS)	<b>A 28nm FDSOI in-cell weight update scheme using one-hot gradients for on-chip learning</b> Mathieu CHENE 3 <sup>rd</sup> year – PhD funded by AI_Engineering_PhD@Lille – Supervision A. Kaiser, A. Frappé, B. Larras – Sponsor: A. Cathelin, S. Clerc

16:25 – 16:45 Break

16:45 (RS)	<b>Multiplier-less in-memory artificial neural network in 28nm CMOS FDSOI for embedded biomedical applications</b> Antoine GAUTIER 4 <sup>th</sup> year – PhD funded under CHIST-ERA JEDA1 program – Supervision A. Frappé, B. Larras – Sponsor: A. Cathelin, S. Clerc
17:00 (SS)	<b>Phase change-memory assisted binary neural network machine learning circuit design</b> Joaquin CORNEJO 1 <sup>st</sup> year – CIFRE PhD ST-IEMN-CEA – Supervision A. Frappé, B. Larras, A. Cathelin, S. Clerc, T. Hirtzlin
17:10 (SS)	<b>Passive envelope detector design for wake-up radio in 2.4GHz band</b> Oussama CHAFAI 1 <sup>st</sup> year – CIFRE PhD ST-IEMN – Supervision A. Kaiser, A. Frappé, R. Welk, M. Ayraud

LS=Long Slot (16' presentation + 4' questions) RS=Regular Slot (12' presentation + 3' questions) SS=Short Slot (8' presentation + 2' questions)

17:20 End of Workshop

LS=Long Slots are allocated to PhD thesis defended in 2023 SS= Short Slots are allocated to freshly started PhD thesis for subject presentation

2/2





# Laboratoire Commun ST-IEMN 20 ans



# Thank you

