

Laboratoire Commun ST-IEMN 20 ans

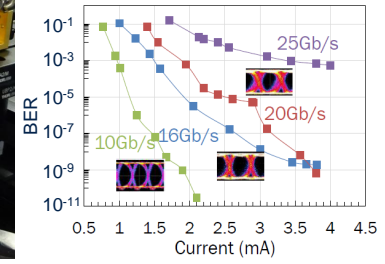

Millimeter-wave datacoms and photonics

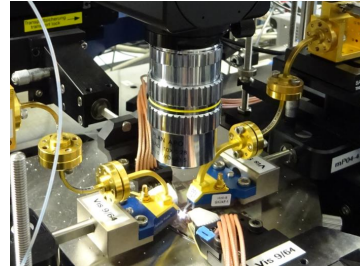

Communication systems and AI hardware

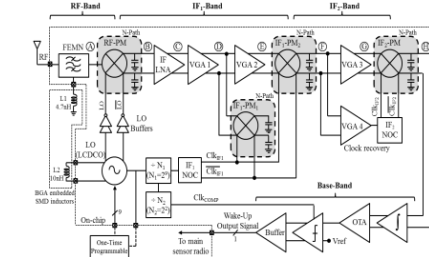
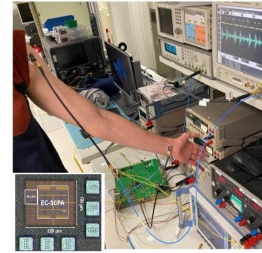

Metrology using high frequency acoustics

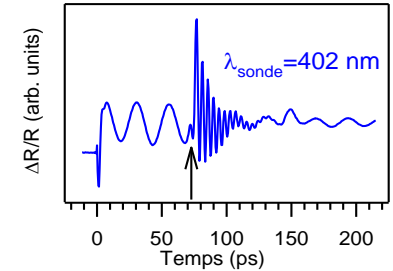
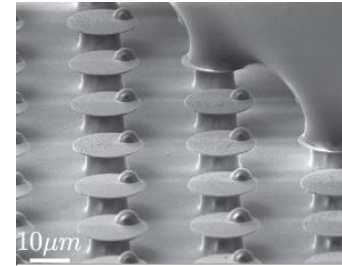

Functional packaging and integrated thermics

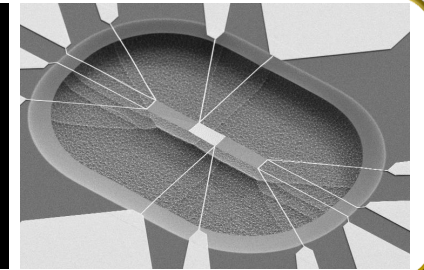
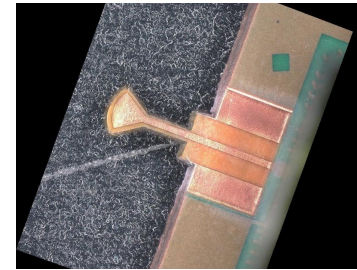



life.augmented

Laboratoire Commun ST-IEMN 20 ans



- IEMN en bref
- Les 4 thèmes du LabCom (Réalisations, Visions)
 - T1: Millimeter-wave datacoms and photonics
 - T2: Communication systems and AI hardware
 - T3: Metrology using high frequency acoustics
 - T4: Functional packaging and integrated thermics
 - Les sujets de l'IPCEI ME-CT
- Ecosystème du LabCom
 - Projets Collaboratifs
 - Production Scientifique et Brevets
 - Doctorants





IEMN at a glance

Neuromorphic Technologies
 Technologies for Health
 Transportation
 Telecom UHD
 IoT Make Sense
 Smart Energy

Materials
 Micro & Nano Devices
 Nano Characterization

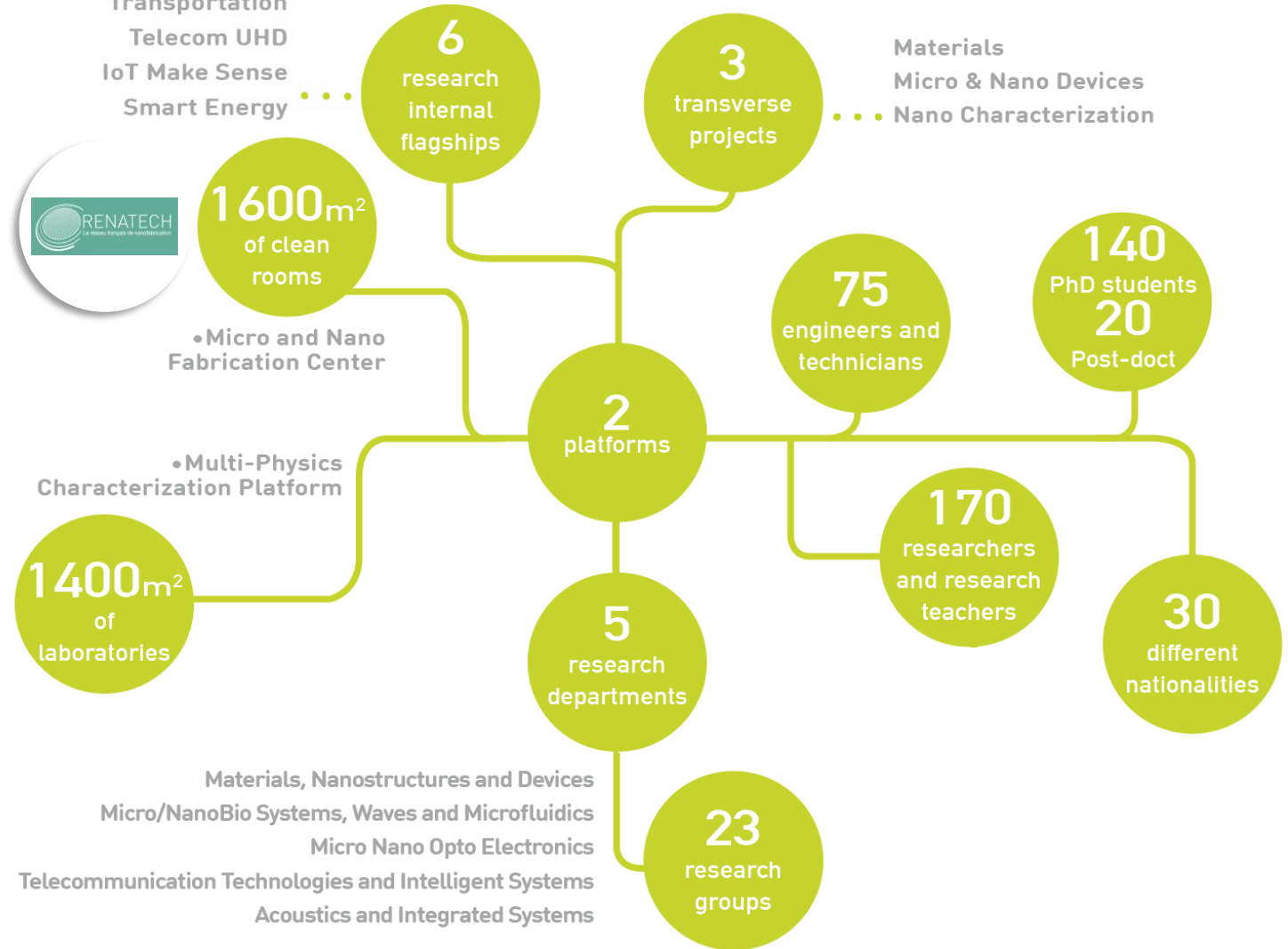



Contrats Plan Etat Région 2021-2027

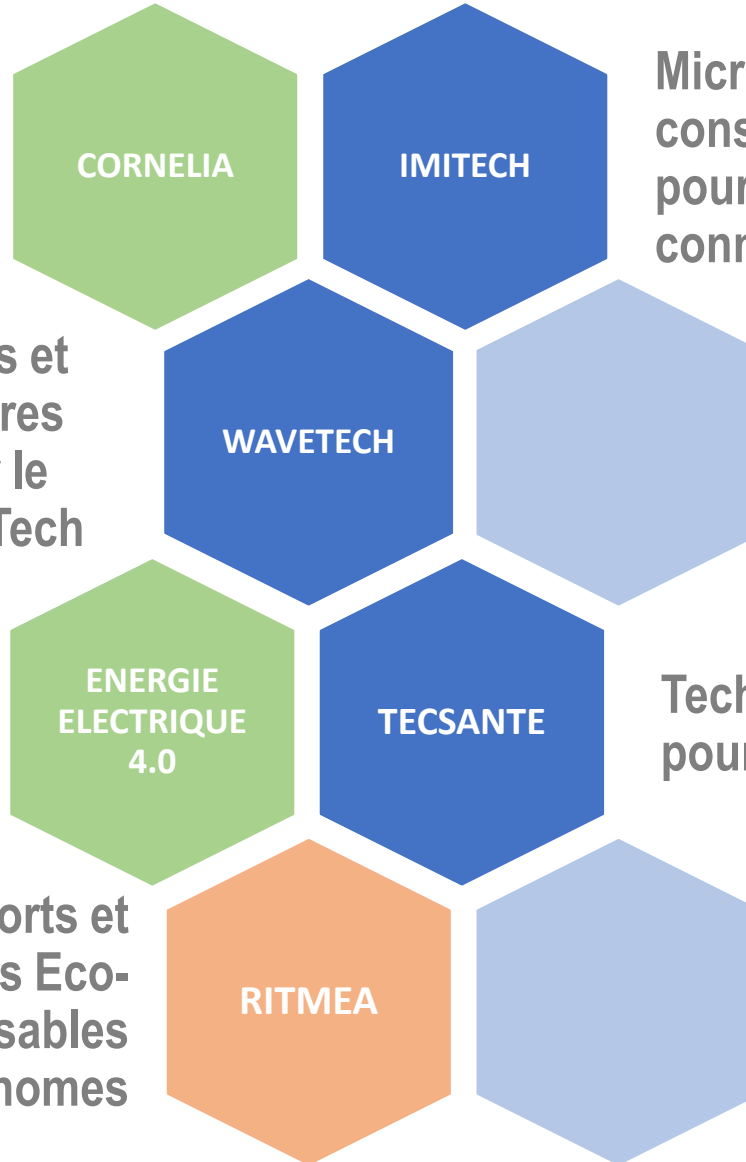

Micro-dispositifs à faible consommation d'énergie pour une société connectée et durable

Ondes et Matières pour le Deep Tech

Technologies pour la santé

Transports et Mobilités Eco-Responsables et Autonomes





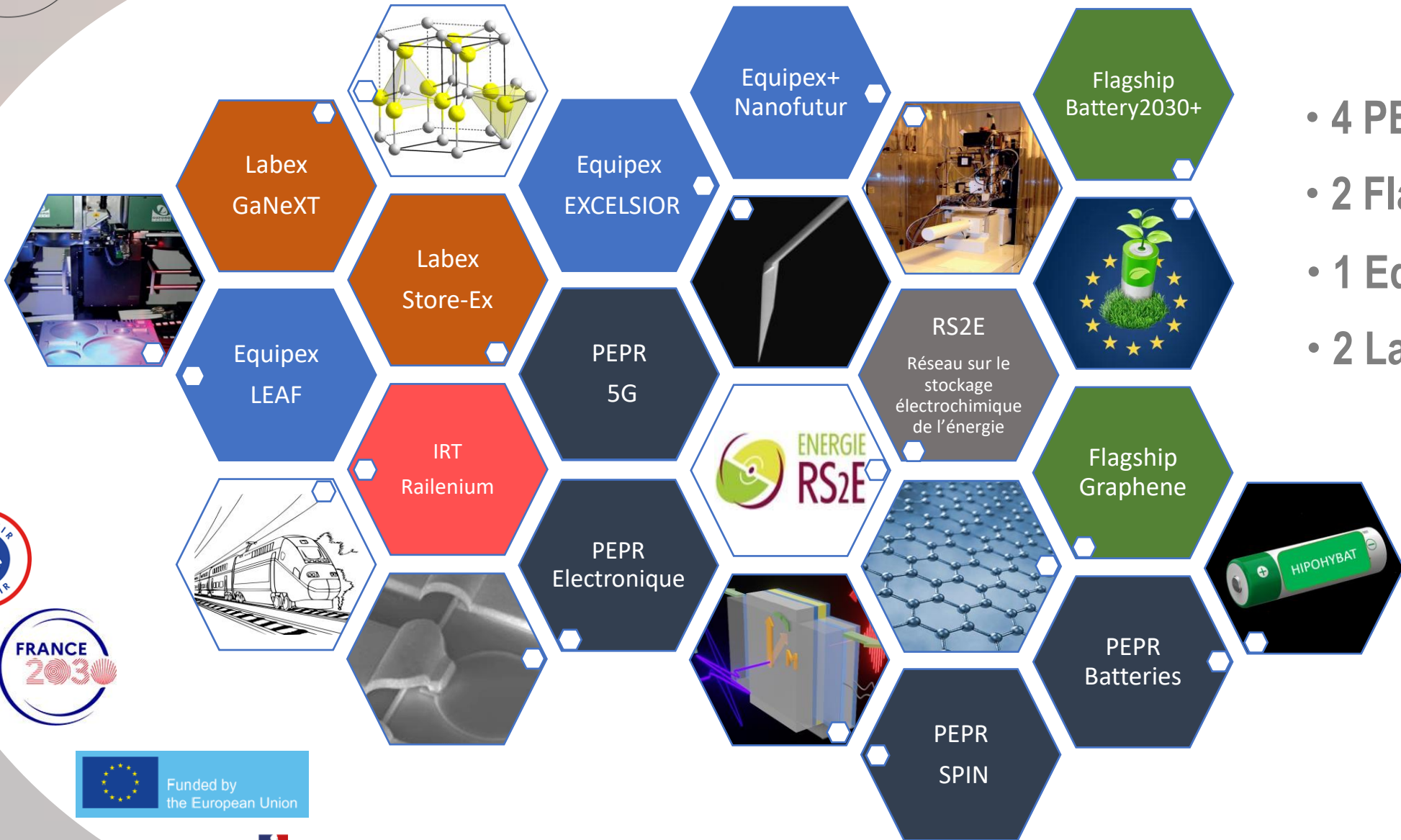

Projets structurants nationaux & européens



- 4 PEPR
- 2 Flagships EU
- 1 Equipex+
- 2 Labex





- Laboratoire commun avec STMicroelectronics (2003)  life.augmented
- Chaire industrielle TERIL-WAVES avec MC2 Technologies 
- Laboratoires communs avec HCS Pharma  et HORIBA 
- Equipe Commune LEOST – IEMN 
- **Startups issues des activités de l'IEMN depuis 2015 :**

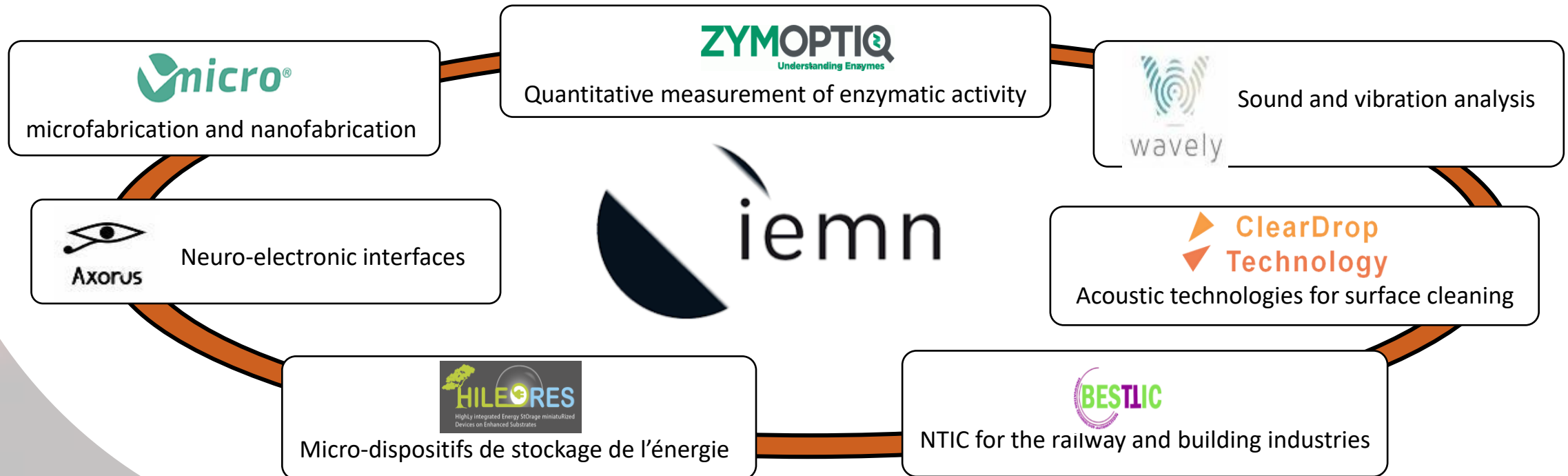



life.augmented

Laboratoire Commun ST-IEMN 20 ans



- IEMN en bref
- Les 4 thèmes du LabCom (Réalisations, Visions)
 - T1: Millimeter-wave datacoms and photonics
 - T2: Communication systems and AI hardware
 - T3: Metrology using high frequency acoustics
 - T4: Functional packaging and integrated thermics
 - Les sujets de l'IPCEI ME-CT
- Ecosystème du LabCom
 - Projets Collaboratifs
 - Production Scientifique et Brevets
 - Doctorants



ST-IEMN Joint Laboratory

- 4 Topics
- Since 2003
- 936 Publication products
- 155 Journals
- 445 Conferences
- 49 Inv. Talks
- 65 patents+ 135 ext
- 91 PhD Thesis defended
- 18 PhD Thesis on-going
- 2 Start-up
Menapic, MC2
- National Programs NANO
2008/2012/2017/2022
- IPCEI 2026
- 2 EQUIPEX (LEAF, EXCELSIOR)
- 20 European projects shared

T1

Millimeter-wave datacoms and photonics

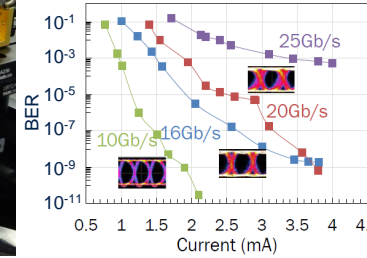
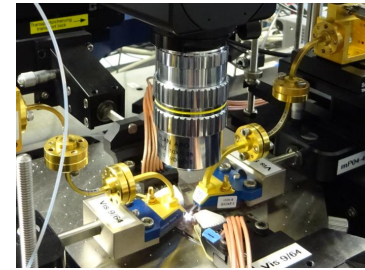

T2

Communication systems and AI hardware

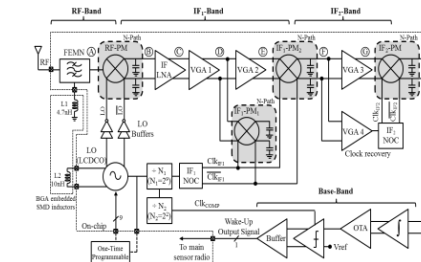
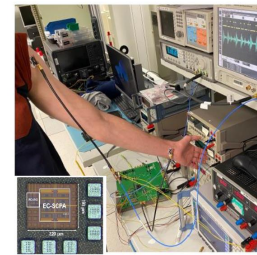

T3

Metrology using high frequency acoustics

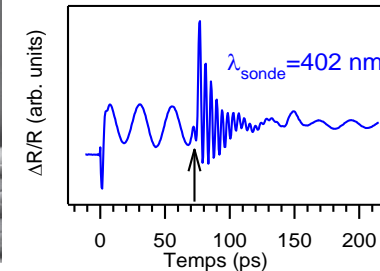
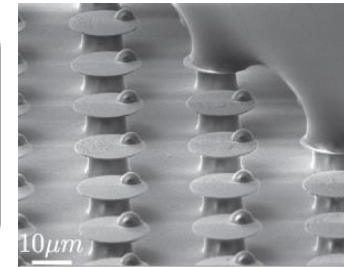

T4

Functional packaging and integrated thermics

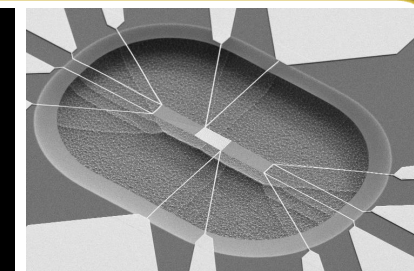
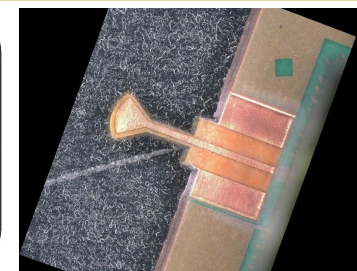

ST-IEMN Joint Laboratory



Gouvernance

Co-direction LabCom
E. Dubois, A. Cathelin

T1: G. Ducournau
D. Gloria

T2: A. Frappé, A. Kaiser
A. Cathelin

T3: A. Devos, J. Carlier
D. Le Cunff, L. Broussous

T4: J.F. Robillard, E. Dubois
S. Monfray, S. Jeannot, D. Gloria

T1

Millimeter-wave datacoms and photonics

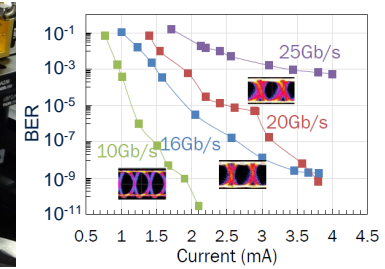
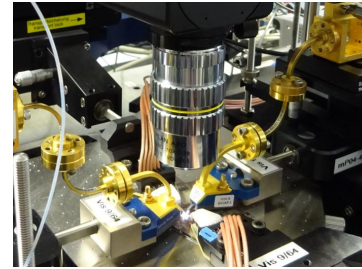

T2

Communication systems and AI hardware

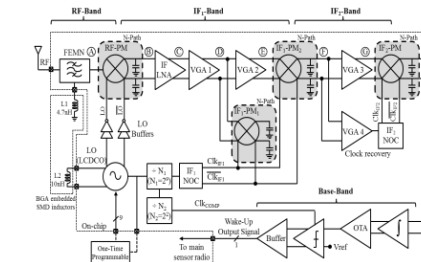
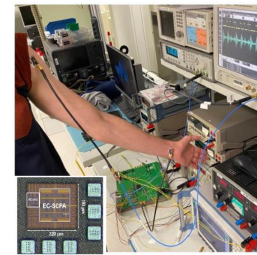

T3

Metrology using high frequency acoustics

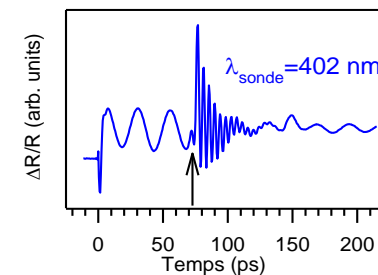
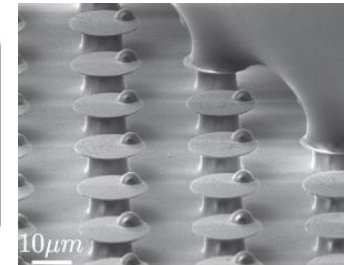

T4

Functional packaging and integrated thermics

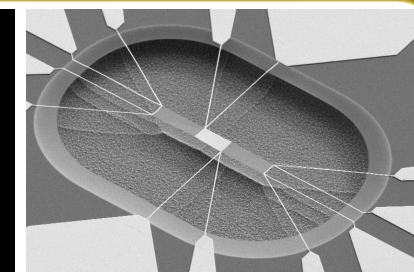
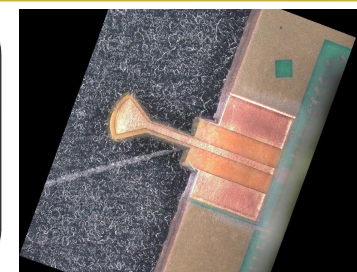

11

Groups involved in the Joint Lab

- EPIPHY: EPItaxy and PHYSics of heterostructures
- NCM: Nanostructures, nanoComponents & Molecules
- PHYSICS: Nano materials physical properties
- SILPHYDE : PHYsical SIMuLation of Electronic and optoelectronic Devices
- SUBLAMBDA: Opto and Micro Electronic Devices
- THZ PHOTONICS
- PUISSANCE: Microwave Power Devices
- ANODE: Advanced NanOmeter Devices
- CARBON: Graphene based devices
- OPTO: Optoelectronics
- MITEC: Microtechnology and Instrumentation for Thermal and Electromagnetic Characterization
- ACOUSTICS

- TPIA: Transduction, Propagation and Acoustic Imaging
- MAMINA: Materials and Acoustics for Micro and NANO integrated systems
- BIOMEMS
- AIMAN-FILMS: Magneto-Nano-Electronics - Active structures, MEMS and flexible structures Ultrasonic thermography - Micro-Fluidics
- NANOBIOINTERFACES
- NAM6: The Micro and Nano Systems
- COMNUM: Digital Communications
- CSAM: Circuits systems and Application of Microwaves
- TELICE: Telecommunication, Interference and Electromagnetic Compatibility
- MICROELEC SI
- WIND group: Wide Bandgap Semiconductor devices

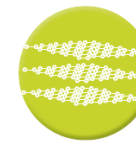

Topic 1

Millimeter-wave datacoms and photonics

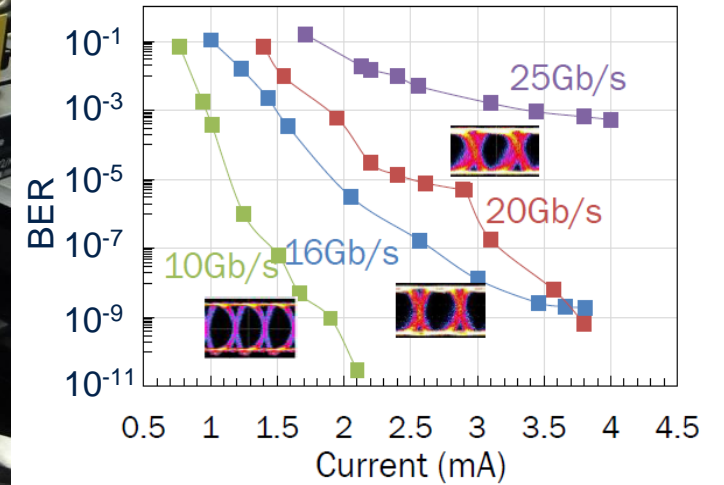
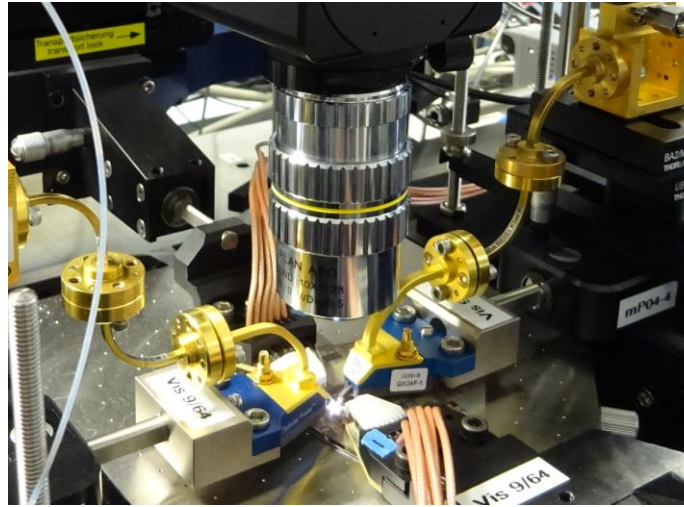

IEMN

G. Ducournau
N. Defrance
J.C. Dejaeger
K. Haddadi
F. Danneville

Y. Roelens
M. Zaknourne
E. Okada
S. Lépilliet

ST

D. Gloria
C. Belem
S. Bouvot
R. Debroucke
P. Chevalier
C. Durand
A. Yvon

F. Giancesello
O. Foissey
S. Jan
S. Cremer
J. Azevedo
E. Bouyssou

PhD/PDoc

D. Ovalle-Taylor
C. Mokhtari
M. Doublet
T. Bordignon
B. Badin
E. Brezza

Technology capability evaluation for RF&mmW: WHY?

- ST technologies targetable applications in the field of RF&mmW

Connectivity, 5G&6G Wireless Communications

- 5G Backhauling in D band
- 5G mmW modular Phase Array transceivers
- 6G transceivers systems D-J bands&bey. 100Gb/s
- IoT,

~GHZ-300GHz



Radar Sensing

- Broadband radar sensor
- THz imaging
- Medical
- Security
- ...

60 to 600GHz



Satellite Communications

- LEO apps
- In flight to Satellite
- Data center to Satellite
- SATCom
- ...

10 to 30GHz



➔ Need to develop, optimize and model technologies including packaging in

Small Signal
Noise up to THz
Power
Pattern Rad.

➔ Evaluate devices FOM and demonstrate their capabilities through elementary demonstrators included in system test platform with functionalized package

WHY and HOW in ST-IEMN Common Lab?

- Commercial characterization tools & methodologies limited to 110GHz

- Need to develop IN (BIST) and OFF Situ up to 1THz:

Noise Sources

RF sources

Tuners

Noise Receivers

Power Detectors

Smart MicroProbes

- Synergy between 2 IEMN competence centers: RF Lab & Technology: T1&T4

- **Characterization Bench Development up to THz IN /OFF situ**
 - S
 - Noise
 - Power
 - 3D radiation pattern
- **Smart THz MicroProbing**

- **Technology device evaluation to enable perf. Improvement**
 - Si Transistors
 - Wide Gap devices
 - Passives
- **Microstructuration enabling perf. detractor understanding and optimization**

- **Technology capability demonstration through elementary blocs in system test platform**
- **Integration with functionalized package**

Our Vision: All in situ first and in Micro Probe later up to THz

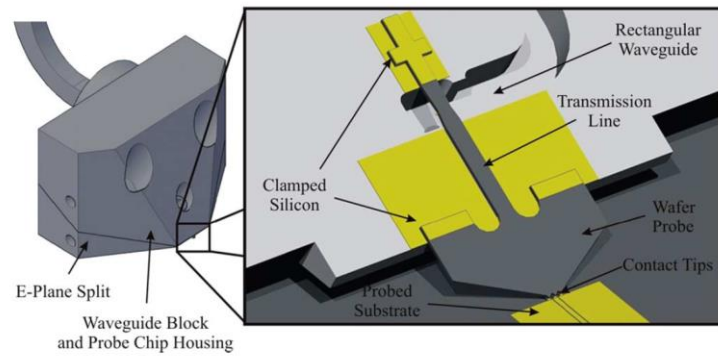
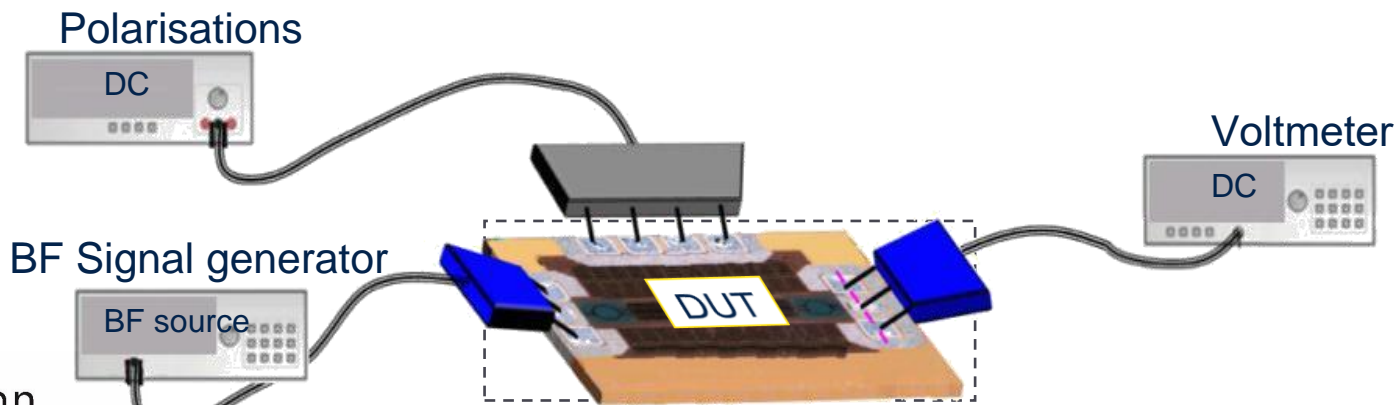
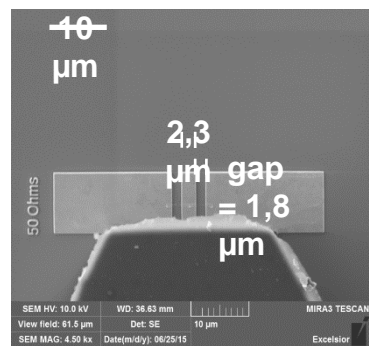
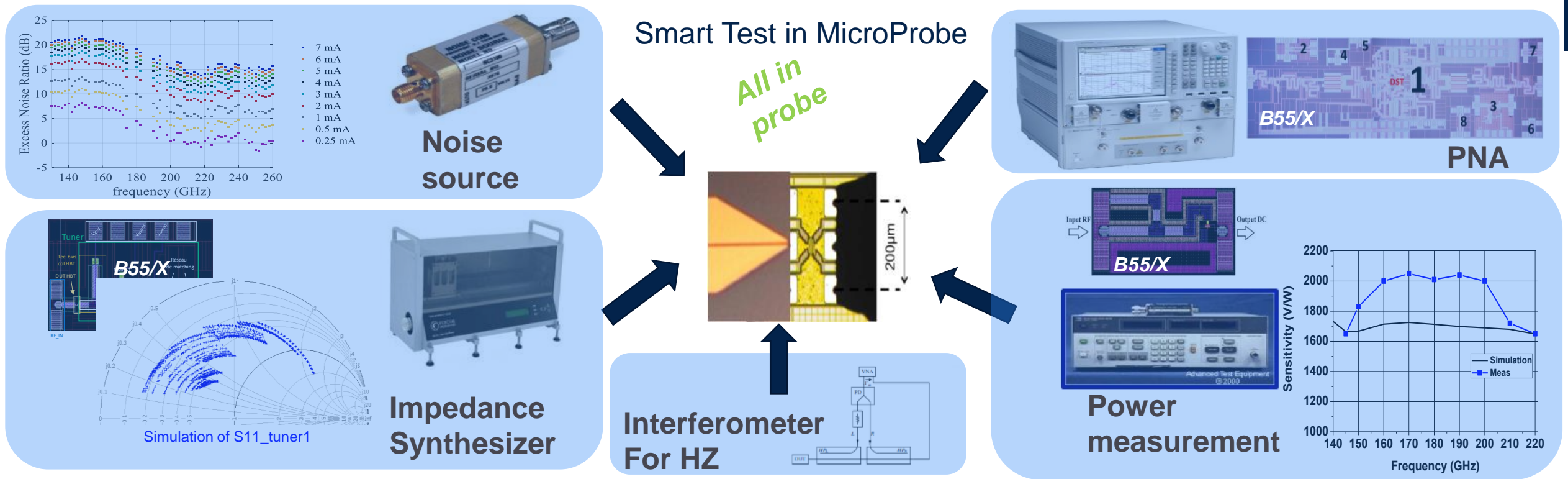

Characterization bench « in situ »

Our Vision: Building blocks validation at system-level

Enabling Beyond 5G/6G wireless core networks evolution:
We are going towards THz between antennas...

Frequencies > 250 GHz expected at horizon 2030

Key dates: 2017: new standard IEEE 802.15.3d (100 Gbit/s)
2019: discussions @ WRC 2019: frequencies 'allocated'

➔ 252-296 GHz / 318-356 GHz

=> Future markets: silicon-based technologies will enable mass developments

➔ Enabling technologies/chipsets towards 2025-2030 markets

Recent steps towards objectives

2020:
210 GHz LNA stage – 6 dB
qualified in 5 Gbps system

BiCMOS 55nm

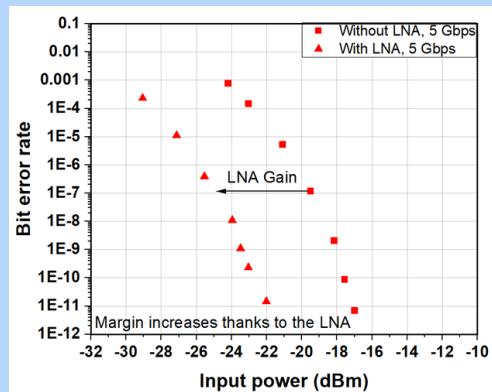
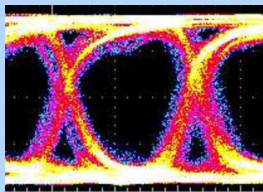

2020:
106 GHz Sub-Harmonic
Mixer 20 dB Conv losses

Up 40 Gbit/s qualified

BiCMOS 55nm /
Schottky diode based

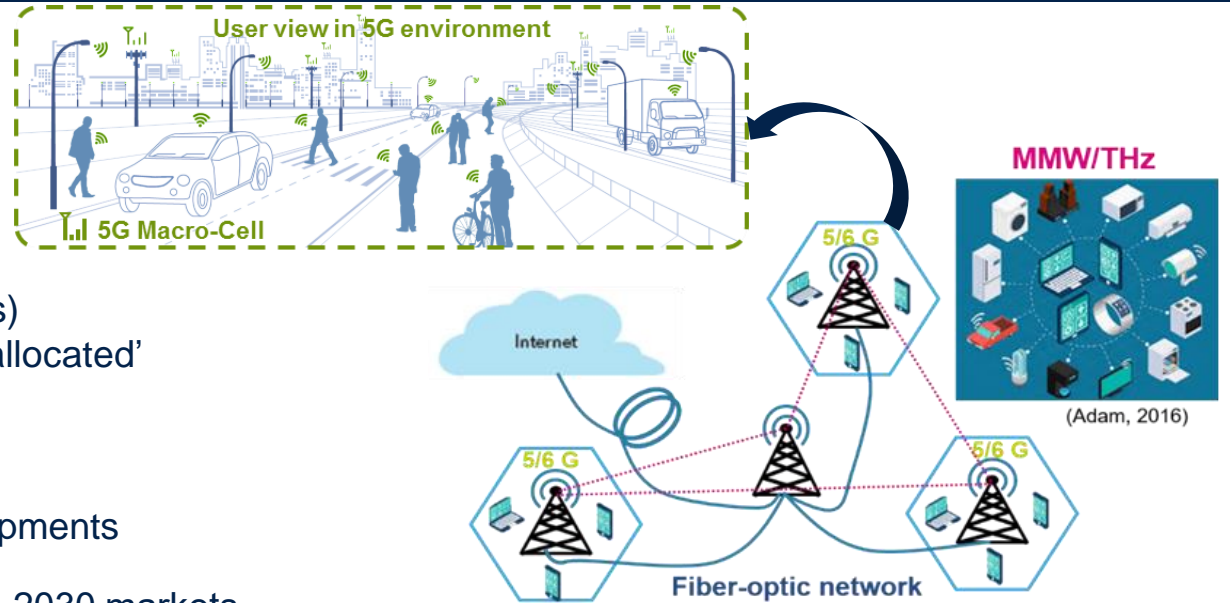
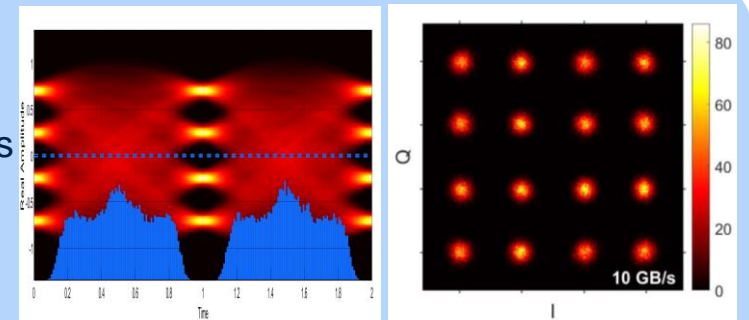

Where we are & Where we go

57 publications, 168 international communications, 18 conferences invitees, 14 priority patents, 32 PhD

➤ Leveraging on several recent key developments (2018-2022) + timeline for next 4-5 years

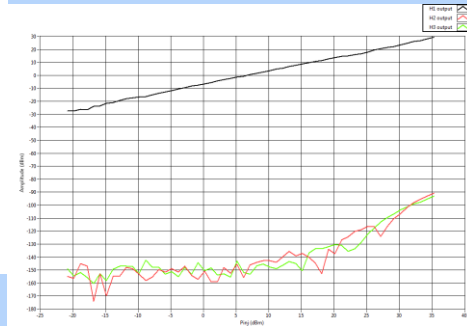
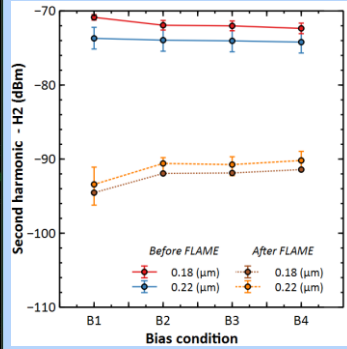
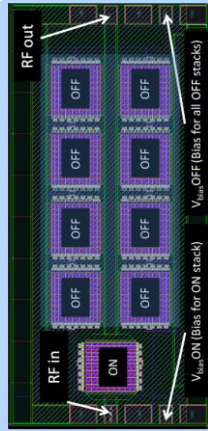

H9SOI SP9T fs laser milling and linearity characterization

- HR substrate
- H2 reduces by 22.7 dB
- H3 reduces by 5.6 dB

Ron/Coff, Hx Factor quality improvement

Microwave nanoprobes development for nano devices characterization

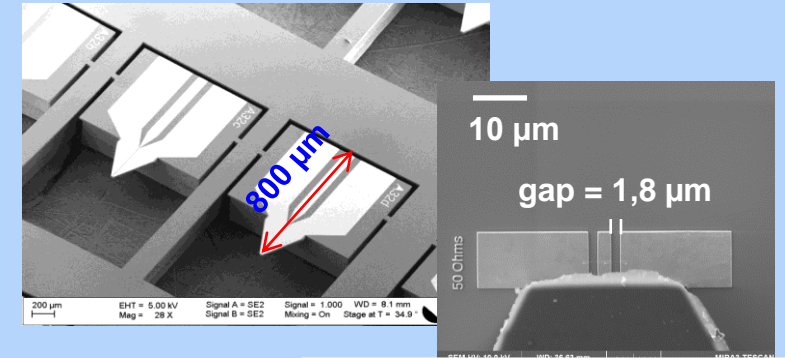

Large signal characterization

HBT device	G_p max. (dB)	PAE max. (%)	P_{OUT} @ 1 dB (dBm)	Power density (mW / μm^2)
BiCMOS055	5,10	22,2	8,2	16,1
IC standard	4,25	16,3	11,0	30,1
IC 5 crenels	4,80	22,2	11,0	30,1

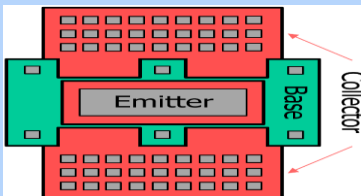

State-of-the-art power density HBT @ 94 GHz (BiCMOS 55 nm)

Up to 180 GHz silicon-based power characterization

Process evaluation

Increase F_t and F_{max} NPN B55X 9ML.

Complementary PNP development

Characterization of MOS/Diode & aF varactor (AdvCMOS/ BiCMOS)

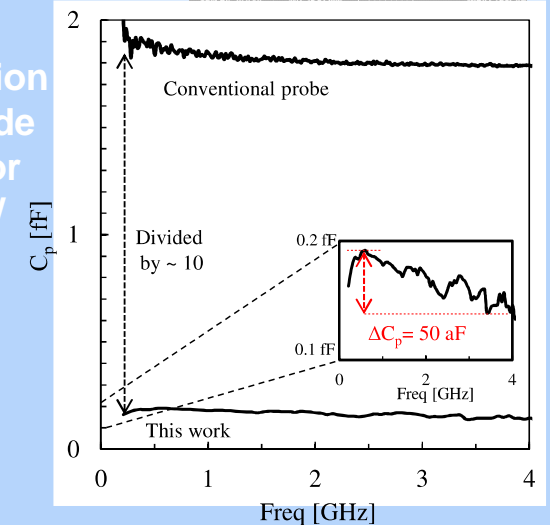

Up to THz range and circuits integration micro functionalized probes

Where we are & Where we go

➤ Leveraging on several recent key developments (2018-2022) + timeline for next 4-5 years

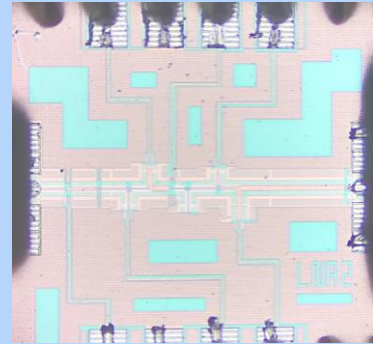
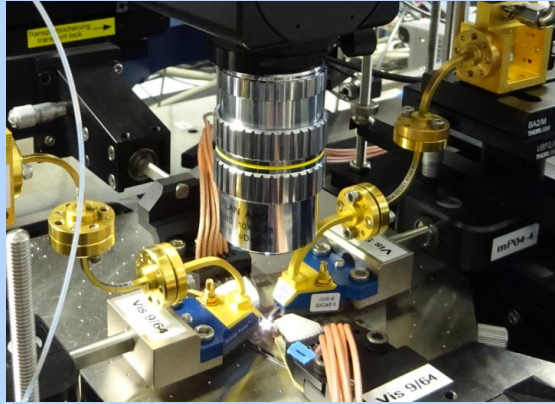

Integration of LNAs in 210 GHz communication 5 Gbps testbed

BiCMOS 55nm

Increase bandwidth/carrier frequency (IPCEI)

Antenna measurement testbed up to 330 GHz

2020:

650 GHz development

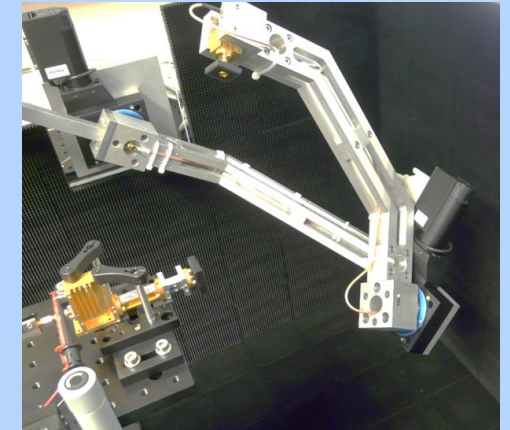

State-of-the-art Noise/IP3 measurements in the 300 GHz bands

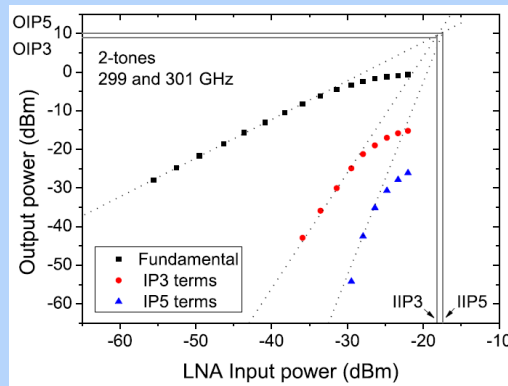
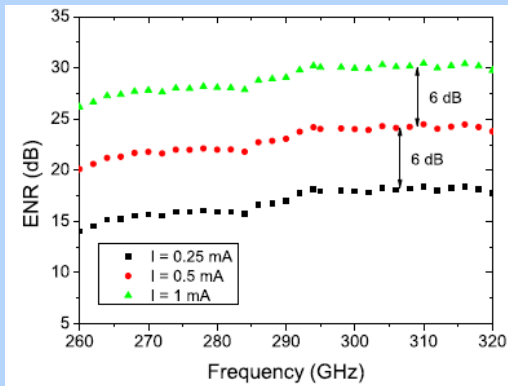

Up to 300 GHz silicon-based noise sources (BiCMOS 55 nm)

300 GHz band noise/power benches

Sustain and Increase > 350 GHz / Power/Noise benches

300 GHz measurement

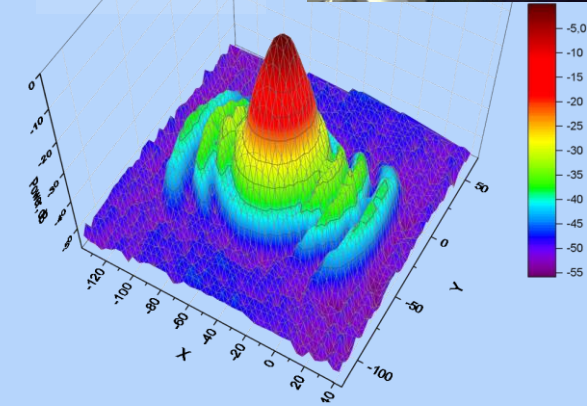

Up to THz range (Silicium based THz rectennas qualification)

T1-Scientific ecosystem

National level: PIAs

Equipex LEAF infrastructure



Laser procEssing pLATFORM
for multiFunctiOnal
packaging

Micro-nano
structuration

Functional packaging for
high-frequency & THz



Equipex Excelsior infrastructure



Nanoprobing / high Z

Very small size
measurement

THz characterization

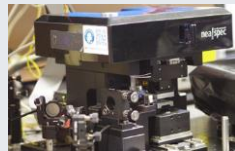
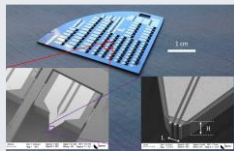

E.U. funded projects
(finished)

ECSEL TARANTO 2017 2021

TowARds Advanced bicmos
NanoTechnology platforms for
rf and thz applicatiOns

Follow-up: KDT 'SHIFT'

KDT-JU SHIFT 2023-2025



Sustainable technologies
enabling Future Telecom
applications



ST-IEMN
Common Lab



IPCEI-ME-CT 'Nano 2026'

- SP03: Development of charac bench for IR sensors
- SP04: Heterogeneous integration InP/Si
- SP05: Linear, NL charac and enabling functions using mm-wave technologies
- SP10: Methods for the characterization of ST's GaN devices

PEPR 5G & Electronics

PEPR 5G

Methods & characterizations for telecom-oriented beyond 5G / Atmospheric studies (propagation)

PEPR Electronics

- THz converters
- THz HBT (III-V, InPoSi)
- THz imaging

H2020 ICT THOR 2018-2022

System-level characterization @ THz

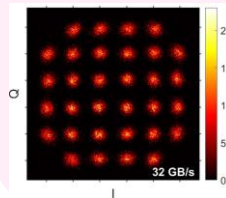

Outdoor demo:
300 GHz
645 m (July 22)

Euramet TEMMT 2019 2021

Metrology for high frequency S-parameters (up to 750 GHz), 1.1 THz (2021)

TERAOPTICS ITN Marie-Curie on THz science & technology

THz sensors measurements, metrology

New for 2023: PEPR (PIA4) / IPCEI-ME-CT/ KDT SHIFT



Topic 2

Communication systems and AI hardware

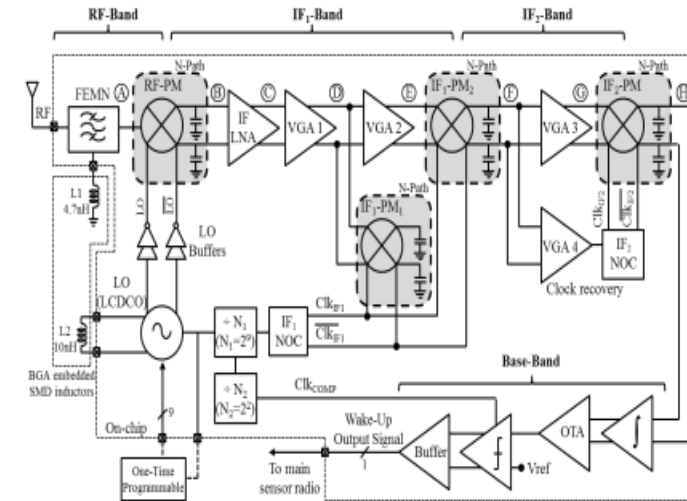
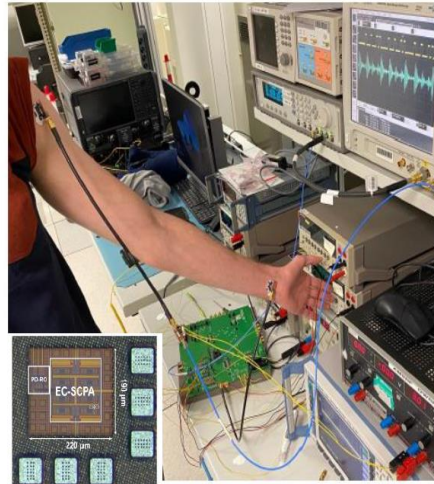

IEMN

A. Frappé
B. Larras
A. Kaiser
B. Stefanelli
L. Clavier

ST

A. Cathelin
D. Duperray
P. Cathelin
S. Nicolas
D. Perrin
F. Paillardet
S. Clerc

PhD/PDoc

J.B. Casanova
C. Beauquier
S. Richardson
S. Mourrane
J. Cornejo
K. Hérissé
J. Duforest
M. Chene
A. Gautier

Context and global objectives: WHY?

Integrated Communication Systems

- ULP TX/RX for On-Body Communications Chips
- High-speed TX for SatCom chip
- Ultra-low power ADC for STM32 Connectivity

Near-sensor computing / AI



Demonstrate FDSOI technology opportunities for real-life ultra-low power AIoT chips and systems

Real-life IoT demonstration platform

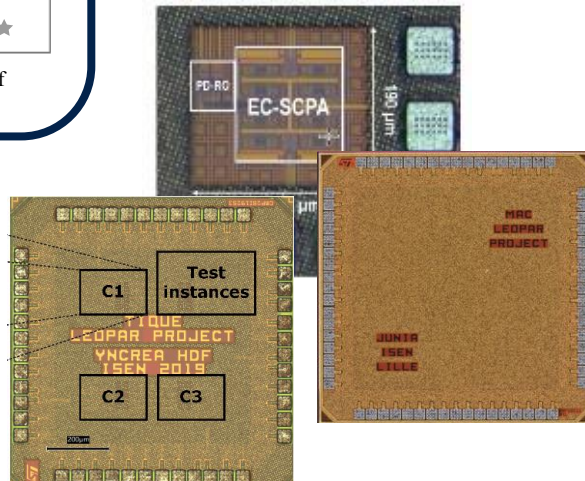
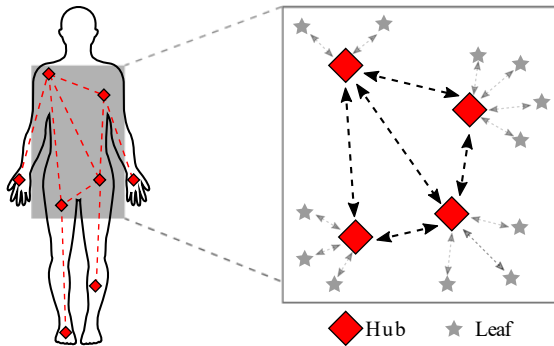

Communication systems and AI Hardware HOW?

Ultra-low power AIoT devices and systems and demonstration in 28nm and 18nm FDSOI

- Bringing system-level and circuit-level **unconventional design techniques** (examples: event-driven processing, mixed-signal processing, fully-digital RF architectures...)
- Leveraging **FDSOI technologies** through circuit design innovations
- From the concept to IC prototyping and demonstration

Illustration for On-Body Communications project

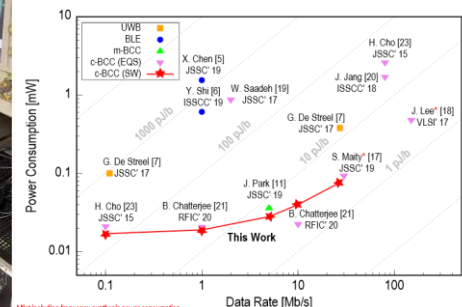
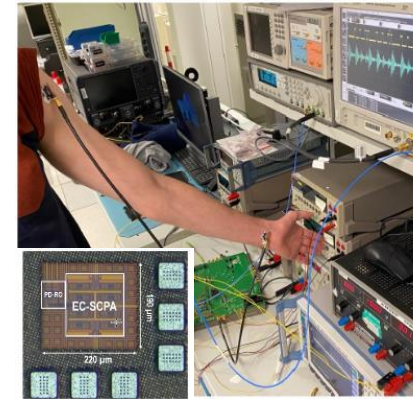
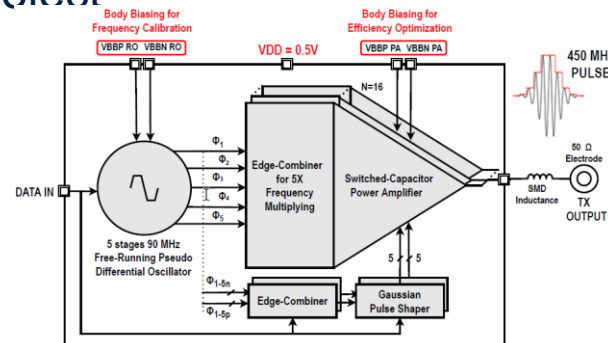
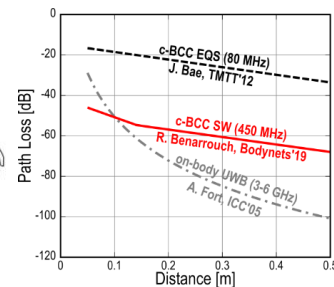
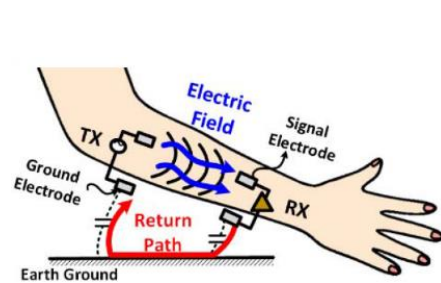

Idea/concept proposal → System-level validation → Circuit design → Chip fabrication → Test and measurements

Communication systems and AI Hardware - WHAT?

Integrated Communication Systems

On-Body ULP Communications

- Channel characterization for Capacitive Body Coupled Communications (IEEE std)

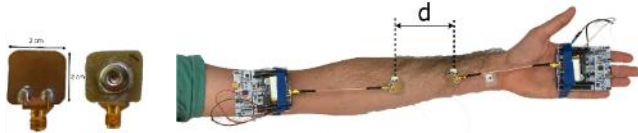

- Network MAC protocols based on heartbeat synchronization

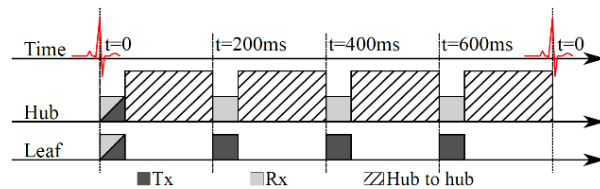

- Design of energy-efficient TX/RX for C-BCC in 28nm FDSOI

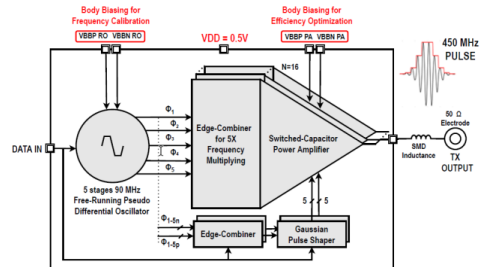
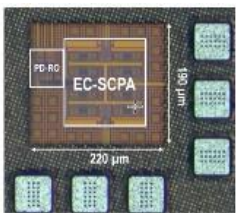

High-speed Digital TX

- Digital-RF 5G TX in 28nm FDSOI, MDG/RFC specs
- High-speed RF DACs / Switched-Capacitor PA / Digital delta-sigma modulation

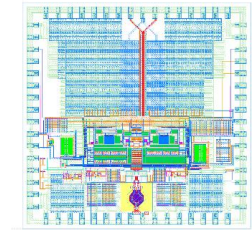

Low-power ADC

- Hybrid ADC architectures for ultra-low power receivers
- MCD/GPM/WBL specs

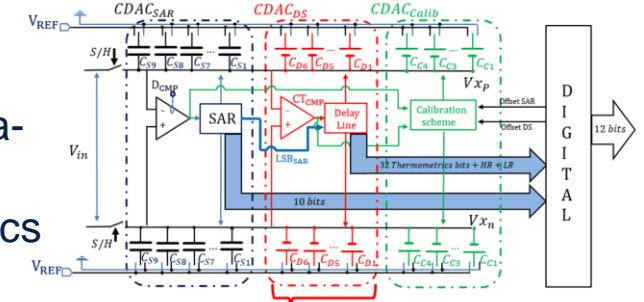

- Bidirectional Digital slope stage
- Conversion time and power consumption divided by 2

Communication systems and AI Hardware - WHAT?

Near-Sensor Computing / AI

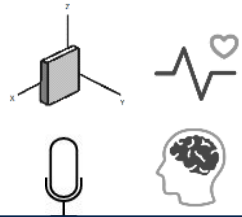

Event-driven
feature extraction

Mixed-signal
classification

Wake-up
signal



- Level-crossing ADCs
- Event-driven signal processing
 - CT FIR filters
 - CT delay elements
 - Energy extraction (audio spectrogram)
 - Slope extraction for ECG signals

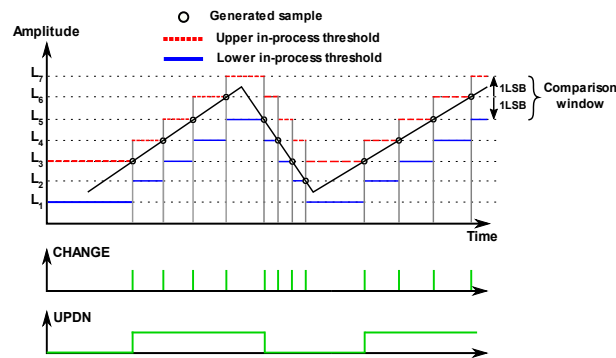

- Antidictionary-based classification
- ULP Compute-in-Memory
 - Mixed-signal current-based MVM
 - Log-quantized Digital CIM
 - In-memory learning
- Clique-based Neural Networks

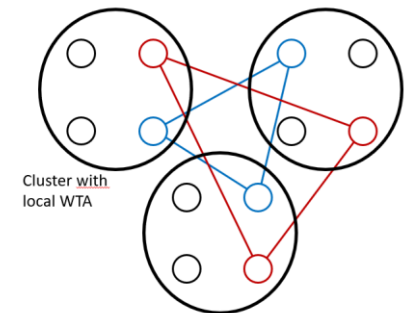
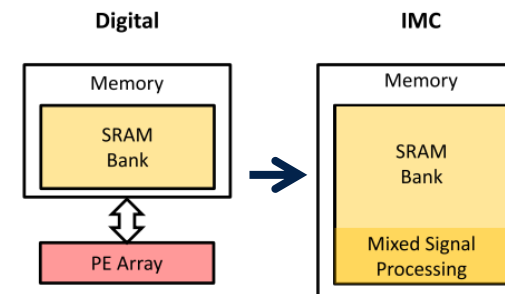

Applications: Keyword spotting, Arrhythmia classification, Sleep apnea detection, Movement detection

Integrated Communication Systems – Recent Achievements

Digital RF Transmitters

Digital RF Transmitter with switched-cap RF DAC and embedded Band Filter in 28nm FDSOI

- Lowest reported active area (circuit under pad integration)
- <10 mW front-end consumption (0dBm output power)
- Tunable for carrier freq <1GHz (ex: 900MHz LTE20)
- Best-in-class image rejection and LO feedthrough reduction via body-bias tuning

R.C. Marin (PhD ST - Région HDF)
TCAS-I 18 + T-MTT 19

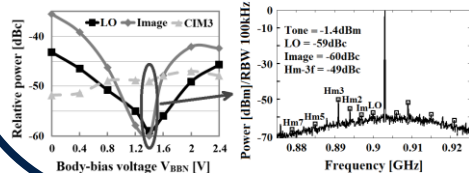
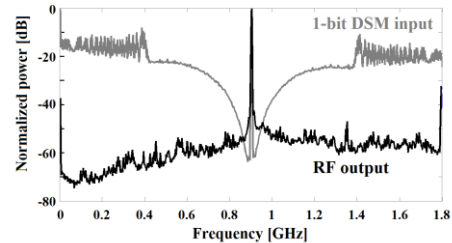
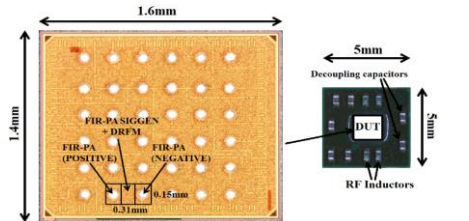
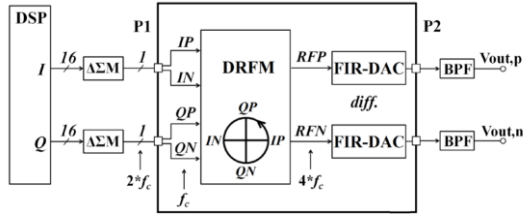

On-Body ULP Communications

28nm FDSOI Ultra-Low Power Transmitter for HBI Nodes

- Highly Duty-cycled transmitter with pulse-based communication
- Ultra-Low Voltage (0.5V) operation
- Flexible data rate (100kb/s to 27 Mb/s) with 17 to 80 μ W power consumption
- Body biasing for RO tuning and SCPA efficiency optimization

PhD G. Tochou (CIFRE ST)
RFIC 2021 Best Industrial Paper Award
T-CAS-I 2021 + JSSC 2022

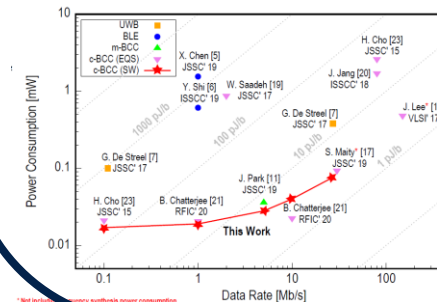
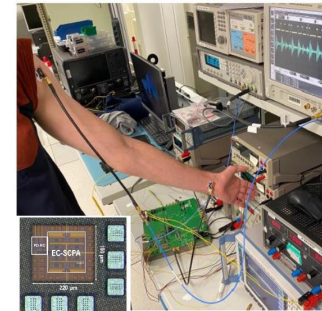
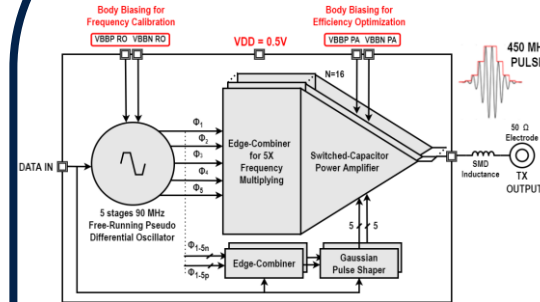

Theme 2 Scientific Production

24 Journals
112 Conferences

11 Invited
6 Book chapters

25 patents & 19 ext.
26 PhD defended

Near-sensor Computing / AI – Recent Achievements

Clique-based Networks

Clique-based Associative Memory in 28nm FDSOI

- 43pJ per inference (x6.5 improvement over SoA)
- Best memory density for associative memories (16kb memory within 27,600 μm^2)

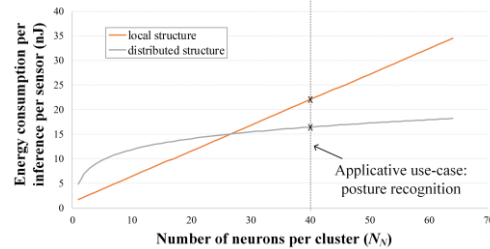
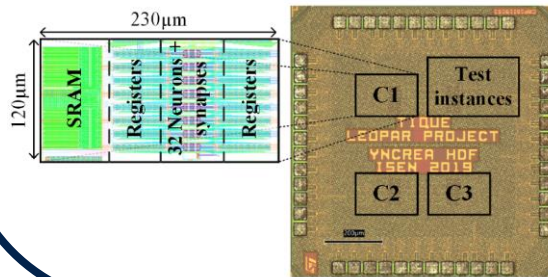
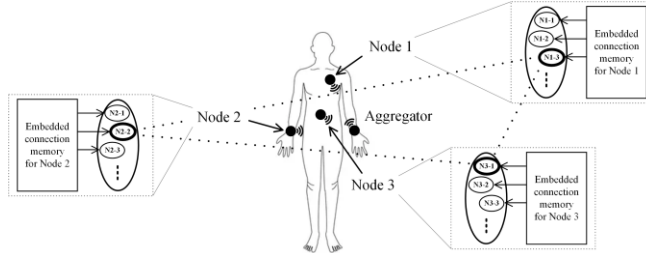
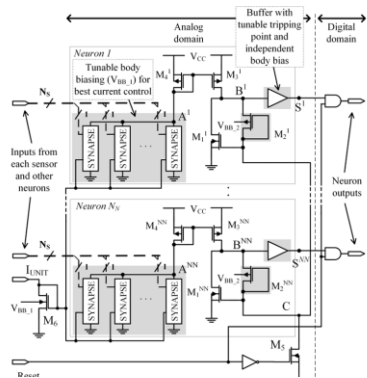

AICAS 2020 Best paper award
JETCAS 2020
ESSCIRC 2021

Event-driven feature extraction for audio applications

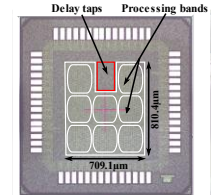
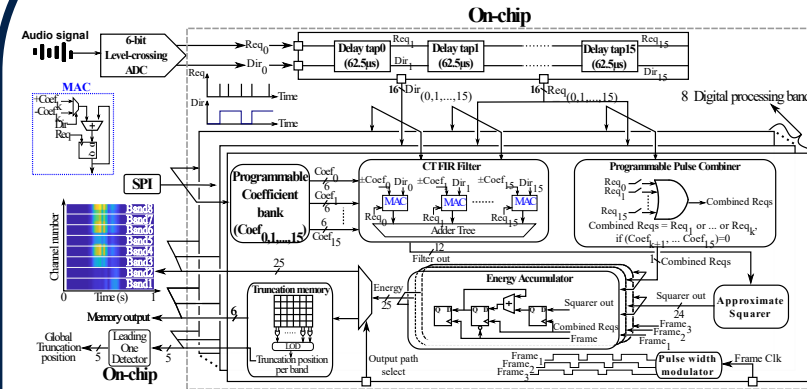

Mixed-signal 28nm FDSOI
Full custom analog delay taps
Semi-custom P&R flow for processing bands
400k logic gates (>6MTors)

Ultra-low power event-driven spectrogram extractor for keyword spotting:

- 291nW activity dependent power consumption.
- >90% recognition accuracy for 10keywords.
- Programmable device for different applications

AICAS 2021
NEWCAS 2023
Patent
ESSCIRC 2023
(Nominated for best paper award)

Feature	This work	JSSC'23 [2]	ISSCC'22 [3]	TCAS'21 [4]
Extractor type	Time-based CT FIR filters	Analog Filters	Ring-Oscillator based BPF	Switched-Capacitor filters
Technology	28nm FD-SOI	65nm	65nm	130nm
Supply voltage (V)	0.7 for Delays 0.61 for Digital	0.4	0.5 for Analog 0.75 for Digital	1.2
Area (mm²)	0.151 w/o Mem 0.57 w/ Mem	0.53	1.6	0.79
Scalability^a/Programmability	Yes/Yes	No/No	Yes/No	No/No
Event-Driven	Yes	No	No	No
Idle Power (nW)	270.7	—	—	—
Energy/keyword (nJ)	1.74	—	—	—
Total Power^b (nW)	291.6 ^c	80	9300	800
Frequency range (Hz)	840-6.25k	100-4k	111-10.4k	30-8k
Nb of channels	8	31	16	32
Feature rate (Hz)	100	100	62.5	100
#Classes(keywords)	11(10)	11(10)	12(10)	12(10)
Accuracy (%)	90.08	91.5	86.03	82.4-87.4 ^d
Classifier	Off-chip software CNN	Off-chip software CNN	On-chip RNN	Off-chip software RNN

^aScalability : Technology nodes scalable ^bTotal Power = Idle power + Speech rate x Energy/keyword
^cPower calculated for a speech rate of 12 keywords/minute, without including the truncation memory
^dConsidering 5-10% degradation from excluding the off-chip logarithm [3]

Theme 2 Scientific Production

24 Journals
112 Conferences

11 Invited
6 Book chapters

25 patents & 19 ext.
26 PhD defended

Ecosystem

On-Body ULP Comms Project
Collaboration with 



ST-IEMN
Pascal Ancey
Common Lab



ULP In-Memory Computing
Collaboration with 

High speed TX for SatCom
Collaboration with 

European Projects

National support

IPCEI-NANO2022 SP02
Event-driven neuro-inspired circuits



IPCEI-NANO2022 SP03
Large-scale IoT experimentation

IPCEI ME-CT 2026
Ultra-low-power distributed artificial intelligence
circuits for autonomous sensors

National projects



Low-Energy On-chip
Pre-processing for Activity
Recognition

Audio domain



Event Driven Artificial Intelligence
Hardware for Biomedical Sensors

Biomedical domain

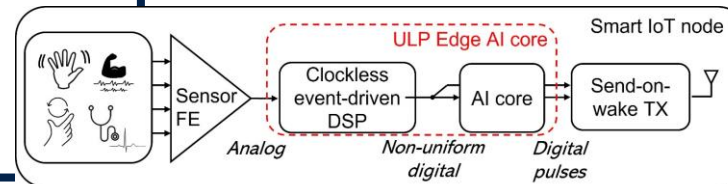

FE = front-end
DSP = Digital Signal Processing
AI = Artificial Intelligence
TX = Transmitter
ULP = Ultra-low power
IoT = Internet of Things



Perspectives

Integrated communication systems

- ➔ ultra-low-power Rx design for enabling the On-Body ULP Comms, collab with SRA
- ➔ Future digital 5G TX architectures (mMIMO, dMIMO)

COMMUNICATE

THINK

Near-sensor computing / AI

- ➔ Demonstration of event-driven concepts for audio, ECG and bioZ feature extraction
- ➔ Efficient on-chip mixed-signal AI engine (IMC, antidictionary, distributed NN)
- ➔ Complete integration of an edge-AI pre-processor

- ➔ Deployment of smart IoT nodes in the learning center
- ➔ Demonstration of intelligent wake-up (sensor and radio-based)

Real-life demonstration platform

Topic 3

Metrology using high frequency acoustics

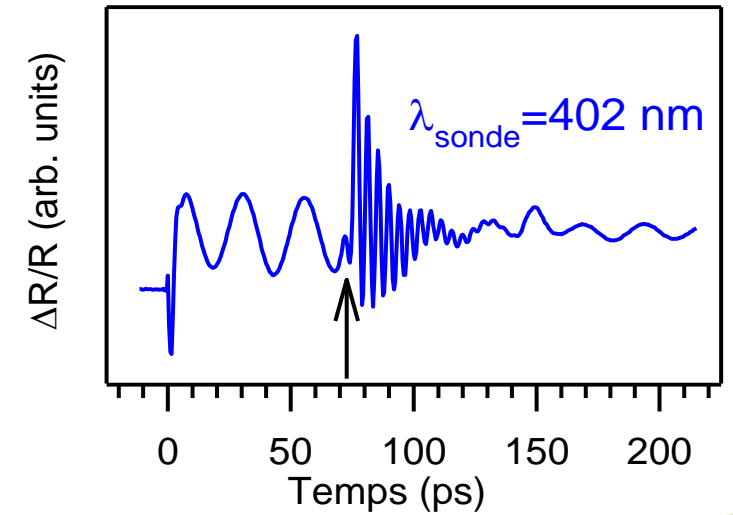
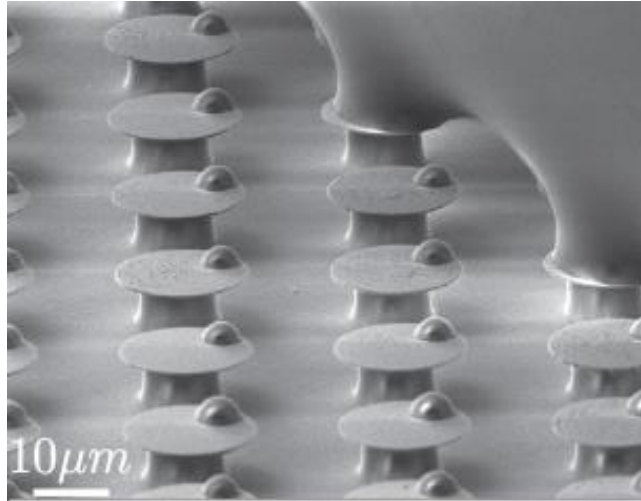

IEMN

A. Devos
J. Carlier
V. Thomy

ST

L. Broussous
D. Le Cunff
P. Garnier

PhD/PDoc

F. Chevreux
A. Chargui
A. Salhab

Context and global objectives: WHY

Thin Film Characterization

- Elastic properties more and more important
- New soft materials
- New applications with known materials

Interfaces / Defects

- Interfaces : Bonding / Adhesion / Delaminations
- Voids detection at t_0 or after thermal stress / humidity
- High Aspect ratio structures : wetting / filling / voids

New characterization techniques are needed

3D integration Wafer to wafer bonding

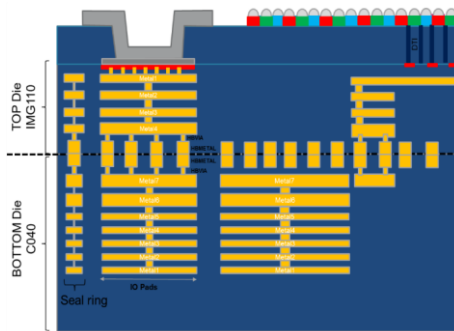

Deep Trench Isolation Wetting & drying

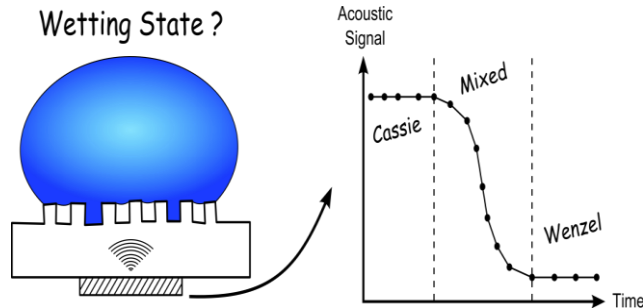

Imagers Micro-lenses covered by dielectrics

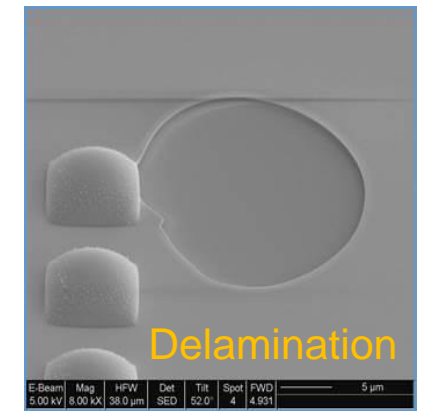
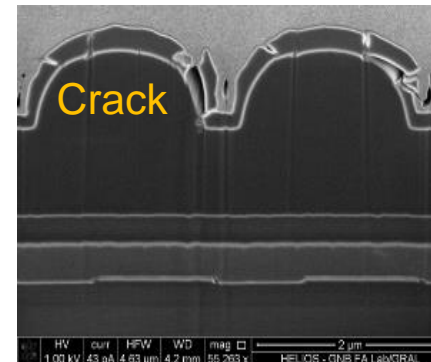

HOW ? Using high-frequency acoustic waves

High Frequency Acoustic waves provides high resolution for very thin films, small defects detection

High frequency Acoustic Reflectometry

- Thin-film piezoelectric transducer
- Analysis of reflected acoustic waves at top and bottom of the structure (at different delays)
- Reflection is affected by filling of high aspect ratio structures.

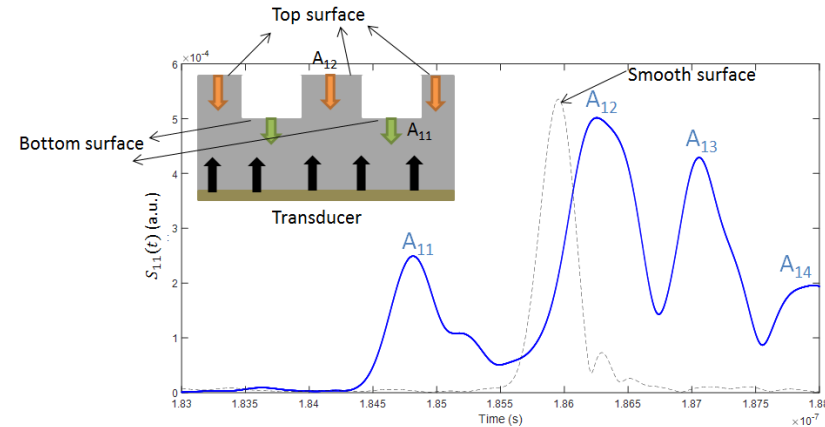

Colored Picosecond Acoustics

- Femtosecond laser to excite (pump) and detect (probe) short acoustic pulses in the wafer itself
- By tuning the laser-wavelength, we enrich the measured signal and multiply the applications.

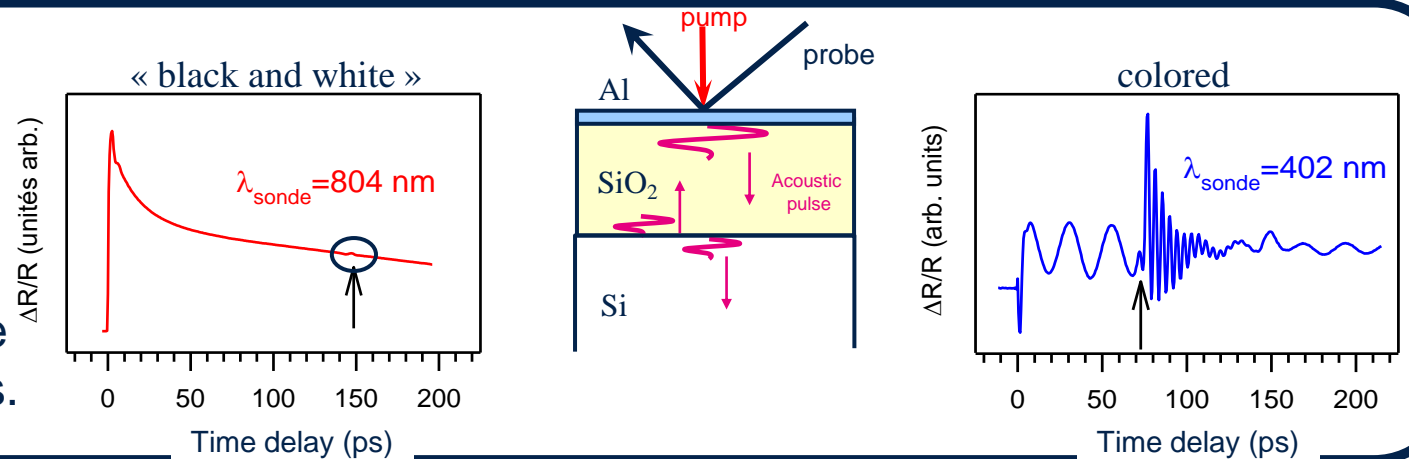

High frequency acoustic reflectometry - WHAT?

Thin-film ZnO transducer fabricated on the back of the wafer

Principle

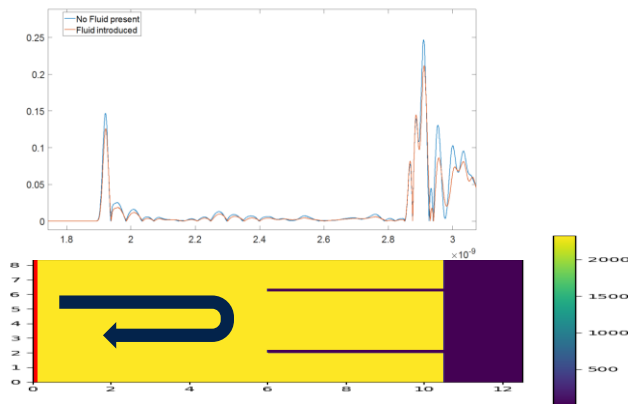
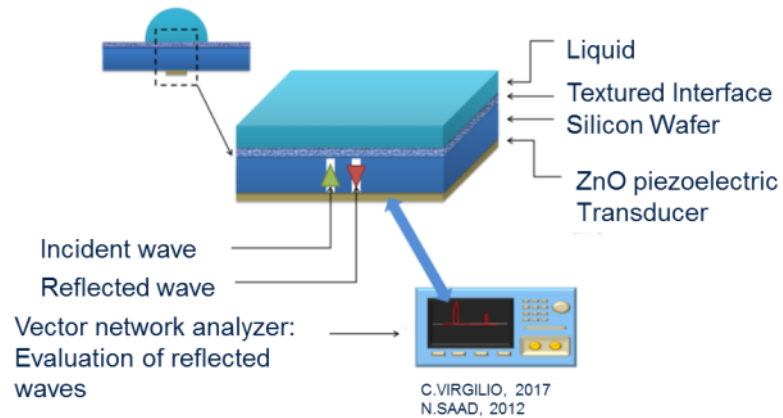

Measurement Bench

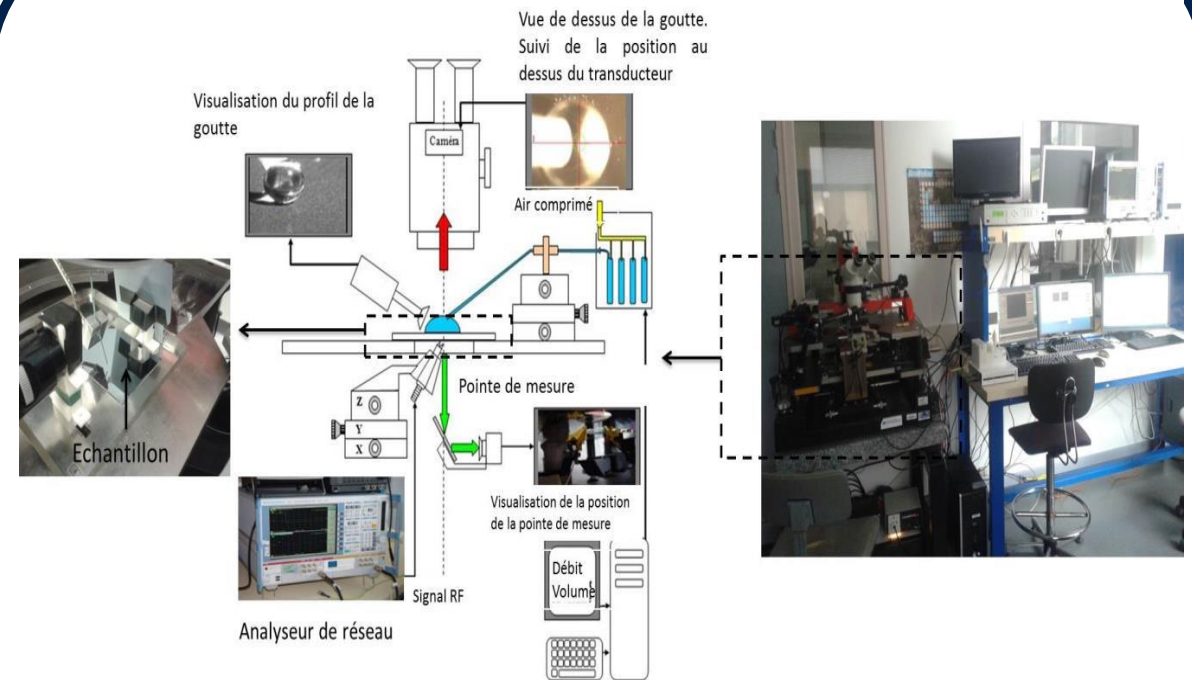

Colored Picosecond Acoustics - WHAT?

A femtosecond laser to excite and detect hypersonic waves

 **SONAR**

@Nanoscale

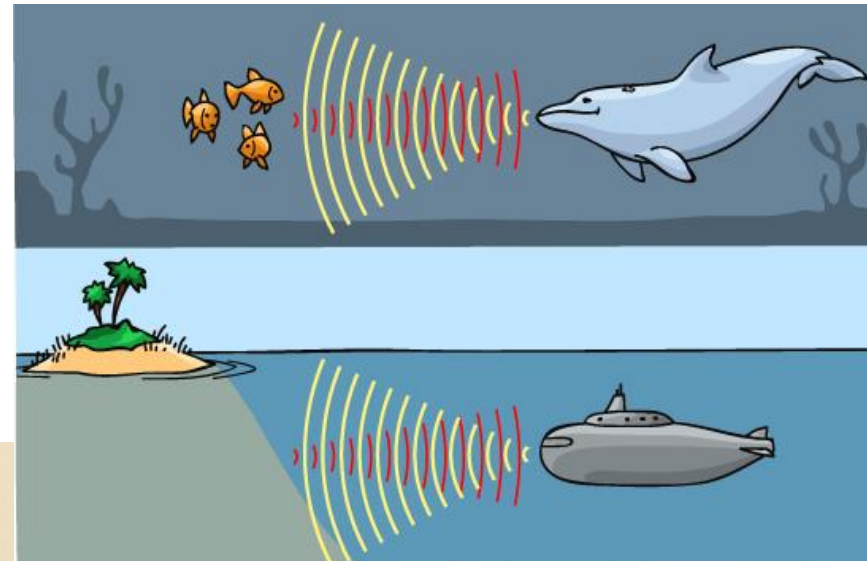

1000000X

Substrate

Thin film



Picosecond Acoustics

That « hypersonic » technique is perfect for thin-film thickness range from a few nm to a few μm

High freq. acoustic reflectometry – Past Achievements

Wetting in Micro-channel

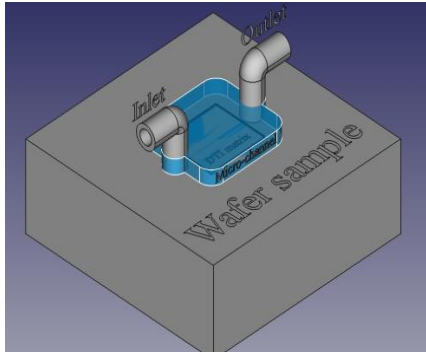

- Micro-channel to simulate industrial cleaning conditions
- Dimensions chosen according to the DTI matrix size: [40 – 80] μm in height and 3 mm² in length \times width

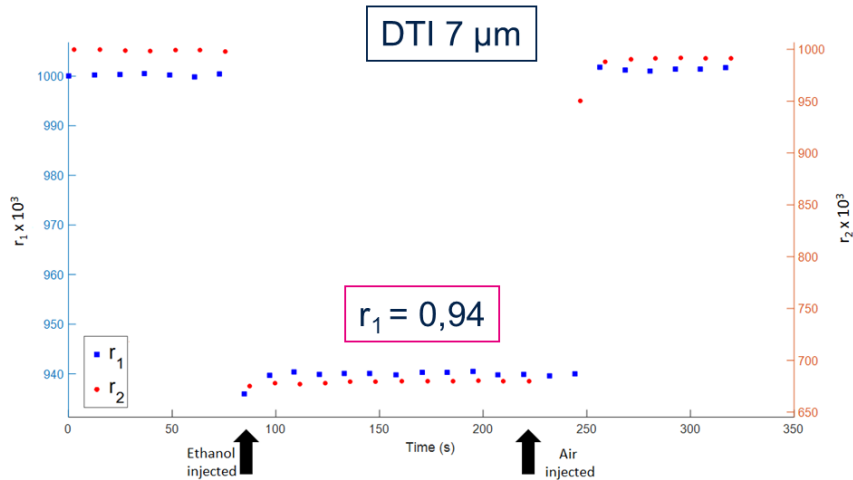

Partial wetting across the DTI samples

Polymer Wetting Characterization

- Use of NOA61 (Norland Optical Adhesive)
- NOA61 solidifies under UV radiation then the structure shape in the liquid state is preserved and can be observed using FIB & SEM
- Two DTI sample wafers, deposition of NOA61 droplets then
 - 1) Acoustic characterization
 - 2) UV lamp + FIB
- The % wetting of the NOA 61 corresponds well with the results obtained with the DI water / ethanol mixtures

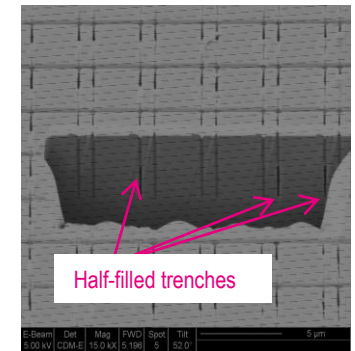
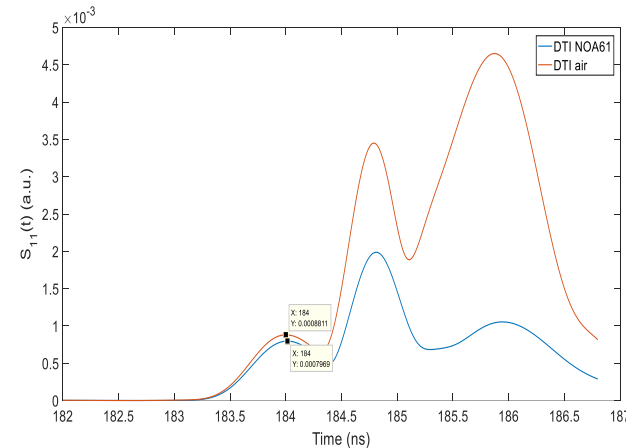

Heterogeneous filling of trenches with apparent wetting defects

Colored Picosecond Acoustics – Past Achievements

Wafer to wafer bonding

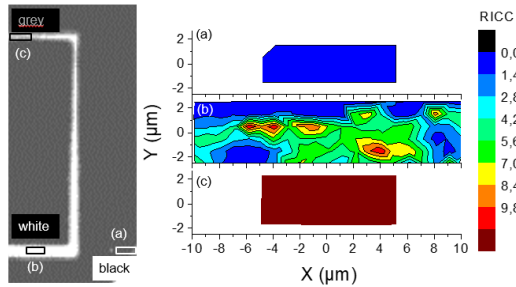

- Comparison between Scanning Acoustic Microscope (SAM) and Colored Picosecond Acoustics (APiC)
- Same acoustic waves but higher in frequency in APiC than SAM
- Adhesion fluctuations are detected along the copper line

S. Bossut (PhD CIFRE)

APiC as a high resolution Scanning Acoustic Microscope

Ultra-thin SiGe stressed layer

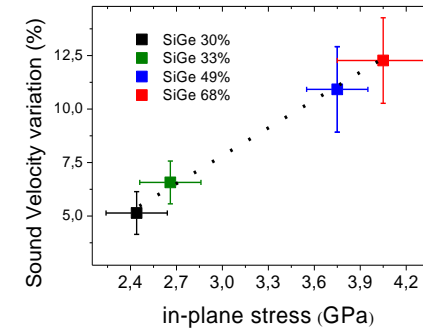

- Sound velocity is measured on SGOI wafers made of ultra-thin SiGe layers.
- According to the in-plane stress, sound velocity is found to deviate from the expected value.

A. Chargui (Postdoc)

A new application of APiC is demonstrated to measure in-plane stress

Dielectric/Resin interface for imagers

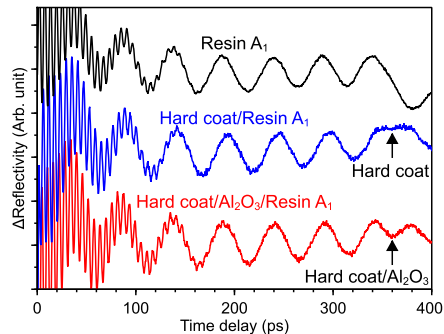

- Elasticity of Various thin-film resins used in imagers is measured using APiC
- The interface between top coat and resin is identified thanks to the time-resolved character of the measurement

F. Chevreux (PhD CIFRE)

Various dielectric/resin interfaces are investigated using APiC

Elasticity at Different Temperatures

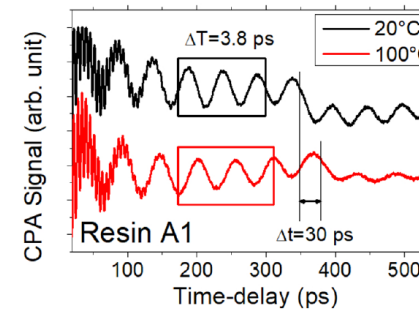

- As the sample is heated, both thickness and elasticity change.
- Both variations are extracted separately by combining Colored Picosecond Acoustics and Ellipsometry

F. Chevreux (PhD CIFRE)

Elasticity and thermal expansion of thin-film resins

Topic 4

Functional packaging and integrated thermics

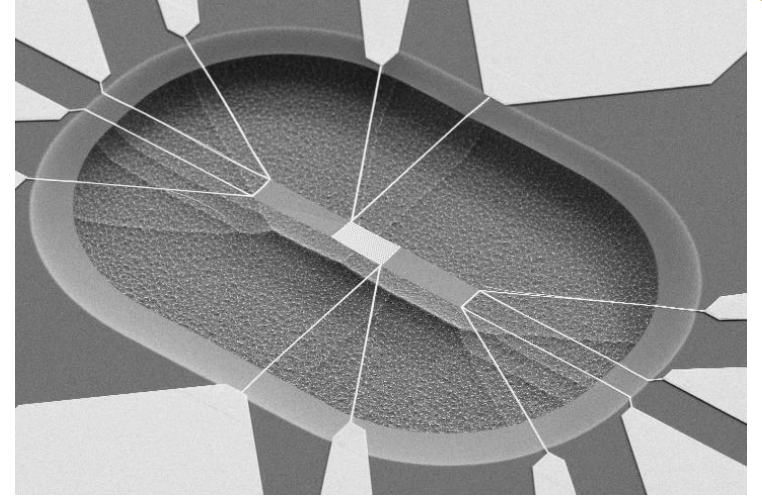
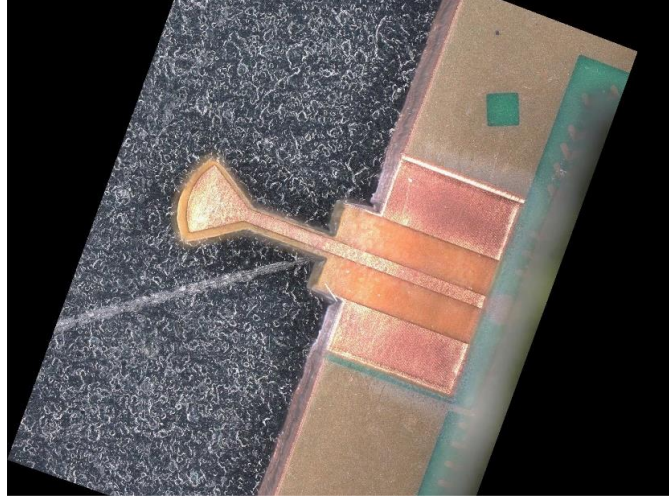

IEMN

J.-F. Robillard
E. Dubois
E. Blandre
J. Philippe
E. Okada
S. Lépilliet

ST

S. Monfray
A. Fleury
S. Jeannot
R. Simola
J. Sandrini
Y. LeFric

PhD/PDoc

J. Canosa
M. Brouillard
H. Ikzibane
A. Patil
V. Fiorese
M. Alawar
D. Gheysens
C. Mercier

Functional Packaging and Thermal Management HOW?

Electro-thermal analysis of complex functions (PCM, RF switch, mmW-THz functions-in-the-guide....)

- Metrology of electro-thermal systems (PCRam, RF Switch, Thermoelectric)
- Thermal management at Device/Component/System level

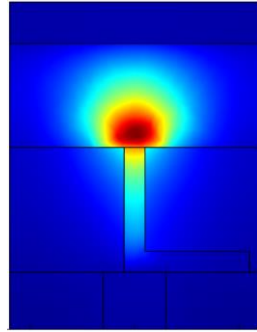

Modeling

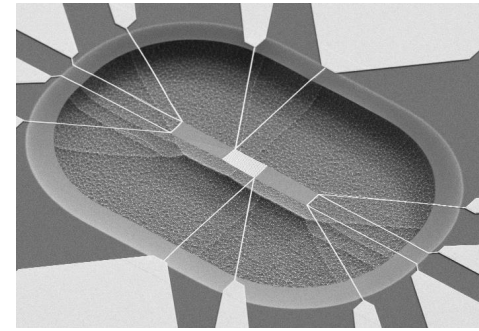

Fabrication of test structures

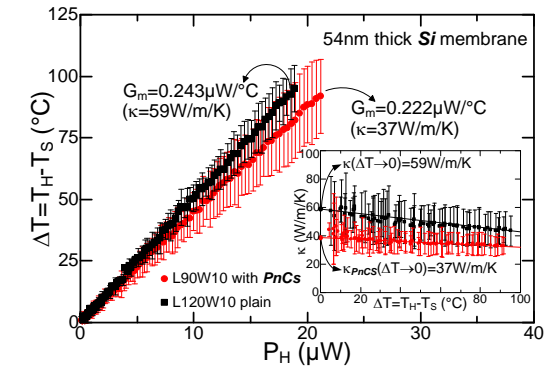

Thermal characterization

- Femtosecond laser-based μ -structuring to fill the 1 μm -1mm fabrication gap
- Enhancement of intrinsic performance, efficiency and reliability
- Thermal management at device/circuit/system level

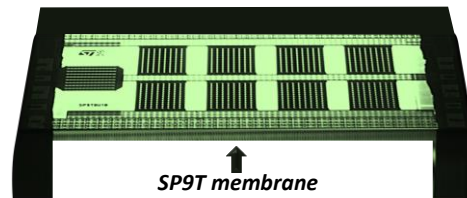

Microfabrication

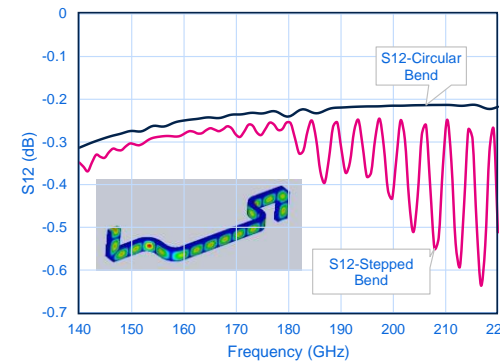

Design/modeling

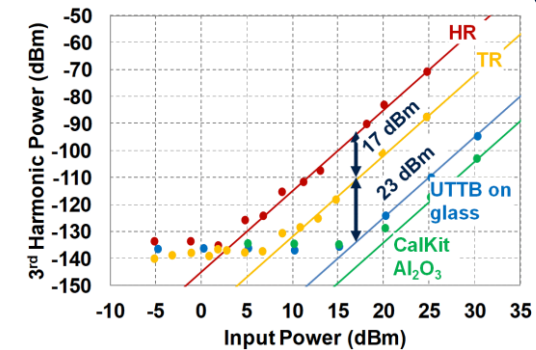

HF characterization

Functional Packaging VISION WHAT?

Bridge the 1 μ m-1mm fabrication gap using new process tools (laser)

Local substrate engineering

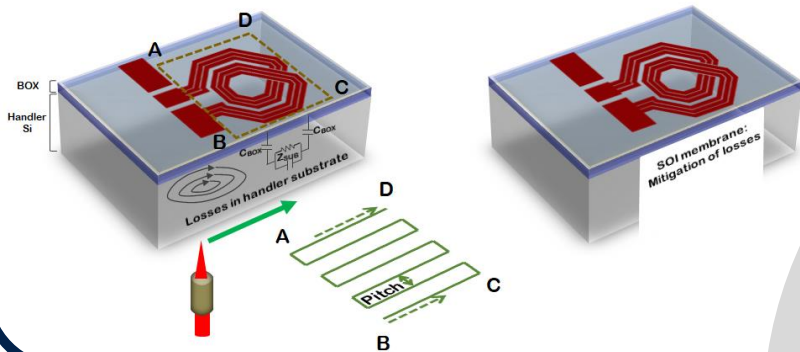

Femtosecond

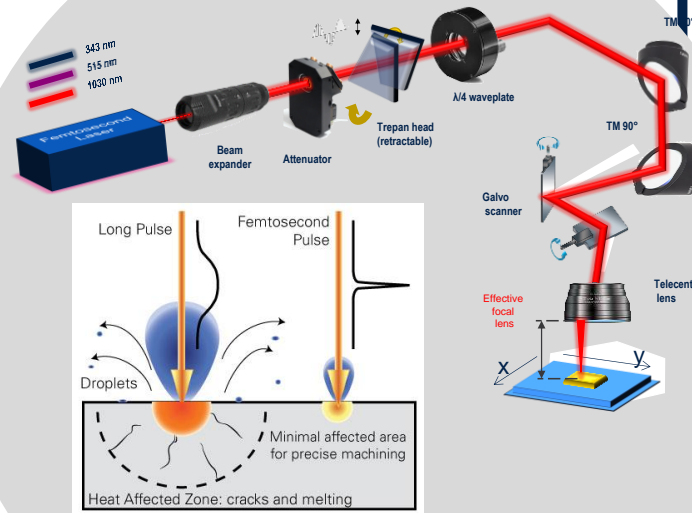

laser μ machining

RF device/circuit ultimate perf
(R_{on} - C_{off} , loss factor, linearity, power handling)

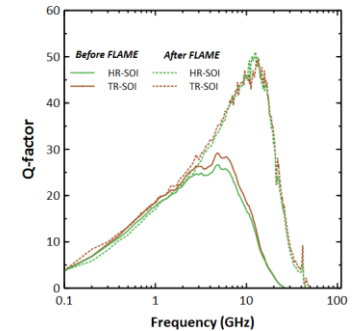
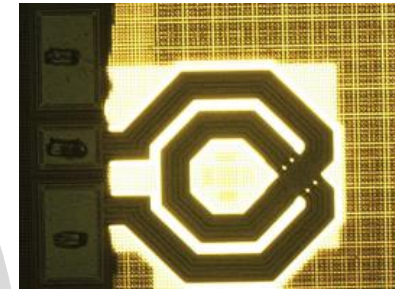

Embedded Si chips in compact mmW/THz waveguides

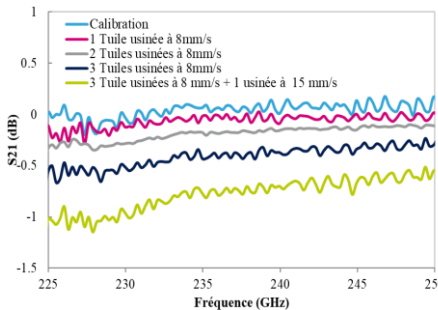
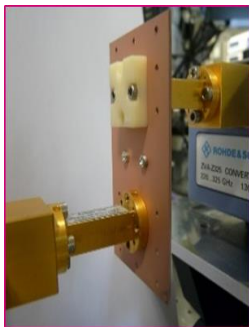

Smart Test-in-MicroProbe

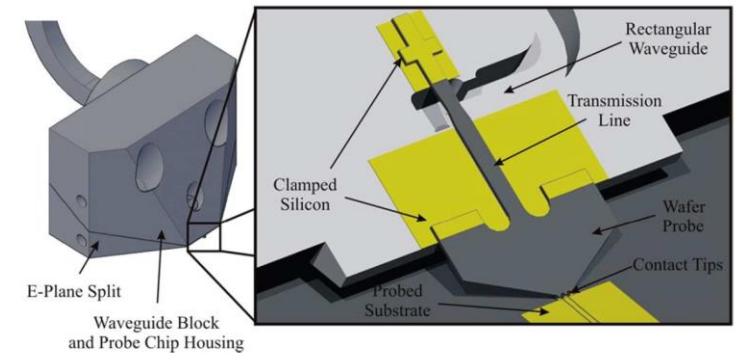

Shared Vision with Theme 1

Thermal Management VISION WHAT?

Converging techniques towards versatile and swift metrology

μ - Raman Thermometry

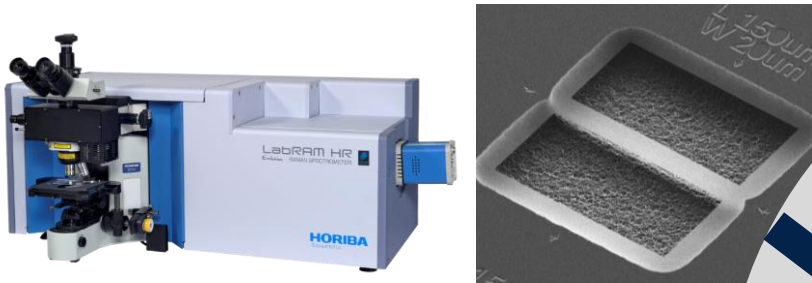

3-omega and electro-thermal

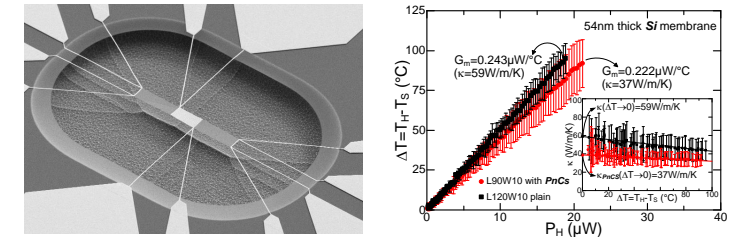

Scanning Thermal Microscopy

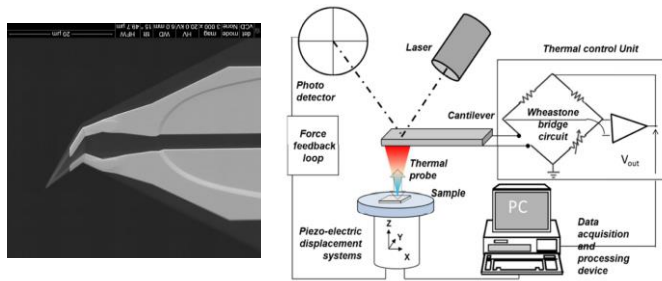

Built-In Thermal Test

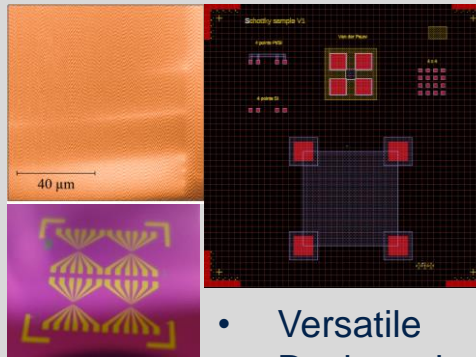

- Versatile
- Device-mimetic
- Quantitative

Structures

Time-Domain Thermo Reflectance

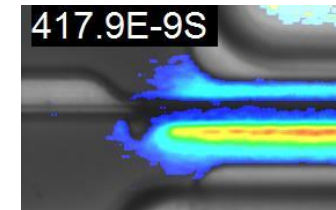

Functional Packaging – Past Achievements

Electro(-Optical) Interposer

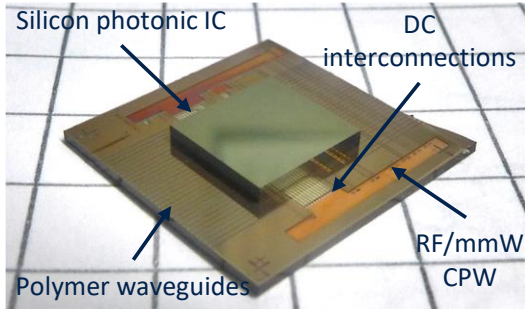

- Single mode polymer waveguides
- RF transmission lines
 - 50 Gb/s signals over a few millimeters
 - Insertion losses < 3 dB/mm at 75 GHz.
- Slanted mirror for optical signal redirection
- Demonstration of optical coupling with a flip-chip bonded PIC25G IC

J.M. Boucaud (PhD CIFRE), Q. Hivin (PhD Univ)

Electrical interposer for Si chip coupling to mmW/THz waveguide

Local Substrate Engineering

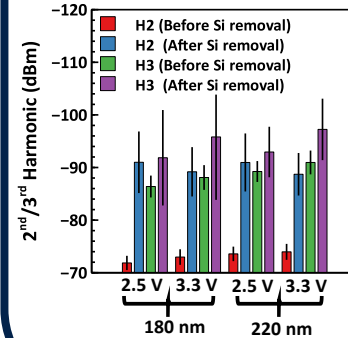

- Probe ultimate performance of devices/circuits by local, removal of substrate handler
- Applied to H9SOI technology
 - substrate coupling in test structures
 - RF switch: mitigation of non linear effects (harmonics)
 - Inductance: boost Q factor and decrease of loss factor
 - LNA: improvement of noise figure

A. Bhaskar (PhD CIFRE), J. Philippe (PhD Univ)

Application to 65 nm RF-PDSOI to boost R_{on} - C_{off} figure-of-merit

mmW Guide & Chip-to-Guide Transition

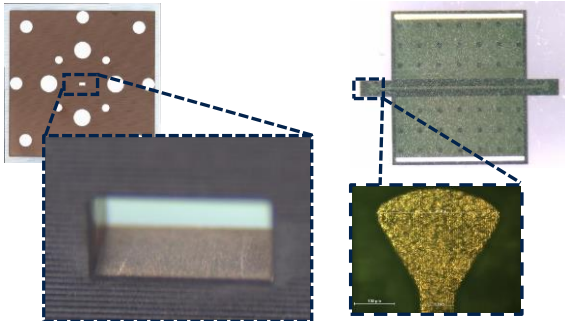

- Compact low loss guides
- Coupling mmW Si chips to rectangular waveguides
- Laser μ machining for low cost and fast prototyping

A. Alves (PDoc NANO2022)
C. Belem (PhD CIFRE)

Building blocks to assess Si tech. at system level and smart test-in- μ probe

Packaged Noise Source

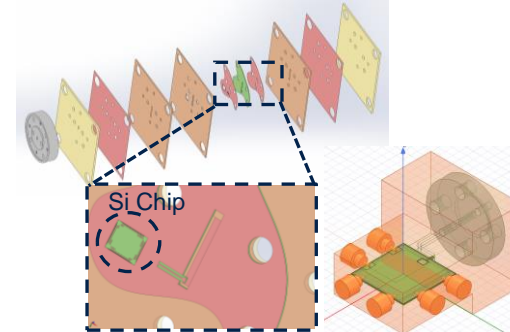

- Tools and methodology to characterize 500 GHz devices (B55): SS, noise, power
- Go beyond successfully developed in-situ measurement approach (BIST)
- Develop compact and loss-less source 'as close as possible to the tip' for on-wafer measurements

V. Fiorese (PhD CIFRE), M. Alawar (PhD NANO2022)

From test in-situ > smart test-in-flange > smart test-in- μ probe

Interdisciplinary with Theme 1



Theme 4 Scientific Production

42 Journals	11 Invited	15 patents & 38 ext.
88 Conferences	3 Book chapters	20 PhD defended

Interdisciplinary with Theme 1

Thermal Management – Past Achievements

Integrated Silicon Thermoelectrics

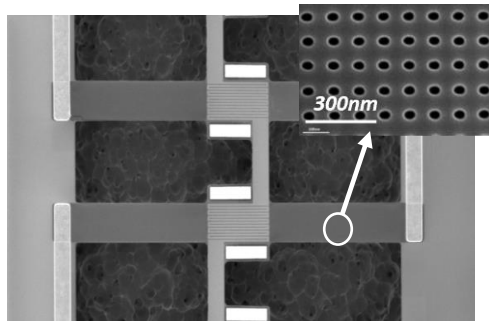

- Demonstration of crystalline silicon Thermoelectric generation
- Use of innovative Phonon Engineering methodology
- State-of-Art mW/cm²/K² results
- CMOS compatibility

T. M. Bah (PhD CIFRE)
V. Lacatena (PhD CIFRE)

Alternative thermoelectric materials for IoT

Thermal conductivity metrology

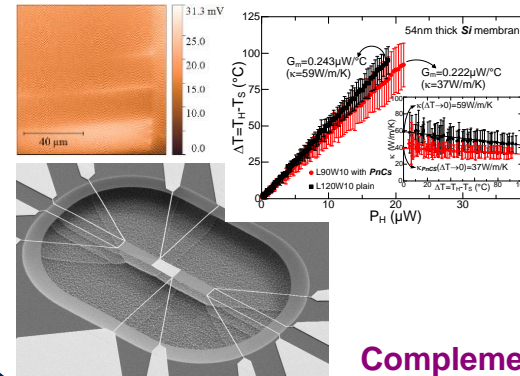

- Fabrication of thermal test structures
- Thermal conductivity measurement
- Raman thermometry
- Scanning Thermal μ scope
- Electro-thermal methods

M. Haras (PhD CIFRE)
J. Yin (PDoc TIPTOP)

Complementary techniques for characterization

Thermal Engineering

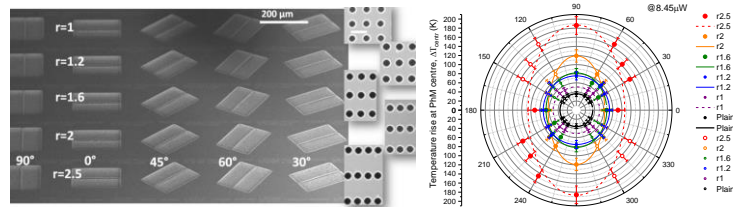

S. Didenko (PhD ERC)

- Direction-dependent thermal conductivity modulation
- Use of innovative Phonon Engineering methodology
- Raman μ Thermometry

Leveraging nanoscale effects for thermics

Thermal Management

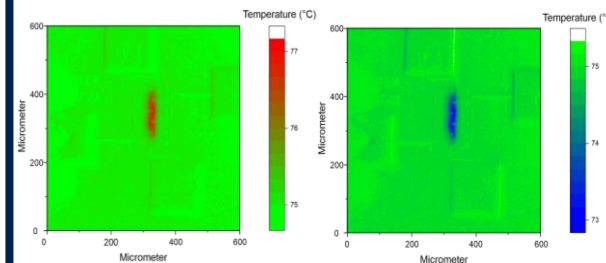

- Local Peltier cooling
- Local Joule heating
- Fully CMOS compatible
- Applications: Lidar (thermo-optics), SPAD (noise reduction), PCRam (efficiency enhancement), RF switches

Integrating cooling devices for performance enhancement

Theme 4 Scientific Production

42 Journals
88 Conferences

11 Invited
3 Book chapters

15 patents & 38 ext.
20 PhD defended

T4-Ecosystem

LEAF EQUIPEX infrastructure



*Laser procEssing pLatform
for multiFunctional
packaging*

Micro-nano structuration



Functional packaging for high-frequency & THz

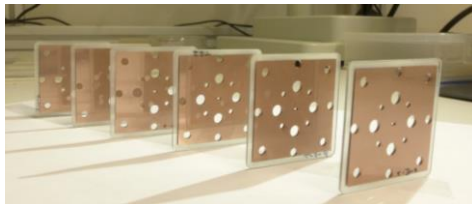

LEAF Project outcome

- 46 PhD/PDOC Users
- Support to 60 collaborative projects (ANR, H2020, DGE, ERC...)
- 30 academic partnerships
- 25 industrial partnerships
- > 600 micromachining operations
- > 100 journal/conf. publications



ERC UPTEG Project

*Unconventional Principles
of Thermoelectric Generation*

Leveraging results from:

- 3 PhD
- 2 PDoc
- 10 RICL
- 1 patent
- 22 oral com. (IEDM, SSDM...)



ST-IEMN
Pascal Ancy
Common Lab



Projects



- IPCEI-NANO2022
- 'Fonctional Packaging'
- IPCEI ME-CT 2026
- 'Fonctional Packaging mmW-THz'
- TIPTOP
- 'High sensitivity thermal probes'
- HANIBAL
- 'Heat transport in the quantum limit'
- EFFICACE Heat transfer at Si-Metal'

Networks

GDR NAME
'Nanomaterials for Energy'
49 Labs, 402 Researchers



RENATECH
μ/nano fab
network



IEMN Tech. facilities

- Short development loops
- Arbitrary sample/wafer size
- Wide range of materials

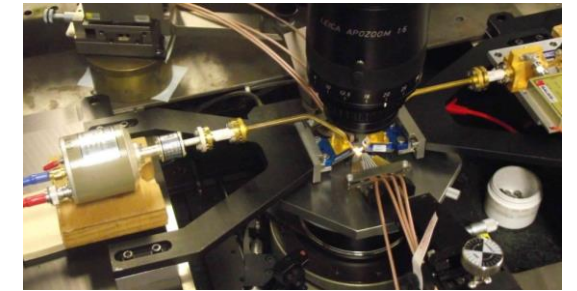

1400m² characterization facility



1600m² clean room facility

Topics NANO 2022 & IPCEI ME CT

NANO 2022			
Thème	Sous-Projet SP#	Titre SP	Lead
T1	SP01	Caractérisation de composants nanométriques à haute impédance jusqu'à 220 GHz dans le cadre de la plateforme Excelsior.	Gloria/Gaquièrre
T2	SP02	Circuits neuro-inspirés événementiels pour l'extraction de caractéristiques, l'apprentissage automatique et la classification de signaux audio / ExG / capteurs	Cathelin/Frappé
T2	SP03	Expérimentation IoT large échelle pour les smart cities	Cathelin/Clavier
T1	SP04	Caractérisation électrique, extraction de schémas électriques équivalents, limitation thermique, modélisation linéaire et non linéaire de composants GaN sur substrat Si	Bernier/Defrance
T3	SP05	Caractérisation acoustique du mouillage / séchage dans les structures à haut rapport d'aspect pour l'optimisation des procédés humides. Application aux imageurs CMOS et mémoires flash.	Broussous/Carlier
T3	SP06	Développement d'une technique de caractérisation d'interface non destructive basée sur l'Acoustique Picosecond Colorée (APIC)	Broussous/Devos
T4	SP07	Packaging fonctionnel en régime sub-mmW	Gloria/Dubois
T1	SP08	Développement de communications sans-fil en gamme sub-THz utilisant les technologies photonique sur Silicium	Gianesello/Ducournau
T1	SP09	Caractérisations en régime linéaires et non linéaires jusque 500 GHz : paramètres S, puissance et bruit (développement de synthèse d'impédances et de récepteur intégrés)	Gloria/Gaquièrre

IPCEI ME CT 2026			
Thème	Sous-Projet SP#	Titre SP	Lead
T2	SP02	Circuits d'intelligence artificielle distribués ultra-faible consommation pour capteurs autonomes	A. Cathelin / A. Frappé
T1	SP03	Développement d'un banc de mesure innovant dans l'infrarouge court afin d'accompagner le développement de capteur innovant en technologie Silicium	F. Gianesello / G. Ducournau
T2	SP04	Intégration hétérogène de transistors InP sur Si pour les applications télécom THz	P. Chevalier / M. Zaknune
T1	SP05	Caractérisation linéaire, non-linéaire, bruit, puissance de composants et réalisations de fonctions en technologies millimétriques avancées	D. Gloria / G. Ducournau
T3	SP07	Evaluation d'une technologie innovante de type Thin Film SAW afin de faire émerger une filière industrielle Européenne de filtre RF 5G	F. Gianesello / B. Dubus
T4	SP08	Packaging fonctionnel avancé en gamme RF et mmW	D. Gloria / E. Dubois
T1	SP10	Développement de méthodes innovantes pour valider les composants GaN de ST	B. Debusne / N. Defrance
T4	SP04	Ingénierie et métrologie thermique des mémoires non-volatiles (e-NVM) à changement de phase (PCM)	R. Simola / J.F. Robillard
T4	SP06	Commutateurs RF MOS-SOI à Microcavités et PCM pour applications 5G et au-delà	A. Fleury / S. Monfray / E. Dubois / J.F. Robillard
T2	SP09	Récepteur de veille pour connectivité IoT - Wake-Up Radio	A. Cathelin / A. Kaiser
T3	SP11	Méthodes de caractérisation acoustique pour l'optimisation des interfaces visant à améliorer le rendement de production de capteurs	P. Garnier / J. Carlier

T1
T2
T3
T4
OUT



life.augmented

Laboratoire Commun ST-IEMN 20 ans



- IEMN en bref
- Les 4 thèmes du LabCom (Réalisations, Visions)
 - T1: Millimeter-wave datacoms and photonics
 - T2: Communication systems and AI hardware
 - T3: Metrology using high frequency acoustics
 - T4: Functional packaging and integrated thermics
 - Les sujets de l'IPCEI ME-CT
- Ecosystème du LabCom
 - Projets Collaboratifs
 - Production Scientifique et Brevets
 - Doctorants



30 Collaborative projects

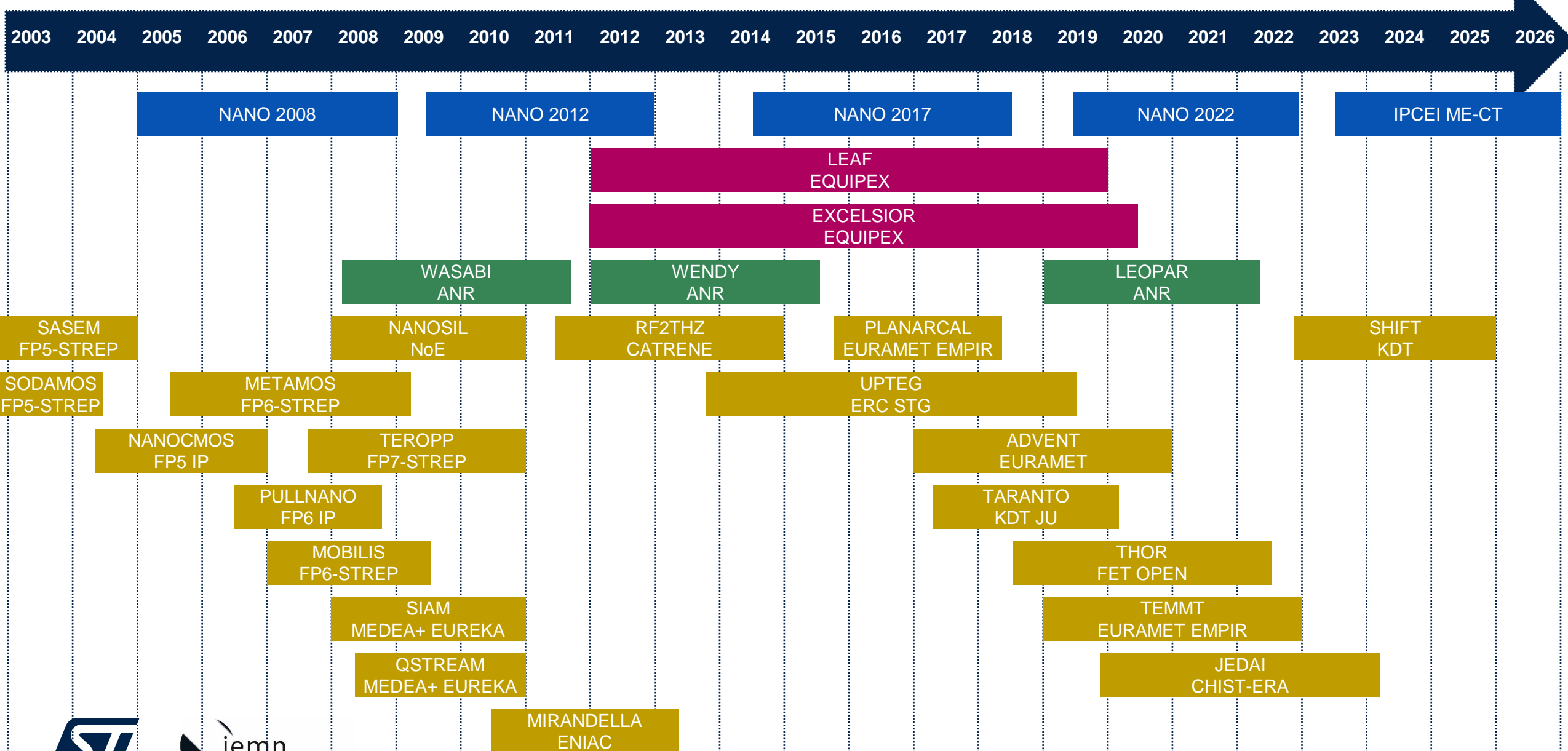

Production

Jan 2003 - Dec 2022 (936 produits de publication)

- 155 journaux
- 494 conférences (incl. invitées) } 649

T1: Millimeter-wave datacoms and photonics
 T2: AI hardware and communication systems
 T3: Metrology using high frequency acoustics
 T4: Functional packaging and integrated thermics

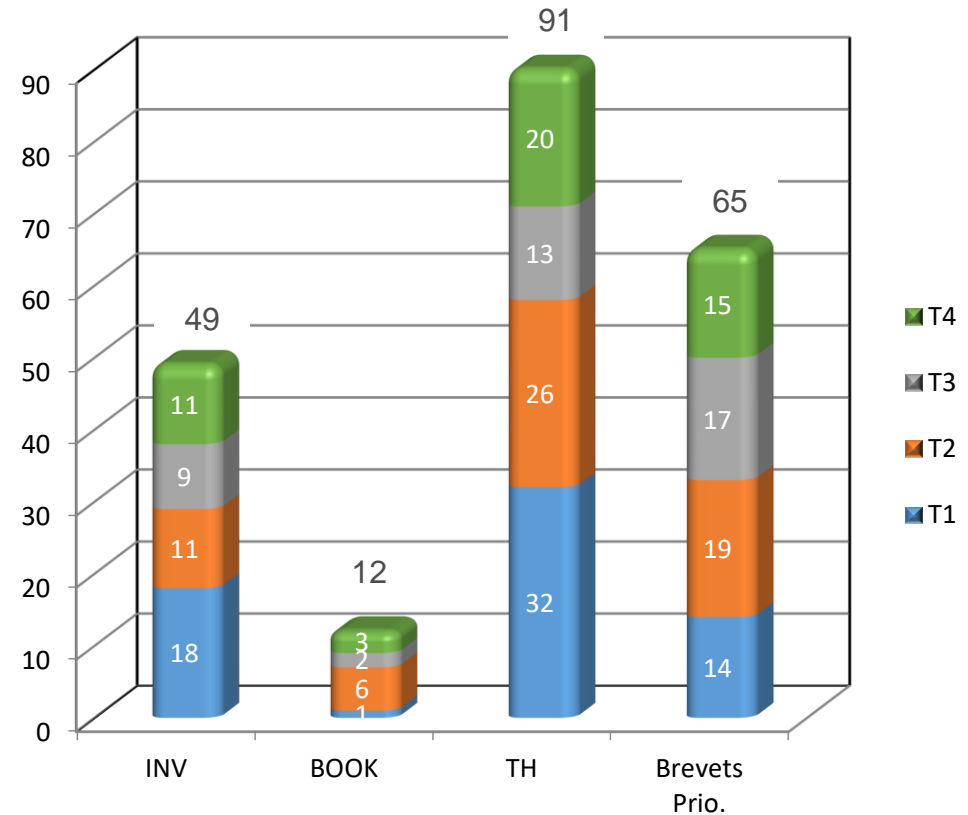
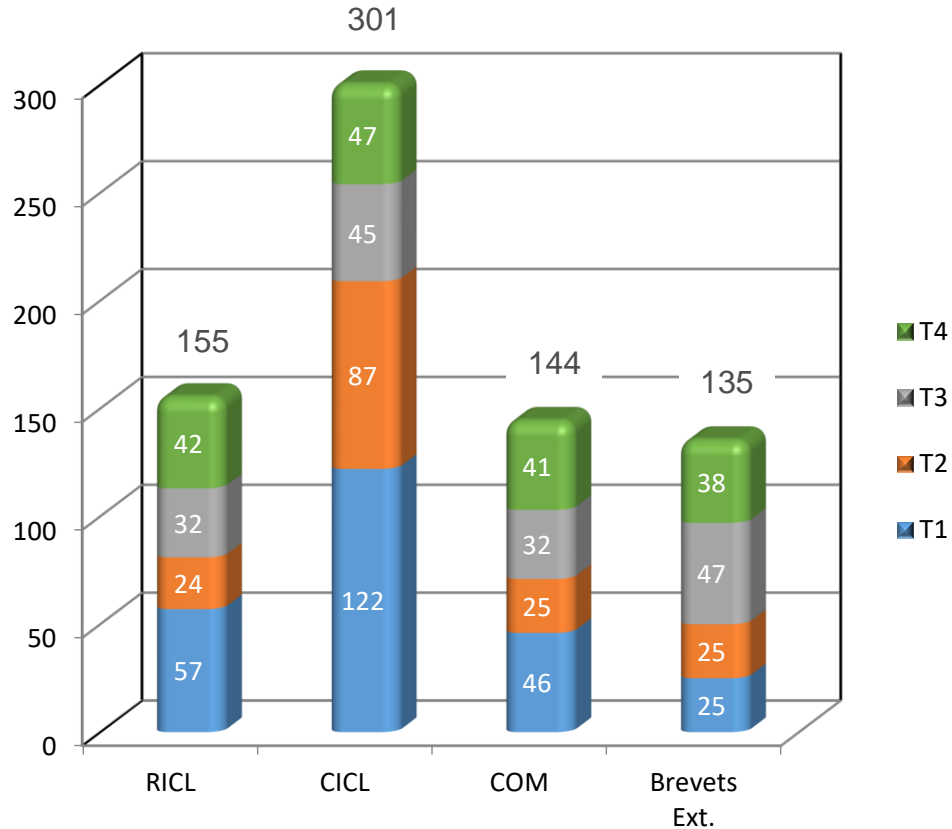

RICL= Articles dans une revue internationale à comité de lecture
 CICL= Communications internationales avec actes
 COM= Communications internationales sans actes
 Brevets Ext.= Extensions internationales brevets

INV= Conférences invitées
 BOOK= Direction ou chapitres d'ouvrages
 TH= Thèses soutenues
 Brevets Prio.= Brevets prioritaires

Bilan Thèses

Thèses	ALL	T1	T2	T3	T4
Soutenues	91	32	26	13	20
En cours	18	6	5	1	6
Total (sout. / en cours)	109	38	31	14	26
CIFRE / Total	67	25	18	9	15
CIFRE / Total (%)	62%	65.8%	58.1%	69.2%	57.7%
Poursuite carrière ST	24	11	7	1	5
Poursuite carrière aca.	10	3	2	1	4

Carrière des doctorants (1/2)

Thème	Nom	Prénom	Date Soutenance	Carrière post-Thèse
T1	VANMACKELBERG	Matthieu	oct.-01	MMJ Services
T1	SILIGARIS	Alexandre	déc.-04	CEA
T1	PAVAGEAU	Christophe	déc.-05	INCIZE
T1	PAILLONCY	Guillaume	nov.-05	National Instruments
T1	PRUVOST	Sébastien	nov.-05	ST
T1	BOUHANA	Emmanuel	oct.-07	Patent Examiner, European Commission
T1	MARTINEAU	Baudouin	mai-08	CEA-LETI
T1	VALENTIN	Raphaël	déc.-08	XYTECH Consulting
T1	MORANDINI	Yvan	oct.-08	ST
T1	GEYNET	Baudouin	déc.-08	-
T1	WALDHOFF	Nicolas	déc.-10	MCF EIL Cote d'Opale
T1	TAGRO	Yohann	avr.-10	IC Design, Los Angeles
T1	FOURNIER	David	juin-10	ATOS
T1	POTTRAIN	Alexandre	nov.-12	ST
T1	POULAIN	Laurent	nov.-12	ICRF Normandie
T1	DORMIEU	Benjamin	déc.-12	ST
T1	DEBROUCKE	Romain	nov.-11	ST
T1	LACAVE	Thomas	déc.-11	ALEDIA
T1	CANDERLE	Elodie	déc.-14	ST
T1	OEUVRARD	Sandrine	nov.-14	LYNRED IR products
T1	DENG	Marina	déc.-14	E/C IMS Bordeaux
T1	BOSSUET	Alice	mars-17	NXP

Thème	Nom	Prénom	Date Soutenance	Carrière post-Thèse
T1	BOUVOT	Simon	mars-18	ST
T1	DAFFE	Khadim	nov.-18	CAT-AMANIA
T1	GAUTHIER	Alexis	mai-19	ST
T1	GONCALVES	Joao Azevedo	mars-19	ST
T1	BELEM GONCALVES	Cybelle	janv.-20	ST
T1	GIDEL	Vincent	oct.-20	MC2
T1	BREZZA	Eduardo	déc.-22	ST
T1	GHANEM	Haitham	déc.-20-	NXP
T1	MAYE	Caroline	sept.-21	LEOS Univ Gustave Eiffel
T1	ALAJI	Issa	nov.-20	NXP
T2	CHAMLA	David	mai-06	ST
T2	FRAPPE	Antoine	dec.-07	JUNIA
T2	RAZAFIMANDIMBY	Stéphane	dec.-07	ST
T2	FLAMENT	Axel	juin-08	JUNIA
T2	GORISSE	Jean	nov.-10	SWATCH (CH)
T2	EGOT	Matthieu	dec.-11	MIRION Technologies
T2	MULLER	Jonathan	sept.-11	E-Peas SA (CH)
T2	CRUNELLE	Romain	dec.-11	Decathlon
T2	ZELENY	Jan	oct.-11	TAE Power solution (CZ)
T2	IZQUIERDO	Cristian	mai-11	NXP (D)
T2	WERQUIN	Arnaud	juin-13	MediTek (UK)
T2	GRAVE	Baptiste	déc.-13	Qualcom (IRL)

Thèse CIFRE
Thèse Autre financement

Carrière ST
Carrière académique

Carrière des doctorants (2/2)

Thèse CIFRE
Thèse Autre financement

Carrière ST
Carrière académique

Thème	Nom	Prénom	Date Soutenance	Carrière post-Thèse
T2	SHERRY	Hani	déc.-12	TiHive
T2	FOULON	Samuel	mai-13	ST
T2	SALAZAR	Camilo	mar.-15	CSEM (CH)
T2	SOURIKOPOULOS	Ilias	déc.-15	LEO Space Photonics (GR)
T2	GEBREYOHANNES	Fikre	déc.-16	Qualcom (IRL)
T2	MARIN	Cristian	nov.-17	Nordic Semiconductor (SE)
T2	CAUSO	Matteo	Jan.-17	Schindler Group (D)
T2	GONZALEZ	Angel	sept.-20	ST
T2	BENARROUCH	Robin	jan.-21	ST
T2	TOCHOU	Guillaume	fév.-22	ST
T2	HERISSE	Kévin	déc.-22	SATT Nord
T2	MOURRANE	Soufiane	sept.-23	ST
T3	AGACHE	Vincent	oct.-03	CEA
T3	CARUYER	Grégory	nov.05	QORVO
T3	VOLATIER	Alexandre	mars-07	QORVO
T3	EMERY	Patrick	juin-08	MENAPIC
T3	DURAND	Cédric	jan.-09	ST
T3	KONE	Issiaka	avr-10	GENERALI
T3	ROBILLARD	Jean-François	juil-08	JUNIA-ISEN
T3	MANTE	Pierre-Adrien	nov. 10	Ingénieur R&D
T3	CASSET	Fabrice	juin-14	CEA-LETI
T3	VIRGILIO	Christophe	mai-17	Ariane Group

Thème	Nom	Prénom	Date Soutenance	Carrière post-Thèse
T3	SALHAB	Abbas	fev.-22	CEA
T3	CHEVREUX	Fabien	sept.-23	INFINEON
T4	LARRIEU	Guilhem	avr.-04	LAAS-CNRS
T4	PENAUD	Julien	oct.-06	TOTAL PV
T4	CHARBUILLET	Clément	juin-07	ST
T4	FRULEUX	Frédérique	juin-07	THALES
T4	BREIL	Nicolas	mai-09	Applied Materials US
T4	LECESTRE	Aurélie	jui-10	LAAS-CNRS
T4	LECAVELIER	Aurélien	mars-13	THALES
T4	MORINI	François	jun-15	Wootzano (UK)
T4	HARAS	Maciej	jan.-16	CEZAMAT
T4	LACATENA	Valéria	juin-16	XFAB Corbeil
T4	PHILIPPE	Justine	sept.-17	JUNIA-ISEN
T4	NIEBOWJESKI	Heimanu	nov.-14	CEA-LETI
T4	BORREL	Julien	mar.-17	ST
T4	ZHU	Tianqi	déc.-19	BELIMO (CH)
T4	DIDENKO	Stanislav	juin-19	JSC IT Labs
T4	BHASKAR	Arun	oct.-19	QUALCOMM
T4	HIVIN	Quentin	juin-19	KEOPSY-S-LUMIBIRD
T4	BAH	Thierno	jui.-19	ST
T4	BOUCAUD	Jean-Marc	juin-20	ST
T4	FIORISE	Victor	sept.-22	ST

Comité de Pilotage et Workshop annuel PhD & Pdocs



2023

ST-IEMN Joint Laboratory - PhD Workshop Program
 Tuesday 13 Feb. 2024
 Room Mont Blanc

Agenda

08:30 Welcome Coffee

- 25 Présentations

- > 200 participants avec l'ouverture du Workshop en visioconférence

Topic 3	Small-scale elastic metrology using high-frequency acoustic waves
08:45 (LS)	Compatibility study of silicon-based films with lithography resists for imaging applications Fabien CHEVREUX CIFRE PhD defended on 11 Dec. 2023 (Remote presentation) – Supervision A. Devos, L.L. Chapelon
09:05 (RS)	Evaluation of Polymer wetting in high aspect ratio nanostructures using FIB and acoustic characterization Abbas SALHAB Post-doc funded under NANO2022 research program (Remote presentation) – Supervision J. Carlier, P. Garnier

LS=Long Slot (16' presentation + 4' questions) RS=Regular Slot (12' presentation + 3' questions) SS=Short Slot (8' presentation + 2' questions)

Topic 1	Potential of advanced technologies in the millimeter wave and photonic domains
09:20 (LS)	Automated and robotic on-wafer probe station for precision Ground-Signal-Ground (GSG) probing Cerine MOKHTARI PhD funded under NANO2022 and defended on 05 Dec. 2023 (Remote presentation) – Supervision K. Haddadi, D. Gloria
09:40 (LS)	Characterization & modeling of 650V GaN diodes for high frequency power conversion Martin DOUBLET PhD funded under NANO2022 and defended on 28 Jun. 2023 – Supervision J.C. de Jaeger, N. Defrance, E. Bouyssou
10:00 (RS)	Contribution to the development of THz Sub-Harmonic Mixers in RF-SOI & BiCMOS technologies targeting high-speed communications David OVALLE TAYLOR 3 rd year – CIFRE PhD ST-Univ. Nice-IEMN – Supervision G. Ducournau, C. Luxey, F. Gianesello
10:15 (RS)	Development of InP DHBT technology for sub-THz power amplification in 6G telecoms Abdelmalek ZEMOUR 1 st year – CIFRE PhD ST-IEMN – Supervision M. Zaknoune, P. Chevalier
10:30 (SS)	InP-on-Si Heterojunction bipolar transistor for low noise sub-THz power amplification for 6G telecoms Jihed DEROUICHE 1 st year – PhD funded under IEMN-IPCEI-04 program (Remote presentation) – Supervision M. Zaknoune, P. Chevalier
10:40 (RS)	Topology solutions for Agile Front-End Module at mmW frequencies (140-170GHz) using in situ calibration: D-band phase shifters design, comparison between active and passive approach Larbi BOUKHEZAR 2 nd year – CIFRE PhD ST-TIMA-IEMN – Supervision V. Knopik, M. Margaleff, C. Durand, P. Ferrari, G. Ducournau

LS=Long Slot (16' presentation + 4' questions) RS=Regular Slot (12' presentation + 3' questions) SS=Short Slot (8' presentation + 2' questions)

10:55 – 11:15 Break

11:15 (SS)	Contribution to circuit design and advanced characterization for D-band communications applications Yewulsew MANALE 1 st year – PhD funded under KDT SHIFT/ANR (Remote presentation) – Supervision G. Ducournau, F. Danneville, D. Gloria
11:25 (SS)	Linear, non-linear, noise and power characterisation of components and realisation of functions in advanced mmW technology Bachar BARIDI 1 st year – PhD funded under IEMN-IPCEI-05 (Remote presentation) – Supervision G. Ducournau, F. Danneville, D. Gloria
11:35 (RS)	RF-SOI Technology Development for 5G Applications Thomas BORDIGNON 3 rd year – CIFRE PhD ST – IEMN – Supervision F. Danneville, Y. Roelens, S. Cremer

LS=Long Slots are allocated to PhD thesis defended in 2023 SS= Short Slots are allocated to freshly started PhD thesis for subject presentation

1/2

Topic 4	RF/mmW functional packaging and microthermics
11:50 (LS)	Integrated metrology devices for the study of transport properties in silicon nanostructures Hafsa IKZIBANE PhD funded by Univ. Lille and defended on 29 Nov. 2023 (Remote presentation) – Supervision J.F Robillard, E. Dubois
12:10 (LS)	Thermal characterization of GeSbTe alloys by Raman thermometry for phase-change memories Akash PATIL CIFRE PhD ST-IEMN defended on 27 Nov. 2023 – Supervision J.F Robillard, E. Dubois, S. Jeannot, P. Boivin
12:30 (RS)	Low-temperature heat transfer in SiN and Si: Quantum nanophononics Jon CANOSA-DIAZ 3 rd year – PhD funded under ANR HANIBAL project – Supervision J.F Robillard
12:45 (SS)	Thermal characterization of emerging materials for PCM non-volatile memories. Tushar CHAKRABARTY 1 st year – CIFRE PhD ST-IEMN – Supervision J.F Robillard, S. Jeannot

12:55 – 14:30 Lunch

14:30 (RS)	Micromachining and packaging of smart probes for sub-mmW on-wafer measurements Maya ALAWAR 4 th year – PhD funded under IEMN-IPCEI-08 research program – Supervision E. Dubois, G. Ducournau, D. Gloria
14:45 (RS)	Microcavities engineering applied to ultra-fast SOI-RFCMOS devices and circuits for 5G and beyond Daniel GHEYSENS 3 rd year – CIFRE PhD ST-IEMN – Supervision E. Dubois, J.F Robillard, A. Fleury, S. Monfray
15:00 (RS)	Ultra-fast RF-PCM switches for 5G and beyond Corentin MERCIER 3 rd year – CIFRE PhD ST-IEMN-CEA – Supervision J.F Robillard, E. Dubois, S. Monfray, A. Fleury, B. Reig

LS=Long Slot (16' presentation + 4' questions) RS=Regular Slot (12' presentation + 3' questions) SS=Short Slot (8' presentation + 2' questions)

Topic 2	Communicating systems and AI hardware
15:15 (LS)	2-Step SAR-assisted digital-slope ADC for ultra-low power radio frequency receivers Jean-Baptiste CASANOVA CIFRE PhD defended on 08 Dec. 2023 – Supervision A. Kaiser, S. Nicolas, D. Perrin
15:35 (LS)	Low power event-driven feature extraction unit for audio keyword spotting in 28nm FD-SOI Soufiane MOURRANE CIFRE PhD defended on 11 Dec. 2023 – Supervision – Supervision A. Frappé, B. Larras, A. Cathelin
15:55 (RS)	Event-driven antidictionary-based ECG classification Julien DUFOREST 4 th year – PhD funded under CHIST-ERA JEDA1 program – Supervision A. Frappé, B. Larras – Sponsor: A. Cathelin, S. Clerc
16:10 (RS)	A 28nm FDSOI in-cell weight update scheme using one-hot gradients for on-chip learning Mathieu CHENE 3 rd year – PhD funded by AI_Engineering_PhD@Lille – Supervision A. Kaiser, A. Frappé, B. Larras – Sponsor: A. Cathelin, S. Clerc

16:25 – 16:45 Break

16:45 (RS)	Multiplier-less in-memory artificial neural network in 28nm CMOS FDSOI for embedded biomedical applications Antoine GAUTIER 4 th year – PhD funded under CHIST-ERA JEDA1 program – Supervision A. Frappé, B. Larras – Sponsor: A. Cathelin, S. Clerc
17:00 (SS)	Phase change-memory assisted binary neural network machine learning circuit design Joaquin CORNEJO 1 st year – CIFRE PhD ST-IEMN-CEA – Supervision A. Frappé, B. Larras, A. Cathelin, S. Clerc, T. Hirtzlin
17:10 (SS)	Passive envelope detector design for wake-up radio in 2.4GHz band Oussama CHAFAI 1 st year – CIFRE PhD ST-IEMN – Supervision A. Kaiser, A. Frappé, R. Welk, M. Ayraud

LS=Long Slot (16' presentation + 4' questions) RS=Regular Slot (12' presentation + 3' questions) SS=Short Slot (8' presentation + 2' questions)

17:20 End of Workshop

LS=Long Slots are allocated to PhD thesis defended in 2023 SS= Short Slots are allocated to freshly started PhD thesis for subject presentation

2/2





Laboratoire Commun ST-IEMN 20 ans



Thank you

