

# « Entanglement between Micro-Magnetism, Electromagnetism and the Tensor Magnetic Phase Theory (TMPT) – Symmetry, invariance and conservation laws analysis »



**Physics and its Applications**



**18<sup>th</sup> of July 2023 in LA**



**Olivier MALOBERTI**

**SYMADE - Unilasalle Amiens - FRANCE**



# Context



## Energy Engineering and Digital Systems

## Energy Management and Systems



**EEDD Program:** Energy & sustainable development

Electrical Engineering, materials and machines, energy technologies for energy transition & sustainable development.



**GEB Program**

Building Energy Production, Management & Efficiency



**PAUC Program**

Process Automated production and connected factory



**RIOC Program**

Computer Networks and Telecommunications



**Topic 1:**

**Energy systems and Sustainable Development  
Material processes & EcoDesign**

Renewable energies, production and autonomy  
Systems, grids and territorial networks



Topic 2: IIoT and Industry 4.0  
Topic 3: Data Science & digital systems

# CONTENT

- 1. Context - State Of the Art - Dilemma**
- 2. From Micromagnetism to the Tensor Magnetic Phase Theory**
- 3. Coupling with the Maxwell equations**
- 4. Derivation of the magnetic domains structuring**
- 5. Symmetry, Invariance principles and analysis**
- 6. Application examples: iron losses, surface laser treatments ...**
- 7. Discussion, Conclusion and Forthcoming**

# 1. Context

## Materials heterogeneity with subdivisions (domains and walls)

# (Soft Magnetic) Materials with polarization(s)

### Magnetic materials

- Magnetic structure
- Magnetic domains and walls
- Closure domains

### Ferroelectric materials

- Domains for the electric polarization

### Multiferroic materials

- Domains for the electric polarization & domains for the magnetic polarization

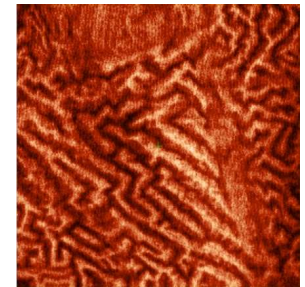
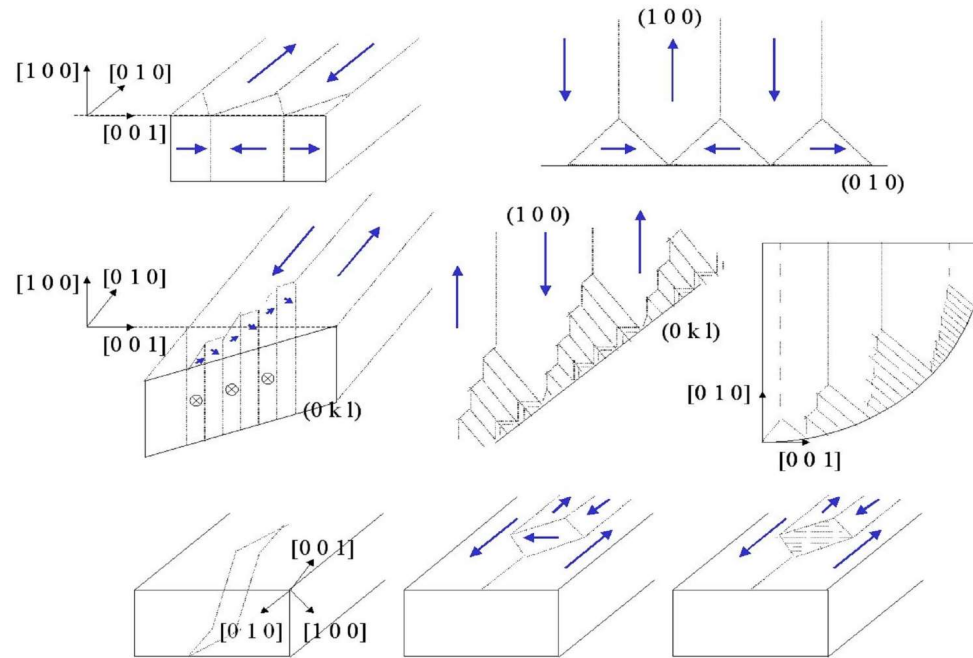

MFM image of NGOES steel

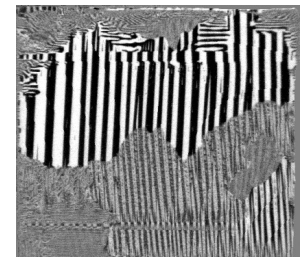

MOKE image of GOES steel

# 1. State Of The Art and dilemmas

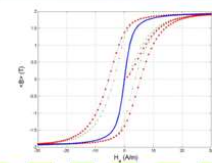
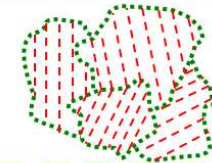
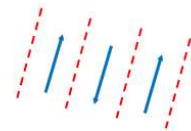
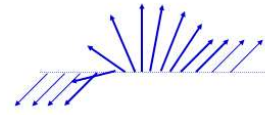
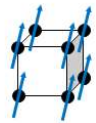
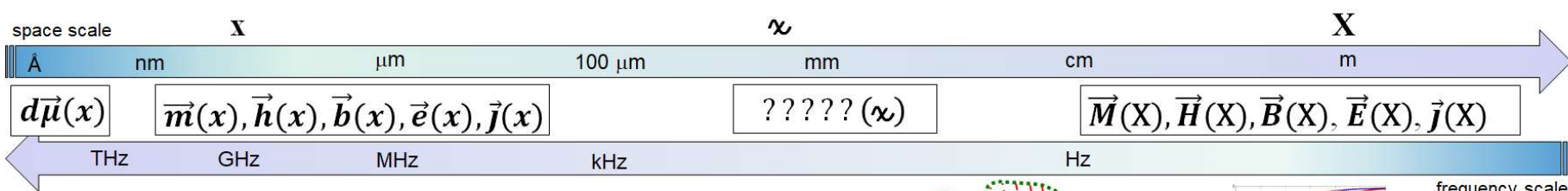

**elementary magnetic moment**  
 $d\vec{\mu} = \frac{g\mu_B}{\hbar} d\vec{S} [A.m^2]$

**Microscopic magnetization:**  
 $\vec{m} = \frac{Z_c d\vec{\mu}}{d\Omega_{lattice}} = M_s \frac{\vec{m}}{m} [A.m^{-1}]$

**MICROMAGNETISM (Landau-Lifshitz-Gilbert)**

$$\frac{1}{\gamma} \frac{d\vec{m}}{dt} = \vec{m} \wedge (\vec{h}_{eff}) \underset{f \ll GHz}{\approx} \vec{0}$$

exchange Stress anisotropy Stray field magnetic field

$$\vec{h}_{eff} = \vec{h}_{ex} + \vec{h}_{an} + \vec{h}_{\lambda_s} + \vec{h}_{\lambda_E} + \vec{h}_{dm} + \vec{h}_{ed} + \vec{h}$$

Cristal anisotropy Self magnetostriction anti-eddy field

**MICRO. ELECTROMAGNETISM (Maxwell)**

$$\begin{aligned} \vec{\nabla} \wedge \vec{h} &= \vec{j} + \epsilon_0 \partial_t \vec{e} \approx \sigma \vec{e} \\ \vec{\nabla} \wedge \vec{e} &= -\partial_t \vec{b} = -\mu_0 \partial_t \vec{h} - \partial_t \vec{m} \end{aligned}$$

**Magnetic field**  $\vec{H}$   
**Flux density**  $\vec{B}$   
**Electric field**  $\vec{E}$   
**Current density**  $\vec{j}$

**BEHAVIORAL LAWS**

$$\begin{aligned} \vec{B}(\vec{H}) \\ \vec{j}(\vec{E}) \end{aligned}$$

**MACRO. ELECTROMAGNETISM (Maxwell)**

$$\begin{aligned} \left\{ \begin{aligned} \vec{\nabla} \wedge \vec{H} &= \vec{j} = \sigma \vec{E} \\ \vec{\nabla} \wedge \vec{E} &= -\partial_t \vec{B} \end{aligned} \right\} \\ \Rightarrow \vec{\nabla} \wedge \vec{\nabla} \wedge \vec{H} + \sigma \partial_t \vec{B} &= \vec{0} \end{aligned}$$

Dilemmas:  $\vec{h}$  depends on distribution of  $\vec{m}$  at very long distance  
 Distribution of  $\vec{m}$  known only in a small area

Microscopic magnetic structures with domains are ignored  
 Magnetization reversal mechanisms with walls are ignored



# 2. From local to HOLISTIC Paradigm ?

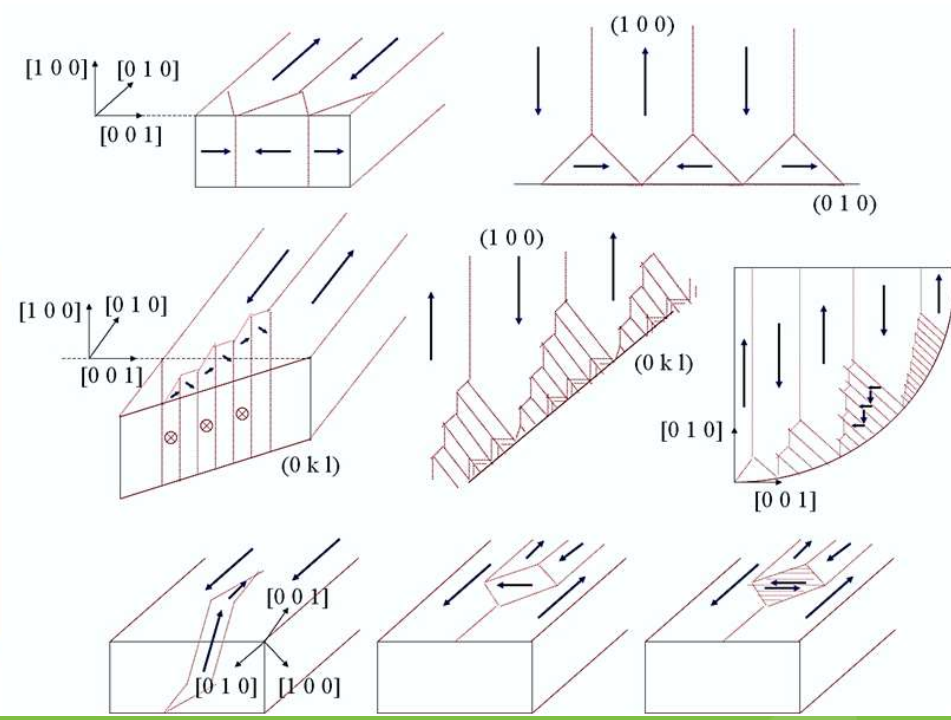
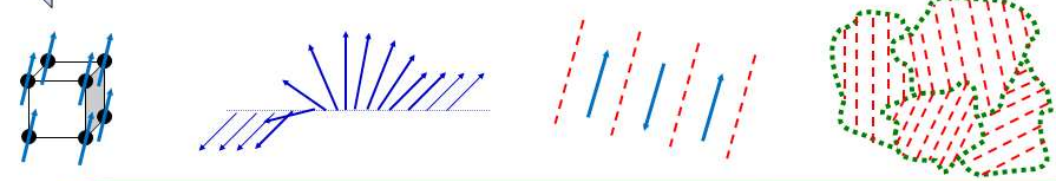
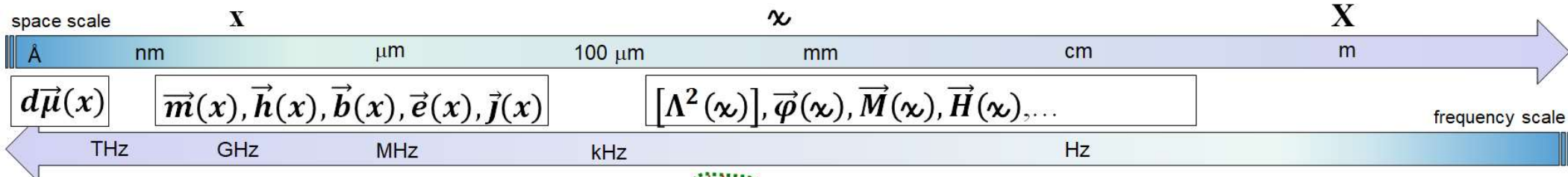

## Magnetization with tensor magnetic phases

$$\vec{M}(x, t) = \langle \vec{m}(x, t) \rangle_x = \mu_0^{-1} [\Lambda^2(x, t)]^{-1} \vec{\varphi}(x, t)$$

$$[\Lambda^2] = \begin{bmatrix} \Lambda_{11}^2 & \Lambda_{12}^2 & \Lambda_{13}^2 \\ \Lambda_{21}^2 & \Lambda_{22}^2 & \Lambda_{23}^2 \\ \Lambda_{31}^2 & \Lambda_{32}^2 & \Lambda_{33}^2 \end{bmatrix} \begin{cases} \Lambda_{ii}^2 \propto \lambda_j \lambda_k; j, k \neq i \text{ and } i = 1..3 \\ \Lambda_{ij}^2 \propto \lambda_k^2; k \neq i \neq j \text{ and } i, j = 1..3 \end{cases}$$

Each factor ( $\lambda_i, \lambda_j$  and  $\lambda_k$ ) is homogeneous to a squared length, linked to walls density and surface for each direction (inspired from Néel)

**ENERGY FORMULATION ?  
GOVERNING EQUATIONS ?**

## 2. From Micro-Magnetism to the TMPT

# Lagrangian Energy densities [J.m<sup>-3</sup>]

Micro-Magnetism (LLG equations)

$$(\boldsymbol{x}, t) = \langle (x, t) \rangle_x$$

MAGNETIC PHASES (TMPT)

$$\ell = \boldsymbol{t} - \boldsymbol{u} \approx -\boldsymbol{u} \quad (f \ll \text{GHz})$$

$$\boldsymbol{u} = \boldsymbol{u}_{ex} + \boldsymbol{u}_{an} + \boldsymbol{u}_{\lambda_s} + \boldsymbol{u}_{\lambda_\varepsilon} + \boldsymbol{u}_{dm}$$

$$\vec{\boldsymbol{h}} = -\vec{\nabla} \vec{\boldsymbol{m}}(\boldsymbol{u})$$

$$\boldsymbol{u}(\boldsymbol{x}, t) = \langle \boldsymbol{u}(x, t) \rangle_x$$

$$\vec{\boldsymbol{m}} \rightarrow \vec{\boldsymbol{M}}([V^2], \vec{\boldsymbol{\varphi}})$$

$$\boldsymbol{u}([V^2], \vec{\boldsymbol{\varphi}})$$

$$\boldsymbol{u}_i = J_s^2 \left( \frac{\gamma_w}{K_{an}} \right)^4 \partial_{\varphi_i^2} \boldsymbol{u}$$

$$\vec{\boldsymbol{L}} = \vec{\boldsymbol{T}} - \vec{\boldsymbol{u}} \approx -\vec{\boldsymbol{u}} \quad (f \ll \text{GHz})$$

$$\vec{\boldsymbol{u}} = \vec{\boldsymbol{u}}_{ex} + \vec{\boldsymbol{u}}_{an} + \vec{\boldsymbol{u}}_{\lambda_s} + \vec{\boldsymbol{u}}_{\lambda_\varepsilon} + \vec{\boldsymbol{u}}_{dm}$$

**TENSOR STATE VARIABLE**

$$[V^2] = [\Lambda^2]^{-1}$$

**Materials parameters**

$\gamma_w$  [J.m<sup>-2</sup>] walls energy density

$\vec{\boldsymbol{K}}_{an} = K_{an} \vec{\boldsymbol{u}}_{an}$  [J.m<sup>-3</sup>] anisotropy vector

$J_s = \mu_0 M_s$  [T] saturation polarization  
 $A_{ex}$  [J.m.A<sup>-2</sup>] exchange coefficient  
 $K_{an}$  [J.m<sup>-3</sup>] anisotropy constant

## 2. From Micro-Magnetism to the TMPT

# Lagrangian Energy densities [J.m<sup>-3</sup>]

Micro-Magnetism (LLG equations)

MAGNETIC PHASES (TMPT)

$$C_{ex} \approx M_S^2 \frac{A_{ex} K_{an}}{\gamma_w^2}$$

$$C_{an} \approx 1$$

$$[Y] \wedge [Z] = [\bar{Y}_1 \wedge \bar{Z}_1, \bar{Y}_2 \wedge \bar{Z}_2, \bar{Y}_3 \wedge \bar{Z}_3]^T$$

$$[Y] \odot [Z] = (\bar{Y}_1 \cdot \bar{Z}_1, \bar{Y}_2 \cdot \bar{Z}_2, \bar{Y}_3 \cdot \bar{Z}_3)^T$$

$$[Y]^{\odot 2} = [Y] \odot [Y]$$

$$[\bar{V}] \wedge [Y] = [\bar{V} \wedge \bar{Y}_1, \bar{V} \wedge \bar{Y}_2, \bar{V} \wedge \bar{Y}_3]^T$$

$$\vec{u}_{ex} \propto C_{ex} \frac{\gamma_w^6}{K_{an}^5} ( [\bar{V}] \wedge [V^2] )^{\odot 2}$$

### Magnetic Exchange

$$u_{ex} = A_{ex} |(\vec{V} \wedge \vec{m})|^2$$

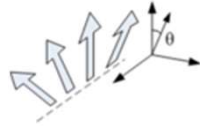

### Magneto-Cristalline Anisotropy

(uni-axial  $\vec{u}_{an}$  case)

$$u_{an} = \frac{K_{an}}{M_S^2} |(\vec{m} \wedge \vec{u}_{an}) \wedge \vec{u}_{an}|^2$$

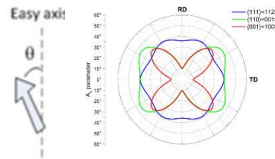

$$\vec{u}_{an} \propto C_{an} \frac{\gamma_w^4}{K_{an}^3} \left( [V^2] - \left( \frac{\vec{K}_{an} \cdot ([V^2] \cdot \vec{K}_{an})^T}{|\vec{K}_{an}|^2} \right)^T \right)^{\odot 2}$$



## 2. From Micro-Magnetism to the TMPT

# Lagrangian energy densities [J.m<sup>-3</sup>]

### Micro-Magnetism (LLG equations)

### MAGNETIC PHASES (TMPT)

#### Stress Induced Anisotropy

$$\mathbf{u}_{s\varepsilon} = -\frac{3}{2} \frac{[\vec{m} \otimes \vec{m}]}{M_S^2} \circ \left( [\lambda] \div [s] \div \frac{[\vec{m} \otimes \vec{m}]}{M_S^2} \right)$$

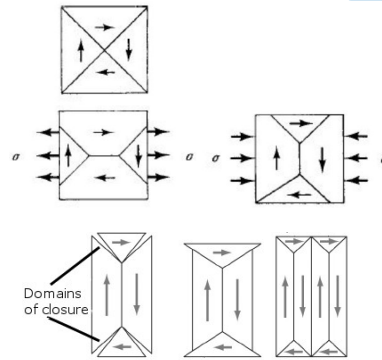

$$\vec{u}_{\lambda s} \propto -\frac{3}{2} C_{\lambda s} \frac{\gamma_w^4}{K_{an}^3} [V^2] \odot \left( \frac{[\lambda] \div [s]}{K_{an}} \div [V^2] \right)$$

*[s] [Pa] the stress tensor*

*[\lambda] [n.u.] magnetostriction tensor*

#### Self Magneto-striction Energy

$$\mathbf{u}_{\lambda\varepsilon} = +\frac{9}{4} \frac{[\vec{m} \otimes \vec{m}]}{M_S^2} \circ \left( [\lambda^2] \div [C] \div \frac{[\vec{m} \otimes \vec{m}]}{M_S^2} \right)$$

$$C_{\lambda s} \approx C_{\lambda\varepsilon} \approx 1$$

$$[\vec{A} \otimes \vec{B}], [\vec{A} \otimes \vec{B}]_{ij} = A_i B_j$$

$$[Y] \div [Z], [[Y] \div [Z]]_{ij} = Y_{ij} Z_{ij}$$

$$[Y] \circ [Z] = Y_{ij} Z_{ij} : \text{scalar product}$$

$$\vec{u}_{\lambda\varepsilon} \propto +\frac{9}{4} C_{\lambda\varepsilon} \frac{\gamma_w^4}{K_{an}^3} [V^2] \odot \left( \frac{[\lambda^2] \div [C]}{K_{an}} \div [V^2] \right)$$

*[\lambda] [n.u.] magnetostriction tensor*

*[C] [Pa] stiffness tensor*

## 2. From Micro-Magnetism to the TMPT

# Lagrangian & dissipation functional

### Micro-Magnetism (LLG equations)

### MAGNETIC PHASES (TMPT)

#### Demagnetizing stray-field Energy

$$\mathbf{u}_{dm} = -\overrightarrow{\mathbf{h}}_{dm} \cdot \overrightarrow{\mathbf{m}}$$



$$\overrightarrow{\mathbf{h}}_{dm}(\overrightarrow{\mathbf{m}} \cdot \overrightarrow{\mathbf{n}}, \overrightarrow{\nabla} \cdot \overrightarrow{\mathbf{m}})$$

$$\overrightarrow{\nabla} \cdot \overrightarrow{\mathbf{m}} \approx 0 \Rightarrow \overrightarrow{\nabla} \cdot \overrightarrow{\mathbf{M}} \approx 0$$

$$\begin{cases} [\overrightarrow{\nabla}] \cdot [\mathbf{V}^2] = 0 \\ [\overrightarrow{\nabla}] \cdot [\Lambda^2] = 0 \end{cases}$$

$$\overrightarrow{\mathbf{u}}_{dm} \propto C_{dm} \frac{K_{an}^4}{\gamma_w^3} \left( \overrightarrow{\mathbf{n}} \cdot ([\Lambda^2] \cdot \overrightarrow{\mathbf{n}})^T \right) \overrightarrow{\odot}^2$$

$C_{dm}$  (grain size, boundaries and surface treatments)  
 $\mathbf{n}$ : unit vector normal to  $\partial\Omega$

#### Eddy currents lost Energy

$$\mathbf{r}_{ed} = \frac{1}{2} \eta \partial_t \overrightarrow{\mathbf{m}} \cdot \partial_t \overrightarrow{\mathbf{m}}$$

$$\overrightarrow{\mathbf{h}}_{ed} = -\overrightarrow{\nabla} \partial_t \overrightarrow{\mathbf{m}}(\mathbf{r}_{ed})$$

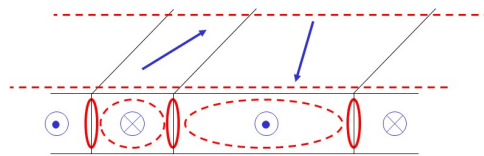

$\eta$  magnetic damping parameter

$$\overrightarrow{\mathbf{R}}_{ed} \propto \frac{1}{2} \frac{\gamma_w^4}{K_{an}^3} \tau \partial_t [\mathbf{V}^2] \overrightarrow{\odot} \tau \partial_t [\mathbf{V}^2]$$

$\tau$  [s] time delay of domains structure

### 3. Coupling with the Maxwell equations?

## Electromagnetism - interfaces

Field diffusion equation everywhere  
 $\Rightarrow \vec{\nabla} \wedge \vec{\nabla} \wedge \vec{H} + \sigma \partial_t \vec{B} = \vec{0}$

Coupling formulation at boundaries  
 $[\text{constraint}(\vec{H}, \vec{B}, [V^2])] = [0]$

- $\epsilon_0$  [F . m<sup>-1</sup>] air permittivity
- $\mu_0$  [H . m<sup>-1</sup>] air permeability
- $\sigma$  [S.m<sup>-1</sup>] electrical conductivity
- $[v]$  [m.H<sup>-1</sup>] magnetic reluctivity
- $\omega$  [rad.s<sup>-1</sup>] angular velocity
- $\tau_b$  [s] time delay of flux

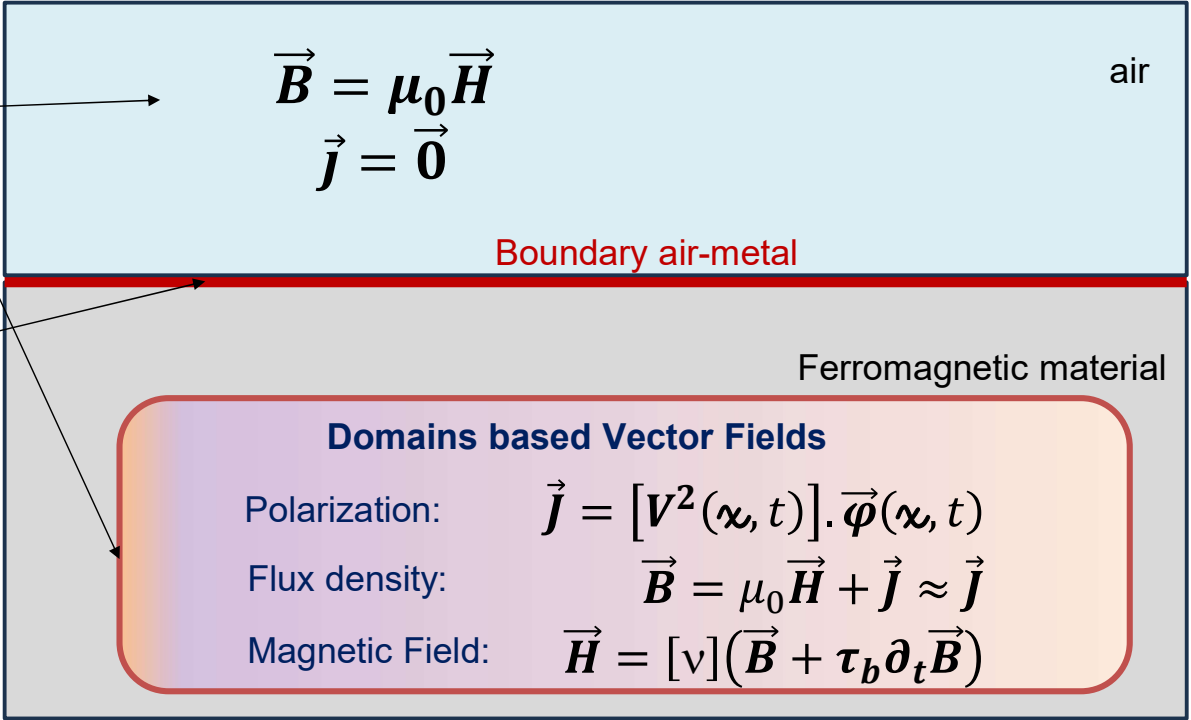

### 3. Coupling with the Maxwell equations?

#### Electromagnetism (Poynting) - volume

$$T + U = \int (\sigma^{-1} |\vec{\nabla} \wedge \vec{H}|^2 + \vec{H} \cdot \partial_t \vec{B}) \cdot dt$$

$$\vec{\nabla} \wedge \vec{H} \approx \vec{\nabla} \wedge ([v][V^2] \vec{\varphi}) = \vec{\nabla} \wedge ([v])[V^2] \vec{\varphi} + [v] \vec{\nabla} \wedge ([V^2]) \vec{\varphi} + [v][V^2] \vec{\nabla} \wedge (\vec{\varphi})$$

$$\vec{U}_{an} \propto \frac{J_s^2}{\sigma \omega} \left( \frac{\gamma_w}{K_{an}} \right)^4 ((\vec{\nabla} \wedge [v])[V^2])^{\odot 2}$$

$$\vec{U}_{ex} \propto \frac{J_s^2}{\sigma \omega} \left( \frac{\gamma_w}{K_{an}} \right)^4 ([v]([\vec{\nabla}] \wedge [V^2]))^{\odot 2}$$

$$\vec{\mathcal{R}}_{ed} \propto [v] \tau_b \partial_t [V^2] \odot \tau_b \partial_t [V^2]$$

$$\delta \int ([v][V^2] (\sigma^{-1} [v][V^2] |\vec{\nabla} \wedge \vec{\varphi}|^2 + \vec{\varphi} \cdot \partial_t [V^2] \vec{\varphi})) dt = 0$$

hamiltonian of diffusion equation for  $\vec{\varphi}$

# 4. Derivation of the domains structuring

## Principle of stationary Vectorial Action [J.s]

### QS conservative Formulation (Euler Lagrange equations)

$$\vec{\mathcal{S}} = \iiint \int \vec{\mathcal{L}}([V^2], \partial_t[V^2], t) dt \, dx \quad \text{or} \quad \mathcal{S}_j = \iiint \int \mathcal{L}_j(V_{ij}^2, \partial_t V_{ij}^2, t) dt \, dx \quad \vec{\mathcal{R}}_{ed} = \vec{0}$$

$$\delta \vec{\mathcal{S}} = 0 \Leftrightarrow \delta \mathcal{S}_j = 0 \Leftrightarrow \left( \frac{\partial \mathcal{L}_j}{\partial V_{ij}^2} - \partial_t \left( \frac{\partial \mathcal{L}_j}{\partial \partial_t V_{ij}^2} \right) \right) = 0 \xleftrightarrow{(f \ll GHz)} \left( -\frac{\partial \mathcal{U}_j}{\partial V_{ij}^2} \right) = 0$$

$$\begin{aligned} [\vec{\nabla}] \cdot [Y] &= (\vec{\nabla} \cdot \vec{Y}_1, \vec{\nabla} \cdot \vec{Y}_2, \vec{\nabla} \cdot \vec{Y}_3)^T \\ [\Delta][Y] &= [\vec{\Delta}(\vec{Y}_1), \vec{\Delta}(\vec{Y}_2), \vec{\Delta}(\vec{Y}_3)]^T \end{aligned}$$

$$\begin{aligned} [\vec{\nabla}] \cdot [V^2] &= 0 \\ [\vec{\nabla}] \cdot [\Lambda^2] &= 0 \end{aligned}$$

$$\begin{aligned} &[\Delta][V^2] - \frac{C_{an}}{C_{ex}} \left( \frac{K_{an}}{\gamma_w} \right)^2 \left( [V^2] - \left( \frac{\vec{K}_{an} \cdot ([V^2] \cdot \vec{K}_{an})^T}{|\vec{K}_{an}|^2} \right)^T \right) + \\ &\frac{3}{2} \frac{C_{\lambda s}}{C_{ex}} \left( \frac{K_{an}}{\gamma_w} \right)^2 \left( \frac{[\lambda] \div [\sigma]}{K_{an}} \div [V^2] \right) - \frac{9}{4} \frac{C_{\lambda \epsilon}}{C_{ex}} \left( \frac{K_{an}}{\gamma_w} \right)^2 \left( \frac{[\lambda^2] \div [C]}{K_{an}} \div [V^2] \right) = [0] \end{aligned}$$



# 4. Example of Results

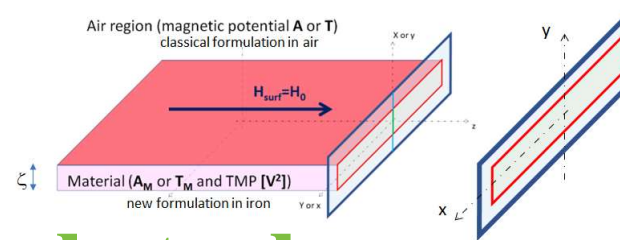

# Application to electrical steels (GOES & NGOES)

## 2D CALCULATION AT QUASI-STATIC EQUILIBRIUM WITH THE FINITE ELEMENT METHOD

### Grain Oriented material

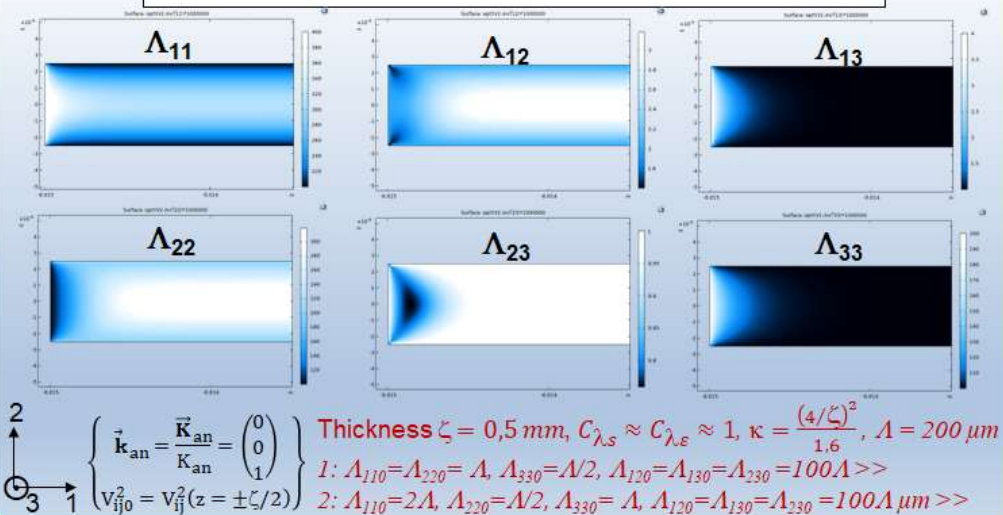

### Non-Grain Oriented Material

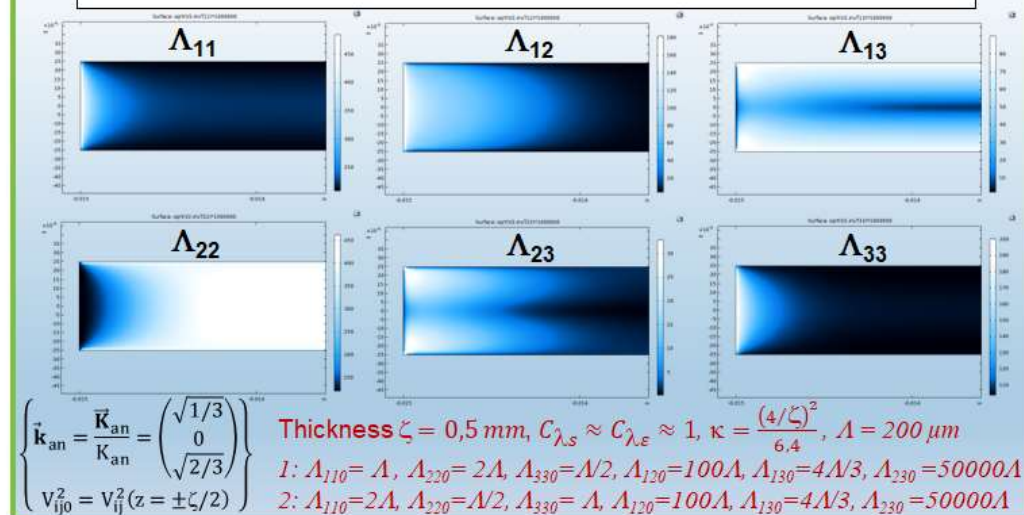

# 4. Derivation of the domains structuring

## Principle of stationary Vectorial Action [J.s]

### Dynamic dissipative Formulation (Noëther equations)

$$\delta \vec{\mathcal{S}} = 0 \Leftrightarrow \delta \mathcal{S}_j = 0 \Leftrightarrow \left( \frac{\partial \mathcal{L}_j}{\partial V_{ij}^2} - \partial_t \left( \frac{\partial \mathcal{L}_j}{\partial \partial_t V_{ij}^2} \right) \right) \delta V_{ij}^2 + \frac{d}{dt} \left( \frac{\partial \mathcal{L}_j}{\partial \partial_t V_{ij}^2} \delta V_{ij}^2 \right) + \frac{\partial \mathcal{L}_j}{\partial t} \delta t = 0$$

$$\xleftrightarrow{(f \ll \text{GHz})} \frac{\partial \mathcal{L}_j}{\partial t} = \frac{\partial \mathbf{u}_j}{\partial V_{ij}^2} \frac{\partial V_{ij}^2}{\partial t} = - \frac{\partial \mathcal{R}_{ed,j}}{\partial \tau \partial_t V_{ij}^2} \frac{\partial V_{ij}^2}{\partial t} \Leftrightarrow \left( \frac{\partial \mathbf{u}_j}{\partial V_{ij}^2} + \frac{\partial \mathcal{R}_{ed,j}}{\partial \tau \partial_t V_{ij}^2} \right) = 0$$

$$\begin{aligned} & [\Delta][\mathbf{V}^2] - \frac{C_{an}}{C_{ex}} \left( \frac{K_{an}}{\gamma_w} \right)^2 \left( [\mathbf{V}^2] - \left( \frac{\vec{K}_{an} \cdot ([\mathbf{V}^2] \cdot \vec{K}_{an})^T}{|\vec{K}_{an}|^2} \right)^T \right) + \\ & \frac{3 C_{\lambda s}}{2 C_{ex}} \left( \frac{K_{an}}{\gamma_w} \right)^2 \left( \frac{[\lambda] \div [\sigma]}{K_{an}} \div [\mathbf{V}^2] \right) - \frac{9 C_{\lambda \epsilon}}{4 C_{ex}} \left( \frac{K_{an}}{\gamma_w} \right)^2 \left( \frac{[\lambda^2] \div [C]}{K_{an}} \div [\mathbf{V}^2] \right) - \left( \frac{K_{an}}{\gamma_w} \right)^2 \tau \partial_t [\mathbf{V}^2] = [\mathbf{0}] \end{aligned}$$

# 4. Example of Results

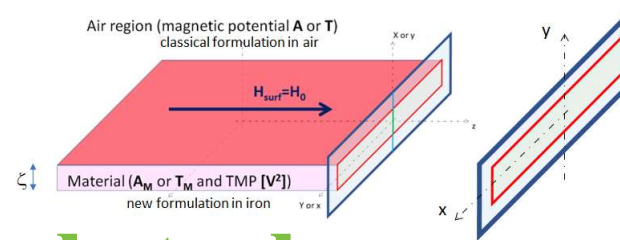

# Application to electrical steels (GOES & NGOES)

## 2D DYNAMIC MAGNETOHARMONIC CALCULATION WITH THE FINITE ELEMENT METHOD

Grain Oriented material

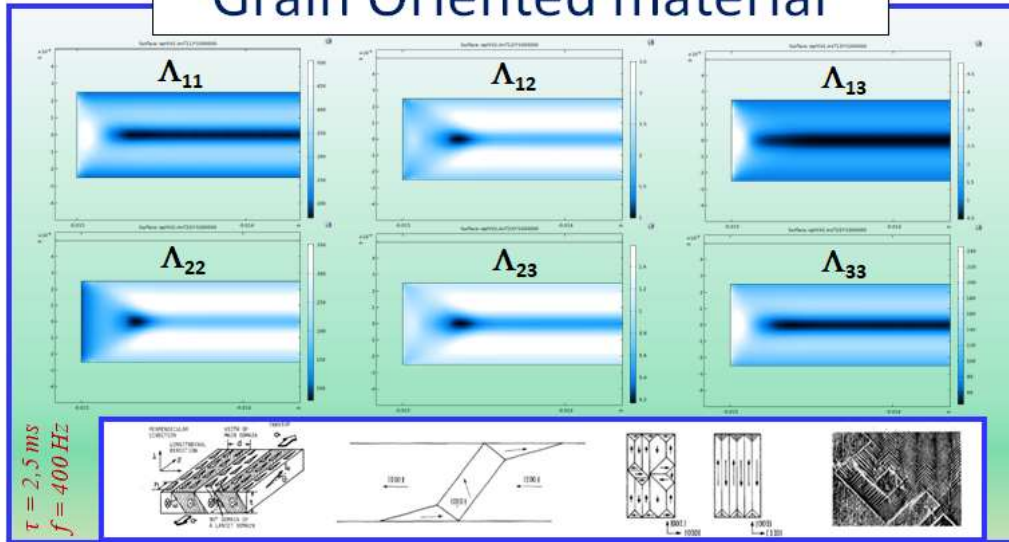

Non-Grain Oriented Material

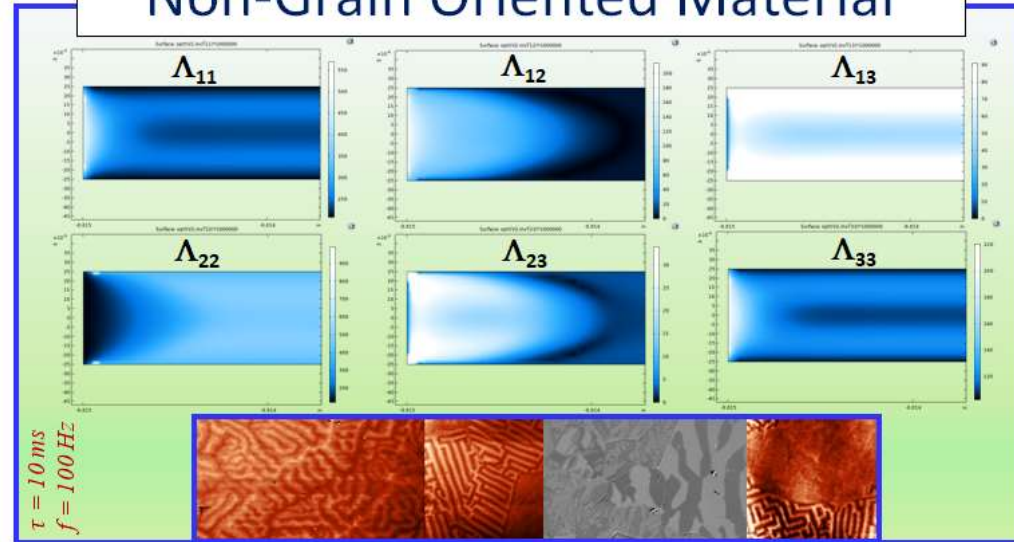

# 5. Symmetries and Invariance

CPT properties of TMPT Lagrangian (  $\boldsymbol{x} \rightarrow -\boldsymbol{x}; t \rightarrow -t; \vec{M} \rightarrow -\vec{M}; \vec{\varphi} \rightarrow -\vec{\varphi}$  )

Dual Lorentz transformation  $\mathbb{V}$  of referential frame (galilean motion at speed  $\vec{v}$ ) that keeps invariant the action

$$\begin{pmatrix} \vartheta t' \\ x'_1 \\ x'_2 \\ x'_3 \end{pmatrix} = \mathbb{V} \begin{pmatrix} \vartheta t \\ x_1 \\ x_2 \\ x_3 \end{pmatrix}$$

Material constant

« Speed of magnetization » :

$$\vartheta = \gamma_w K_{an}^{-1} \tau^{-1}$$

$\det \mathbb{V} = 1$

Lorentz factors :

$$\vec{\beta} = \frac{\vec{v}}{\vartheta}$$

and

$$\alpha = \left( 1 + |\vec{\beta}|^2 \right)^{-1/2}$$

Metrics:

, Invariant 4-vectors:

$$g_{\mu\nu} = \text{diag}(1,1,1,1) \quad \alpha(\vartheta, \vec{v}), \alpha(\vec{\beta} \cdot \vec{F}, \vec{F}), \alpha\left(\frac{\vartheta}{\sigma}, \vec{j}\right)$$

$$\mathbb{V} = \begin{bmatrix} \alpha & -\alpha\beta_1 & -\alpha\beta_2 & -\alpha\beta_3 \\ +\alpha\beta_1 & 1 + (\alpha - 1)\frac{\beta_1^2}{\beta^2} & (\alpha - 1)\frac{\beta_1\beta_2}{\beta^2} & (\alpha - 1)\frac{\beta_1\beta_3}{\beta^2} \\ +\alpha\beta_2 & (\alpha - 1)\frac{\beta_2\beta_1}{\beta^2} & 1 + (\alpha - 1)\frac{\beta_2^2}{\beta^2} & (\alpha - 1)\frac{\beta_2\beta_3}{\beta^2} \\ +\alpha\beta_3 & (\alpha - 1)\frac{\beta_3\beta_1}{\beta^2} & (\alpha - 1)\frac{\beta_3\beta_2}{\beta^2} & 1 + (\alpha - 1)\frac{\beta_3^2}{\beta^2} \end{bmatrix}$$



# 6. Application Examples

## Ferromagnetic Materials

Hysteresis, permeability & losses are due to the magnetization mechanisms within domains & walls

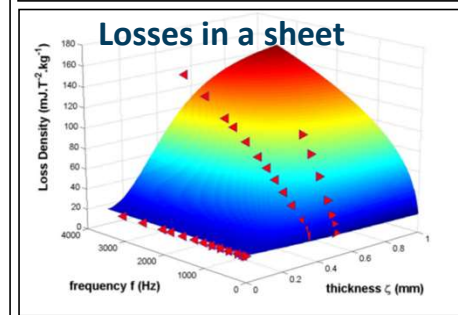
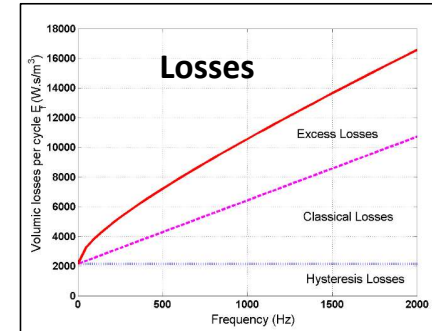
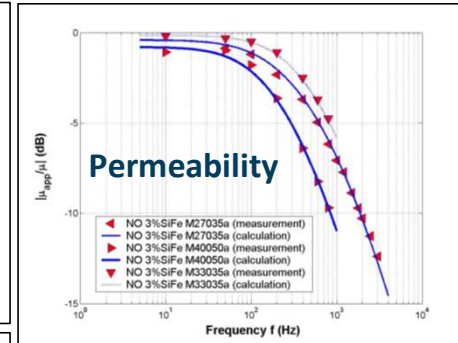
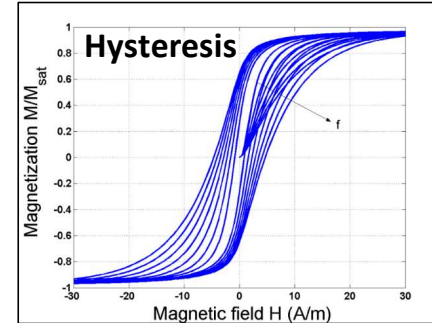
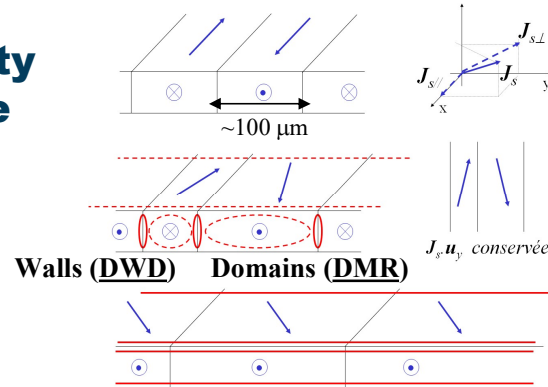

## Ferroelectric and Multiferroic Materials

Both magnetically and electrically polarized domains

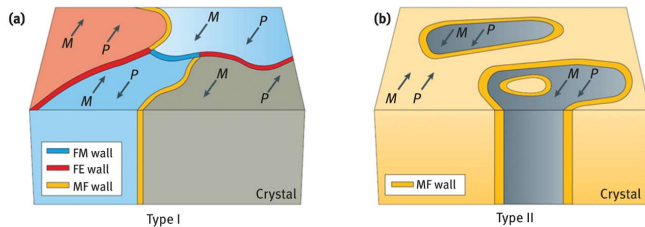

Magnetic Polarization:  $\vec{J} = [V_J^2] \vec{\phi}_J = [V_J^2] \left( \left[ \Lambda_{J\uparrow}^2 \right] - \left[ \Lambda_{J\downarrow}^2 \right] \right) J_s \vec{1}$

Electric Polarization:  $\vec{P} = [V_P^2] \vec{\phi}_P = [V_P^2] \left( \left[ \Lambda_{P\uparrow}^2 \right] - \left[ \Lambda_{P\downarrow}^2 \right] \right) P_s \vec{1}$

Donald M Evans  
DOI: [10.1515/psr-2019-0067](https://doi.org/10.1515/psr-2019-0067)



# 6. Application Examples

## Processes with TMPT control

ESSIAL PROJECT

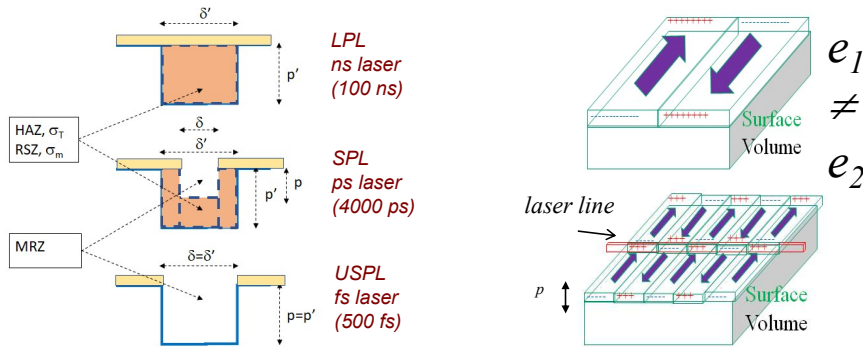

### Domains refinement by Surface Laser treatments

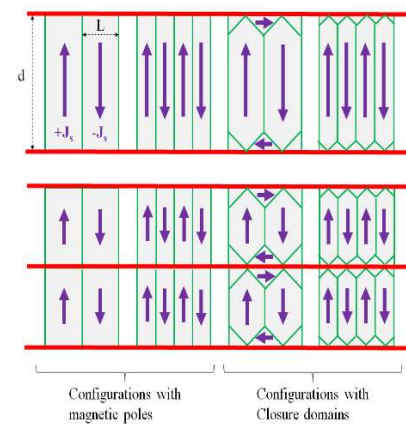

Microscopic impact of Scribing / ablation

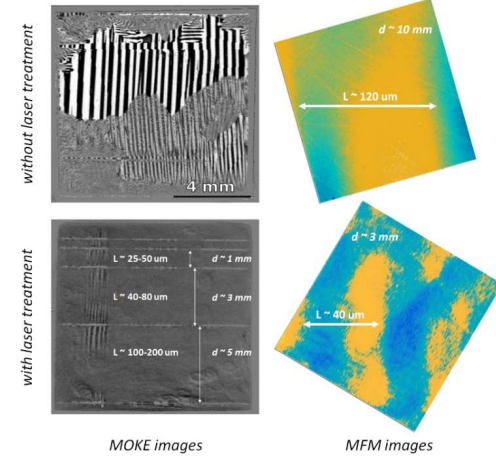

Loss reduction

| LASER | Max. loss reduction (%)<br>Thickness = 0,23/0,27 mm |         |         | Max. permeability<br>increase (%)<br>0,23 / 0,27 mm |         |       | Max. vibration<br>reduction (dB)<br>0,23 / 0,27 mm |       | coating             | Thermal<br>retention<br>(°C) | Coating<br>retention | Max.<br>speed<br>(mm/s) |
|-------|---|---------|---------|---|---------|-------|--|-------|---------------------|------------------------------|----------------------|-------------------------|
|       | i   | m       | s       | l   | m       | s     | i  | m     |                     |                              |                      |                         |
| I     | -20/-20   | -10/-5  | -20/-15 | +20/+15   | +10/+10 | -3/-2 | -10/-15  | -3/-3 | <i>a priori</i>     | 450                          | No                   | NA or 5                 |
| S     | -40/-20   | -10/-5  | -20/-15 | +30/+25   | 0       | -4/-3 | -15/-15  | -6/-6 | <i>a posteriori</i> | 550                          | No                   | 125                     |
| A     | -50/-35   | -25/-20 | -20/-15 | +40/+35   | -10/-20 | -5/-4 | -20/-20  | -6/-6 | <i>a posteriori</i> | >750                         | yes                  | >125                    |

I: CW/LPL Long Pulsed Laser Irradiation  
S: SPL Short Pulsed Laser Scribing  
A: USPL Ultra-Short Pulsed Laser Ablation

Losses: (i) 0,1T / (m) 1T-50Hz / (s) 1,7T-50Hz  
Permeability: (i) 0,1T / (m) 1T-50Hz / (s) 800 A/m-50Hz  
Vibrations: (i) 0,25T / (m) 1T

Noise reduction

# 6. Application Examples

## Magnetic cores

**Cores with various shapes**  
(permeability spectra)



**Accurate Sensors**  
(sensitivity factor)

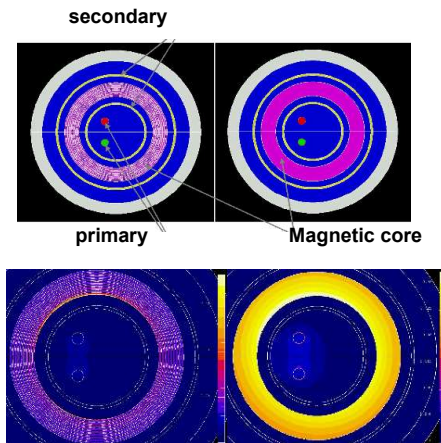

**Classical magnetic components**  
(impedance, losses, yield ...)

transfos, Motors, generators ...

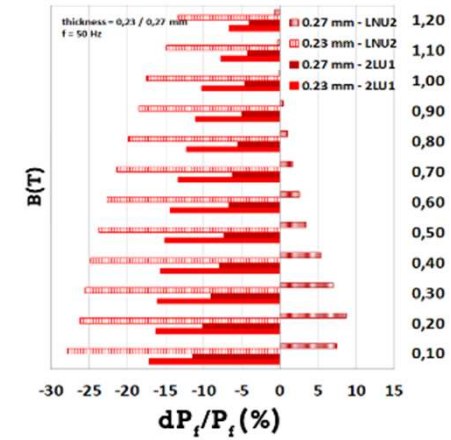
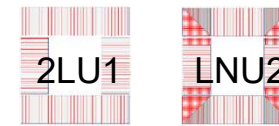

Chokes



Circuit breakers,  
pulse transformers,  
current transformers,  
actuators

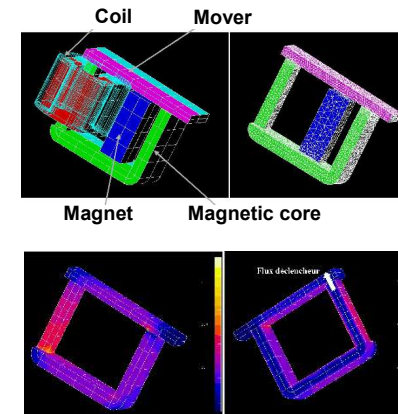
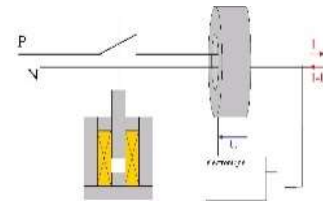

**Sensitive Actuators**  
(threshold )

# 7. Discussions

# Theory v.s. Observations

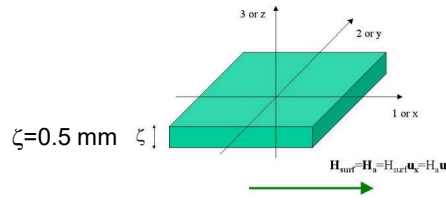

## GOES model

$$K_{an} = K_{an} \mathbf{u}_{an} = K_{an} (1, 0, 0)^T$$

$$\kappa = (C_{an}/C_{ex}) * (K_{an}/\gamma_w)^2 + (C_{\lambda s}/C_{ex}) * (K_{an}/\gamma_w)^2 (9\lambda^2 C/4K_{an}) - (C_{\lambda s}/C_{ex}) * (K_{an}/\gamma_w)^2 (3\lambda s/2K_{an}) \text{ defines the space variations of } [V^2] = [A^2]^{-1}.$$

$$[V^2] = [A^2]^{-1} ?$$

$$[A^2(z)] = \begin{bmatrix} \Lambda_{11}^2 & 0 & 0 \\ 0 & \Lambda_{22}^2 & 0 \\ 0 & 0 & \Lambda_{33}^2 \end{bmatrix}$$

$$(\partial_z^2 - \kappa_{ii}(1 + \tau_{ii}\partial_t)) V_{ii}^2 = 0$$

$$\kappa_{an} = \frac{C_{an}}{C_{ex}} \left(\frac{K_{an}}{\gamma_w}\right)^2 (= 4/(\zeta)^2 \text{ mm}^{-2})$$

Solution:

$$V_{ii}^2(z) = V_{ii0}^2 \frac{\cosh\left(\frac{\sqrt{\kappa_{ii}(1 + j\tau_{ii}\omega)}z}{2}\right)}{\cosh\left(\frac{\sqrt{\kappa_{ii}(1 + j\tau_{ii}\omega)}\zeta}{2}\right)}$$

$\Lambda_{110} = 100 \mu\text{m}, \Lambda_{220} = \Lambda_{330} = 200 \mu\text{m}, \Lambda_{120} = \Lambda_{130} = \Lambda_{230} = 10000 \mu\text{m} \gg,$   
at the surface.

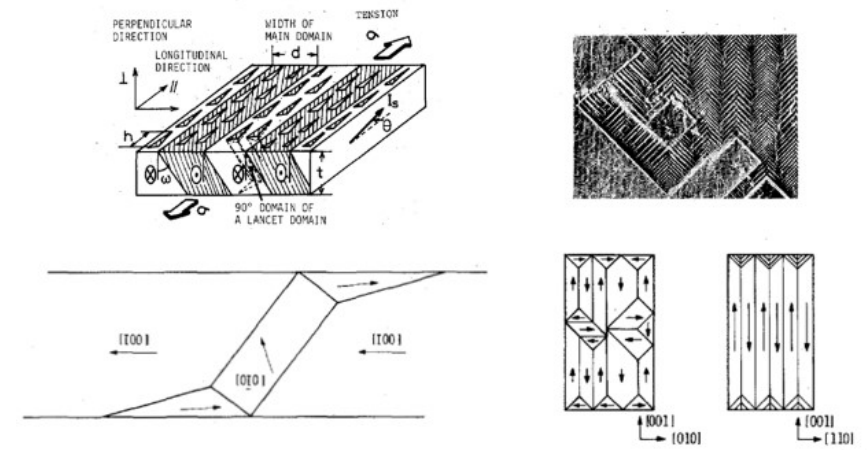
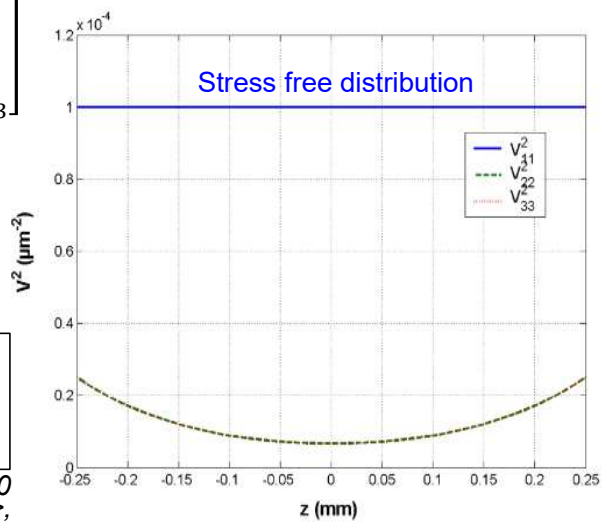

J.W. Shilling, JR. L. Houze, "Magnetic properties and domain structure in grain-oriented 3% Si-Fe", *Trans. on Magnetics*, vol. MAG-10, no. 2, pp. 195, 1974.  
Masaaki Inamura, "AC magnetostriction in Si-Fe single crystal close to (110)[001]", *IEEE Transactions on Magnetics*", vol. MAG-19, no. 1, january 1983.

O. Maloberti, M. Nesser, E. Salloum, S. Panier, J. Fortin, P. Dassonville, C. Pineau, T. Nguyen, J-P. Birat, I. Tolleneer, "The Tensor Magnetic Phase Theory for mesoscopic volume structures of soft magnetic materials - Quasi-static and dynamic vector polarization, apparent permeability and losses", *conférence SMM 24<sup>th</sup>*, Poznan, Poland, 2019.



# 7. Discussions: Theory v.s. Measurements

## GOES with different thicknesses

$$V_{11}^2(z) = V_{110}^2 \frac{\cosh(\sqrt{\kappa_{11}(1+j\tau_{11}\omega)}z)}{\cosh(\frac{\sqrt{\kappa_{11}(1+j\tau_{11}\omega)}\zeta}{2})}$$

$$\vec{\mu}_{app} = \frac{v^{-1}}{\zeta} \left( \int_{-\frac{\zeta}{2}}^{+\frac{\zeta}{2}} [V^2] dz \right) [\Lambda_0^2] \left[ [1] + j\sigma[\Lambda_0^2]v^{-1}\omega \right]^{-1} \frac{\vec{H}_a}{H_a}$$

$$\langle \xi \rangle_r \rangle_t = \pi \langle \vec{H}_{surf} \langle \partial_t \vec{J} \rangle_r \rangle_t \left( d\omega \langle |\vec{J} \rangle_r|^2 \right)^{-1}$$

O. Maloberti, M. Nesser, E. Salloum, S. Panier, J. Fortin, P. Dassonville, C. Pineau, T. Nguyen, J.-P. Birat, I. Tolleneer, "The Tensor Magnetic Phase Theory for mesoscopic volume structures of soft magnetic materials - Quasi-static and dynamic vector polarization, apparent permeability and losses.", *ELSEVIER Journal of Magnetism and Magnetic Materials*, vol. 502 (May 2020), 166403, <https://doi.org/10.1016/j.jmmm.2020.166403>

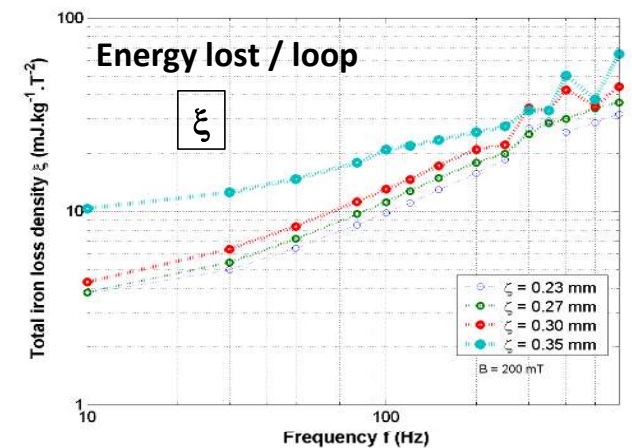
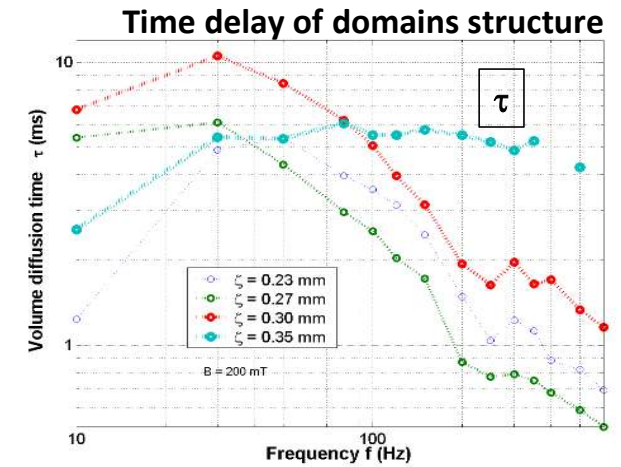
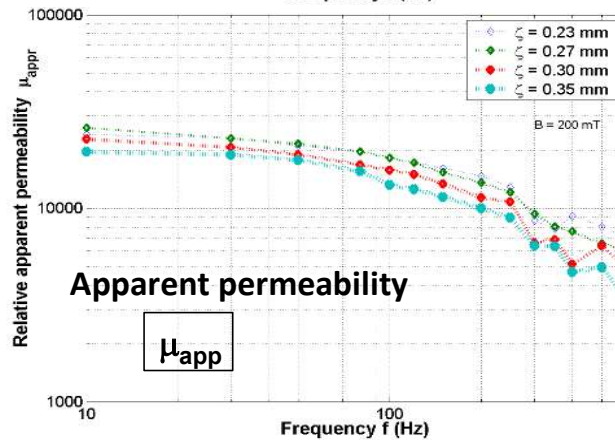
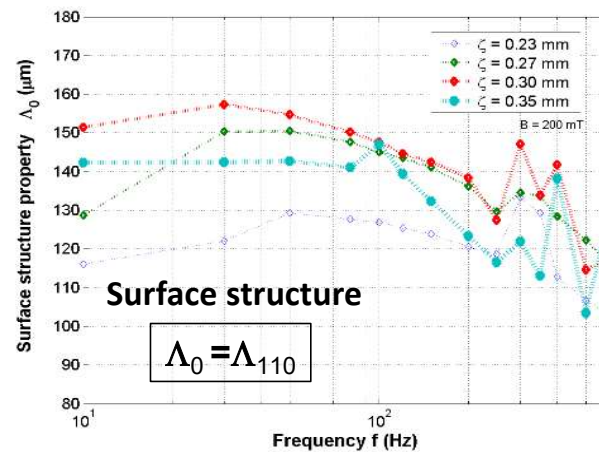

## 7. Conclusion and Forthcoming

---

- Results: Invariant Energy Formulation for the
  - Geometry, field and stress dependant domains and flux at long distance
  - Variability of magnetic domains with phases, dynamics and losses
  - Anisotropic behaviour intrinsic in the tensor variables
- Forthcoming:
  - Couple NL TMPT and classical fields at boundaries and in the volume
  - Consider Variability, *i.e.* different types of anisotropy (cubic ...)
  - Rebuild vector Hysteresis loops with memory and dynamics ...
  - Dual wave equations at high frequencies (BN noise, spin waves ...)





**ESSIAL**

**Thank you**



**OLIVIER MALOBERTI**  
**Materials of Electrical Engineering**  
**(0033-6-46-39-19-23)**  
**[olivier.maloberti@unilasalle.fr](mailto:olivier.maloberti@unilasalle.fr)**  
**[olivie.maloberti@gmail.com](mailto:olivie.maloberti@gmail.com)**



# TENSOR PARAMETERS

## MAGNETOSTRICTION

$$[\varepsilon] = \frac{3}{2} \begin{bmatrix} \lambda_{100} \left( \alpha_1^2 - \frac{1}{3} \right) & \lambda_{111} \alpha_1 \alpha_2 & \lambda_{111} \alpha_1 \alpha_3 \\ \lambda_{111} \alpha_2 \alpha_1 & \lambda_{100} \left( \alpha_2^2 - \frac{1}{3} \right) & \lambda_{111} \alpha_2 \alpha_3 \\ \lambda_{111} \alpha_3 \alpha_1 & \lambda_{111} \alpha_3 \alpha_2 & \lambda_{100} \left( \alpha_3^2 - \frac{1}{3} \right) \end{bmatrix} \rightarrow \mathbf{u}_{s\varepsilon} = + \frac{3}{2} \frac{[\vec{m} \otimes \vec{m}]}{M_s^2} \circ \left( [\lambda] \div [\mathbf{s}] \div \frac{[\vec{m} \otimes \vec{m}]}{M_s^2} \right) \text{ with } [\lambda] = \begin{bmatrix} \lambda_{100} & \lambda_{111} & \lambda_{111} \\ \lambda_{111} & \lambda_{100} & \lambda_{111} \\ \lambda_{111} & \lambda_{111} & \lambda_{100} \end{bmatrix}$$

$$\mathbf{u}_{\lambda\varepsilon} = - \frac{9}{4} \frac{[\vec{m} \otimes \vec{m}]}{M_s^2} \circ \left( [\lambda^2] \div [\mathbf{C}] \div \frac{[\vec{m} \otimes \vec{m}]}{M_s^2} \right) \text{ with } [\lambda^2] = \begin{bmatrix} \lambda_{100}^2 & \pm \lambda_{111}^2 & \pm \lambda_{111}^2 \\ \pm \lambda_{111}^2 & \lambda_{100}^2 & \pm \lambda_{111}^2 \\ \pm \lambda_{111}^2 & \pm \lambda_{111}^2 & \lambda_{100}^2 \end{bmatrix}$$

## STIFFNESS

$$\begin{pmatrix} \sigma_1 \\ \sigma_2 \\ \sigma_3 \\ \sigma_4 \\ \sigma_5 \\ \sigma_6 \end{pmatrix} = \begin{pmatrix} C_{11} & C_{12} & C_{13} & C_{14} & C_{15} & C_{16} \\ C_{21} & C_{22} & C_{23} & C_{24} & C_{25} & C_{26} \\ C_{31} & C_{32} & C_{33} & C_{34} & C_{35} & C_{36} \\ C_{41} & C_{42} & C_{43} & C_{44} & C_{45} & C_{46} \\ C_{51} & C_{52} & C_{53} & C_{54} & C_{55} & C_{56} \\ C_{61} & C_{62} & C_{63} & C_{64} & C_{65} & C_{66} \end{pmatrix} \begin{pmatrix} \varepsilon_1 \\ \varepsilon_2 \\ \varepsilon_3 \\ \varepsilon_4 \\ \varepsilon_5 \\ \varepsilon_6 \end{pmatrix}$$

Orthotropic material

$$\begin{bmatrix} \varepsilon_1 \\ \varepsilon_2 \\ \varepsilon_3 \\ \varepsilon_4 \\ \varepsilon_5 \\ \varepsilon_6 \end{bmatrix} = \begin{bmatrix} \frac{1}{E_1} & -\frac{\nu_{21}}{E_2} & -\frac{\nu_{31}}{E_3} & 0 & 0 & 0 \\ -\frac{\nu_{12}}{E_1} & \frac{1}{E_2} & -\frac{\nu_{32}}{E_3} & 0 & 0 & 0 \\ -\frac{\nu_{13}}{E_1} & -\frac{\nu_{23}}{E_2} & \frac{1}{E_3} & 0 & 0 & 0 \\ 0 & 0 & 0 & \frac{1}{2G_{23}} & 0 & 0 \\ 0 & 0 & 0 & 0 & \frac{1}{2G_{13}} & 0 \\ 0 & 0 & 0 & 0 & 0 & \frac{1}{2G_{12}} \end{bmatrix} \begin{bmatrix} \sigma_1 \\ \sigma_2 \\ \sigma_3 \\ \sigma_4 \\ \sigma_5 \\ \sigma_6 \end{bmatrix}$$

$$[\mathbf{C}] = \begin{bmatrix} C_{11} - C_{12} & & C_{44} & & C_{55} \\ & C_{44} & & & \\ C_{44} & & C_{22} - C_{23} & & C_{66} \\ & & & C_{66} & \\ C_{55} & & & & C_{33} - C_{13} \end{bmatrix}$$

## VECTOR & TENSOR OPERATORS

$$[Y] = [\vec{Y}_1, \vec{Y}_2, \vec{Y}_3] = \begin{bmatrix} Y_{11} & Y_{12} & Y_{13} \\ Y_{21} & Y_{22} & Y_{23} \\ Y_{31} & Y_{32} & Y_{33} \end{bmatrix}, \quad [n] = [\vec{n}, \vec{n}, \vec{n}] : [Y]^T \text{ means to transpose the matrix } [Y]$$

$$[\vec{\nabla}](\vec{A}) = [\vec{\nabla} \otimes \vec{A}], \quad [[\vec{\nabla}](\vec{A})]_{ij} = [\vec{\nabla} \otimes \vec{A}]_{ij} : \text{tensor gradient on a vector}$$

$$\vec{\nabla} \cdot [Y] = (\vec{\nabla} \cdot \vec{Y}_1, \vec{\nabla} \cdot \vec{Y}_2, \vec{\nabla} \cdot \vec{Y}_3)^T : \text{vector divergence on a tensor}$$

$$[\vec{\nabla}] \times [Y] = [\vec{\nabla} \times][Y] = [\vec{\nabla} \times \vec{Y}_1, \vec{\nabla} \times \vec{Y}_2, \vec{\nabla} \times \vec{Y}_3]^T : \text{tensor rotational on a tensor}$$

$$[\Delta][Y] = [\vec{\Delta}(\vec{Y}_1), \vec{\Delta}(\vec{Y}_2), \vec{\Delta}(\vec{Y}_3)]^T : \text{tensor Laplacian on a tensor}$$

$$\vec{\nabla} \cdot = (\partial_1 \cdot, \partial_2 \cdot, \partial_3 \cdot)^T : \text{Nabla operator}$$

$$\vec{\Delta} \cdot = (\partial_1 \partial_1 \cdot, \partial_2 \partial_2 \cdot, \partial_3 \partial_3 \cdot)^T : \text{Laplacian operator}$$

## VECTOR & TENSOR OPERATIONS

$[\vec{A} \otimes \vec{B}], [\vec{A} \otimes \vec{B}]_{ij} = A_i B_j$ : tensor product between two vectors. ¶

$[[Y] \cdot [Z]], [[Y] \cdot [Z]]_{ij} = Y_{ij} Z_{ij}$ : tensor product type 1 between 2 tensors. ¶

$[[Y] \times [Z]] = [\vec{Y}_1 \times \vec{Z}_1, \vec{Y}_2 \times \vec{Z}_2, \vec{Y}_3 \times \vec{Z}_3]^T$ : tensor product type 2 between 2 tensors. ¶

$([Y] \cdot [Z]) = (\vec{Y}_1 \cdot \vec{Z}_1, \vec{Y}_2 \cdot \vec{Z}_2, \vec{Y}_3 \cdot \vec{Z}_3)^T, ([Y] \cdot^2) = ([Y] \cdot [Y])$ : vector product between 2 tensors. ¶

$[Y] \circ [Z] = Y_{ij} Z_{ij}$ : scalar product between two tensors. ¶

## VECTOR & TENSOR PROPERTIES

$$[\vec{\nabla} \times][\vec{\nabla} \times][Y] = [\vec{\nabla}](\vec{\nabla} \cdot [Y]) - [\Delta][Y]$$

$$[X] \cdot ([Y] \times [Z]) = [Z] \cdot ([X] \times [Y]) = [Y] \cdot ([Z] \times [X])$$

$$\vec{\nabla} \cdot ([Y]\vec{A}) = (\vec{\nabla} \cdot [Y]) \cdot \vec{A} + [Y] \circ [\vec{\nabla} \otimes \vec{A}]$$

$$\iint_{\Omega} (\vec{\nabla} \cdot \vec{A}) d^3x = \oiint_{\partial\Omega} (\vec{A} \cdot \vec{n}) d^2x$$

$$\iint_{\Omega} (\vec{\nabla} \times \vec{A}) d^3x = \oiint_{\partial\Omega} -(\vec{A} \times \vec{n}) d^2x$$

$$\iint_{\Omega} (\vec{\nabla} \cdot [Y]) d^3x = \oiint_{\partial\Omega} ([Y] \cdot \vec{n}) d^2x$$

$$\iint_{\Omega} ([\vec{\nabla}] \times [Y]) d^3x = \oiint_{\partial\Omega} -([Y] \times \vec{n}) d^2x$$

$$\iint_{\Sigma} ([\vec{\nabla}] \times [Y]) d^2x = \oint_{\partial\Sigma} ([Y] \cdot \vec{n}) dx$$



## TOWARDS SATURATION

### Limit study

$$\vec{\varphi}_j = \left( \left[ \Lambda_{j\uparrow}^2 \right] - \left[ \Lambda_{j\downarrow}^2 \right] \right) J_s \vec{1}$$

$$\vec{J} = [V_j^2] \vec{\varphi}_j = [V_j^2] \left( \left[ \Lambda_{j\uparrow}^2 \right] - \left[ \Lambda_{j\downarrow}^2 \right] \right) J_s \vec{1}$$

$$\left( \left[ \Lambda_{j\uparrow}^2 \right] - \left[ \Lambda_{j\downarrow}^2 \right] \right) J_s \vec{1} \xrightarrow{\text{saturation}} \left[ \Lambda_j^2 \right] \vec{J}_s$$

$$\vec{J} \xrightarrow{\text{saturation}} [V_j^2] \left[ \Lambda_j^2 \right] \vec{J}_s = \vec{J}_s$$

#### Mechanisms & Limits

| GO grain orientation  | GO grain 0°   | GO grain θ°   | GO grain 0°  |   |
|---|---|---|--|---|
| Magnetic polarization direction   | RD  | RD  | TD   |   |
| Polarization components   | $J_{  } \rightarrow J_s$<br>$J_{\perp} \rightarrow 0$ | $J_{  } \rightarrow J_s \cos \theta$<br>$J_{\perp} \rightarrow J_s \sin \theta$ | $J_{\perp} \rightarrow J_s$<br>$J_{  } \rightarrow 0$                          |   |
| Walls density   | $n_{wa} < n_w$  | $\rightarrow 0$   |  |   |
| Walls surface   | $A_w < S_w$   | $\rightarrow \infty$  |  |   |
| Walls mobility  | $\eta_w$  | $\rightarrow \infty$  |  |   |
| Domains autocorrelation surface   | $S_{DMR}$   | $\rightarrow 0$   | $\rightarrow \alpha \zeta g$   | $\rightarrow 0$                           |
| <b>• Domain Walls Displacement</b>  |   |   |  |   |
| $\Lambda_{DWD} = \sqrt{\frac{n_w S_w J_s}{2 \eta_w n_{wa}^2 A_w^2 (J_s^2 - J_s^2)}} \left( \frac{\partial_t J_{  } - \frac{J_{  } \cdot \partial_t (\sqrt{J_s^2 - J_s^2})}{\sqrt{J_s^2 - J_s^2}}}{\partial_t B_{  }} \right)$ |   | $\rightarrow \frac{0}{0} = \text{finite}$                                       | $\rightarrow \frac{0}{0} = \text{finite}$                                      | $\rightarrow 0$                           |
|   |   | $\rightarrow 0$<br>Classical limit  | $\rightarrow 0$<br>Classical limit   |   |
| <b>• Domains Magnetic Rotation</b>  |   |   |  |   |
| $\Lambda_{DMR} = \sqrt{S_{DMR} \frac{J_s^2}{J_s^2 - J_s^2} \left( \frac{\partial_t J}{\partial_t B} \right)}$   |   | $\rightarrow 0$   | $\rightarrow \alpha \zeta g \tan \theta$<br>$\rightarrow 0$<br>Classical limit | $\rightarrow \frac{0}{0} = \text{finite}$ |

$$\eta_w = \frac{8\pi^2 S_w J_{s\perp}}{\sigma J_s^2} \left( \iiint \left( \iint_w \frac{(z - z_w)}{|r - r_w|^3} d^2 \right)^2 d^3 r \right)^{-1}; \quad S_{DMR} = \frac{n_d}{4\pi} \iiint_d \iiint_d G(r', r) d^3 r' d^3 r, \quad G \text{ is the Green function}$$

$J_s \approx 2 \text{ T}$  (saturation polarisation),  $n_w$ : walls volume density,  $\eta_w$ : wall mobility,  $S_w$ : wall area  
 $n_{wa}$ : active walls volume density,  $\eta_{wa}$ : active wall mobility,  $A_w$ : wall effective area,  $g$ : grain size,  $\theta$ : grain orientation ( $-7^\circ < \theta < 7^\circ$ )

# CONTACTS

---

**OLIVIER MALOBERTI**  
Research Fellow

Materials of Electrical Engineering

Tél. 0033-6-46-39-19-23

@

[olivier.maloberti@unilasalle.fr](mailto:olivier.maloberti@unilasalle.fr)

[olivie.maloberti@gmail.com](mailto:olivie.maloberti@gmail.com)

**MANAR NESSER**

Research Fellow

[Manar.nesser@unilasalle.fr](mailto:Manar.nesser@unilasalle.fr)

**PRESCILLIA DUPONT**

Post-Doc Researcher

[Prescillia.dupont@unilasalle.fr](mailto:Prescillia.dupont@unilasalle.fr)

**ELIAS SALLOUM**

Research Fellow - Lebanon

[salloumelias.es@gmail.com](mailto:salloumelias.es@gmail.com)