



HAL
open science

Analysis of the U.S. Onion Industry with a Focus on New York State Issues

Philippe Jeanneaux

► **To cite this version:**

Philippe Jeanneaux. Analysis of the U.S. Onion Industry with a Focus on New York State Issues. VetagroSup; UMR Territoires; Cornell University CALS. 2023, pp.1-256. hal-04536962

HAL Id: hal-04536962

<https://hal.science/hal-04536962>

Submitted on 8 Apr 2024

HAL is a multi-disciplinary open access archive for the deposit and dissemination of scientific research documents, whether they are published or not. The documents may come from teaching and research institutions in France or abroad, or from public or private research centers.

L'archive ouverte pluridisciplinaire **HAL**, est destinée au dépôt et à la diffusion de documents scientifiques de niveau recherche, publiés ou non, émanant des établissements d'enseignement et de recherche français ou étrangers, des laboratoires publics ou privés.



Distributed under a Creative Commons Attribution - NoDerivatives 4.0 International License

Agri-Cluster Retention and Expansion (ACRE) Program

Analysis of the U.S. Onion Industry with a Focus on New York State Issues

Working Paper

Philippe Jeanneaux

Professor of Rural Economics VetAgro Sup
Visiting Fulbright scholar, 2020-21
Visiting Fellow Cornell University
Department of Global Development
ACRE Project Technical Consultant

Ithaca, February 2023

The designations employed and the presentation of material in this information product do not imply the expression of any opinion whatsoever on the part of the Lyson Center, Cornell University, or VetAgro Sup concerning the legal or development status of any country, territory, city, or area or its authorities, or concerning the delimitation of its frontiers or boundaries. The mention of specific companies or products of manufacturers, whether or not these have been patented, does not imply that these have been endorsed or recommended by the Lyson Center, Cornell University, or VetAgro Sup in preference to others of a similar nature that are not mentioned.

The views expressed in this information product are those of the author, Philippe Jeanneaux, and do not necessarily reflect the views or policies of the Lyson Center, Cornell University, or VetAgro Sup.

Contents

Contents	3
List of figures	7
List of pictures	9
List of map	10
List of tables	10
Acknowledgments	13
How to Use This Report	15
Executive Summary	16
Keywords:	19
Ten Key Factual Highlights	20
Introduction	22
Methodological Clarifications	24
1. New York State Muck Onion Industry Situation Analysis	25
1.1. The New York State Muck Onion Issues.....	25
1.1.1. Production and market issues.....	25
1.1.2. New York onion operations issues	30
1.2. What’s Special About New York Muck Onions?	33
1.3. The “Terroir” of New York muck onions.....	34
1.4. Interest in exploring the development of a statewide muck onion value chain	37
1.5. Summary of Section 1 and rationale for the report's outline	40
2. The Global Onion Market	41
2.1. Worldwide Production	42
2.2. Overview of global trade and the U.S. position	44
2.3. Canadian onion exports to New York: unfair competition or not?.....	57
2.3.1. The arguments of the controversy.....	57
2.3.2. Support for biofood exports.....	60
2.3.3. Price Pooling Program	63
2.3.4. Onion trade between Canada and The U.S.: a complex regional market.....	66
2.4. Summary of Section 2.....	69

3. U.S. onion production and market	71
3.1. U.S. fresh onion production and market	71
3.2. Onion production at the state level	79
3.3. Summary of Section 3	83
4. Focus on Onion Prices.....	85
4.1. Focus on price at the farm gate.....	87
4.2. Focus on cost at the farm gate and competition between sweet and pungent onion...98	
4.3. Focus on prices at the shipping point.....	100
4.4. Focus on terminal (wholesale) market prices	106
4.5. Focus on retail prices	117
4.6. Summary of Section 4.....	127
5. Price transmission analysis (From farm gate to retail)	130
5.1. Introduction	130
5.2. Data description and Sources	130
5.3. Evolution of the price distribution at three stages	132
5.4. What is asymmetric price transmission?.....	134
5.5. Data description and methodology	137
5.6. Time series econometrics analysis	140
5.6.1. Model for measuring price transmission	140
5.6.2. Step 1: Stationarity Test	141
5.6.2.1. Tests analyzing the relation between PPI and TPI time series	142
5.6.2.2. Test of stationarity	144
5.6.2.3. The Augmented Dickey-Fuller (ADF) Test for Shipping price (PPI)	145
5.6.2.4. The Augmented Dickey-Fuller (ADF) Test for terminal market price (TPI).....	146
5.6.3. Step 2: Test of co-integration between the three price series	149
5.6.4. Step 3: Causality analysis between prices series	152
5.6.4.1. First analysis: focus on causality between PPI and TPI.....	153
5.6.4.2. Second Analysis: Focus on causality between Terminal Market Price (TPI) and Retail Price (RPI).	159
5.7. Conclusion of Section 5	161
6. Vidalia case	163
6.1. Framework for analyzing a value food chain.....	163
6.1.1. Creating value.....	166

6.1.2.	Distributing value	167
6.1.3.	Setting up of lasting competitive advantage	168
6.1.4.	Second analytical grid: Governance	170
6.2.	The Vidalia case study	171
6.2.1.	Data to study the Vidalia onion industry	172
6.2.2.	The history of the Vidalia onion in a nutshell	173
6.2.3.	Surplus creation mechanism	175
6.2.3.1.	A terroir to produce a unique onion	176
6.2.3.2.	Segmentation through grading and supply control	186
6.2.3.3.	The key role of Vidalia onion promotion	189
6.2.3.4.	A relevant strategy to create surplus	194
6.2.4.	Surplus distribution mechanism	197
6.2.4.1.	Two main drivers organize pricing distribution	197
6.2.4.2.	Is Vidalia onion production profitable?	201
6.2.5.	The process to protect the Vidalia onion competitive advantage	202
6.2.5.1.	First action: The legal Vidalia onion-growing area	203
6.2.5.2.	Second action: A registered trademark to protect the Vidalia onion system from rivals (internal and external)	204
6.2.6.	What are the institutions that govern competitive advantage?	205
6.3.	Conclusion of Section 6	208
7.	New York Muck Onion Marketing Project: Two simulations for calculating the expected change	210
7.1.	Context and Issues yielding two economic simulations	210
7.1.	A partial budget for calculating the expected change in profit from a new muck onion brand in the farm business	213
7.1.1.	Principles	213
7.1.2.	Application to New York muck onion project	214
7.1.2.1.	The issue	214
7.1.2.2.	A potential alternative	214
7.1.2.3.	Case study: Operation with 1,500 acres in “Mucksoil County” in New York ..	215
7.1.2.4.	Collect data and information	215
7.1.2.5.	A cost/Benefit analysis with a Partial Budget	219
7.1.2.6.	Consideration of non-economic elements (Table of non-quantifiable items) 219	

7.1.2.7.	Consideration of random events (Gain and Loss Matrix)	220
7.1.2.8.	Conclusion: What is the “Tioga Farms Bros” consider decision?	221
7.2.	Exploring the impact of some changes in the New York Onion Value Chain	222
7.2.1.	Issues yielding an economic contributions of onion production	222
7.2.2.	Applied research Methods	223
7.2.3.	The framework: Input-Output Model	224
7.2.4.	The Muck onion industry and assumptions to apply the Input-Output Model	227
7.2.5.	Implementation of scenarios and data	231
7.2.5.1.	Scenario to estimate the economic impact of the branded onion scenario ..	232
7.2.5.2.	Settings to estimate an economic impact of the “Shift to corn” scenario	233
7.3.	Results.....	236
7.3.1.	Scenario 1: The branded onion scenario, an economic impact of changes in the onion sector.....	236
7.3.1.1.	Impact Estimates.....	236
7.3.1.2.	Distribution of Impacts	238
7.3.2.	Scenario 2: The “Shift to corn” scenario, an economic impact of changes in the onion sector.....	241
7.3.2.1.	Impact Estimates.....	241
7.3.2.2.	Distribution of Impacts	242
7.4.	Summary of Section 7.....	245
General Conclusion		247
Key Observations.....		247
Recommendations		250
References.....		252

List of figures

Figure 1. Area Harvested & production 1960-2010 New York State (source: USDA. NASS)	26
Figure 2. Onion Yield (Cwt/acre) 1960-2010 - U.S. vs NY State (source: USDA. NASS)	27
Figure 3. Area harvested (Acres) & Production Onion (All types) (1,000 cwt) U.S./NY State 1960-2010 Source: USDA. National Agricultural Statistics Service	28
Figure 4. Production Shared NYS/USA 1960-2019 – (Source: USDA. NASS).....	29
Figure 5. The New York pungent onion “Terroir” triangle.....	37
Figure 6. Onion types in the U.S.....	41
Figure 7. Global onion production trends (1997-2016) - FAOSTAT	43
Figure 8. Overview of the global onion market (2017). Sources: FAOSTAT & AtlasBig.....	44
Figure 9. U.S. Onions: Import vs Export - 1970/2019 - Source (USDA- Economic research service)	45
Figure 10. Prices of onions imported by the U.S. from 3 main countries - 2016 to 2019 - Import sources by value/volume (\$/1,000 lbs) (USDA)	47
Figure 11. U.S. Onion import 2016 to 2020 (USDA).....	48
Figure 12. Prices of onions Exported by the U.S. from three main countries - 2016 to 2019 - Import sources by value/volume (\$/1,000 lbs) (USDA)	49
Figure 13. U.S. Onion export 2016 to 2020 (USDA)	50
Figure 14. Deterioration of the balance of trade - Onion Fresh 2008/2019 (USDA)	51
Figure 15. Evolution of Onion U.S. Balance of Trade 2010/2019 (USDA)	52
Figure 16. Evolution of Onion production in Mexico 2012/2019 (FAO)	54
Figure 17. Area Harvested & production 1960-2020 USA (Source: USDA - National Agricultural Statistics Service (NASS)).....	71
Figure 18. Onion Yield (Cwt/acre) 1960-2020 USA (source: USDA - NASS)	72
Figure 19. Production (Cwt) 1990-2020 USA (source: USDA - NASS)	73
Figure 20. Production (1,000Cwt) & total farm value (\$1,000) 2010-2020 USA	74
Figure 21. U.S. fresh onions: supply - 1970/2019 (USDA- Economic research service).....	75
Figure 22. U.S. fresh onions: Availability - 1970/2019 (USDA- Economic research service)	76
Figure 23. Onion, fresh market: Share of supply exported by USA 1980-2019.....	77
Figure 24. Onion, fresh market: Share of availability imported by USA 1980-2019 (Source: USDA, Economic Research Service).....	77
Figure 25. Onions for fresh market and processing: Area harvested by State 2016-2020.....	80
Figure 26. Onions for fresh market and processing: Total production by State 2016-2020 (NASS/USDA)	81
Figure 27. Value of utilized production (\$1,000) per State - 2019 (USDA)	82
Figure 28. Evolution Onion in the U.S.A by State, 1,000 Cwt (2000-2019).....	83
Figure 29. Description of the main partners of the onion sector in the U.S.....	85
Figure 30. Onion growers supply chain (Source: Interview ACRE Meeting January 2021).....	86
Figure 31. Onion Current Price at Farm Gate USA 1970-2019 (source: USDA - NASS).....	87
Figure 32. Onion Current Price at Farm Gate - USA 2000-2019 (source: USDA - NASS).....	88
Figure 33. Onions Producer Price Index - U.S. Base year 1982=100 – 2000 to 2019 (USDA)	88
Figure 34. Onions Producer Price Index per month - U.S. Base year 1982=100 – 2000 to 2019 (USDA)	90

Figure 35. PPI for all fresh vegetables, except potatoes (2016-2019) Base year 1982=100 (USDA)	90
Figure 36. The Cobweb process	92
Figure 37. Onion Current and Constant Price at Farm Gate USA 1980-2019 - base 100: 2012 (source: USDA, NASS)	93
Figure 38. Onion Current Price at Farm Gate NYS/USA 1970-2019	94
Figure 39. Onion Constant Price Base 100 (2012) New York State/U.S.A 1970-2019 (source: USDA, NASS)	95
Figure 40. Monthly average "Low Price" Shipping point price - Yellow Globe type NYC Sack 50lbs. Med (\$/50 lbs.) (USDA Market News)	103
Figure 41. Prices at shipping point (High & Low Price) - Yellow Onion Dry Sack 50 lbs. (New York City shipping point: 290 records) 2010-2020 (USDA Market news)	104
Figure 42. Recap of Available Shipping Point Onions Price - 2017/2021 for three different origins - \$/50lbs (Source: Federal - State Market News Service, USDA "Mostly or Midpoint of mostly range)	106
Figure 43. Onion Terminal Market price (\$/1lb) Yellow med 2 1/4" sack 50lbs 2008-2020	109
Figure 44. Onion Globe type Terminal Market price (\$/1cwt) Yellow med 2 1/4" sack 50lbs Canada vs NYS Origin 2008-2019 (New York Shipping) (USDA)	110
Figure 45. Terminal Market prices comparison - NY State vs Canada (origin) (\$/cwt) Yellow med 2 1/4" sack 50lb 2010-2019 (New York Shipping) (USDA)	111
Figure 46. Onion Globe type Terminal Market price for 50 lbs (\$/50lb) Yellow mid size & all Package - Canada Origin Season: 2019/2020 - New York Shipping (USDA)	112
Figure 47. Onion Globe type Terminal Market price (\$/50lb) Yellow Med Size sack 50lb Canada Origin Season 2019/2020 (New York Shipping) (USDA)	113
Figure 48. Onion Globe type Terminal Market price for 50 lbs (\$/50lb) Yellow mid size & all Package - New York State Origin - Season: 2019/2020 - New York Shipping (USDA)	114
Figure 49. Yellow Onion (Globe Type) - Monthly Summary of Daily Wholesale to Retail Market Prices Wholesale-Montreal - \$US/50lbs (Agriculture and Food Canada)	115
Figure 50. Onion Globe type Terminal Market price for 50 lbs (\$/50lb) Yellow Medium Size - NYS & Canada Origin - Season: 2019/2020 - New York and Philadelphia Shipping (USDA)	116
Figure 51. Monthly average Shipping point price vs Terminal Market price, 2011 to 2020	117
Figure 52. Price ranking in the U.S. for 50 Vegetables – Calculated from 2016 - USDA, Economic Research Service	119
Figure 53. Retail Price Nov 2010 – Sept 2020 for Yellow Dry Onion per year (437 obs.)	121
Figure 54. Retail Average smooth price (6 day-prices) 2011 - 2020 Yellow Onion (USDA) Current\$/pound (437 obs.)	122
Figure 55. Yellow Sweet Onion average daily price 2011 - 2020 per year \$ current/pound Northeast US region (USDA)	124
Figure 56. Retail Average smooth price (6 day-prices) for yellow Sweet Onion- \$ current Northeast US region 2011 - 2020 (USDA)	125
Figure 57. Retail Average Price 2011 - 2020 Current\$/pound - Northeast US region - Yellow onion vs Yellow Sweet onion (USDA)	126
Figure 58. Distribution of the value (in percent) between three stages of the supply chain Yellow onion (pungent) New York State and Northeast region - 2010 to 2020 - USDA	134

Figure 59. Symmetric Prices – General principles.....	135
Figure 60. Asymmetric Prices Transmission – General principles.....	136
Figure 61. Shipping Price (PPI) Sept/01/2010 to Jan/31/2021 – 305 units (USDA).....	138
Figure 62. Terminal market Price (PPI) Sept/01/2010 to Jan/31/2021 – 305 units (USDA).....	139
Figure 63. Retail level (RPI) - Sept/01/2010 to Jan/31/2021 – 305 units (USDA).....	140
Figure 64. Shipping price (PPI) and terminal market Price (TPI) - Sept/01/2010 to Jan/31/2021 – 305 units (USDA).....	142
Figure 65. Trends of percentage change in Shipping Price (PPI) and Terminal market Price.....	143
Figure 66. Terminal market price (TPI) and retail price (RPI) - Sept/01/2010 to Jan/31/2021 – 305 units (USDA).....	147
Figure 67. Trends of percentage change in Terminal market Price and Retail Price.....	148
Figure 68. Value Chain Framework (Jeanneaux, 2018).....	166
Figure 69. The history of Vidalia Onion.....	174
Figure 70. The “Terroir” triangle.....	176
Figure 71. Quality inspection within the Vidalia onion value chain.....	186
Figure 72. Retail Average Price 2011 - 2020 Current\$/pound - Northeast US region - Yellow onion vs Yellow Sweet onion (USDA).....	195
Figure 73. National Price (per pound) comparison at retail - Yellow Onion vs Yellow Marketed Sweet Onion April to December 2020 (USDA).....	196
Figure 74. Distribution of the value (in US\$/pound) between three stages of the Vidalia value chain (2020) – USDA.....	199
Figure 75. Distribution of the value (in percent) between three stages of the Vidalia value chain (2020) – USDA.....	200
Figure 76. Partial Budget principles.....	213
Figure 77. Indirect and induced output effects from demand at farm gate for a branded onion scenario, New York, dollars 2018.....	240
Figure 78. Indirect and induced output effects from demand decline at farm gate for onion, New York, dollars 2018.....	245

List of pictures

Picture 1. Example of communication to promote sweet onions as generic all-purpose onions.	30
Picture 2. Black dirt soil in New York State - Credit: Duncan Hilchey.....	36
Picture 3. Black dirt soil in New York State - Credit: Philippe Jeanneaux.....	36
Picture 4. Vidalia® onion aspect.....	177
Picture 5. Vidalia sandy soil.....	178
Picture 6. Vidalia sandy soil and water: Two crucial natural resources.....	179
Picture 7. Vidalia Onion Hand-planting.....	182
& Picture 8. Vidalia Onion Hand-planting.....	182
Picture 9. Vidalia Onion Hand-harvesting.....	182
Picture 10. Vidalia Onion Trademark.....	189
Picture 11. Illustrations of the range of products that use the Vidalia brand to promote their product.....	192

Picture 12. Georgia’s U.S. Senators Johnny Isakson and Saxby Chambliss in front of the Capitol before shipping their Vidalia onion to all 100 Senates offices	194
---	-----

List of map

Map 1. Muck soil location in New York State (by county)	35
Map 2. An example of the year-round strategy: Bland Farms, growing & shipping areas 2021...	56
Map 3. The Vidalia onion-growing district, centered around Toombs County, home to the town of Vidalia.....	180

List of tables

Table 1. Farms and acreage in New York (Census 2017, 2012, 2007, 2002) USDA	31
Table 2. Geographic distribution of farms and acreage in New York	32
Table 3. New York onion growers in 2017 Census of Agriculture.....	33
Table 4. New York Muck Onion Marketing—Project LEADERS.....	38
Table 5. The Shared Vision Statement of the project leaders’ group.....	38
Table 6. New York Muck Onion Industry SWOT Analysis.....	39
Table 7. Yearly production (million tons) of staple foods in 2019	44
Table 8. U.S. onion import 2016/2019 sources by value (\$1,000) & by volume (1,000 lbs) (USDA)	47
Table 9. U.S. Onion export sources by value (\$1,000) & by volume (1,000 lbs) (USDA)	49
Table 10. The key to year-round production – Bland Farms	57
Table 11. Canadian onion imports (value in US\$1,000) from three main countries - 2016 to 2019 - Statistics Canada	58
Table 12. Eligible activities and maximum financial assistance (\$Canadian) (2020)	62
Table 13. Canadian onion imports (value in US\$1,000) from eight main U.S. states - 2015 to 2019 - Statistics Canada and the U.S. Census Bureau.....	67
Table 14. Canadian onion exports (value in US\$1,000) to 10 main U.S. states - 2015 to 2019 - (U.S.) - Statistics Canada and the U.S. Census Bureau	68
Table 15. Canadian province onion exports to New York (and other countries) - 2015 to 2019 ..	69
Table 16. Shipment of yellow onion throughout the year in the U.S. (2018-2019)	91
Table 17. Prices and values of onion for 9 states and Canada at the farm gate - 2016 to 2019 (USDA and Agricultural Statistics for Ontario and Canada, OMAFRA).....	96
Table 18. Costs of production for four groups (5 states & Quebec & Mexico & Canada) at the farm gate - 2016 to 2019 (Extension services and our data collection)	100
Table 19. Prices at the shipping point - yellow, dry onion, 50 lb sack (New York City shipping point) 2010-2020 (USDA Market News).....	102
Table 20. Average “Low Prices” at the shipping point - yellow, dry onion, 50 lb sack	104
Table 21. Yellow onion prices at the New York Terminal Market - Comparison between origin and varieties -Yellow med 2 1/4" sack 50lb - \$/cwt (2008-2019) (New York Shipping) (USDA) ..	108
Table 22. Retail Price Nov 2010 – Sept 2020 for Yellow (not sweet) Onion (437 obs.).....	120

Table 23. Retail Price Nov 2010 – Sept 2020 for Sweet Onion (500 obs.) 500 prices (per pound) from 457,737 stores (min 14 stores / max 2787) Northeast US region (USDA)	123
Table 24. Descriptive statistics for the three price series: PPI, TPI, and RPI (2010-2019) – 305 price units	138
Table 25. Variance ratio test of PPI and TPI series.....	144
Table 26. Stationary test of PPI and TPI series.....	145
Table 27. Augmented Dickey-Fuller (ADF) Test for Shipping price (PPI)	146
Table 28. Augmented Dickey-Fuller (ADF) Test for Terminal Market price (TPI)	146
Table 29. Stationary test of PPI and TPI series.....	148
Table 30. Augmented Dickey-Fuller (ADF) Test for Retail price (RPI)	149
Table 31. Augmented Dickey-Fuller (ADF) Test for Retail price (RPI)	150
Table 32. Johansen’s tests for co-integration of the price series (Shipping price & Terminal Market price).....	151
Table 33. Johansen’s tests for co-integration of the price series (Terminal Market price & Retail price).....	152
Table 34. Long-run equation in the Vector error correction model (VECM).....	154
Table 35. Vector error correction model (VECM).	155
Table 36. LM test for residual autocorrelation (Terminal Market price & Shipping price).	156
Table 37. Test for normally distributed disturbances (Terminal Market price & Shipping price)	156
Table 38. Test for normally distributed disturbances (Terminal Market price & Shipping price)	157
Table 39. Vector error correction model (VECM). Causality from terminal market price to Shipping price.	158
Table 40. Vector error correction model (VECM). Causality between Terminal Market price to Retail price.....	161
Table 41. Overview of Racial and Ethnic Demographics Trends in Tattnall and Toombs counties	184
Table 42. Estimated cost of producing onion in Georgia	202
Table 43. Marketing Order: History and Principles.....	206
Table 44. SWOT analysis of the Vidalia Onion Value Chain	209
Table 45. “Tioga Farms Bros” Pros vs Cons	216
Table 46. Onion Characteristics (Present).....	216
Table 47. Onion Characteristics (Future)	217
Table 48. Onion Characteristics Comparison Present vs Future.....	217
Table 49. Variable Costs (Operating costs) – Present vs Future	218
Table 50. Variable Costs (Branded & Marketing costs) – Present vs Future	218
Table 51. Partial Budget	219
Table 52. Non-quantifiable elements.....	220
Table 53. Gain and loss Matrix	221
Table 54. Hypothetical transactions table for a local economy.....	225
Table 55. The ten main vegetables production in New York in 2018/2019 (USDA, NASS)	228
Table 56. Cost of production comparison for the 10 main vegetables produced in New York (Sources: PennState Extension & New York Onion growers’ survey).....	230

Table 57. Farms and acreage in New York (Census 2017, 2012, 2007, 2002) USDA	231
Table 58. Onion Characteristics	232
Table 59. Onions production at farm gate - USDA, NASS, (2020), New York Agricultural Statistics Annual Bulletin, 2018	234
Table 60. Corn production at farm gate - USDA, NASS, (2020), New York Agricultural Statistics Annual Bulletin, 2018	235
Table 61. Economic Impact of scenario 1: a new premium branded onion within vegetable industry in New York State, 2018 dollars	237
Table 62. Estimated changes in Ten most impacted sectors with the scenario 1: a branded onion scenario within vegetable industry in New York State, 2018 dollars	239
Table 63. Economic Impact of scenario 2: The end of onion within vegetable industry in New York State, 2018 dollars	242
Table 64. Estimated changes in Ten most impacted sectors with the scenario 2: an onion shift away in New York State, 2018 dollars	243

Acknowledgments

This study was prepared in 2021 as part of the AgriCluster Retention and Expansion (ACRE) Program, led by the Thomas A. Lyson Center for Civic Agriculture and Food Systems in collaboration with Cornell University's Department of Global Development. The Lyson Center is a project of the Center for Transformative Action, a nonprofit affiliate of Cornell University. I am extremely grateful for the help and continued support of Duncan Hilchey and Amy Christian of the Lyson Center for Civic Agriculture and Food Systems.

I thank the Department of Global Development, which is affiliated with Cornell's College of Agriculture and Life Sciences (CAL S). I wish to acknowledge David Kay, Senior Extension Associate in the department, for his help and his crucial contribution to section 7.

This study benefited from the support of the United States Department of Agriculture (USDA). I thank Melissa Reeves (USDA), Andrew Hatch (USDA Agricultural Marketing Service [USDA AMS]), Matt Pavone (USDA AMS), and Steven Kauffman (USDA AMS, Winter Haven, FL).

I wish to acknowledge all the experts who have sent me documents and provided advice that have been instrumental in improving this report's quality. Thanks to Stuart Reitz and Gina Greenway (Oregon State University), Clifton Parks (President and CEO, AgriLogic Consulting), Esendugue Greg Fonsah (Coordinator and Agribusiness Extension Economist, Department of Agricultural and Applied Economics, University of Georgia), Amanda R. Smith (Extension Coordinator, Economist University of Georgia), Tim Waters (Professor/Regional Vegetable Specialist, Washington State University Extension), and Sarah Rocker (Northeast Regional Center for Rural Development, Pennsylvania State University).

I wish to thank Canadian experts for their support as well. Thanks to Annie Morissette (CRAAQ), Lorraine Carrier (CECPA), Catherine Lessard (APM Québec), Christine Gingras (Groupe Export), Victoria Crosbie (Financial Guarantee Programs Division - Government of Canada) and Jean-Sébastien Comeau (AAFC/AAC, Cabinet du Ministre de l'Agriculture et de l'Agroalimentaire).

Special acknowledgments to onion growers who are involved in the New York Muck Onion Project for their help: Craig Yunker (Genesee Co. onion grower), Judy Queale-Dunsmoor (Oswego Co. onion grower, New York Bold Onion), Joe DiSalvo (onion grower in Oswego Co.), Chris Pawelski (Orange Co. onion grower), and John Dunsmoor (Oswego Co. onion grower).

I want to acknowledge the Northeast Regional Center for Rural Development (NERCRD) that supported the Thomas A. Lyson Center for Civic Agriculture and Food Systems on the Muck Onion project.

I thank Loren Tauer, Professor at the Charles H. Dyson School of Applied Economics and Management, Cornell University, who reviewed this report and suggested many comments to increase its quality.

Great thanks to Maire Ullrich and Roberta Severson for their comments and our discussions. Maire Ullrich is the Agriculture Program Leader at Cornell Cooperative Extension—Orange County. Roberta Severson is an extension associate and program leader of the Cornell Cooperative Enterprise Program at the Charles H. Dyson School of Applied Economics and Management.

I thank Gretchen Burmeister for copy-editing and her useful comments that were crucial in improving the quality of this report.

How to Use This Report

It is not necessary to read this report cover to cover. It is dense with facts and figures and is not necessarily sequential. After reading the Executive Summary, I recommend studying the table of contents and cherry-picking topics of interest. If you are short of time, you can simply read the Ten Factual Highlights below the summary.

Executive Summary

In this working paper, I outline how the onion industry in the U.S.A. has undergone tremendous change over the past 50 years. Onion demand and production have increased dramatically. Over the past 20 years, production has reached a plateau of 3.2 million tons per year, while consumption has grown and will continue to rise based on demographic projections. These trends result in a trade deficit: the U.S. imports more and more onions each year, particularly from Mexico and Peru.

The situation for onion growers in the U.S. is very different as the global, national, and local contexts have changed over the past 50 years. Onion growers, depending on their geographic location, have developed different strategies to deal with increasingly tough competition. Many growers (in Idaho, Oregon or Washington States) have chosen to develop a price competitiveness advantage. In contrast, others have built a differentiation strategy based on a premium onion linked to a *terroir* (i.e., *place-based soil and climate advantages coupled with unique production practices*), such as the Vidalia onion industry in Georgia. The third group of onion growers has not chosen between these two strategies; they have not collectively and locally established a shared vision that takes their strengths, weaknesses, threats, and opportunities into account.

I suggest that this is the case for the New York onion industry, which competes with onion growers who have based their competitive advantage on a single marketing strategy: low price. But New York onion growers are not cost competitive, and their position has declined. In 2017, about 50 onion growers with more than 5 acres produced 95 percent of onion production with 6,400 acres. However, 20 years ago (in 2002) 114 farms with more than 5 acres used 11,400 acres. For 20 years growers and acreages have been approximately cut in half. My research suggests the drivers of this decline in New York Muck Onion are imperceptible from year to year, but over time have eroded NY's once powerful onion industry. In my view, New York onion growers have become links of a supply chain where they sell a generic onion like a commodity.

Recently, New York onion growers have complained about Canadian exports and have argued that Canada subsidizes Canadian onion growers, causing serious injury to New York growers. I have analyzed Canada's export policy and found that there is no evidence to support this

allegation. There are no subsidies to Canadian onion growers that would alter the price and create an unfair competitive advantage for Canadian exporters.

New York onion growers are focused on Canadian yellow onion imports as they are direct competition, but they are also secondary/indirect competition coming from sweet onions year round. Because sweet onions are becoming a generic all-purpose onion for fresh eating and cooking, sweet onion now compete with pungent onion. The largest U.S. growers and shippers of sweet onions have established production in Mexico and Peru, and have become exporters of onions to the U.S. to meet consumer demand year-round.

Furthermore, my results show that the yellow onion market in the northeast part of the U.S. seems to run correctly, without competitive distortions. Growers and handlers try to compete with other onion supply chains that have better productivity and lower production costs. To maintain their onion market shares, New York onion growers use a single driver: low price. Over the last 10 years (2011-2020), in U.S. Northeast region, the current retail price of yellow (pungent) onions has decreased from US \$1.06 to US \$0.90 per pound. However, to reduce the price to consumers, retailers have reduced their share of the value. I examined New York onion price data for the 10-year period 2010 to 2020. At the beginning of the period (2010/2011), retailers received about 72% of the total value, and by the end (2019/2020), this portion declined to 63%. Retailers lost 9% on average. Four-percentage points have been captured by second handlers and five-percentage points by first handlers-growers. At the end of the period, when consumers paid US \$0.90 per pound, 23 cents went to growers-first handlers, 7 cents to second handlers (packers), and 60 cents to retailers. These results contradict the notion that retailers have increased their profitability at the expense of growers and handlers.

New York onion growers cannot change their position in the hierarchy of the yellow onion market. Consumers consider yellow (storage) onions a staple food and retailers use them in a “loss-leader” strategy. As a loss leader, retailers don’t use this onion to make profit; they are selling generic yellow onions below cost to attract customers (e.g., via promotional price discounts). But Retailers

will only accept a certain level of loss. The net result for New York onion growers is that they are caught in a low-price trap.

Within the low-price trap, there is price volatility suggesting as there is no volume control in the supply chain. Volatility can lead to asymmetric price transmission. Price transmission is the process by which upstream prices influence downstream prices and vice versa. However, I show no asymmetric price transmission or market power on either the grower-handler or retailer sides. In the long-run, shipping prices, terminal market prices, and retail prices move together. Moreover, I found that shipping price drives the terminal market price, and the latter causes retail price. Indeed, first and second handlers operate as if they were price makers even if it is “a low price”.

Therefore, like the Vidalia onion, I recommend that New York onion growers transition at least a portion of their production from the current unprofitable “supply chain” to a new value-added strategy based on a black dirt soil terroir to create a new, more profitable, and sustainable “value chain.” This new approach requires collective investment in the shared advantages the New York muck onion growers have-- unique soil, climate conditions, local onion varieties, and know-how.

At the end of the report, I offer a cost/benefit analysis that shows, with given parameters and strategic investments, the New York muck onion community has the potential to capitalize on a new New York brand of onions that realizes benefits for all stakeholders in the state’s onion industry, not only growers, but also handlers, retailers, and consumers. I have developed a budgeting tool for New York onion farmers to use to help in making the decision to transition a portion of their onions to a new value-added onion brand¹.

In addition, I have also conducted an economic impact analysis of the New York State onion industry. This economic impact analysis shows the importance of the New York onion industry in terms of gross output, labor income and value added.

¹ An Excel spreadsheet to map out all the possible alternatives to onion growers’ decision exists. If you would like to get this Excel spreadsheet, please send a message to: philippe.jeanneaux@vetagro-sup.fr

In a first scenario called the “branded onion scenario”, the change is an increase in onion sales at the farm gate in New York. This reflects the opportunity to develop a strategy of differentiation via a new premium branded onion. I show growers are able to generate a gross output surplus of \$15.2 million. In this scenario, the direct effect is \$15.2 million and a creation of 185 new jobs. The increase of labor income is \$5.3 million and the value added has gone up over \$8 million.

In a second scenario, I evaluated the importance of the New York onion industry by modeling a change in which the onion sector shifted production to grain crops such as corn. In this scenario the onion industry loses its \$41 million gross output to the grain crop sector. The grain crop sector would increase its acreage by approximately 7,200 acres to generate \$4.7 million in new gross output, the direct effect for the onion industry would be a loss of \$36.3 million and a loss of 472 jobs. The decrease in labor income would be \$13 million and value added would decrease by over \$19 million.

To conclude, this report sheds light on the complexity of the onion industry in the U.S. The analysis at the farm gate and at the scale of the onion industry in New York State shows that there is potential to develop a profitable new value chain. The key challenge is for growers and handlers to believe in their strengths and seize the opportunity. To begin exploring this new approach, a group of onion growers begin meeting in 2020-21. With the support of the AgriCluster Retention and Expansion (ACRE) project, led by the Thomas A. Lyson Center, a nonprofit affiliated with Cornell University, these onion growers have drafted a Vision Statement: *“New York Muck Onion industry will command a special market segment where consumers value a unique product. This segment provides increased profit, protects competitive advantage, and resiliency/vitality/vibrancy/well-being for growers and all constituents/members of the value chain”*. With ongoing support from the State of New York, I believe the muck onion growers could achieve this vision.

Keywords: Onion industry, Market strategy, USDA, Price analysis, New York State, Muckland production, Terroir

Ten Key Factual Highlights

1. The United States is a major onion producer worldwide, producing 3.2 million tons.
2. Increased demand for onion and stagnating domestic production in the U.S. led to a trade deficit due to imports from Mexico and Peru. In 2019, U.S. onion imports totaled US\$431 million, US\$195 million more than exports. The largest growers and shippers of sweet onions in the U.S. have expanded onion production outside the U.S. and have become exporters to the U.S.
3. The first competitors to U.S. onion growers are probably U.S. onion growers who control farms in Peru and Mexico.
4. Contrary to popular belief, low-priced Canadian exports have not flooded the U.S. domestic onion market or injured New York State onion growers.
5. My analysis reveals that subsidies (significantly low) to Canadian onion industry have not changed the price or created an unfair competitive advantage for Canadian exporters.
6. In 2019, New York produced 3.2% of domestic onions, compared to 20% in 1960.
7. Based on the data analysis presented in this report, I believe the yellow onion market in the Northeastern U.S. runs as it should, without competitive distortions. First and second handlers seem to operate as price makers even if it is a low price. These handlers compete with other onion supply chains that have better productivity and lower production costs. To maintain their share of the onion market, handlers use a single tool: low price. If there is volatility, it is because growers do not have control of the onion supply.

8. Contrary to common belief, my research shows that consumer onion prices have not increased, while wholesale buyers and farmers have received slightly higher prices over the past 10 years. The retail price of the yellow globe onion has decreased since 2011 to US\$0.90/pound, a 16% decline. A similar trend has been observed for yellow sweet onion (–10%), even if this onion has a better price than yellow pungent onion.

9. Because of their cooking flexibility, large Granex sweet onions may be cutting into the demand for pungent onions. The New York onion acts like a commodity rather than a specialty crop. New York onion growers are involved in a cost competitiveness strategy rather than a differentiation strategy (such as Vidalia). However, NY growers are neither competitive as they were not on the relevant market.

10. A cost/benefit analysis at the farm gate suggests that, depending on the unique circumstances of individual farms, there is the potential to produce and market premium yellow onions on the remaining onion growers' farms in New York State. Indeed, at the farm gate, turning the muck onion business model into a branded premium onion is profitable. An economic impact analysis using IMPLAN™ software, shows the importance of the New York onion industry in terms of gross output, labor income and value added.

Introduction

For many years, New York onion growers enjoyed a leadership position in the national onion supply due to a combination of advantages, including unique soil and climate conditions and proximity to large, diverse markets. However, trends suggest that these advantages are disappearing as global competitors offer comparable, but lower cost, undifferentiated onions. As a result, the current production and marketing approaches of New York onion growers are not particularly effective. New York onion growers are presently competing in a race with each other and growers in other regions to produce high volumes of cheap commodity onions. The question thus becomes: can onion producers continue this race, in which they seem unable to win because the competition is so fierce? Onion growers in New York State wish to understand onion-marketing dynamics in the U.S. and especially in New York State. By learning more about the market for onions, they aspire to identify new competitive advantage based on the strategy of differentiation, which could increase their value and share it equitably between all stakeholders of the value chain.

This report provides some answers to recent complaints and requests from New York State leaders, including U.S. Senator Kirsten Gillibrand, a member of the Senate Agriculture Committee. She called on the U.S. Department of Agriculture (USDA) on September 24, 2019, to investigate if fruit and vegetable farmers in New York and across the country are receiving fair prices for their produce². She argued,

“while the prices of fruits and vegetables have increased for both consumers at the grocery store and for wholesale buyers, the prices that farmers receive for these same products has not kept up with these increases—and [has] even gone down in some cases. Our New York farmers are facing a produce-pricing crisis. Throughout the state, fresh fruit and vegetable growers are hurting because the prices they get for their produce have stayed flat, and in some cases have even

² <https://www.gillibrand.senate.gov/news/press/release/as-new-york-fruit-and-vegetable-farmers-struggle-with-produce-pricing-crisis-gillibrand-calls-on-usda-to-investigate-why-prices-paid-to-farmers-arent-keeping-up-with-the-market->, Retrieved December 16, 2020.

gone down, while the middlemen who move the produce from farmers to grocery stores and grocery store shoppers have seen the prices for the same produce increase.” She added that “despite this, the USDA has not reviewed the fruit and vegetable industry in decades. We need to understand what is causing these unfair prices for our farmers, and I am calling on the USDA to complete a top-to-bottom review of the fruit and vegetable industry so that we can help New York’s farmers better price their produce and plan for their future.”

A small group of New York Muck Onion growers has decided to explore their interests in working together to promote a muck onion value chain or a brand on a statewide basis. Their concern was an opportunity to explore more deeply the onion industry in the U.S.

As a result, this study was conducted during winter 2020/2021 in collaboration with the Thomas A. Lyson Center for Civic Agriculture and Food Systems³ and Department of Global Development at Cornell University. I have analyzed data that comes from numerous USDA online sources. For every analysis, I provide information on the origin of the data, section by section.

The report is divided into seven sections and a conclusion. Section 1 gives a brief overview of the current New York muck onion marketing issue and project. Section 2 provides an overview of the global onion market in terms of imports and exports and its dynamics. Section 3 compares the U.S. fresh⁴ onion production and market to New York. Section 4 is dedicated to prices at different stages (farm gate, shipping, and retail) and presents an analysis of production costs. Section 5 presents a price transmission analysis between producers and retailers to evaluate asymmetric price transmission, and who seems to establish the price. Section 6 illustrates the “differentiation strategy,” which is a way to improve sales and profitability for growers and other stakeholders

³ The Thomas A. Lyson Center is a project of the Center for Transformative Action, which is, in turn, a nonprofit 501c3 tax exempt organization formally affiliated with Cornell University.

⁴ In general, onion products can be divided into 3 categories: fresh bulbs for the market, dehydrated onions as ingredients for food processing, and onions for essential oil production (Wiczowski 2011; Bahram-Pavar and Lim, 2018). Our analysis is based on fresh onion. That means dehydrated onions and onions for essential oil production are not included.

(such as the approach taken by the Vidalia onion value chain). Section 7 proposes to evaluate the economic impact of the expected change in profit from a new muck onion brand. A first evaluation proposes a cost/benefit analysis calculating the expected change in profit from a new muck onion brand in the farm business. A second evaluation estimates the economic impact of the onion industry in New York State using IMPLAN™ software. I end this report with a general conclusion.

Methodological Clarifications

This presentation provides a secondary data analysis of the onion industry in the U.S. with a focus on New York State issues, including detailed evidence regarding the prices onion growers receive. Datasets were secured from the UN FAO, the USDA Economic Research Service; USDA Agricultural Statistics Service, the USDA Market News, and Statistics Canada. Materials and methods are provided within the different sections of this report. Supplementing this secondary data, research and trade literature have also been used. Meetings with onion growers and extension educators and other experts have been organized to get information or discuss the results.

1. New York State Muck Onion Industry Situation Analysis

Over a long time, New York onion industry have competed with onion growers who have based their competitive advantage on a single marketing strategy: low price. Over the last 10 years (2011-2020), in U.S. Northeast region, the current retail price of yellow (pungent) onions has decreased from US\$1.06 to US\$0.90 per pound (USDA AMS⁵). The position of New York onion growers has declined as if they were not competitive. In 2017, about 50 onion growers with more than 5 acres produced 95 percent of onion production with 6,400 acres. However, 20 years ago (in 2002) 114 farms with more than 5 acres used 11,400 acres (USDA Census 2002 and 2017). For 20 years growers and acreages have been approximatively cut in half.

A question occurs from stakeholders of the New York onion industry: can onion producers continue this race, in which they seem unable to win because the competition is so fierce?

Onion growers in New York State wish to understand onion-marketing dynamics in the U.S. and especially in New York State. By learning more about the market for onions, they aspire to identify new competitive advantage based on the strategy of differentiation, which could increase their value and share it equitably between all stakeholders of the value chain.

1.1. The New York State Muck Onion Issues

1.1.1. Production and market issues

On the production side, both acres harvested and volume of production have decline precipitously in recent years. Furthermore, New York's share of total U.S. production is in decline (Figure 1).

⁵ USDA, AMS web site: Retrieved October 20, 2020. <https://www.marketnews.usda.gov/mnp/fv-report-retail?repType=wiz&run=Run&portal=fv&locChoose=location&commodityClass=allcommodity&startIndex=1&type=retail&class=ONIONS+AND+POTATOES&commodity=ONIONS+DRY®ion=NORTHEAST+U.S.&organic=N&repDate=09%2F25%2F2020&endDate=01%2F31%2F2021&compareLy=No>

In 1960, 5.17 million cwt was harvested in New York from 15,000 acres. In 2019, 2.24 million cwt was harvested across 7,000 acres. Onion production has steadily decreased since 1960 (Figure 25). Stagnating yields and acreage loss are the causes of this decline. During the 1990s, the area of farmland devoted to onions remained stable at 13,000 acres/year; however, acreage loss has significantly accelerated in recent years, resulting in a loss of 6,000 acres since 2000.

Figure 1. Area Harvested & production 1960-2010 New York State (source: USDA. NASS)

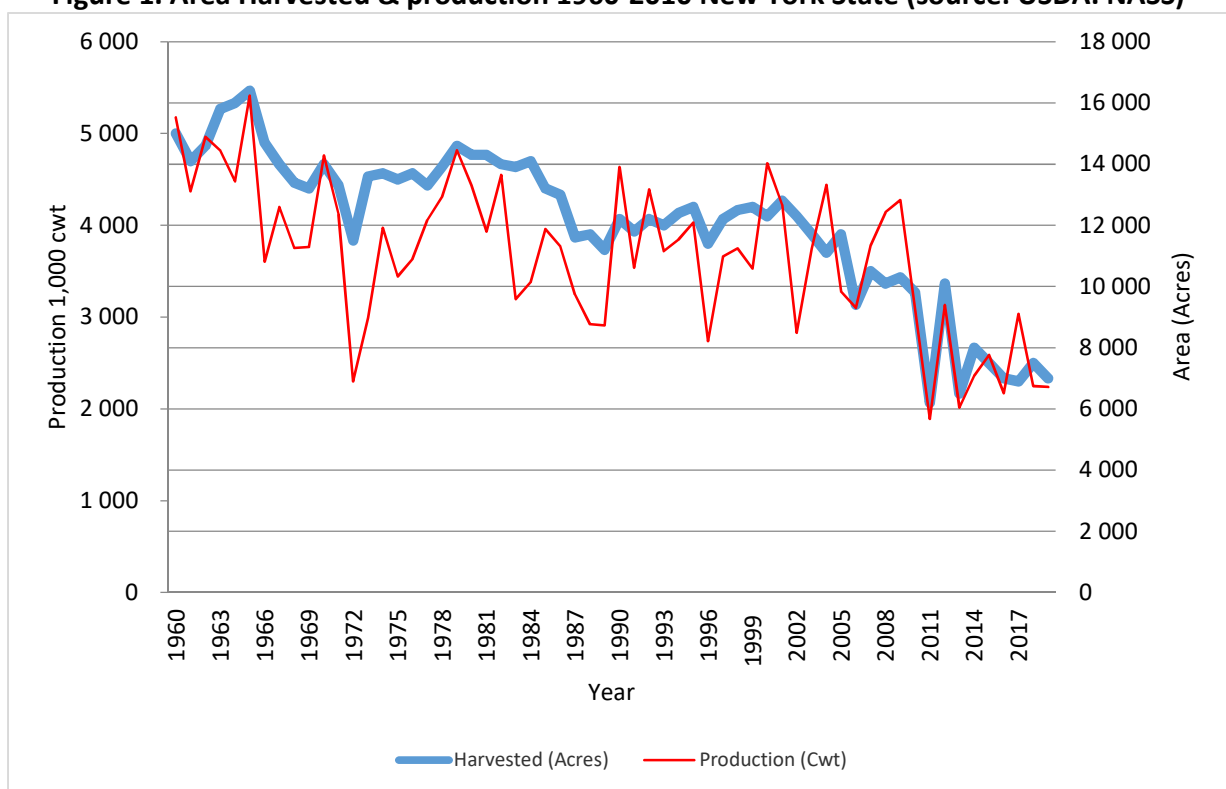

Unlike U.S. onion production, the loss of harvested area has not been compensated by a strong yield improvement in New York; for the last 50 years, onion yields per acre have increased more slowly in NY than elsewhere in the U.S.

Since 1970, NY has experienced a yield gain of 1.5 cwt/acre/year, compared to the total U.S. yield gain of 5.4 cwt/acre/year (Figure 2). Over the last decade (2010-2019), the total U.S. onion yield averaged 516 cwt/acre, while it was 304 cwt/acre during the 1970s. In comparison, the NY onion

yield averaged 325 cwt/acre from 2010-2019, while it was 283 cwt/acre during the 1970s. Moreover, New York onion yield is volatile and can change dramatically between consecutive years. For example, yields in 2016, 2017, and 2018 were 310, 440, and 300 cwt/acre, respectively.

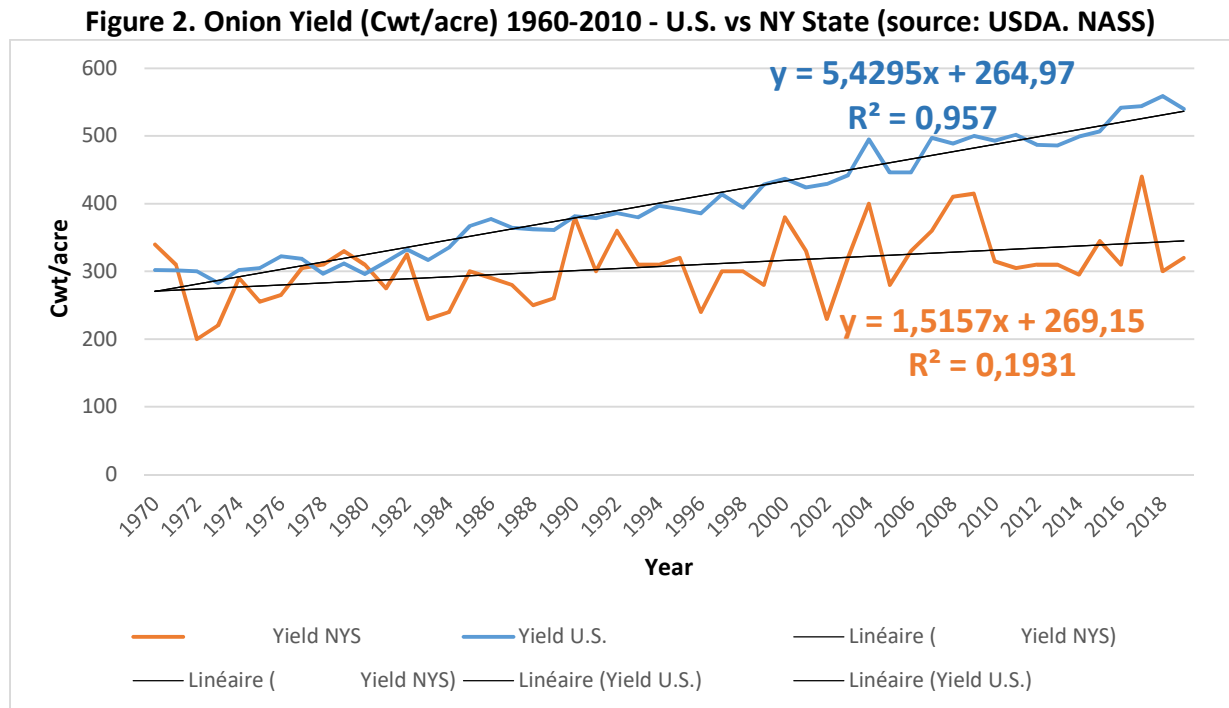

Stagnating yield in NY probably signals a lack of investment in seed genetics or other production advancement for pungent onions rather than poor weather conditions.

The onion is no longer a symbolic product of New York, evidenced by a loss of market share in the domestic onion market. In 2019, New York produced 3.2% of U.S domestic onions, compared to 9% in 1990 and 20% in 1960 (Figure 3 and 4).

Figure 3. Area harvested (Acres) & Production Onion (All types) (1,000 cwt) U.S./NY State 1960-2010 Source: USDA. National Agricultural Statistics Service

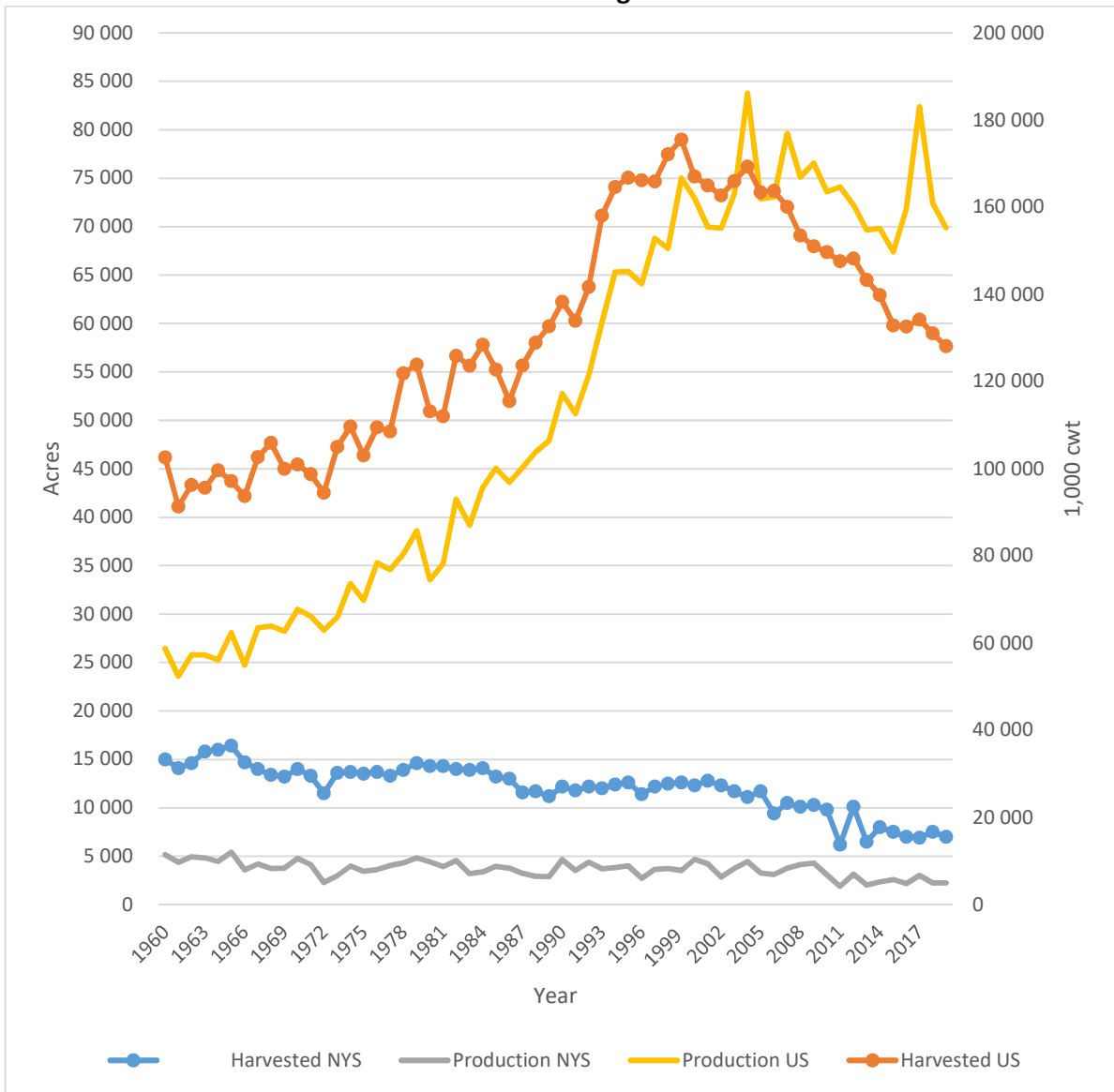
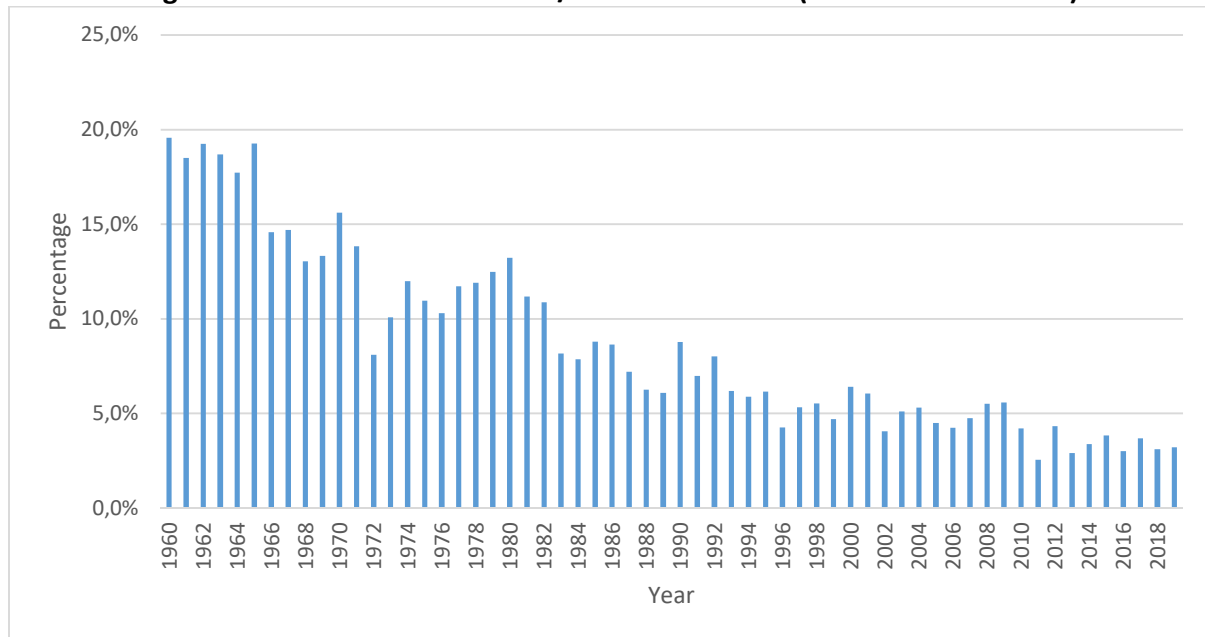

Figure 4. Production Shared NYS/USA 1960-2019 – (Source: USDA. NASS)



Yellow pungent onions are beginning to be replaced in the marketplace by sweet onions, which are now promoted as a generic all-purpose onions. Pungent onions are cooking onions requiring heat treatment to turn their pungency into sweet and complex flavors. They are generally not consumed raw and are therefore rendered virtually useless for salads. Freshly cut onions produce pungent volatiles that are lachrymatory and considered a nuisance to most people (Barham-Parvar and Lim, 2018). Consequently, there is a demand for fresh-cut ready-to-eat pungent onions.

On the other hand, sweet yellow onions are suitable for salads and other fresh dishes due to their low sugar and sulfur content (and less lachrymatory), and they can be cooked to concentrate their sugars.

Picture 1 demonstrates how sweet onion growers promote the generic all-purpose quality of their onions. The box highlights three ways to eat and prepare sweet onions (blue box):

- Barbecue Grilled
- Cooked in a pan
- Raw in a salad

A second message (red box) raises this question for consumers: why buy pungent onions that make you cry if you can avoid this by buying a generic all-purpose sweet onion?

Picture 1. Example of communication to promote sweet onions as generic all-purpose onions



Credit: Bland Farms, <https://blandfarms.com/vidalia-sweet-onions/>

New York onion growers are probably mostly care about yellow pungent onion growers as they are direct competition, but they are also indirect competition coming from sweet onions year round. Because sweet onions are becoming a versatile⁶ onion, sweet onion now compete with pungent onion.

This is a serious challenge for pungent onion growers that will require a new value-adding strategy.

1.1.2. New York onion operations issues

From 2002 to 2017⁷, farm production changed dramatically. The first major change was the loss of 265,000 acres (-7%) of harvested cropland. While harvested vegetable cropland declined from 169,897 acres in 2002 to 124,859 in 2017 (-45,038 acres; -27%), soybeans gained 143,018 acres⁸. Growers evidently moved from complex crops, requiring labor and specific skills, to simpler and more profitable crops. This change is part of a larger trend toward simpler farming that can be

⁶ Produce Business "Peruvian Onions", September 1, 2018: <https://www.producebusiness.com/peruvian-onions/>

⁷ We analyzed the census from 2002 to 2017 - Census of Agriculture (USDA, National Agricultural Statistics Service <https://www.nass.usda.gov/Publications/AgCensus/2017/>

⁸ According to experts we met, soybeans mostly replaced wheat.

seen in many regions, not only in the U.S. We must assume that onion production is increasingly driven by producers who have tried to boost their competitiveness by producing more with the same or fewer inputs (mainly labor). As a result, producers have likely replaced onions with other crops.

In 2017, 558 out of 33,438 farms (1.6%) produced onions on 0.1% of total farm acreage in New York. Onion production and acreage in New York is declining. Since 1960, New York has lost 8,000 acres (1960 = 15,000 acres; 2019 = 7,000 acres) and 2.5 million cwt (1960 = 5 million cwt; 2019 = 2.5 million cwt) (See Figure 2, above (USDA NASS)).

Many onion growers in New York are mid-sized farmers (Table 1). They produce too many onions to sell directly to local customers through farmers markets. Farmers' markets are alternatives for high-quality vegetables, but they require new skills and time for farmers. This is because direct markets involve producer interaction with consumers. In general, because of limited resources, mid-sized farmers must turn to larger markets to sell their onion. On the other hand, mid-sized farmers cannot compete with large operations because they using a low cost high volume strategy. Therefore, these mid-size farms are decreasing in number. The 2017 USDA Census of Agriculture reported that, while the number of small (1 to 9 acres) and large (2,000 acres or more) farms grew, thousands of operations in the middle were lost.

Table 1. Farms and acreage in New York (Census 2017, 2012, 2007, 2002) USDA

(Census USDA)	2002	2007	2012	2017
Farms	232	234	278	558
Acres	11,500	9,600	7,900	6,600
Operations < 5 acres	118 op = 100 acres	155 op = 99 acres	200 op = 150 acres	507 op = 200 acres
Operations > 5 Acres	114 op = 11,400 acres	79 op = 9,500 acres	78 op = 7,750 acres	51 op = 6,400 acres
Operations > 100 Acres	42 op = 8,507 acres (74%)	34 op = 7,785 acres (81%)	26 op = 5,384 acres (68%)	20 op = 5,100 acres (80%)

Moreover, even if the number of onion growers has dramatically increased from 232 to 558 since 2002, these are very small growers that are retailing at direct markets such as roadside stands and farmers’ markets. At the same time, larger onion growers in New York have probably reduced their onion production in a risk management strategy to diversify. Therefore, if these trends continue, onion production in New York will become further marginalized as agribusiness support services decline.

According to the 2012 USDA Census of Agriculture, nine New York counties accounted for 88% of onion production (in acres) and 39% of onion farms. Only three counties (Orange, Orleans, and Oswego) accounted for 78% of onion production and 25% of farms growing onions. In 2017, the nine counties accounted for 92% of onion production (in acres) and 22% of farms growing onions. The three same counties (as above) accounted for 79% of production but with only 10% of farms growing onions (Table 2). While the number of onion-producing operations has risen due to direct marketing activities of small and part-time farms (+100%), the acreage dedicated to onion production has decreased (-17%). The commercial wholesale onion sector is increasingly geographically concentrated.

Table 2. Geographic distribution of farms and acreage in New York (Census 2017 & 2012 USDA NASS)

Geographic area	2017						2012	
	Total harvested		Harvested for fresh market		Harvested for processing		Total harvested	
	Farms	Acres	Farms	Acres	Farms	Acres	Farms	Acres
Onion DRY								
New York State	558	6606	542	6584	26	23	278	7958
Orange	32	1,723	31	d	1	d	47	2,566
Orleans	10	1,642	10	1,642			11	1,921
Oswego	14	1,854	10	d	5	d	12	1,728
Genesee	5	394	5	394			2	d
Madison	18	D	18	d			9	d
Wayne	19	477	19	477			15	414
Yates	20	7	20	7			7	d
Steuben	4	d	4	d	1	d	8	441

Specialization and disinterest in onion production have also led to a concentration of growers. Approximately 51 operations, with more than 5 acres each, harvested from about 6,400 acres in

2017 (96.9%) (Table 3). However, only 20 onion growers (3.6%), with more than 100 acres each, controlled 80% of onion production, i.e., 5,159 out of 6,606 acres.

Table 3. New York onion growers in 2017 Census of Agriculture (USDA, National Agricultural Statistics Service)

AREA HARVESTED	FRESH MARKET & PROCESSING:	
	NBFarm	NBAcres
(0.1 TO 0.9 ACRES)	445	89
(1.0 TO 4.9 ACRES)	62	112
(5.0 TO 14.9 ACRES)	10	(D)
(15.0 TO 24.9 ACRES)	3	56
(25.0 TO 49.9 ACRES)	6	190
(50.0 TO 99.9 ACRES)	12	880
(100 TO 249 ACRES)	14	2271
(250 TO 499 ACRES)	5	1646
(500 OR MORE ACRES)	1	(D)
total	558	6606

New York Muck Onion industry is losing ground and growers because it is not capitalizing on its natural, comparative, and competitive advantages, including its “Terroir” (soils and climate), its long history and tradition of superior onion growing, and its close proximity to the largest onion markets in the U.S.

1.2. What’s Special About New York Muck Onions?

For multiple experts⁹ Muck onion simply taste better, store longer, and are potentially healthier than mainstream onions from other states and countries. New York yellow onion have several characteristics:

- Muck onions are excellent storing onions.
- Science has shown New York Muck Onions have additional health benefits (high antioxidants).

⁹ New York’s beloved ‘black dirt’ onions: <https://www.bbc.com/travel/article/20190822-new-yorks-beloved-black-dirt-onions>, Retrieved May 20, 2021

- One of the big secrets of New York pungent onion is sulfur. The naturally high sulfur content of the soil from thousands of years of composted vegetation ups the pyruvic acid levels in the onions, which, in turn, increases the sugar content, resulting in a bold, pungent taste. This makes New York Muck Onions exceptional for cooking. When caramelized, they become uniquely sweet. Therefore, the first cooking rule to have in mind is that yellow pungent onions have unique chemical characteristics that allow for specific aromas and flavors that other onions do not have. For example, a French onion soup should never be cooked with sweet onion or red onion, but only with yellow pungent onion. Conversely, yellow pungent onions are not suitable for salads¹⁰¹¹. Muck onions pack a punch in raw preparations and perfectly caramelize when cooked. The French have a phrase for this: "Gout de Terroir"-- a taste of place! A terroir¹² is a delimited geographical area defined by a community, which, over its history, has built a set of distinctive cultural traits, knowledge, soils and practices based on a system of interactions between the natural environment and human factors. The know-how involved reveals originality, confers typicality, and allows recognition for the products or services originating from this area and thus for the people who live there. The terroirs are living and innovative areas that cannot be assimilated on tradition alone. Thus, the terroir can build a competitive advantage by enhancing unique localized material and immaterial resources.

1.3. The "Terroir" of New York muck onions

With the unique organic soil naturally high in sulfur that exists in different place in New York state, there is a unique terroir of New York muck onions limited to a few counties in New York

¹⁰ Are You Cooking With the Best Type of Onion? Probably Not: http://www.dvo.com/PinterestRecipes/0430_183051892.html?CID=Pin, Retrieved May 20, 2021

¹¹ A Guide to 6 Different Types of Onions and How to Use Them: <https://www.masterclass.com/articles/a-guide-to-onions#how-to-cook-with-yellow-onions>, Retrieved May 20, 2021

¹² Prévost, P., M. Capitaine, F. Gautier-Pelissier, Y. Michelin, P. Jeanneaux, F. Fort, A. Javelle, P. Moïti-Maïzi, F. Lérèche, G. Brunschwig, S. Fournier, P. Lapeyronie, & É. Josien (2014). "Le terroir, un concept pour l'action dans le développement des territoires." *Vertigo - la revue électronique en sciences de l'environnement* [En ligne], 14(1): mis en ligne le 10 mai 2014, consulté le 2029 mars 2015. <https://doi.org/14810.14000/vertigo.14807>

state (Map 1). Onions are primarily grown on muck (organic) soils found in five counties: Orange, Oswego, Genesee (Elba), Wayne, and Yates (Map 1). Onion production also exists in Madison, Orleans, and Steuben counties.

Map 1. Muck soil location in New York State (by county)
(source: D. Hilchey)

▲
North

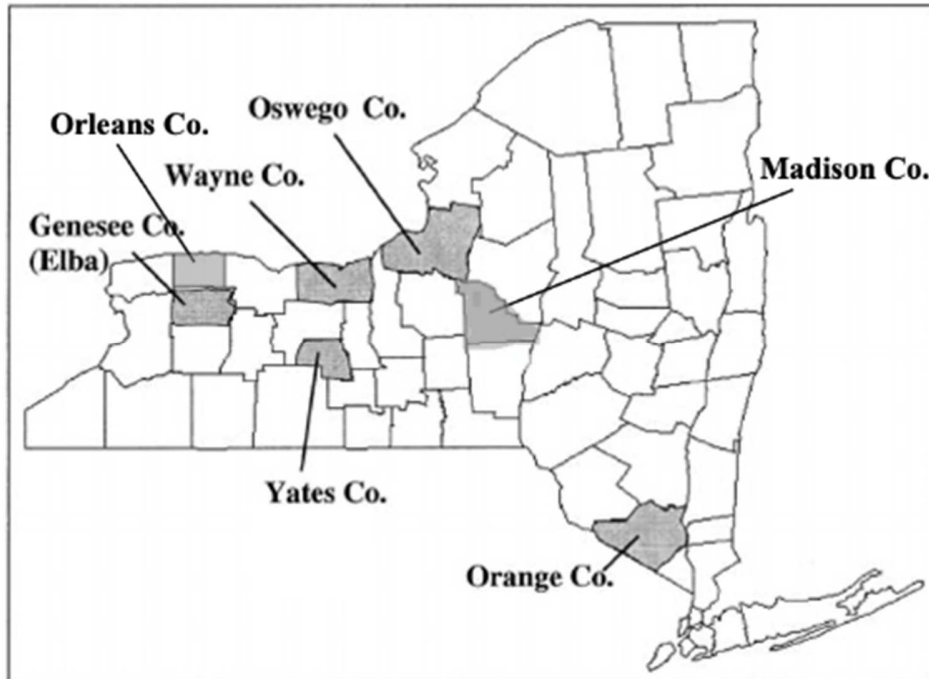

The New York pungent onion terroir is the harmony between product, soil, climate, skills, and cultural factors (Figure 5). The black dirt soil or muck soil takes its name from the dark (Pictures 2 and 3), extremely fertile and damp soil found in the bottom of drained, ancient glacial lakes. The muckland or swampland (bog) was drained and cleaned: tree and brush cutting, root removal. During the late 19th and early 20th centuries, settlers transformed the swampy region into arable farmland and began growing pungent, highly prized black dirt onions.

Picture 2. Black dirt soil in New York State - Credit: Duncan Hilchey



Picture 3. Black dirt soil in New York State - Credit: Philippe Jeanneaux



The high sulfur content of the soil from thousands of years of composted vegetation increases the pyruvic acid levels in the onions resulting in a bold, pungent taste when raw. The high sugar

low-water content yields a pleasantly sweet and a slightly spicy flavor when the onion is cooked¹³. The growing season is limited, and therefore Muck Onions have a natural seasonal availability (they are not common; they are very special– like Vidalia).

Figure 5. The New York pungent onion “Terroir” triangle

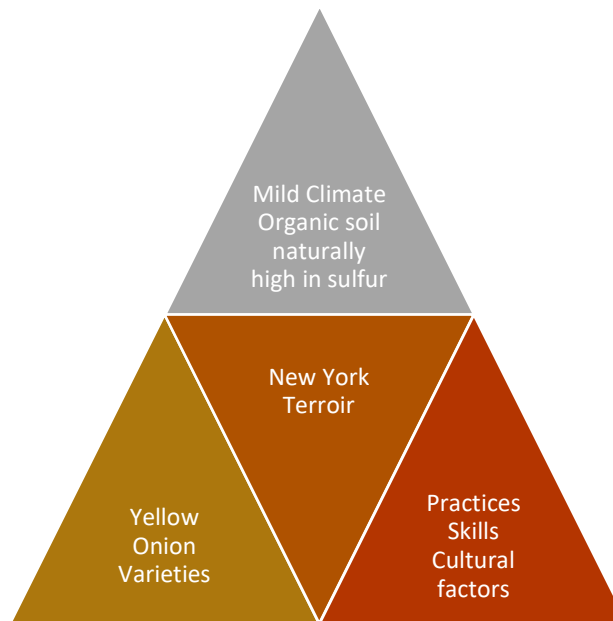

1.4. Interest in exploring the development of a statewide muck onion value chain

A small group of Muck Onion growers (Table 4) has decided to explore their interests in working together to promote their onions on a statewide basis. Started in Fall 2020, the New York Muck Onion Marketing Project explores opportunities for collaborative promotion and marketing among growers, handlers, and retailers. The New York Muck Onion Marketing Project is supported by the Thomas A. Lyson Center, Cornell Cooperative Enterprise Program, Cornell Cooperative Extension. This subsection provides an update of the work of the project’s core group¹⁴.

¹³ <https://newyorkbold.com/> retrieved in September 25, 2020

¹⁴ To address the issue of moving the onion's status to the elite status it deserves, the Thomas A. Lyson Center¹⁴ offered to conduct an AgriCluster Retention and Expansion (ACRE) project with representatives of the New York Muck Onion Industry. ACRE is designed to help farm groups do strategic business planning around an opportunity or challenge. The ACRE Project is also organized to explore marketing options that capitalize on strengths and opportunities of the industry. An announcement was made through Cornell Cooperative Extension networks in the

Table 4. New York Muck Onion Marketing—Project LEADERS

PROJECT LEADERS	AFFILIATION/RESPONSIBILITY
Chris Pawelski	Co-Project Leader, Pawelski Farm, Orange County
Judy Queale-Dunsmoor	Co-Project Leader, Dunsmoor Farm, Oswego County
REGIONAL GROWER REPRESENTATIVES	
Keith Lysack	Orange County Muck
Chris Pawelski	Orange County Muck
Judy Queale-Dunsmoor	Oswego Muck Representative
Joe Disalvo	Oswego Muck Representative
Craig Yunker	Elba Muck Representative

The project leaders’ group attended multiple meetings to map all the SWOTs¹⁵ and additional information and data it had collected into a "Causal Map", which presents a very complex view of the issues and potentials of the New York Muck Onion industry.

This process was then followed by a visioning exercise with the grower representatives, in which each farmer shared their vision for what the New York Muck Onion industry might look in the future with and without any new effort to specialize Muck Onions. The group then drafted a shared vision statement as follows (Table 5):

Table 5. The Shared Vision Statement of the project leaders’ group

New York Muck Onion industry will command a special market segment where consumers value a unique product. This segment provides increased profit, protects competitive advantage, and resiliency/vitality/vibrancy/well-being for growers and all constituents/members of the value chain.

four major onion growing areas of the State inviting two volunteers from each area to participate in the ACRE project. Since fall 2020, the project has involved farmers from the three largest growing areas: Orange County, Oswego County, and Genesee County (Elba Muck). In addition to the onion growers, the NY Muck Onion Marketing Project is supported by the staff of the sponsoring organizations as well as numerous project advisors that represent the Cornell Cooperative Extension, USDA Agricultural Marketing Service, Cornell University faculty and staff, and various New York State programs.

¹⁵ SWOT stands for Strengths, Weaknesses, Opportunities and Threats. A SWOT analysis pulls information internal sources (strengths and weaknesses of an organization) as well as external factors that may have impacts to decisions (opportunities and threats).

The first step of the New York Muck Onion Marketing ACRE Project was a SWOT analysis to flesh out the industry's strengths, weaknesses, opportunities, and threats (Table 6).

Table 6. New York Muck Onion Industry SWOT Analysis

Strengths	Weaknesses
<p>Proximity to markets Good product Health benefits Skill of growers Infrastructure/Technology Established supply chain/Long term relationships Muck soil (natural endowment) Cornell Extension</p>	<p>Lack of consumer knowledge about onions Doing biz in NYS (threat?) Cost of labor, utilities, etc. (level playing field) Lack of funding to invest in technological advances Government regulation (e.g., food safety) Don't market as well as competitors</p>
Threats	Opportunities
<p>Legislative food safety, FSMA, labor Competitors with yellow onions with efficient production Subsidies under the radar (taxation) Fewer young farmers Consolidation of food industry (packers, retailers, input suppliers) Seed genetics on decline Weather/climate Vidalia is marketing as an all-purpose onion</p>	<p>Rising wages throughout U.S. levels the playing field. Consumers are tuned into health. Onions = Good health High fuel prices in future hurt distant competition Consumer Interest in the Origin of food Growth in foodies/cooking Working with retailers to differentiate types of onions and promote NY onions. Work with retailers to educate consumers Control the produce through the value-chain so can't be co-mingled NY Grown and Certified? Use political clout</p>

1.5. Summary of Section 1 and rationale for the report's outline

- ✓ Since 2000, onion production in New York has decreased significantly, resulting in a loss of over 6,000 acres.
- ✓ New York onion yield gains have been too small to compensate for the dramatic acreage decline.
- ✓ Growers are increasingly turning away from onions.
- ✓ New York onion production is becoming increasingly marginal.
- ✓ In 2019, New York produced 3.2% of domestic onions, compared to 9% in 1990 and 22% in 1960.
- ✓ A generic all-purpose sweet is replacing pungent onion on the market.
- ✓ Only 20 onion growers (3.6%), each with more than 100 acres, controlled 80% of total onion production.
- ✓ Mid-size onion farms in New York are not in the relevant profitable value chain.

2. The Global Onion Market

Section 2 aims at providing an overview of the global onion market in terms of imports and exports and its dynamics.

Dry onions (*Allium cepa*) have a long production history in the U.S. Highly adaptable, onions are grown successfully throughout much of North America. Dry onions refer to large, bulbous onions with a shiny, waxy outer layer of skin, sold in stores as yellow, red, or white. There are two main types: sweet onion for fresh consumption (spring/summer) and pungent onions for cooking (Figure 6).

Figure 6. Onion types in the U.S.

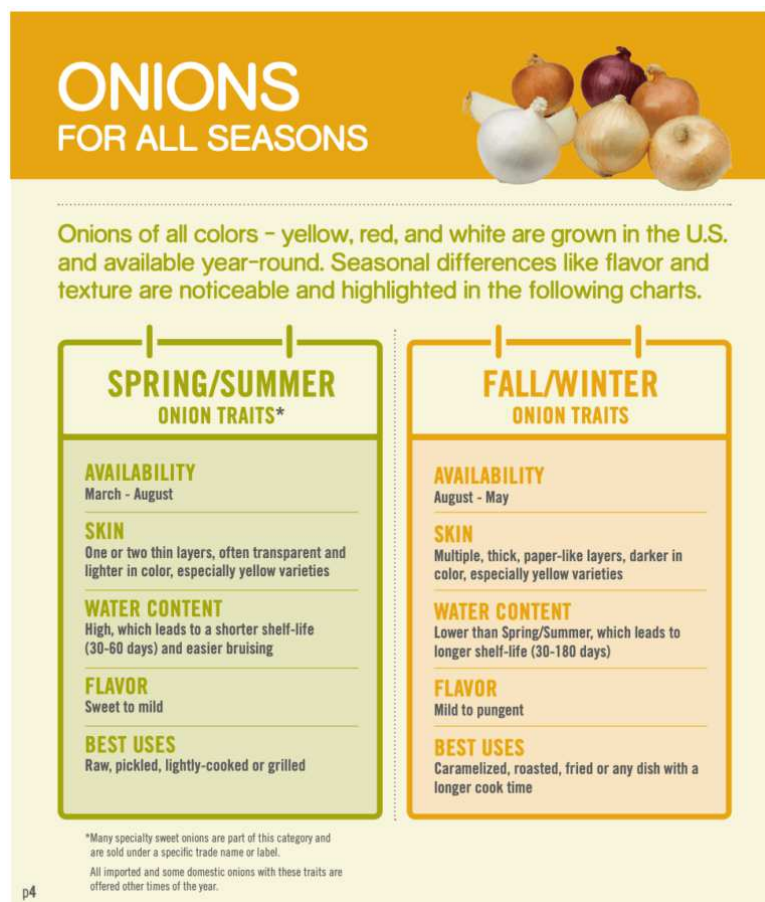

Source: NOA, <https://www.onions-usa.org/all-about-onions/retail/us-production-and-availability/> - Michael J. Havey, USDA-ARS and University of Wisconsin-Madison for NOA

Sweet onion types (Vidalia in Georgia for example) are typically grown in southern states where temperatures tend to be warmer all year round. Sweet onions have a higher concentration of water than solid fiber content and do not store as well as long-day types, which predominate in northern states and have a more pungent flavor (e.g., NY muck-grown onions). This report focuses on yellow onion.

2.1. Worldwide Production

Worldwide, around 100 million tons of onion are produced per year: 93,226,400 tons in 2017, 96,849,585 tons in 2018, and 99,938,016 tons in 2019 (FAOSTAT, 2020)¹⁶. In 2019, China was the largest onion producer globally, with around 24.9 million tons per year (25.6%). India comes second, with 22.8 million tons yearly production in 2019 (20.8%) (AtlasBig, 2021 and FAOSTAT)¹⁷.

The United States is the world's third or fourth-largest producer of onions, with around 3.2 million tons (7,050 million pounds) per year (3.2% of the 100 billion tons grown in 2019). The U.S. was the fourth-largest onion producer globally in 2017 but the third in 2018, just in front of Egypt (3 million tons). The total gross output of onion globally is roughly US\$135 billion per year (our estimation based on FAOSTAT and Atlasbig, 2020)¹⁸.

The next 43 countries produce 45% to reach 95% of total production volume. According to the Herfindahl-Hirschman Index (HHI)¹⁹, the onion market is a moderate concentration market (HHI= 1249<1500). Therefore, it is not considered to be dominated by a few countries.

¹⁶ Requests are made from FAOSTAT: <http://www.fao.org/faostat/en/#data/QC>

¹⁷ <https://www.atlasbig.com/en-us/countries-onion-production>, Retrieved January 12, 2021.

FAOSTAT: www.fao.org/faostat/en/#data/QC

¹⁸ <https://www.atlasbig.com/en-us/countries-onion-production>, Retrieved January 12, 2021.

FAOSTAT: www.fao.org/faostat/en/#data/QC

¹⁹ The Herfindahl-Hirschman Index (HHI) is a widely-used measure of market concentration that can be used to determine market competitiveness. The Herfindahl-Hirschman Index is the sum of the market shares (percentage) of all firms in a particular market after they have been squared. The value of the Herfindahl-Hirschman Index ranges from $10,000/n$ (in the case of perfect competition) to 10,000 (in the case of a full monopoly). The higher the market's concentration, the closer the market is to a monopoly. HHI below 100 indicates a highly competitive industry; HHI between 100 and 1,500 indicates an unconcentrate industry; HHI between 1,500 to 2,500 indicates moderate market concentration; HHI above 2,500 indicates high market concentration.

Worldwide onion production has steadily increased for several years. From 1997 to 2016, production volume was multiplied by a factor of 2.5. From 2000 to 2020, onion volume was multiplied by a factor of two, increasing from 50 million to 100 million tons. This trend is quite impressive (Figure 7).

Figure 7. Global onion production trends (1997-2016) - FAOSTAT

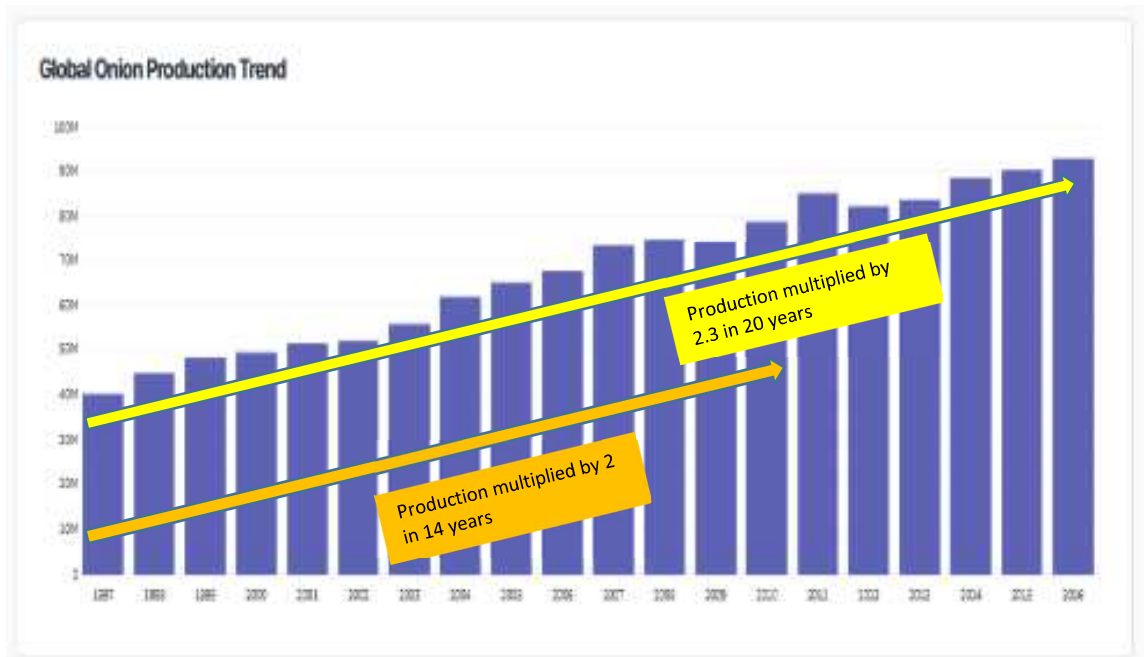

From 2012 to 2018, global onion production increased by 13.5%. China and India continue to produce more onions every year (+1.5% to +2.6% on average) (Figure 8).

Figure 8. Overview of the global onion market (2017). Sources: FAOSTAT & AtlasBig

Country	Rank	Production Volume	Production Share	1-Year Growth in Production
 China	1	23.85M	25.6%	+1.7%
 India	2	19.42M	20.8%	+2.6%
 Egypt	3	3.12M	3.3%	+2.2%
 United States	4	3.03M	3.2%	-0.7%
 Iran	5	2.35M	2.5%	-3.3%
 Turkey	6	2.12M	2.3%	+12.8%
 Russia	7	2.02M	2.2%	-3.7%

In many countries, onions are a staple food, which can increase food security. The U.S. domestic supply of onions is available all year round and onions generally have good suitability for long-term storage. In hot weather, U.S. consumers prefer to use the juicy and sweet onions available in spring and summer. In colder weather, consumers generally turn to onion soups or stews available in the fall and winter. This versatility may explain the success of onion production worldwide. To support the idea that onions are a staple food, we can compare their production to other well-known staple foods (Table 7).

Table 7. Yearly production (million tons) of staple foods in 2019

Food	Paddy Rice	Potatoes	Banana	Onion dry	Apple	Cabbage & brassica	Carrots & turnips
Production in million tons	755	370	116	100	87	70	45

Source: FAOSTAT, 2020

2.2. Overview of global trade and the U.S. position

According to Daniel Workman from World's Top Exports (WTE^x)²⁰, global sales from exported onions totaled US\$3.99 billion in 2019. If we consider the value of total gross output worldwide (US\$135 billion per year in 2019), global trade (exports) represents less than 3%. While global

²⁰ <https://www.worldstopexports.com/onions-exports-by-country/> Retrieved on January 8, 2021.

trade seems marginal, the value of exported onions rose by an average of 21.6% for all exporting countries from 2015 to 2019²¹. Countries that are the major exporters are also the main producers. China, India, the U.S., Egypt, and Mexico sold nearly half (48%) of exported onions during 2019. Nevertheless, on a worldwide scale, onion trade is marginal. Because onions are a strategic staple food that ensures food security especially in the Global South, many countries likely managed to avoid overproduction or shortage rather than to generate currencies (Keatinge et al., 2011). However, some countries like the U.S. are both a high importer and exporter.

In 2019, the U.S. exported 837²² million pounds of onions while it imported 1.254 billion pounds, yielding a negative trade balance of 417 pounds (Figure 9). Imports accounted for 18% of the fresh-market onions consumed in the U.S. in 2019.

U.S. onion imports and export grew steadily between 1970 and 1993. However, in 1994, U.S. onion exports plateaued, while imports grew dramatically (Figure 9). Around 668 million pounds were imported in 2006 and 1.2 million pounds in 2019, i.e., almost a 100% increase! Total imports in 2019 valued around US\$431 million, US\$200 million more than exports.

Figure 9. U.S. Onions: Import vs Export - 1970/2019 - Source (USDA- Economic research service)

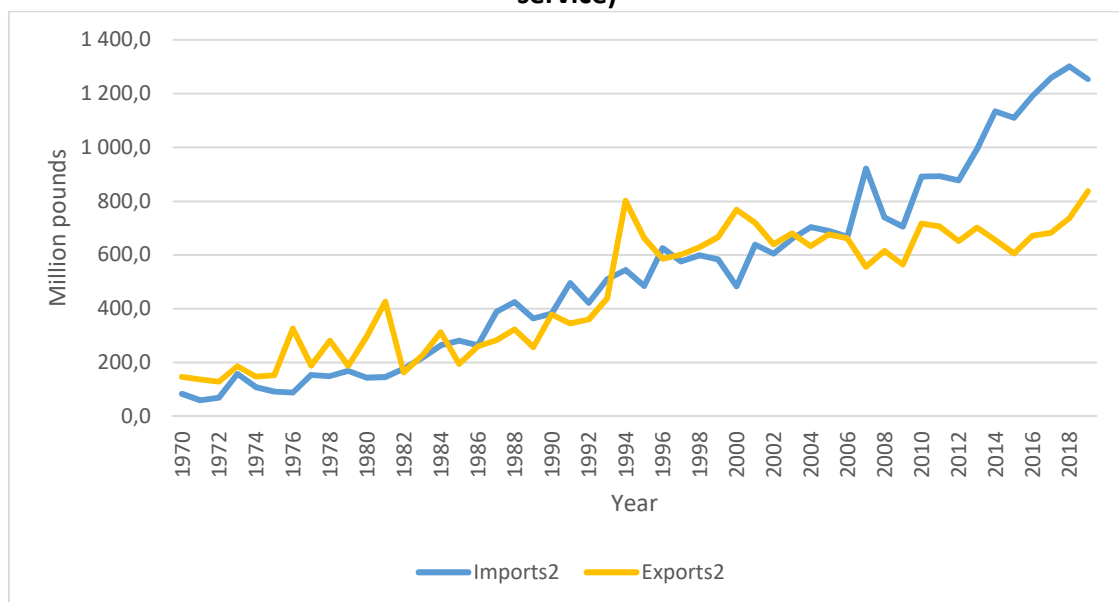

²¹ <http://www.worldstopexports.com/onions-exports-by-country/> Retrieved on January 12, 2021.

²² There is a difference between fresh bulb onion data (Figure 9 and Table 8) due to onion sets and canned onions.

In 2018, worldwide onion imports were 8.4 million tons, with a value of US\$3.5 billion (up 5% from 2017). The U.S. is the largest importer of onions worldwide.

The main world importers were:

1. U.S. (US\$445 million, 12.7%)
2. Vietnam (US\$255 million, 7.3%)
3. UK (US\$229 million, 6.5%)

The U.S. imports 68% in volume from its two neighbors, Mexico and Canada (Table 10). Mexico represents 60% in volume and remains the dominant supplier to the U.S. In 2019, out of 1,200 million pounds, approximately 700 million pounds were imported from Mexico. However, after many years of increases (a record high of 781.7 million pounds was recorded in 2018), imports from Mexico dropped to 673.2 million pounds in 2019, valued US\$315 million (Table 8). Imports from Canada were stable for the last four years (2016 to 2019). 135 to 145 million pounds are imported every year, comprising 10% of U.S. imports by volume. The Canadian market share remains stable but consists of pungent onion, while imports from Mexico and Peru are sweet onion types. Peru is also a major exporter to the U.S., constituting 28.8% by volume of total U.S. imports in 2019. Peru is a newcomer to the export market. Vidalia onion growers from Georgia have expanded their businesses to Peru to supply the U.S. sweet onion market during the winter-spring. U.S. imports from Peru continue to grow and will probably reach Mexico's import volume. Peru represents 28.8% of U.S. onion imports by volume but only 14.6% by value; to conquer the American onion market, Peru (or Vidalia onion growers) likely dump production at a very low price.

U.S. imports reached a record high in 2019 of 345.9 million pounds, 55.9 million pounds more than in 2016. Therefore, when Peru is added to Mexico and Canada, the U.S. imports 96% in volume from only three countries. Typically, three-fourths of all fresh-market onion imports enter the U.S. market during the winter months, when the last spring-summer harvest has been sold.

Table 8. U.S. onion import 2016/2019 sources by value (\$1,000) & by volume (1,000 lbs) (USDA)

Import sources by value (\$1,000)			Annual	Annual	Annual	Annual	Annual
			Average	2016	2017	2018	2019
Share*	All countries	Annual trend	422 751	430 175	409 904	419 450	431 477
75,56%	Mexico		314 346	328 187	303 626	311 019	314 552
11,61%	Peru		53 000	47 478	50 604	52 334	61 583
9,53%	Canada		41 012	39 399	40 266	43 859	40 522
1,26%	Netherlands		5 412	4 628	5 487	5 199	6 334
	Major countries		413 769	419 691	399 983	412 411	422 992

Import sources by volume (1,000 lbs)			Annual	Annual	Annual	Annual	Annual
			Average	2016	2017	2018	2019
Share*	All countries	Annual trend	1 202 951	1 148 978	1 212 444	1 252 518	1 197 865
62,73%	Mexico		729 465	716 398	746 563	781 737	673 162
22,26%	Peru		289 938	253 326	272 179	288 376	345 871
11,49%	Canada		140 107	135 979	142 572	146 937	134 942
1,31%	Netherlands		16 229	13 287	21 265	14 427	15 936
	Major countries		1 175 739	1 118 990	1 182 579	1 231 477	1 169 910

The average onion import price for all countries is US\$351/1000 lbs., or 35 cents per pound. The Mexican onion price is on average around US\$431/1000 lbs. Peru's price is US\$183/1000 lbs. on average. Canada's price is US\$293-300/1000 lbs. when imported and US\$320/1000 lbs when exported (Figure 10).

Figure 10. Prices of onions imported by the U.S. from 3 main countries - 2016 to 2019 - Import sources by value/volume (\$/1,000 lbs) (USDA)

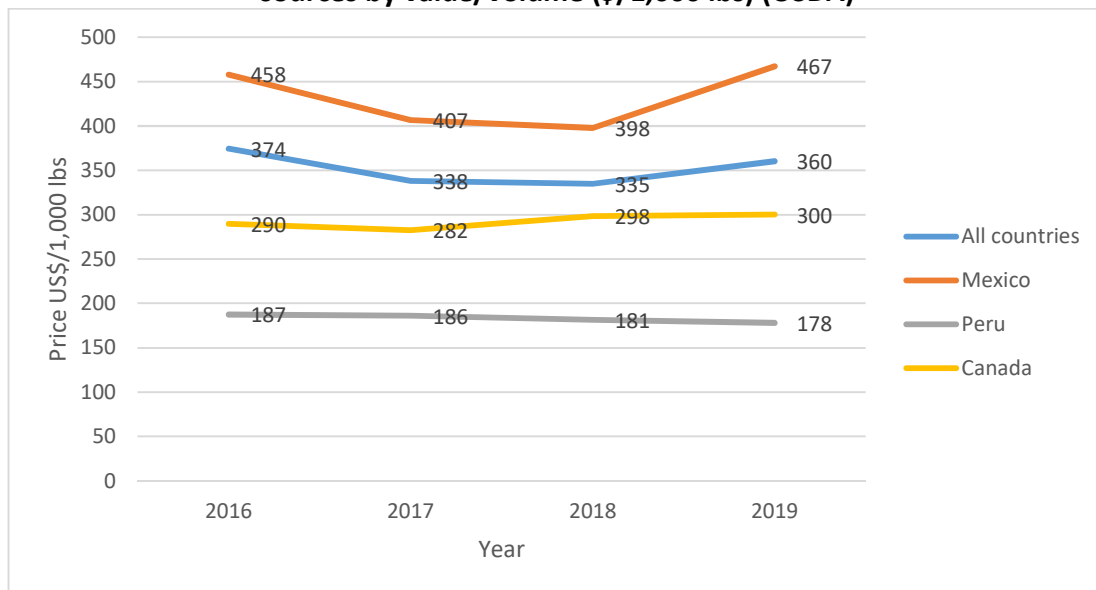

We can observe that when imported volumes increase, unit prices decrease simultaneously, but the imported value remains the same (Figure 11).

Figure 11. U.S. Onion import 2016 to 2020 (USDA)

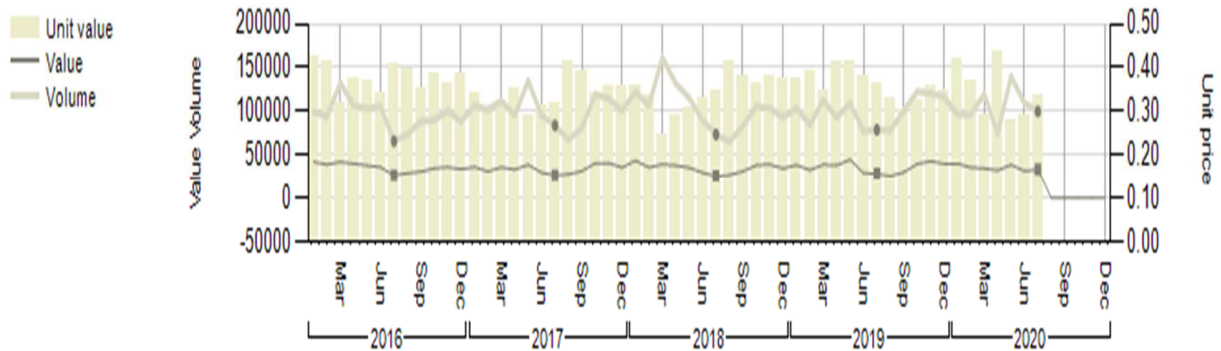

Now let us turn to onion exports from the U.S. to other countries.

From 1996 to 2016, around 600 million pounds were exported every year. Since 2016, exports have grown to reach 810 million pounds in 2019. Total U.S. exports by value in 2019 were around US\$237 million.

In 2019, 80% of total U.S. exports went to Canada and Mexico (Table 9). Out of 810 million pounds, 662 million pounds were exported to these two countries, which are partners of the United States–Mexico–Canada Agreement (USMCA), which took effect on July 1, 2020. This new agreement replaced the North American Free Trade Agreement (NAFTA), which came into force on January 1, 1994. The U.S. also exports to two other countries, Taiwan and the United Kingdom.

Table 9. U.S. Onion export sources by value (\$1,000) & by volume (1,000 lbs) (USDA)

Exports by value (\$1,000)			Annual Average	Annual 2016	Annual 2017	Annual 2018	Annual 2019
Share*	All countries	Annual trend	200 599	192 773	183 627	189 221	236 775
59,16%	Canada		118 680	121 353	106 465	110 786	136 115
21,07%	Mexico		42 264	24 514	43 598	37 633	63 312
6,56%	Taiwan		13 165	17 755	14 619	12 950	7 335
3,75%	United Kingdom		7 512	9 830	6 373	6 805	7 041
	Major countries	2016 2017 2018 2019		173 452	171 054	168 175	213 803

Exports by volume (1,000 lbs)			Annual Average	Annual 2016	Annual 2017	Annual 2018	Annual 2019
Share*	All countries	Annual trend	712 519	662 033	670 012	708 439	809 592
50,73%	Canada		361 452	365 176	355 447	342 540	382 645
26,63%	Mexico		189 714	117 316	179 503	181 056	280 981
11,67%	Taiwan		83 161	105 698	87 618	93 505	45 826
1,53%	United Kingdom		10 865	11 961	8 599	10 310	12 590
	Major countries	2016 2017 2018 2019		600 151	631 167	627 411	722 041

It is important to note that the average export price for the last four years was US\$282/1000 lbs. while the import price was US\$351/1000 lbs., or 35 cents per pound. Canada's average onion price is around US\$328/1000 lbs. Mexico's price on average is US\$223/1000 lbs (Figure 12).

Figure 12. Prices of onions Exported by the U.S. from three main countries - 2016 to 2019 - Import sources by value/volume (\$/1,000 lbs) (USDA)

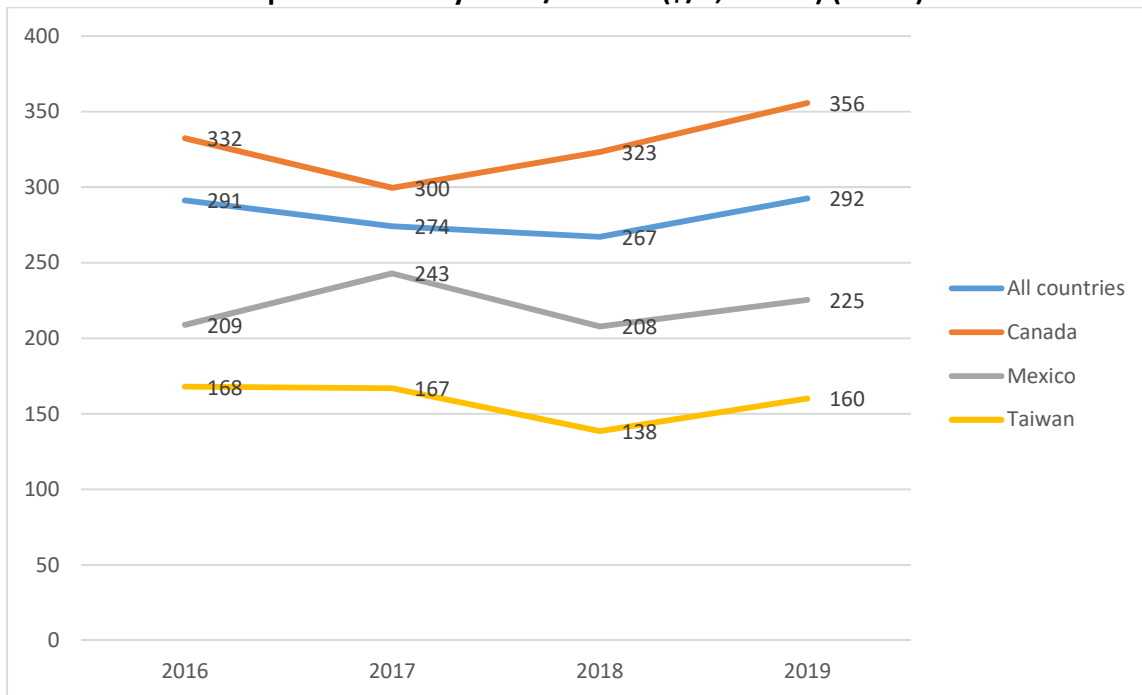

When we look at the evolution of exports over the last four years, we can observe that when volumes exported increase (and sometimes exports increase dramatically), unit price decreases simultaneously. Still, in the end, the exported value is roughly the same (Figure 13).

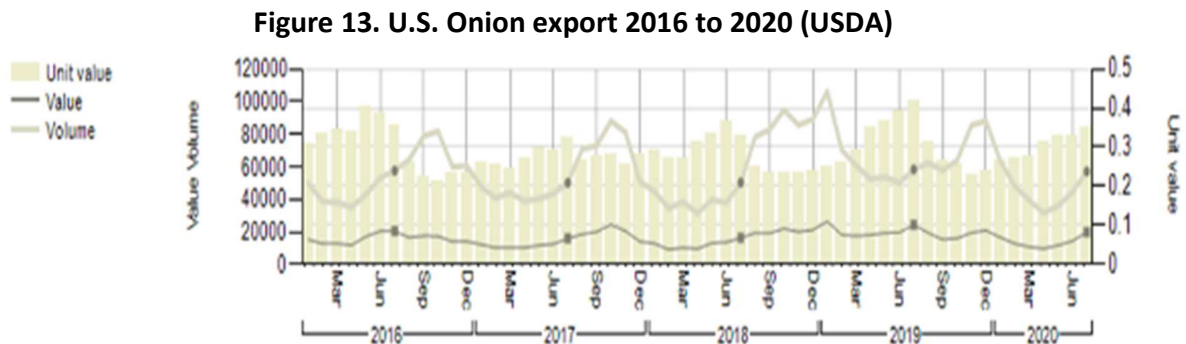

This situation seems to depict a lack of capacity of U.S. growers and handlers to control their production—as though they have been forced to dispose of overproduction. Several explanations are possible:

- (1) U.S. exporters lack storage capacity;
- (2) Exceptionally good weather conditions allowed overproduction and U.S. growers needed to dump it. The objective for U.S. exporters is to find a market and they offer discounts to sell their overage stocks;
- (3) Competition with other countries to export onions to Canada is very tough and tariff concessions must be made to maintain a competitive advantage. This explanation seems relevant when we know that the U.S. has succeeded in keeping its market share around two-thirds over the last four years against Mexico and Peru, two other competitors on the Canadian onion market.

The behavior of the U.S. in the global onion market is very specific and differs from other countries. The U.S. is one of the biggest producers worldwide, producing 7,050 million pounds; the U.S. imports 1,197 million pounds and exports 809 million pounds. U.S. exports represent 11.5% of total domestic production. The U.S. international trade deficit in fresh onions amounts to over 388 million pounds and is valued at US\$196 million for 2019.

As depicted below (Figure 9), the U.S. has experienced a trade deficit since 2006. This deficit has dramatically increased since 2010 (Figure 14).

Figure 14. Deterioration of the balance of trade - Onion Fresh 2008/2019 (USDA)

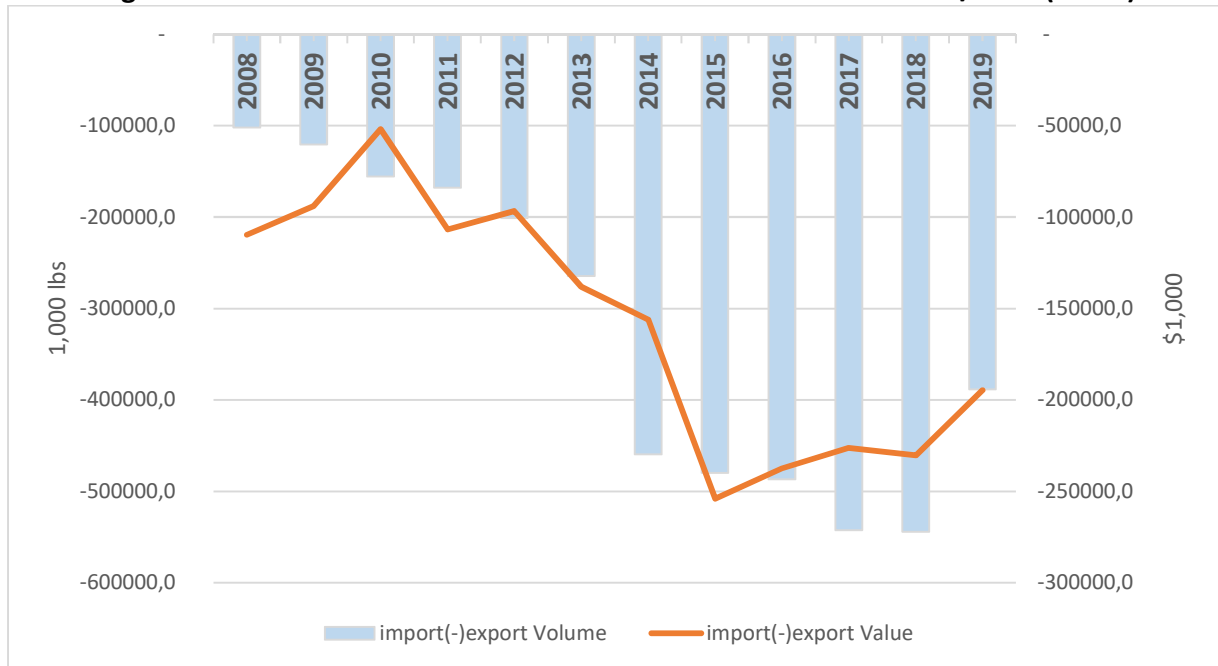

The trade deficit over the last ten years is due to four changes (Figure 15):

- the main determinant is the large and growing deficit with Mexico;
- the growing deficit with Peru;
- the deterioration of the trade surplus with other countries;
- the stagnating trade surplus with Canada that cannot offset the deficit with Peru and Mexico.

Figure 15. Evolution of Onion U.S. Balance of Trade 2010/2019 (USDA)

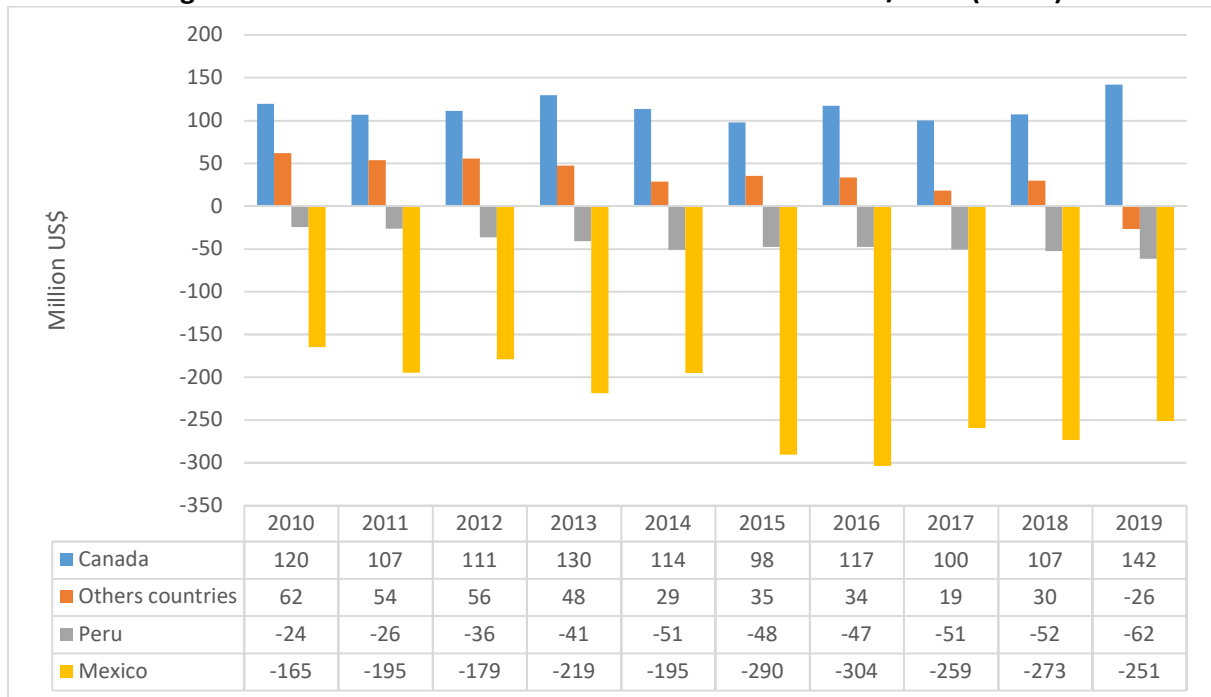

This deficit might signal a decline in the U.S. position in the global onion market. For example, an increase in U.S. imports of onions from Mexico is illustrative of a larger issue. According to USTR, USDA, USDC (2020, p. 2)²³, “the dramatic increase in U.S. imports of fresh fruits and vegetables from Mexico since NAFTA entered into force is undeniable. In 1993, the United States imported approximately US\$1.2 billion of fresh fruits and vegetables from Mexico. By 2019, imports had increased 1,025 percent to US\$13.5 billion.”

U.S. growers and government officials suppose that unfair foreign pricing and foreign government subsidies (in Mexico and Canada) distort the free flow of goods and adversely injure domestic onion growers. Unfair trade practices (i.e., dumping or subsidies) could explain why Mexico has had a competitive advantage in exports to the U.S. for over 20 years. U.S. administrations are now trying to find evidence of unfair trade practices. The United States Trade Representative (USTR) will work with domestic producers and the International Trade Commission to monitor and

²³ USTR, USDA, Commerce (USDC), 2020, *Report on Seasonal and Perishable Products in U.S. Commerce*, Office of the United States Trade Representative (USTR), United States Department of Agriculture (USDA), and the United States Department of Commerce (Commerce), September 1, 2020, 28 p.
<https://ustr.gov/sites/default/files/files/reports/2020/ReportSeasonalPerishableProductsUSCommerce.pdf>

investigate imports of strawberries and bell peppers, which could enable an expedited Section 201 Global Safeguard Investigation. The onion trade is not included in this investigation.

Moreover, there are other explanations for Mexico's exports. It seems that some exporters from Mexico and Peru are in fact U.S. producers. Some U.S. growers consider that Mexico will knock them out of the marketplace if they cannot produce onion in the U.S. at a lower price²⁴. Since 2010, if they met difficulties with labor legislation when importing immigrant farm labor in the U.S., some growers have decided to move to Mexico or Peru. According to Eleconomista & Fresh Plaza²⁵, Mexico was a crucial place to produce onion to supply Mexican domestic consumption and U.S. demand:

"In Mexico, the onion crop is the fifth most important vegetable. In 2011, less than 50,000 hectares were harvested, producing nearly 1.3 million metric tons. In 2019, the production of onions in Mexico reached 1.49 million metric tons (FAOSTAT). Between 2012 and 2018, Mexico's onion production increased by 27 percent (Figure 16). Exports for 2011 were in the order of 303,500 tons, of which 89% were for the U.S. market, equivalent to 19.5% of national production. 95% of Mexican production is concentrated in Chihuahua, Tamaulipas, Michoacan, Baja California, Guanajuato, Zacatecas, Morelos, Puebla, San Luis Potosi, Jalisco and Sonora, targeting 85% of the fresh produce for domestic consumption, 15% for processing. In seven states (Tamaulipas, Chihuahua, Zacatecas, Baja California; Michoacan and Guanajuato), 74% of the national production of onion is concentrated, which together account for 70% of the national area planted. In 2019, 368,870 tons were exported while 64,000 tons were imported. 305,341 tons (83%) were exported to the U.S. market. The onion crop is sown in autumn-winter cycles (AW) and spring-summer (SS), with 80% of the area planted under irrigation regimes and 20% under rain-fed conditions, allowing the fresh supply of this product all year. In 2011, from March to June, 81% of

²⁴ The World, December 30, 2010, retrieved January 15, 2021 - <https://www.pri.org/stories/2010-12-30/why-some-american-farmers-are-moving-mexico>

²⁵ Fresh Plaza retrieved January 15, 2021 <https://www.freshplaza.com/article/2104408/mexico-the-main-onion-producer/>

the AW production was concentrated at 700,000 tons, while 91% of the SS Cycle was close to 600,000 tons, concentrated in the period from August to January”.

Figure 16. Evolution of Onion production in Mexico 2012/2019 (FAO)

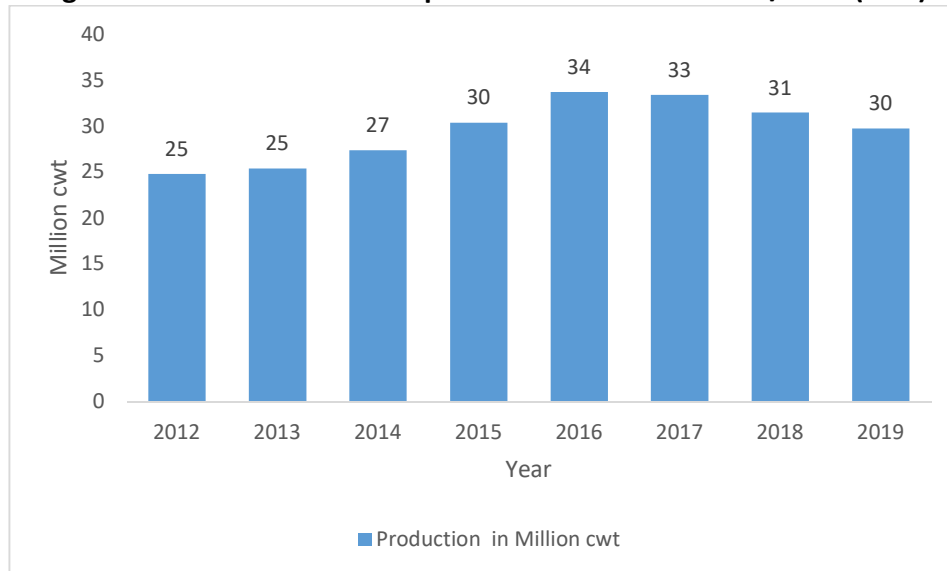

Peru is a newcomer to the export market. Vidalia onion growers from Georgia have expanded their businesses to Peru to supply the sweet onion market during the winter-spring when Vidalia is out of season in the U.S. For example, Bland Farms²⁶, one of the largest growers and shippers of sweet onions in the U.S., expanded production outside of Georgia, domestically and internationally, and into Texas, California, Peru, and Mexico. We can read on the Bland Farms website: “These strategic growing partnerships have proven themselves to be extremely valuable, allowing Bland Farms to supply sweet onions year-round”²⁷(Map 2 and table 10). We can find this same message in the report “An Overview of Strawberry Production in Mexico” from Florida University (Wu et al., 2017)²⁸. Central Mexico is an ideal area for U.S. growers to produce winter vegetables to meet consumer demand year-round.

²⁶ Currently Bland Farms represents half of the entire Vidalia volume and has the biggest controlled-environment storage capacity in the industry. <https://blandfarms.com/bland-farms-remains-a-leader-in-vidalia-onions/> Retrieved January 5, 2021

²⁷ <https://blandfarms.com/about-us/meet-the-blands/> Retrieved January 15, 2021

²⁸ Feng Wu, Zhengfei Guan, J. Jaime Arana-Coronado, and Melvin Garcia-Nazariiega, 2017, An Overview of Strawberry Production in Mexico, EDIS document FE1014, University of Florida, 5 p. EDIS document FE1014 is a

Likewise, to secure onion supplies, U.S. importers provide financial support to Mexican growers in exchange for onion contracts (Wu et al., 2017). Mexican growers' demand for substantial capital investment (e.g., irrigation, machinery, etc.) cannot generally be met by the Mexican national banking system. Some U.S. importers have become lenders to Mexican agriculture. Indeed, the primary competitors of the U.S. agricultural economy are often U.S. growers and handlers themselves.

Nevertheless, in the 2020 *Report on Seasonal and Perishable Products* from the U.S. Department of Commerce, there were no complaints from U.S. sweet onion growers against Mexican onion exports, likely because U.S. growers are involved in growing both in the U.S. and in Mexico.

Map 2. An example of the year-round strategy: Bland Farms, growing & shipping areas 202129



²⁹ Brand Farms website: <https://blandfarms.com/premium-sweet-onions/#:~:text=Our%20Mexican%20sweet%20onions%20originate,and%20Vidalia%20sweet%20onions.> Retrieved January 31, 2021

Table 10. The key to year-round production – Bland Farms³⁰

VARIETY	JAN	FEB	MAR	APR	MAY	JUN	JUL	AUG	SEPT	OCT	NOV	DEC
PERU												
MEXICO-TAMPICO												
TEXAS 100E												
VIDALIA® FRESH												
VIDALIA® STORAGE												
ORGANIC VIDALIA®												
CALIFORNIA SWEETS												
NEVADA SWEETS												

2.3. Canadian onion exports to New York: unfair competition or not?

The relationship between U.S. growers and Canadian exports is quite different from the relationship of the U.S. to Mexico and Peru.

2.3.1. The arguments of the controversy

Here is an overview of onion production and trade in Canada. Canada is a small producer of onion with about 15,000 acres dedicated to this production. In 2009, 242,387 metric tons were produced. Ten years later (2018), the production was close to 240,000 metric tons, harvested approximatively on 13,500 acres. Canada imported 178,165 metric tons in 2019, mostly from the U.S. with 173,500 metric tons (382 million pounds) (97%). When we look at Canadian statistics of onions, Canadian imports are mainly from three countries (96.4%): the U.S., Mexico, and Peru (Table 11).

³⁰ Brand Farms website: <https://blandfarms.com/premium-sweet-onions/#:~:text=Our%20Mexican%20sweet%20onions%20originate,and%20Vidalia%C2%AE%20sweet%20onions.> Retrieved January 31, 2021

Table 11. Canadian onion imports (value in US\$1,000) from three main countries - 2016 to 2019 - Statistics Canada³¹

Country	2016	2017	2018	2019	% share 2016-2019
U.S.	103,825	90,120	94,542	119,045	65.9%
Mexico	38,259	37,808	42,841	47,590	26.9%
Peru	5,545	5,159	5,449	5,732	3.5%
Subtotal	147,629	133,087	142,832	172,367	96.4%
Other countries	4,852	4,461	6,440	6,311	3.6%
Total (All countries)	152,481	137,548	149,272	178,677	100%

New York growers have complained for several years against what they consider an unfair trade practice supported by the Canadian government. In February 2020, Senator Chuck Schumer alleged that *“due to Canada’s suspected unfair pricing practices, cheap Canadian onions are flooding United States markets and leaving New York onion farmers at a steep competitive disadvantage.”* According to the National Onion Association (NOA, 2020): *“Canadian onions were selling recently in New York at \$9 for 48 pounds...”* U.S. farmers need a minimum of US\$10-US\$13 to meet production costs. In a February 2020 statement, Senator Gillibrand said^{32 33}: *“New York State is home to prime onion-producing land, yet our farmers are unable to sell their goods in a domestic market that is flooded by cheap Canadian exports. Farmers across the country have been struggling to keep up with growing production costs, while Canadian exporters have been able to dump cheap onions onto the market at prices comparable to 30 years ago.”* U.S. onion growers have called, with the support of both NY senators, for an investigation into Canadian practices that are considered anti-competitive. Based on our knowledge, the results of such an investigation have not been released to date. We don't know if the USDA conducted this investigation. Moreover, in the *Report on Seasonal and Perishable Products*, released by the U.S.

³¹ The data from Canada come from Statistics Canada and the U.S. Census Bureau
<https://www.ic.gc.ca/app/scr/tdst/tdo/crtr.html?&productType=HS6&lang=eng>

³² U.S. Senators Kirsten Gillibrand, a member of the Senate Agriculture Committee, and Senate Minority Leader Chuck Schumer called for an investigation into unfair trade subsidies to Canadian growers.
<https://www.gillibrand.senate.gov/news/press/release/as-new-york-farmers-struggle-against-influx-of-cheap-canadian-produce-gillibrand-and-schumer-call-for-investigation-into-unfair-trade-subsidies>

³³ In Civileats, By Lisa Held February 7, 2020 - <https://civileats.com/2020/02/07/new-york-farmers-are-struggling-to-sell-their-onions-u-s-lawmakers-want-a-trade-investigation/> Retrieved October 20, 2020.

Department of Commerce in 2020, there are only three complaints from U.S. growers or representatives³⁴:

John Hoblick, Florida Farm Bureau Federation: *“No longer is this a dilemma confined to one state or one commodity. In addition to story after story from Florida specialty crop producers, you’ll likely receive insightful comments from asparagus farmers in Michigan, blueberry growers in Georgia, or onion producers in New York, all experiencing the familiar unfair trade practices that will persist without a remedy”*(Hearing Transcript, Aug. 13, 2020, at 80)

David Fisher, New York Farm Bureau: *“There is concern that unfair subsidization of Canadian produce is occurring, which makes it possible and profitable for Canadian farmers to ship and sell produce in the U.S. either as country export or through individual provincial programs”* (Hearing Transcript, Aug. 20, 2020, at 65)

Zippy Duvall, American Farm Bureau Federation: *“[T]his is not just a Southern or Southeastern problem. It reaches up into New York. It reaches up in, I think we had some New England people testifying on the first hearing. And I also know that I’ve heard concerns from Michigan. So, this problem exists all over our country when it comes to fruits and vegetables”* (Hearing Transcript, Aug. 20, 2020, at 49)

Despite these complaints, the USTR has not requested that the International Trade Commission (ITC) initiate a Section 201 Global Safeguard Investigation into the extent to which increased imports of onions have caused serious injury to New York growers. The only request concerns blueberry production. To investigate, ITC needs to receive a petition from domestic producers or a request from the Administration (no request or petition was received by the end of December 2020). The ICT then investigates whether increased imports of a product are causing or

³⁴ A number of individuals testified that imports of seasonal agricultural products are not an issue confined to the southeastern United States, and that other regions of the country are affected by this issue, including imports from other markets in addition to Mexico. Hearings recorded in the USTR, USDA, Commerce (USDC), Report on Seasonal and Perishable Products in U.S. Commerce, 2020.

threatening to cause serious injury to domestic producers of the product. If so, a positive adjustment to import competition could be decided by the President. It can be assumed that no evidence has been provided to warrant an investigation.

According to United Press International (UPI)³⁵, an Agri-Food Canada spokesman wrote in an email to the author that *“Canada does not unfairly subsidize its onion industry or its onion exports,”* nor does it have *“commodity-specific programs to support the onion industry and does not provide export subsidies to its vegetable sector.”* Moreover, it seems unlikely that Canada subsidized its producers in February 2020 under the U.S.-Mexico-Canada agreement that was just signed in 2020.

To better understand this situation with Canada, I investigate several Canadian export support programs, including the Québec program, “Soutien aux exportations bioalimentaires (SEB)” or “Support for biofood exports,” and the Price Pooling Program.

2.3.2. Support for biofood exports

Québec is a major exporter to New York, with US\$10.5 million out of US\$12.8 million in Canadian exports (Table 12 below). SEB (and similar programs in other provinces³⁶) is strictly a market development assistance program. None of these programs provide direct financial support for exports that would improve the competitiveness of Canadian products. SEB is a funding program offered through the Export Fund to accelerate projects to develop markets outside of the province by Québec agri-food businesses³⁷. The assistance is for enterprises that wish to:

- Better prepare and strengthen their export capacity
- Diversify their markets outside of Québec.

³⁵ Jessie Higgins, February 24, 2020, U.S. onion growers fear Canadian exports could put them out of business, https://www.upi.com/Top_News/US/2020/02/24/US-onion-growers-fear-Canadian-exports-could-put-them-out-of-business/3581581625583/

³⁶ <https://www.agr.gc.ca/eng/commerce-international/?id=1432136045585>

³⁷ http://www.groupeexport.ca/en/programmes/programme_mapaq

The Agri-Food Export Group website provides details on eligible clientele: *“For-profit and social economy agri-food enterprises that are legally incorporated in Québec, and which have an establishment in the province, that market, for a minimum of two years at the time of application, agri-food products or food produced or processed in Québec.”* To be eligible, a project must aim to develop a new market or diversify within a market, incur expenditures of at least CA\$10,000, and include one or more of the eligible activities.

The program’s aid is for logistics related to market development, not export expenses (e.g., transportation, customs, etc.). Therefore, eligible activities concern the acquisition of skills of potential exporters to better understand foreign markets and to assess their ability to export. I have identified 10 technical assistances:

- Gathering market intelligence (custom research, reports, and studies);
- Applying for intellectual property protection in international markets;
- Applying for certification in international markets;
- Seeking expert legal and business advice;
- Search engine optimization;
- Translating, adapting, or creating marketing materials;
- Attending virtual trade shows, networking functions, meetings, or conferences³⁸;
- Visits to foreign markets;
- In-person participation at trade shows (e.g., Summer Fancy Food Show), networking functions, meetings, or conferences;
- Participating in a trade mission

All these supports are compatible with international trade. We can observe that the number of supports is limited and not very important per firm (Table 12).

³⁸ For an example of what activities are promoted, have a look at the publications that are published in the "Food Processing and Distribution" section of the Ministry of Agriculture, Fisheries and Food's website Québec at <https://www.mapaq.gouv.qc.ca/SiteCollectionDocuments/TransformationPortail/Regardsurlemarche/RegardsurlemarcheNewYork.pdf>

Table 12. Eligible activities and maximum financial assistance (\$Canadian) (2020)
Source: Agri-Food Export Group

Activity	Maximum financial assistance
Hiring of specialist for markets development outside of Québec	<ul style="list-style-type: none"> • Hiring of one person until the expiry of the Soutien aux exportations bioalimentaires program anticipated for March 31, 2021 • \$30,000 over a continuous period of 52 weeks
Access to an online sales platform	<ul style="list-style-type: none"> • First year of access only • \$10,000 per platform
Registration of a trade mark	<ul style="list-style-type: none"> • \$10,000 per year
Provision of merchandizing expertise	<ul style="list-style-type: none"> • \$25,000 per year
Recruitment of an agent or distributor	<ul style="list-style-type: none"> • \$25,000 per year
Purchase of market data	<ul style="list-style-type: none"> • \$25,000 per year

The maximum eligible rate for consulting and support fees is \$150/hour, the excess of this rate is not eligible.

The SEB program financed 119 applicants with CA\$7.47 million (US\$ 5.87 million) for 2018/2019, i.e., CA\$62,770/applicant (or US\$49,400/applicant). The SEB supports 15 agricultural product categories, exported to the U.S., Europe, Asia, and Mexico. These figures invite us to put in perspective the potential distorting effects of this type of support on the onion market. Indeed, it appears that it is not these few tens of thousands of dollars of technical support that could give Canada a competitive advantage.

I have made the following estimate: CA\$7.47 million (US\$5.87 million) is allocated per Export Group each year to support exporters in better understanding foreign markets. Onion exports to New York from Quebec (US\$12.8 million) represent 0.17% of the Total Agri-food exports (US\$6,931 million)³⁹. Applying a simple rule of proportionality, all Canadian companies exporting onions to New York from Quebec may receive about US\$13,000 per year. In other words, this very low level of aid is not likely to create the slightest distortion of competition.

³⁹ <https://www.mapaq.gouv.qc.ca/fr/md/statistiques/Pages/exportation.aspx>, visited January 12, 2021

2.3.3. Price Pooling Program

Another issue that needs to be clarified is the “Price Pooling Program,” administered by the Minister of Agriculture and Agri-Food of Canada (AAFC). This program provides a price guarantee that protects marketing agencies and producers against unanticipated declines in the market price of their products⁴⁰. As we can read on the AAFC website, program participants use the price guarantee as security in obtaining credit from lending institutions. This credit allows the marketing agency to improve producers' cash flow through an initial payment for products delivered. It also provides equal returns to producers for products of like grades, varieties, and types. This program is designed to assist and encourage cooperative marketing of eligible agricultural products, including processed products. Price pooling Program participants use the price guarantee as collateral to obtain the necessary financing from financial institutions. In turn, this financing allows the marketing agency to improve producer liquidity through upfront payment for delivered agricultural products, and ensures equal returns to producers for products of the same grade, variety and type. Section 30 of the Agricultural Marketing Programs Act provides that payments to be made by the Minister under price guarantee agreements shall be made out of the Consolidated Revenue Fund by the Minister of Finance, with the approval of the Governor in Council.

The Price Pooling Program corresponds to an “equalization fund” that serves to stabilize prices and secure the economic horizon of farmers. The price guarantee is set at a percentage of the expected average wholesale price of the product. For example, the expected average wholesale price of onions is CA\$17/cwt. The price guarantee paid to the grower is CA\$15.30/cwt if the percentage applied is 90%. Once the entire agricultural product is sold, the actual average wholesale price received by the marketing agency is determined. If the calculated value is less than the guaranteed value (the initial payment plus the eligible costs), the program allows for payment for the shortfall by the Government of Canada. For our example, if the price was

⁴⁰ <https://agriculture.canada.ca/en/agricultural-programs-and-services/price-pooling-program/contact-information>, visited January 15, 2021

CA\$14/cwt, the Government will pay CA\$1.3/cwt (CA\$15.30 – CA\$14.00). If the calculated value is greater, the surplus is retained by the pool for future use or distributed by the marketing agency to the producers according to the grade, variety, and type of product they delivered to the pool. For example, if the price was CA\$16.80/cwt, the marketing agency can save CA\$1.5/cwt (CA\$16.80 – CA\$15.30). The price guarantee is established for each grade of agricultural commodity covered. The price guarantee is expressed in units of measure, for example, CA\$15.30/cwt of a yellow medium onion. The determination of the price guarantee is based on the commodities and grades to be sold, not the grade delivered to the pool. If a compensation is claimed, the eventual payment to be made will be determined using the grade that appears on the invoice or sales contract. In addition, the price obtained must be the best possible price and not a fire sale price. One of the objectives of the pooling price program is to encourage producers to form marketing agencies, to take advantage of marketing opportunities.

The Government of Canada aims at reducing its support while at the same time succeeding in helping growers access markets and increase prices. Therefore, on the one hand, the marketing agency requests a maximum price guarantee for each agricultural product being pooled based on its expected average wholesale price (EAWP) for a given period. On the other hand, experts from AAFC also determine an EAWP for the same period and the level of risk related to the marketing of the product, considering factors such as production, demand, quality, and price trends of the market. A review committee determines the risks related to the marketing agency's ability to implement the proposed marketing plan and guarantee the agricultural product. The maximum price guarantee is then determined by applying a risk factor to the EAWP of an agricultural product for a given period. The objective is to promote a public tool to secure price and to avoid price volatility. Canada appears to promote a public tool accessible to all farmers rather than encourage them to use the futures market. A futures market is an auction market where participants buy and sell commodities and futures contracts for delivery at a specified future date⁴¹. Futures contracts are exchange-traded derivative contracts that lock in the future delivery

⁴¹ <https://www.investopedia.com/terms/f/futuresmarket.asp>, visited on February 1, 2021.

of a commodity or security at a price set today. The futures market is, therefore, able to guarantee a price in the future.

Moreover, according to the Financial Guarantee Programs Division/ Programs Branch, Agriculture and Agri-Food Canada, the onion sector has not been part of the Price Pooling Program over the last ten years. This means that this policy has had no effect on either the Canadian or U.S. onion market during the most recent decade.

Despite this factual analysis that I have done, I know that some U.S. growers continue to view the Ontario and Quebec provincial governments as using a Risk Management Program (RMP) as a support to agriculture and as a distortion of competition. This program would allow Quebec farmers to dump their products in the U.S. market, knowing that they would receive price maintenance assistance for their products. The Risk Management Program (RMP) is not part of the Price Pooling Program I analyzed above. The Risk Management Program is supported by the Canadian Agricultural Partnership⁴², while the Price Pooling Program is supported by the Minister of Agriculture and Agri-Food Canada (AAFC). These are two separate entities.

Some U.S. onion growers say that such provincial support is discouraged by the Canadian federal government but that provinces continue to use these mechanisms knowing that there would be little chance of a WTO trade dispute involving a province. These U.S. onion growers assume that this is an organized maneuver to avoid WTO sanctions. U.S. producers go so far as to say that the economic impact is strong on the scale of their farms, but marginal on the scale of New York State's agricultural economy or American-Canadian trade. It would explain why there is no complaint to the WTO, because producers could not bear the costs of this dispute. Some producers point to a 2014 article published in the trade magazine "Producers"⁴³ to illustrate their arguments. It reported that "The (Canadian) federal government refuses to co-fund the RMP, arguing that cost-based support opens the risk of trade challenges". According to the Canadian

⁴² To have more details about the Canadian Agricultural Partnership, see: <https://agriculture.canada.ca/en/about-our-department/key-departmental-initiatives/canadian-agricultural-partnership>, Retrieved September 9, 2021.

⁴³ <https://www.producer.com/daily/quebec-plans-to-boost-farm-subsidies/>, retrieved July 27, 2021

authorities that I was able to interview, the article I am referring to dates back more than seven years⁴⁴ and concerns the former RMP: Growing Forward 2. The Canadian authorities report that since 2018, Growing Forward 2 has ended and a new RMP has been renewed under the Canadian Agricultural Partnership (CAP). The Canadian Agricultural Partnership is a CA\$3 billion investment over five years (2018-2023) by the federal, provincial and territorial (FPT) governments. It is a producer income stabilization program similar to the U.S. Agricultural Risk Coverage (ARC) program. It pays farmers when estimated revenue falls below a guarantee level (O' Donoghue et al., 2016). ARC payments for 2015 in the U.S. was \$7.8 billion (Wilde, 2018). Therefore, if we consider RMP as an unfair agricultural policy, we have also to consider the same for the U.S ARC program.

In addition, some U.S. onions growers I have spoken with tell me that there is anecdotal evidence of support for transportation costs from the Canadian agencies or authorities. However, this belief is only based on words between professionals. I am reporting in extenso the words of an onion producer: *"I was just speaking to a local repacker. He said Canada is quoting \$10.00 for 50lbs of yellow onions delivered. It is \$2.00 below current local price. He said they (Canadian government) have to be subsidizing the transportation. As a repacker, he said, it's the only explanation and he has no doubts"*. I am not in a position to confirm or deny this type of situation, being reported by growers, packers, repackers in the field. I have mobilized the facts and statistical data. To confirm this accusation will require field investigations to establish solid evidence which is beyond the scope of my time and resources.

2.3.4. Onion trade between Canada and The U.S.: a complex regional market

As a result, I suggest that the low prices of Canadian onion sold on the U.S market in February 2020 were exceptional and may have corresponded to a commercial operation at a time when large quantities of onions were on the market (see section 4.3, below). The extremely low price

⁴⁴ The article was indeed published on January 3, 2014

for a few days in the winter of 2020 constitutes a brief deviation from the average market price over the long term.

Moreover, in general, Canadian prices are not under the average U.S. onion price. Therefore, we will see in section 4, that we cannot say Canada has a lower price than the U.S. and is dumping onions.

When we focus on a few states of the U.S. that are the most active in exporting onions to Canada, only three states (Washington, California, and Oregon) provided 80% of the volume imported by Canada (mostly sweet onion) (Table 13).

Table 13. Canadian onion imports (value in US\$1,000) from eight main U.S. states - 2015 to 2019 - Statistics Canada and the U.S. Census Bureau

	2015	2016	2017	2018	2019	% share 2015-2019	% share 2015-2019 cumulated
Washington	39,576	41,867	39,949	42,582	50,615	43%	43%
California	23,617	30,157	24,063	26,046	30,986	27%	71%
Oregon	7,044	8,672	8,093	8,321	12,965	9%	80%
Georgia	3,901	5,375	4,789	4,786	6,272	5%	85%
New Mexico	2,740	4,342	3,243	2,660	5,052	4%	89%
Idaho	3,517	4,596	3,229	3,384	3,650	4%	92%
Nevada	2,984	3,477	3,011	2,283	3,268	3%	95%
Texas	846	1,892	1,087	1,520	3,063	2%	97%
others states	1,681	3,446	2,655	2,959	3,174	3%	100%
Total	85,908	103,825	90,120	94,542	119,045	100%	100%

On the other side, when we focus on exports from Canada to the U.S., Canada exported close to 85% to six states. Two-thirds of the Canadian exports are to seven states near Canada (New York, Pennsylvania, Massachusetts, New Jersey, Maryland, Michigan, and Ohio). New York is the largest importer, receiving 34% of Canadian exports. Geographical proximity plays an important role in facilitating exports from Canada (Table 14). Québec and Ontario are the two main provinces in Canada exporting onions to the U.S., comprising 97% of exported onions. The value of Québec onion exports is CA\$22 to CA\$25 million, while Ontario's is CA\$16 to CS\$18 million. About half of the exports from Ontario are sent to Florida, Puerto Rico, and Pennsylvania.

Table 14. Canadian onion exports (value in US\$1,000) to 10 main U.S. states - 2015 to 2019 - (U.S.) - Statistics Canada and the U.S. Census Bureau

State	2015	2016	2017	2018	2019	Total 2015-2019	% share 2015-2019	% share 2015-2019 cumulated
New York	13,374	15,184	14,155	15,486	12,854	71,052	34%	34%
Florida	6,574	5,002	5,798	6,141	6,403	29,918	14%	48%
Pennsylvania	3,636	3,955	4,725	4,784	5,264	22,364	11%	58%
Porto Rico	4,972	5,573	3,767	4,542	4,803	23,657	11%	69%
Massachusetts	3,743	3,502	3,464	3,619	3,679	18,008	8%	78%
New Jersey	2,578	2,565	2,772	3,304	2,127	13,345	6%	84%
Illinois	1,101	932	1,488	1,767	806	6,095	3%	87%
Maryland	1,057	364	821	1,492	1,357	5,091	2%	89%
Michigan	829	736	820	770	1,132	4,286	2%	91%
Ohio	1,020	378	788	544	871	3,602	2%	93%
Others	3,472	2,916	2,875	2,985	2,387	14,636	7%	100%
Total	42,354	41,108	41,473	45,434	41,683	212,053	100%	100%

Drilling deeper, when we focus on the provinces or regions of Canada, which are the most active onion exporters to New York, only one region proves to be important: Québec. About half of the exports from Québec are sent to New York. However, only 26% of the volume imported by New York was provided by Québec (Table 15). And when we consider the provinces of Canada as a whole, they do not provide more than 33-34%.

Nevertheless, New York imports about US\$41 to US\$45 million of onions every year (Table 7): one-third from Canada and two-thirds from other countries. New York is more dependent on Canada's exports than the U.S. About US\$12.8 to US\$15.5 million of onions are imported every year by New York from Canada, mostly from Québec. As a comparison, the Shipping value of New York onions is close to US\$63 million.

Table 15. Canadian province onion exports to New York (and other countries) - 2015 to 2019 (value in US\$1,000) - Statistics Canada and the U.S. Census Bureau

Province	2015	2016	2017	2018	2019	% share 2015-2019	% share 2015-2019 cumulated
Québec	11,066	10,946	10,674	12,491	10,518	26%	26%
Ontario	1,819	3,259	2,386	2,234	2,163	6%	32%
Manitoba	486	979	1090	761	148	2%	33%
<i>Others "province"</i>	<i>2</i>	<i>0</i>	<i>5</i>	<i>0</i>	<i>24</i>	<i>0.02%</i>	<i>33%</i>
Subtotal Canada	13,374	15,184	14,155	15,486	12,854	33%	67%
Others countries	29,116	26,372	27,543	30,062	29,012	67%	100%
Total (All countries)	42,489	41,556	41,698	45,548	41,866	100%	100%

2.4. Summary of Section 2

- ✓ The global onion market has continuously grown for 30 years.
- ✓ Total global onion production reached 100 million tons for the first time in 2019, twice as much as in 2000.
- ✓ China is the largest producer, followed by India; together, these countries produce half (48 million tons) of the global production.
- ✓ The U.S. is a major world producer, with less than 3.2 million tons.
- ✓ Onions are a staple food in many countries and are among the most important vegetables globally compared to other commodities.
- ✓ The U.S. has experienced a trade deficit since 2006 and this deficit has dramatically increased since 2012.
- ✓ The U.S. onion trade is predominantly a regional trade between three countries: the U.S., Canada, and Mexico,
- ✓ Around 668 million pounds were imported in 2006 and 1,200 million pounds in 2019, i.e., almost a 100% increase!
- ✓ Total imports in 2019 were valued around US\$431 million, US\$200 million more than exports.
- ✓ The U.S. imports 96% by volume from only three countries: Mexico, Peru, and Canada.
- ✓ The U.S. exports 88% by volume to only three countries: Canada, Mexico, and Taiwan.

- ✓ The U.S. deficit can be explained by the creation of NAFTA, which has encouraged more food exchange between Canada, Mexico, and the U.S.
- ✓ The largest growers and shippers of sweet onions in the U.S. have expanded production outside the U.S.
- ✓ U.S. importers could be led to provide financial support to Mexican growers in exchange for onion contracts from Mexican growers.
- ✓ Mexico and Peru are ideal areas for U.S. growers to produce winter vegetables to meet consumer demand year-round.
- ✓ New York is the main importer of Canadian (Québec) onions.
- ✓ New York onion growers have argued that Canada subsidizes Canadian onion growers and therefore has caused serious injury to NY growers. However, no evidence exists to validate this allegation.

3. U.S. onion production and market

Section 3 presents the U.S. onion production and market.

3.1. U.S. fresh onion production and market

Worldwide onion production has increased steadily for several years. Production reached the symbolic bar of 100 million tons for the first time in 2019, twice as much as in 2000. The U.S. did not participate in this growth because its production has remained the same for 20 years, approximately 3.2 million tons (or 70 Million cwt).

Over the last 60 years, U.S. onion production has risen in volume (Figure 17). Production increased from 1960 (23.6 million cwt) to 2004 (83.8 million cwt), an exceptional year and production peak. Since then, production has decreased, losing more than 10 million cwt to reach a plateau around 70 million cwt, except in 2017, a second exceptional year with 82.4 million cwt. Gross production is holding steady, while acreage declines, suggest productivity (per acre) has indeed be compensating.

Figure 17. Area Harvested & production 1960-2020 USA (Source: USDA - National Agricultural Statistics Service (NASS))

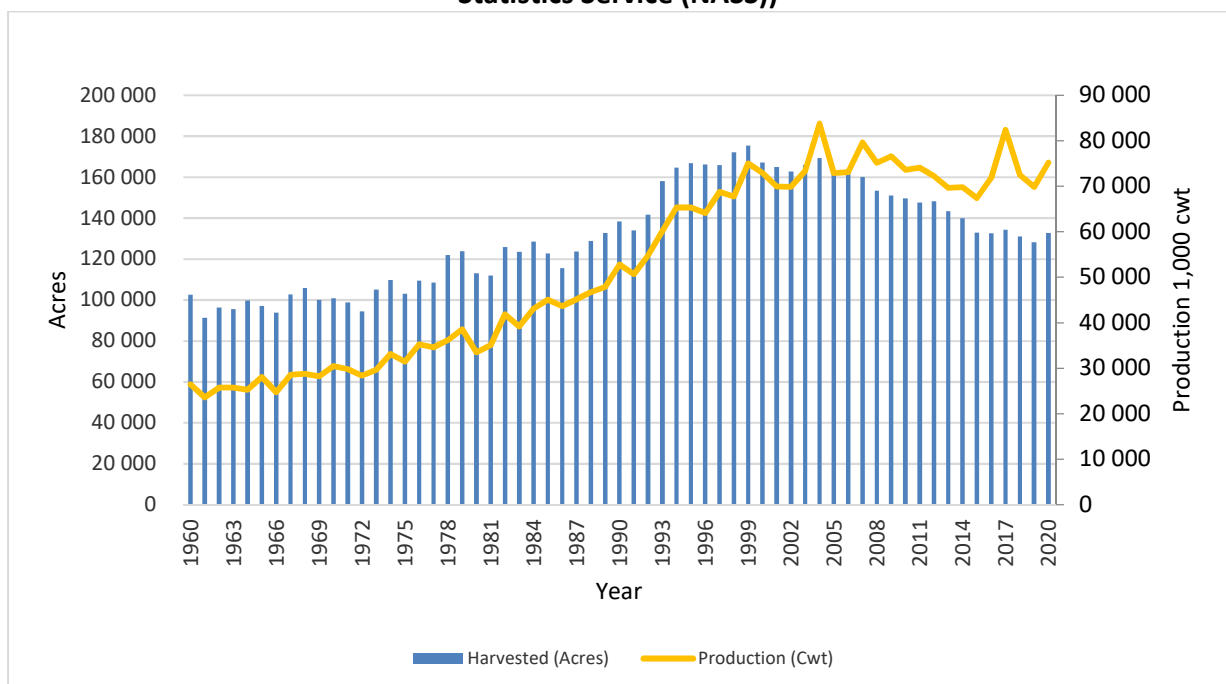

First, there has been steady progress in onion yield, doubling over 60 years (Figure 18). Since 1960, yield has increased steadily from 258 cwt/acre to 550 cwt/acre in 2019. However, while one would expect gross production to increase during the same period, production has stagnated since the mid-2000s. A second factor explains this. Onion acreage in the U.S. has fallen since 2000 (Figure 17. above) and yield improvements have just been able to offset this decline. The productivity per acre has been compensating to keep gross volume comparable to the early 2000s. In 2020, onion farmland accounted for 134,700 acres, i.e., 45,000 fewer acres than 20 years earlier.

Figure 18. Onion Yield (Cwt/acre) 1960-2020 USA (source: USDA - NASS)

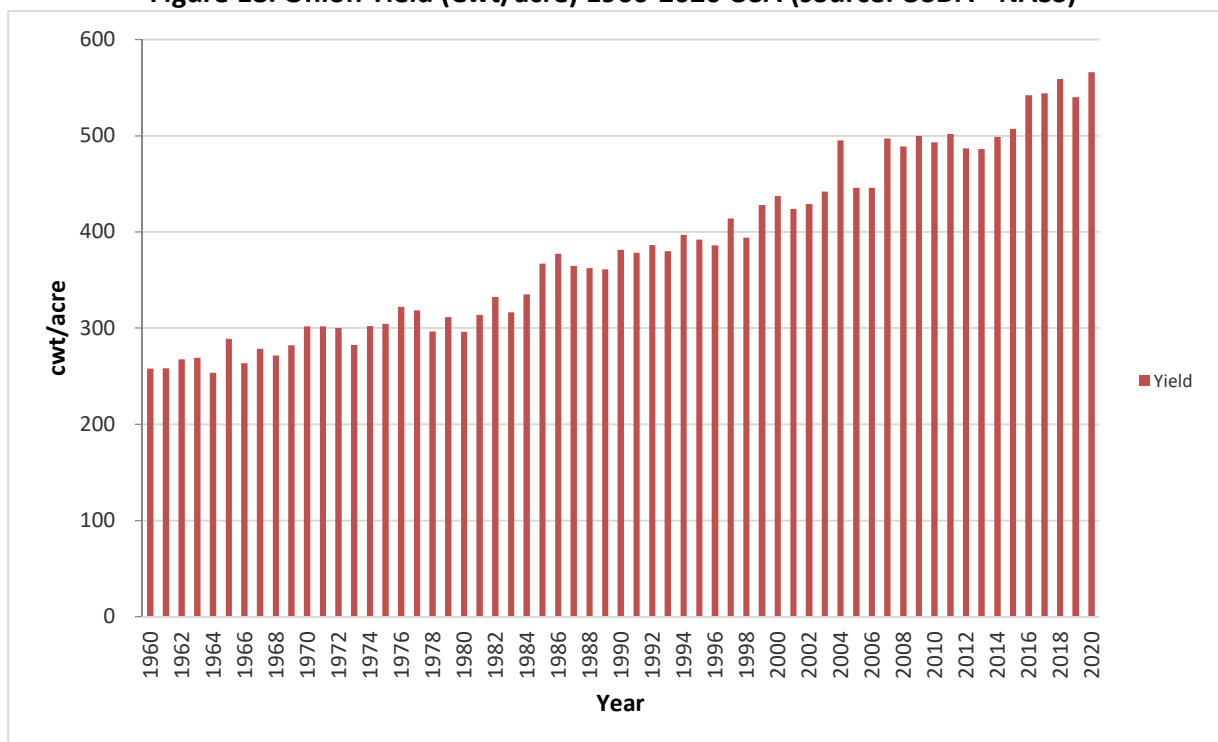

We have provided some explanations (Section 2) as to why this might be the case. Several large U.S. onion companies have reduced their farmland in the U.S. and simultaneously increased onion production in other countries. Others have adopted crops that we must assume are more profitable.. As a result, U.S. onion production is stagnating (Figure 19).

Figure 19. Production (Cwt) 1990-2020 USA (source: USDA - NASS)

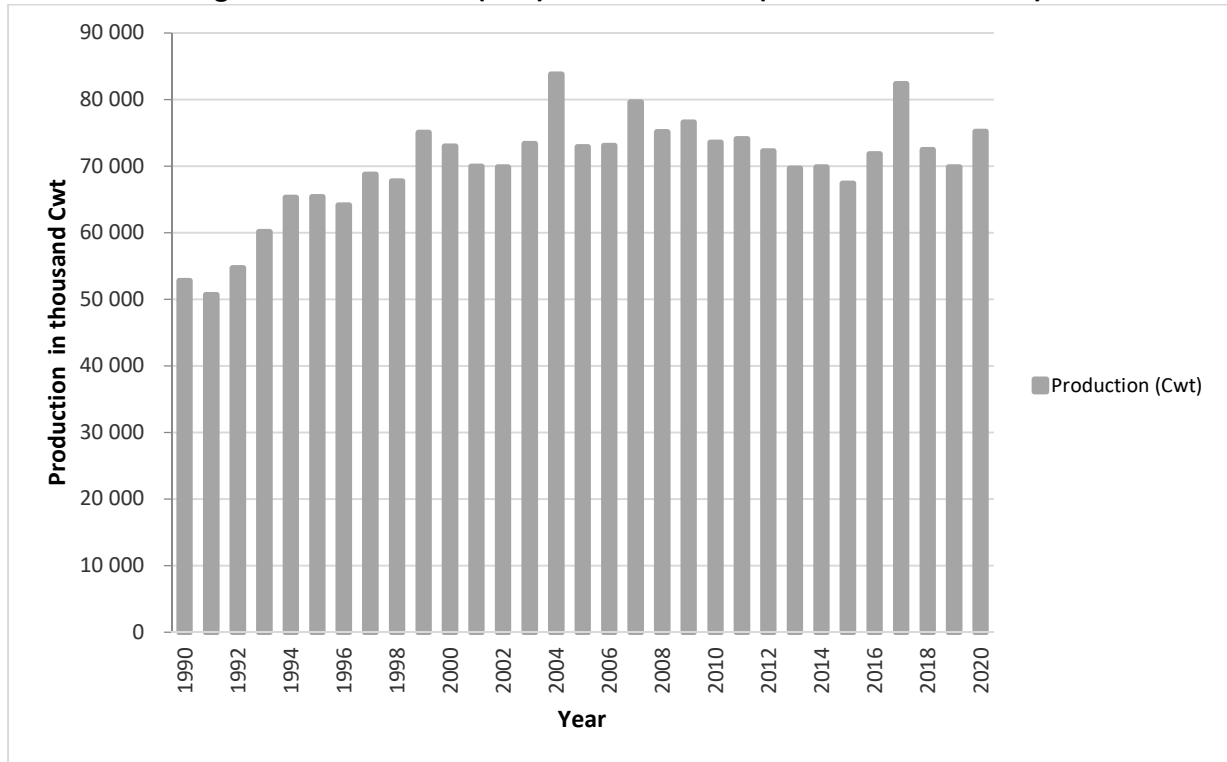

Over the last decade (2010 to 2020), prices have been volatile, leading to a large change in the total value of onions at the farm gate from US\$742 million to US\$1,049 million (i.e., a maximum difference of US\$307 million) (Figure 20). For this period, there is no concrete link between volume and price. For example, 2010 was similar to 2011 in volume, but price differed by 30%. Here, the difference is likely due to the opening of the U.S. domestic market to the global market. Global production, especially Mexican and Peruvian harvests, could have supply chain effects that influence the domestic price.

Figure 20. Production (1,000Cwt) & total farm value (\$1,000) 2010-2020 USA
(Source USDA - NASS)

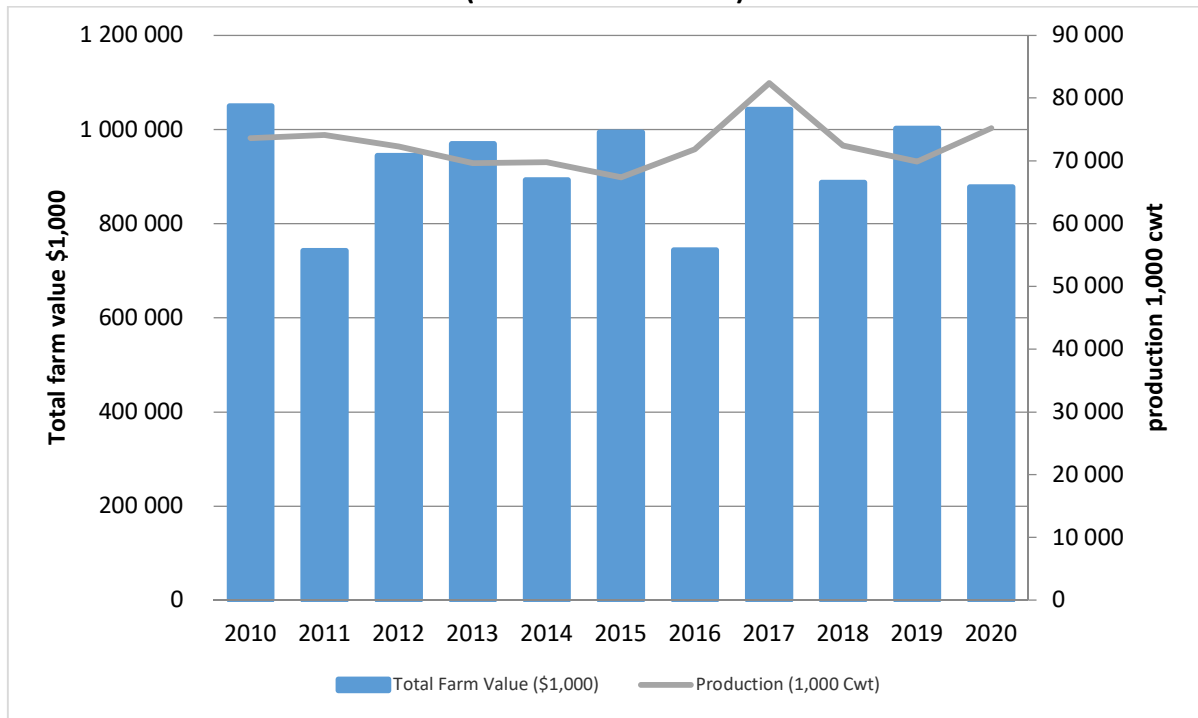

While U.S. onion production has stabilized to 70 million cwt, U.S. onion consumption is increasing. According to the National Onion Association (NOA), per capita onion consumption has risen over 70% since 2000, from 12.2 pounds per person in 1982 to just over 20 pounds per person in 2018. The National Onion Association notes that: *“onion rings, onion blooms, other onion appetizers, caramelized onions, and classic French Onion Soup remain popular restaurant uses for onions. In the past decade, red onions have gained popularity especially in fast casual dining segments on pizza, sandwiches and salads”*⁴⁵.

The U.S. Census Bureau estimated the U.S. population was 328 million persons in 2019⁴⁶. Therefore, U.S. total demand for onions in 2019 was about 65.6 million cwt.

U.S. production seems able to supply this demand. Nevertheless, shrink, loss, and export must be considered to evaluate this ability fully.

⁴⁵ <https://www.onions-usa.org/all-about-onions/consumption/> Retrieved January 06, 2021

⁴⁶ <https://www.census.gov/quickfacts/fact/table/US/PST045219#> Retrieved January 28, 2021

To analyze this capacity, I use data from the USDA, Economic Research Service (ERS), which annually evaluates the supply of U.S. fresh onion (Figure 21). Total supply has increased since 1970. There are three reasons for this.

- Firstly, domestic production has risen to reach a plateau near 60-70 million cwt.
- Secondly, imports have grown since 1980. As noted above (Figure 9 [above]), 11 to 13 million cwt are imported every year since 2015.
- Thirdly, stocks⁴⁷ have increased. This is consistent with the development of onion production. Over this long period, stocks correspond to 20-25% of production, i.e., 14 to 17 million cwt for the last 10 years (2010 to 2019). Therefore, the higher the production, the higher the stocks. As a result, for 2019, the total supply was about 90 million cwt.

Figure 21. U.S. fresh onions: supply - 1970/2019 (USDA- Economic research service)

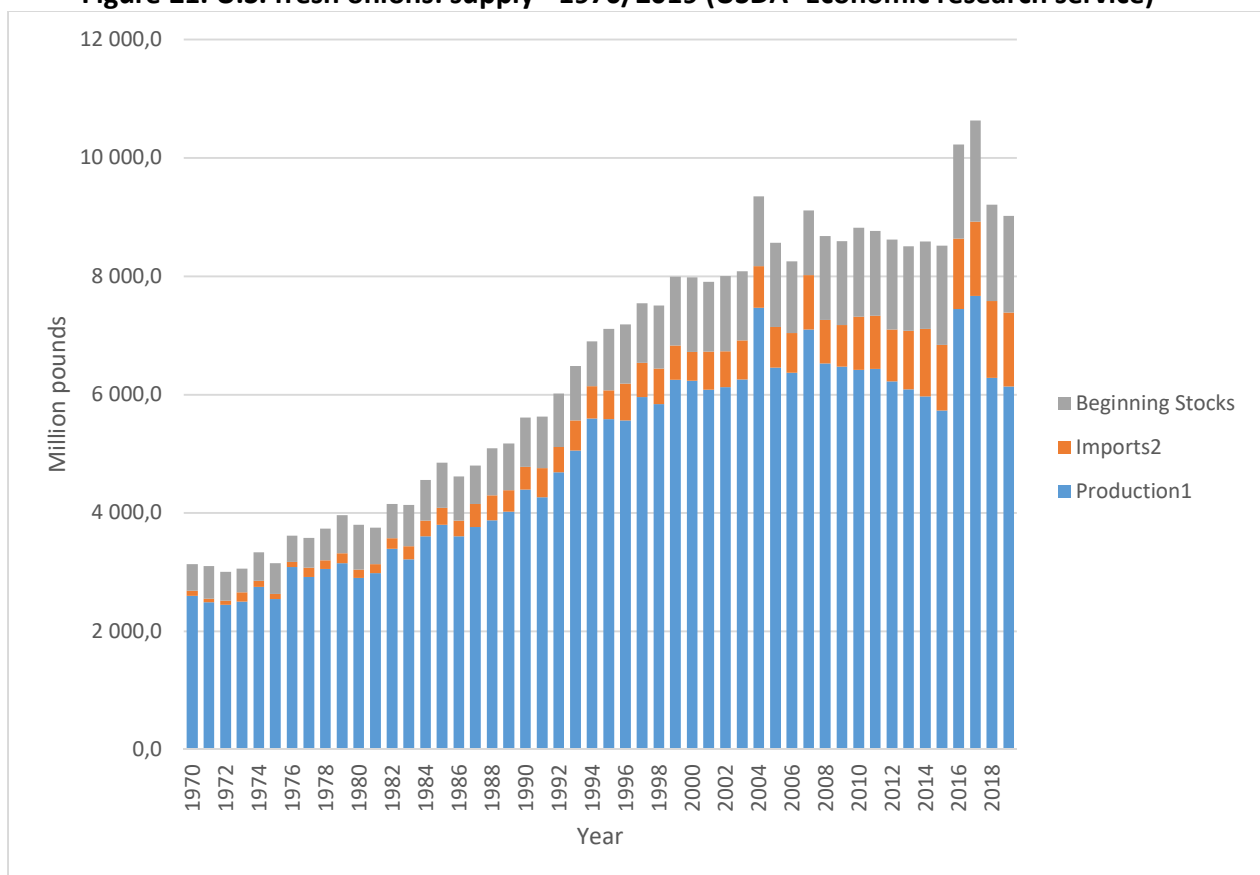

⁴⁷ "Stock" refers to the carry-over of onions not sold from the previous year.

To evaluate how the total supply is used, I computed data from the USDA ERS, which annually evaluates U.S. fresh onion uses (Figure 22).

Figure 22. U.S. fresh onions: Availability - 1970/2019 (USDA- Economic research service)

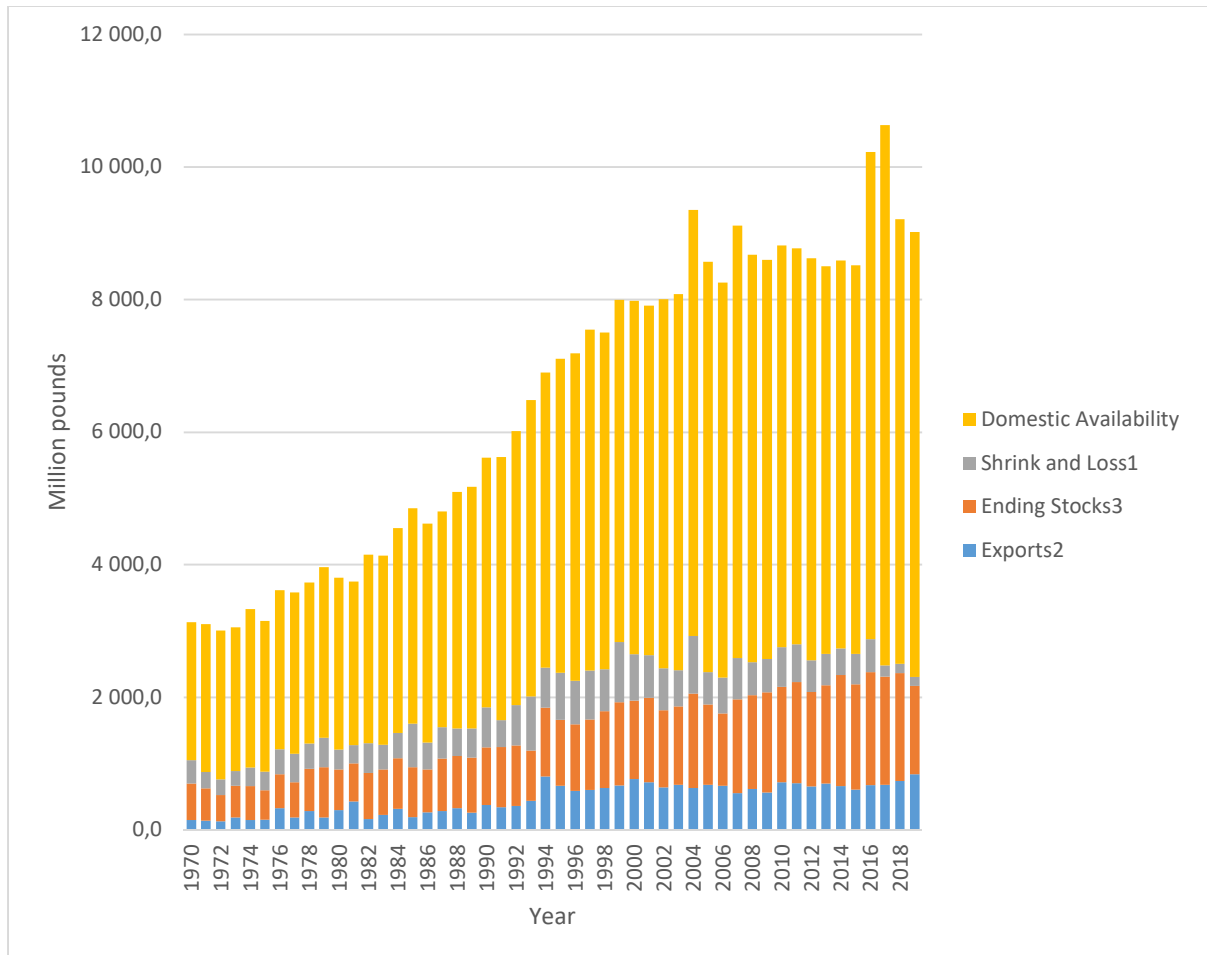

There are four main allocations of the total onion supply.

First, a portion of the supply is exported as noted above (see Figure 9 above). Since 2010, 6.05 to 8.37 million cwt have been exported (50% of the volume to Canada). The share of total supply exported by the U.S. from 1980 to 2019 averages between 6% to 8% (Figure 23). Although onion supply has increased, this percent has changed little, indicating that exports did not keep pace with the supply because more onions were imported than exported.

Figure 23. Onion, fresh market: Share of supply exported by USA 1980-2019
 (Source: USDA, Economic Research Service)

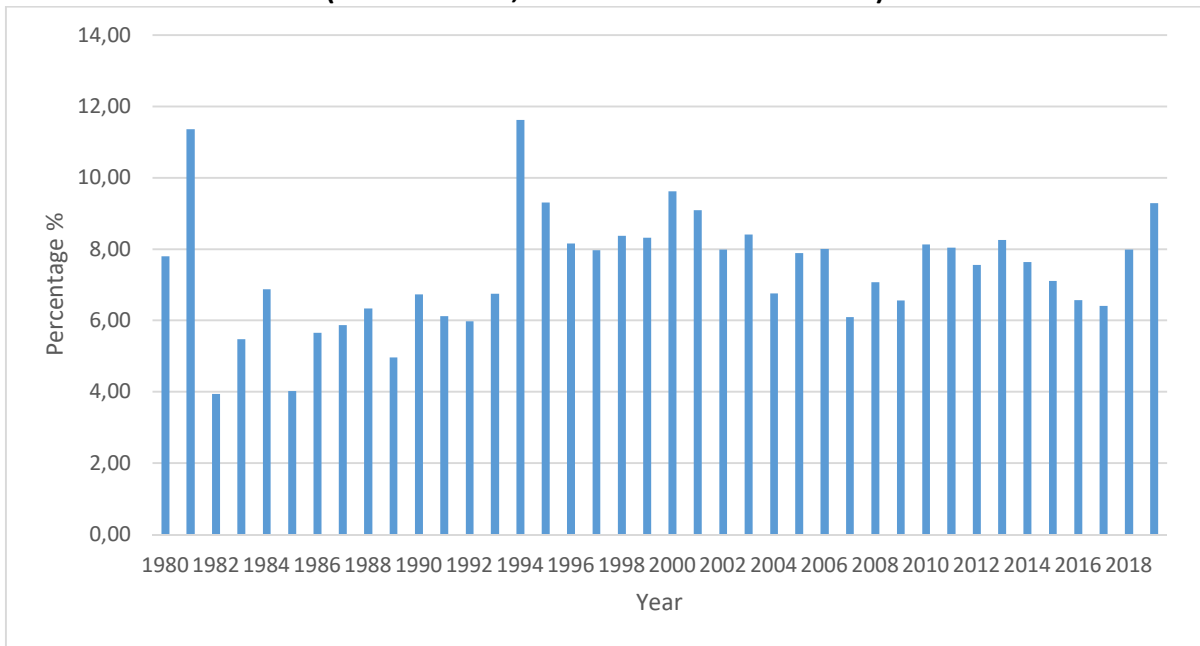

To illustrate this trend, I note that the share of availability imported has increased since the mid-2000s (Figure 24).

Figure 24. Onion, fresh market: Share of availability imported by USA 1980-2019
 (Source: USDA, Economic Research Service)

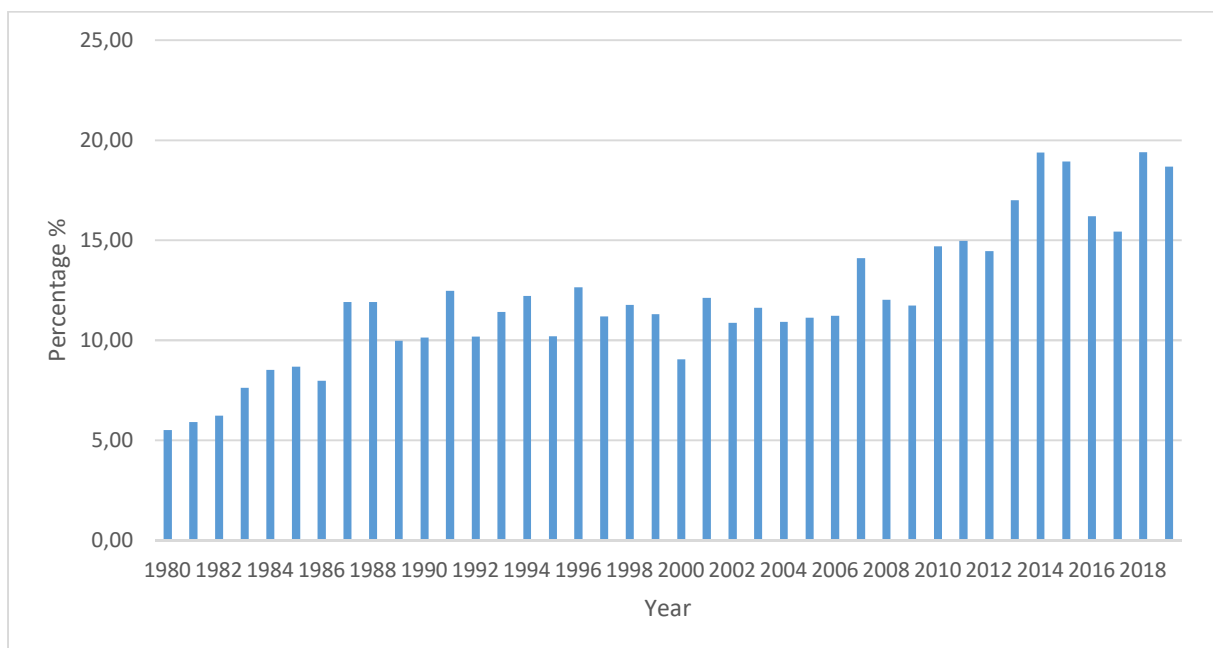

Second, part of the supply is unavailable due to shrinkage and losses. Less than 2 million cwt has been lost since 2017. This portion declines as growers and shippers adopt new technologies, such as controlled atmosphere storage (CAS).

Third, stocks have increased, as noted before. Indeed, growers and shippers have invested in “technical and marketing storage” assets (such as warehouses for CAS). Growers and shippers can regularly supply retailers who wish to meet consumer demand year-round by storing onions for long periods.

Fourth, the residual balance corresponds to the volume of onions made available to consumers. This is what USDA labels “Availability.”

By measuring the supply moving from production to marketing channels⁴⁸, the USDA Economic Research Service (ERS) has estimated the availability⁴⁹ of onions for human consumption in the U.S. and overseas armed forces. The ERS calculates the residual of the total annual supply available by subtracting measurable uses, such as farm inputs (feed and seed), exports, ending stocks, and industrial uses. The domestic onion availability has increased over time to reach 67 million cwt, which roughly meets U.S. demand (about 65.6 million cwt for 2019, i.e., 20 pounds/capita).

The U.S. is projected to grow by nearly 79 million people in the next four decades, from about 326 million to 404 million between 2017 and 2060⁵⁰. According to the USDA *Agricultural Projections to 2029*⁵¹, the annual demand for fruits in the U.S. will increase by 1.8 billion pounds and vegetables by more than 2 billion pounds. This increase is primarily driven by an increase in

⁴⁸ The food availability data series is a popular proxy for food trends and is the only source of time series data on U.S. food availability in the country. This data series also provides per capita availability data for hundreds of commodities (USDA ERS).

⁴⁹ For more details, look at: <https://www.ers.usda.gov/data-products/food-availability-per-capita-data-system/food-availability-documentation/> visited October 11, 2020

⁵⁰ Vespa J., Medina L., Armstrong D., “Demographic Turning Points for the United States: Population Projections for 2020 to 2060,” Current Population Reports, P25-1144, U.S. Census Bureau, Washington, DC, 2020

⁵¹ USDA Agricultural Projections to 2029. Office of the Chief Economist, World Agricultural Outlook Board, U.S. Department of Agriculture. Prepared by the Interagency Agricultural Projections Committee. Long-term Projections Report OCE-2020-1, 114 pp.

fruit and vegetable consuming ethnic groups (Hispanic-Americans and Asian-Americans) in the U.S. population, coupled with "natural" population growth of 0.7% to 0.8% per year. The U.S. per capita consumption of onions in 2018 was 20.4 pounds per year, a 100% increase in consumption since 1970. Onion demand has increased for several decades due to the rise in consumption of burgers, salads, away-from-home dining, etc. Onions also have natural qualities that make them attractive to consumers, particularly in today's health-conscious market.

If we apply these projections to the demand for onion and assume that 30 million new U.S. citizens will eat 20 pounds of onion per year, about 6 million cwt should be produced to meet the new demand. Given the U.S. onion production dynamics of the past few years, it seems that imports may prove to be the solution in meeting this new challenge. This observation makes it necessary to consider onion production dynamics at the state level. Indeed, for instance, the volumes currently produced in the U.S. are stagnating, and the USDA does not foresee long-term growth: drought problems in California will not allow the state, which generates nearly half of the country's vegetables, to "maintain a rate of expansion comparable to what has been observed in the past." Moreover, although U.S. onion yield has improved, we must assume that genetic innovation will not lead to a similar improvement rate in the future. The laws of agronomy remind us that the marginal growth of plant productivity is decreasing and not constant. Future genetic progress will be less efficient. Additionally, if onion volumes remain on a plateau or even decrease, the support for varietal improvement research could be reallocated to other crops for which the ratio of research costs to production benefits is better, further limiting genetic improvement. Similarly, the decline in gross onion production in New York supports this trend.

3.2. [Onion production at the state level](#)

My analysis will now focus on onion production at the state level. Nine states constitute the majority of onion production in the U.S. (Figure 25):

- California
- Washington
- Oregon

- Idaho
- Georgia
- Texas
- New York
- New Mexico
- Colorado

Onion production is mostly located in the western region of the U.S. Only two states are in the eastern region: Georgia and New York.

Two states (California and Washington) constituted 50% of the area harvested and of the total production (Figures 25 and 26). California and Washington are also the main exporters of onion and control 71% of export market shares.

These states mainly produce sweet onions. New York radically differs from its competitors by producing pungent onions.

Figure 25. Onions for fresh market and processing: Area harvested by State 2016-2020 (USDA NASS)

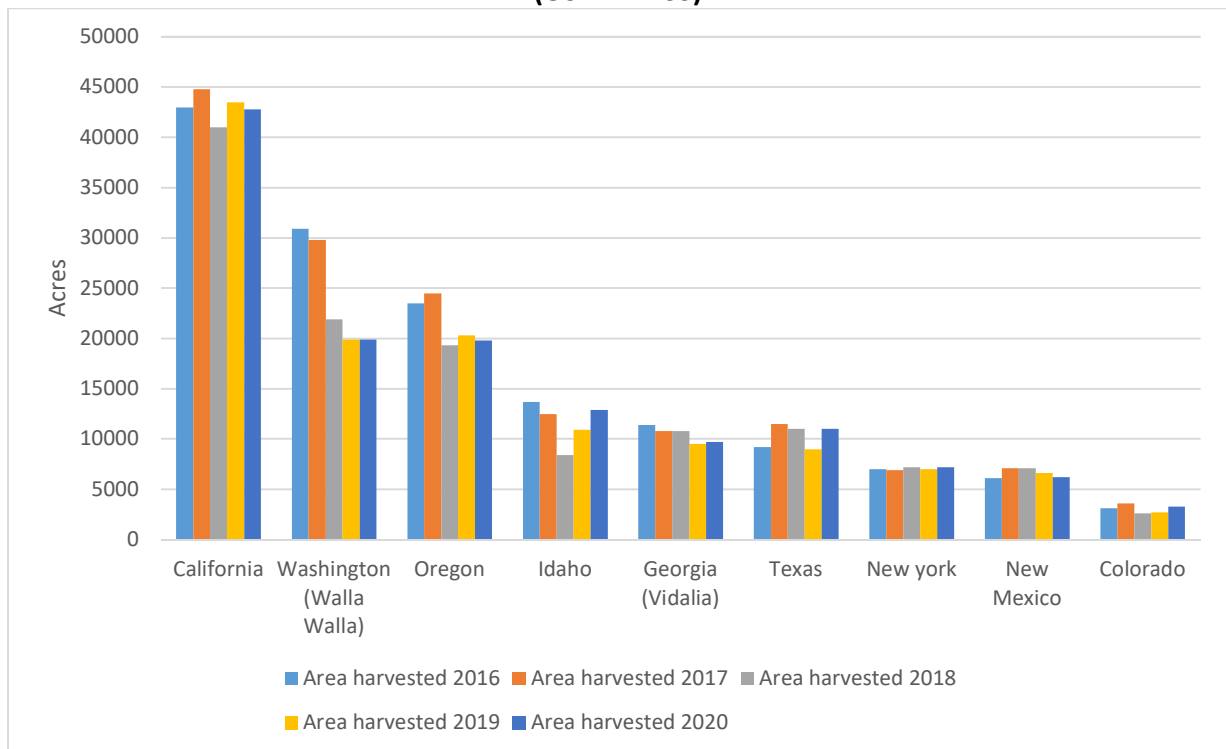
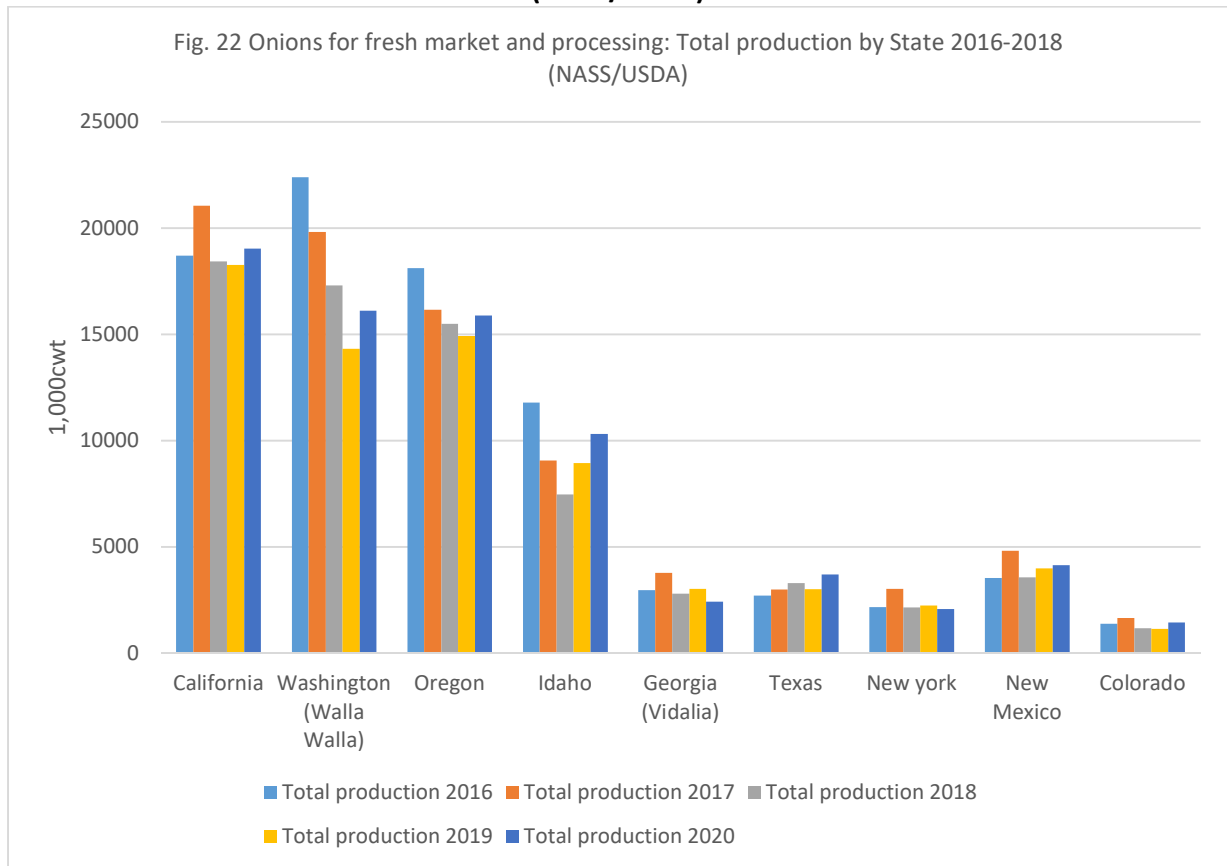
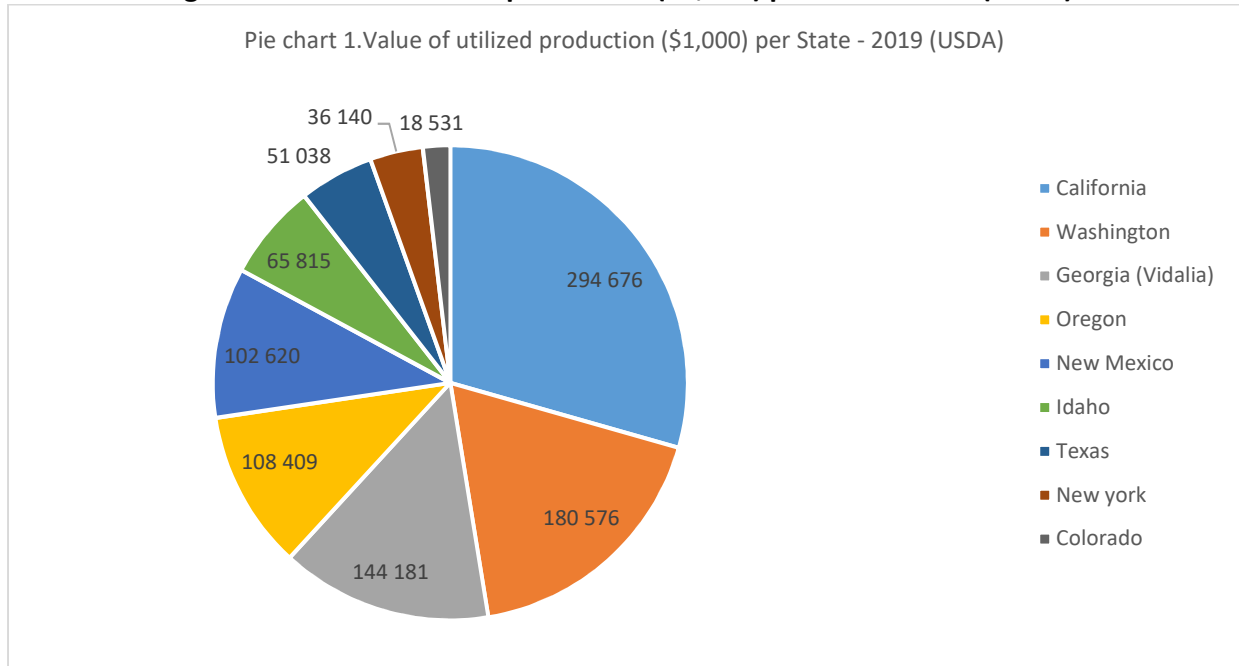

Figure 26. Onions for fresh market and processing: Total production by State 2016-2020 (NASS/USDA)



When prices are considered, the value of utilized production is calculated and provides a different view of the aforementioned hierarchy (Figure 27). While Georgia is in 5th place in terms of total production and area harvested, the state occupies third place in economic value. Georgia onions are valued at a higher price, while California and Washington are the revenue leaders because they produce a larger volume. Moreover, New York is revealed to produce fewer onions

Figure 27. Value of utilized production (\$1,000) per State - 2019 (USDA)



States can be divided into three groups based on the evolution of onion production over the last twenty years (2000-2019) (Figure 28).

The first group includes the largest producers by volume per year: California, Washington, and Oregon. California has produced about 20,000 thousand cwt each year. Onion production in Washington and Oregon has increased continuously since 2000.

The second group consists of five states (Colorado, Georgia, New Mexico, New York, and Texas) that produce less than 5,000 thousand cwt per year and have stable or slightly declining production.

The third “group” is Idaho. This state’s production has steadily grown since 2000, like Washington and Oregon, but produces a much smaller volume.

As a result, the dynamics of onion production are not driven by a general economic rule that would apply to all states probably because the market is not integrated. Producers within a state may develop a new strategy if they have new opportunities and access to markets.

Figure 28. Evolution Onion in the U.S.A by State, 1,000 Cwt (2000-2019)
(USDA, National Agricultural Statistics Service)

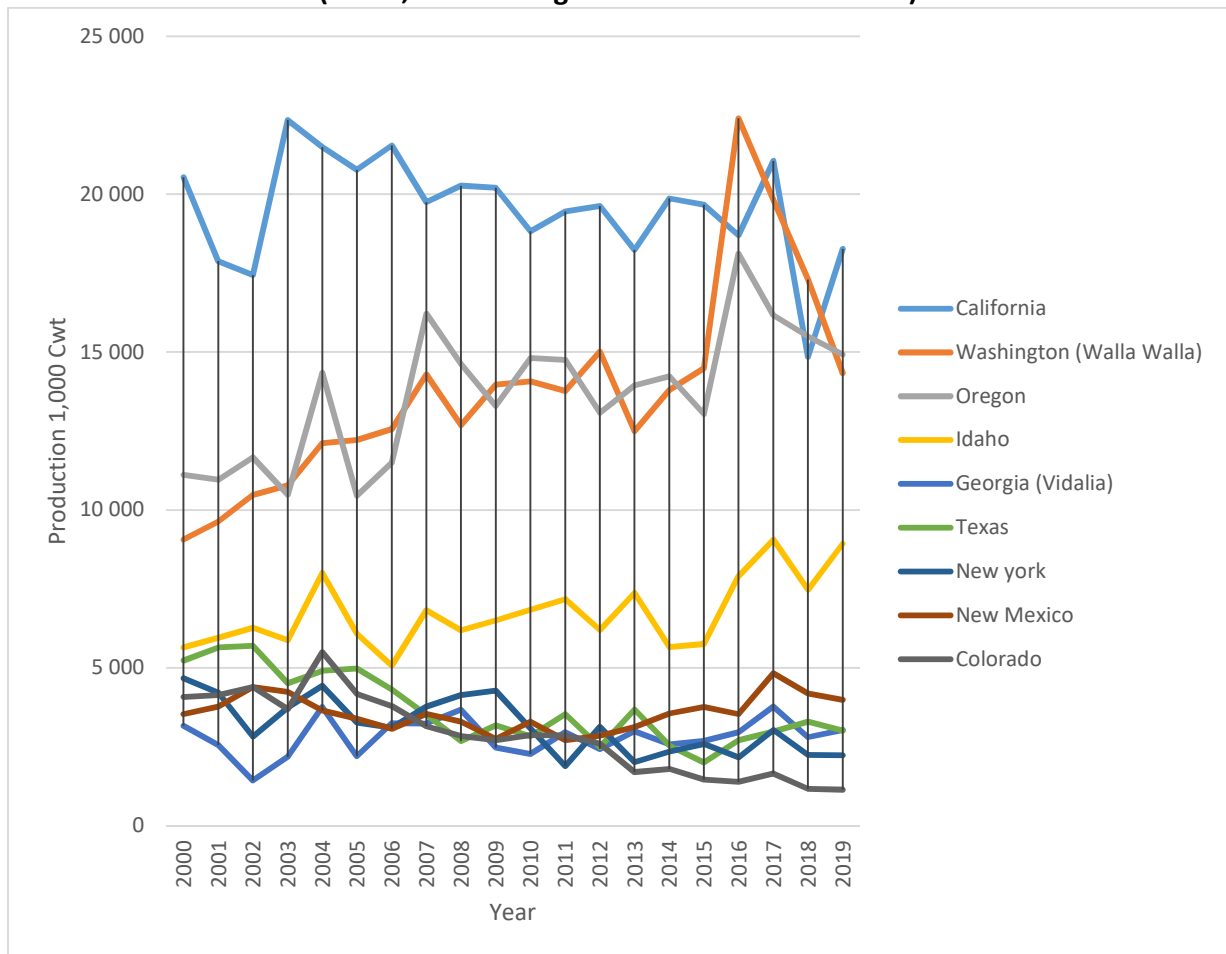

3.3. Summary of Section 3

- ✓ While global onion production has increased steadily for the past 20 years, U.S. onion production has slowed and stagnated.
- ✓ The U.S. acreage decline is offset by increasing yield. However, this is not true for New York State.

- ✓ Two states (California and Washington) constitute 50% of the domestic onion production and contribute 70% of exports.
- ✓ Four states produce 85% of domestic onions.
- ✓ U.S. per capita consumption of onions in 2018 was 20.4 pounds per year, a 100% increase in consumption since 1970.
- ✓ The onion market is growing steadily.
- ✓ Demand for vegetables will increase by 2050 due to the changing dynamics of the American population.
- ✓ Increased demand for onion and stagnating domestic production in the U.S. led to a trade deficit comprised of imports from Mexico and Peru.

4. Focus on Onion Prices

This section is dedicated to onion prices at different stages of the supply chain: the farm gate, Shipping point, terminal point and retail.

If you ask a New York onion grower how price has changed over the last few decades, he will probably answer: *“Prices are the same as they were 40 years ago.”* This is pretty close to the reality: as we will see in this section, constant prices (current prices adjusted for inflation) have decreased over time. Therefore, some growers consider they have become less profitable due to new regulations, new costs, etc... However, their production costs per pound have fallen steadily because they have substituted capital for labor and made gains in productivity. A producer needs less labor time to buy a gallon of gas today than he did 60 years ago. Moreover, prices need to be analyzed in the context of their farming system. For example, a price may be very low, but gross output per acre may be higher due to the very high yield per acre.

Onion growers sell their products through different channels. When they cannot sell directly to retailers or consumers, growers sell to handlers, packers, repackers, shippers, wholesalers, and brokers (Figure 29). All these intermediaries play roles in grading, packing, repacking, processing, and storing onions and controlling the supply, negotiating access to specific markets, exporting, speculating, etc. A supply chain is the interconnection of all the functions that start with manufacturing raw material into the finished product and end when the product reaches the final customer.

Figure 29. Description of the main partners of the onion sector in the U.S.

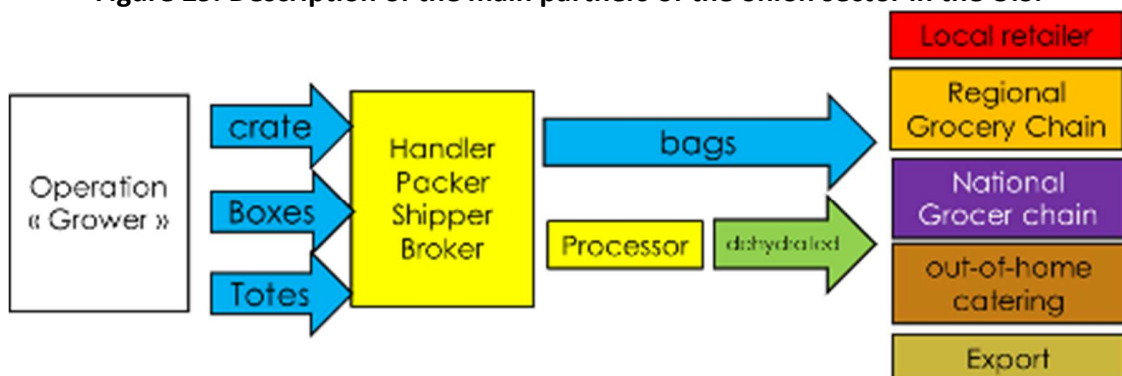

Growers can also become packers to sell on-farm, to local retailers, or to regional or national grocery chains (Figure 30).

Figure 30. Onion growers supply chain (Source: Interview ACRE Meeting January 2021)

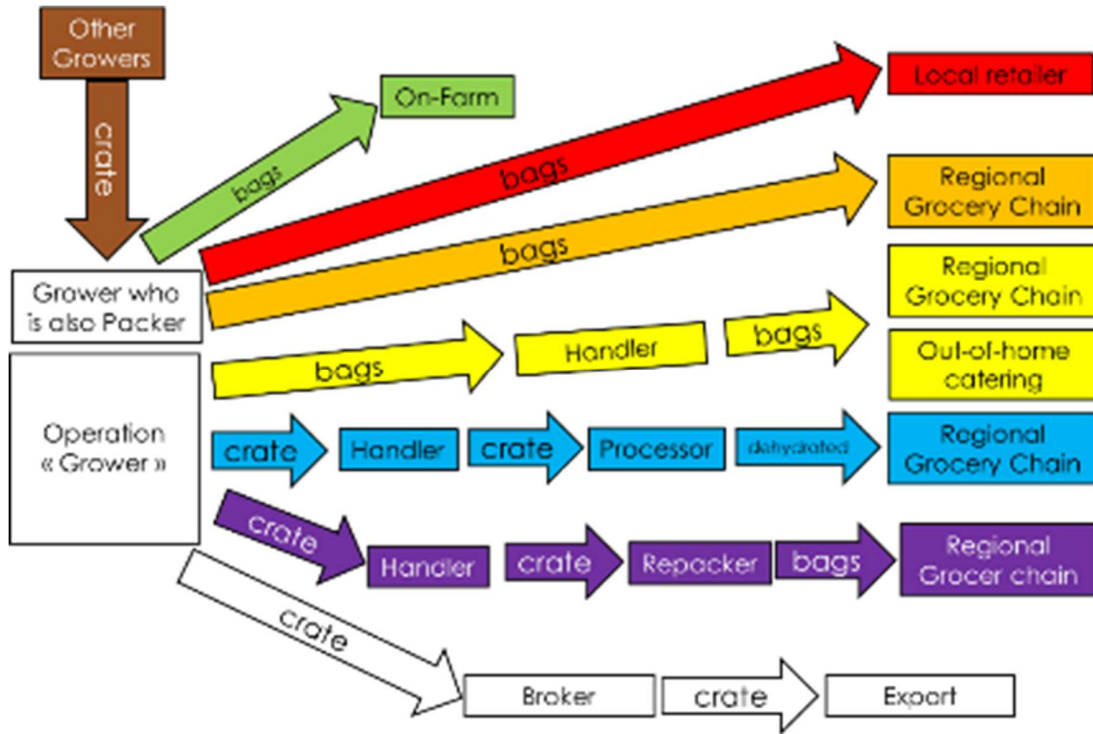

Therefore, analyzing prices does not produce homogenous data for a type of product. The challenge is to identify what prices are comparable. If we can get prices at different supply chain stages, we could determine how value along the supply chain is distributed among the linkages.

Therefore, in this section, I will analyze four prices⁵²:

- Prices at the farm gate with a focus on production costs
- Shipping point price. These prices represent open (spot) market sales by first handlers on products of generally good quality and condition—unless otherwise stated—and may include promotional allowances or other incentives

⁵² To know more about the definition, see Market News: <https://www.marketnews.usda.gov/mnp/fv-help-17>

- Terminal market prices. The terminal market refers to a physical location in a metropolitan area where wholesalers sell produce (second handlers) to retailers or other large users in wholesale lots.
- Retail prices. These prices represent the advertised prices for onions at major retail supermarket outlets.

4.1. Focus on price at the farm gate

First, I provide an overview of onion price at the U.S. farm gate over the last forty years. The current⁵³ price has continuously increased, from US\$4/cwt in 1970 to US\$15/cwt in 2019 (Figure 31) and +10% between 2010 and 2019. To identify if this increase is due to a better willingness to pay from handlers and retailers, I calculated the real price without considering inflation (see below).

Figure 31. Onion Current Price at Farm Gate USA 1970-2019 (source: USDA - NASS)

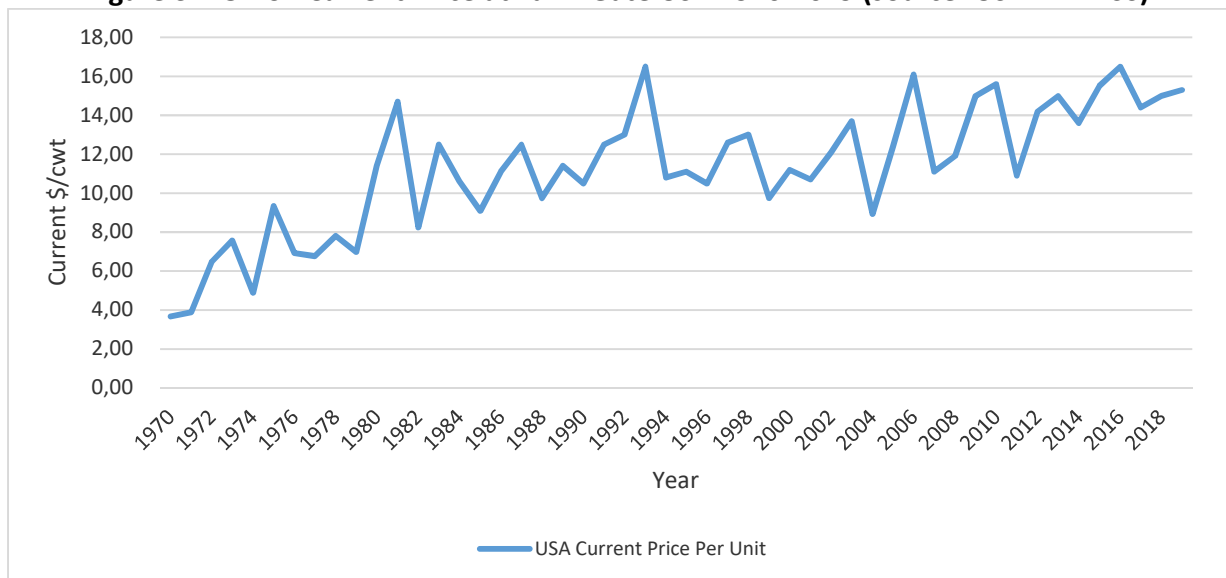

Moreover, when we focus on the last twenty years (2000 to 2019), we see the same trend. The price in 2000 was US\$11/cwt and US\$15/cwt in 2019 so that the current price gained

⁵³ Current price is unadjusted for the effects of inflation. Another name given to current price is nominal price. Constant price is adjusted for the effects of inflation and known as the real price. Inflation decreases the time value of money and reduces the quantity of goods and services that can be purchased in the future.

US\$0.23/cwt/year on average (Figure 32). We can also see fluctuations, such as 2004-2006, when prices increased from US\$9/cwt to US\$16/cwt.

Figure 32. Onion Current Price at Farm Gate - USA 2000-2019 (source: USDA - NASS)

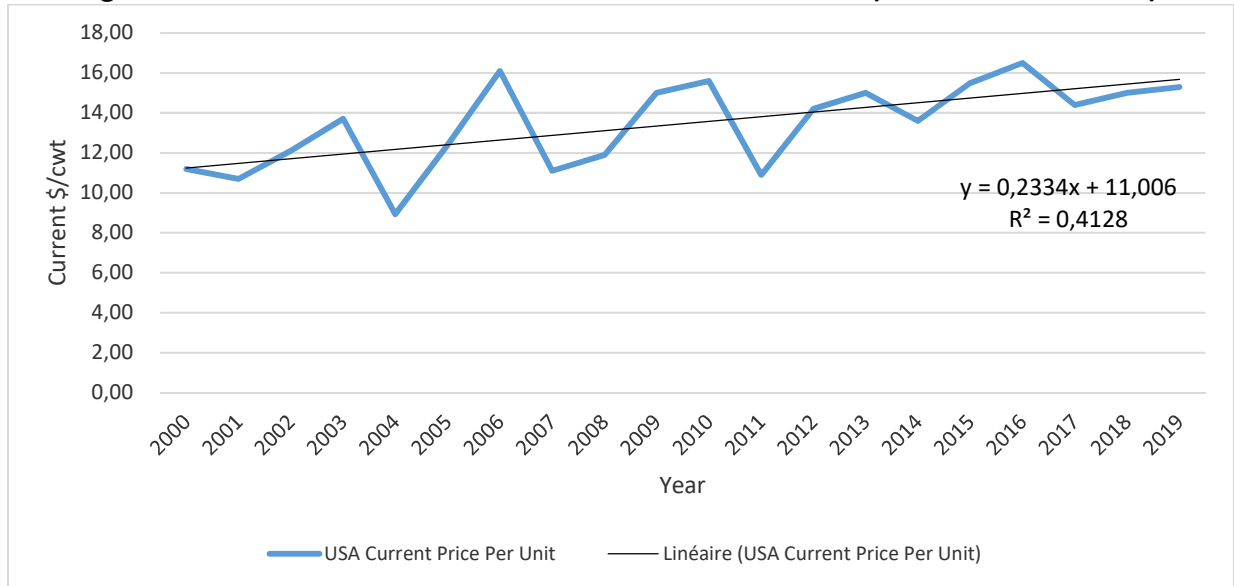

Price volatility is even more significant at the monthly onion price level (Figure 33). I use the Producer Price Index (PPI) to analyze monthly price volatility. PPI is used to measure the average change in price received by domestic producers for their output.

Figure 33. Onions Producer Price Index - U.S. Base year 1982=100 – 2000 to 2019 (USDA)

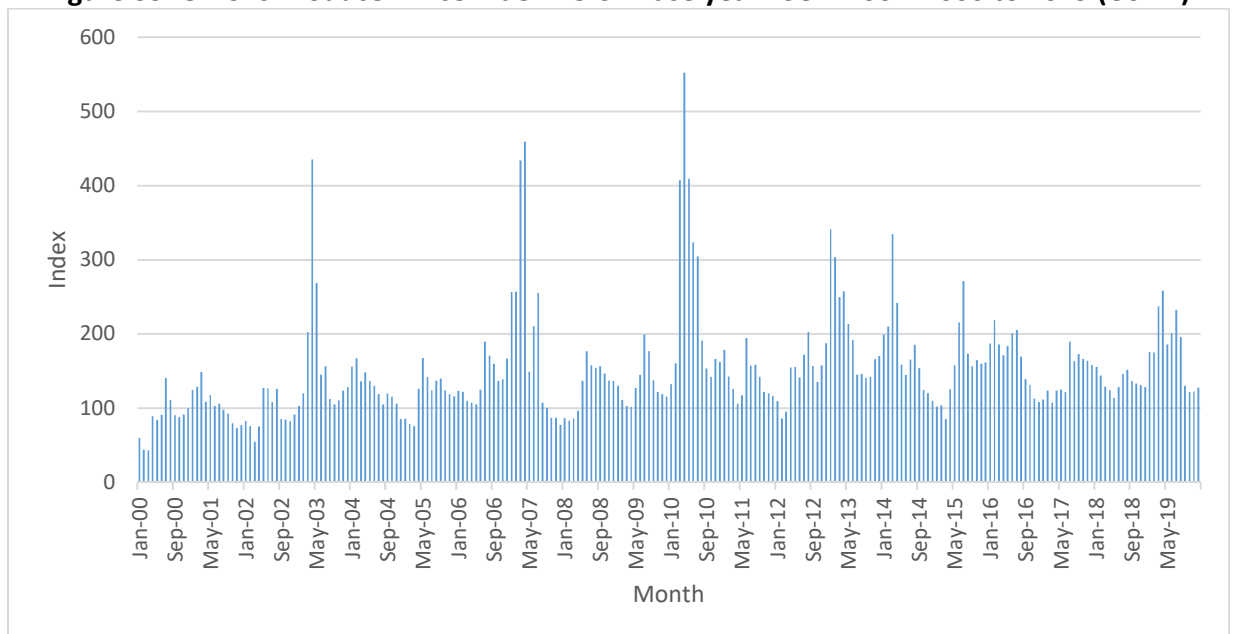

This volatility varies throughout the year. The PPI generally fluctuates from 80 to 150 but can sometimes exceed 400. In other words, the price each year can be multiplied or divided by a factor of two and exceptionally by 5 or 6! Over the last twenty years, two years (2007 and 2010) were extremely high, leading to volatility.

In general, after the harvest period, producers can supply the market with huge quantities that cause a dramatic drop in prices, depending on the weather conditions, the technical capacities of onion storage, and the possibility for growers to finance their storage. Moreover, even if onions, and especially yellow pungent onions from New York, have long shelf lives, they are ultimately perishable as one grower reminds us⁵⁴: "I've got 60 days. After that, they'll start to sprout, and I've got to dump them." In addition, commercial producers in New York are geographically dispersed, resulting in difficulties in coordinating market sales with other growers. If growers need cash, they may be forced to sell their products at a lower price than expected. This kind of situation sometimes encourages governments to support farmers to be able to store their products. Banks are still unwilling to finance the growth of working capital needs: stocks are growing faster than short-term debt, and banks are reluctant to finance vegetable stocks, which are generally perishable and risky (Barry and Robison, 2001)⁵⁵. Governments can then offer guarantee funds, as we saw with Canada's policy above.

On the other hand, when retailers need more onions, prices can rise quickly. Figure 34 shows the monthly price change between 2000 and 2019. Two periods appear to be more volatile: March-April and July. The months from August to December appear more stable, although from one year to the next, the PPI index may move from 100 to 200. It is difficult to give a significant explanation for this fluctuation because this index aggregates prices from different states with different onion varieties, types, harvest seasons, markets, etc.

⁵⁴ <https://civileats.com/2020/02/07/new-york-farmers-are-struggling-to-sell-their-onions-u-s-lawmakers-want-a-trade-investigation/> retrieved October 19, 2020.

⁵⁵ Barry, Peter J. & Robison, Lindon J., 2001. "Agricultural finance: Credit, credit constraints, and consequences," Handbook of Agricultural Economics, in: B. L. Gardner & G. C. Rausser (ed.), Handbook of Agricultural Economics, edition 1, volume 1, chapter 10, pages 513-571, Elsevier

Figure 34. Onions Producer Price Index per month - U.S. Base year 1982=100 – 2000 to 2019 (USDA)

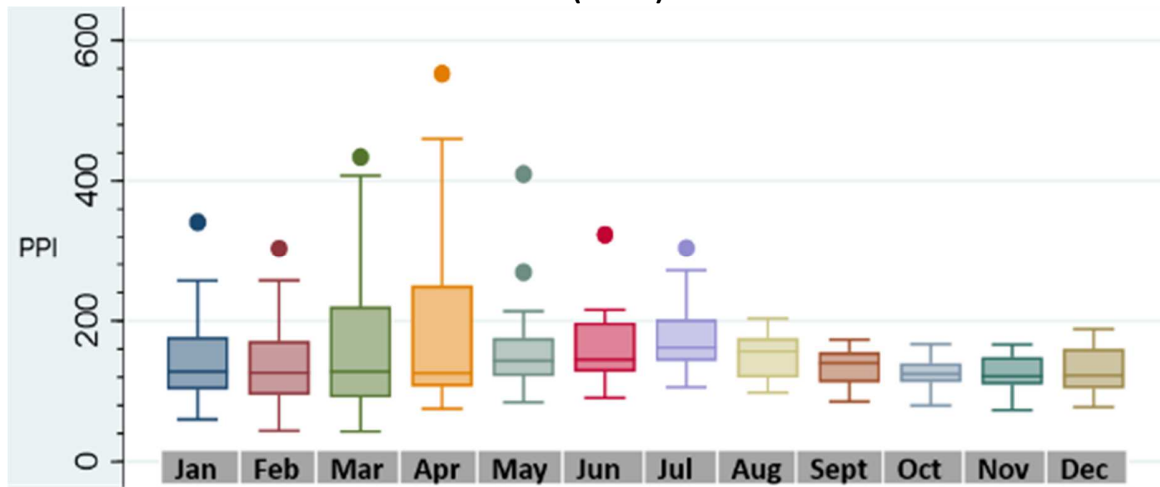

The behavior of the onion market is quite similar to other vegetable and fruit markets (Fig. 35), which are volatile for varying reasons.

Figure 35. PPI for all fresh vegetables, except potatoes (2016-2019) Base year 1982=100 (USDA)

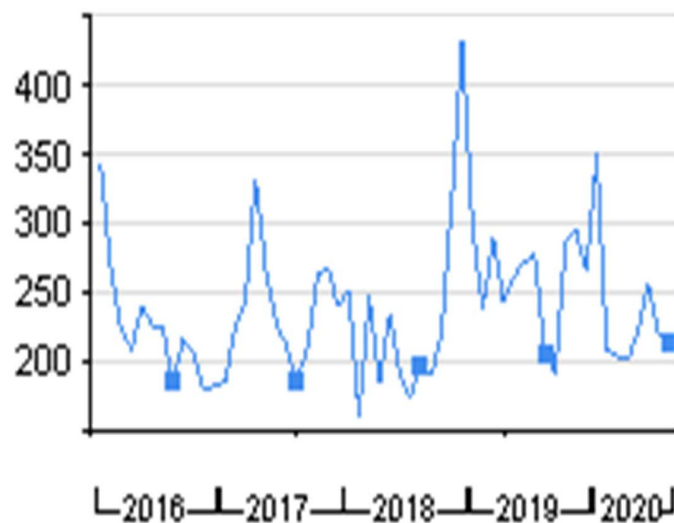

First, external market factors, including hazardous (climatic, sanitary, etc.), agronomic and environmental factors cause volatility. Moreover, it is important to note that onions are vegetables with a long shelf-life, unlike some fruits that can perish within a few hours (like strawberries). Regions supply the market at different periods of the year, exacerbating

competition and thus causing prices to fall (or to increase) very quickly (Table 16). Another reason is internal to the functioning of the market, as shown by Ezequiel⁵⁶ with his Cobweb model (see below). The theorem explains why prices are subject to periodic fluctuations and why producers make false expectations about future prices. Producers are often wrong because market equilibrium is not instantaneous due to the lag between planting and harvesting. Their price expectations are based on past price observations but generally do not correspond to the future price. The Cobweb Theorem argues that price fluctuations can lead to fluctuations in supply that cause a cycle of rising and falling prices.

Table 16. Shipment of yellow onion throughout the year in the U.S. (2018-2019)
Source: Federal State Market News "Mostly or Midpoint of mostly range"⁵⁷

VARIETY	SEPT	OCT	NOV	DEC	JAN	FEB	MAR	APR	MAY	JUN	JUL	AUG
Michigan Yellow Globe Type												
Central Wisconsin Yellow Globe Type												
New York Yellow Globe Type												
Peru Import - Repacked at Various E. Coast Shipping Points Yellow Granex Market Sweet												
Columbia Basin Washington & Umatilla Basin Yellow Hybrid												
Idaho and Malheur County, Oregon Yellow Spanish Hybrid												
Mexico Crossing Through South Texas Yellow Grano												
Vidalia District, Georgia Yellow Granex - Marked Sweet												
Lower Rio Grande Valley, Texas Yellow Grano - Marked Sweet												
Southern New Mexico Yellow Grano												
Walla Walla District, Washington Yellow Walla Walla Sweets												
Imperial Valley, California Yellow Grano												
San Joaquin Valley, California Yellow Hybrid												

In addition, demand for agricultural goods is generally price inelastic (i.e., a fall in price only causes a smaller percent increase in demand). The consumption of vegetables and onions in particular, is subject to the price inelasticity of demand (Femenia, 2019)⁵⁸. The consumer no longer increases his consumption regardless of the price.

⁵⁶ Ezequiel M., 1938, "The Cobweb Theorem". *The Quarterly Journal of Economics*, 52, 2: pp. 255–280

⁵⁷ <https://onionworld.net/category/shipping-point-prices/> visited January 25, 2021

⁵⁸ Femenia shows the higher the income is, the lower the level of elasticities. This means that for a country like the US with high incomes, the elasticity of demand for staple food like onions is very low.

The Cobweb Theory

From Tejvan Pettinger, Oxford University

(<https://www.economicshelp.org/blog/glossary/cobweb-theory/>), with some additions (Figure 36).

- (a) If there is a very good harvest, then supply will be greater than expected (Q_1 to Q_2) and this will cause a fall in price (P_1 to P_2).
- (b) However, this fall in price may cause some farmers to go out of business. Next year farmers may be put off by the low price and produce something else. The consequence is that if we have one year of low prices, next year farmers reduce the supply (Q_2 to Q_3).
- (c) If supply is reduced (Q_3), then this will cause the price to rise (P_2 to P_3).
- (d) If farmers see high prices (and high profits), then next year they are inclined to increase supply (Q_3 to Q_2) because that product is more profitable.

In theory, the market could fluctuate between high price and low price as suppliers respond to past prices.

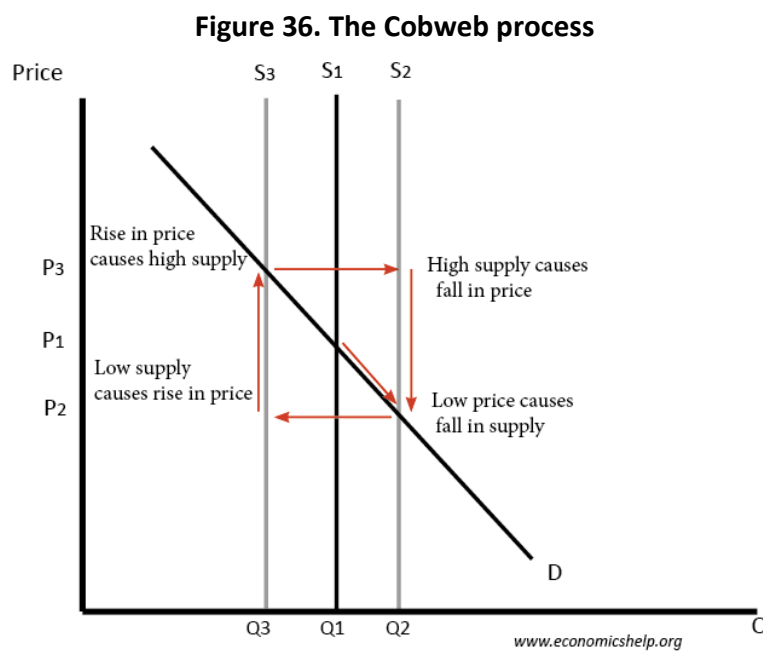

So, the price can fall or rise dramatically (Figure 33.). This is a big issue for growers who are left with uncertainty about future price. As the economic horizon is not clear, they have no incentive to invest in assets and innovations that would make productivity gains to lower production costs.

We have seen that current prices are volatile and that the price for 2019 is quite different from 1990 or 2000. To understand the evolution of constant price and identify real price, I have corrected current prices for inflation. This operation considers that a (current) dollar of 2000 is

"worth" less than a dollar of 1990 but more than a dollar of 2010. The current price has been corrected by the GDP price deflator, which was 100 in 2012.

In Figure 37, the current dollar price corresponds to the blue curve and the constant price to the red curve. While the current price has fluctuated in a range of US\$5/cwt since 1980 (US\$10 to \$US15/cwt), the constant price has declined from about US\$25/cwt to US\$15/cwt. This means the “purchasing power” of a cwt of onion has fallen sharply over the same period.

This analysis provides us with two assumptions:

- The onion remains a basic, standard, and undifferentiated product that growers have not differentiated to obtain a greater willingness to pay from buyers.
- There may also be a supply control problem that leads to shortages and overproduction.

In this case, the only possibility for growers to cope with the decline of the constant (real) price is to apply a cost competitiveness strategy. Growers have likely experimented with this strategy already.

Figure 37. Onion Current and Constant Price at Farm Gate USA 1980-2019 - base 100: 2012
(source: USDA, NASS)

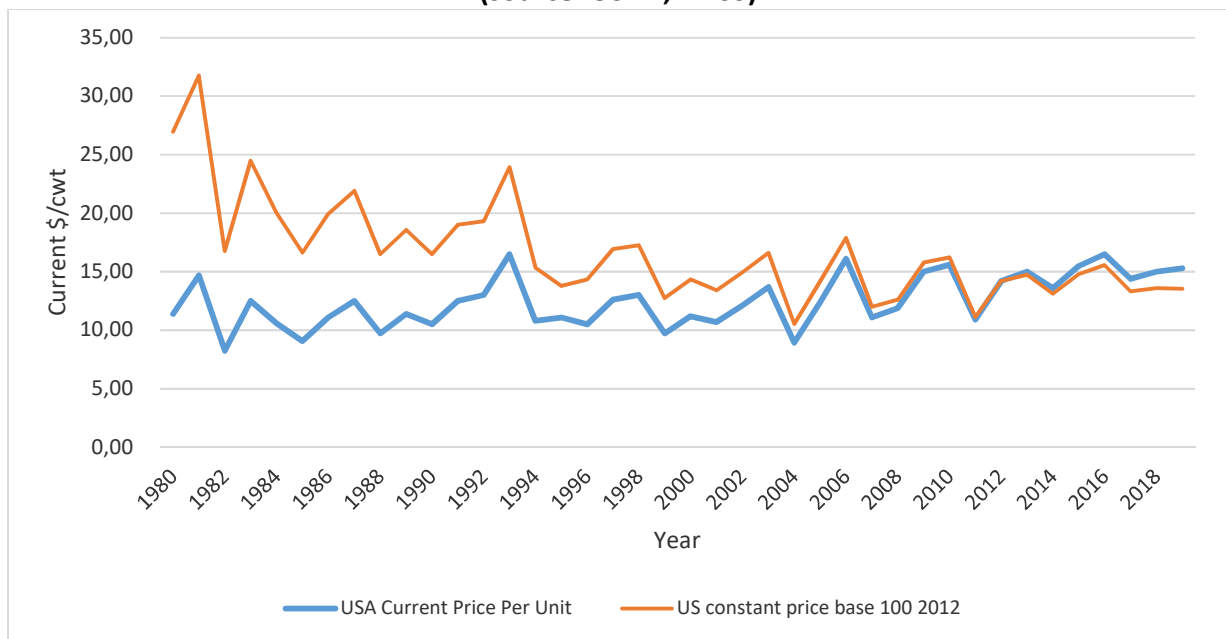

When we focus on the price of onions from New York, we see the same trends, suggesting that the price of New York onion depends on the U.S. price (domestic price). The linear correlation coefficient (Pearson's correlation coefficient) is 0.9234 and reflects the strength of the linear relationship between NYS and USA onion prices. I assume that the NYS onion price is subject to the whim of the onion market of which NYS is a smaller player, unless NYS can differentiate its product (either real or perceived). Current prices have risen since 1970 (Figure 38.). The prices paid for New York onions seems to be higher than for U.S. onions as a whole.

Figure 38. Onion Current Price at Farm Gate NYS/USA 1970-2019
(source: USDA - NASS)

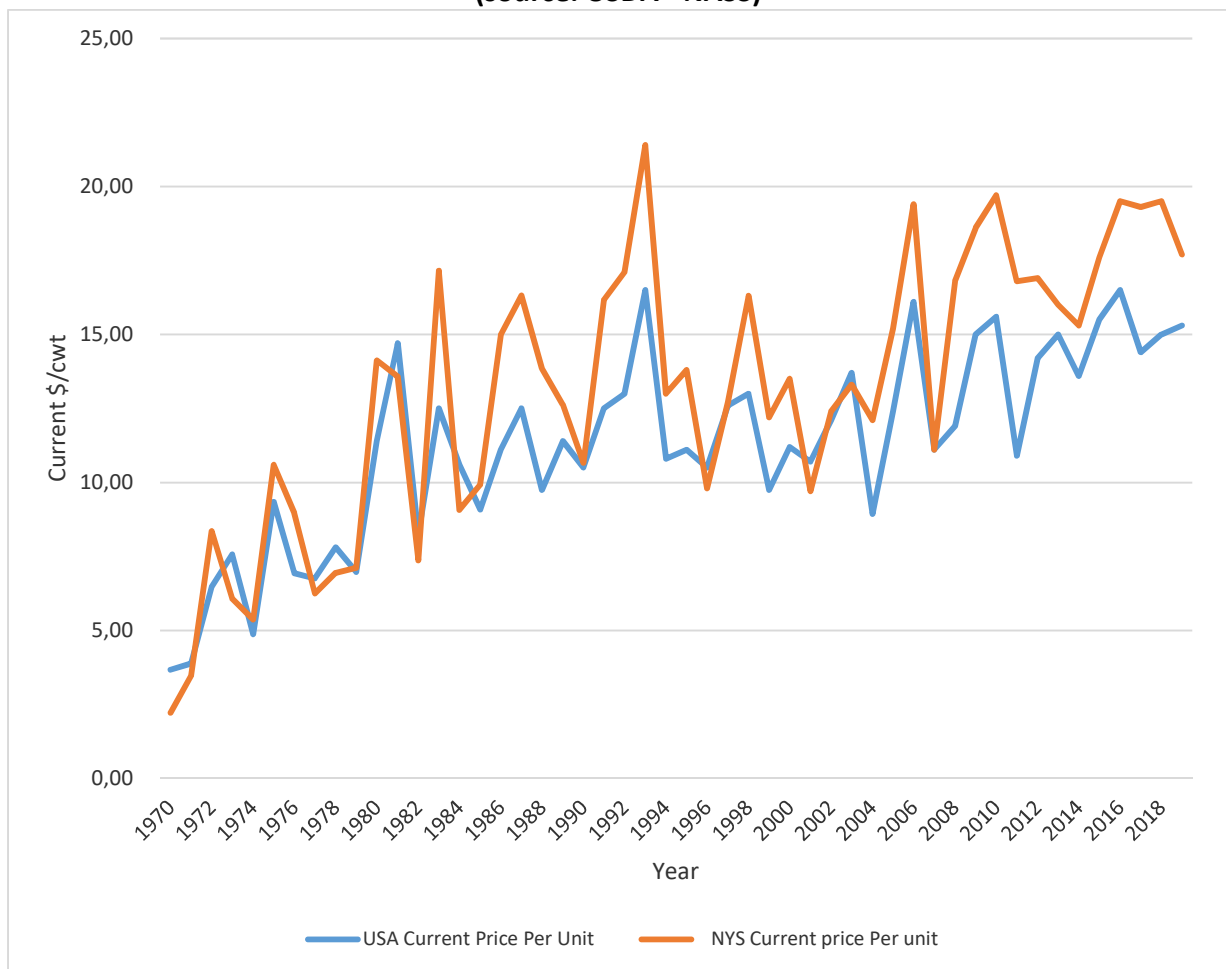

Fluctuation over this 40-year period is notable. From 1970 to the mid-90s, the constant price seems more volatile than for the next period (mid-90s to 2019) (Figure 39). I assume growers could have invested in storage capacities (warehouses, controlled atmosphere, etc.) over the last

20 years to increase their ability to cope with seasonal market demand. These investments could also play a role in “deseasonalizing” the consumption of sweet onions.

Figure 39. Onion Constant Price Base 100 (2012) New York State/U.S.A 1970-2019
(source: USDA, NASS)

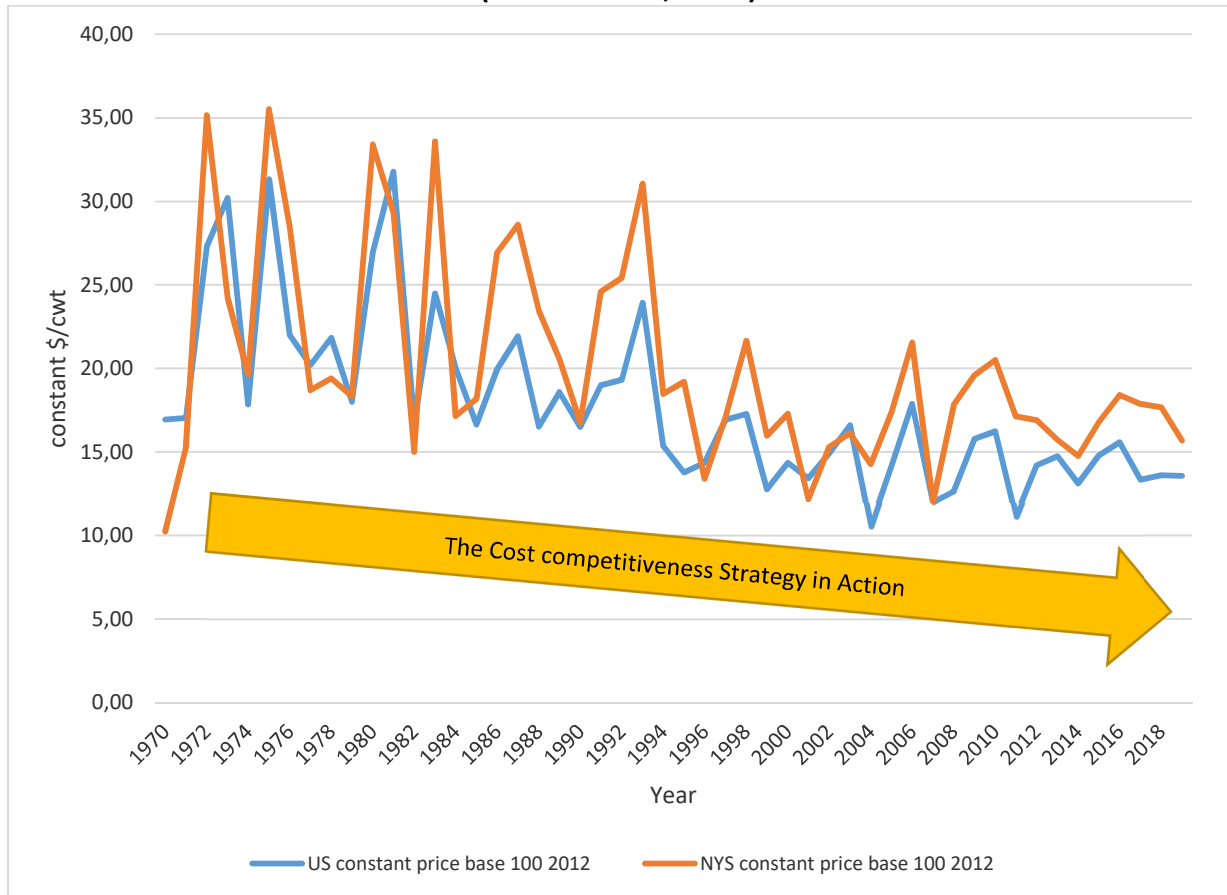

To conclude this subsection on onion prices at the farm gate, I compare prices between nine significant states in terms of production over the last four years (2016-2019) (Table 17).

**Table 17. Prices and values of onion for 9 states and Canada at the farm gate - 2016 to 2019
(USDA and Agricultural Statistics for Ontario and Canada, OMAFRA)**

State	Price per unit 2016 (\$/cwt)	Price per unit 2017 (\$/cwt)	Price per unit 2018 (\$/cwt)	Price per unit 2019 (\$/cwt)	Yield Cwt/acre 2019	Value of utilized production per acre (\$1,000/acre) 2019	Area harvested (Acres) 2019	Value of utilized production (\$1,000) 2019
Cat.1 Idaho	6.30	8.28	6.52	7.40	820	6,038	10,900	65,815
Cat.1 Oregon	15.30	8.55	6.56	7.34	735	5,340	20,300	108,409
Cat.1 Washington	11.70	8.68	10.70	13.30	720	9,074	19,900	180,576
Cat.2 Georgia (Vidalia)	39.00	34.80	39.60	48.50	320	15,177	9,500	144,181
Cat3. New Mexico	26.70	17.50	19.00	25.70	605	15,548	6,600	102,620
Cat3. California	9.52	13.80	13.20	16.10	420	6,774	43,500	294,676
Cat3. Colorado	15.70	23.80	23.30	16.70	425	6,863	2,700	18,531
Cat3. New York	21.50	19.30	19.50	17.70	320	5,163	7,000	36,140
Cat3. Texas	25.00	24.70	19.00	17.30	335	5,671	9,000	51,038
US total	13.70	12.90	12.50	14.60	540	7,743	129,400	1,001,986
Ontario (Canada)	13.05	13.65	13.65	13.90	385	5,350	5,529	29,595
Canada	14.80	15.30	15.60	15.92	378	6,016	14,090	84,772

In 2019, the onion sector comprised 129,400 acres at the farm gate and generated more than US\$1 billion, i.e., US\$7,740 per acre (\$15/cwt).

While sweet onions from Georgia are valued at US\$40 per cwt on average, onions produced in Idaho are sold at a very low price, roughly US\$7.50 per cwt. Three categories may correspond to three strategies.

- The first category (Cat.1) includes Washington, Idaho, and Oregon, three northwestern states with the lowest prices (US\$7.50/cwt to US\$10.50/cwt, on average) but best yield per acre (above 720 cwt/acre). Because these states can offset low prices with high production per acre, they can reduce their production costs and compete with other countries or states that have developed a cost competitiveness strategy. Moreover, Washington is the largest exporter to Canada; 53% of Canadian onion imports are from this state. The profitability of these states is based on their ability to maximize yield per acre.
- The second category is completely opposed to the first and includes only one state, Georgia (Cat.2). With their Registered U.S Certification Vidalia® Mark, growers have developed a differentiation strategy based on geographical location. It is illegal to package, label, identify, or classify any onions for sale inside or outside [Georgia] as Vidalia

onions or to use the term Vidalia if these onions have not been grown in one of the twenty counties of the specified Vidalia onion-growing region. With this specific onion, growers have succeeded in capturing a better willingness to pay from consumers and a fairer return of value to the grower. As a result, over the last four years, growers have sold their onions at the best prices, from US\$36.00/cwt to US\$46.00/cwt on average. Even though Georgia has a lower yield than other states, the value of utilized production per acre is among the best.

- The third category is more heterogeneous. Prices are higher than the U.S. average price and, depending on the year, vary between US\$16.50 and US\$25.00/cwt. There is not a huge difference in the value of utilized production per acre, which is about US\$5,500/acre. The five states in this category (California, Colorado, New York, New Mexico, and Texas) seem to be unclear on their strategy. For several reasons (agronomic, technical, marketing, etc.), they cannot adopt one of the two strategies (cost competitiveness or differentiation) cited in the previous categories. New Mexico is slightly different from the other four in this category because 2019 was an exceptional year for onion growers and marketers. The New Mexico onion yield in 2019 was 605 cwt, up from 590 cwt in 2018, and prices in 2019 were up from 2017 and 2018. I have added Ontario to have a comparison with a region quite similar to New York. Results from this “Province” are close to New York and I assume Ontario and Canada could be included in the third group.

Some experts consider I should not compare Georgia and other sweet onion growing areas to New York and other non-sweet onion growing areas because they are completely different products. It was true as long as there was no competition coming from sweet onions year round. But, because sweet onions are becoming a year round generic all-purpose onion for fresh eating and cooking, sweet onion now compete with pungent onion. On the basis of the opinions of onion growers and retailers, I assume that the vast majority of consumers are unable to differentiate a sweet onion from a pungent one. I also assume customers consider the sweet onion to be the result of a technical innovation that would have prevented the onion from being pungent and

causing tears. Therefore, I assume sweet and pungent yellow onions are not completely different product and can fairly be compared.

The reader should be careful with these numbers: they should be taken as relative rather than absolute values. I extracted price per unit from the *Annual Vegetables (2016 to 2019) Summary Report* (USDA, National Agricultural Statistics Service). The price per unit (US\$ per cwt) is calculated as follows: the value of utilized production (US\$1,000) divided by utilized production (1,000 cwt). Therefore, the value of utilized production concerns different kinds of onions (e.g., quality, packaged, and graded). This means that the final price per unit may result from aggregating ungraded crate onions and graded and packed onions in 10-pound net bags because the producer is also a packer.

We observed that prices could change quickly from one year to another (such as in the case of California, New York, and Texas) and from one state to the next. Since onion growers sell their products through different channels, I am not completely sure that all these prices correspond to the same quality and the same mode of packaging. To be compared, prices at the farm gate must be homogenous for a type of product. Can onions from Georgia (Vidalia) be compared to onions from Idaho? I think not. This comparison is not relevant to know which category has the lowest production cost because these onions are not on the same market. Nevertheless, Vidalia growers have succeeded in breaking away from commodities, while all other onions end up in the same market where the competition is tough and based essentially on the ability to provide low prices.

4.2. Focus on cost at the farm gate and competition between sweet and pungent onion

Therefore, to have a complete overview of competition ability, I propose comparing production costs between the three groups I have identified above.

As for price received at the farm gate, the main challenge is to identify what costs are comparable. The comparison I propose is based on budgets provided by extension services located all over the

U.S. Even though these budgets do not use exactly the same methods and the same assumptions, they can be compared with caution.

My budgets are based on field run yields and include the storage cost but do not include packing charges. Moreover, I include on operating costs but not fixed costs. Operating costs are already tricky to handle because they depend on agronomic practice. When we focus on a single year without considering the previous crop, we forget, for example, the positive effects of a legume on soil fertility that can change the quantity of fertilizer needed. Furthermore, calculating fixed costs involves making assumptions about depreciation or costs allocated to onions rather than other crops. It is also a challenge to calculate the costs of production factors that are “self-provided” by family workers⁵⁹.

Table 18 presents production costs that are relevant to our analysis of farm gate prices. Georgia (Vidalia) production costs are completely different from those of other states, even without considering packing costs. Vidalia production costs per acre are higher than comparable states: the operating production cost is close to US\$18/cwt, three times higher than what we observed for Idaho and Oregon (close to US\$5.5 per cwt). However, Vidalia is profitable at the farm gate. Idaho and Oregon, which both implement a cost competitiveness strategy, are also profitable. These states are the most competitive and it is difficult for other states to compete in the same market. Texas, Wisconsin, and New York cannot reduce their operating costs under US\$8.5 per cwt. Their main challenge is that they compete in the same market simultaneously (see Table 16 above). This situation is exacerbated by the presence of onion from Peru, a country where production costs are very low. Resultantly, growers in the third category (identified above) are under the market pressure of low-cost producers. I assume that Vidalia onion growers are also (indirectly) in this low-cost market with their onion from Peru.

A key driver of the decline of NY onion production is the muck onion industry’s long-time adoption of a low-cost and low-price strategy to compete with other onion regions with cost

⁵⁹ Most cost of production budgets also include fixed costs. Fixed costs may not be as accurately estimated as operating costs, but can be estimated.

advantages (e.g., lots of sun water, cheap labor, and cheap fuel for transportation), but has not been profitable. Competing with these other regions is, of course, a race to the bottom.

Table 18. Costs of production for four groups (5 states & Quebec & Mexico & Canada) at the farm gate - 2016 to 2019 (Extension services and our data collection)

Cost of Production Onion - Yellow	Cost of Production with Storage NO Packing, Marketable Yields per Acre	Cost of Production with Storage NO Packing, Marketable Yields per Acre	Cost of Production with Storage NO Packing, Marketable Yields per Acre	Cost of Production with Storage NO Packing, Marketable Yields per Acre	Cost of Production with Storage NO Packing, Marketable Yields per Acre	Cost of Production with Storage NO Packing, Marketable Yields per Acre	Cost of Production with Storage NO Packing, Marketable Yields per Acre	Cost of Production with Storage NO Packing, Marketable Yields per Acre
States	Idaho and Malheur County Oregon (Cat1.)	Peru Red	Tizapán el Alto, Jalisco, Mexico	Texas (Cat3.)	Québec (Canada) Black soil	Wisconsin (Cat3.)	New York State Black soil (Cat3.)	Georgia (Cat2.)
Origin of Data	Gina Greenway	https://fr.scribd.com/doc/59962645/Costos-Para-Cebolla	https://www.tierrafertil.com.mx/cuanto-cuesta-producir-una-hectarea-de-cebolla/	South Extension District - 12	Forest Lavoie Conseil - Phytodata Inc.	UW Extension	Philippe Jeanneaux Estimation	Esendugue Greg Fonsah and Chris Tyson
Year	2016-2018	2015	2015	2020	2010 updated 2019	2014	2019	2019 & 2020
Revenue								
Marketable Yield Sack#	1,600	650	750	750	740	656	750	700
Box or Sack lb.	50	50	50	50	50	50	50	40
Cwt/acre	800	325	375	375	370	328	375	280
Price Cwt	7.00	12.80	16.00	20.00	14.86	12.81	14.13	30.00
Price Sack \$	3.5	6.4	9.0	10.0	7.4	6.4	7.1	12.0
Total revenue	5,600	4,160	5,911	7,500	5,499	4,200	5,299	8,400
Total Variable Costs (Operating costs)	4,424	1,638	2,816	3,263	3,500	3,084	4,000	4,964
Returns over operating Costs per acre	1,176	2,522	3,752	4,237	1,999	1,116	1,299	3,436
Operating Cost (per cwt)	5.53	5.04	7.50	8.70	9.50	9.40	10.70	17.7
Revenue/cwt	7.0	12.8	15.8	20.0	14.9	12.8	14.1	30.0

4.3. Focus on prices at the shipping point⁶⁰

The onion supply chain is often complex even if there are three main members: onion growers (who produce, grade, and store), handlers (who, depending on the state and local context, are packers, shippers, repackers, and brokers), and consumers. Handlers are the intermediaries between growers and customers (see Figures 29 and 30 above).

This subsection analyzes the central position of handlers and the prices at this stage of the supply chain. I focus on price data at the shipping point and terminal market.

⁶⁰ About Shipping Point Report Details, look at the USDA Agricultural Marketing Service <https://www.marketnews.usda.gov/mnp/fv-help-13> and to access to data: <https://www.marketnews.usda.gov/mnp/fv-report-config-step2?repType=wiz&type=shipPrice&locChoose=locState&commodityClass=allcommodity&run=Update>

According to the USDA⁶¹, a shipping point is the point (location) of production or port of entry from which the product is initially shipped. The shipping point is included in a geographic area often referred to in market news reports as a "district" where there are multiple shippers. For New York State, the shipping point is New York City. Shipping point prices represent open (spot) market sales by first handlers on products of generally good quality and condition—unless otherwise stated—and may include promotional allowances or other incentives. No consideration is given to after-sale adjustments unless otherwise stated. Reported prices generally include, but are not limited to, applicable brokerage fees and commissions, customs fees and duties, and U.S. packaging and U.S. freight costs before the first sale paid by the shipper and/or seller. Delivered sales and shipping point excludes all charges for freight after sale.

I have compared Shipping prices corresponding to the following conditions:

- Prices come from the New York shipping point⁶²;
- packages are 50 lbs sacks;
- onions are yellow, dry, of Globe variety, and are not organic;
- the size of onion is med 2 1/4" minimum;
- prices are given for 50 lbs. packages. I have also converted prices for 1 lb. or 1cwt;
- for every shipping day, two prices are released ("Low Price" and "High Price"), but I focus analysis on "Low Price";
- the data series is from 2010 to 2020.

These choices and restrictions are justified to reduce complexity. It is difficult, if not impossible, to provide a clear overview if we wish to consider all the packages (10 lbs. sacks, 40 lbs. crates, 40 lbs. cartons, 50 lbs. sacks, master container 15 3-lbs. mesh sacks, etc.), varieties (Yellow, Red, and White), sub-varieties (Globe, Hybrid, Granex, Grano, Spanish, Walla Walla, semi-globe, Flat, etc.), and qualities (Colossal, Jumbo, medium, etc.). There are roughly 300 price records per year for the New York shipping point and about 1,800 price records for the New York terminal point per year.

⁶¹ <https://www.marketnews.usda.gov/mnp/fv-help-05>

⁶² <https://www.marketnews.usda.gov/mnp/fv-help-15>

Over the last ten years (2010-2020), onion prices at the New York City shipping point have fluctuated from US\$4/50lbs to US\$20/50lbs for the “Low Price” of the shipment marketing season and from US\$5/50lbs to US\$22/50lbs for “High Price” (Figure 40). These prices are exceptional and include only a few days (7 out of 290 records). On average (Table 19), “Low Price” is US\$8.8/50lbs (US\$17.6/cwt), and “High Price” is US\$10.3/50lbs (US\$20.6/cwt). The variation around the mean is the same for the different prices (SD/AV: 0.24 to 0.25).

Table 19. Prices at the shipping point - yellow, dry onion, 50 lb sack (New York City shipping point) 2010-2020 (USDA Market News)

Criteria	Low price (50lbs)	High price (50lbs)	Low price (1 cwt)	High price (1 cwt)
min	4	5	8	10
max	20	22	40	44
Average (AV)	8.8	10.3	17.6	20.6
Standard Deviation (SD)	2.24	2.49	4.48	4.98
Median	9	10	18	20
SD/AV	0.25	0.24	0.25	0.24

At the New York City shipping point, shipments are concentrated in six months, from October to March, for yellow globe onion (Figure 40). Generally, Shipping prices start around US\$8/50lbs and fluctuate during the marketing season, but there is no universal rule. Sometimes prices decreased from October to March, sometimes prices increased. Consequently, it is not easy for growers to identify the best period to sell their onions.

Figure 41. Prices at shipping point (High & Low Price) - Yellow Onion Dry Sack 50 lbs. (New York City shipping point: 290 records) 2010-2020 (USDA Market news)

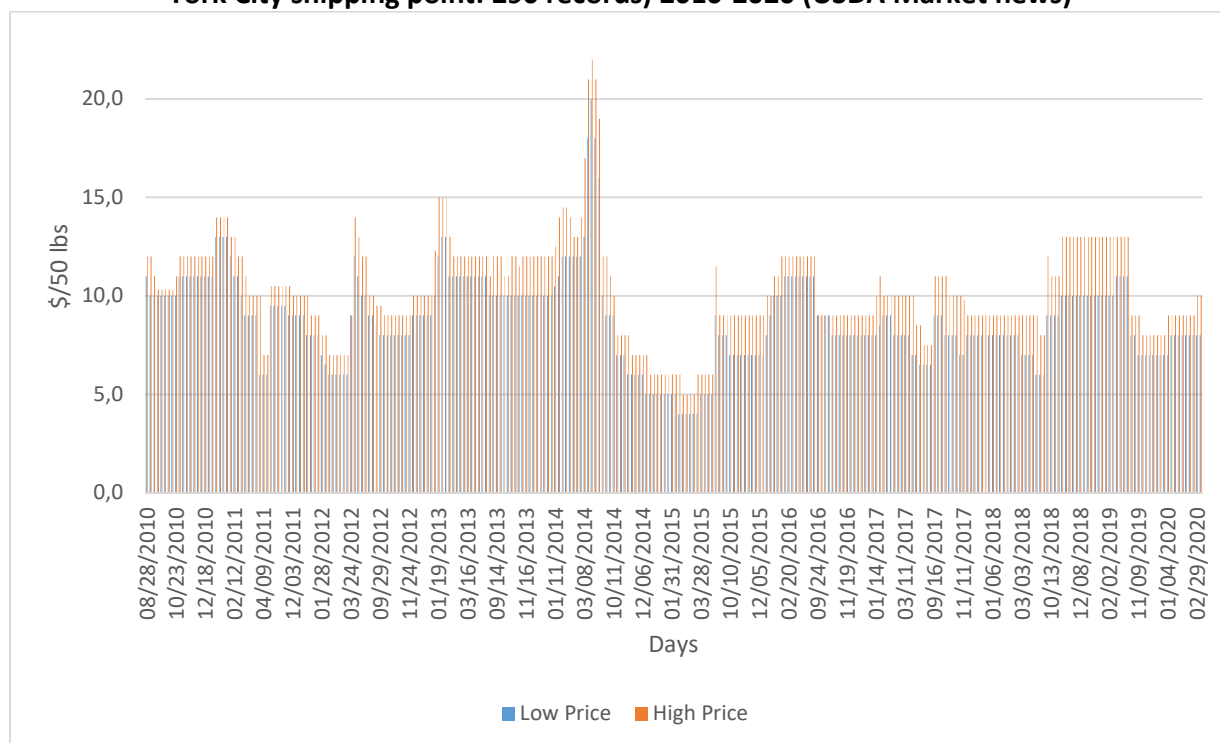

In general, prices are not as volatile during a marketing season. The coefficient of variation (CV (SD/Average)) is typically less than 0.19, while the CV=0.38 in 2014 (Table 20).

Table 20. Average “Low Prices” at the shipping point - yellow, dry onion, 50 lb sack (New York City shipping point) 2010-2020 (USDA Market News)

Year	2011	2012	2013	2014	2015	2016	2017	2018	2019
Average \$/50lbs	8.10	9.90	11.10	6.20 \$12.40/cwt	8.95	8.10	7.70	10.25	9.00
SD	1.28	1.33	2.10	2.35	1.70	0.67	0.85	0.38	1.60
CV	0.16	0.13	0.19	0.38	0.19	0.08	0.11	0.04	0.18

Finally, it should be noted that for the 2019 marketing season (October 2019-February 2020), Shipping prices were not high but did not fall dramatically, as New York producers reported. This marketing season (based on Shipping price data) was similar to 2015 and 2016 but worse than 2018. Growers may not have much confidence in the future market due to new marketing techniques, such as “internet bidding,” when retailers solicit bids for produce contracts. Distributors must place a public bid stating the price they are willing to sell onions and the lowest bidder tends to win the contract. Therefore, this technique would essentially push prices down.

New York producers believe a flood of Canadian onions, unfairly subsidized by the Canadian government, is the cause of dramatic price decreases. In February 2020, many media outlets defended the idea that New York onion growers struggle against an influx of cheap produce, priced below the production price, coming from across the Canadian border⁶⁴.

However, I believe that New York growers are actually more in competition with other U.S. onion growers who supply very low-priced yellow onions. This can be illustrated with a comparison of price for four periods and three locations: Columbia Basin, Washington (yellow hybrid); Idaho; Malheur County, Oregon (yellow Spanish hybrid); and New York (Globe) (Figure 42). These states compete at the same time, even though their onions are different. New York growers are disadvantaged because their competitors have higher yields and can produce more per acre with the same production costs as New York growers, resulting in lower production costs per acre⁶⁵. Thus, they can supply the market with a low-cost onion (US\$6 to US\$7/ 50lbs or US\$12 to US\$14/cwt), while New York prices are close to US\$7.5 to US\$8.5/ 50lbs or US\$15 to US\$17/cwt (for the end of 2017 and 2019/2020).

This situation seems to drive prices down. Indeed, the price of New York onions cannot deviate from competitors' prices at the risk of losing markets⁶⁶. New York growers have not considered until now that their onion may be different and can be sold in another, more profitable market to compensate for low yield. To do so, they would have to distinguish their onion and create a new market.

⁶⁴ Onion Business: <https://onionbusiness.com/canadian-onions-continue-to-impact-u-s-industry/>
Fresh Plaza: <https://www.freshplaza.com/article/9187900/new-york-senators-call-for-investigation-over-influx-of-canadian-onions/>
Civil eats: <https://civileats.com/2020/02/07/new-york-farmers-are-struggling-to-sell-their-onions-u-s-lawmakers-want-a-trade-investigation/>
Capital Press: https://www.capitalpress.com/state/idaho/onion-industry-questions-low-priced-canadian-imports/article_ca94eedc-5377-11ea-9c1f-c3ddcabb9b35.html

All retrieved in February 01, 2021

⁶⁵ I don't forget they have the transportation cost to New York markets.

⁶⁶ This situation asks if these markets are cointegrated. We analyze this situation in an econometric model in section 5, below.

Figure 42. Recap of Available Shipping Point Onions Price - 2017/2021 for three different origins - \$/50lbs (Source: Federal - State Market News Service, USDA "Mostly or Midpoint of mostly range)

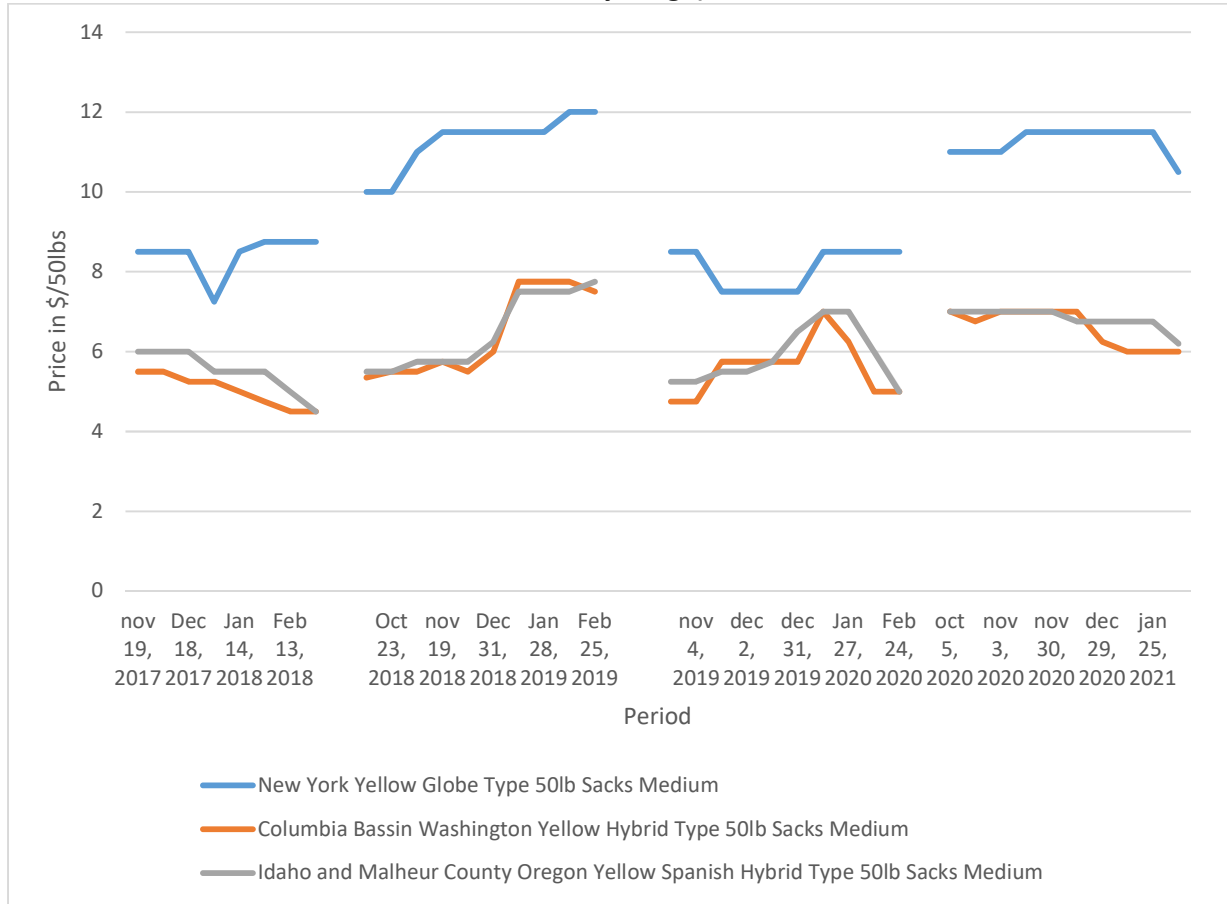

4.4. Focus on terminal⁶⁷ (wholesale) market prices⁶⁸

The terminal market⁶⁹ refers to a physical location in a metropolitan area where wholesalers sell produce to retailers or other large users in wholesale lots. Market reporters gather information on terminal market sales primarily through personal interviews with sellers and buyers. For terminal market price reports, the following conditions apply: *“Unless otherwise stated prices below cover sales by first receivers of available supplies to 9:00 a.m. on this morning’s wholesale*

⁶⁷ About Terminal Report Details, look at the USDA Agricultural Marketing Service: <https://www.marketnews.usda.gov/mnp/fv-help-13>

⁶⁸ <https://www.marketnews.usda.gov/mnp/fv-report-config-step2?repType=wiz&type=termPrice&locChoose=location&commodityClass=allcommodity&run=Run>

⁶⁹ <https://www.marketnews.usda.gov/mnp/fv-help-13>

terminal market. Sales are made from wholesale lots of stock of generally good merchantable quality and condition unless otherwise stated.”

We have mostly compared terminal market prices⁷⁰ corresponding to the following conditions:

- prices come from New York onions, but also other states and Canada;
- packages are 50 lbs sacks;
- onions are yellow and dry;
- the size of onion is medium 2 1/4” minimum;
- prices are given for 50 lbs packages. I have also converted prices for 1 lb or 1cwt;
- for every shipping day, two prices are released (“Low Price” and “High Price”), but in this report, I only present “Low Price”;
- three sub-varieties have been compared (Grano, Hybrid, and Globe);
- three origins have been considered for Globe onions (New York, Canada, and other states)
- the data series is from 2008 to 2019;
- 179 daily prices to 330 prices have been collected depending on the variety and the origin;
- Five “prices” were analyzed: Grano (205 price records), Hybrid (222 price records), New York Globe (330 price records), Canada Globe (318 price records), and other Globe (179 price records).

There is a price difference between onion varieties. Grano and Hybrid varieties are better valued than Globe. Grano and Hybrid are mostly sweet onion, while Globe is mostly sold as a pungent onion (Table 21). Grano prices are over US\$31/cwt on average, and Hybrid prices are close to US\$30/cwt. Prices for New York and Canada Globe are very close, about US\$25/cwt, and are under the prices of Globe onion from other origins. For a similar yellow (Globe) onion that is on the market at the same time, terminal market prices vary from US\$24.30/cwt (lowest average price) to US\$25.42/cwt. Prices mostly fluctuate between US\$22/cwt to US\$28/cwt (Figure 40) but can potentially fluctuate between an extreme range of US\$15/cwt and US\$76/cwt, a ratio of 1 to

⁷⁰ <https://www.marketnews.usda.gov/mnp/fv-report-config-step1?&reportConfig=true&type=movement&repType=wiz&run=Run&dr=1>

5. Higher prices are observed for the few periods during the Shipping season when onion demand is larger than supply due to delays in harvesting or shortage at the end of the production season.

Table 21. Yellow onion prices at the New York Terminal Market - Comparison between origin and varieties -Yellow med 2 1/4" sack 50lb - \$/cwt (2008-2019) (New York Shipping) (USDA)

Price \$/cwt =\$/100lb	Grano		hybrid		New York State orange/western		Canada		NY no Origin	
n	205		222		330		318		179	
	Low	High	Low	High	Low	High	Low	High	Low	High
min	20	20	18	22	16	16	14	15	16	18
max	60	76	44	48	50	68	64	68	60	72
Average	31.00	34.00	28.20	30.40	24.30	26.70	24.5	26.80	25.42	27.92
SD	7.00	9.00	4.62	5.02	5.26	6.12	5.70	6.00	5.88	7.02
Coef var	0,24	0,25	0,17	0,17	0,23	0,24	0,23	0,22	0,23	0,25

Prices vary between years. For example, in 2010, Grano and Globe onions sold at higher prices.

These higher prices were similar at the farm gate (see above).

However, it appears that the price at the beginning of the shipment season very quickly defines an average price that reflects the state of the market. Nevertheless, prices may vary according to harvest levels for the states and countries that supply the U.S. onion market month after month (Fig. 43 and Table 16 [above]).

Figure 43. Onion Terminal Market price (\$/1lb) Yellow med 2 1/4" sack 50lbs 2008-2020 (New York Shipping) (USDA)

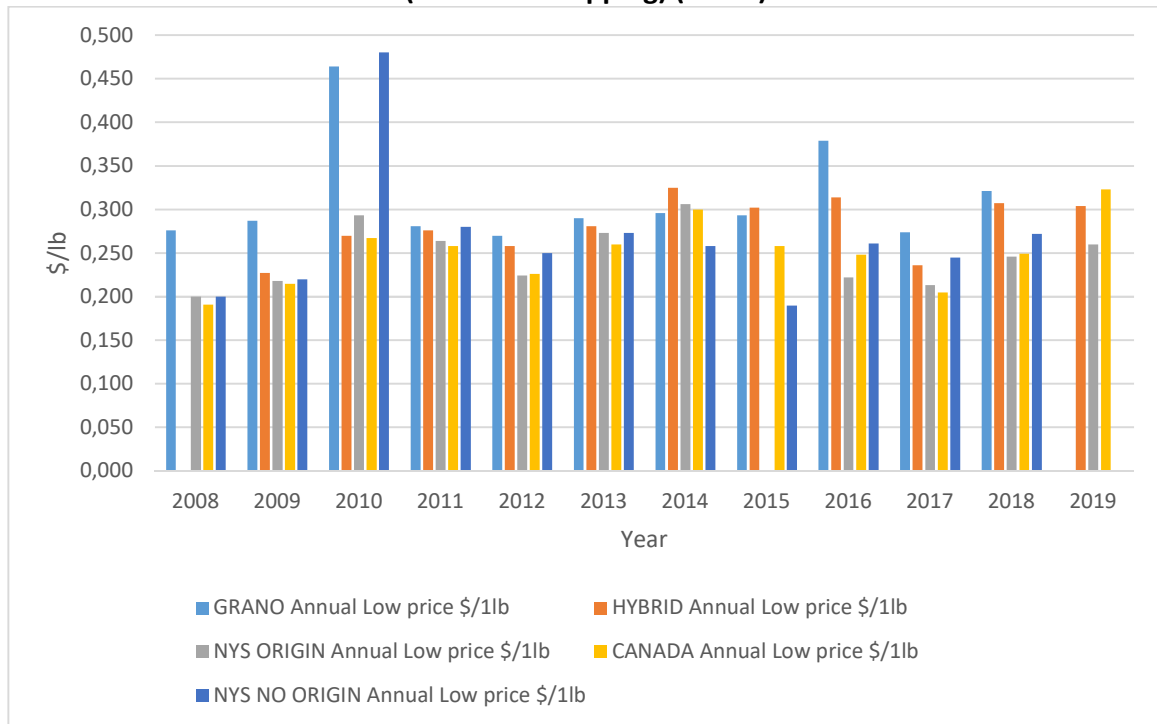

Important harvests from different states can enter the market at the same time, exacerbating competition and thus causing prices to fall (or to increase) very quickly.

When we focus on onions of New York and Canada origin, we can observe that prices are very close and that from 2008-2018, New York prices were better than Canadian prices (Figure 44). 2019 (reflecting the 2018 marketing season year) is the first year that Canada's average price was US\$5.5/cwt larger than New York's, a difference of 20%. But this was an aberration. Typically, these prices move together because New York and Canadian onions are perfect substitutes. Both are produced on muck, with similar climate, and costs. I wish to note that New York's production of medium onion was absent from the 2015 marketing season. Medium-sized onions were completely replaced by Jumbo size, and because I have chosen to focus on medium size, we do not have data for this marketing season year.

Figure 44. Onion Globe type Terminal Market price (\$/1cwt) Yellow med 2 1/4" sack 50lbs Canada vs NYS Origin 2008-2019 (New York Shipping) (USDA)

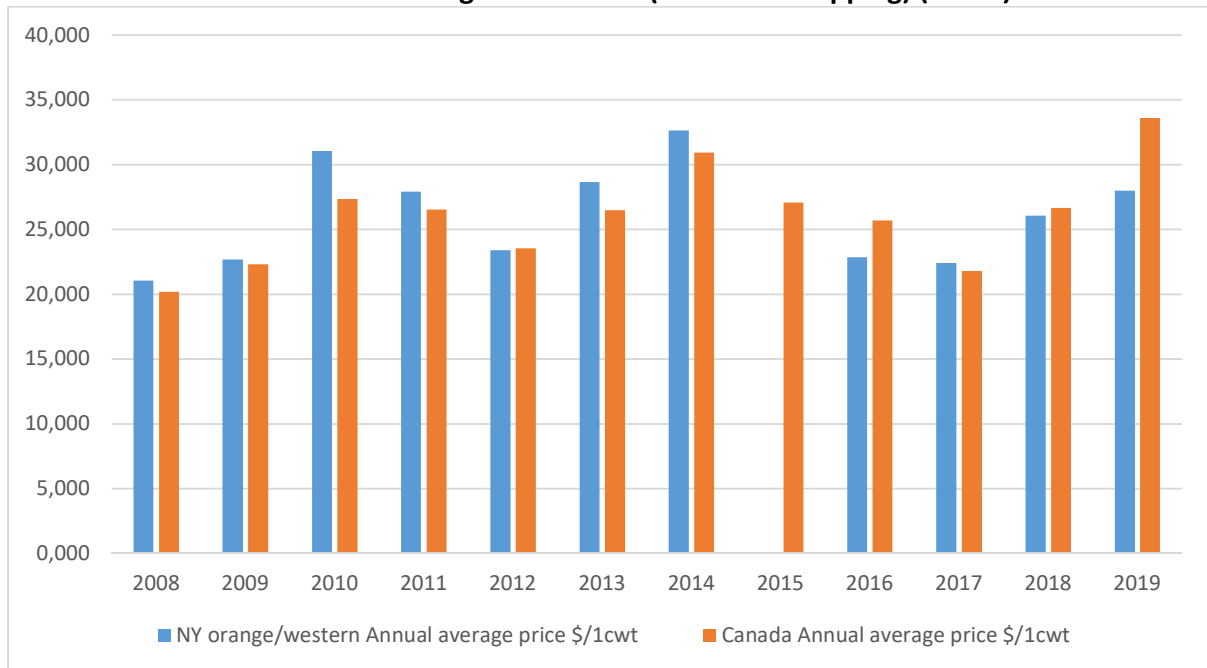

During this period, onions of Canadian origin were on the market longer than NY onions. NY onions were present 49 out of 107 months; for 26 months (1/2 of months present), the price was less than US\$25/cwt. On the other hand, Canadian onions were present 67 out of 107 months; for 25 months (1/3 of months present), the price was less than US\$25/cwt (Figure 45). This is likely due to Canadian investment in controlled atmosphere storage.

Based on this comparison, Canadian growers have had the same behavior on the market for 12 years. So, why do we read complaints from growers such as:

“We went from \$28 for a 50-pound bag down to \$12 within a couple of weeks,” said an onion farmer in Orange County who had been chronicling his struggles in September 2019 (Civil Eats, 2020)⁷¹. *“...farmers have been forced to sell at that low price, as buyers are suddenly hard to find.*

⁷¹ <https://civileats.com/2020/02/07/new-york-farmers-are-struggling-to-sell-their-onions-u-s-lawmakers-want-a-trade-investigation/> Retrieved January 15, 2021

Figure 45. Terminal Market prices comparison - NY State vs Canada (origin) (\$/cwt) Yellow med 2 1/4" sack 50lb 2010-2019 (New York Shipping) (USDA)

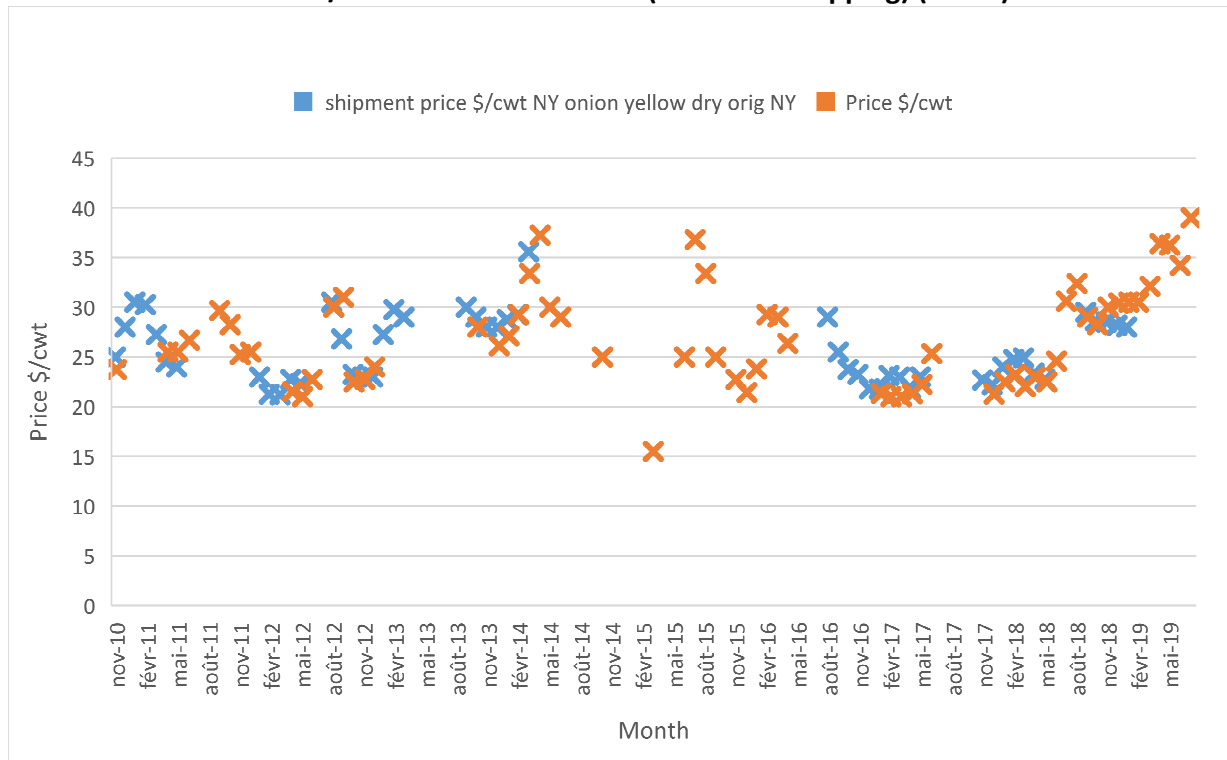

These same allegations are made by senators who defend the interests of New York farmers:

“New York State is home to prime onion-producing land, yet our farmers are unable to sell their goods in a domestic market that is flooded by cheap Canadian exports,” Senator Gillibrand said in a statement. *“Farmers across the country have been struggling to keep up with growing production costs, while Canadian exporters have been able to dump cheap onions onto the market at prices comparable to 30 years ago.”*

2019/2020 seems to be similar to previous years. The average price, based on 153 price records from September 7, 2019, to May 30, 2020, for medium-sized, packaged Canadian onions was about \$14.70/50lbs (standard Deviation of 1.88, meaning two-thirds of the prices are between \$12.82/50lbs and \$16.58/50lbs) (Figure 46).

Figure 46. Onion Globe type_Terminal Market price for 50 lbs (\$/50lb) Yellow mid size & all Package - Canada Origin Season: 2019/2020 - New York Shipping (USDA)

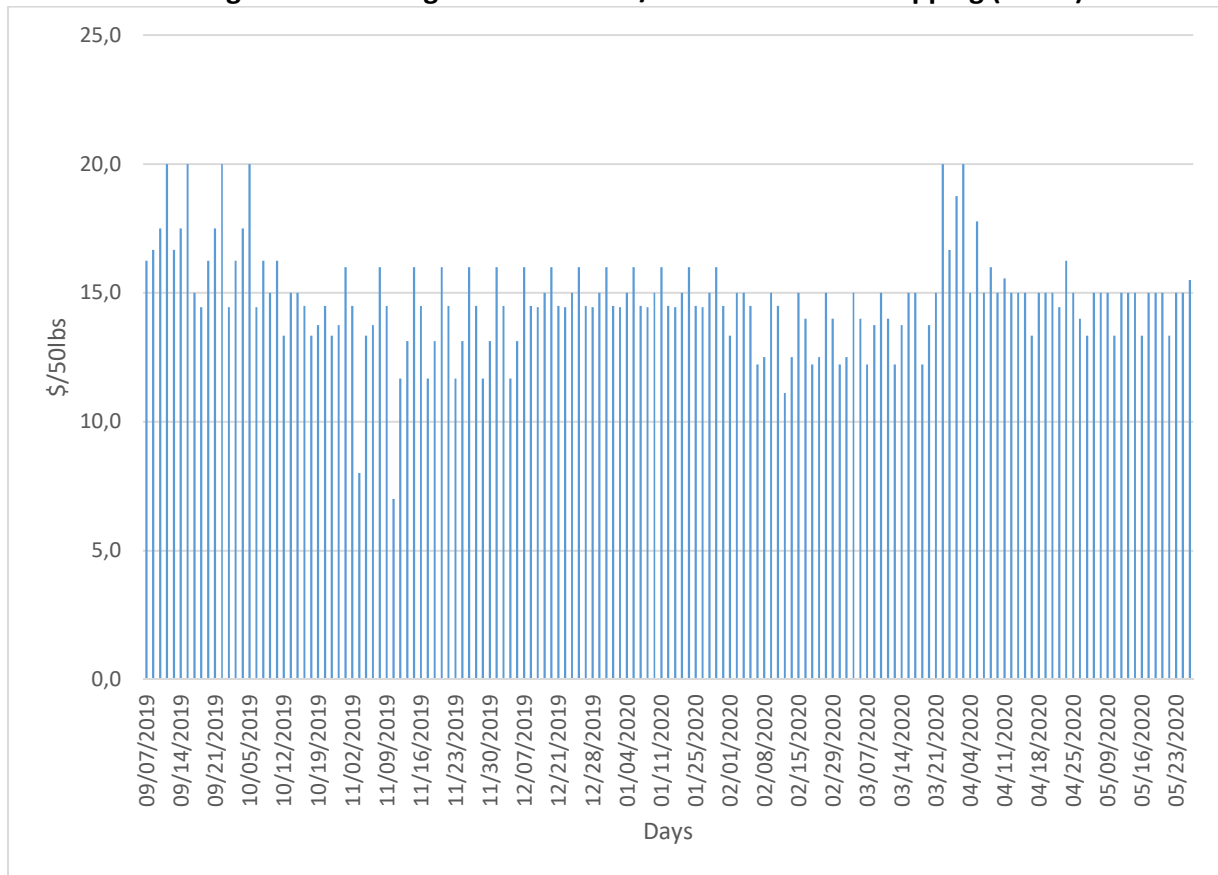

Nevertheless, New York State growers mentioned very low prices, but only seven price records under US\$11/50lbs exist. Even though 2019/2020 (production season 2019) does not seem exceptional, it was for a small category of onions. For medium-sized (med) Globe type onions, packaged in 50 lbs. sacks, prices were very high before the harvesting period, about US\$28/50lbs. in August 2019. Only Canadian onions supplied the market. These prices were exceptional because they were twice the average price (US\$14/50lbs or US\$28/cwt). Then, beginning in August 2019, Canadian, medium-sized onion prices fell steadily to a low of US\$7/50 pounds, almost twice below average (Figure 47). In three months, the price fell by nearly 75%. However, only five days in October and November 2019 had prices dip under \$10/50lbs. Indeed, in mid-November, a specific medium size (med) onion from Canada left definitively the market for this Shipping season.

Figure 47. Onion Globe type_Terminal Market price (\$/50lb) Yellow Med Size sack 50lb Canada Origin Season 2019/2020 (New York Shipping) (USDA)

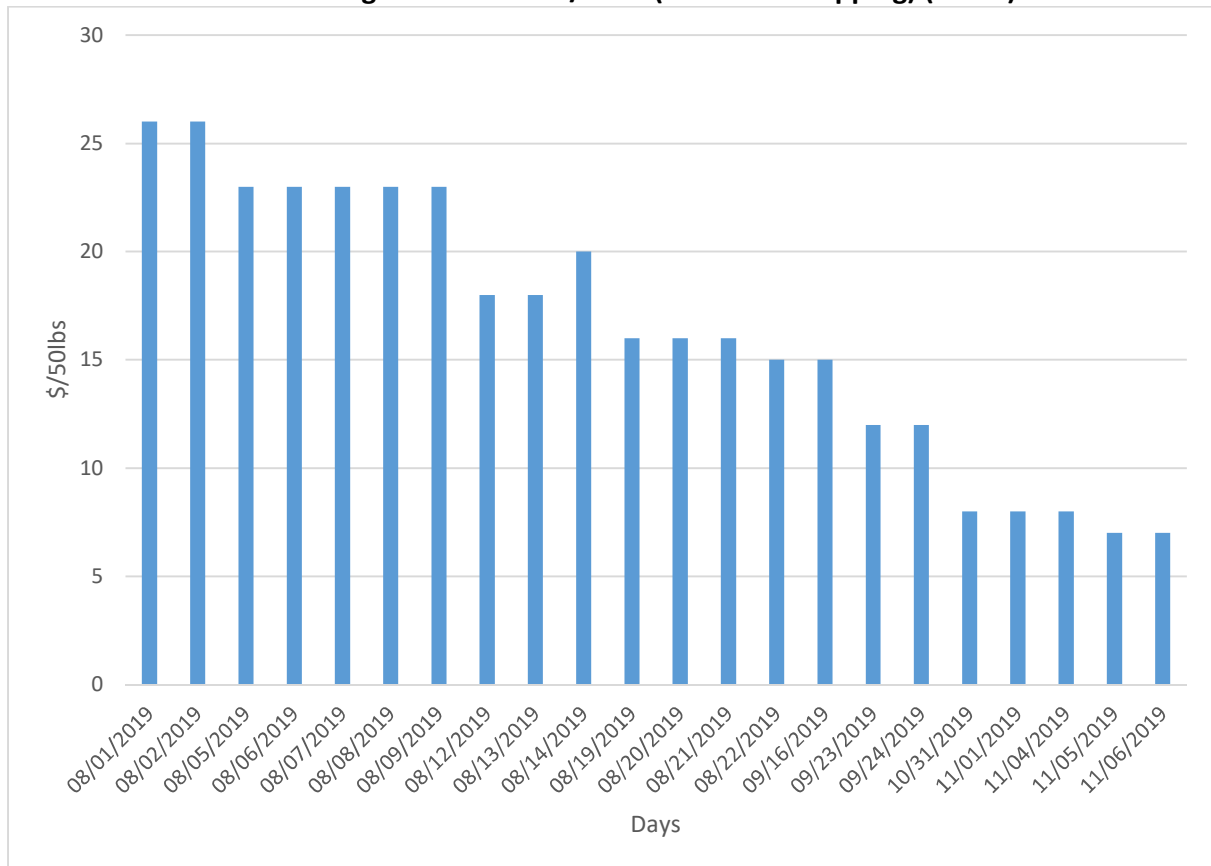

Even though these prices have been very low, we do not know what quantities had been sold on the market. If quantities had been very large, we can assume this would result in low market prices. However, this is not what happened since neither the market for other Canadian onions nor New York onions had been driven down in price. Indeed, prices for Canadian onions averaged approximately US\$14.70/50lbs (Figure 47), and for New York onions, overall prices were fairly constant (Figure 48). Based on 107 price records from September 7, 2019, to May 30, 2020, the average price for "medium" sizes and all package types was approximately US\$14/50lbs (standard deviation of 2.35., meaning two-thirds of the prices were between US\$11.67/50lbs and US\$16.33/50lbs).

Figure 48. Onion Globe type_Terminal Market price for 50 lbs (\$/50lb) Yellow mid size & all Package - New York State Origin - Season: 2019/2020 - New York Shipping (USDA)

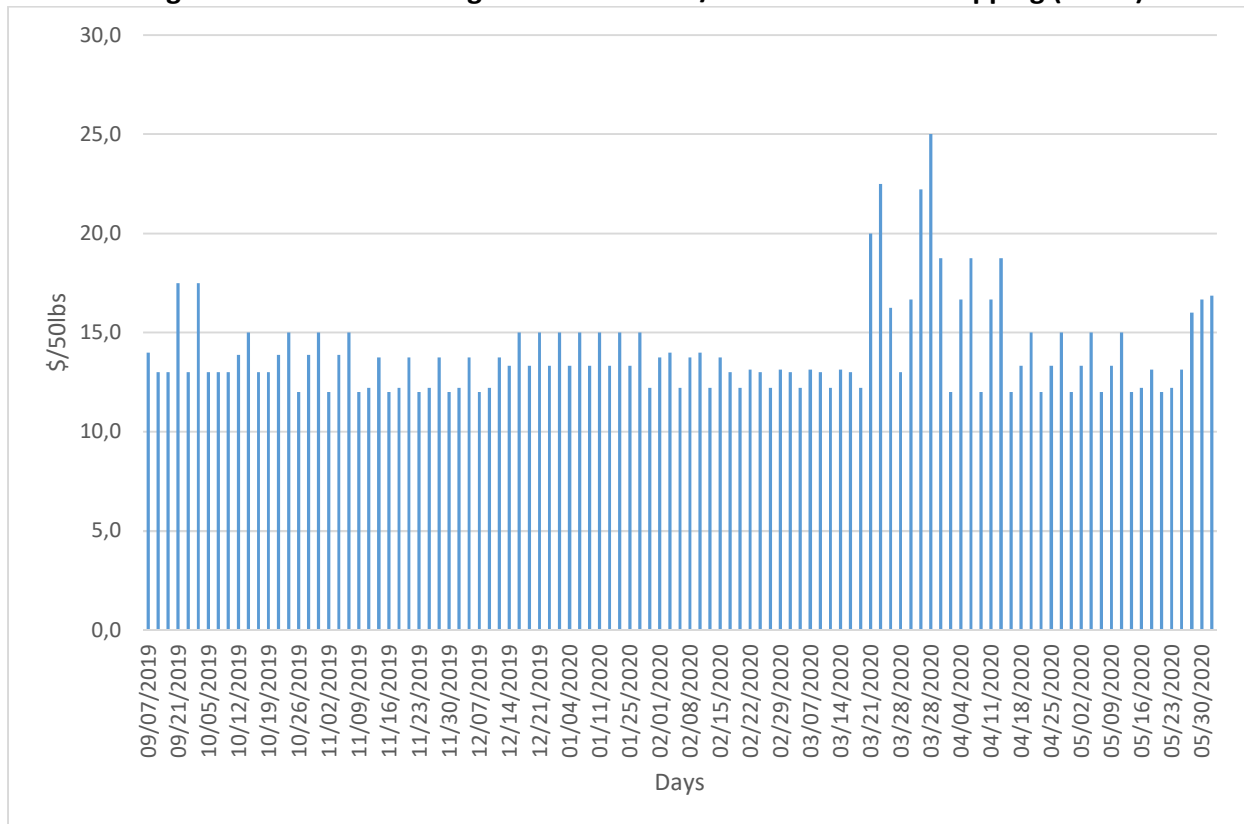

From price data at the shipping point and terminal market, I conclude that Canadian exporters have not been able to cheaply dump onions onto the market at very low prices to destabilize the Northeast U.S. onion sector. We must assume that these very low prices are exceptions. In situations where the commodity is perishable, a delivery person may have to sell at a loss or not sell his production at all. Sometimes a handler can accept to reduce his price for a category of onion, to access a more profitable market, with another category.

Given that these low prices are exceptional, it cannot be argued that, since Canada has similar production costs to New York, the only way to provide low-priced onions is by lowering the net production cost through subsidies to Canadian producers, when such subsidies do not exist.

Besides, it is not in the interest of any Canadian (or U.S. grower) to sell their onions at the lowest price when they can sell on more profitable markets, such as the New York terminal market where

prices in 2019/2020 were close to US\$15/50lbs on average. For Canadian growers faced with lower prices (US\$8.5 to US\$10⁷² per 50lbs) on the Montreal (Québec) wholesale⁷³ to retail market from September 2019 to March 2020 (Figure 49), they could have taken the opportunity to sell their onions on the U.S. market at US\$15/50lbs⁷⁴. Wholesale prices were extremely low from September 2019 to March 2020 than for September 2018 to March 2019.

Figure 49. Yellow Onion (Globe Type) - Monthly Summary of Daily Wholesale to Retail Market Prices Wholesale-Montreal - \$US/50lbs (Agriculture and Food Canada⁷⁵)

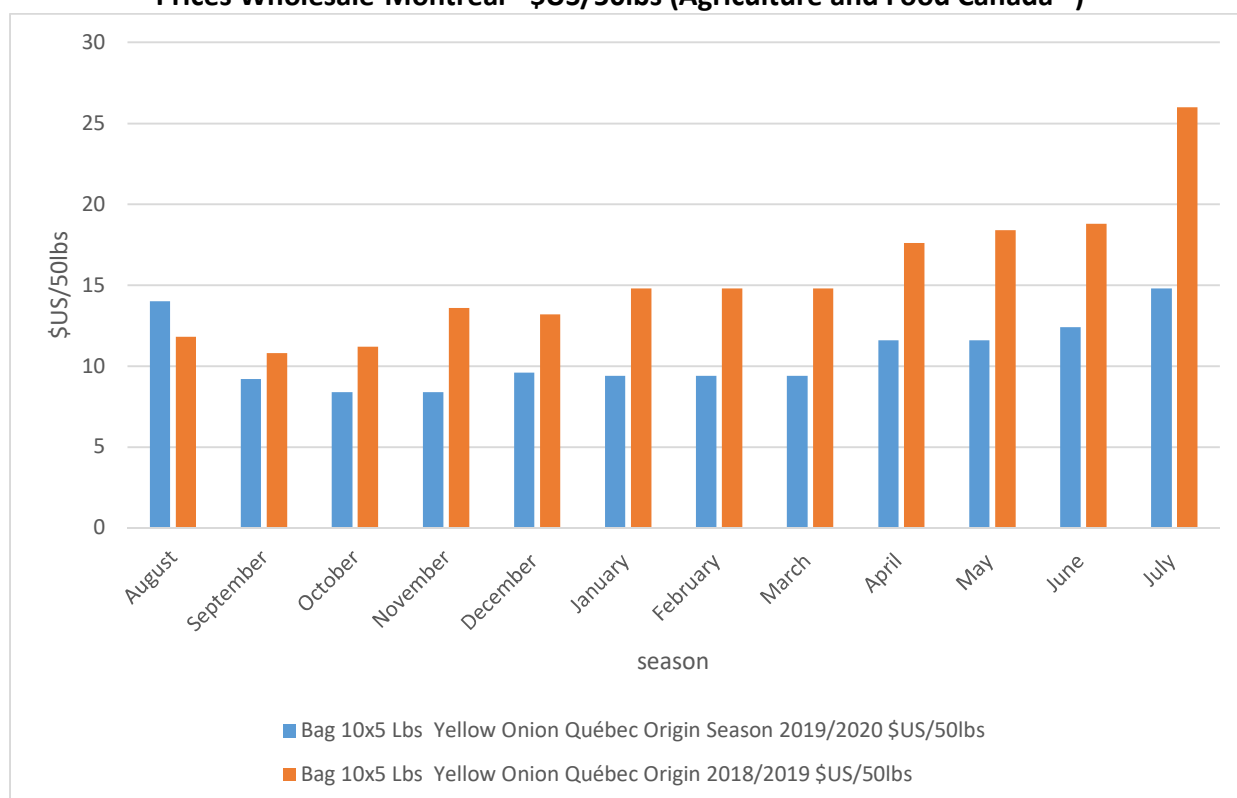

⁷² I used Low price (and not High price). I only present low price to compare the price between the multiple markets. During the period September to March, “High prices” are \$1-\$2 higher.

⁷³ Annual Summary of Daily Wholesale to Retail Market Prices – Wholesale-Montreal. Prices are in CAN\$. I converted canadian prices in US\$: <https://aimis-simia.agr.gc.ca/rp/index-eng.cfm?action=gR&r=315&signature=F12F95728A99615F2AF6D47896B03DB5&pdctc=&pTpl=1#wb-cont> Retrieved February 1, 2021

⁷⁴ So the implication is that there was a glut of onions in Montreal, so they could have made more money by shipping to NYC and even given transportation sold them for less than US \$15.50

⁷⁵ For further details on Wholesale Price reports in Canada, take a look at: <https://agriculture.canada.ca/en/canadas-agriculture-sectors/horticulture/market-information-infohort/wholesale-price-reports?menupos=01.02.02.02>

Lastly, I compared prices between New York and Canada's onions at two terminal markets, New York and Philadelphia, during the 2019/2020 season (Figure 50).

Prices in New York are generally lower than prices in Canada with rare exceptions as we have seen before, whatever the terminal market. Canadian exporters can better value their onions in the U.S market, especially at the Philadelphia Terminal Market. Again, no evidence supports the idea that Canada is attempting to destabilize the northeastern U.S. onion sector since Canadian exporters would actually drive up prices, even though more onions could drive the price down.

Figure 50. Onion Globe type_Terminal Market price for 50 lbs (\$/50lb) Yellow Medium Size - NYS & Canada Origin - Season: 2019/2020 - New York and Philadelphia Shipping (USDA)

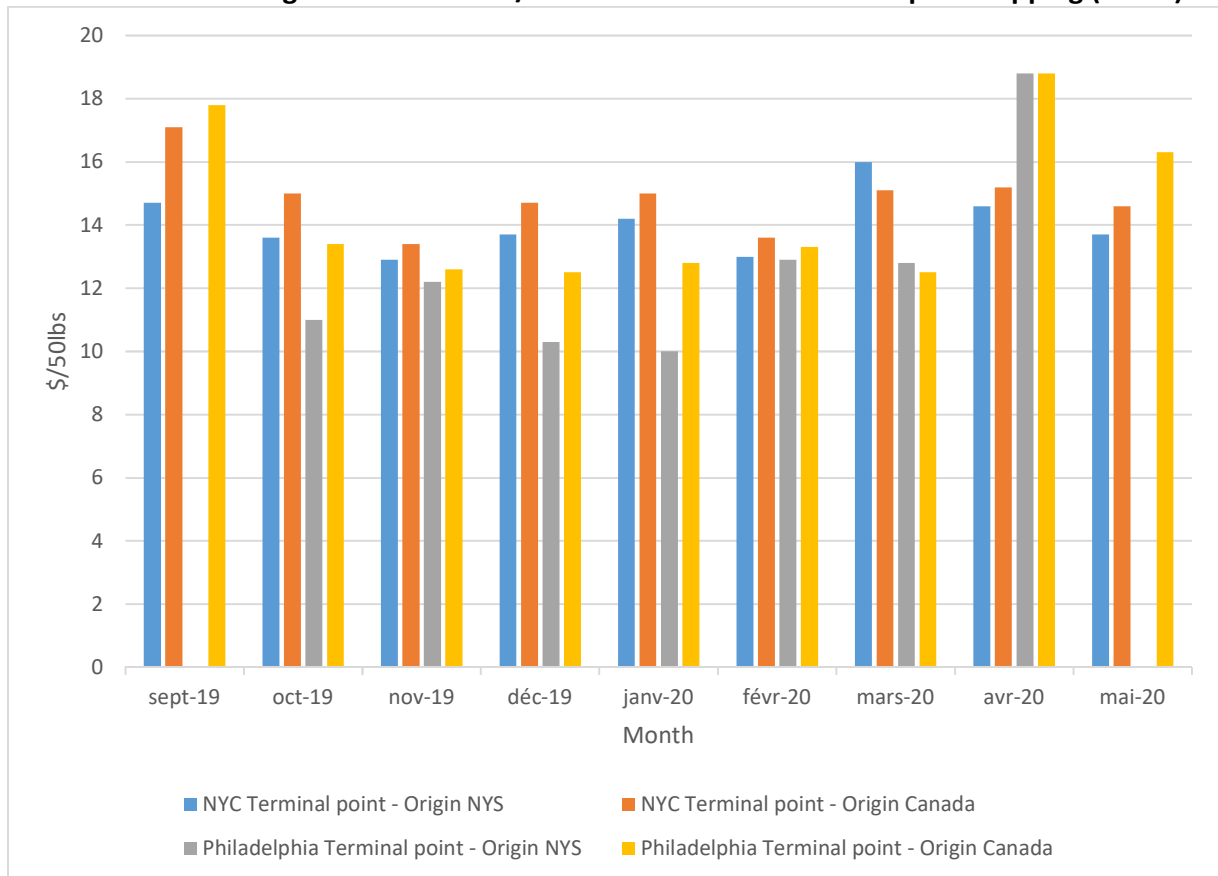

Before analyzing prices at the retail stage, I compared shipping point prices to terminal prices for New York yellow onion (Globe type, 50 lbs sack, medium size). As expected, terminal market prices are always higher than shipping point prices. The average difference over the last 10 years (2011-2020) is about US\$5/cwt (Figure 51).

**Figure 51. Monthly average Shipping point price vs Terminal Market price, 2011 to 2020
New York Origin - Yellow Globe type NYC Sack 50lbs Med (\$/cwt) (USDA - Market News)**

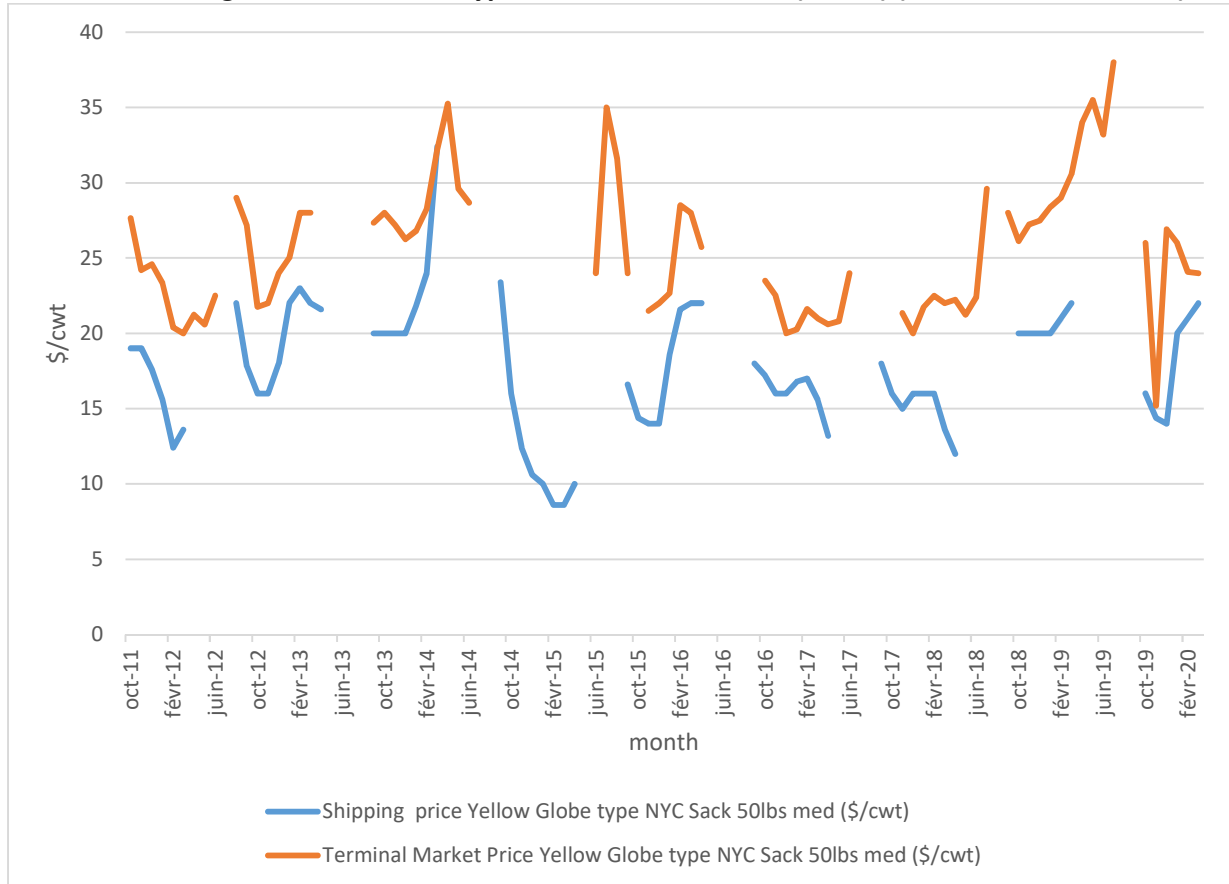

4.5. Focus on retail⁷⁶ prices

We have mostly compared retail prices⁷⁷ corresponding to the following conditions:

⁷⁶ About Retail Report Details, look at the USDA Agricultural Marketing Service:
<https://www.marketnews.usda.gov/mnp/fv-help-17>

⁷⁷ <https://www.marketnews.usda.gov/mnp/fv-report-retail?portal=fv&startIndex=1&class=ALL®ion=NATIONAL&organic=ALL&commodity=ALL&reportConfig=true&dr=1&repType=wiz&step2=true&run=Run&type=retail&locChoose=location&commodityClass=allcommodity>
Specialty Crops Market News surveys more than 500 retailers, comprising over 29,000 individual stores, with online weekly advertised features. Information represents advertised prices for onions at major retail supermarket outlets. Weighted averages are simple weighted averages. The simple weighted average is the number of stores multiplied by an advertised price for a certain commodity/variety/unit. Retail data represents one week of data collection ending on the report date and encompasses advertisement pricing from the Saturday before the report date through the following Thursday.

- Prices are from onions sold in the Northeast U.S. region. I assume this is the critical marketing area for New York growers;
- onion is yellow, dry onion;
- size of onion is medium 2 1/4" minimum;
- prices are given for 1 pound;
- for every retail day or week, two prices are released "Low Price" and "High Price," but in this report, I only present low price;
- two types are compared (yellow "pungent" vs. yellow marked sweet);
- the data series are from 2011 to 2020;
- retail prices for yellow onion come from 46,943 stores, providing 437 daily prices (based on a minimum of 2 stores and a maximum of 255);
- retail prices for yellow sweet onion come from 457,737 stores located in the northeast U.S., providing 500 daily prices (based on a minimum of 14 stores and a maximum of 2787).

These prices are computed to produce a simple weighted average.

We have already mentioned that onion consumption is increasing. Every year, each American consumer buys 20 pounds. Onion is appreciated for its variety of uses; a staple and mixed-use food, onions are used as condiments and the main ingredient. The widespread consumption of onions can also be attributed to its affordable price. According to a recent study from the USDA, onion is ranked 20/50 least expensive vegetable (Figure 52).

Figure 52. Price ranking in the U.S. for 50 Vegetables – Calculated from 2016 - USDA, Economic Research Service

Fresh Onion Rank 20/50 least expensive
 \$0.41/cup ≈ \$1.43/lb (3.49 cups = lb)

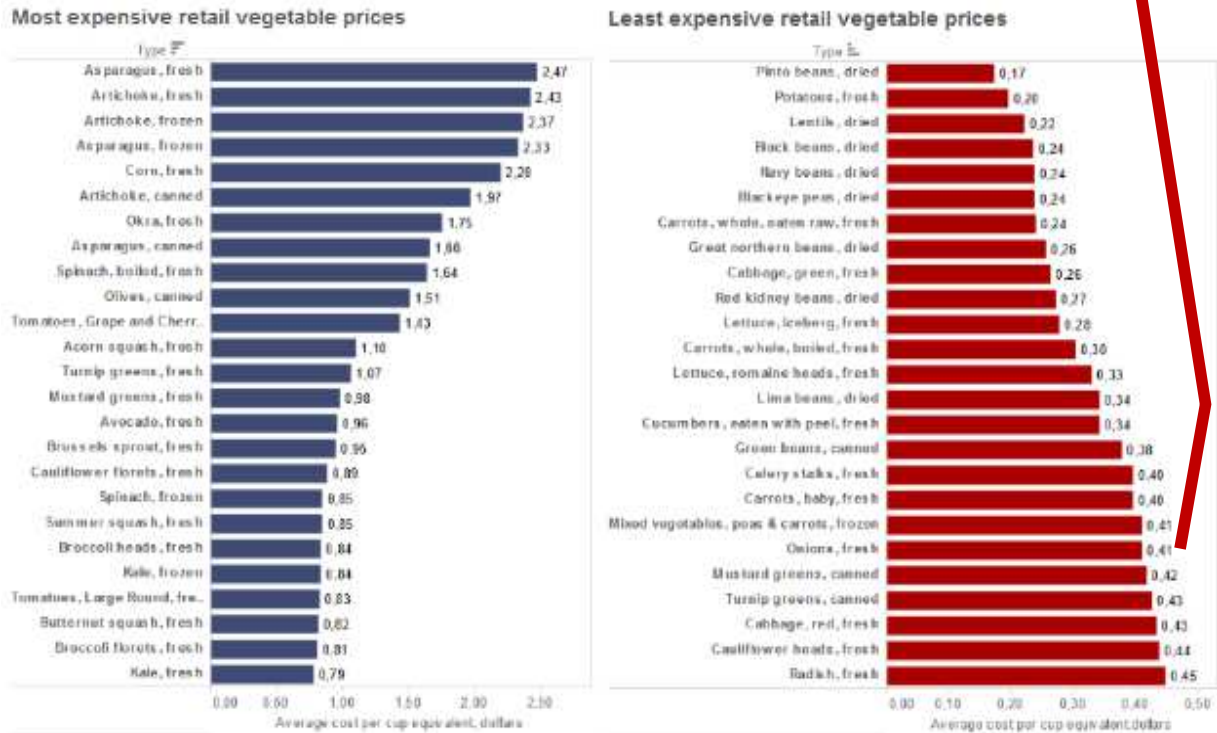

Source: USDA, Economic Research Service. Calculated from 2016 IRI Infoscan data; the USDA National Nutrient Database for Standard Reference, Release 26; and the 2009-2010 Food Patterns Equivalents Database (FPED) as well as the FPED's accompanying Methodology and User Guide.

We provide a general overview of price differences between onion types.

Onions are close in price to other vegetables like carrots, turnips, red cabbages, or celery, with an average cost per cup equivalent dollar around US\$0.41. Onions are valued two times greater than potatoes, so onions are not always considered a basic food with a price so low that it is unable to change.

We start with the retail price over the last 10 years for yellow globe type onions, which correspond to pungent onion grown in New York and Canada. These retail prices are based on daily average prices from 47,000 stores that provide 437 daily average prices. On average, the retail price is \$0.95/pound (Table 22). 93.5% of these prices are between US\$0.5/pound and US\$1.5/pound.

Two-thirds of these prices are between US\$0.64/pound and US\$1.26/pound. Thus, retail prices are volatile, such that retailers do not supply onions at the same price all year round. Retailers do not absorb price volatility even though they generally do not like to always change prices. Instead, they indirectly transmit the price offered by packers and growers to the final consumer.

**Table 22. Retail Price Nov 2010 – Sept 2020 for Yellow (not sweet) Onion (437 obs.)
437 prices (per pound) from 46,943 stores (min 2 stores / max 255) Northeast U.S. region
(USDA)**

	Weighted Avg Price/pound	Low Price	High Price	smooth price (6 days)
min	0.23	0.23	0.23	0.52
max	3.57	1.50	3.99	1.49
Average (Av)	0.95	0.75	1.08	0.95
Standard Deviation (SD)	0.31	0.25	0.37	0.15
CV: SD/Av	0.32	0.33	0.34	0.16
Median	0.92	0.79	0.99	0.94

Retail price per year for the last ten years can be divided into three groupings (Figure 53). The first group (blue color) experienced the best prices of the decade (more than US\$1/pound) and includes 2011, 2012 and 2017. The second group (grey color) consists of four years (2013 to 2016) with a flat price, around US\$0.95/pound. The third group (green color) includes the last three years (2018 to 2020), with prices under US\$0.9/pound. We must assume the retail price has decreased since 2011.

Figure 53. Retail Price Nov 2010 – Sept 2020 for Yellow Dry Onion per year (437 obs.) Northeast U.S. region (USDA)

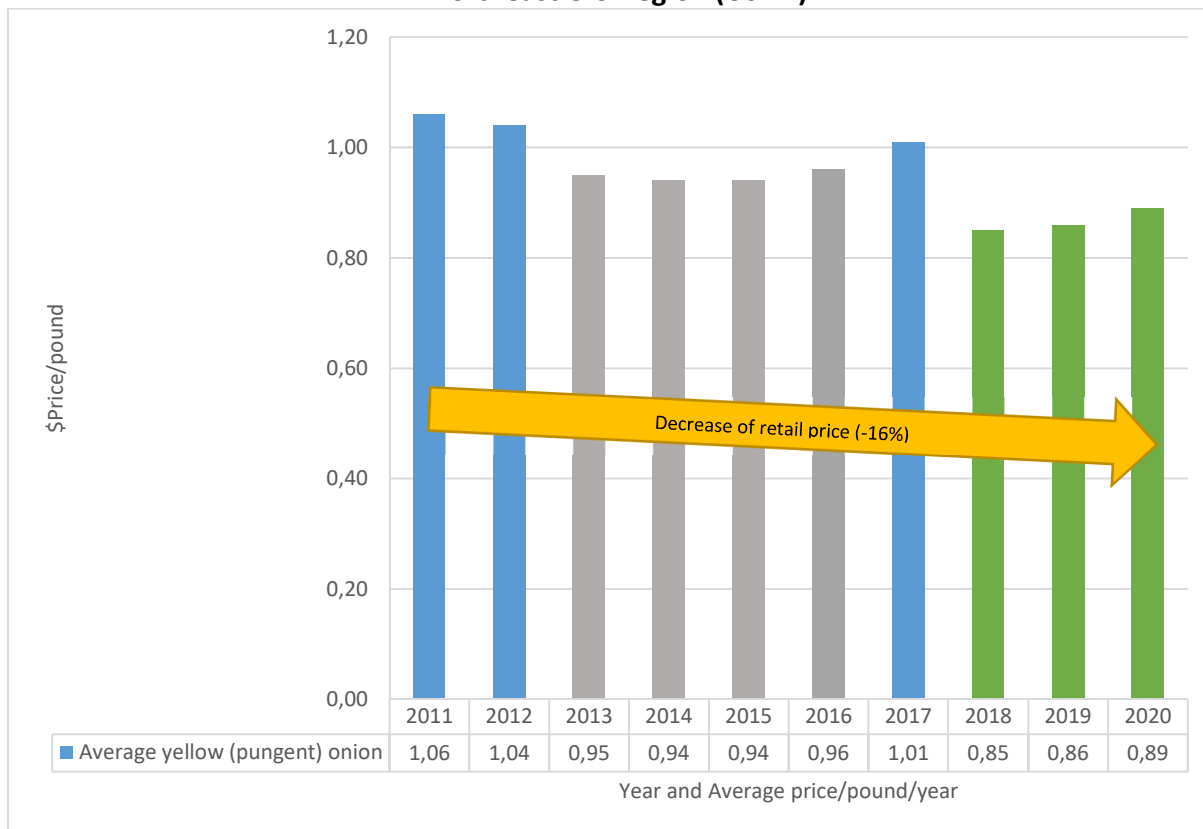

Indeed, over the last ten years (November 2010 to September 2020), the retail price has gone down from about US\$1.06/pound to US\$0.90/pound, a 16% decline (Figure 53). Notice that the current retail price differs from the current price at the farm gate (Figure 31, above). Indeed, the current price at the farm gate increased by 10% during the same period.

Retail prices are volatile (Figure 54). This phenomenon is observed for vegetables but not for products such as milk, meat, or flour. Vegetables are heavily influenced by weather and season. Moreover, onions are a raw commodity, and since there is little change between production and retail, a price fluctuation due to a change in volume directly affects the price. Indeed, from farm to fork, operations are mainly storage, grading, packaging, and shipping. For a product like flour, a change in the farm gate price of wheat has little effect on the retail price because wheat is only

5-6% of the retail price of soft bread. Therefore, even if the farm gate price changes significantly, the effect on the consumer is marginal.

The volatility of yellow onion prices signals the difficulty at the supply chain's front end to control volume, placing growers and handlers in an unavoidable and undesired situation. Therefore, New York pungent onions are "trapped" in a supply chain that treats their onions as a commodity. Retailers consider onions a staple and probably a "loss-leader product" that is sold cheaply to attract customers.

**Figure 54. Retail Average smooth price (6 day-prices) 2011 - 2020 Yellow Onion (USDA)
Current\$/pound (437 obs.)**

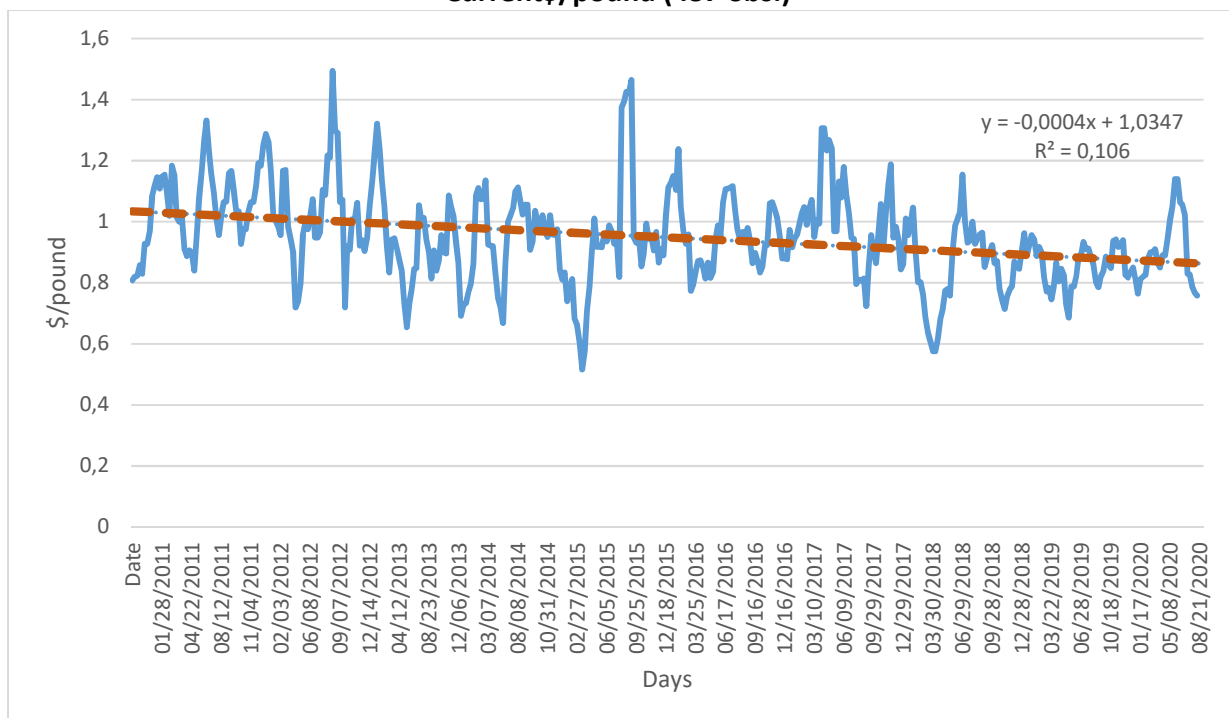

We now focus our analysis on the retail price for yellow sweet onions, which can correspond to sweet onions grown in Georgia, Peru, and Mexico, over the last ten years. These retail prices are based on daily average prices from 458,000 stores that provided 500 daily average prices. On average, the retail price is US\$1.29 per pound (Table 23). Two-thirds of these prices are between US\$1.13 /pound and US\$1.45/pound. Sweet onion retail prices are volatile but less than yellow,

pungent onion. The coefficient of variation is lower for yellow sweet onion than for yellow, pungent onion, and the level of dispersion around the mean is lower, 0.12 vs. 0.32, respectively. The lower volatility of yellow sweet onion prices signals a better ability at the supply chain's front end (growers and handlers) to control volume and quality.

Table 23. Retail Price Nov 2010 – Sept 2020 for Sweet Onion (500 obs.) 500 prices (per pound) from 457,737 stores (min 14 stores / max 2787) Northeast US region (USDA)

	Weighted Avg Price/pound	Low Price	High Price	smooth price (6 days)
min	0.90	0.39	1.29	1.05
max	1.97	1.29	3.99	1.63
Average (Av)	1.29	0.80	1.76	1.29
Standard Deviation (SD)	0.16	0.15	0.27	0.11
CV: SD/Av	0.12	0.19	0.15	0.08
Median	1.29	0.79	1.78	1.29

My analysis of the retail price for yellow sweet onion per year over the last 10 years shows a different situation than yellow (pungent) onion (Figure 55). Annual average prices of sweet onion are always more than US\$1.20/pound. The ten years can be divided into two groupings. The first group (Blue color), from 2011 to 2014, experienced the best prices of the decade, with average prices exceeding US\$1.30/pound and continually increasing from US\$1.30 to US\$1.38/pound. The second group (Green color), from 2015 to 2020 (excepted 2019), experienced decreasing prices and fluctuations between US\$1.21 and US\$1.30/pound. Prices stabilized around US\$1.23/pound at the end of the decade.

Figure 55. Yellow Sweet Onion average daily price 2011 - 2020 per year \$ current/pound Northeast US region (USDA)

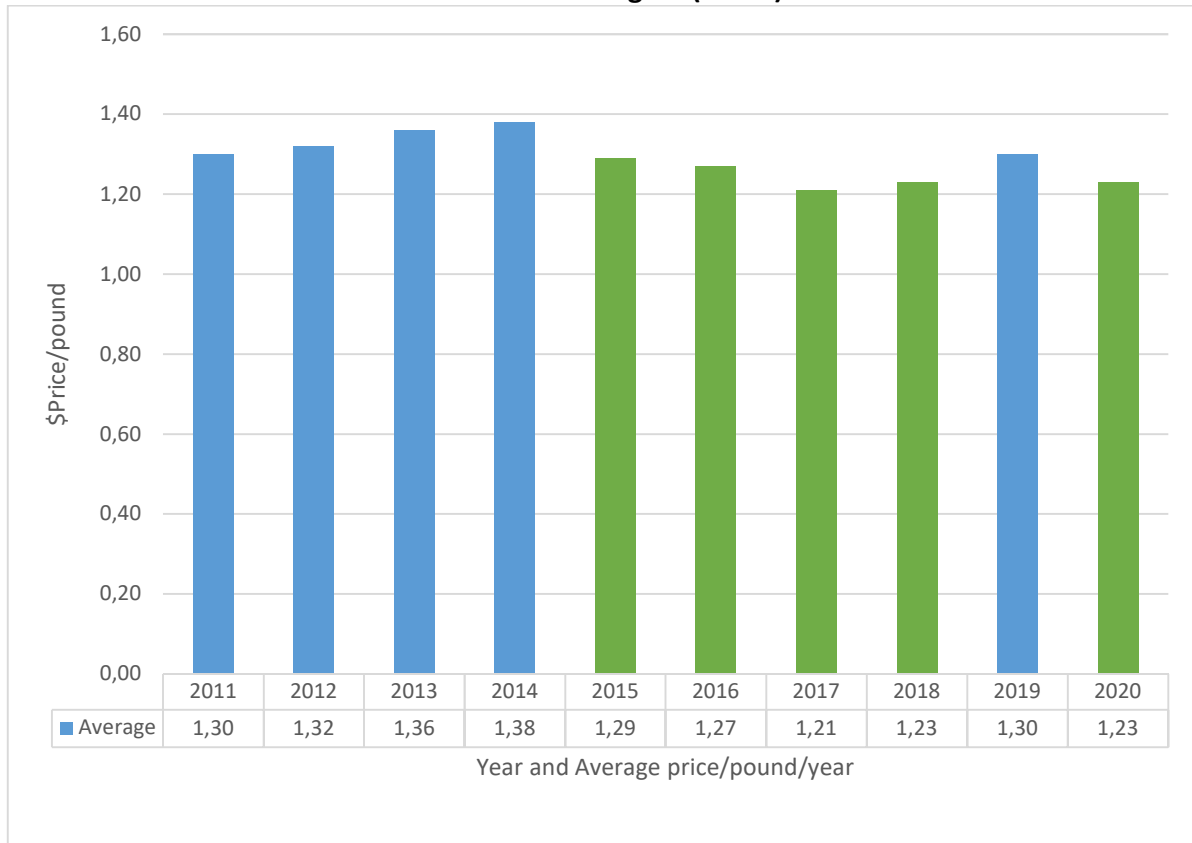

Over the last ten years (2011 to 2020), the retail current (Not adjusted for inflation) price of yellow sweet onion has decreased from US\$1.34/pound to US\$1.22/pound, a 10% decline (Figure 56). It is important to note that this represents the current price and differs from the farm gate's current price (Figure 31, above). Indeed, the current price at the farm gate increased by 10% during the same period.

Figure 56. Retail Average smooth price (6 day-prices) for yellow Sweet Onion- \$ current Northeast US region 2011 - 2020 (USDA)

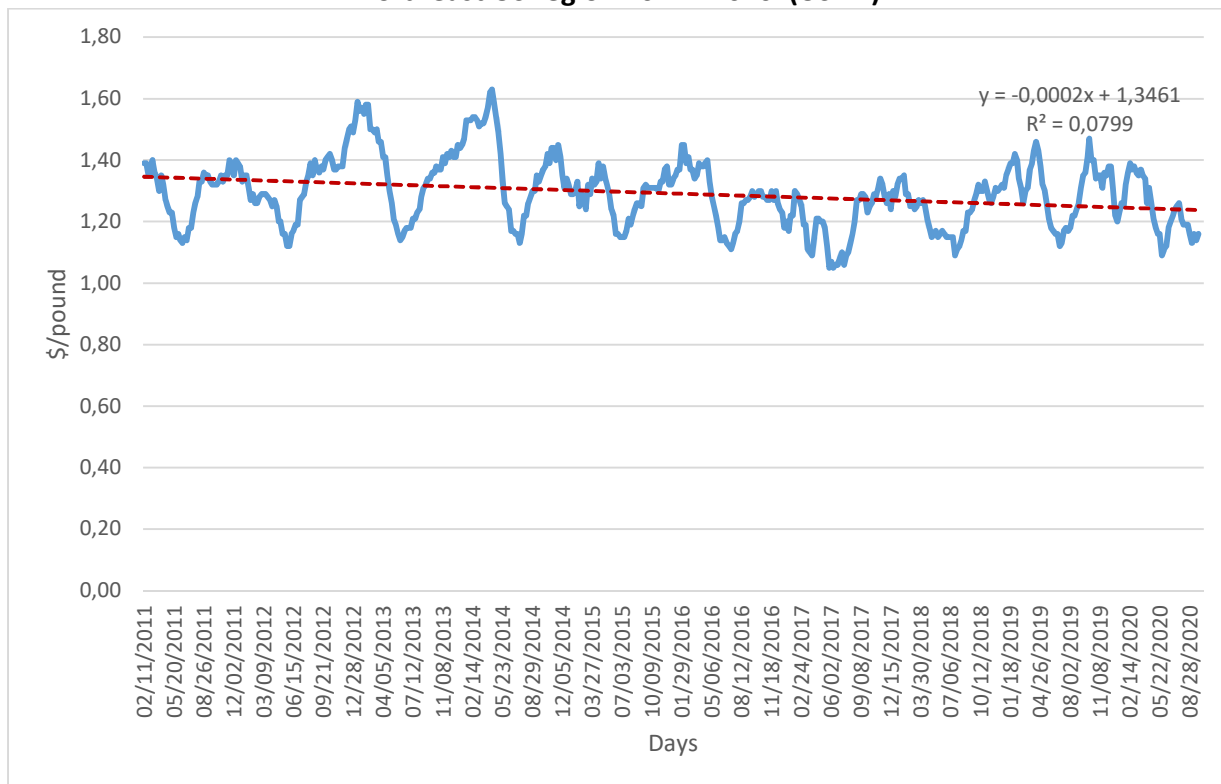

The downward trend of retail onion prices can be explained by increased competition, which has led to downward pressure on prices. Major U.S. retailers have started sourcing their supplies from outside the country. Mexico, Peru, and, to a lesser extent, Canada have increased exports to the U.S. However, this change is also partly due to a few U.S. grower-handlers who have expanded their operations into Mexico and Peru to supply the U.S. onion market year-round

To conclude this sub-section dedicated to retail prices, I note that yellow onion prices differ depending on the variety. Yellow sweet onion is better valued than yellow (pungent) onion, \$0.24/pound to \$0.44/pound (or 20% to 50%), depending on the year (Figure 57).

Figure 57. Retail Average Price 2011 - 2020 Current\$/pound - Northeast US region - Yellow onion vs Yellow Sweet onion (USDA)

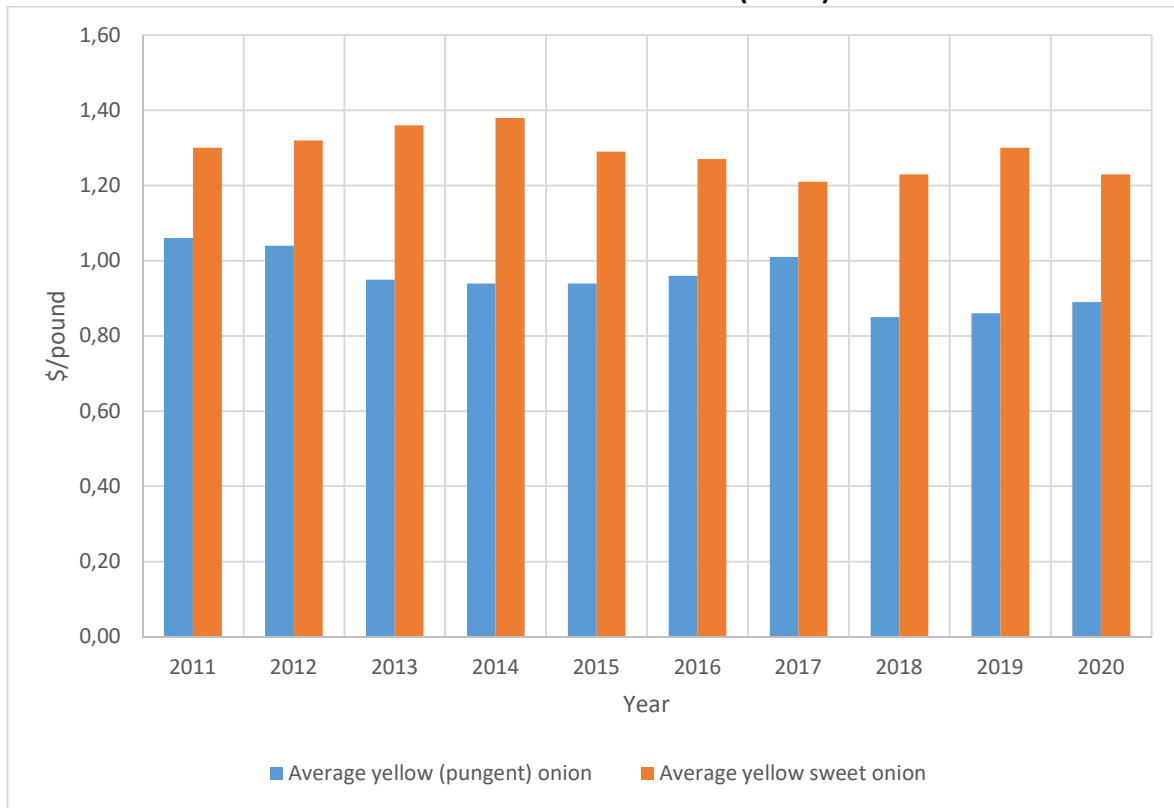

This difference between yellow sweet onion and yellow pungent onion is probably due to two main factors:

- The first concerns the key role of Vidalia onion notoriety and reputation in pulling yellow sweet onion prices up. For forty years, Vidalia onion growers have spent time and money promoting a unique brand and increasing the quality of their onions and their reputation.
- The second concerns the lack of notoriety and reputation of onions from New York. Despite efforts by a few growers (see the New York Bold onion experience⁷⁸), NY pungent onions perform poorly on the market. We must assume that New York pungent onion growers are "trapped" by a low-value reputation. Retailers consider onions a staple and probably a "loss-leader product" that is sold cheaply to attract customers.

⁷⁸ <https://newyorkbold.com/>

The literature on quality labels and trademarks in the agri-food sector has mainly assumed that a quality label or a brand signals a higher value for retailers and consumers.

Brands increase the marketing power of growers in grower-retailer relationships. Knowledge of the product by customers and thus the transmission of this knowledge throughout the sector play a key role in its notoriety and, consequently, its value. New York onions do not have much notoriety, even if its reputation seems quite good. Indeed, gourmets appreciate this pungent onion because it has specific culinary qualities. A better knowledge of this onion would allow a valuation more consistent with its real quality. I suggest one way to improve relations between producers and distributors is through "a tripartite cooperative relationship between a supermarket chain, packers and growers, as part of a vertical partnership approach for the implementation of a value chain." The lack of involvement of onion growers in the "tripartite relationship" will undoubtedly have to be corrected so that growers can escape the low notoriety trap.

Further investigation is needed to answer our remaining questions.

First, regarding our previous analysis, I wonder whether grocery chains dominate the market and exert power over onion growers. In other words, is there unequal market power and asymmetrical price distribution? Who is making the price? To answer these questions, I have carried out a price transmission analysis.

Second, to better understand the drivers behind value chains based on competitive advantage, notoriety, and reputation, I provide an overview of the Vidalia onion differentiation strategy.

4.6. Summary of Section 4

- ✓ Current onion prices at the farm gate have increased from US\$11/cwt in 2000 to US\$15/cwt in 2020.
- ✓ Since 1980, the constant price has declined from about US\$25/cwt to US\$15/cwt in 2020. This means the "purchasing power" of a cwt of onion has fallen sharply over the same period.

- ✓ Prices at the farm gate are volatile. Weather conditions and storage capacities drive market prices.
- ✓ Growers are geographically dispersed and face difficulties in coordinating their sales on the market with other growers to avoid overproduction and shortages.
- ✓ Two lessons come from this analysis:
 - The onion remains a basic, standard product that growers cannot differentiate to obtain a greater willingness to pay from buyers.
 - There may also be a supply control problem that leads to shortages and overproduction because producers are no longer the price makers.
- ✓ A few states (Texas, Wisconsin, and New York) cannot reduce their operating costs under US\$8.5/cwt. They compete with states and countries with lower production costs, like Idaho, Oregon, Mexico, and Peru.
- ✓ New York onion prices cannot deviate from competitors' prices at the risk of losing markets. Onions of New York origin are not different for handlers because New York growers have not considered until now that their onions may be differentiated and sold in other, more profitable markets to compensate for the low yield. To do so, they would have to distinguish their onion and create a new market for it.
- ✓ Prices at the shipping point follow the same trend but are less volatile than the farm gate price.
- ✓ Prices at the terminal market are quite similar to Shipping prices in terms of trend and volatility. Terminal market prices are always higher than shipping point prices. The average difference over the last 10 years (2011-2020) is about US\$5/cwt.
- ✓ New York and Canada prices are very close, and from 2008 to 2018, New York prices were generally better than Canadian prices.
- ✓ New York onion growers compete more with other U.S. growers than Canadian growers.
- ✓ Retail prices are volatile. This means that retailers do not supply onion at the same price all year round. Retailers do not absorb price volatility. Instead, they indirectly transmit the price offered by packers and growers to the final consumer.

- ✓ The retail price of yellow globe type onion has decreased since 2011 from about US\$1.06/pound to US\$0.90/pound, or a 16% decline.
- ✓ Like yellow (pungent) onion, the retail price of yellow sweet onion has decreased from about US\$1.34/pound to US\$1.22/pound, a 10% decline over the last 10 years (2011 to 2020).
- ✓ The volatility of yellow onion prices signals the difficulty at the supply chain's front end to control volume, placing growers and handlers in an unavoidable and undesired situation.

5. Price transmission analysis (From farm gate to retail)

5.1. Introduction

In February 2020⁷⁹, Lisa Held from *Civil Eats* reported onion growers' dismay: "At a moment when he was being offered at most 17 cents a pound for his onions, for example, Pawelski visited his local grocery to find that bags of local onions were selling for 83 cents a pound, leaving the grower with as little as 20 percent of the customer's food dollar". Mid-sized farms in New York seem to have difficulty competing with large farms and the global supply chain. Are they in the wrong market? It seems pointless to try to change the rules of competition. Retail has become more and more consolidated, with large grocery chains dominating the market and wielding more power over produce sellers. Essentially, this means buyers are increasingly setting the prices.

I wonder whether grocery chains dominate the market and exert more power over onion growers. In other words, is there a change in the value distribution from growers to retailers? Is there market power with an asymmetrical price distribution? Who is making the price? How does the Northeast yellow onion market operate?

To answer these questions, I have carried out two analyses:

- The first evaluates changes in the price distribution from growers to retailers;
- The second one evaluates asymmetric price transmission. Asymmetric price transmission may reflect a situation of imperfect competition where some agents have the ability to influence directly or indirectly market prices. One objective is to test how growers' and retailers' prices are horizontally integrated. A second objective is to determine the direction of causality that exists between producers' price and retailers' price.

5.2. Data description and Sources

I have used three databases to carry out these analyses, including data provided by the USDA, Agricultural Marketing Service (USDA AMS) from September 1, 2010, to January 31, 2021.

⁷⁹ <https://civileats.com/2020/02/07/new-york-farmers-are-struggling-to-sell-their-onions-u-s-lawmakers-want-a-trade-investigation/> Retrieved October 20, 2020

Database 1 concerns the “Shipping Price Index” (PPI). I consider this variable to be a good proxy of the farm gate price (PPI). This index is the price received by first handlers when they sell onions to second handlers (packers who then sell to retailers). Some are handlers, but some can be growers who play the role of first handlers.

- We used yellow globe type onion in 50 lbs. packages that are med 2 1/4" min and not organic.
- We used 305 observations (generally weekly price).
- These prices come from the New York City Shipping Market.
- The data spanned eleven years, from September 1, 2010, to January 31, 2021. One production year is generally considered September N to March N+1 (September 1, 2015, to March 31, 2016, for example)
- The data were downloaded from the USDA, AMS website:
<https://www.marketnews.usda.gov/mnp/fv-report-config-step3?locChoose=comState&commodityClass=allcommodity&startIndex=1&rowDisplayMax=25&type=shipPrice&commAbr=ONS&repTypeChanger=shipPriceDaily&repType=shipPriceDaily&locAbrfrom=1&locAbr=NY&locAbr=1&locAbrPass=NEW+YORK%7C%7CNY&locAbrlength=1&step3date=true&step3=Go>

Database 2 concerns the “Terminal Market Price” (TPI). TPI measures the prices received by second handlers when they sell to retailers.

- Terminal Market is the location where the product is sold: New City (for example).
- We used only worked on yellow globe type onion in 50 lbs. packages that are med 2 1/4" min and not organic.
- We had 305 observations (generally weekly price).
- The data spanned eleven years, from September 1, 2010, to January 31, 2021. One production year is generally considered September N to March N+1 and corresponds to Shipping prices.
- These prices come from the New York City Shipping Market. Onions with the characteristics I selected (size, type, package) come from Canada (Québec) and New York.
- The data were downloaded from the USDA, AMS website:
<https://www.marketnews.usda.gov/mnp/fv-report?commAbr=ONS&rowDisplayMax=25&locAbr=AJ&repType=termPriceDaily&locNa>

[me=ATLANTA&type=termPrice&repTypeChanger=termPriceDaily&startIndex=1&locChoose=location&commodityClass=allcommodity&locAbrlength=1&locAbrPass=ONIONS+DRY%7C%7CONS&refine=false&step3date=true&repDate=09%2F01%2F2019&endDate=08%2F31%2F2020&organic=NO&environment=&environment=1&Run=Run](https://www.marketnews.usda.gov/mnp/fv-report-retail?repType=wiz&run=Run&portal=fv&locChoose=location&commodityClass=allcommodity&startIndex=1&type=retail&class=ONIONS+AND+POTATOES&commodity=ONION+S+DRY®ion=NORTHEAST+U.S.&organic=N&repDate=09%2F01%2F2019&endDate=08%2F31%2F2020&organic=NO&environment=&environment=1&Run=Run)

Database 3 concerns the “Retail Price” (RPI). RPI measures the prices received by retailers for when they sell their onions to consumers.

- We have used the Northeast U.S., the area where retailers are located.
- We have only worked on yellow onion, not sweet and not organic, and the unit is per pound.
- We computed 305 observations (generally weekly price).
- The data spanned eleven years, from September 1, 2010, to January 31, 2021. One production year is generally considered September N to March N+1 and corresponds to Shipping prices.
- Three hundred five prices (per pound) from 46,943 stores (a minimum of 2 stores and a maximum of 255) were collected.
- Information represents weekly advertised fruit and vegetable retail sale prices to consumers at major supermarket outlets.
- The data were downloaded from the USDA, AMS website:
<https://www.marketnews.usda.gov/mnp/fv-report-retail?repType=wiz&run=Run&portal=fv&locChoose=location&commodityClass=allcommodity&startIndex=1&type=retail&class=ONIONS+AND+POTATOES&commodity=ONION+S+DRY®ion=NORTHEAST+U.S.&organic=N&repDate=09%2F25%2F2020&endDate=01%2F31%2F2021&compareLy=No>

5.3. Evolution of the price distribution at three stages

We saw in the previous section that the yellow onion market situation has not changed in the last ten years (2011 to 2020). This onion is generally considered a very ordinary vegetable by consumers and even some members of the supply chain. Regardless of its reputation, what has been the distribution of its value over the last ten years?

In my analysis of the above data I present three key findings (Figure 58):

- (1) The current price of yellow (pungent) onion has lost US\$0.10 over 10 years, from \$1.06 to \$0.90/pound;
- (2) To reduce the price to the consumer, retailers have reduced their share of the onion value. At the beginning of the period (2010/2011), retailers got about 72% of the total value of onion sales and first handlers and/or growers-handlers) about 21% and packers about 7%. By the end (2019/2020), this portion was close to 63% for retailers. Retailers have lost 9% on average. 4% were recovered from second handlers and the remaining 5 % were recovered by first handlers and/or growers-handlers. At the end of the period, 26% of the retail value went to growers-first handlers, 11% to second handlers (packers);
- (3) When a consumer pays 90 cents for one pound, 23 cents go to growers-first handlers, 7 cents to second handlers (packers), and 60 cents to retailers.

These results contradict the notion that retailers have increased their profitability. Retailers are always trying to attract new customers, and to achieve this goal, they use a price reduction strategy. However, not all products have the same ability for price reduction, so there is a risk of damaging the product's reputation and the consumers' willingness to pay, reducing the retailer's profitability. Standard products can sometimes undergo a price reduction. However, New York onion growers cannot change their position in the sweet onion hierarchy.

We can therefore assume that the New York onion is generally considered a low-priced onion in the marketplace. However, how could it be otherwise, because this onion does not seem to be different from the others varieties in the consumers' eyes. Retailers use New York onion to attract customers by promoting a low price and have agreed to reduce their margin because it is unlikely that handlers would reduce their price. New York onion is in a low-price trap.

However, retailers consider onions a staple and a "loss-leader" product, sold cheaply to attract customers.

Figure 58. Distribution of the value (in percent) between three stages of the supply chain Yellow onion (pungent) New York State and Northeast region - 2010 to 2020 - USDA

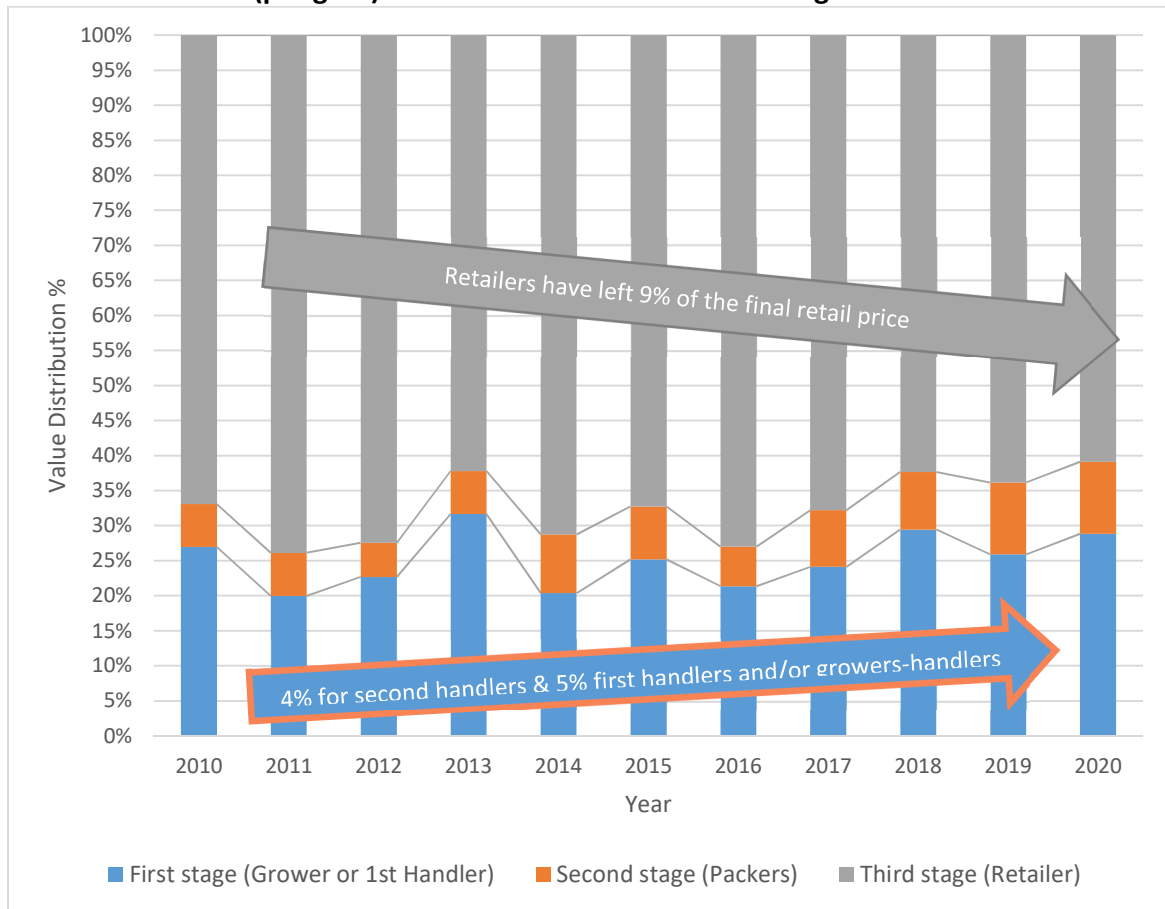

Who makes the price: first handlers-growers, second handlers, or retailers? Who has the power to control the market and change the value distribution?

These questions can be answered through an asymmetric price transmission analysis.

5.4. What is asymmetric price transmission?

According to Jaffry and Grigoryev (2011, p.14)⁸⁰: “Prices within a supply chain are said to have “symmetry” when they move together (Figure. 59). It is normally assumed that markets operate

⁸⁰ Jaffry, R. and Grigoryev, R. (2011): Asymmetric price transmission within the UK dairy supply chain. [online] University of Portsmouth: Centre for Economic Analysis and Policy. Available at: <http://www.dairyco.org.uk/resources-library/market-information/apt-reports/apt-report-2011> [Accessed October 28, 2013]

in this way, with prices at all levels of the supply chain (Farm gate to retail) rising and falling in line with each other”.

Figure 59. Symmetric Prices – General principles

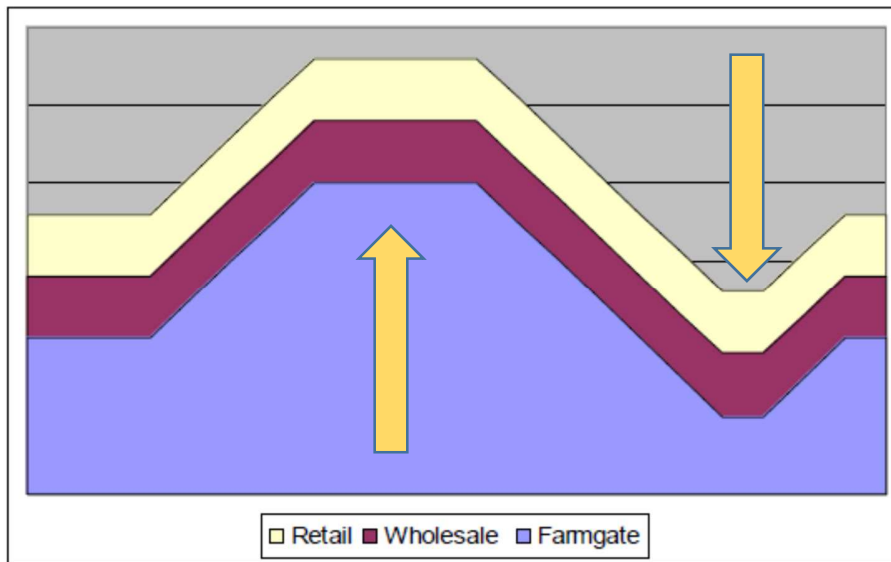

Asymmetric price transmission (Figure. 60) is defined as (Jaffry and Grigoryev, 2011, p.15):
“prices at different levels of the supply chain [that] do not move up and down in line with each other. It is often assumed that this occurs when one party has sufficient power to manipulate price changes to their advantage (i.e. they have market power), however there are also a number of other reasons why prices may move independently of each other, which include:

- Differing cost structures (and thus changes in total costs over time)
- Government intervention
- Diversity of market structure
- Increased value adding
- Differences in transmission of information
- Product perishability
- Search costs within local markets

In the example below (Figure 56), there is an asymmetric price transmission. Indeed, wholesale and retail prices increase concurrently, while the farm gate price rises much later. Jaffry and Grigoryev (2011, p. 15) write that: *“if when prices fell there was a similar delay then there would be no ‘net gain’ for either party, and any delay in price change would simply be considered a ‘lag.’ However as in Figure 56 below downward price movements between wholesale and farm gate level are simultaneous. This delay is not a lag, but asymmetric price transmission which results in a gain at wholesale level and a loss at farm gate level”*.

Figure 60. Asymmetric Prices Transmission – General principles

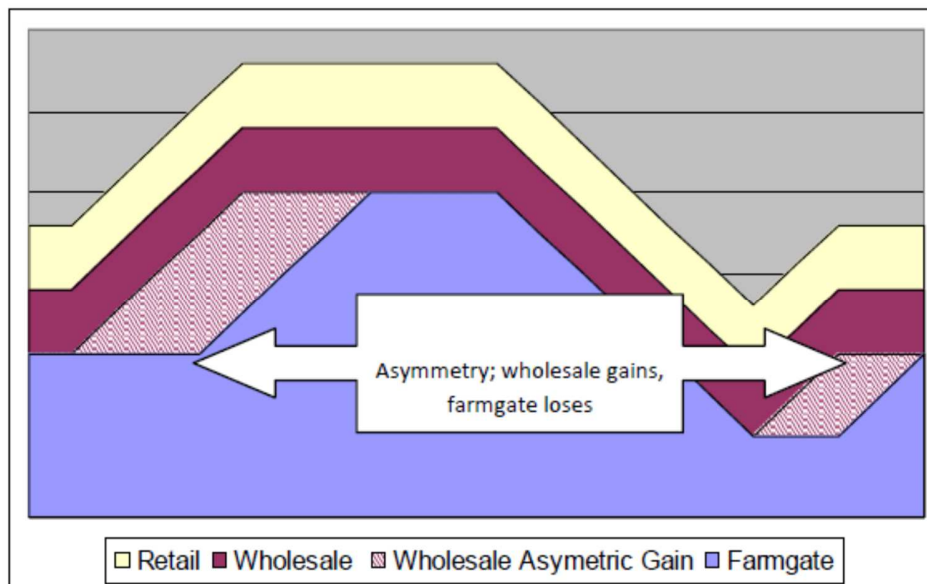

Moreover, *“it is important not to confuse price transmission asymmetry with changes in margins within a supply chain. The methods used to investigate asymmetric movements in prices along a supply chain do not consider either increases or decreases in margins, simply whether price rises and falls (regardless of size) are ‘symmetric’”*. We know different costs of adjustment, depending on whether prices rise or fall, might be another cause of price asymmetries.

5.5. Data description and methodology

I have used three databases to carry out this analysis. The data spans from September 1, 2010, to January 31, 2021. These data series are provided by the USDA, AMS⁸¹:

- Database 1 concerns the “Shipping Price” (PPI).
- Database 2 concerns the “Terminal Market Price” (TPI).
- Database 3 concerns the “Retail Price” (RPI).

I have computed the data with Stata 16 software. The descriptive analysis focuses on comparing price movement trends for growers and retailers. This involves graphically presenting price series and comparing price changes using the F-statistic. For the quantitative analysis, a stationary test, a co-integration test, and the Vector Error Correction Model (VECM) were used to show how prices are integrated at the three stages of supply (first handlers, second handlers, and retailers), and what is the direction of causality between the series.

I have based my approach on similar methods in the literature^{82 83 84 85 86 87} and on *Time Series Analysis (Lecture 3): How to Perform Stationarity Test in Stata?* from Bosede Ngozi Adeleye⁸⁸. Let’s have a look at the description of the three databases.

⁸¹ To get more information, visit USDA, Agricultural Marketing Service: <https://www.marketnews.usda.gov/mnp/fv-help-05>

⁸² Lemma, H. R., & Singh, R. (2015). Testing for price co-integration between producers and retailers: Evidence from Ethiopian milk market. *iBusiness*, 7(1), 1-9, <https://doi.org/10.4236/ib.2015.71001>

⁸³ Breseman, D. (2018). Drivers of Asymmetric Vertical Price Transmission The case of fresh vegetables in California, Wageningen University – Department of Social Sciences, Agricultural Economics and Rural Policy Group, AEP-80433, February 2018, 61 p.

⁸⁴ Engle, R. F., & Granger, C. W. J. (1987). Co-integration and error correction: Representation, estimation, and testing. *Econometrica: Journal of the Econometric Society*, 55(2), 251-276.

⁸⁵ Hassan, D., & Simioni, M. (2001). *Price linkage and transmission between shippers and retailers in the French vegetable channel*. *Economics Working Paper Archive (Toulouse)* 18, French Institute for Agronomy Research (INRA), Economics Laboratory in Toulouse (ESR Toulouse). Retrieved from <https://ideas.repec.org/p/rea/inrawp/18.html>

⁸⁶ Verbeek, M. (2004) *A Guide to Modern Econometrics*. 2nd Edition, Erasmus University Rotterdam, John Wiley & Sons Ltd., Hoboken.

⁸⁷ Vavra, P. and B. Goodwin (2005), “Analysis of Price Transmission Along the Food Chain”, OECD Food, Agriculture and Fisheries Papers, No. 3, OECD Publishing, Paris. <http://dx.doi.org/10.1787/752335872456>

⁸⁸ http://cruncheconometrix.blogspot.com/2018/02/time-series-analysis-lecture-3-how-to_21.html

Terminal market prices (TPI) are less volatile than Shipping prices (PPI), which are less volatile than retail prices (RPI) (Table 24). The dispersion around the mean is stronger and the price range is greater at the retail stage. This volatility can come from weather conditions, periods of shortage and overproduction, and marketable strategy.

Table 24. Descriptive statistics for the three price series: PPI, TPI, and RPI (2010-2019) – 305 price units.

Variable	Obs.	Mean	Std. Dev.	CV	Median	Min	Max
(PPI) Shipping Price \$/pound	305	0.178	0.0437	0.246	0.18	0.08	0.4
(TPI) Terminal Market Price \$/pound	305	0.249	0.0385	0.154	0.250	0.16	0.36
(RPI) Retail Price \$/pound	305	0.938	0.2773	0.296	0.91	0.32	1.96

Prices at the Shipping stage (PPI) are volatile (Figure 61), fluctuating from US\$0.40/pound to US\$0.08/pound between production periods (year).

Figure 61. Shipping Price (PPI) Sept/01/2010 to Jan/31/2021 – 305 units (USDA)

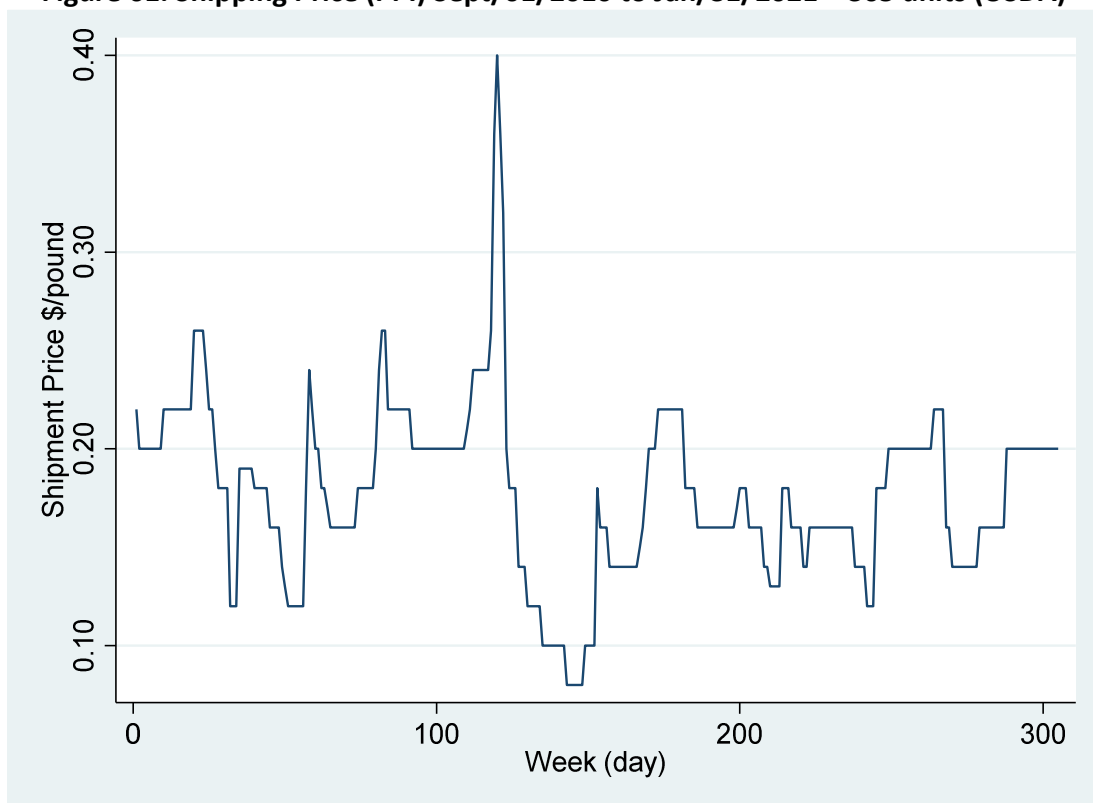

Prices at the terminal market point (TPI) are also volatile (Figure 62), very quickly fluctuating from US\$0.37/pound to US\$0.16/pound.

Figure 62. Terminal market Price (PPI) Sept/01/2010 to Jan/31/2021 – 305 units (USDA)

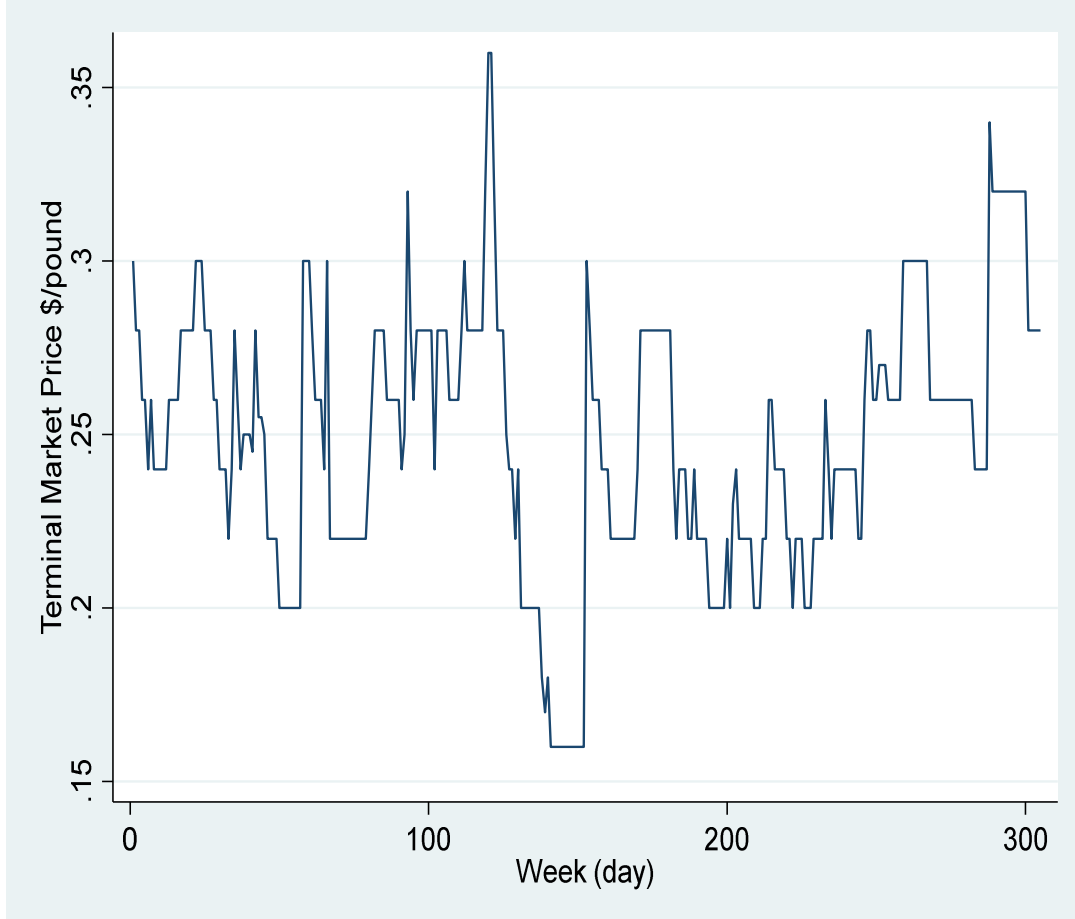

The volatility of retail prices (RPI) is more intense than PPI and TPI (Figure 63). Prices fluctuate from US\$0.40/pound to US\$1.90/pound in a very short time, although there has been less fluctuation over the last four years.

Figure 63. Retail level (RPI) - Sept/01/2010 to Jan/31/2021 – 305 units (USDA)

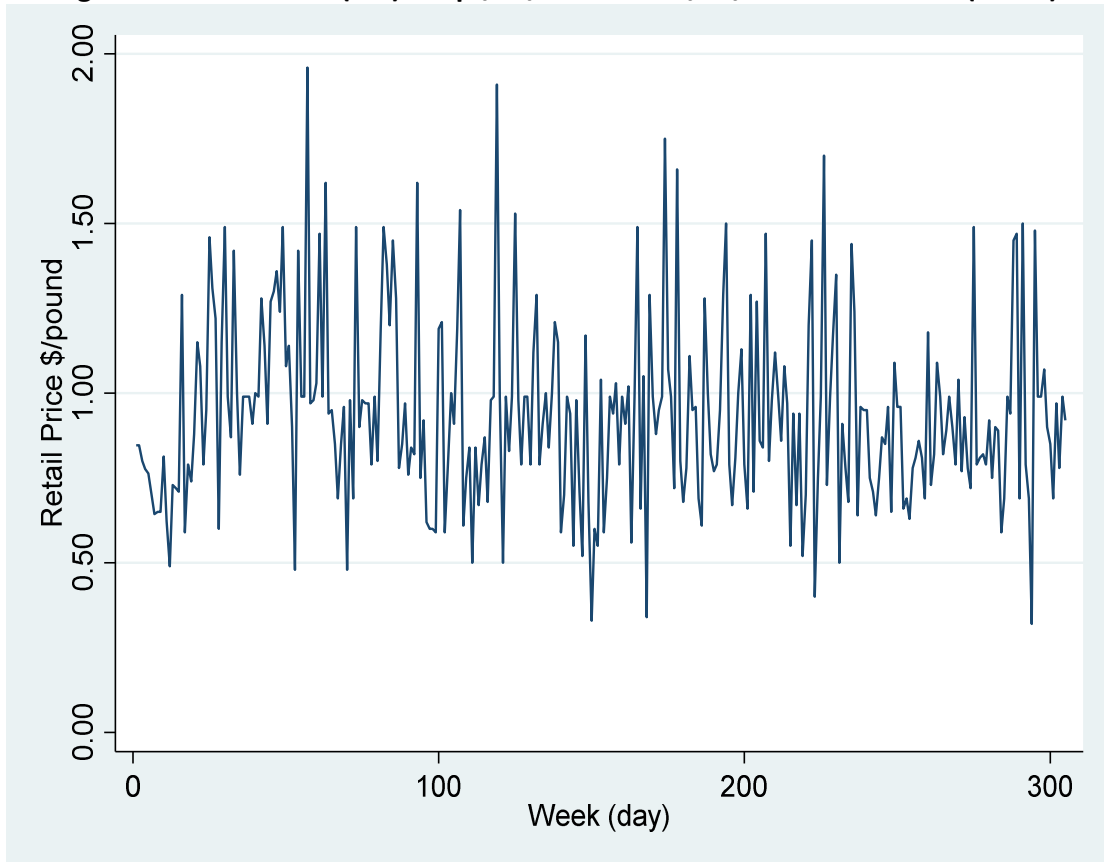

Based on Figures 63, price series appear stationary. Indeed, mean and variance do not appear to drift upwards or downwards over time, nor does it appear that they can be predicted by the season or other periodic intervals.

5.6. Time series econometrics analysis

This sub-section involves three stages of analysis: stationarity, co-integration, and causality tests.

I performed these tests during two parallel stages of analysis:

- First, for the relationship between PPI and TPI time series
- Second, for the relationship between TPI and RPI time series

5.6.1. Model for measuring price transmission

The analysis consists in determining whether the price series are cointegrated. Cointegration analysis defines whether long-run equilibrium exists between PPI, TPI and RPI.

The long run relationship is given as:

$$P_t^{ppi} = \alpha_0 + \alpha_1 P_t^{tpi} + \mu_t \quad (1)$$

Where P_t^{ppi} is the price in PPI market and P_t^{tpi} the PPI price in TPI.

If μ_t is stationary, then market prices are cointegrated.

In our analysis, we have used the Johansen test of cointegration.

If P_t^{ppi} and P_t^{tpi} are co-integrated, we can estimate the following error correction model:

$$\Delta P_t^{ppi} = \beta_0 + \beta_1 \mu_{t-1} + \sum_{i=1}^p \gamma_i \Delta P_{t-i}^{tpi} + \sum_{i=1}^p \gamma_i \Delta P_{t-i}^{ppi} + \varepsilon_t \quad (2)$$

μ_{t-1} is the lagged value of the residual derived from equation (1) and ε_t is a “white noise”.

The error correction coefficient β_1 reflects the speed of price adjustment.

5.6.2. Step 1: Stationarity Test

The first step determines if the three price series are stationary. A series is stationary when:

- there is no trend;
- there is no seasonality;
- the mean and variance do not vary over time

The stationarity test identifies the presence of non-stationarity if the variables have unit roots or not (i.e., if they are stationary or not) and their individual order of integration.

Why are non-stationary variables a problem? If prices are non-stationary, regression analysis will produce misleading results. With non-stationary variables, regression analysis may identify a statistically significant relationship even when there is no relationship. According to Adeleye (2018),⁸⁹ “Stationarity of a series (that is, a variable) implies that its mean, variance and

⁸⁹ http://cruncheconometrix.blogspot.com/2018/02/time-series-analysis-lecture-3-how-to_21.html & <https://www.youtube.com/watch?v=UgbMUS9eWPw>
<https://www.youtube.com/watch?v=u2psrzrcGU8>

covariance are constant over time. That is, these do not vary systematically over time. In other words, they are time invariant... Regressing two series that are nonstationary, likewise, yields a spurious (or nonsense) regression. That is, a regression whose outcome cannot be used for inferences or forecasting. In short, such results should not be taken seriously and must be discarded.”

5.6.2.1. Tests analyzing the relation between PPI and TPI time series

Terminal market prices (TPI) fluctuate with less amplitude than Shipping prices (PPI), even if PPI and TPI have the same profile (Figure 64).

Figure 64. Shipping price (PPI) and terminal market Price (TPI) - Sept/01/2010 to Jan/31/2021 – 305 units (USDA)

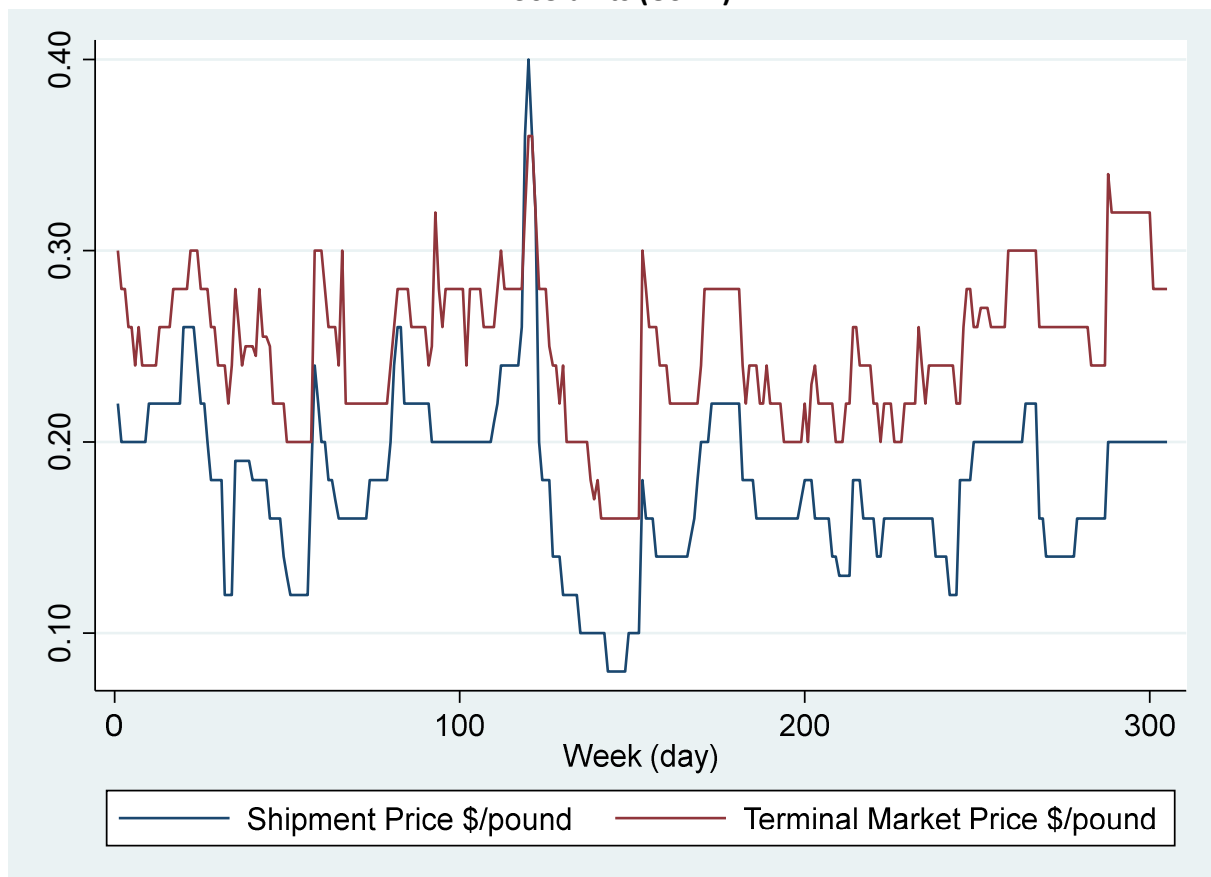

The price series appear to be moving together, which signals a possible association between Shipping price and terminal market price (Figure 64). Percentage change trends reveal the same association between price series (Figure 65).

Figure 65. Trends of percentage change in Shipping Price (PPI) and Terminal market Price Sept/01/2010 to Jan/31/2021 – 305 units (USDA)

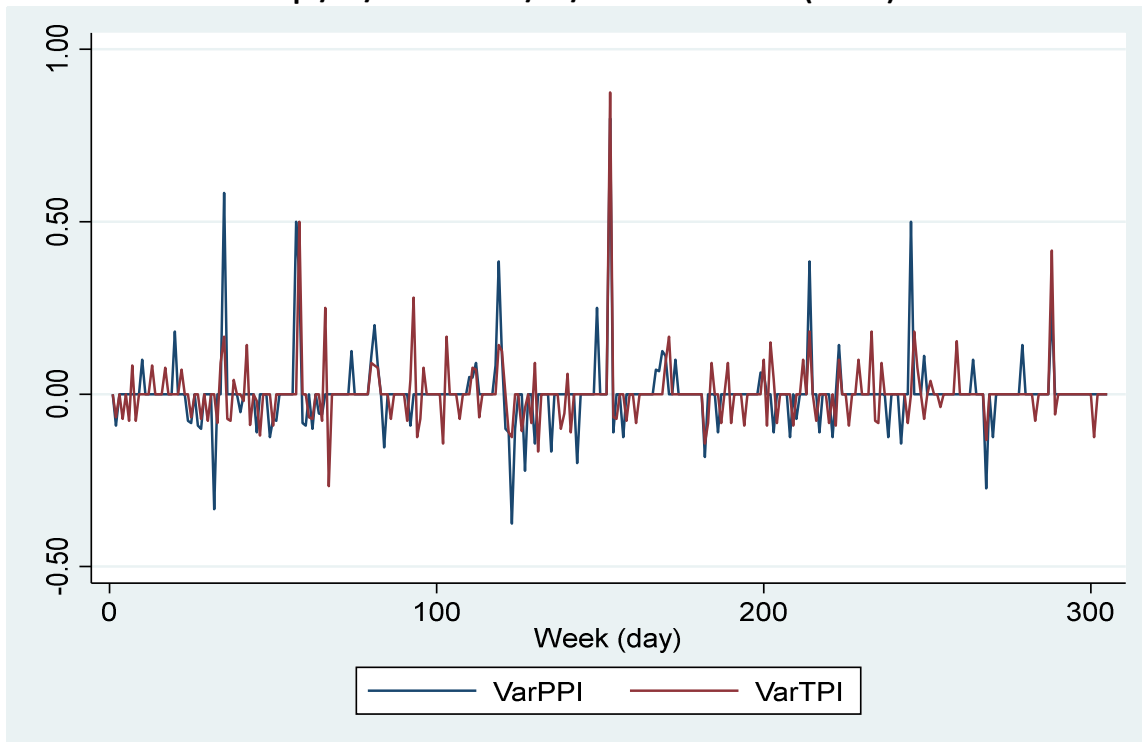

To evaluate price series association more accurately, I use F-statistics to compare the change in the two price series (Table 25). The standard deviations of Shipping price (growers-1st handlers) (PPI) and terminal market price (TPI) are 0.0437 and 0.0385, respectively. The standard errors of the two-price series are 0.0025 and 0.0022, respectively. The value of the F-statistic is 1.2877, which is less than 1.35 (the threshold above which we can reject the null hypothesis at the 5% significance level) and 1.50 (the threshold above which we can reject the null hypothesis at the 1% significance level)⁹⁰.

⁹⁰ A non-significant p-value should not be interpreted as meaning that the variances are equal, only that there is insufficient evidence to reject the null hypothesis that the variances are equal. It's useful to look at the confidence interval for the variance ratio as well as the p-value.

Therefore, we fail to reject the null hypothesis that the magnitudes of change in the two price series are identical, even at the 5% significance level. The magnitudes of the change are quite similar and confirm that the two prices move together. There is no lag in prices here.

Table 25. Variance ratio test of PPI and TPI series

Variance ratio test

Variable	Obs	Mean	Std. Err.	Std. Dev.	[95% Conf. Interval]	
PPI	305	.1775738	.0025037	.0437248	.172647	.1825005
TPI	305	.2491311	.0022063	.0385316	.2447896	.2534727
combined	610	.2133525	.0022094	.0545683	.2090135	.2176914

ratio = sd(PPI) / sd(TPI) f = 1.2877
 Ho: ratio = 1 degrees of freedom = 304, 304

Ha: ratio < 1 Ha: ratio != 1 Ha: ratio > 1
 Pr(F < f) = 0.9861 2*Pr(F > f) = 0.0278 Pr(F > f) = 0.0139

5.6.2.2. Test of stationarity

I have carried out a regression analysis on both PPI and TPI series. If R^2 is above 0.9, it may suggest that the variables are nonstationary. In our case, R^2 is 0.6049 (Table 26). Nevertheless, the rule-of-thumb to validate if variables are nonstationary or not is to compare the R^2 obtained from the regression analysis to the Durbin Watson (DW) statistic. If R^2 is higher than DW, a spurious regression has occurred because the variables are nonstationary. A low DW statistic is evidence of positive, first order auto-correlation of the error terms. As indicated in Table 26, R^2 is 0.6049, while the Durbin-Watson d-statistic is 0.5017498.

Table 26. Stationary test of PPI and TPI series

Source	SS	df	MS	Number of obs	=	305
Model	.273033526	1	.273033526	F(1, 303)	=	463.96
Residual	.178311228	303	.000588486	Prob > F	=	0.0000
Total	.451344754	304	.001484687	R-squared	=	0.6049
				Adj R-squared	=	0.6036
				Root MSE	=	.02426

TPI	Coef.	Std. Err.	t	P> t	[95% Conf. Interval]
PPI	.685399	.0318202	21.54	0.000	.6227824 .7480157
_cons	.1274223	.0058187	21.90	0.000	.1159721 .1388724

Durbin-Watson d-statistic (2, 305) = 0.5017498

According to Granger and Newbold (1974)⁹¹, when $R^2 > DW$, the estimated regression is likely spurious. Resultantly, I assume Shipping price and terminal market price are not stationary and cannot be used for forecasting. So, how do we correct for non-stationarity?

I used the Augmented Dickey Fuller test, a unit root test, to evaluate if Shipping and terminal market prices are stationary.

5.6.2.3. *The Augmented Dickey-Fuller (ADF) Test for Shipping price (PPI)*

The *tau (t)* statistic is -4.355 (Table 27). The null hypothesis of a unit root can be rejected against the one-sided alternative hypothesis if the computed absolute value of the *tau statistic* exceeds the DF or MacKinnon critical tau values. I conclude that the PPI series is stationary in first difference⁹². I first tested in level values and found non-stationarity and then when I differenced the series were stationary. It was the case for all three price series.

⁹¹ Granger C.W.J., Newbold P. (1974), Spurious regressions in econometrics, Journal of Econometrics, 2 (2), 111-120, [https://doi.org/10.1016/0304-4076\(74\)90034-7](https://doi.org/10.1016/0304-4076(74)90034-7).

⁹² The first difference of a time series is the series of changes from one period to the next. If Y_t denotes the value of the time series Y at period t, then the first difference of Y at period t is equal to $Y_t - Y_{t-1}$.

Table 27. Augmented Dickey-Fuller (ADF) Test for Shipping price (PPI)

Augmented Dickey-Fuller test for unit root Number of obs = 303

	Test Statistic	Interpolated Dickey-Fuller		
		1% Critical Value	5% Critical Value	10% Critical Value
Z(t)	-4.355	-3.456	-2.878	-2.570

MacKinnon approximate p-value for Z(t) = 0.0004

D.PPI	Coef.	Std. Err.	t	P> t	[95% Conf. Interval]	
PPI						
L1.	-.0941632	.0216229	-4.35	0.000	-.1367149	-.0516115
LD.	.2557643	.0556491	4.60	0.000	.1462523	.3652763
_cons	.0167176	.0039463	4.24	0.000	.0089517	.0244836

5.6.2.4. *The Augmented Dickey-Fuller (ADF) Test for terminal market price (TPI)*

The *tau* statistic is -4.106 (Table 28). Hence, the null hypothesis of a unit root is rejected. TPI series is stationary at first difference.

Table 28. Augmented Dickey-Fuller (ADF) Test for Terminal Market price (TPI)

Augmented Dickey-Fuller test for unit root Number of obs = 303

	Test Statistic	Interpolated Dickey-Fuller		
		1% Critical Value	5% Critical Value	10% Critical Value
Z(t)	-4.106	-3.456	-2.878	-2.570

MacKinnon approximate p-value for Z(t) = 0.0009

D.TPI	Coef.	Std. Err.	t	P> t	[95% Conf. Interval]	
TPI						
L1.	-.1184379	.0288428	-4.11	0.000	-.1751977	-.0616781
LD.	-.0561095	.0574925	-0.98	0.330	-.1692492	.0570301
_cons	.0294709	.0072587	4.06	0.000	.0151864	.0437554

When we look at the relationship between terminal market and retail price, there is no evidence to support that the price series are moving together, which signals that there may be an association between second handler's price and retailers' price between 2011 and 2020 (Figure 66).

Figure 66. Terminal market price (TPI) and retail price (RPI) - Sept/01/2010 to Jan/31/2021 – 305 units (USDA).

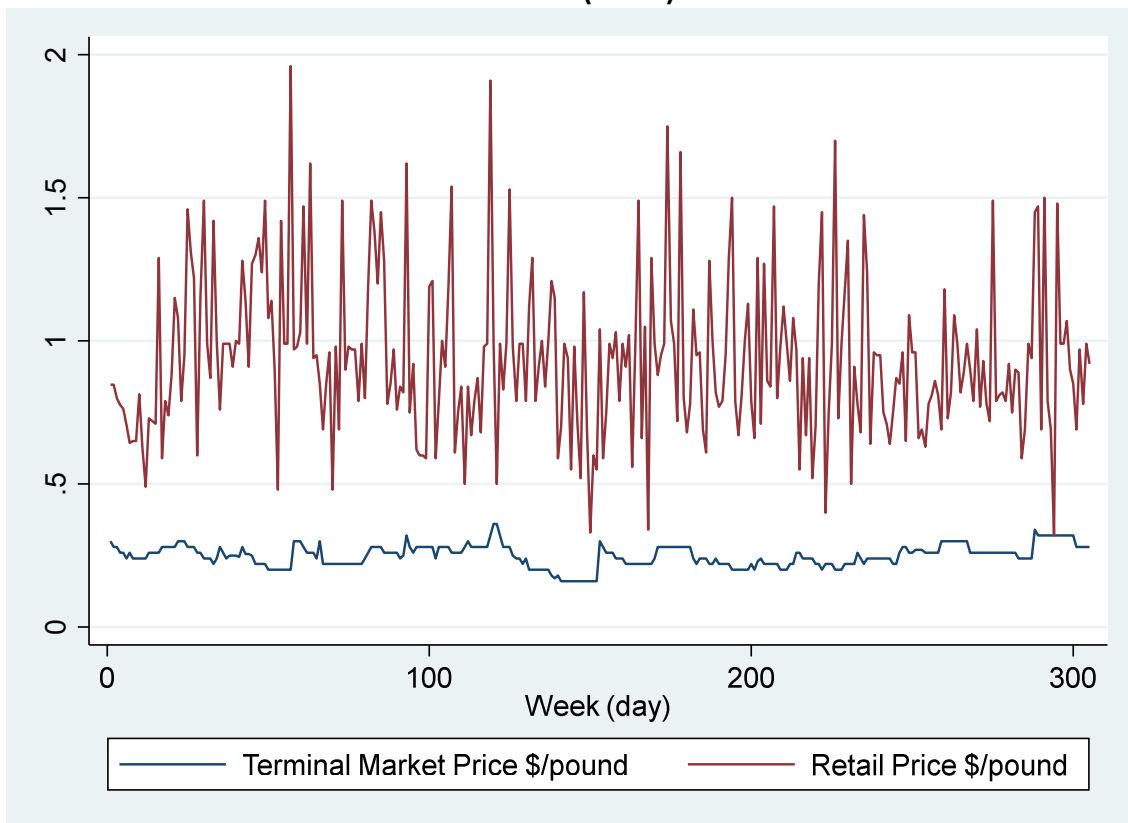

Then, I calculated percentage change trends of TPI and RPI to see if there is an association between growers' price and retailers' price: the price series do not seem associated (Fig. 67).

**Figure 67. Trends of percentage change in Terminal market Price and Retail Price
Sept/01/2010 to Jan/31/2021 – 305 units (USDA)**

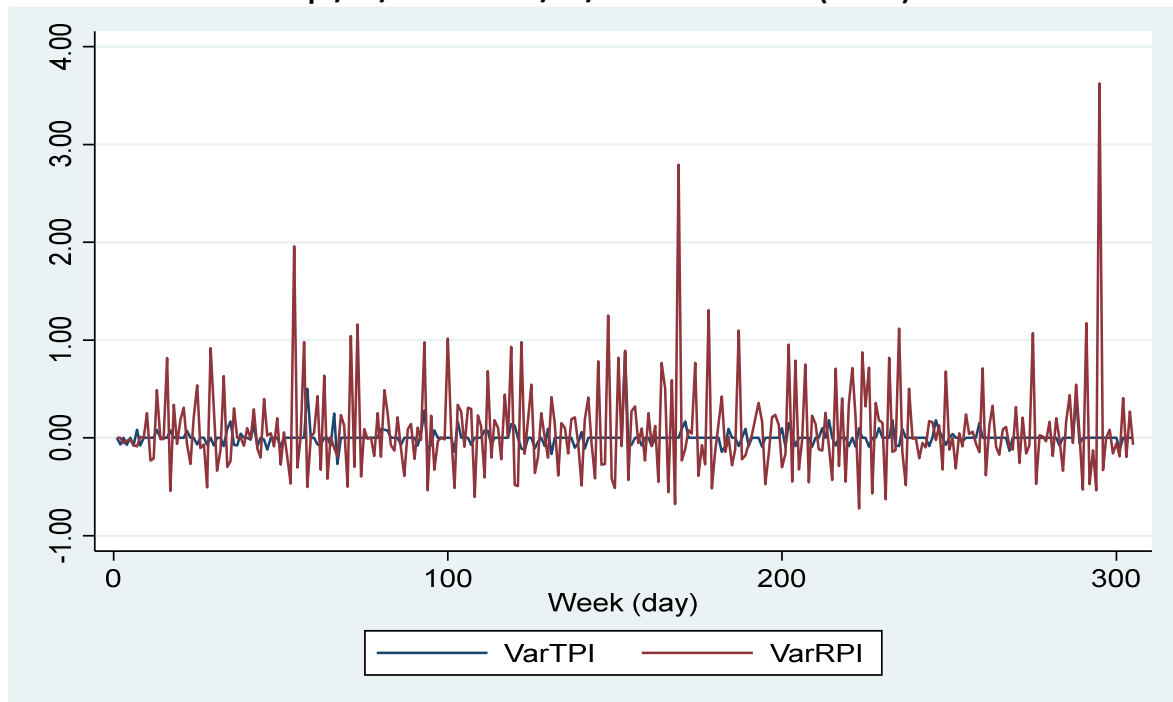

According to Granger and Newbold (1974), when $R^2 > DW$, the estimated regression is likely spurious. In our case, R^2 is less than the Durbin Watson (DW) statistic (Table 29): terminal market prices and retail prices are stationary.

Table 29. Stationary test of PPI and TPI series

Source	SS	df	MS	Number of obs	=	305
Model	.001419712	1	.001419712	F(1, 303)	=	0.96
Residual	.449925042	303	.001484901	Prob > F	=	0.3290
Total	.451344754	304	.001484687	R-squared	=	0.0031
				Adj R-squared	=	-0.0001
				Root MSE	=	.03853
TPI	Coef.	Std. Err.	t	P> t	[95% Conf. Interval]	
RPI	.0077923	.0079692	0.98	0.329	-.0078897	.0234742
_cons	.2418222	.0077937	31.03	0.000	.2264856	.2571588

Durbin-Watson d-statistic (2, 305) = 0.2570782

The Augmented Dickey-Fuller (ADF) Test confirms that retail price is stationary (RPI). That is what the earlier graph implied. The *tau* statistic is -11.390 (Table 30). Hence, the null hypothesis of a unit root is rejected. RPI series is stationary at first difference.

Table 30. Augmented Dickey-Fuller (ADF) Test for Retail price (RPI)

Augmented Dickey-Fuller test for unit root		Number of obs = 303		
Test Statistic	Interpolated Dickey-Fuller			MacKinnon approximate p-value for Z(t) = 0.0000
	1% Critical Value	5% Critical Value	10% Critical Value	
Z(t)	-11.390	-3.456	-2.878	-2.570

D.RPI	Coef.	Std. Err.	t	P> t	[95% Conf. Interval]
RPI					
L1.	-.8862266	.0778093	-11.39	0.000	-1.039348 - .7331055
LD.	-.0255888	.0577011	-0.44	0.658	-.139139 .0879613
_cons	.8318252	.074717	11.13	0.000	.6847894 .9788609

While the time series are probably stationary, there is a possibility of a long-run relationship between the three-price series, as they are expected to have a common stochastic trend over time. So, to support this expected trend, I have performed co-integration tests.

5.6.3. Step 2: Test of co-integration between the three price series

To test for co-integration, I had to define how many lags to include. Nielsen (2001)⁹³ has shown that the methods used in lag-order selection statistics for VARs and VECMs can determine the lag order for a VAR model with (1) variables⁹⁴. Accordingly, the lag-order selection statistics (LR, FPE,

⁹³ Nielsen, B. 2001. Order determination in general vector autoregressions. Working paper, Department of Economics, University of Oxford and Nuffield College. <https://ideas.repec.org/p/nuf/econwp/0110.htm> (This link doesn't work)

⁹⁴ Lemma, H. R., & Singh, R. (2015). Testing for price co-integration between producers and retailers: Evidence from Ethiopian milk market. *iBusiness*, 7(1), 1-9, <https://doi.org/10.4236/ib.2015.71001>

AIC, HQIC, and SBIC) were computed. AIC statistics (-10.5582) show that four lags should be used to estimate the co-integration equation (Table 31).

Table 31. Augmented Dickey-Fuller (ADF) Test for Retail price (RPI)

Selection-order criteria

Sample: 5 - 305

Number of obs = 301

lag	LL	LR	df	p	FPE	AIC	HQIC	SBIC
0	1165.45				8.9e-08	-7.72394	-7.70916	-7.68699
1	1589.69	848.46	9	0.000	5.6e-09	-10.483	-10.4238	-10.3352*
2	1608.14	36.903	9	0.000	5.3e-09	-10.5458	-10.4423*	-10.2871
3	1616.47	16.668	9	0.054	5.3e-09	-10.5413	-10.3935	-10.1719
4	1628.01	23.074*	9	0.006	5.2e-09*	-10.5582*	-10.366	-10.0779

Endogenous: PPI TPI RPI

Exogenous: _cons

Once the number of lags was determined, I implemented Johansen and Juselius' framework⁹⁵ to assess the number of co-integration equations and the rank of the co-integration matrix.

First, I carried out this test for Shipping prices and terminal market prices. As indicated in Table 32, we can reject the null hypothesis that there is no integration between Shipping prices and retail prices because both the trace and the max statistics are greater than their respective 5% critical values when $r = 0$. That is, $31.2332 > 15.41$ and $17.4713 > 14.07$. There is strong evidence to reject the null hypothesis that the number of co-integrating equations is not more than one since both the statistical values are greater than their respective 5% critical values when $r \leq 1$ (i.e., $13.7619 > 3.76$). The co-integration test shows that there are two long-run associations between prices.

The two variables are co-integrated, meaning a strong, long-run association between Shipping prices and retail prices. In other words, these two variables move together in the long-run.

⁹⁵ Johansen, S., & Juselius, K. (1990) Maximum likelihood estimation and inference on co-integration—with applications to the demand for money. *Oxford Bulletin of Economics and Statistics*, 52, 169-210. <http://dx.doi.org/10.1111/j.1468-0084.1990.mp52002003.x>

Table 32. Johansen's tests for co-integration of the price series (Shipping price & Terminal Market price).

Johansen tests for cointegration					
Trend: constant			Number of obs = 301		
Sample: 5 - 305			Lags = 4		
maximum				trace	5%
rank	parms	LL	eigenvalue	statistic	critical value
0	14	1631.2532	.	31.2332	15.41
1	17	1639.9888	0.05639	13.7619	3.76
2	18	1646.8698	0.04469		
maximum				max	5%
rank	parms	LL	eigenvalue	statistic	critical value
0	14	1631.2532	.	17.4713	14.07
1	17	1639.9888	0.05639	13.7619	3.76
2	18	1646.8698	0.04469		

Second, I carried out this test for terminal market prices and retail prices. As indicated in Table 33, we can reject the null hypothesis that there is no integration between Shipping prices and retail prices because both the trace and the max statistics are greater than their respective 5% critical values when $r = 0$. That is, $62.0614 > 15.41$ and $48.8498 > 14.07$. There is strong evidence to reject the null hypothesis that the number of co-integrating equations is not more than one since both the statistical values are greater than their respective 5% critical values when $r \leq 1$ (i.e., $13.2115 > 3.76$). The co-integration test shows that there are two long-run associations between prices.

The two variables are co-integrated, meaning a strong, long-run association between terminal market prices and retail prices. In other words, these two variables move together in the long-run.

Table 33. Johansen's tests for co-integration of the price series (Terminal Market price & Retail price).

Johansen tests for cointegration					
Trend: constant			Number of obs = 301		
Sample: 5 - 305			Lags = 4		
<hr/>					
maximum				trace	5% critical
rank	parms	LL	eigenvalue	statistic	value
0	14	712.0156	.	62.0614	15.41
1	17	736.44052	0.14981	13.2115	3.76
2	18	743.04628	0.04294		
<hr/>					
maximum				max	5% critical
rank	parms	LL	eigenvalue	statistic	value
0	14	712.0156	.	48.8498	14.07
1	17	736.44052	0.14981	13.2115	3.76
2	18	743.04628	0.04294		
<hr/>					

Therefore, the price series are related and can be combined linearly. Even if there are shocks in the short run, which may affect movement in the individual series, the series will converge in the long-run.

5.6.4. Step 3: Causality analysis between prices series

I assume there is co-integration between the Shipping and terminal market price series and between terminal Market and retail prices. However, what is the causality between price series: which price causes the other? Given that there is no more than one co-integrating equation, I use the Engel Granger-Vector Error Correction Model, to determine the direction of causality between the time series Engle and Granger, 1987). The Granger causality test is a statistical hypothesis test for determining whether one time series is useful for forecasting another. By using the notation of our empirical case study⁹⁶, the Engle and Granger (1987) approach shows that if PPI_t and TPI_t are cointegrated, their relationship can be analyzed using an error correction

⁹⁶ This notation assumes that a Shipping Price in period t (PPI_t).affects the Terminal market price in period t (TPI_t).

model. Granger and Lee (1989) adapted this model to test for asymmetric price transmission in a two-step procedure. They introduce an error correction model that includes asymmetric adjustment terms (also called error correction terms, or ECT) as a method to test for asymmetric price transmission in cointegrated series. This model (adapted to our empirical case study) makes TPI_t responsive to changes in PPI_t (or vice versa). Then through the ECT, the model corrects for any deviations from the long-run equilibrium that remain from previous periods (Breseman, 2018).

A general specification of the Granger causality test in a bivariate (PPI, TPI) context can be expressed as following:

We estimate,

$$TPI_t = \alpha_0 + \beta_1 PPI_t + \mu_t \quad (1)$$

Then, we test for cointegration of PPI_t and TPI_t . If they are cointegrated, then this equation estimates their long-run equilibrium. The residuals of Equation 6a represent the positive and negative deviations from the long-run equilibrium between PPI_t and TPI_t . These residuals μ_t are estimated, and their lags serve as the ECT used in the following equation (2).

If PPI_t and TPI_t are cointegrated, the following error correction model is estimated:

$$\Delta TPI_t = \alpha_0 + \sum_{i=1}^m \alpha_i^+ \Delta P_{t-i}^{TPI+} + \sum_{i=1}^n \alpha_i^- \Delta P_{t-i}^{TPI-} + \sum_{j=1}^p \beta_j^+ \Delta P_{t-j}^{PPI+} + \sum_{j=1}^q \beta_j^- \Delta P_{t-j}^{PPI-} + \gamma^+ \mu_{t-1}^+ + \gamma^- \mu_{t-1}^- + \varepsilon_t \quad (2)$$

5.6.4.1. First analysis: focus on causality between PPI and TPI

To determine the influence of PPI on TPI, TPI is the dependent test model variable. However, the VECM model automatically converts TPI into D_TPI , a first difference variable. TPI , $LD.TPI$, $L2D.TPI$, $L3D.TPI$, $LD.PPI$, $L2D.PPI$, and $L3D.PPI$ are the independent variables. $Ce1$ is the co-integrated

equation and #1 because we have one co-integration equation. Ce1 is the speed of adjustment. The estimation result is presented in Tables 34 and 35.

Our first objective is to test long-run causality. The coefficient L1 for the cointegrated equation one (_ce1) is significant because $P > |z|$ is less than 1%. TPI is positioned as the dependent variable. In the long-run, PPI has a positive effect on TPI in the long-run on average, because the coefficient (-0.9725056) is negative and is statistically significant at the level of 1% (Table 34).

Table 34. Long-run equation in the Vector error correction model (VECM).

		Johansen normalization restriction imposed				
beta		Coef.	Std. Err.	z	P> z	[95% Conf. Interval]
_ce1	TPI	1
	PPI	-.9725056	.1388912	-7.00	0.000	-1.244727 - .7002838
	_cons	-.0767724

Now, I focus on the Error Correction Time (ECT coefficient). In Table 35, the coefficient has a negative sign (-0.1202949). When there is a long-run causality running from Shipping price (PPI) to terminal market price (TPI), ECT is significant.

This coefficient corresponds to the speed of adjustment toward long-run equilibrium. The estimates imply rapid adjustment toward equilibrium. The adjustment term (-0.12) is statically significant at the 1% level, suggesting that previous week's errors (or deviation from long-run equilibrium) are corrected for within the current week at a convergence speed of 12.02%.

**Table 35. Vector error correction model (VECM).
Causality Shipping price to Terminal Market price.**

Vector error-correction model

Sample: 5 - 305	Number of obs	=	301
	AIC	=	-10.78398
Log likelihood = 1639.989	HQIC	=	-10.7002
Det(Sigma_ml) = 6.35e-08	SBIC	=	-10.57461

Equation	Parms	RMSE	R-sq	chi2	P>chi2
D_TPI	8	.017927	0.1585	55.18833	0.0000
D_PPI	8	.016516	0.0813	25.92238	0.0011

	Coef.	Std. Err.	z	P> z	[95% Conf. Interval]	
D_TPI						
_ce1						
L1.	-.1202949	.0440615	-2.73	0.006	-.2066538	-.0339359
TPI						
LD.	-.2676453	.069869	-3.83	0.000	-.404586	-.1307046
L2D.	-.1722584	.0690639	-2.49	0.013	-.3076212	-.0368956
L3D.	-.0570923	.0648961	-0.88	0.379	-.1842863	.0701017
PPI						
LD.	.3297981	.0748137	4.41	0.000	.1831659	.4764302
L2D.	.0744047	.0768562	0.97	0.333	-.0762306	.22504
L3D.	.009211	.0758156	0.12	0.903	-.1393848	.1578069
_cons	8.53e-06	.0010335	0.01	0.993	-.0020171	.0020342
D_PPI						
_ce1						
L1.	.0586899	.0405946	1.45	0.148	-.020874	.1382539
TPI						
LD.	-.0793873	.0643715	-1.23	0.217	-.2055531	.0467785
L2D.	-.0185203	.0636298	-0.29	0.771	-.1432324	.1061917
L3D.	.0170791	.0597899	0.29	0.775	-.1001069	.1342651
PPI						
LD.	.2703518	.0689271	3.92	0.000	.1352571	.4054465
L2D.	.0324569	.0708089	0.46	0.647	-.106326	.1712399
L3D.	-.155661	.0698502	-2.23	0.026	-.2925649	-.0187571
_cons	.0000175	.0009522	0.02	0.985	-.0018488	.0018838

Our second objective is to test short-run causality. I assume that the independent variables are LD.TPI, L2D.TPI, L3D.TPI, LD.PPI, L2D.PPI, and L3D.PPI. The null hypothesis is these variables

cannot explain D_TPI. Using a Chi2 test, in which Chi2 (3) = 20.45 and Prob > chi2 = 0.0001, I can reject the null hypothesis because the probability is less than 5%, meaning short-run causality running from PPI to TPI. In other words, PPI can cause TPI.

Next, I tested if there is autocorrelation. For Lag 1 and Lag 2, the p-value is 0.95938 and 0.68382, respectively (Table 36). We fail to reject the null hypotheses. Because there is no autocorrelation, we can accept the results of this model.

Table 36. LM test for residual autocorrelation (Terminal Market price & Shipping price).

Lagrange-multiplier test

lag	chi2	df	Prob > chi2
1	0.6325	4	0.95938
2	2.2832	4	0.68382

H0: no autocorrelation at lag order

I also tested for normally distributed disturbances using a Jarque-Bera test. Errors are not normally distributed (Table 37).

Table 37. Test for normally distributed disturbances (Terminal Market price & Shipping price)

Jarque-Bera test

Equation	chi2	df	Prob > chi2
D_TPI	4016.423	2	0.00000
D_PPI	1186.589	2	0.00000
ALL	5203.012	4	0.00000

Lastly, I checked the stability condition of VEC estimates. VECM specification imposes a unity modulus, and we can say that the model is stable (Table 38).

Table 38. Test for normally distributed disturbances (Terminal Market price & Shipping price)

Eigenvalue stability condition

Eigenvalue	Modulus
1	1
.8771119	.877112
.3486752 + .4514143i	.570394
.3486752 - .4514143i	.570394
-.4936034	.493603
.02608892 + .4480323i	.448791
.02608892 - .4480323i	.448791
-.3077013	.307701

Therefore, Shipping price (PPI) can cause terminal market price (TPI). To determine if there is a unidirectional or a bi-directional causality, I must evaluate if the terminal market price (TPI) affects Shipping price (PPI).

Now, PPI is the dependent variable. The VECM model automatically converts PPI into D_PPI, a fast difference variable. Therefore, PPI is converted into D_PPI, meaning that fast difference of PPI. In addition, PPI, LD.PPI, L2D.PPI, L3D.PPI, LD.TPI, L2D.TPI, L3D.TPI. In Table 39, the ECT coefficient has a negative sign (-0.0570763) but is not significant. There is no long-run causality running from terminal market price (TPI) to Shipping price (PPI).

Therefore, I conclude that both prices are co-integrated, and there are two long-run associations between prices.

In my estimation of the VECM, there are two types of parameters of interest, including the adjustment and the short-run coefficients. The adjustment parameter on terminal market price (or second handlers) has a coefficient of -0.1202949 and a P-value of 0.006, implying that it is significant at the 1% level (when terminal market price is the dependent variable). The adjustment parameter on Shipping price (first handlers or growers-handlers) has a coefficient of -0.0570763 and a P-value of 0.148, implying that it is not significant even at the 10% level. This reveals that there is only one way of causality, from Shipping price to terminal market price. The causality test shows that the first handlers dominate price determination and set the price for second handlers. Resultantly, Shipping price drives terminal market price.

Indeed, the second handlers' price does not determine Shipping price. When terminal market price is the dependent variable, the coefficient of the adjustment parameter is -0.1202949⁹⁷ indicating that for a 100% change in the first handlers' price, the second handlers' price changes by about 12% in one week. More than eight weeks are necessary for the second handler's price to fully adjust if there are no additional shocks at the Shipping price level. When Shipping price is the independent variable, the adjustment parameter coefficient is -0.0570763, indicating that for a 100% change in terminal market price, the Shipping price varies by about 5.7% (which is low). The second handlers' price does not significantly drive the Shipping price (first handler).

5.6.4.2. *Second Analysis: Focus on causality between Terminal Market Price (TPI) and Retail Price (RPI)*⁹⁸.

We know that there is co-integration between Terminal Market Price (TPI) and Retail Price (RPI) and no more than one co-integrating equation. To determine which prices cause the other, I use

⁹⁷ This parameter indicates the speed of adjustment of second handlers' price when there is change in Shipping price.

⁹⁸ The mode of presentation of the results was inspired by the article from: Lemma, H. R., & Singh, R. (2015). Testing for price co-integration between producers and retailers: Evidence from Ethiopian milk market. *iBusiness*, 7(1), 1-9, <https://doi.org/10.4236/ib.2015.71001>

an Engel Granger-Vector Error Correction Model (see Shipping price and terminal market analysis above) and perform diagnostics (serial correlation, normality, etc.).

My first objective is to test if TPI influences RPI. In this analysis, the target model and the dependent variable is retail price (RPI). However, the VECM model automatically converts RPI into ΔP_{Retail} , the fast difference variable of RPI. Our second objective is to test if RPI influences TPI. In this analysis, our target model and dependent variable is TPI. However, the VECM model automatically converts TPI into $\Delta P_{\text{TerminalMarket}}$, the fast difference variable of TPI. The output (Table 40) indicates that the model fits well, as indicated by the R^2 and Chi-square results.

In my estimation of the VECM, there are two parameters of interest: short-term adjustment and coefficients. The adjustment parameter of Retail Price (or price of retailers) has a coefficient of -0.8139755 and a P-value of 0.000001, implying significance at the 1% level. In contrast, the adjustment parameter of terminal market price has a coefficient of -0.0005519 and a P-value of 0.881, indicating there is significance even at a level of 10% (Table 40). Therefore, there is only one way causality, from Terminal Market price to Retail price. **In other words, the terminal market price determines the retail price. That means second handlers may be price-makers.**

Indeed, the retail price does not drive the second handlers' price. When the retail price is the dependent variable, the adjustment parameter coefficient is -0.8139755, indicating the retail price adjustment when the terminal market price changes. For a 100% change in second handlers' price, retailers' price varies by about 81% in one week. It takes less than two weeks for the retail price to fully adjust if there are no additional shocks to the terminal market price. When terminal market price is the independent variable, the adjustment parameter coefficient is to -0.0005519. For a 100% variation in retail price, terminal market price varies by about 0.0055%, which is very low, indicating that retailers' price does not significantly drive second handlers' price.

Table 40. Vector error correction model (VECM). Causality between Terminal Market price to Retail price

Dependent variables	Independent variables	Coefficient	Standard error	P-value
$\Delta P_{\text{Terminal Market}}$	Adjustment _{TPI}	-0.0005519	0.0036853	0.881
	Constant _{TPI}	-8.32e-06	0.0011023	0.994
ΔP_{Retail}	Adjustment _{RPI}	-0.8139755	0.0935872	0.000
	Constant _{RPI}	9.88e-09	0.0159693	1.000
	N# of Obs. 302	lags (3)		
	R-sq	chi2	P>chi2	
$\Delta P_{\text{Terminal Market}}$	0.0329	10.06091	0.1221	
ΔP_{Retail}	0.4637	255.9075	0.0000	

5.7. Conclusion of Section 5

Our analysis produced two major results.

(1) First, concerning value distribution:

- Over the last 10 years (2011-2020), the current price of yellow (pungent) onion decreased from US\$1.05 to US\$0.90 per pound.
- Retailers exert pressure to contain price at a low level
- However, to reduce price, retailers have reduced their shared value. At the beginning of the period (2010/2011), retailers received about 72% of the total value, and by the end (2019/2020), this portion was close to 63%. They lost 9% on average. A first half (4%) has been seek from second handlers and the second half portion (5%) by first handlers and growers.
- At the end of the period (when consumers pay US\$0.95/lb), 23 cents go to growers-first handlers, 7 cents to second handlers (packers), and 60 cents to retailers.
- These results contradict the notion that retailers have increased their profitability.
- New York onion growers cannot change their position in the hierarchy of the onion market. We must therefore assume that the New York onion is considered a staple and

“loss-leader onion.” Therefore, retailers used this onion to attract customers by promoting a low price and have agreed to reduce their margin because it is unlikely that handlers and growers would reduce their price.

- New York onion is in a low-price trap.

(2) Second, concerning price transmission and onion price makers:

- Our three variables are co-integrated, meaning strong, long-run associations between Shipping prices, terminal market prices, and retail prices. In other words, these prices move together in the long-run.
- Even if there were shocks in the short run, which may affect individual movement, these price series would converge in the long-run.
- Therefore, there is not asymmetric price transmission and market power on both the growers-handlers side and retailers' side.
- Nevertheless, Shipping price (PPI) drives terminal market price (TPI), and the latter causes retail price (RPI).
- First handlers-growers dominate price determination and are price-makers.

The yellow onion market in the northeast part of the U.S. seems to run correctly, without competitive distortions. In the long-run, Shipping prices, terminal market prices and retail prices move together. The main result is that Shipping price drives terminal market price, and the latter causes retail price. The data suggest that first handlers are more able to establish prices than other actors in the value chain. First and second handlers seem to be operating as price makers even if it is “a low price” and as if retailers made pressure on price but were not price makers. Growers and handlers try to compete with other onion supply chains that have better productivity and low production costs. Growers and handlers use a single driver to maintain their onion market shares: low price.

6. Vidalia case

6.1. Framework for analyzing a value food chain

In the current context of globalization, price volatility, generation renewal crisis, farms profitability crisis, climate change, and strained relationships with the large food retailers, the fate of the onion economy is questioned by growers and public policymakers: what collective strategy can enable the maintenance of thriving and sustainable agriculture? What model of development must be promoted? What new onion chain must be implemented?

Local actors have suggested some ideas. Indeed, some vegetable growing areas (especially in Europe but also in the U.S.) have chosen to move onion production under “geographical indications” to offset the downward price trend. A geographical indication is used to demonstrate a link between the origin of the product and a given quality, reputation, or other characteristic that the product derives from that origin, known as “the terroir.” As explained in section 1, a terroir⁹⁹ is a delimited geographical area defined by a community, which, over its history, has built a set of distinctive cultural traits, knowledge, and practices based on a system of interactions between the natural environment and human factors. The know-how involved reveals originality, confers typicality, and allows recognition for the products or services originating from this area and thus for the people who live there. The terroirs are living and innovative areas that cannot be assimilated on tradition alone. Thus, the terroir can build a competitive advantage by enhancing unique localized material and immaterial resources. When the terroir is recognized by a legal, geographical indication, this signal informs consumers of the uniqueness of the products resulting from this link. It also represents the collective goodwill resulting from this uniqueness.

We consider geographical indication within a value chain as a Localized Agri-Food Systems (LAFS). However, there are variable results, particularly in terms of the price paid to growers. Some LAFS

⁹⁹ Prévost, P., M. Capitaine, F. Gautier-Pelissier, Y. Michelin, P. Jeanneaux, F. Fort, A. Javelle, P. Moïti-Maïzi, F. Lérique, G. Brunschwig, S. Fournier, P. Lapeyronie, & É. Josien (2014). "Le terroir, un concept pour l'action dans le développement des territoires." *Vertigo - la revue électronique en sciences de l'environnement* [En ligne], 14(1): mis en ligne le 10 mai 2014, consulté le 2029 mars 2015. <https://doi.org/14810.14000/vertigo.14807>

are classically referred to as success stories ¹⁰⁰: Protected Designation of Origin (PDO)¹⁰¹ Roquefort in France, PDO Gruyère in Switzerland, Protected Geographical Indication (PGI) Café de Colombia, Darjeeling tea in India, Penja Pepper in Cameroon, Parmigiano-Reggiano in Italy, and Idaho Potatoes, Vidalia Onion, and Washington State Apples in the U.S.

The success of these products is probably based on the ability of the original supply chains to turn into *value* chains. What is the difference between a supply chain and a value chain?

A supply chain is the interconnection of all functions, starting from raw material manufacturing into the finished product and ending when the product reaches the final customer.

A value chain is a set of activities that focuses on creating or adding value to the product. A value chain is a business to respond to the marketplace by linking growers and marketing actors (handlers) to markets demands (Agriculture and Food Council, 2004). Onion production in New York, for instance, is closer to a supply chain than a value chain. Innovative enterprises have learned that, if it is to be utilized for competitive advantage, the supply chain must be viewed not as a necessary cost of providing a product or service or a sum of costs but as a source of extra value and profit. We can assume that some consumers (and retailers) want better quality, more diversity, more typicity, and more originality and there is evidence that consumers are willing to pay more to increase their usefulness (Bonnet and Simioni, 2001).

¹⁰⁰ Vandecandelaere, E., Teyssier, C., Barjolle, D., Jeanneaux, P., Fournier, S., Beucherie, O. (2018). *Strengthening sustainable food systems through geographical indications: an analysis of GI economic impacts*. Rome: Food and Agriculture Organization of the United Nations (FAO) and BERD, 135p.

Vandecandelaere E., Teyssier C., Barjolle D., Fournier S., Beucherie O., & Jeanneaux P. (2020). Strengthening sustainable food systems through geographical indications: Evidence from 9 worldwide case studies. *Journal of Sustainability Research*, 2(4): e200031.

¹⁰¹ The EU geographical indications system protects the EU names of products that originate from specific regions and have specific qualities or enjoy a reputation linked to the production territory. Geographical indications comprise: PDO – protected designation of origin (food and wine) and PGI – protected geographical indication (food and wine) The differences between PDO and PGI are linked primarily to how much of the product's raw materials must come from the area, or how much of the production process has to take place within the specific region. Geographical indications establish intellectual property rights for specific products, whose qualities are specifically linked to the area of production

To explain these successes, we assume that value chains use different strategies based on the simultaneous control of three levers^{102 103}: the creation of value-added, the distribution of this value-added between all agents of the chain, and the protection of competitive advantage. To explain the mechanism of governance within the sector, I will discuss how relationships between stakeholders of the value chain (producers, processors, state) organize themselves to set and control the rules of production, which will play a role in the formation of prices at different stages of the value chain.

Moreover, by focusing on collective strategies and forms of coordination, I analyze the mechanisms behind entry barriers for competitors. These barriers are used to produce a competitive advantage and are regulatory. They interfere with competitors who do not subscribe to these rules and are generally specific to the territorial model of governance.

Finally, I highlight the role of formal and informal institutions on the type of deployed governance and the level of performance of the value agri-food chains in terms of prices to producers. We are aware of the importance of aligning the various dimensions that determine the type of governance and its positive effects on prices.

I have proposed a grid exploring the value chain based on three different dimensions: (1) creating value; (2) distributing value; (3) setting up a lasting competitive advantage (Figure 68).

¹⁰² Vandecandelaere, E., Teyssier, C., Barjolle, D., Jeanneaux, P., Fournier, S., Beucherie, O. (2018). *Strengthening sustainable food systems through geographical indications: an analysis of GI economic impacts*. Rome: Food and Agriculture Organization of the United Nations (FAO) and BERD, 135p <http://www.fao.org/3/I8737EN/i8737en.pdf>

¹⁰³ Jeanneaux P., 2018 "Stratégies des filières fromagères sous AOP en Europe - Modes de régulation et performance économique » <https://www.quae.com/produit/1529/9782759229062/strategies-des-filieres-fromageres-sous-aop-en-europe>

Figure 68. Value Chain Framework (Jeanneaux, 2018)

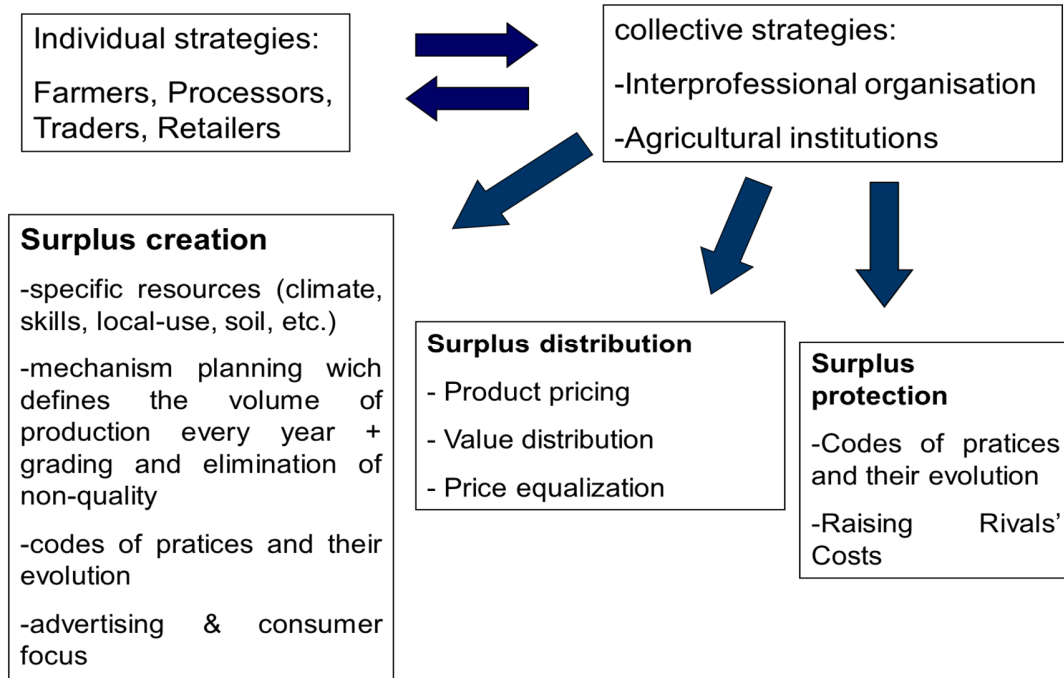

6.1.1. Creating value

The first dimension is about value creation within the supply chain. Two elements play a role in creating value. The first element involves the stakeholders' capacity to take advantage of the specific resources on their territory to feed into the differentiation strategy (Barjolle et al., 2000)¹⁰⁴. We refer to local know-how, which creates product uniqueness linked to origin (types, varieties, local practices, seasonal dimension, soil quality, etc.). Practices are listed and registered in Ministerial decrees and are enforceable against third parties. These practices, which are similar to property rights, are promoted and defended.

¹⁰⁴ Barjolle, D., Chappuis, J. M., & Dufour, M. (2000). Competitive position of some PDO cheeses on their own reference market: Identification of the key success factors. In B. Sylvander, D. Barjolle, F. Arfini (eds). *The socio-economics of origin labelled products in agri-food supply chains: Spatial, institutional and coordination aspects*. INRA-Economica.

The second element is about production control and monitoring (Sylvander, 2004)¹⁰⁵. Indeed, the value chain should not go through overproduction or shortage periods to balance supply with demand, restrain price volatility, and optimize the quality and sales of the product. In theory, there are multiple ways for managing vegetable supply, including (a non-exhaustive list): the quota system (allocation of annual rights to produce vegetables); the control of market opening (marketing season planning); the control of the territory where production takes place, including zone reduction; the financing of redirecting vegetable overproduction to standardized markets; and the implementation of export support measures. Through vegetable selection and downgrading, quality management is an effective tool when the vegetable reprocessing industry can take advantage of the downgraded quantities.

6.1.2. Distributing value

The second factor is the distribution of added value through different levels of the value chain (Barjolle et al., 2007)¹⁰⁶. Outsourcing indeed affects the remuneration of production factors. The extent of value distribution between levels of the value chain can be measured by analyzing vegetable price settings. In theory, the bilateral price setting mechanism between stakeholders can be institutionally guided by the value chain organization.

Several options can be considered. Price policy sets the terms for bilateral transactions. For example, upstream price setting can be based on the real vegetable value obtained on the market. Price calculation may result from market data made publicly available (vegetable price depending on the quality and weighed by volume). This mechanism might be formalized with a standard contract approved by the stakeholders of the value chain. In other instances, the vegetable price at the farm gate may be set without relation to the selling price of the vegetable at retail. Price

¹⁰⁵ Sylvander B., (2004). "Development of Origin Labelled Products: Humanity, Innovation and Sustainability. Synthesis and Recommendations." Dolphins Project (Development of Origin Labelled Products: Humanity, Innovation and Sustainability). CE, Bruxelles.

¹⁰⁶ Barjolle, D., Révillon, S., & Sylvander, B. (2007). Création et distribution de valeur économique dans les filières de fromages AOP. *Economie et Sociétés*: 1507-1524.

negotiation may then refer to more general data on national prices. Further measures (e.g., quality-based price following a grid set up by the value chain inter-professional organization, pooling-price program, and direct payment) can be put in place to support the price setting mechanism.

6.1.3. Setting up of lasting competitive advantage

The analytical framework refers to the domain of “Laws and Economics,” based on the observation using direct legal sources. This discipline aims at analyzing and understanding the economic consequences of operating legal mechanisms. The legal elements form the relevant dimensions for stakeholders for setting and implementing an economical strategy while seeking to influence their institutional environment and the relations between the economic stakeholders. To guaranty that local goods are produced by respecting a code of practices, the stakeholders of value chains reach to list and register practices as rules in a legal document (Ministerial decree, contract, etc.). This process is able to differentiate and protect the value chain against competitors and provide a competitive advantage to the links of the value chain. A code of practices is an institution. The Nobel Laureate in economics, Douglas North, defines institutions as "the rules of the game in a society; more formally, they are the humanly devised constraints that shape human interaction. Thus, they structure incentives in exchange, whether political, social, or economic. Institutional change shapes the way societies evolve through time and, hence, is the key to understanding historical change" (North 1990, p. 3). Institutions are both formal (constitutions, laws, property rights) as well as informal (sanctions, taboos, customs codes of conduct) (North 1991, p. 97). This definition integrates two essential dimensions: that of the production of institutions, and that of their implementation ("enforcement") according to various modalities. The stakeholders of a value chain always work to produce, implement and enforce institutions.

According to Porter (1985)¹⁰⁷, value chain analysis allows the contribution of each activity to obtain a competitive advantage. To lower their costs, big industrial groups continuously arbitrate between in-house production and outsourcing, as well as spatial integration or splitting.

Implementing these strategies constitutes massive competition attacks that result in eliminating competitors that fail in developing alternative strategies. Large industrial vegetable groups mostly set up their processing plants within the major vegetable growing regions. Some companies remotely guide their whole supply chain while seeking a competitive advantage through a cost competitiveness strategy. Vertical integration of suppliers (and horizontal integration of competitors) results from the large groups' strategy for reducing production costs. By these means, economies of scale are achieved as fixed costs get distributed in bigger production quantities.

Following Coase (1937)¹⁰⁸, Williamson (1985)¹⁰⁹ developed the idea that vertical integration depends on the potential achievement of economies of information resulting from the integration of economic relations. According to his theoretical framework, companies tend to integrate their suppliers based on their asset's specificities and the transactions' frequency (contract's specificity); in other words, on the potential reduction of transaction cost that companies can expect. The search for market power can raise competitors' costs without necessarily cutting one's production costs.

The Raising Rivals' Costs theory (Salop, Scheffman, 1983; Scheffman, Higgins, 2003)¹¹⁰ analyzes market power searching behavior. It states that suppliers' integration or exclusive contracting with suppliers enables the specific stakeholder to impose, at the supply level, higher costs to competitors while weakening their position. The "predatory" company seeks to control suppliers

¹⁰⁷ Porter M., (1985). "Competitive advantage: creating and sustaining superior advantage." New York, the free press

¹⁰⁸ Coase, Ronald H. (1937), "The Nature of the Firm," *Economica*4 (November): 386 – 405

¹⁰⁹ Williamson O. E., (1985). *The Economic Institutions of Capitalism: Firms, Markets, Relational Contracting*. New York, The Free Press.

¹¹⁰ Salop S. C., Scheffman D. T., (1983). "Raising Rivals' Costs." *American Economic Review* 73: 267-271.

Scheffman D. T., Higgins R. S., (2003). "20 Years of Raising Rivals' Costs : History, Assessment, and Future." *George Mason Law Review* 12(2): 371-387.

that are indispensable for the competitors and induce higher prices for the intermediary goods or services than the cost the company bears. Competitors face an induced market power and see their profits reduced by the increased cost and the pressure by the predatory firm on the selling price of the end products. By focusing on the factors leading to vertical integration, this approach reverses the analysis, suggesting that suppliers' integration does not lower the production and/or transaction costs but instead imposes higher costs to weaken competition while integrating or taking control of their suppliers.

In this study, I propose that retaining collective control of the rules of production contained in legal texts makes it possible to impose a strategy of raising competitors' costs and limits the possibility of the latter imposing another model of organization of production, which is generally based on a strategy of domination by costs (Porter, 1985)¹¹¹.

I analyze how agricultural producers organize themselves collectively to protect the competitive advantage of their value chain. In this collective organization, farmers and handlers develop a commercial strategy of differentiation, distinguishing themselves from strategies based on cost domination. To do this, producers develop shared rules whose implementation is partly facilitated by public regulation mechanisms. In this way, they develop a sustainable collective competitive advantage, from which each agent benefits individually (Perrier-Cornet and Sylvander, 2000)¹¹². In this framework, firms can influence the institutional framework and the organization of relations between producers and wholesalers and adapt to it.

6.1.4. Second analytical grid: Governance

Promoting an original way to manage businesses, the governance of the value chain results from the capacity of different agents (who have decision power) to collectively set the goals, the means, and the actions' rules. To highlight the heterogeneity of value chains regarding their

¹¹¹ Porter M., (1985). "Competitive advantage: creating and sustaining superior advantage." New York, the free press

¹¹² Perrier-Cornet P., Sylvander B., (2000). "Firmes, coordinations et territorialité. Une lecture économique de la diversité des filières d'appellation d'origine." *Economie rurale* 258: 79-89.

territory linkage, some authors (Sylvander, 2004)¹¹³ distinguish territorial and sectoral governance. I propose an analytical grid inspired by this analysis of territorial versus sectoral governance and crossed with our grid of the regulation of cheese production systems.

Sectoral governance is understood as business management by a group of firms defending their interests in the name of their sector. Over time, these companies mostly merge with their competitors. As a result, the power relations between the economic agents of the sector mainly consist in negotiations between farmers and the handlers' level in the framework of an authority that might be, in the U.S, supported by USDA.

Territorial governance by managing an organization is a business management mode for collective matters that the State can offset. This organization model can take the form of a value chain inter-professional organization. Whereas in territorial governance, the organization's mission is to represent and to defend the production system's interests (the products and its agents), the value chain organization enables agents to coordinate regulations and actions between them, which will take the form of inter-professional agreements containing the code of practices, the collective marketing of the products, the definition of the production zone, and the setting of the dues for the organization. The organization relies on this policy for taking action. The power relations between the stages are set up within the organization, creating an institutionalized place for consultation (e.g., a Federal Marketing Order).

6.2. The Vidalia case study

Vidalia onion is a success story. In 2018, on his Food Network television show, celebrity chef Bobby Flay said the following about Vidalia onions: "Vidalia onions aren't just the most famous onions in the world; I think they may be the only famous onions in the world." Vidalia onion corresponds to the production of onion in Georgia and concerns only 20 counties. Growers

¹¹³ Sylvander B., (2004). "Development of Origin Labelled Products: Humanity, Innovation and Sustainability. Synthesis and Recommendations." Dolphins Project (Development of Origin Labelled Products: Humanity, Innovation and Sustainability). CE, Bruxelles

produce three million hundredweight on 11,000 acres and generate about US\$120-130 million per year.

6.2.1. Data to study the Vidalia onion industry

To study the Vidalia onion industry, the information we seek on the Vidalia onion industry has been collected from a variety of data types:

- public statistical data collected from the USDA website
- exchanges with USDA members in charge of the Federal Marketing Order
- articles and other scientific literature
- technical documents from the University of Georgia
- production costs
- administrative documents (such as Federal Marketing Order)
- farmers' websites,
- the website of the Vidalia onion association
- information from the Vidalia Onion Museum
- websites of the professional press available on the web.

Due to the COVID-19 health crisis, we could not collect oral information from farmers, experts, and sector stakeholders.

All the data, whether bibliographic or collected empirically in the field, allowed us to produce a certain number of written or intermediate graphic works (commodity chain diagrams, institutional framework diagrams, flow diagrams, price graphs, production graphs, summary tables of variables, etc.) to synthesize the data for the first time, to identify the major trends and relevant indicators.

6.2.2. The history of the Vidalia onion in a nutshell^{114 115 116}

The cultivation of Vidalia onions started in the early 1930s. This onion is named *Vidalia* because it was historically grown in the town of Vidalia in Georgia. The story (Fig. 69) says that a farmer, Mose Coleman, living in Toombs County, Georgia, produced onions in 1931 that were unusually sweet and mild and managed to sell them at a higher price than other onions.

The Vidalia onion gets its mild and sweet flavor from the low-sulfur soil, short-day varieties, plenty of irrigation water, and a temperate climate. The craze for this onion gained momentum quickly and encouraged other growers to start producing Vidalias as well. In the 1940s, farmers began to sell their onions to tourists, which may explain why the onion's fame soon spread beyond its production area. Although production was not limited to the area of Vidalia, the onions became known as Vidalia onions. In the 1960s, the *Piggly Wiggly* grocery store, headquartered in Vidalia, saw the potential of this product and helped farmers throughout the area get their new onions on store shelves. By the mid-1970s, about 600 acres were devoted to producing the Vidalia onions, and a national marketing effort began. Production increased by almost tenfold during the next ten years.

In the 1980s, faced with domestic and international competition, Vidalia onion producers in Georgia began protecting their niche market. They have gained national and international recognition through marketing, legislative protection, and research. They have also protected the name, quality, and image of the product through state ownership of the trademark.

¹¹⁴ Most of the information about the history of Vidalia Onion comes from the excellent document written by Toe C. Olson: Olsson, T. (2012). Peeling back the layers: Vidalia onions and the making of a global agribusiness. *Enterprise & Society*, 13, 832 - 861.

¹¹⁵ We also extract information from the GIANT Project. The GIANT project hopes to serve as a base of research through which academics and students around the world learn about geographic indications, their impacts on trade today, and the numerous debates being waged around the world on their behalf. <http://mandalaprojects.com/giant-project/vidaliaonion.htm> Retrieved on November 15, 2020

¹¹⁶ Lot of interesting information is gathered from the blog of AYP: <https://www.ayptravels.com/2020-georgia-part-15-vidalias-sweet-onion-museum/>, Retrieved on November 15, 2020

Figure 69. The history of Vidalia Onion

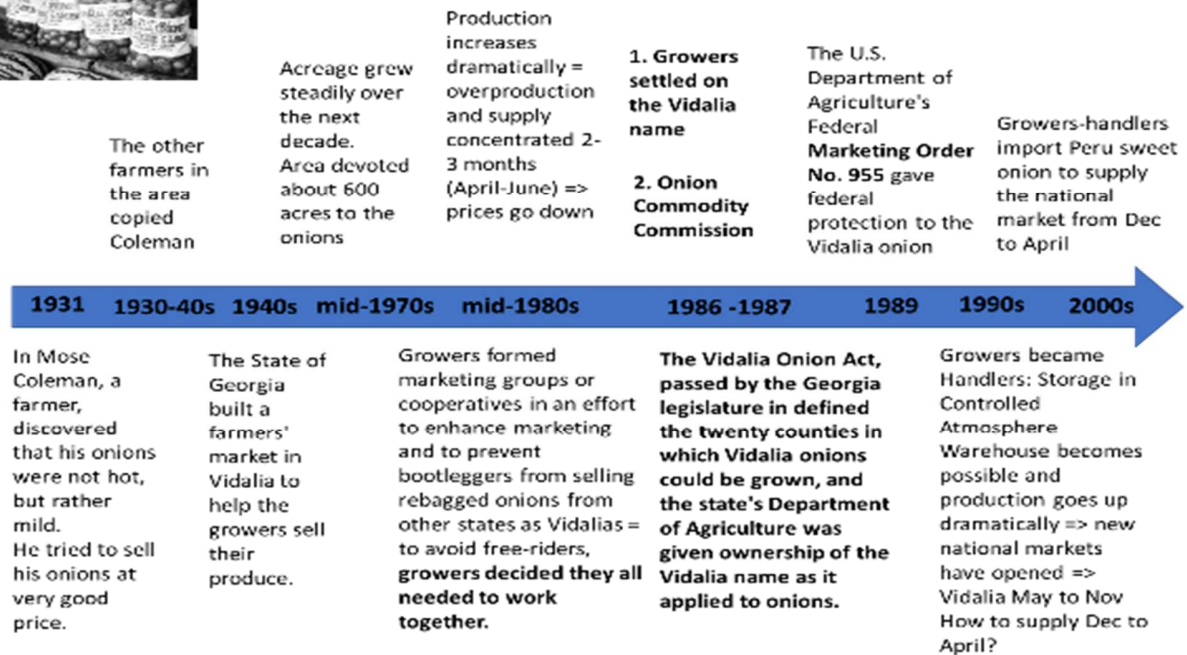

Their approach is exemplary and is very similar to the agri-food production systems under geographical indication (i.e., Protected Designation of Origin or Protected Geographical Indication) found in Europe, particularly in France, Italy, and Spain.

According to Molnar & Cui (2018)¹¹⁷, approximately 225 growers cultivated Vidalia onions on over 14,000 acres. About 125 handlers were involved in the grading, packing, and distribution of Vidalia. In 2021, according to USDA, 65 growers were registered as Vidalia onion growers within the Federal Marketing Order. They represented more than 65% of the volume grown in the Vidalia area. Growers owned medium to large onion farms. They produce Vidalia on land ranging between 200 to 1,500 acres. The Vidalia industry is a broad mix of farmers:

- some who only grow onions;
- some who grow onions and have their own packing lines;

¹¹⁷ Molnar J, Cui L, 2018, Journal of Agriculture and Life Sciences Vol. 5, No. 1, June 2018 doi:10.30845/jals.v5n1p1

- and a small number of larger operators who purchase or contract onions from farmers, grow their own onions, and in some cases, have contract relationships with operations in Peru and Mexico to import sweet onions for packing when the Vidalia crop has been exhausted.

This is why 55 out of 65 registered growers are also packers.

Onion acreage peaked in the 1990s. The registered acreage was around 4,135 acres in the 1988-1989 season and peaked in the 1995-1996 season with 16,000 acres. During the 2001-2002 season, there were 15,214 acres under production (133 growers & 91 handlers), which decreased to roughly 11,000 acres in the 2018 season.

Vidalia onion has a strong reputation and is exclusive on the market, allowing retailers to sell the product for between 30-40 cents (30 to 40%) more per pound than other onions.

To explain this success story, we analyze how growers have created value, distributed this value, and protected their competitive advantage.

6.2.3. Surplus creation mechanism

What are the causal relationships that can explain the observed positive economic impacts?

Growers have developed four categories of actions that have created a sustainable surplus:

- Growers have accumulated factual arguments based on local resources to differentiate their onion and market it as a unique onion;
- Growers have developed grading to eliminate bad quality and to offer a premium onion. The quality control of the Vidalia onion value chain is critical for maintaining a competitive edge in the marketplace;
- Growers have implemented a supply control to avoid overproduction and shortage and to avoid volatility and mistrust with customers;

- Growers have decided to create a single common brand and have pooled their funds to finance promotion to enhance the notoriety of this brand.

6.2.3.1. A terroir to produce a unique onion

Growers have identified over a long time the attributes that create a unique product. Smittle et al. (1979)¹¹⁸ described what we consider a “terroir” (Figure70): “*Vidalia Onion is the appellation given to mild, sweet-tasting onions grown in several counties in southeast Georgia, which have called “status” onions (Jaynes). Their **sweet taste** is derived from the variety of onion, husbandry practices, climate, and soil conditions that reduce pungency of the onions.*”

The Terroir is the harmony between product, soil, climate, skills, and cultural factors.

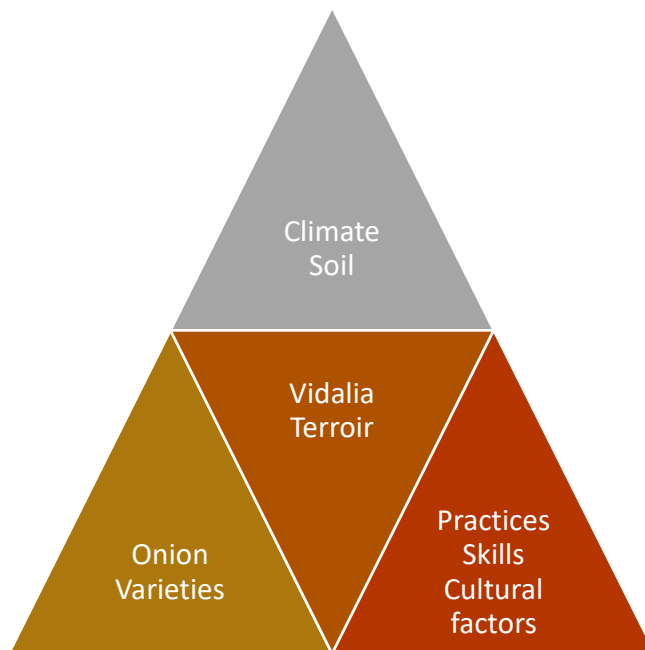

Figure 70. The “Terroir” triangle

(1) The first component is the onion. A Vidalia onion should have a light, golden-brown exterior and a milky white interior. It should be rounded on the bottom and slightly flat on top (Picture 4). Vidalia onions have a higher water and sugar content than other onions.

¹¹⁸ Smittle D. A., Hayes M.J., & Dickens W. L. (1979), Quality Evaluation of Onions, The University of Georgia College of Agriculture Experiment Stations, Tifton, Georgia, Research Report 3366, November 1979

According to Smittle et al. (1979), Vidalia onions are of the Granex variety. A true Vidalia is "*of the hybrid yellow granex, granex parentage or any other similar variety. Granex onions are hybrids of the Bermuda onion and the Grano onion. The genetic disposition toward low pungency comes from the Bermuda side of the family. Bulk, important for producing high tonnage per acre, comes from Grano side.*"

Picture 4. Vidalia® onion aspect



Credit: What Makes a Vidalia Onion | Vidalia® Onions
<https://www.vidaliaonion.org/about-vidalia-onions/what-makes-a-vidalia-onion/>

(2) The second component is soil and climate conditions (or pedoclimatic conditions). Vidalia Onions grow in sandy soil (Picture 5) with low sulfur. According to Olsson (2012), low sulfur soils (ceteris paribus) produce lower pungency onions as if there is “something in the soil.”¹¹⁹

It should be noted that a minority of farms practice organic farming. When I asked Horticulture and Vegetable Extension Specialists in Georgia like Timothy Coolong (Professor of Horticulture and Vegetable Extension Specialist at UGA) if there are any organic onion producers in Georgia and especially in the Vidalia region, he said: “Yes, we have several growers - a few hundred acres. Vidalia onions are our largest single organic vegetable crop grown in Georgia.” And when I asked

¹¹⁹ Quote is from the "The Onion You Could Fall in Love With," Atlanta Constitution Magazine, June 27, 1976, 23.

why organic practices are less used, Timothy Coolong said: “For us, organic onions are more *challenging to grow, and the market, while growing is still smaller than conventional*”. And he added: “*They [growers] are trying to reduce inputs- our sale prices largely haven’t risen, but inputs have so margins are tighter- anything they can do to reduce inputs is good. Growers would like to reduce chemicals to save money and don’t unnecessarily spray. They try to reduce chemicals as much as possible on their own.*”

Coolong explained growers’ difficulties: “*They [both organic and conventional farmers] understand that our climate in the Southeastern U.S. (hot humid) promotes many disease and insect pests and they definitely try to manage their crop accordingly*”. And related to the future, Timothy Coolong concluded that “*growers are aware of environmental issues, and one of the biggest environmental challenges facing producers is weather variability due to climate change*”.

Picture 5. Vidalia sandy soil

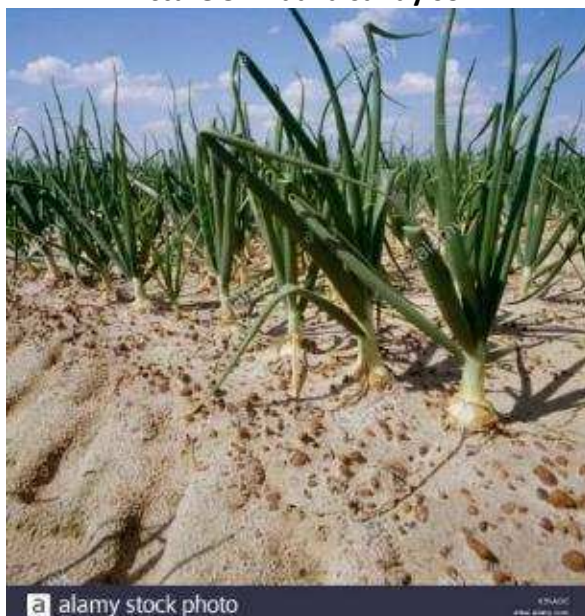

Credit: Grant Heilman Photography / Alamy Stock Photo

If the first condition is to have sandy soils, the second is to have a specific climate, with mild winter temperatures and adequate precipitation (Olsson, 2012)¹²⁰. Indeed, Vidalia onions owe their mildness in part to being grown as a winter crop. An increase in growing temperature from 15°C to 35°C will double pungency. Because low soil moisture further increases pungency, and with relatively light winter precipitation, irrigation is necessary. Therefore, water is a critical resource (Picture 6).

Picture 6. Vidalia sandy soil and water: Two crucial natural resources



Credit: M & T Farms - Lyons GA, Vidalia Onion Planting
<https://www.youtube.com/watch?v=MHFDXwQp9vU>

Once the key natural components of the originality of the Vidalia onion have been identified, the delimitation of the area where the product can grow seems obvious. Growers have limited production to suitable areas. Thus, this unique terroir has been materialized by an official production area. The unique terroir of the Vidalia onion-growing region includes 20 counties in the southeastern part of Georgia (Map 3): 13 whole counties and portions of seven others.

¹²⁰ Olsson, T. (2012). Peeling back the layers: Vidalia onions and the making of a global agribusiness. *Enterprise & Society*, 13, 832 - 861

Map 3_The Vidalia onion-growing district, centered around Toombs County, home to the town of Vidalia

North ▲



(Cartography by Paul F. Starrs) from Howard (2002)¹²¹

(3) The third component of the terroir is human skills.

Over a long time, growers have learned the best conditions for sweet onion production. They have developed local know-how, which has been built on empirical knowledge accumulated over the years. An original feature of Vidalia onions is the old practice of hand-growing.

¹²¹ Howard, T. (2002). The onion landscape of Georgia. *Geographical Review*, 92(3), 452-459.
<https://doi.org/10.2307/4140920>

The crop is hand-planted from September through February each year, with 70,000 plants produced on each acre. One planter can plant a 1/2 acre per workday, i.e., 35,000 plants over a 10-hour workday or one transplant planted every second! About 12,000 acres are planted each year.

Seeds are planted in nursery beds in September and hand-transplanted to fields in November and December over an 8- to 9-week period (Pictures 7 & 8). Mechanical planting for onion production is possible and has a similar total yield to hand-transplanting (Da Silva et al., 2019).

If direct seeding is possible, onion seed should be sown on October 15th, give or take a week. This is later than sowing in transplant production but is required to avoid undue seed-stem formation (flowering) in the spring. The soil should be prepared so that it is free of clods and plant residue, and the surface should be smooth with the proper amount of soil moisture. Soil that is too wet will clog the sowing equipment, while soil that is too dry may result in the seeder riding up on the soil and not sowing the seed at the proper depth. Seeds should be sown with a precision seeder, such as a vacuum planter set to sow seed at 4-6 inches in-row at a depth of 1/4 - 1/2 inches deep. According to Da Silva et al. (2019), care must be exercised to correctly sow the seed since a grower will only have one chance to get it right. If weather conditions are not favorable, there is a risk of compromising the crop. As a result, even if direct sowing is cheapest, hand planting seems more flexible in coping with hazardous weather and more secure in achieving yield goals.

**Picture 7. Vidalia Onion Hand-planting
& Picture 8. Vidalia Onion Hand-planting**

(Credit: M & T Farms - Lyons GA, Vidalia Onion Planting <https://www.youtube.com/watch?v=MHFDXwQp9vU>)



Vidalia onions are also hand harvested, which is an old practice. Less than 2% of Vidalia Onions are mechanically harvested. A worker needs a full day to clip enough onions to fill 150 bags (40 lbs. each), i.e., 6,000 pounds per worker per day. A worker needs four days to hand-harvest just 1 acre or 600 bags (Picture 9). Around 200 million pounds of Vidalia Onions are shipped each season. Therefore, 33,000 worker-days are necessary for harvest.

Picture 9. Vidalia Onion Hand-harvesting

(Credit: ThinkProgress.org, "Georgia Farmers Face Another Worker Shortage Because Of Harmful Immigration Law" by Amanda Peterson Beadle, 13 Apr 2012. Retrieved March 18, 2021)



Many reasons can explain why Vidalia onion is hand-harvested:

- hand-harvesting seems to be the best practice to avoid rough handling and wounding by machinery that would reduce sweetness and juiciness. (UGA Extension, 2017)¹²².
- Harvesters select the best onion and reduce time spent on quality control in warehouses.
- Hand-harvesting is, therefore, a guarantee of quality and can be valued on the market.
- Vidalia onion growers must secure their labor force for the hand-planting period. By providing hand-harvesting, hand-grading, and hand-packaging jobs, Vidalia onion growers are more attractive for workers, especially migrant workers.

Indeed, the Vidalia onion labor system is based on migrant labor. According to John Shuman¹²³, president of Shuman Farms, the challenge is to bring in workers in November and December to transplant the crop and in spring to harvest the onions. He complains that seasonal, temporary workers are not available in the U.S. Therefore, growers use the H-2A guest worker program that allows U.S. employers to bring foreign nationals to the U.S. to fill temporary agricultural jobs. He said this program has been successful because it brings in non-immigrant workers from Mexico and other countries who want to work in the U.S at different periods of the year and return to their country during other periods. Even if this policy is quite expensive for employers, it plays a crucial role in securing and retaining workers.

It is a challenging task to estimate onions workers. According to Larson (2008)¹²⁴, 18,212 Migrant and Seasonal Farmworkers (MSFW) were counted in 2008 for the 20 counties where Vidalia onion grows. 8,906 were migrant workers, and 9,233 were seasonal workers. These workers were not all employed in onion planting, transplanting, harvesting, grading, or packaging; many workers harvested and planted peppers, tomatoes, watermelon, etc. Larson (2008) assumes that about 20% to 33% of these growers were involved in onion planting or harvesting, an estimated 5,000

¹²² UGA Cooperative Extension Bulletin 1198 • *Onion Production Guide*, 2017

¹²³ By Harley Strickland | January 10, 2019 at 5:12 PM EST - Updated January 10 at 5:53 PM, retrieved Feb 18, 2021

¹²⁴ Larson C. A., 2008, Georgia Farmworker Health Program – Migrant and seasonal farmworker enumeration profiles study Georgia, State Office of Rural Health, Cordele, January 2008, 42 p.

MSFW. The Vidalia region includes 13% of all counties in Georgia but represents 22% of MSFW. Migrant and seasonal farmworkers are essential for producing value in this industry.

Vidalia onion workers may also be local workers who came from Mexico and other Central American countries. The Hispanic population has dramatically grown since 1980. Tattnall and Toombs counties illustrate this demographical change. Some of the Hispanic population is probably employed as Vidalia onion workers (Table 41).

Table 41. Overview of Racial and Ethnic Demographics Trends in Tattnall and Toombs counties

	1970	1980	1990	2000	2018
Total population	35708	40726	41794	48372	52401
White population	25442	29564	29837	31318	31100
Black population	10241	10987	10800	13073	14300
Hispanic population	144	311	1179	4263	5910
Percent Hisp/Total	0,4%	0,8%	2,8%	8,8%	11,3%

Source: US Census of Population, Tattnall and Toombs counties, Georgia, 1970-2018

*does not figure in seasonal, temporary workers

Migrant workers are the backbone of the Vidalia industry, producing high-quality onions with a relatively low-cost labor force. It is an open question on how fair and therefore sustainable the migrant labor system operates in the Vidalia region.

Indeed, the Vidalia onion industry and migrant and seasonal farmworkers have developed a codependence that has evolved over many years. This relationship increasingly limits the ability of U.S. workers to compete for job opportunities.

As noted earlier, the H-2A program allows agricultural employers to hire foreign guest workers on temporary work visas to fill seasonal jobs. To participate, employers must demonstrate that a shortage of U.S. workers exists and that wages and working conditions meet certain minimum requirements. Employers must post job openings and show that they have not received any applications. They can then resort to H-2A. In fact, U.S. workers are discouraged from responding to job offers in the Vidalia onion industry. This is because Georgia's state labor laws favor

employers by offering a very low minimum wage rate of about \$5.15/hour¹²⁵ (employers subject to the Fair Labor Standards Act must pay the \$7.25 Federal minimum wage^{126, 127}). Because of the high cost of living in the United States, this rate does not allow a permanent American resident a livable wage. Therefore, no American citizens can accept this type of employment. And since there are no applicants, employers can use the H-2A program to employ low-wage migrant workers. Georgia's wage rate is the lowest in the United States, along with the state of Wyoming. Meanwhile, the rate is \$12.50/hour for New York State and \$14.00 for California¹²⁸.

This situation poses potential risks for producers since some unscrupulous labor contractors and farmers knowingly take advantage unfair labor practices. For example, in 2021, there was litigation on human and labor trafficking operations. As reported by the United States Department of Justice: *“two dozen defendants have been indicted on federal conspiracy charges after a transnational, multi-year investigation into a human smuggling and labor trafficking operation that illegally imported Mexican and Central American workers into brutal conditions on South Georgia farms¹²⁹.”* This could negatively affect labor-law compliant producers by degrading the reputation of their businesses.

¹²⁵ Details are available in Title 34-Chapter 4-Section 34-4-3. Amount of minimum wage to be paid by employers; employers and employees covered by chapter: <http://ga.elaws.us/law/section34-4-3> retrieved December 22, 2021.

¹²⁶ Details about the Federal minimum wage are available on: <https://dol.georgia.gov/minimum-wage>, retrieved December 22, 2021.

¹²⁷ Georgia's minimum wage is \$5.15 per hour, however, with some limited exceptions, the federal minimum wage rate applies. Georgia's minimum wage law can be found in the Official Code of Georgia Annotated (O.C.G.A.) at Title 34-Chapter 4-Section 3 (O.C.G.A. 34-4-3) and the Fair Labor Standards Act, generally and at 29 U.S.C. 203, 206, 213, and 214. retrieved, December 01, 2021

¹²⁸ From Paycor, which is a company providing human capital management (HCM) software: <https://www.paycor.com/resource-center/articles/minimum-wage-by-state/> retrieved, December 01, 2021

¹²⁹ <https://www.justice.gov/usao-sdga/pr/human-smuggling-forced-labor-among-allegations-south-georgia-federal-indictment>, retrieved, December 01, 2021

6.2.3.2. Segmentation through grading and supply control

The first driver in valuing the *Terroir* is to select onions that reveal the uniqueness of this product. We have seen that Vidalia onion is a product of *terroir*. Tangible and relevant attributes differentiate the product, and to turn these attributes into premium quality, growers have implemented a grading system. The quality standards set by the Vidalia Onion Committee identify minimum grades, sizes, quality, and maturity and set packing specifications for size, capacity, weight, and dimensions (Clemens, 2002). These quality standards help ensure the reputation of the Vidalia onion for consumers. Moreover, federal inspection and grading standards for onions are used for Vidalias to guarantee quality. Onions must be inspected by the USDA to use the Vidalia name (Figure 71). Vidalia onions are placed into three grades: U.S. No. 1, U.S. No. 2, and U.S. Combination. These “external” controls are independent of growers and handlers and ensure the impartiality of the rating process, which then bolsters the reputation of Vidalia onion.

Figure 71. Quality inspection within the Vidalia onion value chain



To discourage growers from supplying bad quality onions, low-quality onions are chopped and given to cows or to produce biomass. These two outlets make it possible to control the supply and avoid overproduction and price decrease.

The second driver in controlling onion supply is based on limiting production to suitable areas.

By delimiting the Vidalia *Terroir* within 20 counties in Georgia (see Map 3 above), growers have created an exclusivity and a local monopoly. Growers have created a situation that promotes scarcity and protects from overproduction to lead to higher prices.

The third driver is to stabilize supply and maintain prices at a high level. Two main actions have been implemented to maintain optimal quality and regulate the market: storage under a controlled-atmosphere to increase the onion's shelf life and the packaging date of Vidalia onion.

(1) The first crucial action was to introduce controlled-atmosphere storage.

“We sell about half of our crop on fresh and we will put about three million 40 lb. units in cold storage and we’ll sell them through to Labor Day,” says Bob Stafford of the Vidalia Onion Committee.

Forty years ago, much of Vidalia's onion production was sold in less than two months, from mid-April to mid-June. Because they had to sell their products quickly to preserve the onion from spoilage, supply exceeded demand, and prices dropped dramatically.

Thanks to research programs that found solutions for longer onion storage, controlled-atmosphere storage has been used in the Vidalia onion industry since the 1990s. The air in warehouses was replaced with nitrogen, which chills the onions to one or two degrees above freezing. This technique preserves onions from spoilage and considerably extends the storage and sale period. Growers can steadily provide onion to satisfy customers and to maintain prices at a higher level. Growers can continue to sell their onions as late as Christmas. Extending the Shipping time allowed Vidalia to access new markets. To provide supermarkets, some growers developed year-round production for year-round consumption. A few growers produce sweet onions in Peru and Mexico to achieve this goal and export their sweet onions to the United States to provide the market from December to April. Some growers have considered that if they cannot produce onions in the U.S. at a lower price, Mexico will knock them out of the marketplace¹³⁰, and they have decided to produce sweet onions in Peru. Due to its desirable soil and climate, Peru has become a counter-seasonal Vidalia producer.

In an article released by “ProduceBusiness” (2017)¹³¹, Shuman Produce, a grower in the heart of Vidalia country marketing under the RealSweet label, depicts Peruvian onions as a “*Vidalia cousin.*” Shuman said: “*Our Real Sweet Peruvian sweet onions are part of our year-round*

¹³⁰ The World, December 30, 2010 - <https://www.pri.org/stories/2010-12-30/why-some-american-farmers-are-moving-mexico>

¹³¹ ProduceBusiness, Howard Riell September 1, 2017, “The Vidalia Cousin: Peruvian Onions”: <https://www.producebusiness.com/vidalia-cousin-peruvian-onions/>, retrieved March 19, 2021

RealSweet sweet onion program and provide consumers with a high-quality sweet onion with a similar shape and flavor profile to the Vidalia during the fall and winter months.” He added: *“Peruvian sweet onions have increased in popularity due to following directly after Vidalia onion season.”* According to L. G. Herndon Jr. Farms, a grower in the Vidalia area (Lyons, Georgia), onions produced in Peru have increased customer loyalty and allow us¹³²: *“to stay in touch with our customers year-round. We start Peruvian onions in mid-August and continue until the first of February; we can ship them until March.”* However, one main challenge is to ensure the best quality for consumers. Bland Farms is a large grower-shipper of sweet onions in the U.S. and has its own growing operation in Peru, with Georgia personnel making scheduled site visits to check on quality¹³³.

Technologies (e.g., controlled-atmosphere storage) to control supply and quality have opened new markets, new opportunities, and a new business model that goes hand in hand with globalization. This strategy has played a positive multiplier effect on the wealth of the Vidalia onion value chain.

(2) The second crucial action was to introduce the “Pack date.”

Historically, the Vidalia sweet onion was a seasonal onion that appeared in roadside stands and stores around mid-April and was virtually gone by mid-June. High prices rewarded growers who were able to enter the market early in the season. These prices encouraged some growers to bring immature onions to market. Prices dropped dramatically, and the reputation of the onion was likely to deteriorate. To avoid this vicious circle, producers agreed to set a packing date each year at which they can sell the onion. Vidalia onions cannot be sold before this date. The Georgia Department of Agriculture (GDA) and the Vidalia Onion Committee (VOC) announce this “special moment” every year. The pack date for the 2021 season was April 19¹³⁴. The pack date is

¹³² ProduceBusiness, Howard Riell September 1, 2017, “The Vidalia Cousin: Peruvian Onions”: <https://www.producebusiness.com/vidalia-cousin-peruvian-onions/>, retrieved March 19, 2021

¹³³ ProduceBusiness, Howard Riell September 1, 2017, “The Vidalia Cousin: Peruvian Onions”: <https://www.producebusiness.com/vidalia-cousin-peruvian-onions/>, retrieved March 19, 2021

¹³⁴ <https://vegetablegrowersnews.com/news/georgia-sets-2021-ship-date-for-vidalia-onions/> retrieved March 19, 2021

determined by soil and weather conditions during the growing season that helps ensure the highest quality Vidalia onions, known for their sweet and mild flavor.

6.2.3.3. The key role of Vidalia onion promotion

Several means are used to promote Vidalia onion.

The first is the unique brand “VIDALIA®” to differentiate the onion from its competitors. In the early 1970s, Georgia onion promotion was fragmented and confusing. Some labels competed: for example, “Glennville Sweets” or “Tattnall County Sweets,” but also private labels like “Vidalia Sweets” or “Pride of Piggly Wiggly Brand Vidalia Onions.”

In 1986, onion growers and the state of Georgia decided to create a single iconic brand to stop confusion and enable easy recognition. The Georgia State Legislature passed the Vidalia Onion to trademark Vidalia's name for onions of the Vidalia growing region. This brand is a common and certified brand owned by Georgia (Picture 10).

Picture 10. Vidalia Onion Trademark
Source: <https://www.vidaliaonion.org/>



The Georgia Department of Agriculture (GDA) and the Vidalia Onion Committee (VOC) have invested in this brand to increase its notoriety. Because increasing the notoriety of a brand is expensive, a major challenge was to pool enough money to get the threshold effect from which an advertising investment is profitable. To get and pool money, since 1989, Vidalia onion growers have been granted Federal Marketing Order (FMO) No. 955 through the U.S. Department of

Agriculture's Agricultural Marketing Service. FMO No. 955 was established to stipulate where the crop can be grown and help with research and promotion of Vidalia onions. The Vidalia Onion Committee administers the FMO No. 955 and authorizes production research and marketing promotion programs. This federal program and Georgia laws that protect the Vidalia trademark have provided a legal framework for the industry.

Per Federal Marketing Order (FMO) No. 955, the order's provisions are binding on all growers and handlers of onions produced within a strictly defined geographic area, which covers all or part of 20 Georgia counties. The FMO assessment is 13 cents/bag paid by "the first handler." So, the Vidalia Onion Committee receives about US\$700,000 to US\$800,000 every year. Nevertheless, since 55 registered growers out of 65 are also first handlers, the Federal Marketing Order functions to pool money from local grower-packers to fund promotion, rather than money from handlers who are not growers. Every year, about US\$400,000, half of the packer assessment, is spent to promote the brand and improve the effectiveness of the onion promotion strategy.

Once the brand exists, it is easier to organize events to promote the brand. The pack date is one of these annual events. If the pack date regulates supply to increase quality, it is also a driver in creating buzz and stimulating the desire to buy Vidalia onions. The date the onion ships is an annual rite of spring.

Once the brand exists, it is also important for retailers and consumers to be sure they buy an authentic Vidalia onion. The Vidalia Onion Committee has obtained a Price Look Up code (PLU) to easily identify each onion through a produce identification sticker. The International Federation for Produce Standards (IFPS)¹³⁵ is the global organization that assigns PLU codes to produce items. According to IFPS, which is composed of national produce associations worldwide, PLU codes make checkout and inventory control easier, faster, and more accurate. The long-term objective of the federation is to improve the supply chain efficiency of the fresh produce industry through developing, implementing, and managing harmonized international standards. The PLU code is a four- or five-digit international code that identifies specific fruits and vegetables. Supermarkets

¹³⁵ <https://www.ifpsglobal.com/Home/About-IFPS>, retrieved March 22, 2021

have used PLU codes since 1990. PLU code 4159 denotes a conventionally grown Vidalia onion. The PLU code sticker on each onion is crucial to enforce the brand and to ensure consumers pay for the right product and the right quality. The PLU code sticker on each onion provides a new service to grocery stores and supermarkets (i.e., easier, faster, and more accurate inventory control) and is key to building trust between growers and retailers.

This advertising strategy has been successful, but it has exposed onion growers to unfair competition from growers and processors outside the Vidalia region. Therefore, to avoid counterfeiting, the Georgia Department of Agriculture (GDA) and the Vidalia Onion Committee (VOC) cleverly decided to allow any processors to use Vidalia onion in their culinary preparations, rather than a costly process of controlling and restricting the use of the name. According to the Vidalia Onion Act of 1986, (O.C.G.A. 2-14-130): *“anyone desiring to use the word VIDALIA® on any product containing fresh Vidalia® onions that will be processed, marketed or sold as such, must first apply to the Georgia Department of Agriculture for a license to use the registered U.S. Certification Mark Vidalia®.”* To encourage use of the brand, the cost to use the license was low. Truly a stroke of genius, as the Vidalia Onion Committee “is paid” to promote its product; the program brings in approximately US\$300,000/year through the very low royalty fees. Several processors use the Vidalia trademark (Picture 11).

Royalty fees are US\$0.001 per 6oz of product. For example, to use the Vidalia trademark in a 12 fluid ounce bottle of Vidalia Onion Dressing containing 1.3% by weight of Vidalia onion, it costs the processor around US\$0.0000026: $(12 * 0,013 / 60) * 0,001$

Royalty fees from the Vidalia name are used to protect the name and enforce the trademark.

Picture 11. Illustrations of the range of products that use the Vidalia brand to promote their product



Other means are used to promote Vidalia onion.

Since 1991, the Vidalia Onion Committee has annually honored one individual with induction into the Vidalia Onion Hall of Fame. The Committee considers the recipient's character, reputation, and overall contribution to the growth and success of the Vidalia onion¹³⁶.

The Vidalia® Onion Committee also awards an annual "Grower of the Year" award. The Grower of the Year Award is to recognize the overall achievement and success of Vidalia onion producers.

¹³⁶<https://www.vidaliaonion.org/> retrieved January 20, 2021

The emphasis of this award is on quality, production, and the ability to work within the confines of the Marketing Order.

The Vidalia® onion reputation is also based:

- on recurrent events such as the “Vidalia Onion Festival.” The festival alone brings in 75,000-100,000 people looking to be educated about and entertained by the Vidalia onion;
- and on permanent promotion such as the Vidalia Onion Museum located in Vidalia¹³⁷. The Vidalia Onion Museum provides historical experience across a 1,300 square foot space. The museum opened in 2011, and after its first year in operation, it drew visitors from 40 states and seven countries. According to Wendy Brannen, executive director of the onion committee, the Vidalia Onion Museum is an unqualified success. She said: *“We have had in print over 50 stories with 5.9 million media impressions, on TV and radio we’ve had more than 415 stories with potential impressions being 284.8 million, and on the internet we’ve had over 300 stories with potential impressions of 697 million.”*¹³⁸

The Vidalia Onion Business Council (VOBC) collects a voluntary assessment at US\$2/acre for political lobbying. VOBC may collect about US\$18,000 every year, funding the 2,000 pounds of onions that were given to all 100 Senate offices (Picture 12)¹³⁹. This kind of promotion increases the reputation of the product in the political arena.

¹³⁷ <https://www.vidaliaga.gov/cvb/page/onion-museum> retrieved January 20, 2021

¹³⁸ <https://theproducenews.com/vidalia-museum-draws-visitors-all-over-learn-sweet-onion-history>, retrieved February 12, 2021.

¹³⁹ https://www.northwestgeorgianews.com/georgia-senators-deliver-vidalia-onions-to-colleagues-in-washingto-georgia-new/article_9566dc5b-fe0d-564c-b742-839620dabf4b.html retrieved January 202021

Picture 12. Georgia’s U.S. Senators Johnny Isakson and Saxby Chambliss in front of the Capitol before shipping their Vidalia onion to all 100 Senates offices



(Credit: Johnny Isakso, Jun 5, 2007)

6.2.3.4. A relevant strategy to create surplus

The differentiation strategy based on valorizing a unique, common pool resource, the “Terroir,” has been successful. Over several years, sweet onions have been better valued on the market (Fig. 72). From 2011 to 2020, we estimate the sweet onion surplus at retail was close to 30-40% on average compared to yellow “pungent” onion for the Northeast U.S. region.

Figure 72. Retail Average Price 2011 - 2020 Current\$/pound - Northeast US region - Yellow onion vs Yellow Sweet onion (USDA)

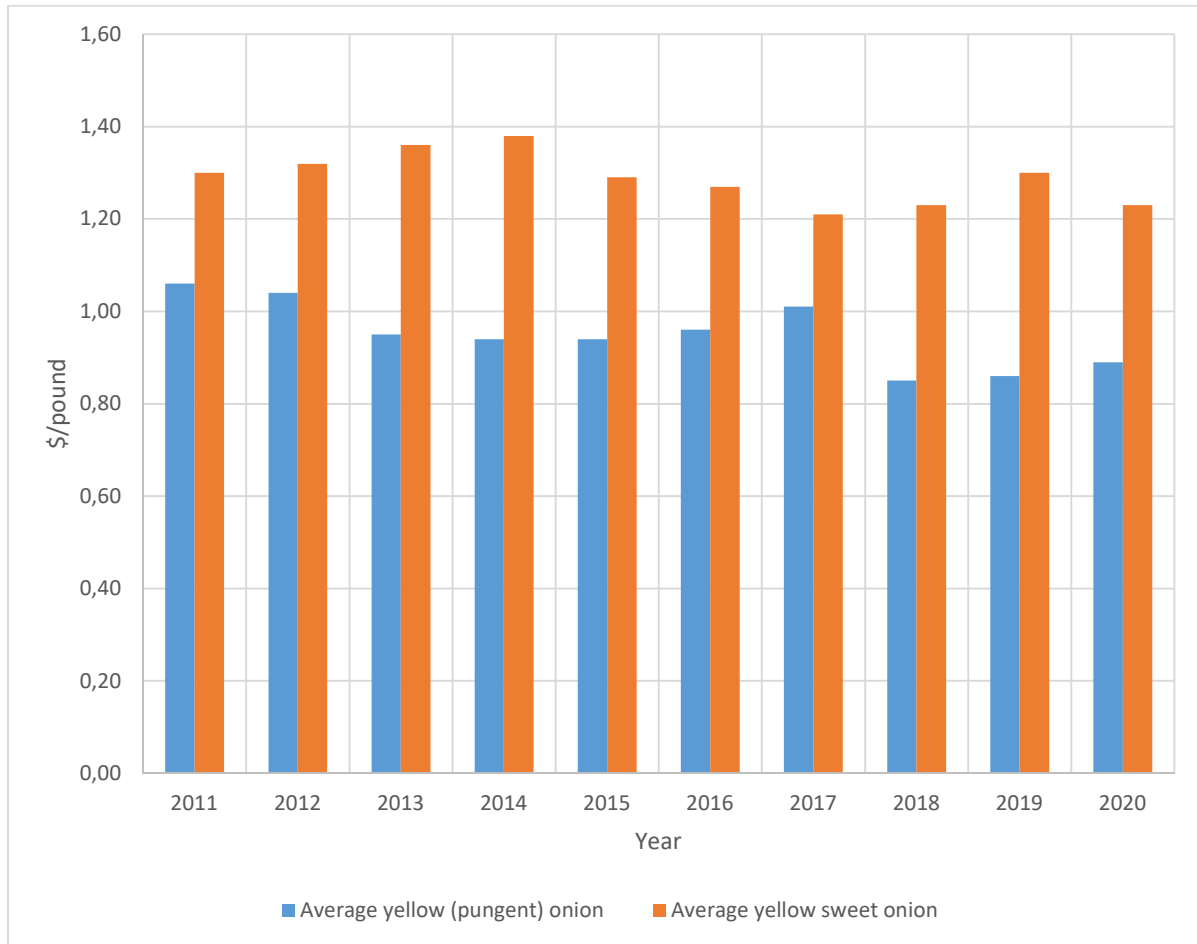

We observe the same difference between yellow onion and marketed yellow sweet onion at the national retail level for 2020 (Figure 73). We focus on the Vidalia marketing period (mid-April to December 2020). The weighted average price was about US\$1.07/pound for sweet onion, while it was US\$0.77/pound for yellow onion, a 39% difference.

Figure 73. National Price (per pound) comparison at retail - Yellow Onion vs Yellow Marketed Sweet Onion April to December 2020 (USDA)

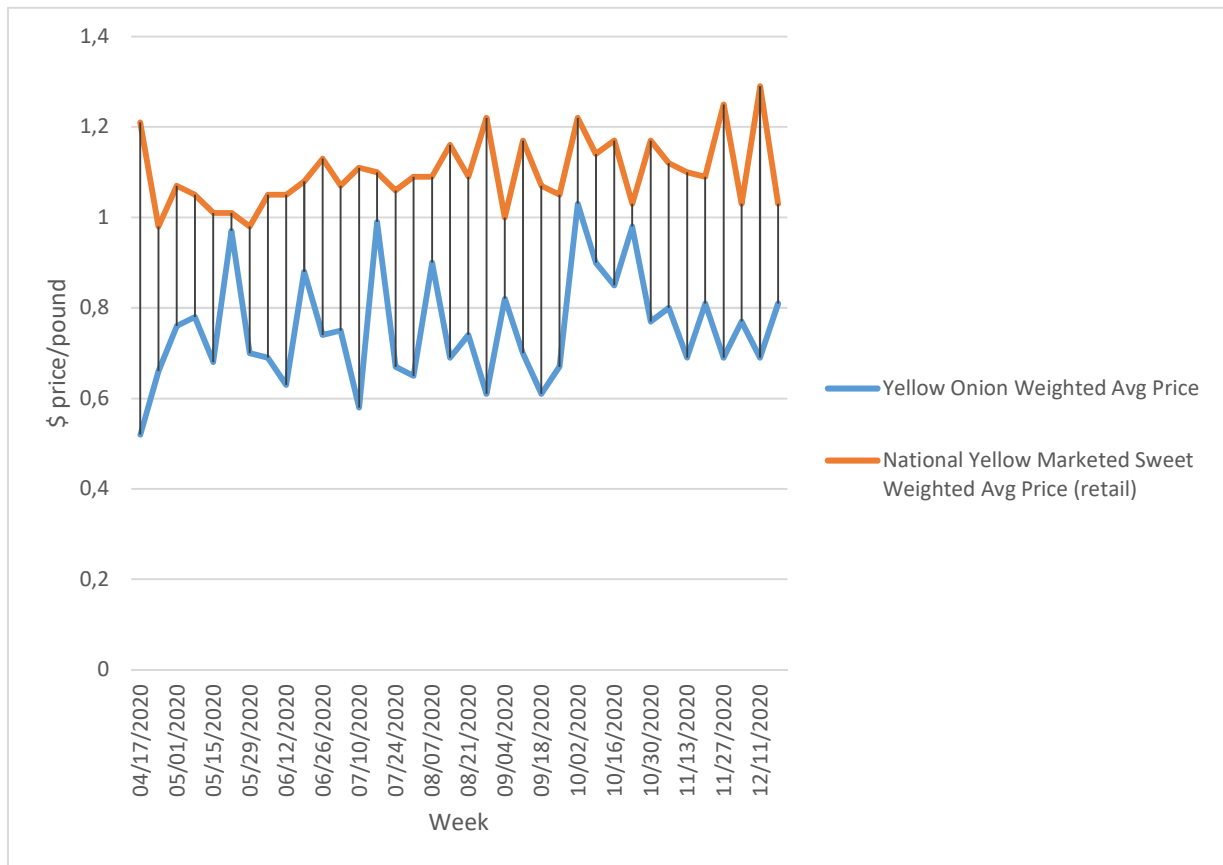

In 2018, onions ranked first in terms of the farm gate value, generating US\$149.5 million, 13.3% of Georgia’s total farm gate value of US\$1.12 billion. The farm gate value per acre of onion was US\$11,780¹⁴⁰. This value was higher than the U.S. onion farm gate value, which was US\$6,765 per acre¹⁴¹. This simple indicator highlights how Vidalia onion has succeeded in developing its differentiation strategy.

¹⁴⁰ CAED, 2019, Georgia Farm Gate Value Report 2018, University of Georgia, Center for Agribusiness and Economic Development, AR-19-01, December 2019, 178 p.

¹⁴¹ Source: USDA, National Agricultural Statistics Service, Vegetables Summary

6.2.4. Surplus distribution mechanism

Having examined the creation of surplus, the next question is how this value is distributed among stakeholders.

This question may seem strange for those who believe the market is the only tool for resource allocation and the only institution able to define prices at different supply chain stages. In many supply chains, a pricing policy sets the terms for bilateral transactions. For example, upstream price setting can be based on the actual market value of vegetables. Price calculation for a link of the supply chain may result from market data made publicly available (vegetable price depending on the quality and weighed by volume). Sometimes stakeholders agree to apply a standard contract that defines marketing conditions (volumes, quality, prices, shipping times, etc.).

6.2.4.1. Two main drivers organize pricing distribution

For the Vidalia onion value chain, we assume that two main drivers organize pricing distribution.

The first driver is transparency at different stages and especially at the shipping point. Every week, the USDA releases national shipping point trends through its Agricultural Marketing Service for onions in different U.S. regions.

A grower can easily find daily or weekly prices. According to the USDA, these *“prices represent open (spot) market sales by first handlers on product of generally good quality and condition unless otherwise stated and may include promotional allowances or other incentives. No consideration is given to after-sale adjustments unless otherwise stated. Brokerage fees paid by the shipper are included in the price reported. Delivered Sales Shipping Point Basis excludes all charges for freight.”* For example, on Monday, April 30, 2020, a grower can find this kind of information:

VIDALIA DISTRICT GEORGIA: DEMAND FAIRLY GOOD. MARKET STEADY.

Yellow Granex - Marked Sweet

40 lb cartons

jbo 18.00-22.00 mostly 18.00-20.00

ORGANIC

40 lb cartons

jbo 26.00-29.00 occas lower ("occas" means Occasional 1 to 5%)

With this information, growers can decide the best period to sell their products. They can also compare these prices to a previous period. Of course, market transparency is not a driver to increase prices at the farm level. This information allows growers to better negotiate prices at the first handler stage.

The second driver is based on farm activities. Growers have become packers and have vertically integrated activities that were controlled by first and second handlers. In 2021, according to the USDA, 65 growers were registered as Vidalia Onion Growers within the Federal Marketing Order. 55 out of 65 growers registered were also packers. These growers owned medium to large onion farms and produce Vidalias on land ranging between 200 and 1,500 acres. The Vidalia industry is a broad mix of farmers:

- some who only grow onions;
- some who grow onions and have their own packing lines.

The latter strategy allows growers to obtain more market power and more value.

In 2020, when a consumer pays US\$1.10/lb for a sweet onion (not only Vidalia) at retail, 56 cents (51%) go to grower-first handlers, 12 cents (11%) to second handlers (packers), and 42 (38%) cents to retailers (Figure 74 and 75). This situation is radically different from New York State and Northeast region (see above, Figure 58).

Figure 74. Distribution of the value (in US\$/pound) between three stages of the Vidalia value chain (2020) – USDA

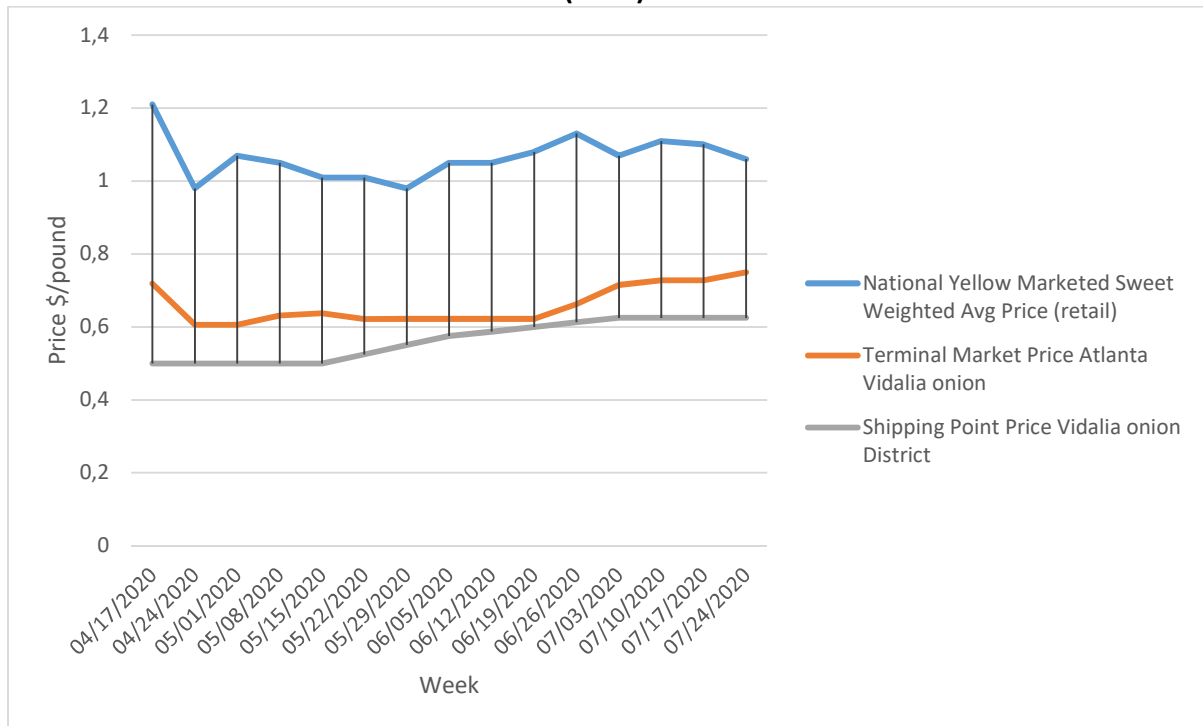

During the season, prices change steadily (Figure 74). When the Vidalia season starts with the “pack date,” the price is higher, and retailers get a lower portion of the value. Then the shared value increases. At the beginning of the period (April 2020), retail received about 42% of the total value and by the end (December), this portion was close to 30%. Simultaneously, first handlers-growers received 40% of the total value, which was increased to 60% by the end of the period. Second handlers cannot maintain their position during the period and received 10% on average (Figure 75).

Figure 75. Distribution of the value (in percent) between three stages of the Vidalia value chain (2020) – USDA

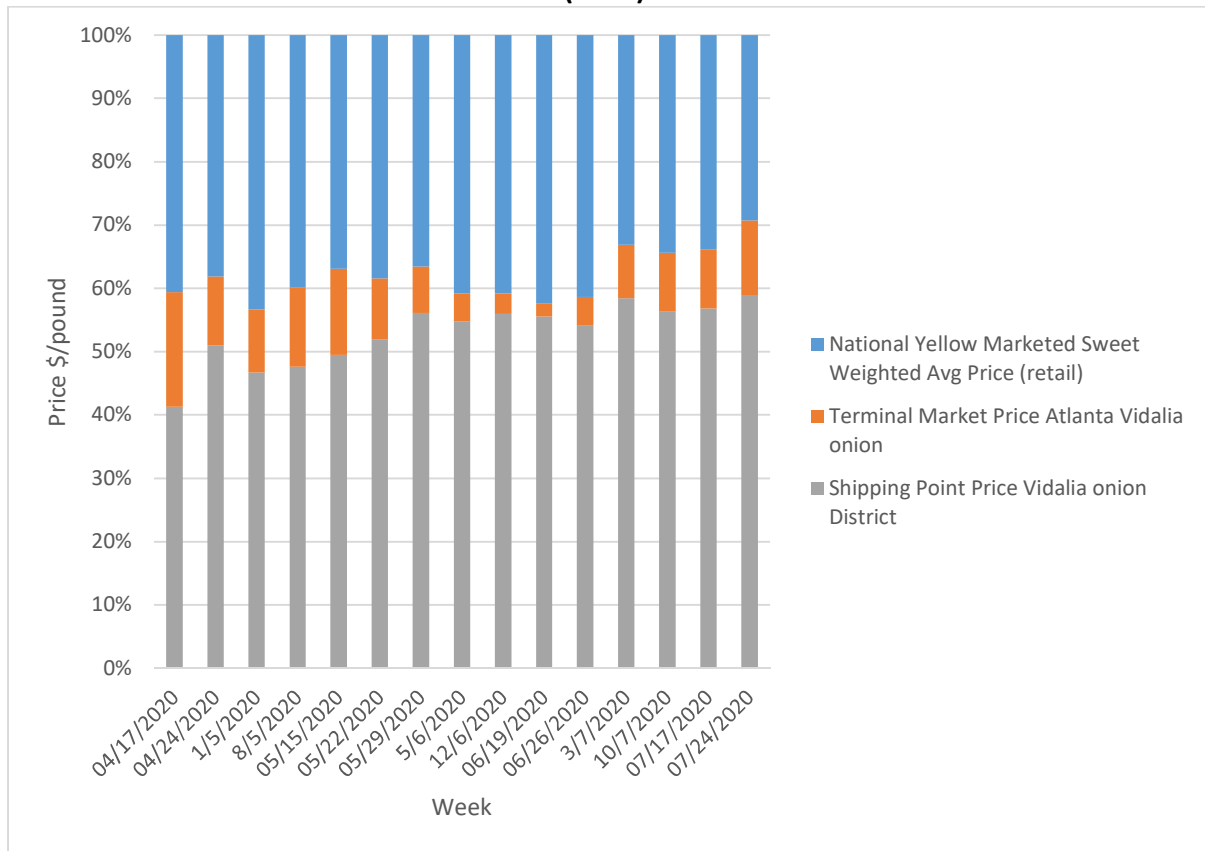

Georgia growers harvested nearly 230 million pounds (530 bags, 40 lbs./acre) or 5.75 million 40lbs bags of Vidalia onions with a value:

- At the farm gate: US\$85 million based on a price of US\$15/40lb bag
- At the Shipping place: US\$170 million based on a price of US\$30/40lb bag
- At retail: US\$253 million based on a consumer price of 1.10€/pounds = US\$44/bag 40lbs

According to the Vidalia Onion Committee¹⁴², Vidalia onions have a US\$350-million economic impact from related marketing activities in the region. In other words, each 40lb bag sold at the farm gate generated an economic impact equivalent to four times its initial value.

¹⁴² This information can be found in the Onion Museum in Vidalia (VOC). We were not able to find the study that gave rise to this result.

6.2.4.2. *Is Vidalia onion production profitable?*

Prices for Vidalia onions have remained strong in Georgia compared to other onion types and vegetables. However, if production costs are higher than other onion production in the U.S, farmers' profitability may suffer.

According to UGA Cooperative Extension¹⁴³, to be profitable, a Vidalia onion grower needs a minimum yield of 306 (40 lbs.) boxes per acre and a minimum price of US\$9.79 per 40 lbs. box of Vidalia onions. Because Vidalia onion prices varied from US\$15 - US\$19 per 40 lbs. box every year (on average), Vidalia growers are generally profitable.

One-half the time, the budgeted grower would expect a return of US\$3,104 per acre or more at US\$16 and a yield of 500 boxes (40 lbs).

Indeed:

Total revenue per acre is US\$8,000 (500 boxes*\$16/box)

Total budgeted cost per acre is US\$4,896 (Table 42)

And returns are US\$3,104 per acre.

The UGA Cooperative Extension report highlights the deviation from the previous results. One out of six years, a grower would expect to make a maximum of US \$4,801 per acre and to earn a minimum of US\$1,406 per acre.

¹⁴³ UGA Cooperative Extension, 2017, Onion Production Guide, Bulletin 1198, June 2017, extension.uga.edu
Source: 2014 Georgia Farm Gate Value Report (2015). Compiled and published annually by the Center for Agribusiness & Economic Development, Report Number: AR-15-01 (September)

**Table 42. Estimated cost of producing onion in Georgia
(Source: UGA Cooperative Extension, 2017)**

	Unit	Quantity	Price	\$Amt./acre
Plants	Thou	70.00	5.00	350.00
Lime, applied	Ton	1.00	30.00	30.00
Side-dressing	Cwt	4.00	13.00	52.00
Fertilizer	Cwt	15.00	11.00	165.00
Insecticide	Acre	1.00	54.00	54.00
Fungicide	Acre	1.00	249.00	249.00
Herbicide	Acre	1.00	30.00	30.00
Machinery (fuel, lubricant & maintenance)	Acre	1.00	21.00	21.00
Set plants	Acre	1.00	333.00	333.00
Irrigation	Appl	8.00	24.00	192.00
Interest on Operating Capital	\$	1476.00	0.06	44.28
Pre-Harvest Variable Costs	Acre	1.00		\$1,520.28
Harvest and Marketing Costs	Unit	Quantity	Price	\$Amt./acre
Hand harvest labor	Boxes	500.00	1.39	695
General labor	Hrs	50.00	8.00	400
Burlap bags (prorated)	Ea	500.00	0.36	180
Grading	Bag	500.00	1.21	605.00
Labeled mesh bags	Ea	100.00	0.48	48.00
Cartons	Ea	500.00	1.69	845.00
Drying	Bag	500.00	0.18	90.00
Vidalia Onion Committee Assessment	Bag	500.00	0.12	60.00
Total Harvest and Marketing				\$2,923.00
Total Variable Costs				\$4,443.28
Fixed Costs	Unit	Quantity	Price	\$Amt./acre
Machinery	Acre	1.00	107.57	107.57
Irrigation	Acre	1.00	117.50	117.50
Overhead and Management	\$	1520.28	0.15	228.04
Total Fixed Costs				\$453.11
Total budgeted cost per acre				\$4,896.39

6.2.5. The process to protect the Vidalia onion competitive advantage

I analyzed how onion growers, growers-handlers, and handlers have organized themselves collectively to protect the competitive advantage of their value chain. In this “collective organization,” farmers and handlers have developed a commercial strategy of differentiation, distinguishing itself from cost competitiveness strategies. Growers and handlers have defined shared rules, which are partly facilitated by public regulation mechanisms.

First, the Georgia Department of Agriculture has defined additional regulations applicable to Vidalia onions in Chapter 40-7-8 of the Rules & Regulations of the State of Georgia (2007)¹⁴⁴. It is a code of practice that depicts the product's specifications and frames the production, control, and marketing practices.

Historically, two main actions have been implemented to protect Vidalia onion production.

6.2.5.1. First action: *The legal Vidalia onion-growing area*

In 1986, the Vidalia Onion Act established that only sweet onions grown in 20 South Georgia counties from a distinctive Granex seed and packed and sold on or after the official pack date each year could be called Vidalia onions.

According to the Vidalia Onion Committee¹⁴⁵, a Vidalia onion is one of several varieties of sweet onion grown in a production area defined by Georgia law since 1986 and the United States Code of Federal Regulations (CFR). Varieties include the hybrid Yellow Granex, varieties of Granex parentage, and similar varieties recommended by the Vidalia Onion Committee and approved by the U.S. Secretary of Agriculture¹⁴⁶. The Chapter 40-7-8-07, "Onion Pungency Analysis," of the Rules and Regulations of the State of Georgia, the Georgia Department of Agriculture has defined the method to measure pungency, if pungency values are utilized in the promotion and/or marketing of Vidalia onions.

Moreover, Georgia's State Legislature passed the "Vidalia Onion Act of 1986," which authorized a trademark for "Vidalia Onions" and limited the production area to the following counties of Georgia or certain subsets as defined by the state's Commissioner of Agriculture:

- Thirteen counties: Appling, Bacon, Bulloch, Candler, Emanuel, Evans, Jeff Davis, Montgomery, Tattnall, Telfair, Toombs, Treutlen, and Wheeler.
- Portions of seven counties: Dodge, Jenkins, Laurens, Long, Pierce, Screven, and Wayne.

¹⁴⁴ Georgia Department of Agriculture, 2007, Rules and Regulations of the state of Georgia, Chapter 40-7-8- Additional regulations applicable to Vidalia Onions, 21 p.

http://agr.georgia.gov/Data/Sites/1/ag_Marketing/Vidalia%20Onion/files/Vidalia%20Rules%20Regulations.pdf

¹⁴⁵ <https://www.vidaliaonion.org/about-vidalia-onions/> Retrieved in November 15, 2020

¹⁴⁶ https://en.wikipedia.org/wiki/Vidalia_onion Retrieved in November 15, 2020

The State of Georgia has been an ally of growers in developing a differentiation strategy of “Terroir” by protecting a unique and a specified geographical area and a specific yellow Granex onion variety. All producers and first handlers of Vidalia onions must register with the Georgia Department of Agriculture in the spring before planting occurs.

The Vidalia onion was named Georgia's official state vegetable in 1990.

6.2.5.2. Second action: A registered trademark to protect the Vidalia onion system from rivals (internal and external)

The Vidalia Onion Act of 1986 was passed by the Georgia State Legislature, trademarking the name “Vidalia onions” and defining the twenty-county growing region. Georgia regulations *preclude persons in Georgia from bagging or selling onions not grown in Georgia as Vidalia Onions.*

VIDALIA® is a Registered U.S. Certification Mark to protect the Vidalia onion system from competitors. It is a single mark owned by the State of Georgia. It is illegal to “package, label, identify, or classify any onions for sale inside or outside Georgia as Vidalia onions or to use the term “Vidalia.” In Chapter 40-7-8-04¹⁴⁷, “certification Mark Agreement,” of the Rules and Regulations of the State of Georgia, the Georgia Department of Agriculture states that: *“Any person who desires to grow, pack, process, market and/or sell onions as Vidalia onions or Vidalia green onions, or use the Mark “Vidalia®” on products containing Vidalia onions or Vidalia green onions, must enter into an agreement with the Georgia Department of Agriculture for the use of the registered U. S. Certification Mark “Vidalia®.” The Commissioner shall establish the terms and conditions of the agreement annually”.*

If a grower outside the Vidalia onion growing district labels an onion as Vidalia, he risks paying a fine of up to US\$100,000. We assume that fines of up to US\$100,000 have greatly reduced

¹⁴⁷ Georgia Department of Agriculture, 2007, Rules and Regulations of the state of Georgia, Chapter 40-7-8- Additional regulations applicable to Vidalia Onions, 21 p.

incidences of mislabeling. However, this policy implies control, convictions of counterfeiters, and enforcement of sanctions, which is expensive and not always effective.

Therefore, the Vidalia Onion Committee proposed a low-cost user license. If a processor wishes to advertise his product as containing Vidalia onions, he must pay a royalty fee, which helps cover enforcement costs. Royalty fees are US\$.001 per 6oz of product¹⁴⁸.

6.2.6. What are the institutions that govern competitive advantage?

The success story of the Vidalia onion value chain results from an organization dedicated to managing and protecting the product. The challenge has been to gather growers who consider a collective competitive advantage more beneficial than individual competition.

Growers compete with each other, but they also collaborate. They respect and have faith in their organization. Growers have built their competitive advantage on a common resource embedded in a small area in Georgia: the *“Terroir of Vidalia onion.”*

Georgia acts as strategic support in discouraging the opportunism of producers and packers who would like to take advantage of this common resource for themselves alone and exclude the other producers of the area.

Georgia has given power of attorney to an organization of growers. The Vidalia Onion Committee (VOC) was created to protect and manage the quality of the crop and control free riders. It has helped to avoid wasted time, effort, and money. The VOC was instrumental in getting the Federal Marketing Order (Table 43) passed and establishing the Vidalia onion as Georgia’s Official State Vegetable. The committee is made up of onion grower leaders dedicated to protecting and expanding the Vidalia onion brand. The Vidalia Onion Committee has eight grower-members and eight alternates (four must be growers-handlers), and one public member.

¹⁴⁸ For instance, to use Vidalia in this Vidalia Onion Dressing (12 fluid ounce bottle) it costs for processor around $(12 * 0,013 / 60) * 0,001 = 0,0000026$ cent

The USDA Agricultural Marketing Service is a third crucial partner in enforcing the Vidalia onion collective voluntarism project.

Table 43. Marketing Order: History and Principles

According to Andrew Hatch (Deputy Director, Marketing Order and Agreement Division, USDA, Agricultural Marketing Service, Specialty Crops Program, (10/27/2020)

- The Agricultural Marketing Agreement Act (AMAA) of 1937 – the authority for federal marketing orders – allows producers to resolve problems that cannot be accomplished alone. While some limitations on lobbying and cross-border coordination exist, activities conducted under federal marketing orders are not held in violation of antitrust laws in the United States.
- Laws were enacted following the Great Depression, as specialty crop producers sought marketing services to help boost the economic standing of farming communities.
- Can work together on all kinds of issues influencing the marketability of fruits, vegetables, and specialty crops, including conservation (e.g., reducing almond water use), research (pests in FL), market access initiatives (how to comply with EU requirements).
- Some just comply with minimum quality requirements through mandatory grading services to ensure quality and are not so robust in activities.
- Help stabilize returns for growers; can control quantity as well.

The AMAA authorizes 11 activities to be carried out in a marketing order, but the Vidalia order does not authorize every activity. The Vidalia order is a Federal Marketing Order and has chosen to implement a few of the 11 activities focusing on marketing, promotion, and research. These activities are consistent with the main stakeholders, who want to increase notoriety (i.e., Vidalia onion as the best-known sweet onion brand all over North America) and reputation (i.e., Vidalia onion as a premium), through the targeted use of common financial resources.

A fourth crucial partner is the University of Georgia and UGA Cooperative Extension in carrying out applied research programs to improve onion growing production in South Georgia.

The Vidalia order authorizes the following activities¹⁴⁹¹⁵⁰:

- Collect and publish data: VOC collects acreage grown and units sold
- Production research: Mostly through the University of Georgia, including trials on new varieties, flavor profile, and mitigating losses from pests, center rot, mold, bacteria, etc.
- Marketing & promotion: US\$300,000/year. Porter Novelli (Public relations firm, part of Omnicom Group) has developed recipes and does social media posts for market advertisement
- Market research: Looking for new markets. Some programs access funding through the Market Access Program with the Foreign Agriculture Service to gain matching funds for market research. For example, Market Access Funds can match funds to investigate marketing in Europe, etc.
- Assessment of handlers: This is how revenues are raised, and the Committee decides how the funds are allocated.
- Contributions: The Committee receives outside contributions from groups that want to fund research and promotions for Vidalia onions.
- Container and pack requirements: Producers decide how they want to package and market their product.

The Vidalia order does not authorize the following activities:

- Minimum standards (size, grade, maturity, quality, and packaging): Vidalia often uses already defined standards.
- Mandatory inspection: Often done through the state, the federal government has oversight.
- Volume control: While Vidalia does not, some programs that do are cranberries, tart cherries, and peppermint oil.

¹⁴⁹For more details, look at e-CFR website: <https://www.ecfr.gov/cgi-bin/text-idx?SID=550fdd37271ea12a101c2ed4ed6567c6&mc=true&node=pt7.8.955&rgn=div5>

¹⁵⁰ Georgia Department of Agriculture, 2007, Rules and Regulations of the state of Georgia, Chapter 40-7-8- Additional regulations applicable to Vidalia Onions, 21 p. http://agr.georgia.gov/Data/Sites/1/ag_Marketing/Vidalia%20Onion/files/Vidalia%20Rules%20Regulations.pdf

- Marketing Orders have a manager and compliance officer, which is another expense and responsibility of the committee—running day-to-day operations. If inspection is built into the Marketing Order, the state usually has a cooperative agreement to inspect. If not, the USDA can use its inspection division. A cooperative agreement with the state is usually less expensive than federal oversight. Whoever is calling for the inspection for the product would pay the inspection fees.

6.3. Conclusion of Section 6

The Vidalia onion industry is a textbook example of farmers developing a market by carefully choosing varieties, limiting production to suitable areas, enforcing standards, and marketing these special attributes to consumers (NFAPP, 2002). Stakeholders have developed a differentiation strategy based on geographical attributes (soil, climate), specific onion varieties, and know-how, which are the ingredients of the "Terroir." The Vidalia onion terroir is a common good recognized by a bounded geographical area and valued through a public brand owned by Georgia.

Developing a differentiation strategy based on local specificities requires legal protection of the common attributes that define a "terroir". Two legal levers have been chosen to ensure this protection: a public trademark and a legal production area.

Growers and handlers have agreed to pool their efforts and their money to improve the notoriety and reputation of their onion. Due to counterfeit issues and the lack of legally binding statutes outside of Georgia, producers and handlers of Vidalia onions requested, and the USDA promulgated, a Federal Marketing Order that defined the production area as a matter of United States federal law.

Thanks to the Georgia State Legislature, growers have trademarked the name "Vidalia onions" and defined the legal, twenty-county growing region. Georgia regulations state that it is illegal to "package, label, identify, or classify any onions for sale inside or outside Georgia as Vidalia onions or to use the term "Vidalia."

Growers and packers (of which 55 out of 65 registered growers are also packers) have implemented packaging and branding standardization, using a standard box, bag, or other packages for fresh Vidalias (along with the Committee’s Vidalia logo on the packaging) to allow for consistent, uniform messaging to consumers.

Finally, even if Vidalia yields are low and operating costs higher, growers have succeeded in getting a better willingness to pay from customers and are profitable. The Vidalia onion is a widely recognized brand, distributed nationally, and is a success story. Nevertheless, if the Vidalia value chain has strengths and opportunities that support producers in their choice, there are also weaknesses and threats that disturb the value chain (Table 44).

Table 44. SWOT analysis of the Vidalia Onion Value Chain

Strength	Weakness
Reputation (High quality) and a Terroir Notoriety (Well-known brand) Marketing order State of Georgia support Collective brand Strong value chain	Decrease in the number of farms A few growers who are also packers could have a quasi-monopoly Self-interest Migrant and seasonal farmworkers dependence Few organic farm
Opportunity	Threat
Demand for local products Machinery Innovation U.S. demography (new consumers) Growing customer catchment area (United States, Mexico, & Canada created one of the largest free trade regions in the world with the North American Free Trade Agreement)	New diseases (virus) Risk from consumers misunderstanding Vidalia and Peru onions Change in labor rules Soil erosion & soil depletion Water & drought issues (climate change)

7. New York Muck Onion Marketing Project: Two simulations for calculating the expected change

7.1. Context and Issues yielding two economic simulations

As presented in section 1 (above) a world-class soil resource, the mucklands, of New York are among the most productive vegetable-growing areas in North America. Constituting about 30,000 acres across four main regions of the state¹⁵¹, New York's Black Dirt regions are the crown jewels of the Northeast region's farmland inventory and produce over 95% of the region's onions. There are about 7,000 acres of black dirt onions with a value of nearly \$40 million per year. It is this scale of production that makes these high-quality onions affordable for everyone.

New York's Black Dirt regions are experiencing an absolute decline in market share. Both acreage and production are down, even if production per acre has climbed a little bit. New York State onion acreage decreased significantly from about 13,000 acres in 2000 to less than 7,000 acres in 2019. New York's onion growers are becoming increasingly less competitive over time with other yellow onion growing regions. In 2017 (USDA Census), about 50 onion growers with more than 5 acres produced 95 percent of the State's onion production with 6,400 acres. However, 20 years ago (in 2002) 114 farms with more than 5 acres used 11,400 acres. Over 20 years growers and acreages have been approximatively cut in half.

In 2019, the onions grown in New York State accounted for 3.2% of domestic production. It was 20% in 1960. The demand for traditional yellow pungent onions may be shrinking in part because sweet onions are becoming a generic all-purpose onion for fresh eating and cooking (see section 1). Despite their potential as a specialty product with unique geographical attributes (soil,

¹⁵¹ The majority of the black dirt acreage is found in four key areas of the state including the (1) Black Dirt Region of Orange County, (2) the Elba mucklands of Genesee/Orleans, (3) the Oswego muck of Oswego County, (4) the Onion town Area of Madison County; and smaller mucklands under 500 acres like the South Lima muck. The areas are distinct in some respects but have a common history in their creation by the great Laurentian ice sheet, their rich American history involving immigrant farmers, and the common characteristics of the onions themselves with a high sugar content.

climate), a specific genetic material, and the specialized know-how of growers, New York muck onions are largely treated like a commodity in relation to other yellow onions. A key driver of decline New York onion production has to do with the muck onion industry's long-time adoption of low-cost/low-price leadership strategy to be competitive with other onion regions that have cost advantages (lots of sun, subsidized water, cheap labor, and cheap fuel for transportation). The yellow pungent onion industry in New York State used to carry on this strategy as if it what the only one. However, competing with these other regions over the last 20 years and in the 2020 decade is a race to the bottom.

My research suggests the drivers of this decline in New York Muck Onion are imperceptible from year to year, but over time have eroded NY's once powerful onion industry.

New York onion growers and handlers wonder if the New York muck onion industry could command a special market segment where discriminating chefs and home cooks value a unique product. This segment could provide increased profit, protect a competitive advantage, and offer resiliency/vitality/vibrancy/well-being for growers and all constituents/members of the value chain.

The grower representatives then brainstormed potential actions the New York Muck Onion industry might take to achieve the shared vision. The lists of ideas generally include working together across the Muck Onion growing areas to promote the uniqueness of Muck Onions, and to explore a range of collaborative marketing initiatives in collaboration with handlers. They think New York Muck Onion growers can collaborate with handlers and retailers to educate consumers, and bring New York's famous onion to a national market. More deeply, the Project leaders' group listed potential actions New York's muck onion industry might take to achieve the shared vision:

- Consumer/Customer education through promotion:
 - Work with Taste makers/influencers/celebrity chefs
 - Statewide Muck onion festivals/onion day at the state fair
 - Social media program: Twitter, FB, Instagram, TicToc, Barefoot Contessa, etc. Bling/SWAG

- Work with trade associations, CIA, chefs - other food service groups that can promote muck onion consumption
- Explore an identifier: “Certified NY Muck Onion”
- Explore statewide specialty muck onion product line that commands premium
- Engage with NYSDAM to assist in funding and bringing growers and handlers together
- Explore federal market order like Vidalia (USDA is ready to help)
- Forming a farmer-owned marketing enterprise (LLC, LLP, or Co-op)

At this point in the process (September 2021), the New York Onion Project is still a potential project. There are three main issues that need to be resolved to move into the implementation phase:

- Assess the value of working together (growers, handlers, retailers) in onion growing areas and markets in New York State.
- Expand the number of growers and handlers involved in the ACRE project and begin to explore specific marketing projects in depth.
- **Evaluate the feasibility of transforming the growing and marketing of a standard yellow onion into a premium New York muck yellow onion.**

To give some answers to this last issue aimed at evaluating the economic impact of transforming the growing and marketing of a standard yellow onion into a premium quality New York muck yellow onion, two evaluations are proposed in the following pages.

The first is a farm-level assessment using different decision-making tools, in particular a partial budget (Subsection 7.1.). The second is a New York onion industry-wide evaluation using IMPLAN™ software (Section 7.2.).

7.1. A partial budget for calculating the expected change in profit from a new muck onion brand in the farm business

The economic impact analysis at the farm gate presented in this section benefited from the critical input of Craig Yunker who is a farmer in Elba, NY.

7.1.1. Principles

A partial budget provides a formal and consistent method for calculating the expected change in profit from a proposed change in the farm business. It compares the profitability of one alternative, typically what is being done now, with a proposed change or future alternative (Kay et al., 2008). We compare a situation A (present) to a situation B (future). The budget is partial (and not a whole-farm budget) because we only consider what is changing. We compare situations “at cruising speed”. We neglect the transition period (Figure 76).

Figure 76. Partial Budget principles

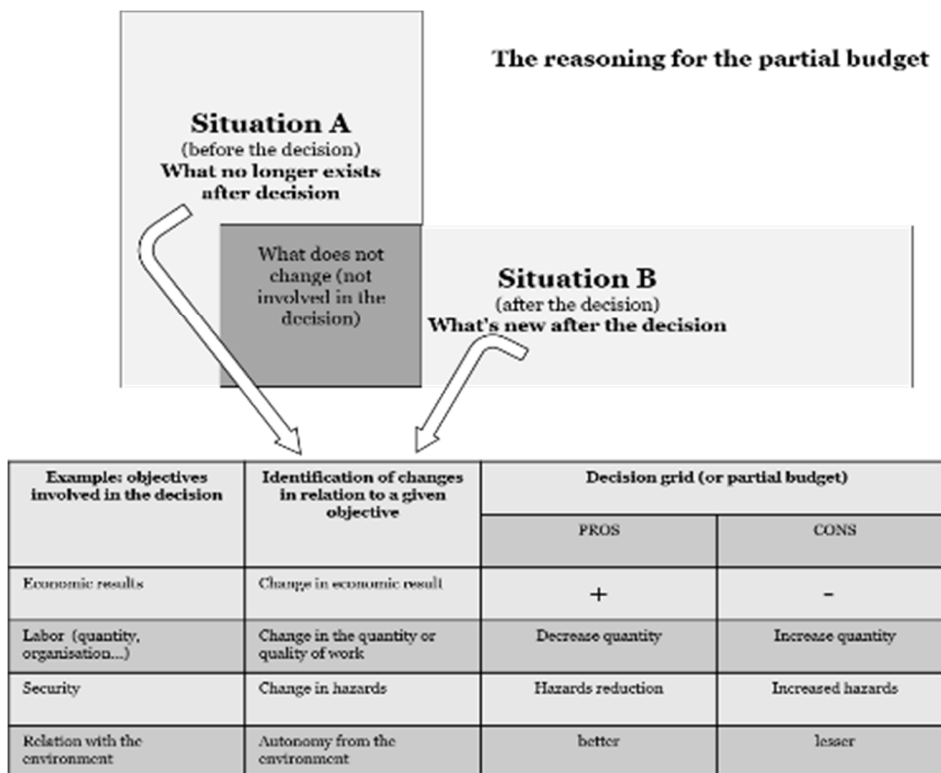

Decision ?

The partial budgeting procedure in four steps:

1. Identify and define the problem
2. Identify alternative
3. Collect data and information
4. Analyse alternatives (Partial Budget)

We add two other steps:

5. Consideration of non-economic elements (Table of non-quantifiable items)
6. Consideration of hazards (Gain and Loss Matrix)

7.1.2. Application to New York muck onion project

7.1.2.1. *The issue*

- ✓ Muck onions are treated like a commodity rather than a specialty crop.
- ✓ The onion remains a basic, standard product that growers cannot sufficiently differentiate to obtain a greater willingness to pay from buyers, retailers, and consumers
- ✓ New York State muck onion growers have not developed the proper value chain, which treats muck onions as a high value specialty crop. Onion Growers are using a price leadership strategy that cannot compete with other yellow onion growing region.

7.1.2.2. *A potential alternative*

Muck onions simply taste better, store longer, and are potentially healthier than mainstream onions from other states and countries.

New York Muck Onion industry could command a special market segment where discriminating chefs and home cooks value a unique product. This segment could provide increased profit.

As onion growers who wonder if they would turn their yellow standard onion into a New York branded black dirt onion, they wonder what is the cost/benefit of onion promotion to their farm

operation and ask the question: **Is it in their best interest to produce premium yellow onions on their farm?**

7.1.2.3. Case study: Operation with 1,500 acres in “Mucksoil County” in New York

Currently family farm leads by two brothers: Brother1, Brother2 and two managers run “Tioga Farms Bros” with a staff of seasonal and non-seasonal workers

Farmland: 15 % Black soil => 225 acres

Field crops (Corn, wheat, barley, alfalfa soybean, etc.): 1,300 acres

Vegetables (Cabbage, Peas, Snap Bean, Spinach): 100 acres

20 % of acreage is provided supplemental irrigation. Irrigation for standard onion is possible.

Onions: 100 acres = > 100 % yellow pungent onion. Onions grow on organic muck soil. Growers plant directly from seed and from transplants, and are yellow varieties. Onions are packed and marketed by a neighboring farm.

7.1.2.4. Collect data and information

Our assumptions are debatable. However, all options are possible when using the partial budget with the Excel file we constructed. In the Excel spreadsheet, a grower can easily modify the parameters to consider or not the different costs and the different production parameters (surface, prices, yields, weight losses, etc.).

The economic horizon of the project must be defined because in some cases, growers must invest and finance their investment with a loan, so growers must calculate the annual depreciation and interest. The economic horizon for the “Tioga Farms Bros” project is 7 years.

First, “Tioga Farms Bros” listed and classified the different elements that should be changed in a table with two columns: PROS vs CONS (Table 45). Some changes are quantifiable and are used as variables for the partial budget. Others are non-quantifiable and are taken into account in a table of non-quantifiable items. A last category of items concerns random effects and are used to evaluate the risk level of the project with a gains and losses matrix.

Table 45. “Tioga Farms Bros” Pros vs Cons

Characteristics of changes	PROS	CONS
Economic (quantifiable items)	More revenue (volume) More revenue (better price)	Less revenue (volume) Less revenue (better price) Proceeding costs Branded (advertisement) costs Quality Control (certification) costs Grading costs Packaging (black mesh) costs Trucking costs Same Yield but less marketable
non-quantifiable (intangible) items	Better use of my equipment Better use of my labor skills Access to new market More independence from our handler Pride – Your work makes you proud Relationship with other growers	More management times Working with new handlers and new retailers
Random events	Price increase of the branded onion	Price increase of the standard onion Less marketable premium onion due to weather conditions that increase small onion size

Assumptions: Outputs

Initial Situation (Present):

The present situation was: 100 acres raised standard onions. An acre produced 42 boxes * 1,000 pounds (20 bags *50 pounds), meaning that 42,000 pounds are harvested per acre or 420 hundredweights per acre.

10% were not marketable due to defaults (size, shape, mold, etc.).

Marketable quantity is: $420 - 10\% = 420 - 42 = 378$ hundredweights/acre

Non-Marketable quantity is 42 hundredweights/acre. This volume is used to feed livestock.

These onions are sold \$30/ton (or \$1.5/ hundredweight).

Three types of onion are produced (Table 46):

Table 46. Onion Characteristics (Present)

Size	Portion of the gross production	Price per bag	Price per cwt
Two-inches	30%	\$5.5	\$11
Medium	50%	\$8.5	\$17
Jumbo	20%	\$9.5	\$19

Weighted Standard onion price: \$15.50/cwt

Final (Future) Situation:

The future situation is: 100 acres raise premium onion with a local premium brand cannot be valued as premium (“baby” size, etc.).

Marketable quantity is different. Grading for premium excludes 12 % (+2 %): $420 - 12\% = 420 - 50 = 370$ hundredweights/acre

Non-Marketable quantity is 50 hundredweights/acre. This volume is used to feed livestock.

These onions are sold \$30/ton (or \$1.5/ hundredweight).

Prices rise by 35 % (Difference observed between a standard onion and a premium onion – branded) (Cf. Vidalia).

Same yields, same practices.

Three types of onion are produced (Table 47):

Table 47. Onion Characteristics (Future)

Size	Portion of the gross production	Price per bag	Price per cwt
Two-inches	30%	\$7.5	\$15
Medium	50%	\$11.5	\$23
Jumbo	20%	\$12.5	\$25

Weighted branded premium onion price: \$21/cwt

There is no change in packaging.

Present and future outputs are (Table 48):

Table 48. Onion Characteristics Comparison Present vs Future

Situation A (present)		Situation B (future)	
Standard Yellow onion: Yield:378 cwt/acre Price per cwt: \$15.50 Onion acreage: 100	Gross production: $378 * 15.50 * 100 =$ \$585,900	Branded Premium Yellow onion: Yield:370 cwt/acre Price per cwt: \$21 Onion acreage: 100	Gross production: $370 * 21 * 100 =$ \$777,000
Non-marketable standard onion:	Gross production:	Non-marketable standard onion:	Gross production:

42 cwt/acre Price per cwt: \$1.5 Onion acreage: 100	42*1.50*100 = \$6,300	50 cwt/acre Price per cwt: \$1.5 Onion acreage: 100	50*1.50*100 = \$7,500
total	\$592,200 =\$1,410/cwt	total	\$784,500 =\$1,867/cwt

Assumptions: Inputs

Operating costs for the Standard pungent onion production are (Table 49):

Table 49. Variable Costs (Operating costs) – Present vs Future

(Present) Variable Costs (Operating costs) for Standard pungent onion production	Per Acre	(Future) Variable Costs (Operating costs) Future Branded Premium pungent onion	Per Acre
Seed or Set plant	713	Seed or Set plant	713
Fertilizer	354	Fertilizer	354
Plant protection	1006	Plant protection	1006
Supplies and Utilities	111	Supplies and Utilities	111
Custom & consultants	0	Custom & consultants	0
Irrigation	0	To increase regularity, onion acreage is provided supplemental irrigation	150
Machinery (fuel, lube, maintenance)	854	Machinery (fuel, lub, maintenance)	854
Specific labor	300	Specific labor	300
Hand harvest labor	0	Hand harvest labor	0
Grading	500	Grading	500
Storage + drying	200	Storage + drying	200
Others (Fees and insurance)	150	Others (Fees and insurance)	150
Interest on Operatig Capital	50	Interest on Operating Capital	50
Total Variable Costs \$/acre	4,238	Total Variable Costs \$/acre	4,388

Marketing costs for the Future branded onion production are (Table 50):

Table 50. Variable Costs (Branded & Marketing costs) – Present vs Future

Variable Costs (Branded & Marketing costs)	Per Acre
Extra grading	100
New labelling mesh bags (black mesh)	70
Promotion Assessment per bag: \$0.15 x740 bags/acre (For example: assessment is 0.13/box for Vidalia)	110
Voluntary promotion fee to finance “Lobbying” (same as Vidalia) \$5/acre	5
Consultants to give advices to increase quality	50
New marketing costs to promote the brand	65
Total Marketing Costs \$/acre	400

7.1.2.5. *A cost/Benefit analysis with a Partial Budget*

All the variables are taken into account in the partial budget (Table 51).

Table 51. Partial Budget

PROS	CONS
Additional Revenue	Reduced Revenue (What current revenue will be lost or reduced?)
(Future) Premium Branded Yellow: 370cwt *\$21/cwt*100 acres = \$777,000	(Present) Standard Yellow: 378cwt *\$15.5/cwt*100 acres = \$585,900
(Future) Non-marketable onion 50 cwt *\$1.50/cwt*100 = \$7,500	(Present) Non-marketable onion 42 cwt *\$1.50/cwt*100 = \$6,300
Total Additional Revenue: \$784,500	Total Reduced Revenue: \$592,200
Reduced cost (What current costs will be reduced or eliminated?)	Additional Costs (What future or additional costs will be incurred?)
Present operating cost to produce = \$4,238 per acre 100 acres x 4,238= \$423,800	Future operating costs to produce a branded onion = \$4,388 per acre 100 acres x 4,388= \$438,800 Future branded costs and marketing costs 100 acres x \$400/acre = \$40,000
Total Reduced cost: \$423,800	Total Additional costs: \$478,800
(A) TOTAL additional revenue and reduced costs \$1,208,300	(B) TOTAL additional costs and reduced revenue \$1,071,000
NET Change in Profit (A minus B) =	\$137,300 or \$1,373/acre

As a result, it seems profitable to change the business model to produce a branded premium onion. However, “Tioga Farms Bros” cannot make a decision on the economic interest of the change alone. Therefore, they should identify the non-quantifiable elements that have to be taken into account in the decision, and compare them with the change in economic result from the partial budget.

7.1.2.6. *Consideration of non-economic elements (Table of non-quantifiable items)*

The non-quantifiable elements should be listed in order of importance and lessons learned about their weight in relation to the quantifiable elements and risk taking (Table 52).

Table 52. Non-quantifiable elements

order	PROS	CONS	order
1 +++	Access to new market	More management time	1 ---
2 +++	Pride – Your work makes you proud	Working with new handlers and new retailers	2 ---
3 +++	Relationship with other growers		3 ---
4 ++	The brand gives value to my business		4 -
5+	Better use of my labor skills		5 -
6+	More independence from our handler		
7+	Better use of my equipment		

Based on this table, “Tioga Farms Bros” consider that the PROs outweigh the CONs.

7.1.2.7. Consideration of random events (Gain and Loss Matrix)

A final dimension remains to be addressed: the risk involved in the project. The risk must be assessed to see if this dimension will not contradict the first two results.

“Tioga Farms Bros” consider they have to evaluate the impact of onions price and of marketing and branded costs (Table 53).

First, in the budget partial future price for a premium onion is \$21/cwt. What would be the impact on profit if this price is \$18/cwt (\$3 less compared to the reference) or \$15/cwt (\$6 less compared to the reference).

- \$111,000 ↑ (\$6 x 370 x 100 = \$222,000) (Growers cannot value their onion)

- \$111,000 ↑ (\$3 x 370 x 100 = \$111,000) (Intermediate situation Price increase by 20%)

Second, in the budget partial future marketing and branded costs for a premium onion are \$400/acre. What would be the impact on profit if these costs are \$200/acre (\$200 less compared to the reference) or \$600/acre (\$200 more compared to the reference).

+ \$20,000 ← → - \$20,000 (\$200 x 100 = \$20,000)

Table 53. Gain and loss Matrix

Gain and loss Matrix		Marketing and branded costs		
		\$200/acre	\$400/acre	\$600/acre
Price	\$15/cwt	-64,700	-84,700	-104,700
	\$18/cwt	46,300	26,300	6,300
	\$21/cwt	157,300	137,300	117,300

If the price is \$18/cwt the project is still profitable whatever marketing and branded costs are.

If marketing and branded costs are \$400/acre, the project is still profitable until the price is not under \$17.30/cwt. If marketing and branded costs are \$600/acre the equilibrium price is \$17.83/cwt.

“Tioga Farms Bros” consider they are able to get a price close to \$18/cwt.

7.1.2.8. Conclusion: What is the “Tioga Farms Bros” consider decision?

1. In terms of quantifiable elements:

“Tioga Farms Bros” note that turning their onion business model into a branded premium onion is profitable. They can expect an additional profit close to \$137,300 or \$1,373/acre

2. In terms of non-quantifiable elements:

More Pros than Cons. They know they must spend time to work with all the stakeholders of the value chain to promote their onion.

3. In terms of risks:

“Tioga Farms Bros” consider the project low risk because they are able to get a price close to \$18/cwt.

With this exercise, we provide a Decision-Making Tool that could help growers assessing a possible alternative to their decision, its costs, its benefits as well as chances of success or failure. On a more operational level, we built an Excel spreadsheet to map out all the possible alternatives to onion grower's decision.

7.2. Exploring the impact of some changes in the New York Onion Value Chain

The economic impact analysis presented in this section benefited from the critical input of David Kay, Senior Extension Associate in the Department of Global Development, which is affiliated with Cornell's College of Agriculture and Life Sciences (CALs).

7.2.1. Issues yielding an economic contributions of onion production

The key issues include the following¹⁵²:

- (1) Onion growers, but also handlers and policymakers in New York State wish to understand the onion-marketing situation and dynamics in the U.S. and especially in New York State. They wish also to understand the economic contributions of onion production to the local

¹⁵² I used multiple articles and guides to define and make this economic contributions analysis of onion production to the local economy. See:

Schmit, T. M., Jablonski, B. B. R. (2017). *A practitioner's guide to conducting an economic impact assessment of regional food hubs using IMPLAN: A systematic approach* (EB 2017-01). Ithaca, NY: Charles H. Dyson School of Applied Economics and Management, Cornell University. Retrieved from

<http://publications.dyson.cornell.edu/outreach/extensionpdf/2017/Cornell-Dyson-eb1701.pdf>

Schmit, T. M., Severson, R. M., Strzok, J., Barros, J. (2018b). *Economic contributions of the apple industry supply chain in New York State* (EB 2018-03). Ithaca, NY: Charles H. Dyson School of Applied Economics and Management, Cornell University. Retrieved from <https://dyson.cornell.edu/outreach/extension-bulletins/documents/Cornell-Dysoneb1803.Pdf>.

Schmit, T. M. (2016). *The economic contributions of agriculture in New York State (2014)* (EB 2016-09). Ithaca, NY: Charles H. Dyson School of Applied Economics and Management, Cornell University. Retrieved from

<http://publications.dyson.cornell.edu/outreach/extensionpdf/2016/Cornell-Dyson-eb1609.pdf>

Thilmany McFadden David Conner D., Deller S., Hughes D., Meter K., Morales A., Schmit T., Swenson D., Bauman A., Phillips Goldenberg M., Hill R., Jablonski B.B.R., Tropp D. (2016), *The Economics of Local Food Systems: A Toolkit to Guide Community Discussions, Assessments, and Choices*. U.S. Department of Agriculture, Agricultural Marketing Service, March 2016. Web.

Schaffer, W.A. (1999). *Regional Impact Models*. 2nd edn. Edited by Scott Loveridge and Randall Jackson. WVU Research Repository, 2020 Retrieved from

<https://researchrepository.wvu.edu/cgi/viewcontent.cgi?article=1006&context=rri-web-book>

economy. Contribution analysis can measure the gross changes in New York State economy that can be attributed to the muck onion industry.

- (2) By learning more about the muck onion industry, they aspire to identify new competitive advantage based on the strategy of differentiation, which could increase product value and share it equitably between all stakeholders in the value chain. Expansion of sales by onion operations, due to a higher willingness to pay from customers for a premium onion will mean increased sales for agricultural support firms, increased incomes for farm owners and workers, and increased sales for retail and service businesses that support the onion industry.

To address these issues, my objective is to estimate the economic impact of the onion industry in New York State.

7.2.2. Applied research Methods

According to Schmit et. al. (2018), impact analysis examines the net (marginal) change in new (or foregone) economic activity associated with an industry, event, or policy change in an existing regional economy (Schmit et al., 2018)¹⁵³.

Another possibility offered by input-output modeling systems like IMPLAN¹⁵⁴ is to estimate the overall economic contributions of local food systems or sectors to the local economy. Contribution analysis measures the gross changes in a region's existing economy that can be attributed to a given industry, event, or policy (Schmit et al., 2018). In this paper, I estimate the marginal economic contribution of possible changes in revenue to the onion sector, not the contribution of the entire existing sector.

¹⁵³ Schmit, T. M., Severson, R. M., Strzok, J., Barros, J. (2018). *Economic contributions of the apple industry supply chain in New York State* (EB 2018-03). Ithaca, NY: Charles H. Dyson School of Applied Economics and Management, Cornell University. Retrieved from <https://dyson.cornell.edu/outreach/extension-bulletins/documents/Cornell-DysonEB1803.Pdf>.

¹⁵⁴ To know more about IMPLAN, see: <https://blog.implan.com/what-is-implan>, retrieved 07/10/2021

7.2.3. The framework: Input-Output Model

In this impact analysis I use the IMPLAN¹⁵⁵ software package that allows the estimation of the multiplier effects of changes in final demand for one industry on all other industries within a given economic area. Multipliers are estimated for the entire state. The estimation of multipliers relies on input-output models like IMPLAN. Input-output modeling is based on accounting techniques that quantify key economic flows or interactions between firms, industries, and social institutions within a local economy (Mulkey and Hodges, 2004). Each sale or purchase activity within the economy (agriculture, mining, manufacturing, trade, services, etc.) is assigned to an economic sector with the number of sectors determined by the level of detail desired and for which data is available. IMPLANTM Software supplies data for 536 distinct producing economic sectors, including 14 agricultural sectors. Then, for a one-year production period, a transactions table reflects the value of goods and services exchanged between sectors of the economy. *The table 54 contains three components of the local economy which capture all transactions within the economy: producing sectors (purchasing and selling industries), final demand sectors which consume industry production and are considered to behave exogenously to the model, and value added sectors representing the portion of revenues above input costs which goes to labor, owners, and taxes* (see Mulkey and Hodges, 2004, p.3).

¹⁵⁵ IMPLAN. (2021). New York State IMPLAN data (model year 2018) and modeling software. Huntersville, North-Carolina.

Mulkey D., Hodges A. (2004), Using IMPLAN to assess local economic impact. University of Florida, Gainesville, <http://edis.ifas.ufl.edu>. 2008.07.16.

**Table 54. Hypothetical transactions table for a local economy
(Example from Mulkey and Hodges, 2004)**

	Purchasing Industries					Final Demand			Total
	Agriculture	Mining	Manufacturing	Trade	Service	Households	Government	Exports	
Selling Industries									
Agriculture	12	2	10	6	0	1	1	7	39
Mining	5	2	20	0	0	0	2	11	40
Manufacturing	5	3	6	20	5	9	10	40	98
Trade	2	3	2	1	5	25	10	5	53
Service	7	10	30	2	10	18	10	0	87
Value Added									
Indirect business									
taxes	1	2	4	4	7				
Household earnings	5	14	20	12	40				
Profits	1	2	3	4	10				
Imports	1	2	3	4	10				
Total	39	40	98	53	87	53	33	63	617

Using the simple example of Mulkey and Hodges (2004), if focusing on the agricultural sector, the total value of agricultural output is 39¹⁵⁶ (see Table 54, first row). 30 is sold as intermediate inputs to other producing industries, including 12 to agriculture, 2 to mining, 10 to manufacturing and 6 to trade. The remainder is 9 and is sold to final demand (7 to export, 1 to government and 1 to households). Then to produce its own products, agriculture purchases from other selling industries (12 from agriculture, 5 from mining, 5 from manufacturing, 2 from trade and 7 from service). The remainder is 8 value added (taxes, household earning and profits). The transactions show the way in which agriculture is linked to other sectors and final demand. While this sample “transactions” table is shown in terms of the value of output, similar tables can be constructed in terms of other economic measures like numbers of jobs. When a change in demand for products from the agricultural sector occurs, there are impacts in terms of gross output, income, employment and value added not only to agriculture, but also to the other sectors of the local economy.

¹⁵⁶ No single unit of measurement is required here, but typically, this is measured as the value of the input used or output produced (i.e. price times quantity).

According to Schmit et al., (2018, p. 40), *gross output is the value of industrial production in producer prices. For manufacturing sectors, it equals the value of sales plus changes in inventory, for service sectors, it equals sales, and for wholesale and retail sectors, it equals the gross margin (i.e., sales less the purchase cost of the goods sold). Labor income is the sum of employee compensation (i.e., total payroll cost) and proprietor income (i.e., income to self-employed and unincorporated business owners). Within IMPLAN™, employment is the average number of employee positions throughout a year, with no distinction made between full and part-time positions*¹⁵⁷.

Thus, it is possible to calculate multipliers that estimate three components of total change within a specified economic region (Mulkey and Hodges, 2004):

- Direct effects represent the initial change in one or more industries;
- Indirect effects are changes in inter-industry transactions as supplying industries respond to increased demands from the directly affected industries;
- Induced effects reflect effects of increased consumer spending resulting from direct and indirect income changes.

Mulkey and Hodges (2004) provide a clear explanation of how to analyze multipliers of which there are many and which can be calculated in different ways. Within IMPLAN¹⁵⁸, an industry output multiplier of 1.5 estimates that a change in sales to final demand of \$1.00 by the industry in question would result in a total change in local output of \$1.50 - the original or direct change plus an additional \$0.50. An income multiplier of 1.5 indicates for every \$1.00 change in income in the industry directly affected, there will be a corresponding income change totaling \$1.50 in the local economy as a whole. Similarly, an employment multiplier of 1.5 indicates that the creation of one new direct job will result in a total of 1.5 jobs in the local economy. Other value added multipliers are constructed like income multipliers. They relate changes in value added in the industry experiencing the direct effect to total changes in value added for the local economy.

¹⁵⁷¹⁵⁷ See <https://blog.implan.com/interpreting-employment-impacts> for how IMPLAN calculates jobs.

¹⁵⁸ See <https://blog.implan.com/understanding-implan-multipliers> for the way IMPLAN calculates multipliers.

7.2.4. The Muck onion industry and assumptions to apply the Input-Output Model

The impact evaluation is based on hypothetical scenarios to illustrate to onion growers and handlers the economic significance of strategies that could be developed in multiple onion growing counties in New York State. The economic region defined for purposes of the analysis includes the geographic area (New York State) from which the strategy is primarily expected to draw workers.

My approach is organized as follows:

I estimate the economic impact in New York State of two main changes in the muck onion sector using IMPLAN:

- The first change assumes an increase in onion prices, and therefore value of onion sales, at the farm gate in New York due to the existence of a higher value New York pungent onion brand. I assume no changes in costs. I call this first change, the branded onion scenario.
- The second change assumes onion growers would reduce onion production by the exact amount of current production and would instead grow corn, a less labor-intensive crop. I call this second change, the “shift to corn” scenario.

To implement this evaluation, I had to address two technical issues.

The first technical issue is that IMPLAN does not provide onion sector data. Onions are pooled in the vegetable sector. The vegetable sector is structured around 10 critical vegetables (Table 55). In New York State these 10 key vegetables use 105,000 acres out of the 125,000 acres (or 84%) occupied by all vegetable productions (54 vegetables¹⁵⁹). Out of these 10 vegetables, onion production (7,200 acres) uses 7% of the acreage (the 10 main vegetables, 105,000 acres) but represents 15% of the output gross sales (\$) and 13% of the volumes (cwt). No key vegetable would have a disproportionate impact on the production function because many contribute to

¹⁵⁹ USDA, National Agricultural Statistics Service, 2017 Census of Agriculture – State Data (New York), Table 36. Vegetables, Potatoes and Melons Harvested for Sale: 2017

the total, including five of the ten account which each account for between 10-20% of the value of output¹⁶⁰.

Table 55. The ten main vegetables production in New York in 2018/2019 (USDA, NASS)¹⁶¹

	Potato	Pumpkin	Cucumber	Green peas	Bell Pepper	Cabbage	Snap beans	All squash	Sweet Corn	Onion NY	Vegetables Top10
Output \$Million	47	8	14	3.5	8.5	54	35	24	36	41	271
Area Harvested Acre	13,000	5,700	3,300	6,800	1,400	10,000	26,000	4,900	26,700	7,200	105,000
Production 1000 Cwt	3,886	467	396	248	154	4,040	2,104	808	2,793	2,160	17,056
Output \$Million - %	17%	3%	5%	1%	3%	20%	13%	9%	13%	15%	100%
Area Harvested Acre - %	12%	5%	3%	6%	1%	10%	25%	5%	25%	7%	100%
Production Cwt - %	23%	3%	2%	1%	1%	24%	12%	5%	16%	13%	100%

The second technical issue concerns the absence of a production function for onions in New York. According to Schmit et al., (2018), when conducting an economic impact or contribution analysis in IMPLAN, it is important to consider when the existing industry parameters that represent its spending activities are appropriate for analysis and when those parameters should be updated through supplemental data collection. Production functions in IMPLAN (intermediate inputs and outlays to value added per dollar of output) are based on primary data collected nationally by industry, then weighted by IMPLAN to better reflect regional production. Even at the national level, each industry sector reflects a weighted average of all inputs used to produce the inherently still diverse mix of products aggregated into a single industry sector. Accordingly, these weighted averages most closely reflect the production technologies and inputs of firms that contribute a relatively large proportion of total output to a sector (i.e., typically large firms). For example, a production function of a New York vegetable sector comprised of the ten vegetables shown in

¹⁶⁰ The production function characterizes the output of a firm given the inputs it uses. According to Britannica, **Production function**, in economics, is represented as an equation that expresses the relationship between the quantities/values of productive factors (such as labor and capital) used and the amount/value of product obtained. It states the amount of product that can be obtained from every combination of factors, assuming that the most efficient available methods of production are used. Only if the value and mix of inputs for a number of the five vegetables dominating by value of output varied in unusual patterns would a single one of them dominate at the aggregated sector's production function. Retrieved from <https://www.britannica.com/topic/production-function>

¹⁶¹ USDA, National Agricultural Statistics Service, (2020), New York Agricultural Statistics Annual Bulletin, 2018 – 2019, Northeastern Regional Field Office, 56 p. & USDA, National Agricultural Statistics Service, (2019), Vegetables 2018 Summary, February 2019

Table 55 would more accurately reflect the production input mix used to grow and market cabbages or potatoes or onions than it would peas or peppers. Similarly, with each sector represented by only a single production function, any New York “onion sector” production function would be much more heavily influenced by the technology, or input-output relationships, used on some large onion farms in a County than it would be by medium-sized farms in another County.

Clearly, from one farm to another there will be differences in climate, soils (even if it is muck soil in each county), and production practices. The latter are probably an instrumental source of heterogeneity. Growers do not use the same combination of factors. Some can use low-input farming practices while other uses large amounts of inputs per habit. Moreover, operations have different production systems. Some farms are specialized in onion production and may have economies of scale, while others produce a wide range of products (vegetables, crops, livestock) and may have economies of range. Their costs of production are likely different. The solution to this issue could be to collect primary data on these costs. However, this option has not been possible, given the challenges of obtaining this data from growers, handlers and others sector to calculate more verifiable input coefficients. Schmit et al., (2018) encountered this difficulty for their case study of the apple sector in New York State.

Nevertheless, I have collected costs of production (secondary data) in New York and Pennsylvania for the 10 main vegetables grown in New York. I have primarily used Pennsylvania data because this data is available and the state is adjacent to New York and has similar weather conditions. Pennsylvania Cooperative Extension¹⁶² has constructed a wide range of sample budgets for multiple vegetables. I adjusted this data with surveys from a few New York onion growers. I then

¹⁶² For example, for onions, it is possible to find an article dedicated to onion production, practices, budget, etc. This article has been written by Elsa Sánchez, professor of horticultural systems management; Thomas Ford, extension educator; Lynn F. Kime, senior extension associate in agricultural economics; Jayson K. Harper, professor of agricultural economics; Michael D. Orzolek, professor emeritus of horticulture; and R. Matthew Harsh and Chesley Farms, PennStet Extension, updated in October 23, 2020, retrieved from <https://extension.psu.edu/onion-production> and from <file:///C:/Users/pjeannea/AppData/Local/Temp/sample-onion-production-budget.pdf>

computed this data to calculate an average weighted cost for the whole, based on the importance of each vegetable according to its gross output. Next, I have compared this average weighted cost of production by input category to the onion cost of production. This permits me to measure the gap between an average weighted cost of the 10 vegetables and the cost of production for onions (Table 56). Overall, total costs for vegetables and for onions differ by only 1% (\$4,540/\$4,517), though specific items differ on average by less than 10%. The main cost gap is for pesticides, which differ up to minus 22%. However, pesticides only account for similar and smallish proportions of total variable costs for both the weighted sector (16% (657/4,109)) and the onion sector on its own (19% (800/4,140)). The average cost of production for onions overall is similar to that for vegetables, as well as the breakdown of the costs.

Therefore, given my analysis that the production function for onions and vegetables are similar (Table 56), it seems justifiable to use IMPLAN’s vegetable sector production function as a proxy for the production function for onions.

Table 56. Cost of production comparison for the 10 main vegetables produced in New York (Sources: PennState Extension & New York Onion growers’ survey)

	Potato	Pumpkin	Cucumber	Green peas	Bell Pepper	Cabbage	Snap beans	All squash	Sweet Corn	Onion NY	Weighted costs/\$ output	Costs /output gap
Plants - Veg Sets	400	90	2710	150	2900	700	200	100	150	500	468	-7%
Fertilizers	300	210	100	180	100	600	150	200	100	300	304	1%
Pesticides	1165	600	580	200	450	520	250	500	460	800	657	-22%
Other operating costs (Irrig)	170	600	600	100	1000	600	50	600	260	350	343	-2%
Energy	171	163	138	70	130	150	50	150	120	120	132	9%
Maintenance	90	100	100	50	100	120	50	100	100	90	94	5%
Ope+Harvest+grading labor	780	1200	2500	200	3150	2000	150	1300	400	1000	1046	4%
Packaging+Marketing	1000	1370	1250	100	4000	1800	50	1500	220	900	986	9%
interest on operating capital	94	70	100	50	100	100	50	70	50	80	79	-2%
Total variable costs	4170	4403	8078	1100	11930	6590	1000	4520	1860	4140	4109	-1%
Total Fixed costs	430	430	410	150	690	500	180	500	400	400	408	2%
Total costs	4600	4833	8488	1250	12620	7090	1180	5020	2260	4540	4517	-1%

Transactions data like that shown in Table 54 (above) can be transformed into “per dollar of output” units or “input coefficients” that reflect the technology mix used for production in each industry. An input coefficient is defined as, “The dollar value of a Commodity required directly by

an Industry to produce a dollar of Output. It is also referred to as the direct requirement coefficient”¹⁶³.

Secondary data from USDA (NASS, Census 2017) suggest that the majority of farms participating in onion industry are mid-scale or large (Table 57).

Table 57. Farms and acreage in New York (Census 2017, 2012, 2007, 2002) USDA

(Census USDA)	2017 NYS All Vegetables and Potatoes	2017 NYS Onions
Farms	3,544	558
Acres	124,859	6,606
Operations<5 acres Total Acreage Average size (acres/operation)	2,164 operations (61%) 3,591 acres (2.9%) 1.2 acre/farm	507 operations (90.8%) 201 acres (3%) 0.40 acre/farm
5 Acres <Operations <100 acres Total Acreage Average size (acres/operation)	1,161 operations (32.8%) 25,654 acres (20.5%) 22.1 acres/farm	31 operations (9.2%) 1,230 acres (18.6%) 39.7 acres/farm
Operations > 100 Acres Total Acreage Average size (acres/operation)	219 operations (6.2%) 95,611 acres (76.6%) 436 acres/farm	20 operations (3.6%) 5,175 acres (78.4%) 258.8 acres/farm

I am aware that sectoral information is only available on an aggregate basis for an industry sector (such as vegetables), which often limits the extent to which the activities of a specific product (such as onion) can be accurately analyzed. Therefore, the reader should keep in mind this important limitation of this evaluation.

7.2.5. Implementation of scenarios and data

I estimate the economic impact assessments of two assumed changes in the muck onion sector.

¹⁶³ Input coefficient definition, retrieved from <https://support.implan.com/hc/en-us/articles/115009666928-Input-Coefficient>

7.2.5.1. Scenario to estimate the economic impact of the branded onion scenario

This first scenario is an increase in onion sales at the farm gate in New York. This reflects the opportunity to develop a strategy of differentiation via a new premium branded onion. I simply shock the vegetable sector of IMPLAN through an increase of the value of onions (+35%) in the vegetable sector of New York State to measure how that increase impacts income, other forms of value added and jobs.

In this scenario, I assume the following¹⁶⁴:

1. All of New York State's 7,200 acres of onions are now receiving a premium price at farm gate.
2. The non-marketable quantity is 50 hundredweights/acre. This volume is used to feed livestock. These onions are sold for \$30/ton (or \$1.5/ hundredweight).
3. Onion premium prices at the farm gate rise by 35% (this is the difference observed between a standard onion and a premium onion such as Vidalia).
4. Both the standard onion and the premium onion have the same total yields (at the field), and utilize the same production practices. However, the marketable quantity for premium onions is lower than for standard onions. Indeed, grading for premium onions excludes 12 % instead of 10%, thus marketable yielding 370 hundredweights/acre instead of 378 hundredweights/acre.
5. Three types of onion are produced, whether at premium prices (shown) or standard prices (Table 58):

Table 58. Onion Characteristics

Size	Portion of the gross production	Price per bag	Price per cwt
Two-inches	30%	\$7.5	\$15
Medium	50%	\$11.5	\$23
Jumbo	20%	\$12.5	\$25

¹⁶⁴ I used the same data than for the partial budget analysis in the previous section (7.1).

The weighted price of branded onions in this scenario is \$21/ hundredweight, instead of \$15.5/hundredweight, a 35% surplus of \$5.5/hundredweight.

Scenario 1 Calculations:

- The addition to the value of gross output that impacts the onion sector is:
 $(21.5 - 15.5) * 370 * 7,200 = \14.65 Million
- Non-Marketable quantity is 50 hundredweights/acre (instead of 42 hundredweights/acre for standard onion). The price is \$1.5/ hundredweight. The surplus to take into account is:
 $1.5 * 50 * 7,200 = \$540,000$
- The surplus of gross output that impacts the onion sector is: $14,650,000 + 540,000 = \$15,190,000$
- I consider the gross output is **\$15.2 Million** for 2018.
- I set up a branded onion activity. The type of activity is “Industry Change”. I create a new event within the vegetable sector, assuming onions have the same impacts as the vegetable sector¹⁶⁵
- Dollar year is 2018. IMPLAN Sector 3: Vegetable and melon farming
- The analysis is for a single region: New York State

7.2.5.2. Settings to estimate an economic impact of the “Shift to corn” scenario

In the “shift to corn scenario”, onion growers would stop to produce onion and would decide to produce corn instead. This assumption reflects the decline of onion production from farmers who would like to grow crops less labor intensive.

Scenario 2 “Shift to corn” scenario Calculations:

¹⁶⁵ I am aware that my other assumptions indicate more or less that farmer revenues increase by \$15.2 million due to a price increase. Hence, expenditures on inputs haven’t changed, more or less. Instead, one component of value added (proprietor compensation) has increased. To be consistent, I’d need to specify what proprietors choose to do with that increased income. Spend it on consumer goods? Pay off debt? Expand their operations and increase production? I don't know their choices due to the lack of a stakeholder survey to get more details about their rationality. However, since the IMPLAN model assumes prices are fixed, if growers expand their business they will spend more inputs to increase the quantity of onions sold.

First, for this scenario the followings settings were used to create the onion sector, based on USDA, annual statistics bulletin¹⁶⁶ (Table 59).

- I estimate the size (value of output) of the onion industry in New York State.
- I assume the vegetable sector declines by an amount equal to the value of the onion sector's gross output in 2018, that is to say **\$41 Million**
- I assume growers change their crop rotation to produce grains (such as corn) on the 7,200 acres left by the onion
- Onion production is volatile from year to year (Table 59). 2018 was similar to 2015 and 2017 was outstanding. For the last four year, on average, the gross output is about \$45 Million.

Table 59. Onions production at farm gate - USDA, NASS, (2020), New York Agricultural Statistics Annual Bulletin, 2018

Dry Onions Area Planted and Harvested, Yield, Production, Price, and Value – New York: 2014-2018

Year	Area planted	Area harvested	Yield per acre	Total production	Harvested not sold	Utilized production	Price per cwt ¹	Value of utilized production
	<i>acres</i>	<i>acres</i>	<i>cwt</i>	<i>1,000 cwt</i>	<i>1,000 cwt</i>	<i>1,000 cwt</i>	<i>dollars</i>	<i>1,000 dollars</i>
2014.....	(NA)	(NA)	(NA)	(NA)	(NA)	(NA)	(NA)	(NA)
2015.....	7,800	7,500	345.0	2,588.0	(NA)	(NA)	17.60	40,533
2016.....	7,200	7,000	310.0	2,170.0	-	2,170.0	21.50	46,655
2017.....	7,000	6,900	440.0	3,036.0	415.9	2,620.1	19.30	50,682
2018.....	7,400	7,200	300.0	2,160.0	51.8	2,108.2	19.50	41,042

- Represents zero.

(NA) Not available.

¹ Marketing year average price.

- For this simulation of the economic contribution, I consider the gross output is **\$41 Million** for 2018. This value is consistent with the situation presented above in the report in subsection 7.1. where I used the followings settings:
 - **Yield Standard Yellow onion: 378 cwt/acre**
 - **Price per cwt: \$15.50**
 - Harvested area: 7,200 acres
- Gross output is: $7200 \times 378 \times 15.50 = \42.18 Million.

¹⁶⁶ USDA, National Agricultural Statistics Service, (2020), New York Agricultural Statistics Annual Bulletin, 2018 – 2019, Northeastern Regional Field Office, 56 p.

- Dollar year is 2018.
- Sector: Vegetable and melon farming (3)
- The analysis is for a single region: New York State

Second, the followings settings were used to create this new activity (corn production), based on USDA, annual statistics bulletin¹⁶⁷ (Table 60).

- For corn:
 - **Yield Corn: 159 Bushels/acre**
 - **Price per Bushel: \$4.10**
 - Harvested area: 7,200 acres
- Gross output is: $7200 \times 159 \times 4.10 = \4.693 Million.
- For this scenario, I consider grain sector (2) increases its gross output of **\$4.7 Million** for 2018.

Table 60. Corn production at farm gate - USDA, NASS, (2020), New York Agricultural Statistics Annual Bulletin, 2018

Corn for Grain Area Planted and Harvested, Yield, Production, Price, and Value – New York: 2014-2018

Year	Area planted ¹	Area harvested	Yield per acre	Production	Price per bushel ²	Value of production ³
	<i>1,000 acres</i>	<i>1,000 acres</i>	<i>bushels</i>	<i>1,000 bushels</i>	<i>dollars</i>	<i>1,000 dollars</i>
2014	1,140	680	148.0	100,640	4.11	413,630
2015	1,080	590	143.0	84,370	4.01	338,324
2016	1,100	570	129.0	73,530	3.90	286,767
2017	1,000	485	161.0	78,085	4.07	317,806
2018	1,100	645	159.0	102,555	4.10	420,476

¹ Area planted includes corn planted for both grain and silage.

² Marketing year average price.

³ Based on final State marketing year average price for years prior to 2018; for 2018, based on preliminary State marketing year average price.

- Dollar year is 2018.
- Sector: Vegetable and melon farming (3)
- The analysis is for a single region: New York State

¹⁶⁷ USDA, National Agricultural Statistics Service, (2020), New York Agricultural Statistics Annual Bulletin, 2018 – 2019, Northeastern Regional Field Office, 56 p.

7.3. Results

7.3.1. Scenario 1: The branded onion scenario, an economic impact of changes in the onion sector

7.3.1.1. *Impact Estimates*

We estimate the impact of the branded scenario corresponding to a new brand that is able to generate a gross output surplus of \$15.2 million.

In this scenario, the direct effect is \$15.2 million and the creation of 185 new jobs. The increase of labor income is \$5.3 million and the value added has gone up over \$8 million (Table 61). The total direct gross output supports an additional \$6.2 million in indirect effect and \$5.8 million in induced effect. In other words, creating \$15.2 million at farm gate generates over \$12 million of indirect and induced effects.

Direct effects account for the largest portion of the total economic impact in each impact category. It is 56% of total output, 76% of employment, 55% of labor income and 53% of value-added. For Indirect effects, the portion is approximately 22% of output, of labor income and of value added, and 15% of employment. Induced effects account for approximately 21% of total output, 13% of employment, 25% of value-added, and 22% of labor income.

I have presented the results with the same rationale as Schmit et al. (2018b¹⁶⁸). The Impact output multiplier for the branded onion scenario at farm gate in New York State is 1.79. This is the sum of the direct, indirect, and induced effects divided by the direct effect. A multiplier of 1.79 means that for every dollar generated in the onion farm, \$0.79 is generated in backward¹⁶⁹ linked (non-

¹⁶⁸ Schmit, T. M., Severson, R. M., Strzok, J., Barros, J. (2018b). *Economic contributions of the apple industry supply chain in New York State* (EB 2018-03). Ithaca, NY: Charles H. Dyson School of Applied Economics and Management, Cornell University.

¹⁶⁹ Backward linkages characterize the relationship of an industry or institution with its supply chain. An Industry has significant backward linkages when its production of output requires substantial Intermediate Inputs from many other industries within the same study area. In the standard I-O model, Type I multipliers are measures of such backward linkedness. They include only "indirect" impacts. Type SAM multipliers expand on these inter-industry

onion) industries. The sum in value for Indirect and induced effects is \$12.028 million (respectively \$6.227million and \$5,801 million). Decomposing the multiplier effect (0.79) into its indirect and induced components, the indirect effect is 0.41 (from business-to-business activity) and the induced effect is 0.38 (from labor income spending). As a comparison, the contribution output multiplier calculated for farm production within the apple industry in New York in 2016 was 1.81, which was weighted slightly more towards indirect effects (0.36) than induced (0.45) (Schmit et al., 2018b) (Table 61).

Table 61. Economic Impact of scenario 1: a new premium branded onion within vegetable industry in New York State, 2018 dollars

ImpactType	Direct Effect	Indirect Effect	Induced Effect	Total Effect	Impact Multiplier
Output (\$1,000)	15,200	6,227	5,801	27,229	1.79
Employment # workers	185.2	40.0	33.3	258.6	1.40
Labor Income (\$1,000)	5,335	2,227	2,153	9,714	1.82
Total Value Added (\$1,000)	8,138	3,438	3,782	15,358	1.89

Source: IMPLAN (2018), author calculations, and presentation of definition by Schmit and al., 2018b
 Direct effects represent total activity (sales, employment, labor income, value added) by the respective industry.

Indirect effects represent all activity by the backward-linked supply chain industries.

Induced effects represent additional industry activity due to consumption out of labor income.

The impact employment multiplier is 1.40 and lower than the other multipliers. A gross output of \$15.2 million generates as a direct effect the equivalent at 185.2 jobs. In other words, one job is created when \$82,073 of output are generated. As a comparison, for the apple industry in New York in 2016, for farm production, one job is created when \$56,556 of output are generated (\$317 million for 5,605 jobs). Therefore, in New York State onion farm production it takes 1.45 time more output to create a job. A simulation done within the grain sector suggests that a gross output of \$15.2 million generates as direct effect the equivalent at 88.6 jobs, or \$171,578 to create one job. A last simulation done within the dairy cattle and milk production sector at farm gate suggests that a gross output of \$15.2 million generates as direct effect the equivalent at 46.5

linkage effects to include effects associate with changes in income to households and associated household spending. Retrieved from <https://support.implan.com/hc/en-us/articles/115009497627-Backward-Linkage>

jobs, or \$326,880 to create one job, showing this sector has probably made huge and higher gains of labor productivity over the last year than for the other agricultural sectors.

Now, when we consider total value added, which includes labor income, but also other property type income (e.g., corporate profits, capital consumption, interest), and government taxes and fees (Schmit et al., 2018), the new premium onion industry contributes \$8.138 million to the state's total Gross Domestic Product¹⁷⁰ through its direct activity. There are additional indirect and induced contributions of \$3.438 million and \$3.782 million, respectively. This implies that for every dollar of GDP contributed by the new demand at farm gate for a branded premium onion, an additional \$1.89 are generated in backward linked industries. As a comparison, the total value added multiplier for apple farm production is 1.83, 1.69 for grain farming and 2.00 for dairy cattle and milk production.

7.3.1.2. *Distribution of Impacts*

While Table 58 above provides the impact of indirect and induced effects as a result of a new demand at farm gate for a premium branded onion, input-output analysis is especially well suited to scrutinize what industries contribute to those effects. The IMPLAN model allows us to determine the distribution of total impacts across other sectors of the local economy. The total impacts are reported in Table 62, which depicts the breakdown across the 10 sectors that are most impacted.

Of course, the largest output impact occurs in the vegetable farming sector, the sector where the direct impact takes place (Table 62). The second ranked output impact is "Other Real estate" (447). This sector includes the value of operations for residential property managers, lessors of nonresidential buildings, and offices of real estate agents and brokers (offering services other than residential leasing).

¹⁷⁰ Indeed, the total Gross Domestic Product (GDP) corresponds to the sum of *value added* at every stage of production (the intermediate stages) for all final goods and services produced within a region.

In terms of impact on employment, “Support activities for agriculture and forestry is a sector experiencing major impacts by providing job 18 jobs, following by “Other real estate” (6 jobs). Other impacted sectors include a range of sectors providing goods and services to local residents who earn increased income as a result of the branding scenario (Table 62).

Table 62. Estimated changes in Ten most impacted sectors with the scenario 1: a branded onion scenario within vegetable industry in New York State, 2018 dollars

Rank / Output	Sector	Description	Total Output (\$1,000)	Total Employment # workers	Total Labor Income (\$1,000)	Total Total Value Added (\$1,000)
1	3	Vegetable and melon farming	15,331	186.9	5,381	8,208
2	447	Other real estate	1,445	6.8	324	661
3	19	Support activities for agriculture and forestry	710	18.0	643	575
4	400	Wholesale - Other nondurable goods merchant wholesalers	703	1.9	206	444
5	449	Owner-occupied dwellings	655	0.0	0	518
6	170	Pesticide and other agricultural chemical manufacturing	590	0.4	34	109
7	444	Insurance carriers, except direct life	418	0.5	64	231
8	490	Hospitals	379	1.9	189	221
9	441	Monetary authorities and depository credit intermediation	310	0.3	43	268
10	47	Electric power transmission and distribution	223	0.2	27	95

Indirect and induced impacts take place in other sectors of the local economy. Figure 77 provides the top ten distribution of indirect and induced effects, by industry, generated by the branded onion scenario (direct activities). The distribution is provided for output.

Other real estate has the highest backward linkage in terms of output, as seen before. Then, support activities for agriculture, wholesale and agricultural chemical manufacturing. This makes intuitive sense because many inputs and services purchased by farms come from sectors that are

strongly linked to agriculture. Most of the impacts are derived from indirect effects. However, the induced effects are equivalent to the indirect effects for the insurance and banking sectors.

Figure 77. Indirect and induced output effects from demand at farm gate for a branded onion scenario, New York, dollars 2018

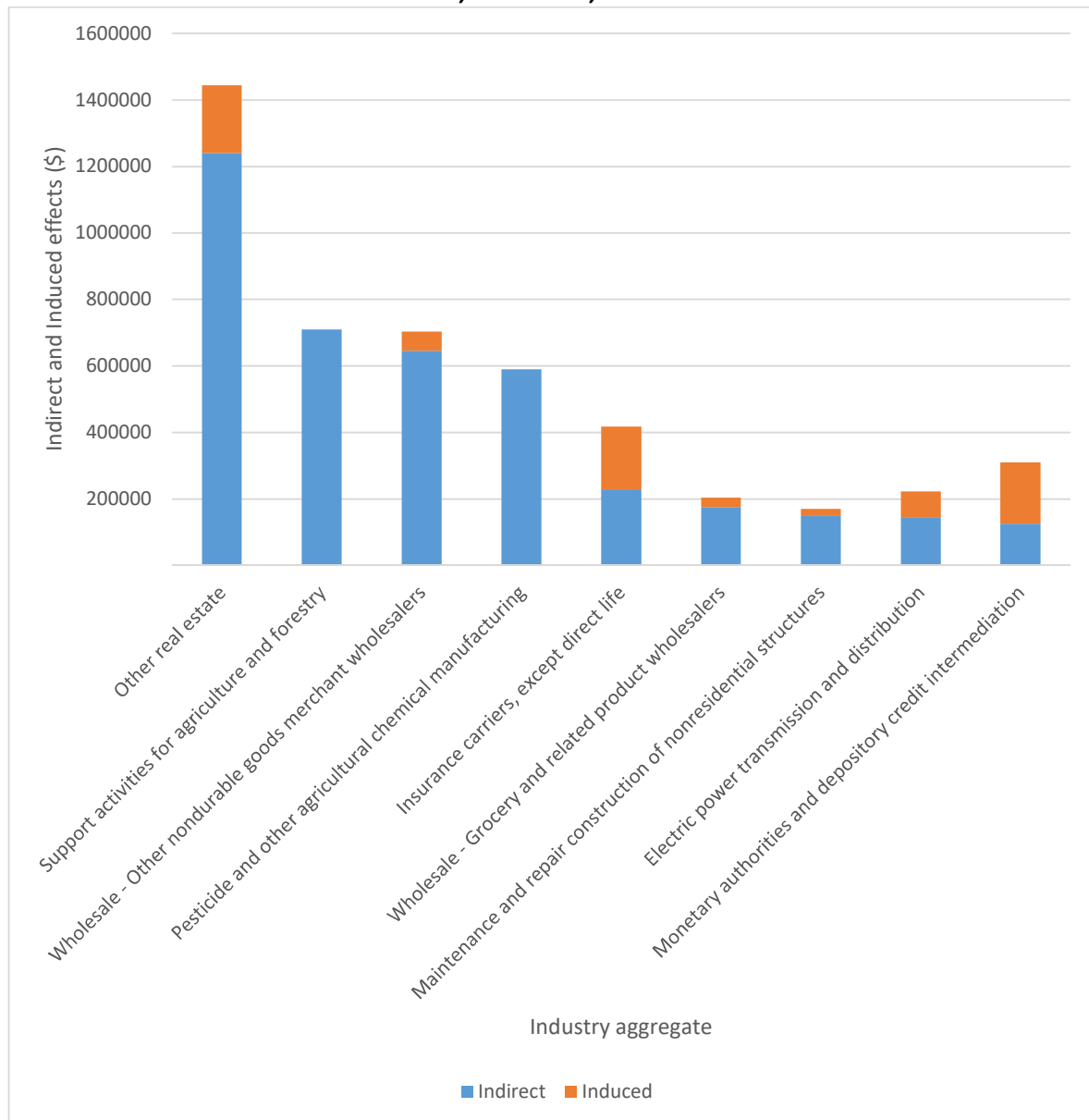

This result should be interpreted with caution. IMPLAN uses an algorithm and industry averages that may not correspond to the reality of a specific situation. If the gross sale of production increases, producers could change the allocation of this surplus and increase their income instead

of investing more or hiring more workers. IMPLAN replicates the current production function for the sector on average and does not create a new one.

7.3.2. Scenario 2: The “Shift to corn” scenario, an economic impact of changes in the onion sector

7.3.2.1. *Impact Estimates*

I have also analyzed the impact of the “shift to corn scenario”.

In this scenario, the onion sector loses a gross output of \$41 million and the grain farming sector increases its acreage about 7,200 acres to generate a new gross output of \$4.7 million. As a result, the agricultural industry overall loses a gross output close to \$36.3 million (Table 63).

In this scenario, the direct effect is a loss of \$36.3 million and a loss of 472 jobs. The decrease of labor income is \$13 million and the value added has gone down over \$19 million.

The total direct gross output yields to a negative \$15.1 million in indirect effect and \$14.1 million in induced effect. In other words, losing \$36.3 million at farm gate destroys over \$29.2 million of indirect and induced effects.

I have depicted the results with the same rationale as Schmit et al. (2018b) (Table 63). The impact output multiplier for the case of a shift away from onion production on the farm in New York State is 1.80. This is the sum of the direct, indirect, and induced effects divided by the direct effect. A multiplier of 1.80 means that for every dollar generated in the onion farm, \$0.80 is generated in backward linked (non-onion) industries. Decomposing the multiplier effect (0.80) into its indirect and induced components, the indirect effect is 0.41 and the induced effect is 0.39. As I said in subsection 3.1., as a comparison, the contribution output multiplier calculated for farm production within the apple industry in New York in 2016 was 1.81, which was weighted slightly more towards indirect effects (0.36) than induced (0.45) (Schmit et al., 2018b).

Table 63. Economic Impact of scenario 2: The end of onion within vegetable industry in New York State, 2018 dollars

ImpactType	Direct Effect	Indirect Effect	Induced Effect	Total Effect	Contribution Multiplier
Output (\$1,000)	-36,300	-15,098	-14,105	-65,502	1.8
Employment # workers	-472.2	-97.4	-81.0	-650.7	1.38
Labor Income (\$1,000)	-13,024	-5,421	-5,232	-23,677	1.82
Total Value Added (\$1,000)	-1,9171	-8,344	-9,194	-36,708	1.91

Source: IMPLAN (2018), author calculations

The impact employment multiplier is 1.38 and lower than the other multipliers meaning that one job is loss when \$76,906 of gross output are lost at farm gate. Note that a decline of the gross output (minus \$36.3 million) has a negative direct effect on jobs with the equivalent at 472 jobs lost.

Now, when we consider total value added the onion production shift away contributes to a negative effect on the state's total Gross Domestic Product¹⁷¹ (\$19.17 million). This implies that for every dollar of GDP lost by the onion production shift away at farm gate, an additional \$0.91 is generated in backward linked industries. As a comparison, the total value-added multiplier for apple farm production is 0.83, 0.69 for grain farming and 1.00 for dairy cattle and milk production.

7.3.2.2. *Distribution of Impacts*

While Table 63 above provides the impact of indirect and induced effects because of a new demand at farm gate for corn rather than for onion, input-output analysis is especially well suited to scrutinize what industries contribute to those effects. The IMPLAN model allows determining the distribution of total impacts across other sectors of the local economy. The total impacts are reported in Table 8 and depicts the breakdown across the 10 sectors that are most impacted.

Of course, the largest output negative impact occurs in the vegetable farming sector, the sector where the direct impact took place (Table 64). The second sector the most impacted in terms of

¹⁷¹ Indeed, the total Gross Domestic Product (GDP) corresponds to the sum of *value added* at every stage of production (the intermediate stages) for all final goods and services produced within a region.

output concerns grain farming. This positive impact only slightly offsets the decrease in onion production (approximately 10%). The third one corresponds to “Other Real estate” (447). This sector includes the value of operations for residential property managers, lessors of nonresidential buildings, and offices of real estate agents and brokers (offering services other than residential leasing).

The other sector experiencing major negative impacts in terms of total employment (losing jobs and related services) is “Support activities for agriculture and forestry” (minus 44 jobs) and “Other real estate” (minus 16 jobs). Other impacted sectors include a range of sectors losing goods and services sales to local residents who earn less income as a result of the decline of onion production (Table 64).

Table 64. Estimated changes in Ten most impacted sectors with the scenario 2: an onion shift away in New York State, 2018 dollars

Rank / Output	Sector	Description	Total Output (\$1,000)	Total Employment # workers	Total Labor Income (\$1,000)	Total Total Value Added (\$1,000)
1	3	Vegetable and melon farming	-41,350	-504	-14,512	-22139
2	2	Grain farming	+ 4,704	+27	+1,367	+2,783
3	447	Other real estate	-3,375	-16	-756	-1,545
4	19	Support activities for agriculture and forestry	-1,738	-44.0	-1,573	-1,406
5	400	Wholesale - Other nondurable goods merchant wholesalers	-1,670	-5	-490	-1,055
6	449	Owner-occupied dwellings	-1,591	0		-1,259
7	170	Pesticide and other agricultural chemical manufacturing	-1,438	-1	-82	-267
8	444	Insurance carriers, except direct life	-1,048	-1	-161	-579
9	490	Hospitals	-920	-5	-458	-537
10	441	Monetary authorities and depository credit intermediation	-744	-1	-103	-645

Indirect and induced negative impacts take place in other sectors of the local economy. Figure 78 provides the top ten distribution of indirect and induced negative effects, by industry, generated by the end of onion production (direct activities). The distribution is provided for output.

Other real estate has the highest backward linkage as seen before. Then, support activities for agriculture, wholesale and agricultural chemical manufacturing. This makes intuitive sense because many inputs and services purchased by farms come from sectors that are strongly linked to agriculture. Most of the impacts are derived from indirect effects. However, the induced effects are equivalent to the indirect effects for the insurance and banking sectors. There is also a low negative indirect impact on vegetable farming. A positive impact comes from grain farming, but is extremely low (\$5,900 for indirect impact and a negative induced impact close to \$1,300).

This result should be interpreted with caution. IMPLAN uses an algorithm and industry averages that may not correspond to the reality of a specific situation. If the gross sale of production increases, producers could change the allocation of this surplus and increase their income instead of investing more or hiring more workers. IMPLAN replicates the current production function for the sector on average and does not create a new one.

Figure 78. Indirect and induced output effects from demand decline at farm gate for onion, New York, dollars 2018

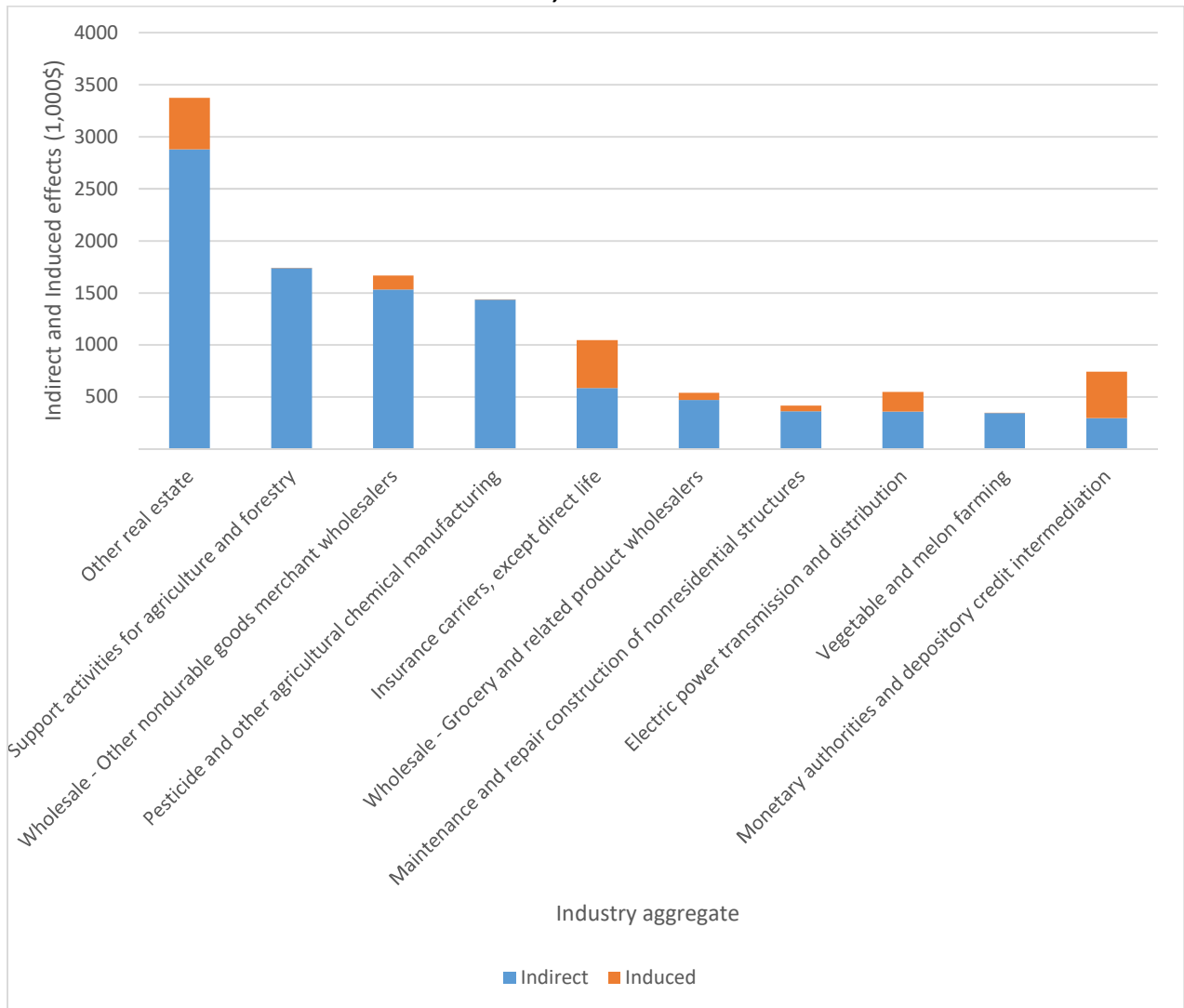

7.4. Summary of Section 7

- ✓ A cost/benefit analysis at the farm gate suggests that, depending on the unique circumstances of individual farms, there is the potential to produce and market premium yellow onions on the remaining onion growers' farms in New York State.
- ✓ At the farm gate, turning the muck onion business model into a branded premium onion is profitable.

- ✓ If onion production within the onion sector lost its \$41 million gross output to the grain crop sector, which would increase its acreage by approximately 7,200 acres to generate \$4.7 million in new gross output, the direct effect would be a loss of \$36.3 million and a loss of 472 jobs. The decrease in labor income would be \$13 million and value added would decrease by over \$19 million.
- ✓ In addition to the loss of GDP for New York State, the negative consequences would impact landowners and providers of services and inputs to agriculture. As an example, the support activities for agriculture and forestry would lose 44 jobs (e.g., extension educators, researchers, research support employees, and the like) and \$1.5 million labor income.
- ✓ In the branded onion scenario, growers are able to generate a gross output surplus of \$15.2 million. In this scenario, the direct effect is \$15.2 million and a creation of 185 new jobs. The increase of labor income is \$5.3 million and the value added has gone up over \$8 million.
- ✓ The total direct gross output supports an additional \$6.2 million in indirect effect and \$5.8 million in induced effect. In other words, creating \$15.2 million at farm gate generates over \$12 million of indirect and induced effects.
- ✓ The output multiplier for the branded onion scenario at farm gate in New York State is 1.79. For every dollar generated on onion farms, \$0.79 is generated in backward linked (non-onion) industries. As a comparison, the contribution output multiplier calculated for farm production within the apple industry in New York in 2016 was 1.81.
- ✓ In this scenario one job within is created when \$82,073 of output are generated. For apple farming it is \$56,556; \$171,578 for grain sector and \$326,880 for dairy cattle and milk production.
- ✓ The branded onion scenario shows the onion industry contributes \$8.138 million to the state's total Gross Domestic Product through its direct activity.
- ✓ In the branded onion scenario, the same sectors are impacted as in the "shift to corn scenario", but positively.

General Conclusion

Key Observations

This conclusion highlights the key findings of my study of the New York State and U.S. onion industries and how they have evolved over the past several decades. I also suggest recommendations.

Onion growers in New York State wish to understand onion-marketing dynamics in the U.S. and especially in New York State. By learning more about the market for onions, they aspire to identify new competitive advantage based on the strategy of differentiation, which could increase their value and share it equitably between all stakeholders of the value chain. To support the transition towards this new collective action strategy, this Working Paper Summary provided a secondary data analysis of the onion industry in the U.S. with a focus on New York State issues, including detailed evidence regarding the prices onion growers get offered.

I show how the onion industry has undergone tremendous change over the past 50 years. Onion demand and production have increased dramatically. Over the past 20 years, production has reached a plateau, while consumption has grown and will continue to rise based on demographic projections. These trends result in a trade deficit: the U.S. imports more and more onions each year, particularly from Mexico and Peru.

The situation for onion growers in the U.S. is very different as the global, national, and local contexts have changed over the past 50 years. Onion growers, depending on their geographic location, have developed different strategies to deal with increasingly tough competition. Many growers have chosen to develop a price competitiveness advantage. In contrast, others have built a differentiation strategy based on a premium onion linked to *a terroir*, such as the Vidalia onion industry in Georgia. The third group of onion growers has not clearly chosen between two strategies; they have not collectively and locally shared a new vision that takes their strengths, weaknesses, threats, and opportunities into account.

I suggest that this is the case for the New York onion industry, which competes with onion growers who have based their competitive advantage on a single marketing argument: low price. But New In their zeal to be price competitive instead of qualitatively competitive meant many family farm onion growers are not viable in the long run. Their position has declined. In my view, New York onion growers have become links of a supply chain where they sell a generic onion like a commodity.

New York onion growers have complained about Canadian exports and have argued that Canada subsidizes Canadian onion growers, causing serious injury to New York growers. I have analyzed Canada's export policy and found that there is no evidence to support this allegation. There are no subsidies to Canadian onion growers that would alter the price and create an unfair competitive advantage for Canadian exporters.

My results show that the yellow onion market in the northeast part of the U.S. seems to run correctly, without competitive distortions. Growers and handlers are price makers even if they "price down." Indeed, they try to compete with other onion supply chains that have better productivity and lower production costs. To maintain their onion market shares, growers use a single driver: low price. New York onion growers cannot change their position in the hierarchy of the sweet onion market. We assume that the New York onion is considered a staple food and a "loss-leader onion." Therefore, retailers don't use this onion to make profit, but they use this onion to attract customers by promoting a low price for a basic onion and have agreed to reduce their margin because it is unlikely that handlers and growers would reduce their price. New York onion is in a low-price trap.

I show no asymmetric price transmission or market power on both the grower-handler and retailer sides. I found that Shipping price (PPI) drives the terminal market price (TPI), and the latter causes retail price (RPI). First and second handlers seem to operate as price makers even if it is "a low price".

Therefore, following the example of the Vidalia onion, I suggest that New York onion growers develop a strategy of differentiation based on a black dirt soil terroir and the resulting pungent high sugar onion to create a new, more profitable, and sustainable value chain. This new production method requires collective investment in the local commons: soil, climate conditions, local onion varieties, and know-how. I prepared a cost/benefit analysis that shows an interest to produce premium yellow onions on growers' farms. Indeed, at the farm gate, turning the onion business model into a branded premium onion can be profitable. With this exercise, I provide a Decision-Making Tool that could help growers assessing a possible alternative to their decision, its costs, its benefits as well as chances of success or failure. On a more operational level, I built an Excel spreadsheet to map out all the possible alternatives to onion grower's decision.

The economic impact analysis has been completed with an economic impact analysis at the New York State onion industry level.

In a first scenario called the "branded onion scenario", the change is an increase in onion sales at the farm gate in New York. This reflects the opportunity to develop a strategy of differentiation via a new premium branded onion. I show growers are able to generate a gross output surplus of \$15.2 million. In this scenario, the direct effect is \$15.2 million and a creation of 185 new jobs. The increase of labor income is \$5.3 million and the value added has gone up over \$8 million.

In a second scenario, I evaluated the importance of the New York onion industry by modeling a change in which the onion sector shifted production to grain crops such as corn. In this scenario the onion industry loses its \$41 million gross output to the grain crop sector. The grain crop sector would increase its acreage by approximately 7,200 acres to generate \$4.7 million in new gross output, the direct effect for the onion industry would be a loss of \$36.3 million and a loss of 472 jobs. The decrease in labor income would be \$13 million and value added would decrease by over \$19 million.

To conclude, this report shed light on the complexity of the onion industry in the U.S. Onion industry and its evolution reveals the varied strategies of the stakeholders in this sector to get a competitive advantage that is based both locally and globally.

The analysis at the farm gate and at the scale of the onion industry in New York State shows that there is potential to develop a new value chain. A New York pungent onion value chain could meet consumer expectations and improve the business model of producers and handlers.

The key challenge is for growers and handlers to believe in their strengths and seize opportunities. Therefore, I suggest some recommendations.

Recommendations

A few states (Texas, Wisconsin, and New York) cannot reduce their operating costs under US\$8.5 per cwt. They cannot compete in the same market simultaneously with states like Oregon and Idaho, or countries like Mexico and Peru. The price of New York onions cannot deviate from competitors' prices without risking the loss of markets. Onions of New York origin are not perceived as different by handlers and repackers because growers have not considered their onion can be differentiated and sold in more profitable markets to compensate for their comparatively lower yield. To do so, growers would have to distinguish their onion and tap a slightly higher market.

Accordingly, I suggest that instead of focusing on reasons why New York onion growers are not competitive and profitable, all stakeholders of this supply chain (growers, handlers, retailers, public decision-makers, researchers, and extension educators) should take greater advantage of their common legacy: a unique pungent onion grown on a unique black soil.

Indeed, the naturally high sulfur content of the soil from thousands of years of composted vegetation increases the pyruvic acid levels, increasing the sugar content of onions and resulting in a bold, pungent taste. This makes New York Muck onions exceptional for cooking. When caramelized, they become uniquely sweet. The French have a phrase for this: "gout de

terroir”—a taste of place. Despite all these special qualities, Muck onions are treated like a commodity rather than a specialty crop.

New York growers and handlers need trust and transparency to better work together in the future. The stakeholders should collaborate on the development of a Produce Prices-Costs-Margins Monitoring Tool (PPCMMT) that draws comparisons between price, cost and margin trends across the value chain

Aesop's fable, “The Farmer and His Sons,” is a good example to summarize my suggestions: A dying farmer called his sons to his bedside in order to give them advice. He said, “There is a great treasure hidden in one of the field crops.” Shortly thereafter he died. The sons, upon his death, took tools and carefully dug over every inch of the land several times. They found no material treasure, but the land henceforth yielded an extraordinary crop because of this thorough cultivation. If historically the moral was “hard work is itself a treasure,” the lesson to be learned from this fable is not that New York onion farmers must work harder, but that they have a treasure under their feet that they cannot ignore.

References

Agriculture and Food Council, 2004, Value Chain Guidebook: A Process for Value Chain Development, Second Edition.

Bahram-Parvar M., Lim L., (2018) Fresh-Cut Onion: A Review on Processing, Health Benefits, and Shelf-Life Comprehensive Reviews in Food Science and Food Safety, March 2018 17 (2): 290-308 <https://doi.org/10.1111/1541-4337.12331>

Barjolle, D., Révillon, S., & Sylvander, B. (2007). Création et distribution de valeur économique dans les filières de fromages AOP. *Economie, filières et marchés agroalimentaires* (pp. 1507-1524). Economie et Sociétés.

Barjolle, D., Chappuis, J. M., & Dufour, M. (2000). Competitive position of some PDO cheeses on their own reference market: Identification of the key success factors. In B. Sylvander, D. Barjolle, F. Arfini (eds). *The socio-economics of origin labelled products in agri-food supply chains: Spatial, institutional and coordination aspects*. INRA-Economica.

Barry, P. J., Robison, L. J., 2001. "Agricultural finance: Credit, credit constraints, and consequences," Handbook of Agricultural Economics, in: B. L. Gardner & G. C. Rausser (ed.), Handbook of Agricultural Economics, edition 1, volume 1, chapter 10, pp. 513-571, Elsevier

Biscaia Ribeiro da Silva A. L., Diaz-Perez, J. C., Coolong, T., Dutta, B., & Hajihassani, A. (2020). *2019 Vidalia onion extension and research report* (Annual Publication 114-1). University of Georgia Extension. <https://extension.uga.edu/publications/detail.html?number=AP114-1>

Bonnet C., Simioni M. (2001). Assessing consumer response to protected designation of Origin labelling: a mixed multinomial logit approach, *European Review of Agricultural Economics*, vol. 28, n°4, pp. 433-449.

Boyhan G. E., & Torrance, R. L. (2002). Vidalia onions: Sweet onion production in southeastern Georgia. *HortTechnology*, 12(2), 196-202. <https://doi.org/10.21273/HORTTECH.12.2.196>

Breseman, D. (2018). *Drivers of asymmetric vertical price transmission: The case of fresh vegetables in California*. (Wageningen University – Department of Social Sciences, Agricultural Economics and Rural Policy Group). Retrieved from <https://edepot.wur.nl/441511>

CAES (2019). *2018 Georgia Farm Gate Value Report* (Report No. AR-19-01). University of Georgia, Center for Agribusiness and Economic Development. <https://caed.uga.edu/publications/georgia-agricultural-statistics.html>

Coase, R. H. (1937). The nature of the firm. *Economica*, 4(16),386-405. <https://doi.org/10.1111/j.1468-0335.1937.tb00002.x>

Engle, R. F., & Granger, C. W. J. (1987). Co-integration and error correction: Representation, estimation, and testing. *Econometrica: Journal of the Econometric Society*, 55 (2), 251-276. <https://doi.org/10.2307/1913236>

Ezekiel, M. (1938). The cobweb theorem. *The Quarterly Journal of Economics*, 52(2), 255–280. <https://econpapers.repec.org/RePEc:oup:qjecon:v:52:y:1938:i:2:p:255-280>

Femenia, F., (2019). A meta-analysis of the price and income elasticities of food demand. Working Paper SMART – LERECO, N°19-03, INRAE, 78 p. <https://hal.archives-ouvertes.fr/hal-02103880/document>

Georgia Department of Agriculture (2007). Chapter 40-7-8 Additional regulations applicable to Vidalia Onions. *Rules and regulations of the state of Georgia*.

Granger C.W.J., Newbold P. (1974), Spurious regressions in econometrics, *Journal of Econometrics*, 2 (2), 111-120, [https://doi.org/10.1016/0304-4076\(74\)90034-7](https://doi.org/10.1016/0304-4076(74)90034-7).

Granger, C. W. J., & Lee, T.-H. (1989). Investigation of production, sales and inventory relationships using multicointegration and non-symmetric error correction models. *Journal of applied econometrics*, 4(S1), S145-S159.

Hassan, D., & Simioni, M. (2001). Price linkage and transmission between shippers and retailers in the French vegetable channel. [Economics Working Paper Archive \(Toulouse\)](https://ideas.repec.org/p/rea/inrawp/18.html) 18, French Institute for Agronomy Research (INRA), Economics Laboratory in Toulouse (ESR Toulouse). <https://ideas.repec.org/p/rea/inrawp/18.html>

Howard, T. (2002). The onion landscape of Georgia. *Geographical Review*, 92(3), 452-459. <https://doi.org/10.2307/4140920>

Jeanneaux, P., 2018 Stratégies des filières fromagères sous AOP en Europe - Modes de régulation et performance économique <https://www.quae.com/produit/1529/9782759229062/strategies-des-filieres-fromageres-sous-aop-en-europe>

Johansen, S., & Juselius, K. (1990) Maximum likelihood estimation and inference on co-integration—with applications to the demand for money. *Oxford Bulletin of Economics and Statistics*, 52(2), 169-210. <https://doi.org/10.1111/j.1468-0084.1990.mp52002003.x>

Keatinge, J.D.H., Yang, RY., Hughes, J. Easdown W. J., & Holmer, R. (2011). The importance of vegetables in ensuring both food and nutritional security in attainment of the Millennium Development Goals. *Food Sec.* 3, 491–501. <https://doi.org/10.1007/s12571-011-0150-3>

Larson C. A. (2008) Georgia farmworker health program – Migrant and seasonal farmworker enumeration profiles study Georgia. State Office of Rural Health, Cordele. <http://lib.ncfh.org/pdfs/2k9/9163.pdf>

Lemma, H. R., & Singh, R. (2015). Testing for price co-integration between producers and retailers: Evidence from Ethiopian milk market. *iBusiness*, 7(1), 1-9, <https://doi.org/10.4236/ib.2015.71001>

Molnar, J. J., & Cui, L. (2018). Why don't we do it in the field: Vidalia onion producer perspectives on harvest, sort, and storage technologies. *Journal of Agriculture and Life Sciences*, 5(1). <https://doi.org/10.30845/jals.v5n1a1>

Mulkey D., Hodges A. (2004), Using IMPLAN to assess local economic impact. University of Florida, Gainesville, <http://edis.ifas.ufl.edu>. 2008.07.16.

Nielsen, B. (2001). Order determination in general vector autoregressions. Working paper, Department of Economics, University of Oxford and Nuffield College. <http://www.nuff.ox.ac.uk/Economics/papers/2001/w10/NielsenOrder.pdf>

North D. C., (1990), *Institutions, Institutional Change and Economic Performance*, Cambridge University Press, Cambridge, 152 p.

North D. C., (1991), "Institutions", *Journal of Economic Perspectives*, 5 (1), hiver, pp. 97-112.

O'Donoghue, E.J., A. Hungerford, J.C. Cooper, T. Worth, and M. Ash. (2016). *The 2014 Farm Act Agriculture Risk Coverage, Price Loss Coverage, and Supplemental Coverage Option Programs' Effects on Crop Revenue*, ERR-204, U.S. Department of Agriculture, Economic Research Service, January.

Olsson, T. (2012). Peeling back the layers: Vidalia onions and the making of a global agribusiness. *Enterprise and Society*, 13 (4), 832 – 861. <https://dx.doi.org/10.1017/S1467222700011484>

Porter, M. (1985). *Competitive advantage: Creating and sustaining superior advantage*. NY: Free Press.

Prévost, P., Capitaine, M., Gautier-Pelissier, F., Michelin, Y., Jeanneaux, P., Fort, F., Javelle, A., Moïti-Maïzi, P., Lérique, F., Brunschwig, G., Fournier, S., Lapeyronie, P., & Josien, É. (2014). Le terroir, un concept pour l'action dans le développement des territoires. *VertigO - la revue électronique en sciences de l'environnement [En ligne]*, 14(1). <https://doi.org/10.4000/vertigo.14807>

Reziti, I., & Panagopoulos, Y. (2008) Asymmetric price transmission in the Greek agri-food sector: Some tests. *Agribusiness*, 24(1), 16-30. <http://dx.doi.org/10.1002/agr.20144>

Salop S. C., & Scheffman, D. T. (1983). Raising rivals' costs. *American Economic Review*, 73(2), 267-271. <https://EconPapers.repec.org/RePEc:aea:aecrev:v:73:y:1983:i:2:p:267-71>

Scheffman D. T., & Higgins, R. S. (2003). 20 years of raising rivals' costs: History, assessment, and future. *George Mason Law Review*, 12(2), 371-387. http://www.georgemasonlawreview.org/wp-content/uploads/2014/03/12-2_Scheffman-Higgins.pdf

Smittle D. A., Hayes M. J., & Dickens, W. L. (1979). *Quality Evaluation of Onions* (Research Report 3366). The University of Georgia College of Agriculture Experiment Stations, Tifton, Georgia,

Sylvander B., (2004). "Development of Origin Labelled Products: Humanity, Innovation and Sustainability. Synthesis and Recommendations." Dolphins Project (Development of Origin Labelled Products: Humanity, Innovation and Sustainability). CE, Bruxelles.

Torrance, R. L. (2003). Vidalia Onions. *New Georgia Encyclopedia*. <https://www.georgiaencyclopedia.org/articles/business-economy/vidalia-onions>

UGA Cooperative Extension (2017). *Onion Production Guide* (Bulletin 1198). <https://extension.uga.edu/publications/detail.html?number=B1198&title=Onion%20Production%20Guide>

USDA Agricultural Projections to 2029. Office of the Chief Economist, World Agricultural Outlook Board, U.S. Department of Agriculture. Prepared by the Interagency Agricultural Projections Committee. Long-term Projections Report OCE-2020-1, 114 pp.

USTR, USDA, Commerce (USDC), 2020, Report on Seasonal and Perishable Products in U.S. Commerce, Office of the United States Trade Representative (USTR), United States Department of Agriculture (USDA), and the United States Department of Commerce (Commerce), September 1, 2020, 28 p.

Vandecandelaere, E., Teysier, C., Barjolle, D., Jeanneaux, P., Fournier, S., & Beucherie, O. (2018). *Strengthening sustainable food systems through geographical indications: An analysis of GI economic impacts*. Rome: Food and Agriculture Organization of the United Nations (FAO) and BERD. <http://www.fao.org/3/a-i8737en.pdf>

Vavra, P. and B. Goodwin (2005), "Analysis of Price Transmission Along the Food Chain", OECD Food, Agriculture and Fisheries Papers, No. 3, OECD Publishing, Paris. <http://dx.doi.org/10.1787/752335872456>

Verbeek, M. (2004) *A guide to modern econometrics*. 2nd Edition. John Wiley & Sons Ltd., Hoboken.

Vespa J., Medina L., & Armstrong D. (2020). *Demographic Turning Points for the United States: Population Projections for 2020 to 2060*. Current Population Reports, P25-1144, U.S. Census Bureau, Washington, DC.

Wiczkowski W. 2011. Garlic and onion: Production, biochemistry, and processing. *In: Sinha NK, Hui YH, Evranuz EO, Siddiq M, Ahmed J, editors. Handbook of vegetable and vegetable processing. Ames, Iowa: Blackwell Publishing Ltd. Chapter 31.*

Wilde P., (2018), Food policy in the United States: An introduction, 2nd edition, Earthscan Food and Agriculture, Routledge, New York

Williamson O. E., (1985). *The economic institutions of capitalism: Firms, markets, relational contracting*. NY: The Free Press.

Wu F., Guan Z., Arana-Coronado J., & Garcia-Nazariega M. (2017). *An Overview of Strawberry Production in Mexico* (EDIS document FE1014). University of Florida. <https://edis.ifas.ufl.edu/fe1014>