



**HAL**  
open science

## High resolution mass spectrometry-based untargeted approach: a cutting-edge analytical technique for the detection and identification of organophosphorus synthesis sources

Carla Orlandi, Grégoire Delaporte, Emmanuel Joubert, Christine Albaret, Anne Bossée, Laurent Debrauwer, Emilien Jamin

### ► To cite this version:

Carla Orlandi, Grégoire Delaporte, Emmanuel Joubert, Christine Albaret, Anne Bossée, et al.. High resolution mass spectrometry-based untargeted approach: a cutting-edge analytical technique for the detection and identification of organophosphorus synthesis sources. CBRNE Research & Innovation; 6th International Conference, Mar 2024, Strasbourg, France. hal-04530537

**HAL Id: hal-04530537**

**<https://hal.science/hal-04530537>**

Submitted on 3 Apr 2024

**HAL** is a multi-disciplinary open access archive for the deposit and dissemination of scientific research documents, whether they are published or not. The documents may come from teaching and research institutions in France or abroad, or from public or private research centers.

L'archive ouverte pluridisciplinaire **HAL**, est destinée au dépôt et à la diffusion de documents scientifiques de niveau recherche, publiés ou non, émanant des établissements d'enseignement et de recherche français ou étrangers, des laboratoires publics ou privés.

# ➤ High resolution mass spectrometry-based untargeted approach

A cutting-edge analytical technique for the detection and identification of organophosphorus synthesis sources

Carla ORLANDI  
carla.orlandi@inrae.fr



Research &  
Innovation  
6<sup>th</sup> International Conference

STRASBOURG  
FRANCE  
March 19<sup>th</sup> - 21<sup>st</sup> 2024

## > Context



Events using toxic chemical threat agents → crucial to obtain as much historical information as possible

🔗 Synthesis route and conditions

🏭 Production batches and/or precursors

📍 Source or geographical origin



- aging
- low concentrations
- complex matrices

### SOURCING

The process of **search** and **identification** of discriminating elements whose various properties allow us to attribute an origin to a product or sample

Additives

Persistent  
contaminants

Decomposition  
Degradation

Hydrolysis products

Impurities

Secondary reaction  
products

Precursors and  
unreacted raw  
materials

Interaction by-  
products



**Chemical Attribution Signature**

The role of chemical analysis is to provide well-founded information about the source of the sample, in support of forensic investigations

# ➤ Metabolomics-based trace discovery strategies

Methodology to support attribution of the origin of a toxic agent according to the chemical signature of substances resulting from its production pathway

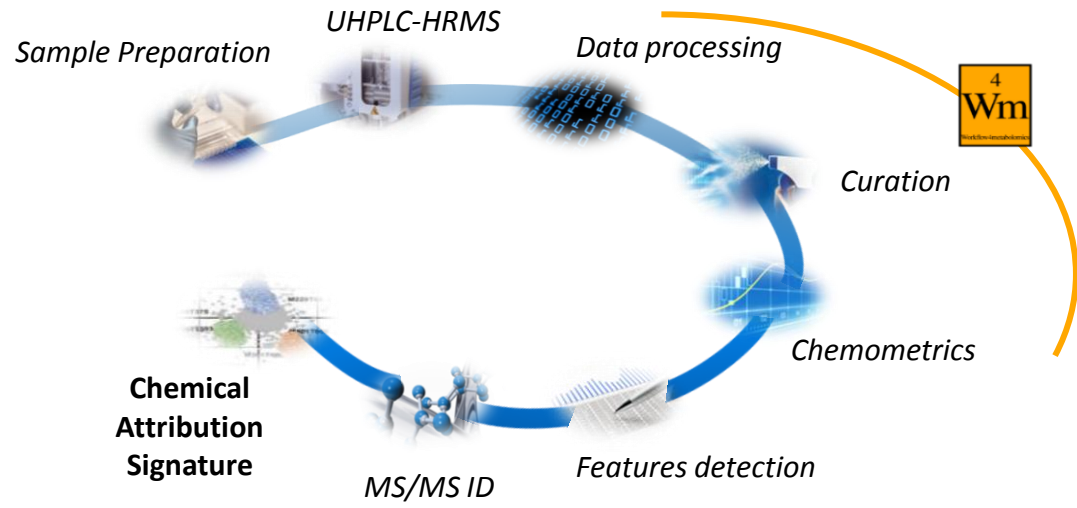
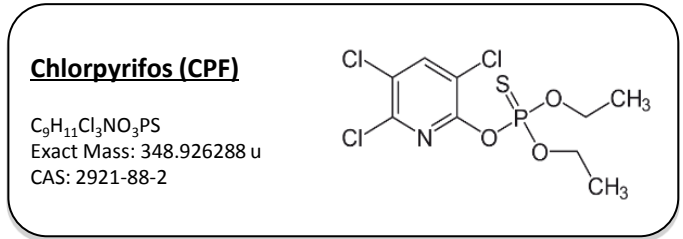

# > Syntheses of Chlorpyrifos



Simplest and least specific → preserve as much information as possible

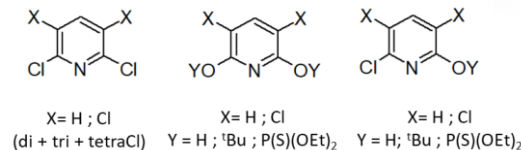
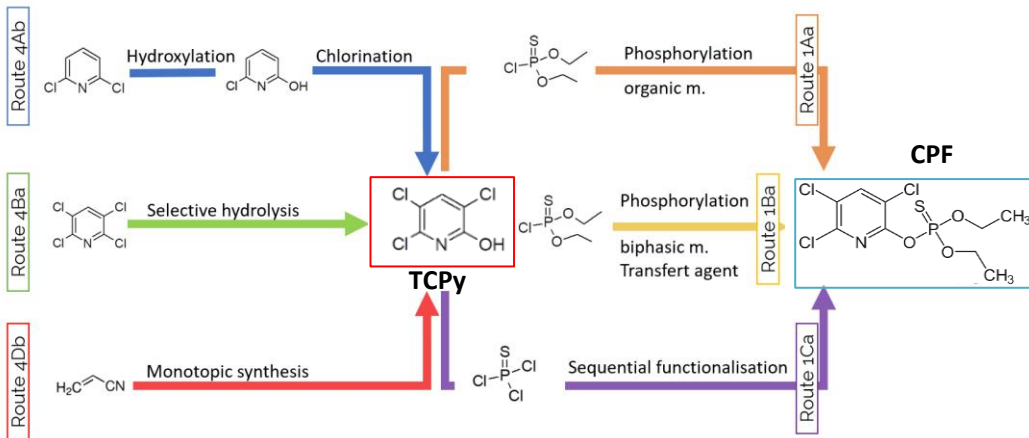

Wide range of compounds and possible impurities combinations

Synthesis	Precursor	Reactant
S1	4Ab	1Aa
S2	4Ab	1Ba
S3	4Ba	1Aa
S4	4Ba	1Ba
S5	4Ba	1Ca
S6	4Db	1Aa
S7	4Db	1Ba

7 chlorpyrifos synthesis combinations (21 samples) – Exp1

Wide variety of aspects → homogeneity of samples analyzed  
(3 trials/triplicate/synthesis, i.e. 63 samples) – Exp2

Homogeneity of synthesis raw materials (Exp2)

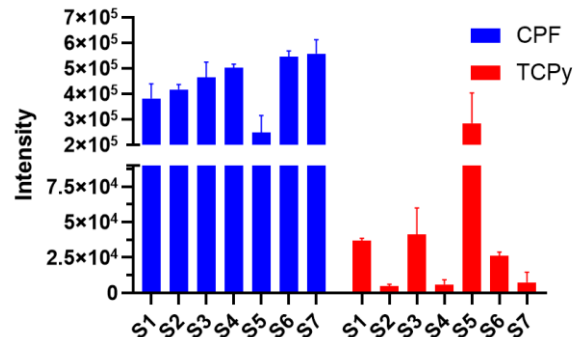

# > Analytical conditions LC-HRMS



## Mode and Ionization optimization APCI & ESI

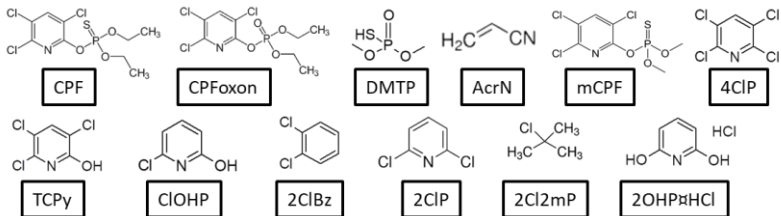

Positive mode ESI : more suitable for these compounds class and greater number of ions formed



### ACQUITY UPLC I class Waters

- Hypersil Gold C18 (100x2.1mm, 1.9 $\mu$ m)
- Mobile phases:  
A) H<sub>2</sub>O/CH<sub>3</sub>OH/AcOH  
B) CH<sub>3</sub>OH/AcOH
- 0.3mL/min at 40°C
- Injection volume: 10 $\mu$ L

### QToF Synapt G2-Si HRMS Waters

MS spectra m/z 50 - 800  
MS resolution ~15000

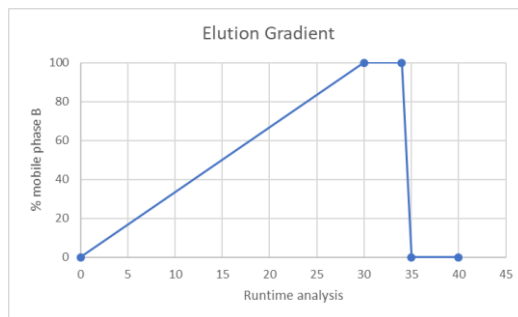

ESI parameters	POS
Capillary (kV)	0.7
Sampling Cone (V)	20
Source Offset	60
Source T (°C)	130
Desolvator T (°C)	250
Cone Gas (L/Hr)	50
Desolvation Gas (L/Hr)	550
Nebuliser G (Bar)	6.5

### Sequence acceptability criteria (QC)

# > Untargeted data processing

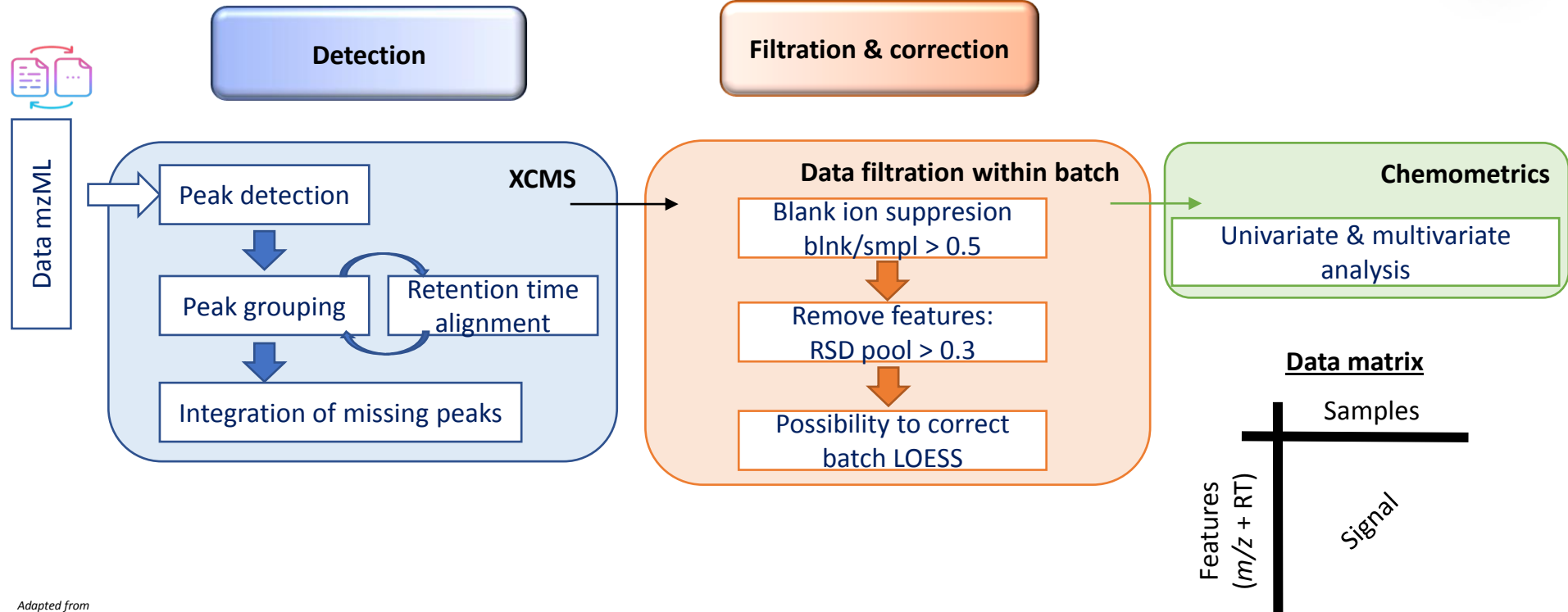

Adapted from  
K. Dinis et al. Food Control 139 (2022) 109098

# > Chemometrics



Multivariate methods suitable to provide a more complete description of studied phenomena

- Major directions of variability → PCA (unsupervised) → exploratory

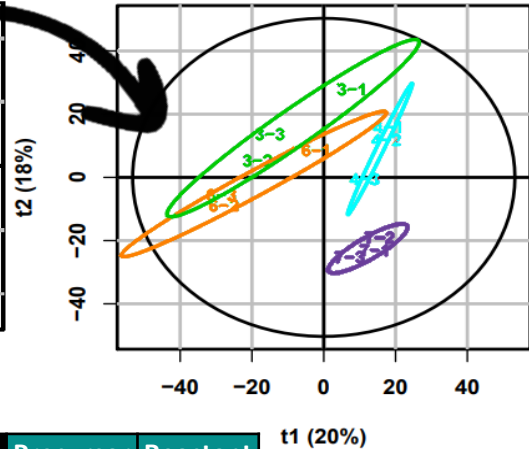
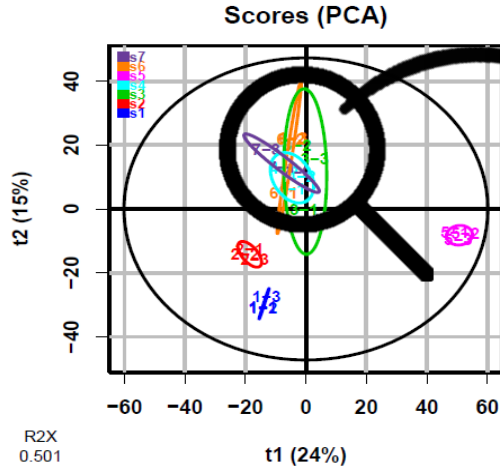
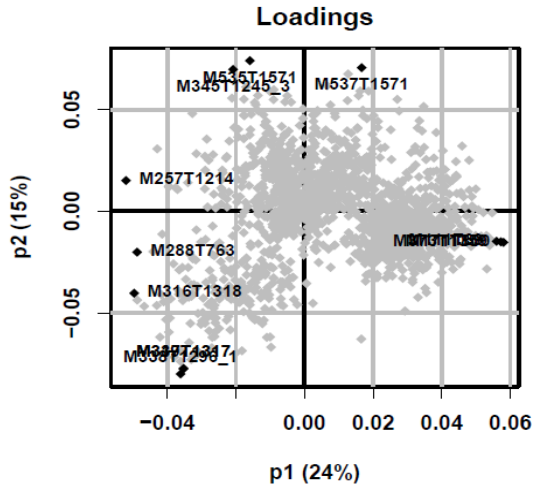

PCA: First overview of variability between samples and correlation between features

Synthesis	Precursor	Reactant
S1	4Ab	1Aa
S2	4Ab	1Ba
S3	4Ba	1Aa
S4	4Ba	1Ba
S5	4Ba	1Ca
S6	4Db	1Aa
S7	4Db	1Ba



# > Chemometrics



Multivariate methods suitable to provide a more complete description of studied phenomena

- Specific directions of variability → PLS (supervised) → predictive of regression or discrimination

Synthesis	Precursor	Reactant
S1	4Ab	1Aa
S2	4Ab	1Ba
S3	4Ba	1Aa
S4	4Ba	1Ba
S5	4Ba	1Ca
S6	4Db	1Aa
S7	4Db	1Ba

Number of discriminating features (VIP>1)

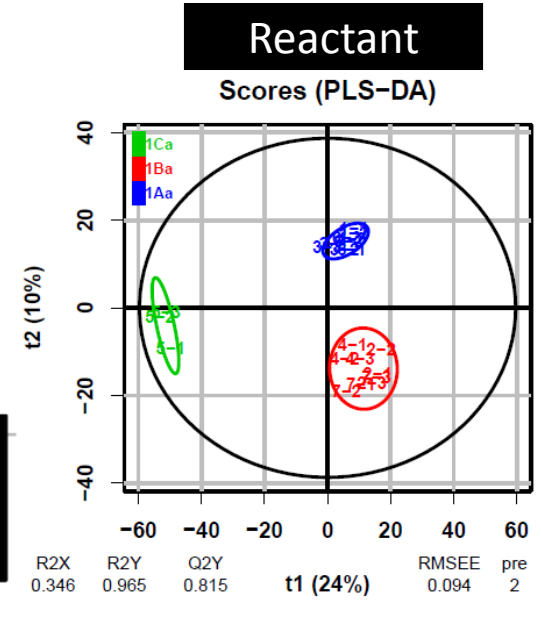
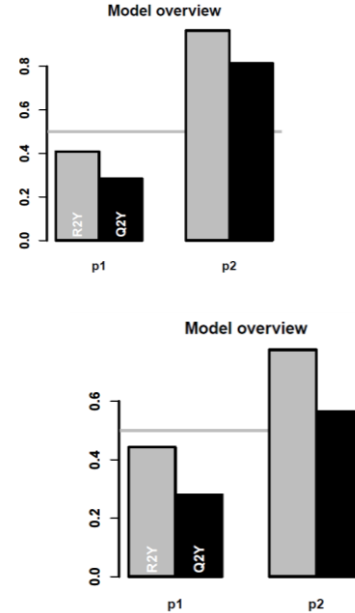
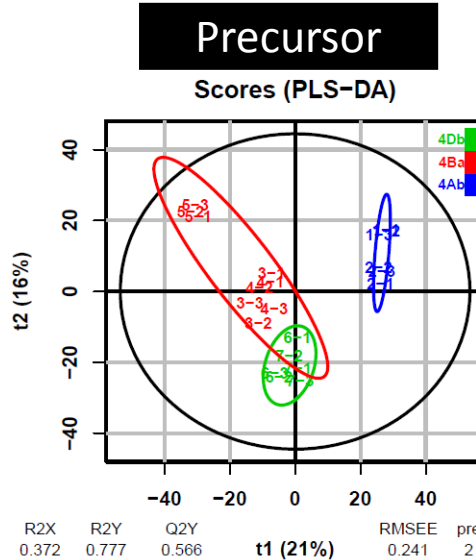
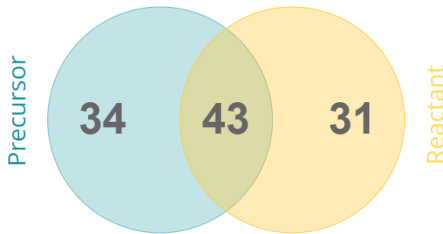

PLSDA: discrimination of synthetic sources achieved  
Quality of the model was assessed with  $Q^2Y > 0.4$  and permutation test

# Annotation Challenges



## HRMS : sensitive and selective detection of discriminating impurities

- Features (PLSDA; VIP>1) annotated using LC, MS, MSMS and IMS to propose a putative structure
- MS<sup>2</sup> → characteristic fragments for structural elucidation

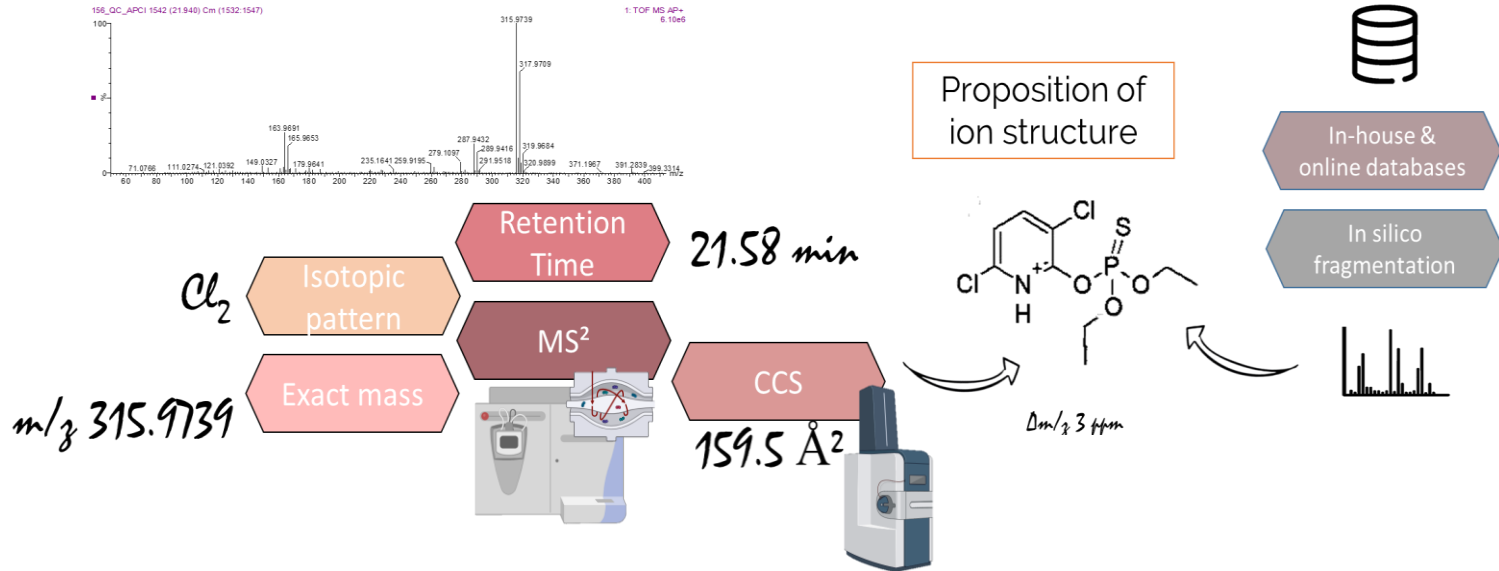

Sumner et al. *Metabolomics* (2007) 3, 211-221  
 Schymanski et al. *Environ Sci Technol.* (2014) 48:2097-8

[1] Confirmation Structure	[2] Probable Structure	[3] Tentative Candidate	[4] Unknown
4	14	28	55

# ➤ How sensitive is the model to variation?

## Remove 20% of the weakest features

ROC CURVES	CTRL: Exp1 (21 samples)	PAT: Exp2 (63 samples)
Common discriminating features	intensity	intensity



Area under the ROC curve	S1	S2	S3	S4	S5	S6	S7
Area	0.85	0.85	0.83	0.86	0.76	0.78	0.82
95% confidence interval	0.78 to 0.92	0.78 to 0.91	0.76 to 0.90	0.80 to 0.93	0.68 to 0.83	0.71 to 0.85	0.75 to 0.89
P value <0.0001 ?	yes	yes	yes	yes	yes	yes	yes

Specificity (Rmv 20% Exp1)	S1	S2	S3	S4	S5	S6	S7
Area	0.86	0.85	0.83	0.86	0.76	0.78	0.82
95% confidence interval	0.79 to 0.92	0.78 to 0.91	0.76 to 0.90	0.80 to 0.92	0.68 to 0.83	0.71 to 0.85	0.75 to 0.89
P value <0.0001 ?	yes	yes	yes	yes	yes	yes	yes

  

Sensitivity (Rmv 20% Exp2)	S1	S2	S3	S4	S5	S6	S7
Area	0.71	0.71	0.69	0.71	0.67	0.69	0.69
95% confidence interval	0.62 to 0.80	0.62 to 0.80	0.61 to 0.78	0.62 to 0.80	0.58 to 0.76	0.60 to 0.77	0.60 to 0.78
P value <0.0001 ?	yes	yes	yes	yes	no	yes	yes

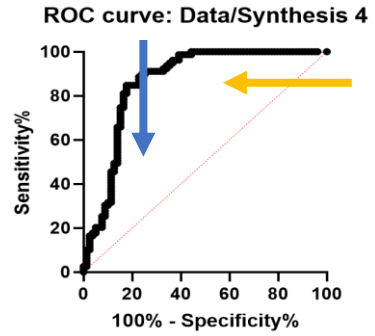

All the AUC values > 0.5 → results are not random  
 Model still valid to variations modeling real case samples

# ➤ Chemical Attribution Signature (W4M, MetaboAnalyst)

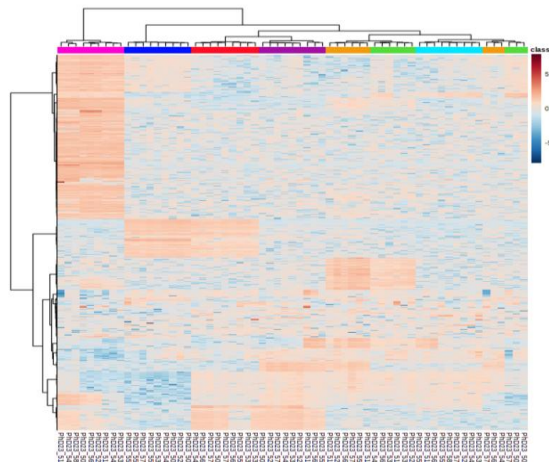

Heatmap

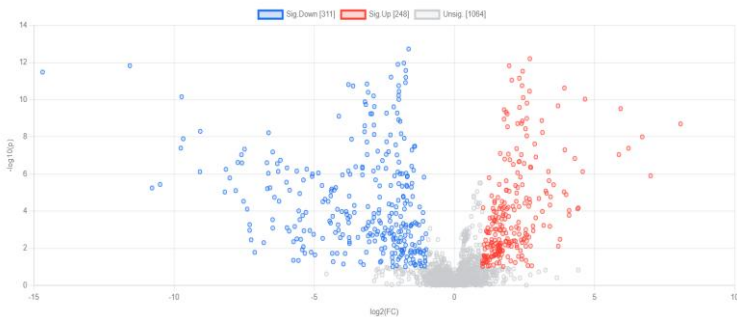

Volcano Plot (S1 vs. S2)

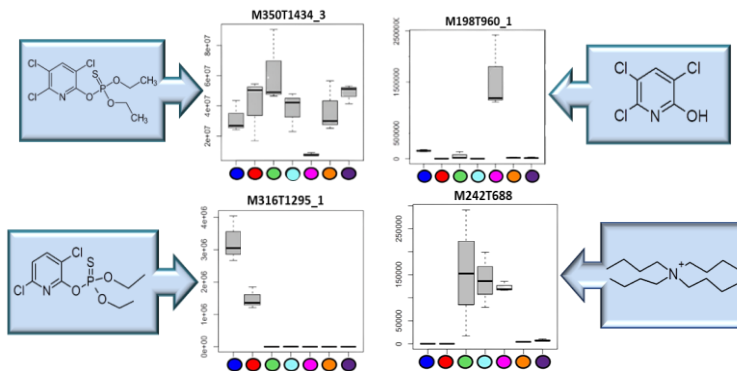

Boxplot

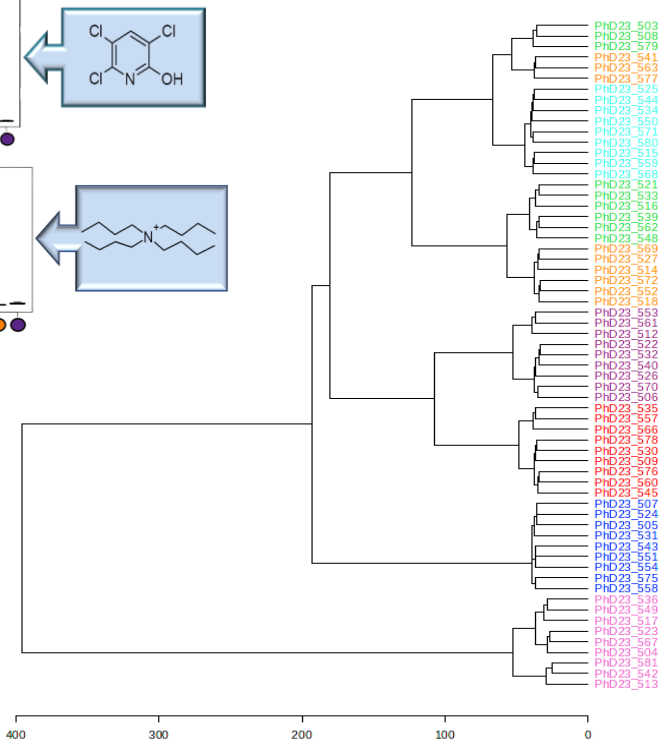

Hierarchical Clustering Analysis

Different graphical representations can be used to illustrate synthesis impurities giving information about sourcing

## > Conclusions

- ⊕ **Sensitivity** : Link a manufacturing origin/process to a chemical footprint from synthetic raw materials
- ⊕ **Selectivity** : Footprint characteristic of a single route or set of pathways with common steps

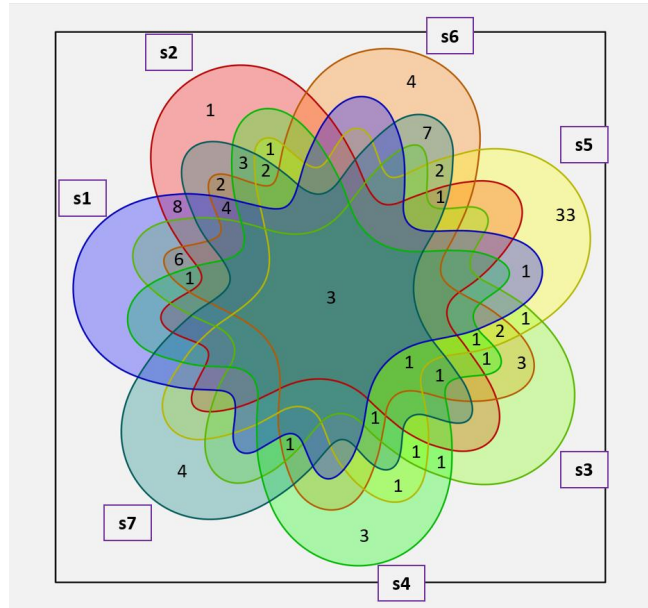

## > Perspectives

### ⊕ Ruggedness

⊕ Is it applicable to complex samples?



**Matrices**  
Sand, Water, Soils, Air

✓ Model Validation

✓ Crude yields

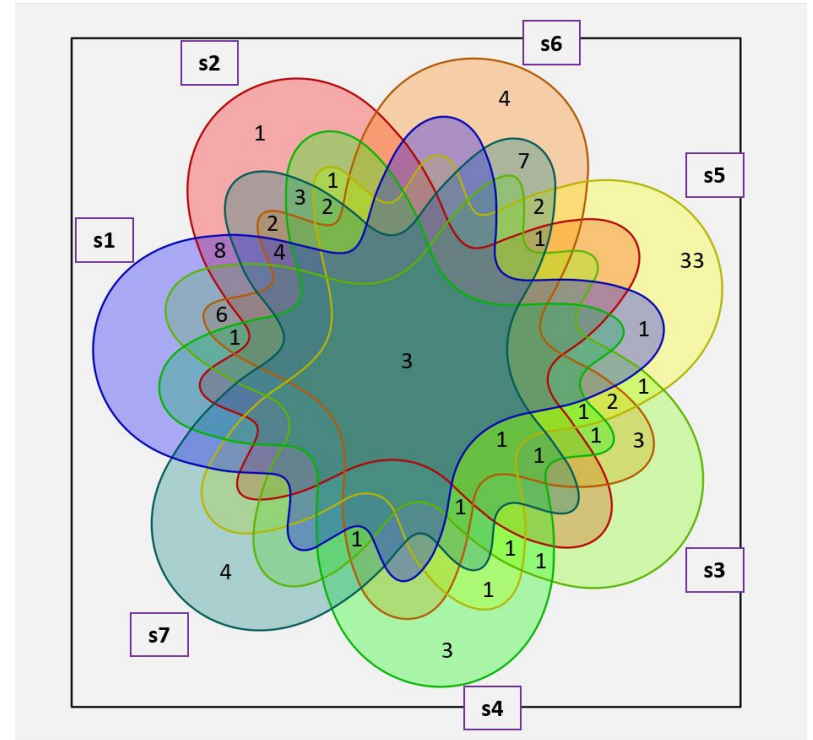

To be continued...

# Acknowledgements

## Supervisors



Emilien JAMIN  
Laurent DEBRAUWER



## Collaborators and funders

### DGA NRBC

Grégoire DELAPORTE  
Anne BOSSEE  
Emmanuel JOUBERT  
Christine ALBARET



Grant DGA  
N° 22470120



Grant AID  
N° 2022 65 0036

## Monitoring committee



Research &  
Innovation  
6<sup>th</sup> International Conference

STRASBOURG  
FRANCE  
March 19<sup>th</sup> - 21<sup>st</sup> 2024

# Thank you for your attention

INRAE

