



HAL
open science

Multi-scale experimental deformation and damage initiation of clay-rich rocks

Matthieu Lusseyran, Alexandre Tanguy, Audrey Bonnelye, Alexandre Dimanov, Jerome Fortin

► **To cite this version:**

Matthieu Lusseyran, Alexandre Tanguy, Audrey Bonnelye, Alexandre Dimanov, Jerome Fortin. Multi-scale experimental deformation and damage initiation of clay-rich rocks. EGU General Assembly 2024, Apr 2024, Vienne (Austria), Austria. hal-04528151

HAL Id: hal-04528151

<https://hal.science/hal-04528151v1>

Submitted on 30 Apr 2024

HAL is a multi-disciplinary open access archive for the deposit and dissemination of scientific research documents, whether they are published or not. The documents may come from teaching and research institutions in France or abroad, or from public or private research centers.

L'archive ouverte pluridisciplinaire **HAL**, est destinée au dépôt et à la diffusion de documents scientifiques de niveau recherche, publiés ou non, émanant des établissements d'enseignement et de recherche français ou étrangers, des laboratoires publics ou privés.

Multi-scale experimental deformation and damage initiation of clay-rich rocks

Coupling ultrasonic wave propagation and full field deformation measurements by digital image correlation (DIC)

Matthieu Lusseyran ¹, Audrey Bonnelye ², Alexandre Tanguy ¹, Alexandre Dimanov ¹, Jérôme Fortin ³

Matthieu Lusseyran

• Second-year PhD student

• Master : Geology, IPGP

• Licence : Mechanics, Sorbonne université



1 Objectives

Understanding the damage processes in clay-bearing rocks is a decisive factor in geological engineering for:

- nuclear waste deep geological repositories.
- rupture of fault gauges in seismic zones

What are the deformation mechanisms affecting the P-wave velocity?

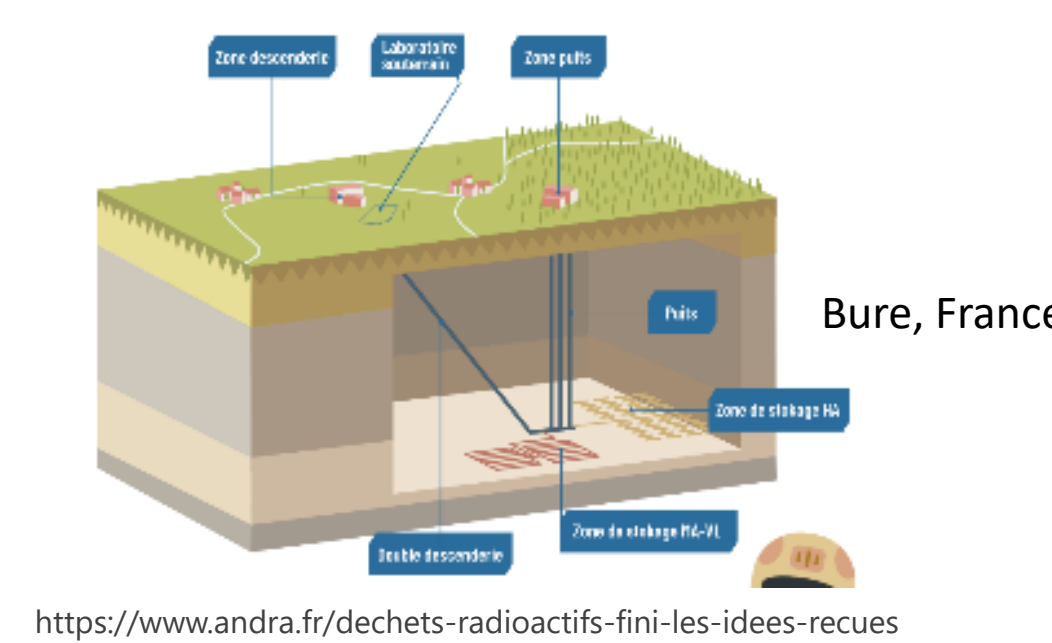

Method :

We focus on the impact of micro-damage, from an experimental point of view, on:

- ultrasonic P-wave velocity (V_p)
- full deformation fields calculated by Digital Image Correlation (DIC).

2 Samples

Samples :
Tournemire clay samples, cored from IRSN underground lab.

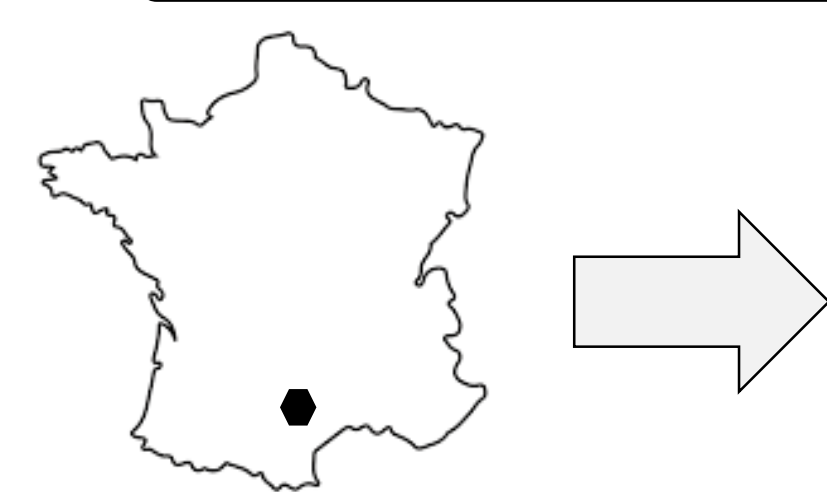

Drilling angle relative to the natural stratification of the sample

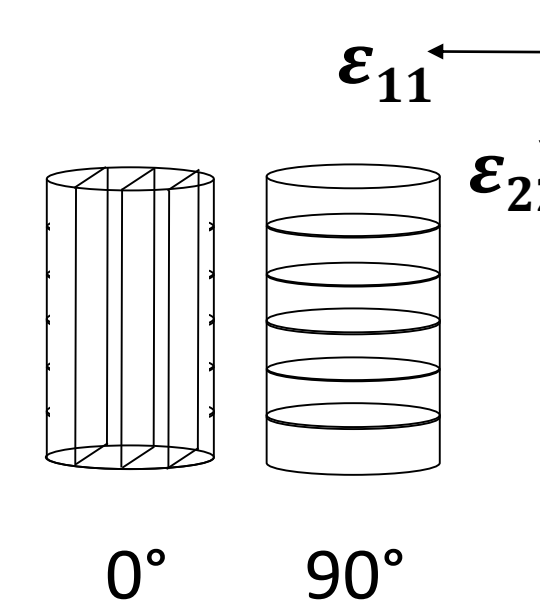

3 Settings

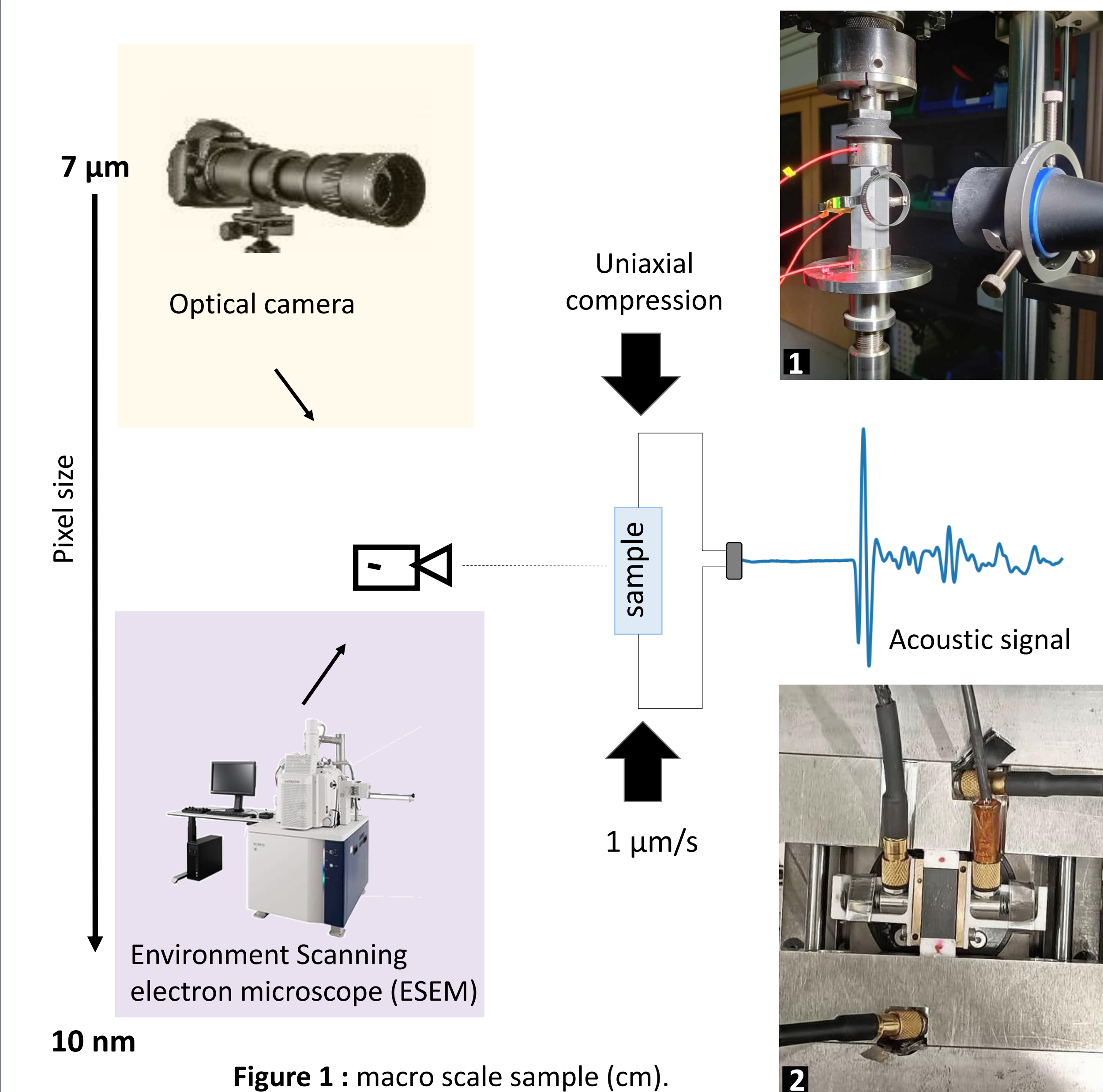
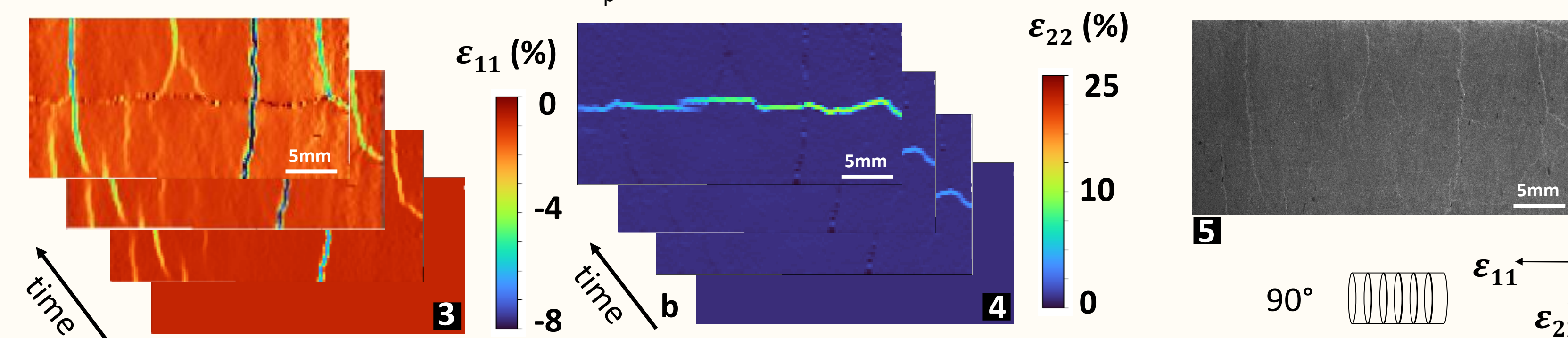

Figure 1 : macro scale sample (cm).

Figure 2 : micro scale sample (mm).

4 Macroscale results – cm scale

The first experiments are led on macroscopic samples : 72mm in height and 36 in diameter. The strain maps calculated by DIC and P-waves velocity V_p are presented below



Figures 3 and 4 : Strain maps ; Damage processes measured by digital image correlation (DIC) are usually represented over time as a series of deformation maps. This method is well suited to identify major damage events (macro-cracks).

Figure 5 : Reference image

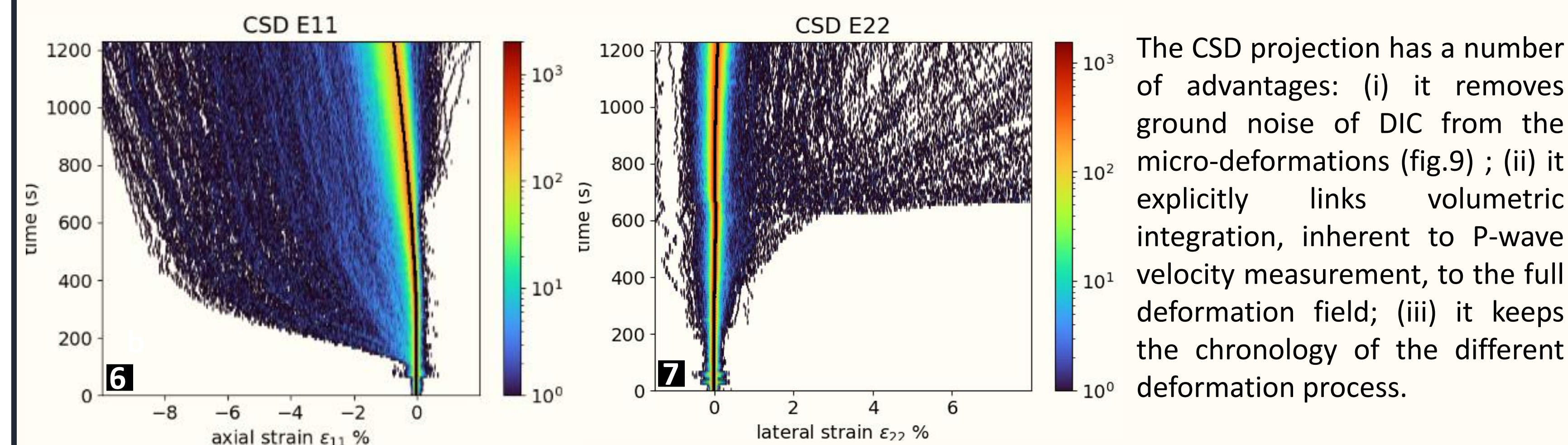

Figure 6 and 7 : Chronogram of Strain Distribution (CSD) ; temporal evolution of distribution of deformation extracted from full strain maps with classes as x-axis and time as y-axis. The colorbar shows the number of occurrences.

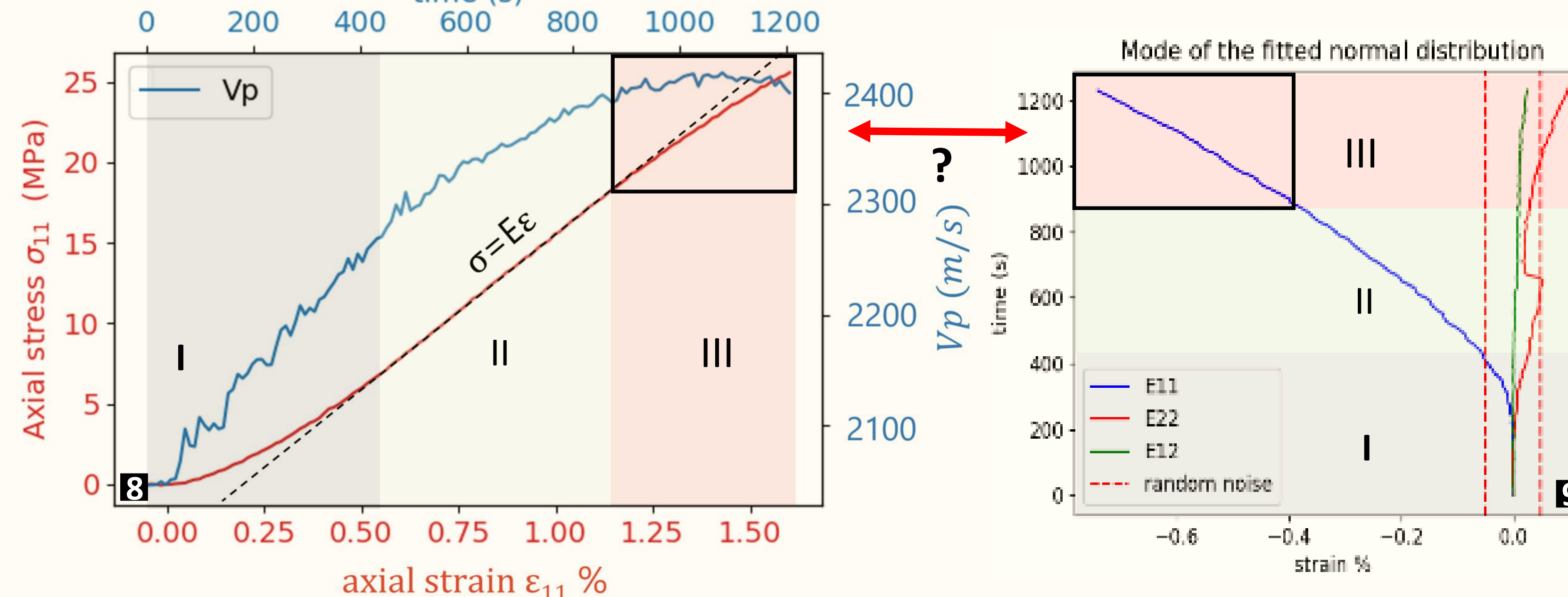

Figure 8 : Evolution of axial P-wave velocity V_p in blue, with loading curve in red. The loading curve is divided into three sections. I, closure of preexisting cracks. II, elastic deformation. III, inelastic deformation : crack initiation and propagation. Figure 9 shows the most probable deformation (x-axis) as a function of time (y-axis) calculated from the CSDs (Figure 6 and 7).

Here, the mechanism causing the P-wave velocity to drop during dilatancy is not fully captured by DIC due to the lack of resolution. These mechanisms are probably at the scale of the clay matrix (nanometer order), which is below the pixel size (6.4μm) of the optical camera.



5 Microscale results -μm scale

We now scale down the previous experiment to the ESEM chamber with a 8*8*16mm sample. Images are taken with fields ranging from 400 to 50 micrometers.

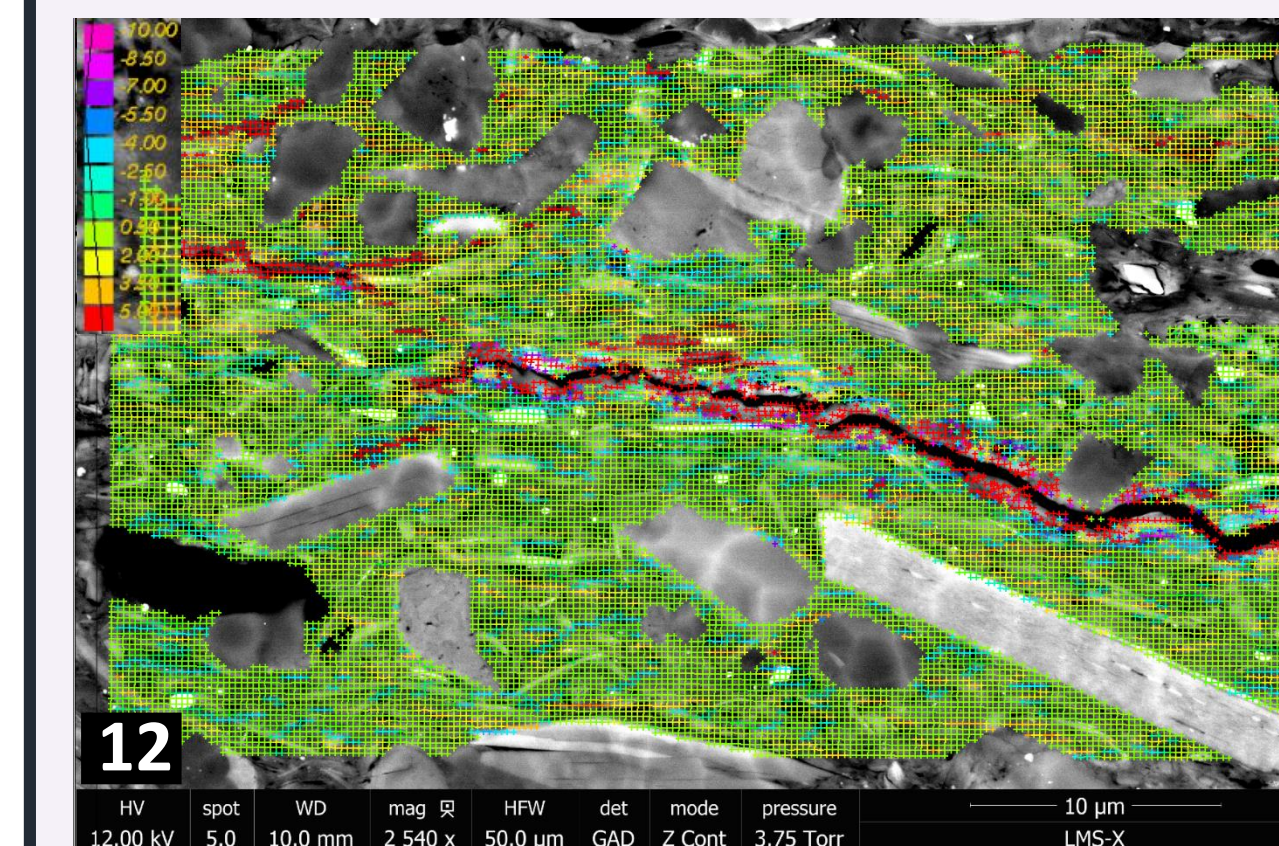
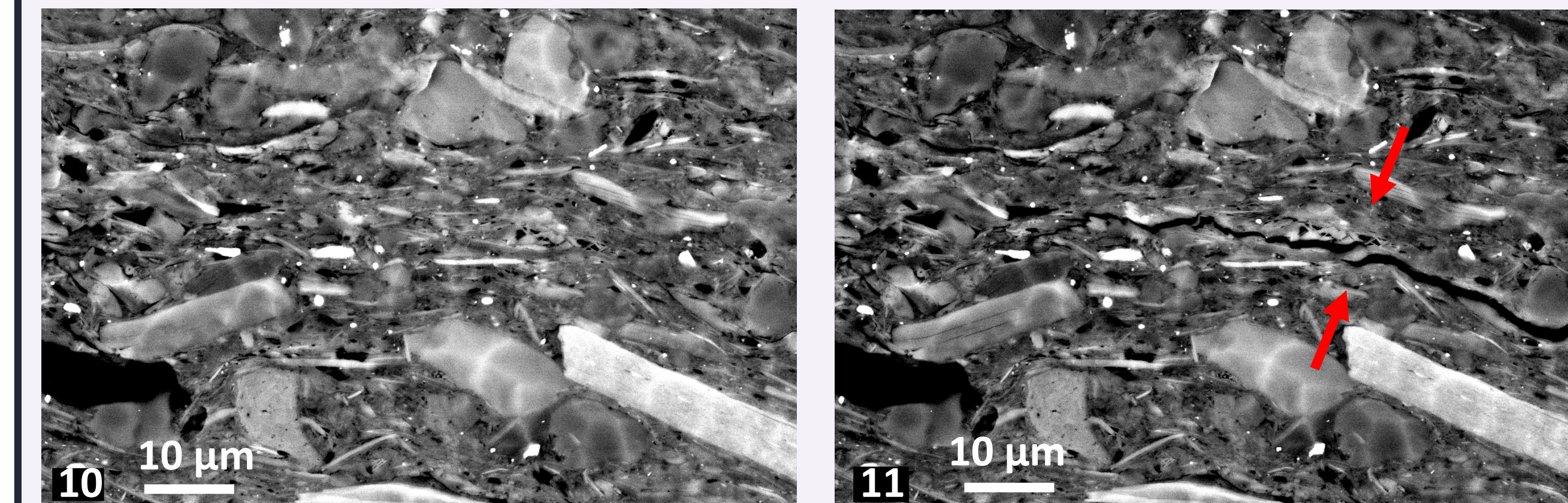

ESEM images figure 10 and 11 : These images are taken before and after a crack opening, respectively at T2_1 and T2_2 (cf. load steps, figure 13). The corresponding strain map is presented figure 12.

Lateral and axial V_p , force and temperature

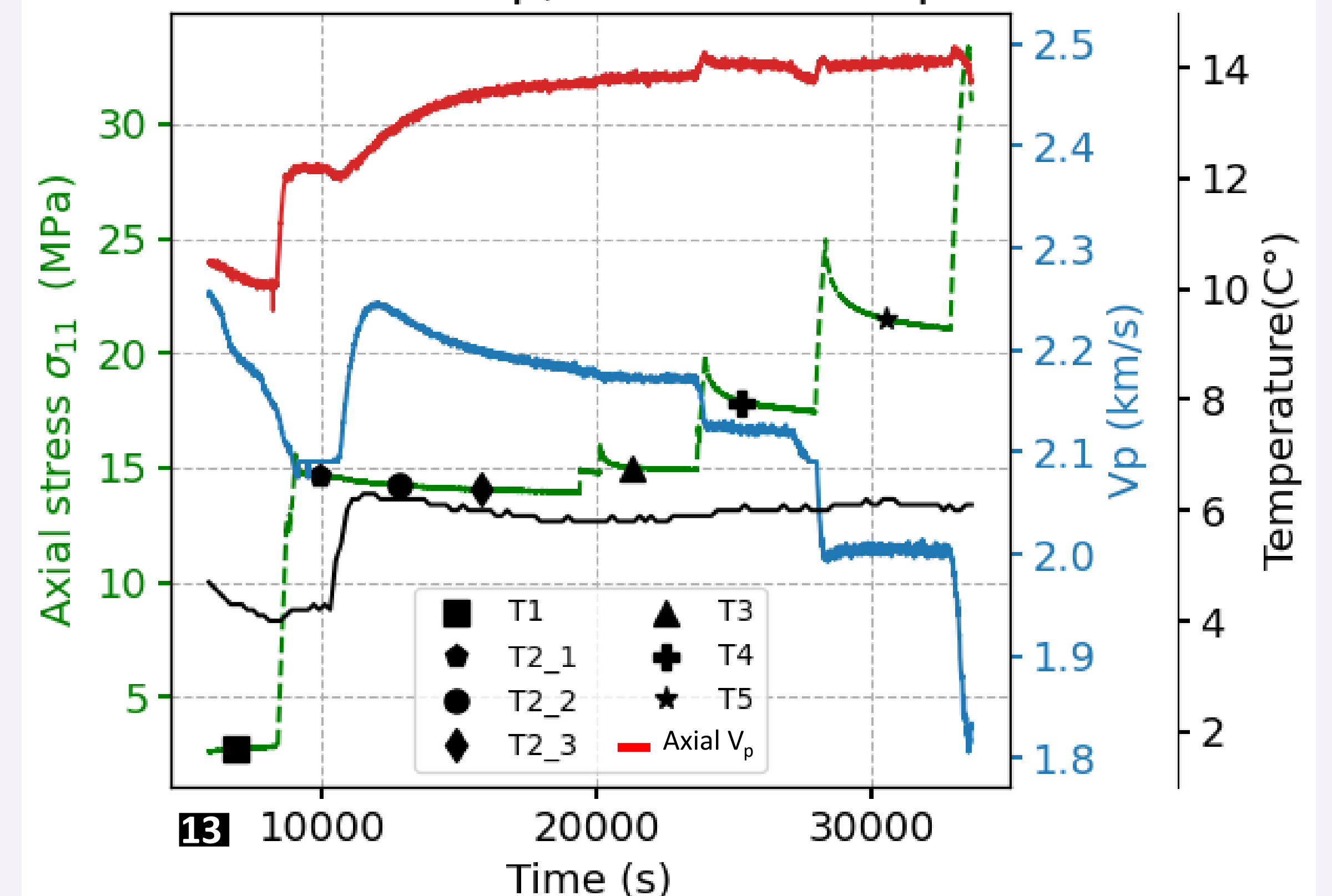

figure 13 : Evolution of axial and lateral P-wave velocity (m/s), axial stress (MPa) and temperature (°C) as a function of time. The dots correspond to image acquisitions.

6 Conclusions

- Good correlation between macrostructures and P wave velocity, but not enough resolution to really spot the micro damaging process within the clay matrix.
- At the microscale using ESEM for images , acquisition. The protocol is working and the first results are very promising !

We're almost there !!