



HAL
open science

Model-based computational tools for reliability assessment and diagnostics

Pierre Calmon, Edouard Demaldent, Alexandre Imperiale, Christophe Reboud, Roberto Miorelli, D. Rodat, Olivier Mesnil, Andrii Kulakovskiy, Bastien Chapuis, Xavier Artusi, et al.

► To cite this version:

Pierre Calmon, Edouard Demaldent, Alexandre Imperiale, Christophe Reboud, Roberto Miorelli, et al.. Model-based computational tools for reliability assessment and diagnostics. NDE 2018 - 27th conference on Non Destructive Evaluation 2018, ISNDT, Dec 2018, Mumbai (Bombay), India. hal-04520544

HAL Id: hal-04520544

<https://hal.science/hal-04520544>

Submitted on 25 Mar 2024

HAL is a multi-disciplinary open access archive for the deposit and dissemination of scientific research documents, whether they are published or not. The documents may come from teaching and research institutions in France or abroad, or from public or private research centers.

L'archive ouverte pluridisciplinaire **HAL**, est destinée au dépôt et à la diffusion de documents scientifiques de niveau recherche, publiés ou non, émanant des établissements d'enseignement et de recherche français ou étrangers, des laboratoires publics ou privés.

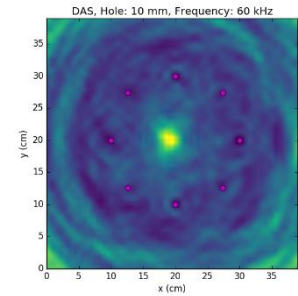
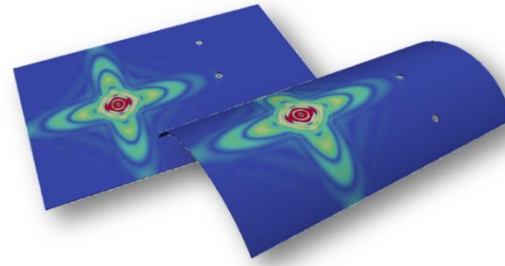
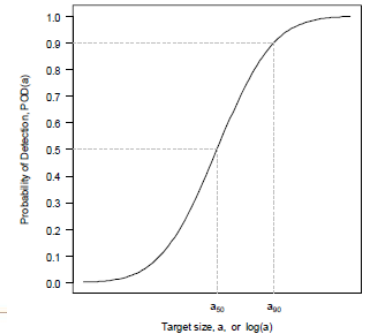
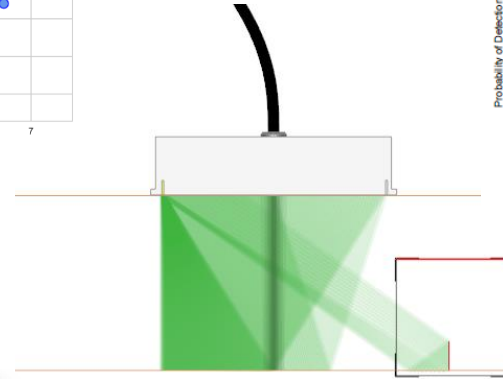
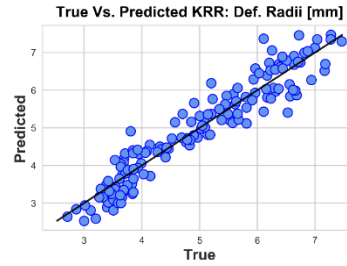

MODEL-BASED COMPUTATIONAL TOOLS FOR RELIABILITY ASSESSMENT AND DIAGNOSTICS

Pierre CALMON and coll.



■ NDE Department

- 110 staff members (20 PhD)
- Located in Paris-Saclay

■ RESEARCH AREAS

Development of innovation in NDE-SHM

→ Modelling Simulation Data

→ Instrumentation Methods

Technological transfers to the industry

■ COLLABORATIONS

- Industrial partnership : Energy, Aircraft, railways, oil and gas, manufacturing, ...
- International academic partnership

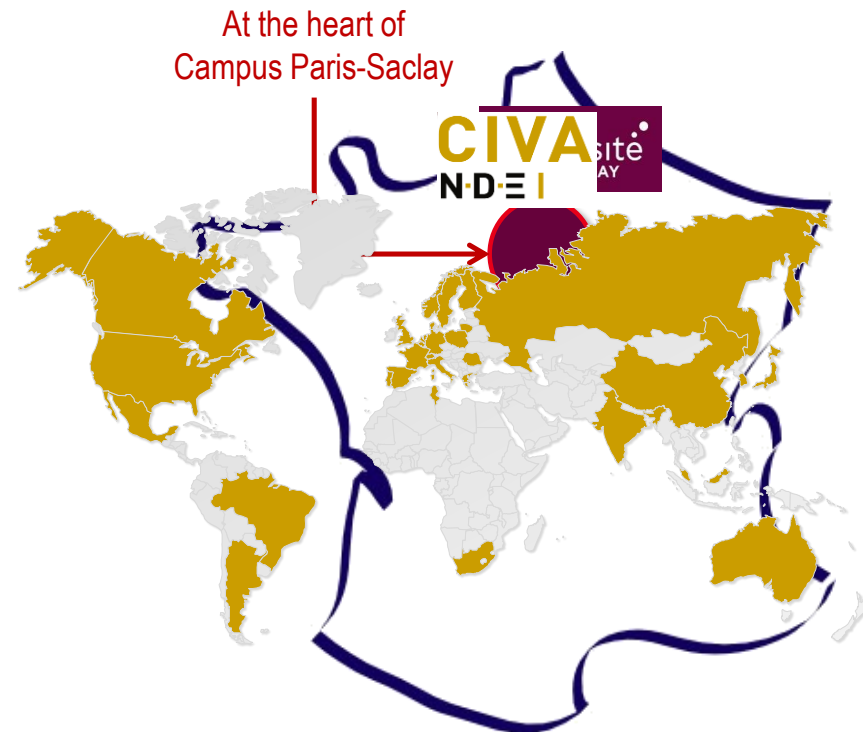

A glimpse on some current *computational* activity at CEA LIST.

- Introduction: New trends in modelling
- Computational tools for reliability assessment
MAPOD, sensitivity analysis, accuracy assessment
- Computational tools for imaging and diagnostics:
Inversion, data analytics

A choice: To limit the talk to UT/GW applications.

INTRODUCTION

New trends in modelling

- **Unchanged objectives of modelling :**
 - NDT performance demonstration
 - Design of inspections, of SHM systems
 - Imaging and diagnostics: enhanced/automated
 - Training, monitoring, “virtual NDT”
- **But with new uses implying new challenges :**
 - Intensive computations (statistics)
 - Real time computations for on line applications
 - + Increasing complexity, accuracy, realism
- **And an enlarged vision of “modeling”:**
 - Physics-based models
 - **Data-based models: Meta-models**

Off line tools



On line tools



PHYSICS BASED MODELS

Implementation of a mathematical formulation of the physical problem

- Need to handle always more complex cases
- With the challenges of accuracy/rapidity/easiness of use

Continuous works in the implementation of numerical modelling in CIVA

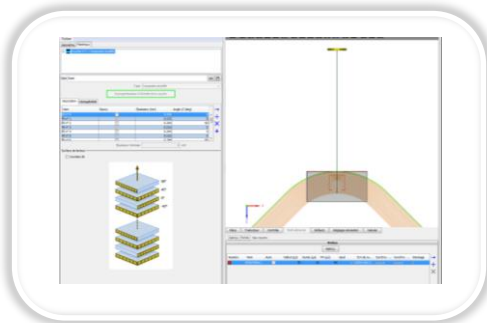

UT Composites

SFEM results for UT on weld

- Simulation on 3D cases
 - Simulated time: 30 μ s
 - 3000 steps at 1 MHz
 - 6000 steps at 2 MHz
 - Computation time:
 - 6 min. at 1 MHz
 - 1h30 min. at 2 MHz

Computer used for computation:

- Bi-processor computer
- 2 Intel Xeon Processors E5-2687W v2
- 25M Cache, 3.40 GHz, 2x8 cores

ADVISE

Ultrasonic 3D field for 1MHz source

UT Welds

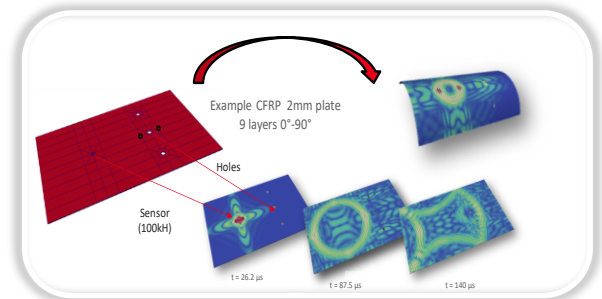

GW SHM

DATA BASED MODELS (METAMODELS)

Construction of a model from (real or numerical) data:

- **One advantage:** Makes possible **fast/intensive computations** after a phase of building the model.
- If based on real data: No needs of physical models (complex/random phenomena)
- **But one requirement: To have data.**
- Physics-based models can provide data!
Complementarity of data-driven and physic-based models.

DATA BASED MODEL (METAMODELS)

Metamodel: Input/Output “black-box” built from a numerical data base, which can be substituted to the initial physics-based model

- "Off line" phase: Possibly time consuming



Data base generation

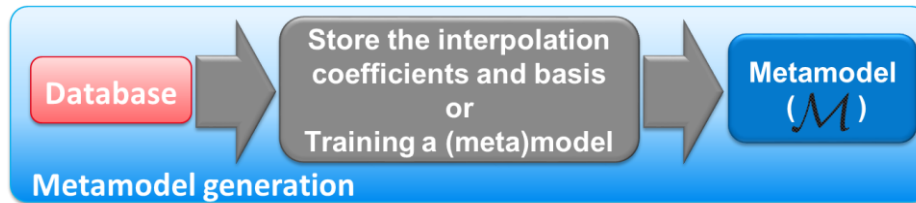

Creation of the metamodel (Kriging, RBF, SVR, ...)

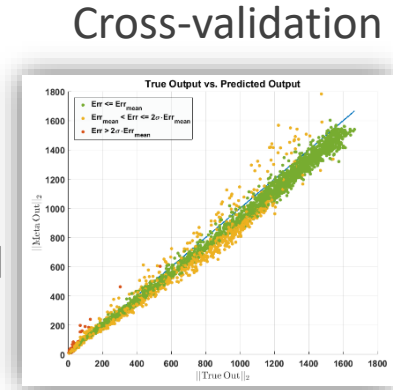

- "On line" phase: Possibly real-time

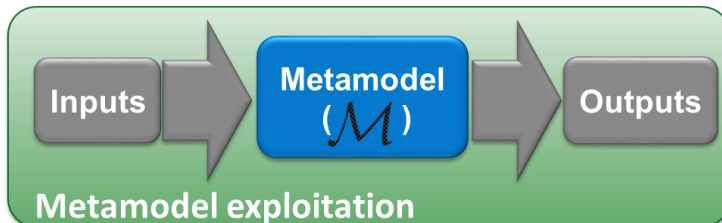

Exploitation of the metamodel

COMPUTATIONAL TOOLS FOR NDE RELIABILITY ASSESSMENT:

*MAPOD, Sensitivity analysis,
Accuracy assessment*

- Deterministic: Well established acceptance of the use of modelling for Inspection qualification by ENIQ .
- Probabilistic: More recently, adoption of the **MAPOD** approach in various sectors of industry
 - **First idea**: To replace expensive and sometimes uneasy to implement experimental trials by numerical simulation
 - In 2016 publication of a **IIW** Recommended practice on MAPOD
- **New ideas**: Using meta-models makes possible
 - To go further than the “standard” POD methodology
No assumptions on the data, confidence on POD, ...
 - To fill the gap between probabilistic and deterministic
POD + Sensitivity analysis

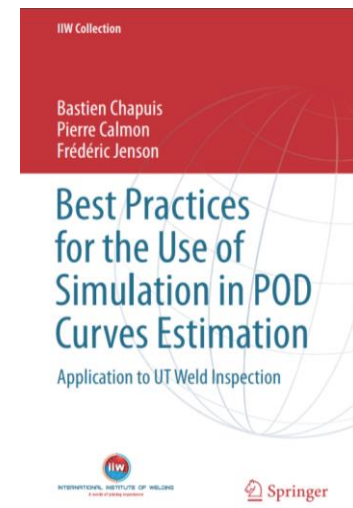
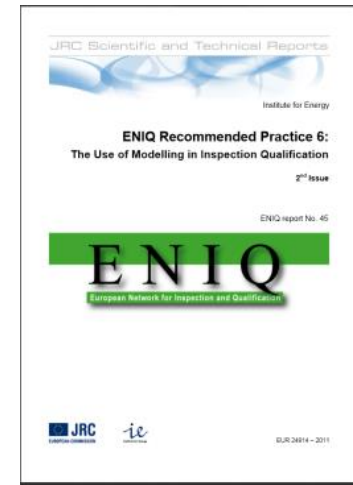
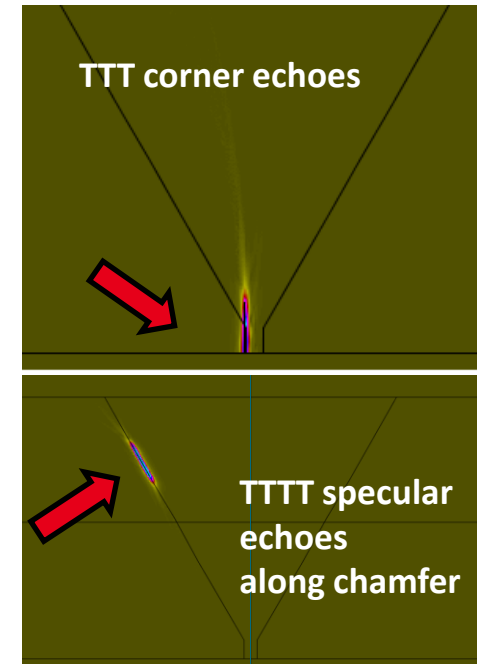
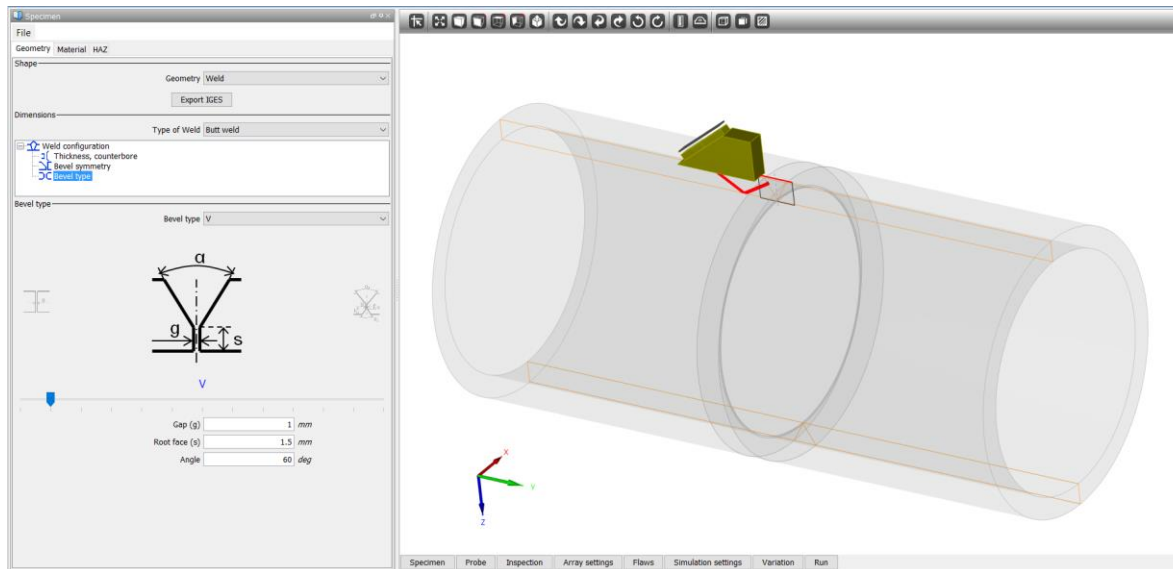

Illustration on one UT-TFM case: Welding Inspection

FMC - TFM Images



Array 7 MHz 64 elts Steel welded pipe 21 mm, Planar breaking defect and lack of fusion

Objective of the study: Estimate the sensitivity of the detection performances to the different parameters and establish a POD.

Methodology: Metamodels + uncertainty propagation

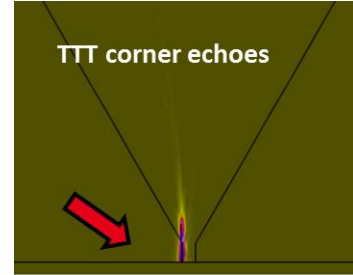

First step: Creation of the metamodel from a CIVA data-base

Num...	User label	Tag	Min	Max
1	Flaws list - Height	X	0.01	4.0
2	Flaws list - Tilt	X1	-10	10
3	Specimen - Thickness (t)	X2	19	23
4	Specimen - Transverse wave velocity	X3	3190.0	3391.0
5	Flaws list - Skew	X4	0	3
6	Inspection settings - Offset Y	X5	-19	-15

Input: 6 parameters

Output: Amplitude Max of TFM-image

Interpolator: Kriging

Cross-Validation: Measurement of the discrepancy between the meta-model and CIVA

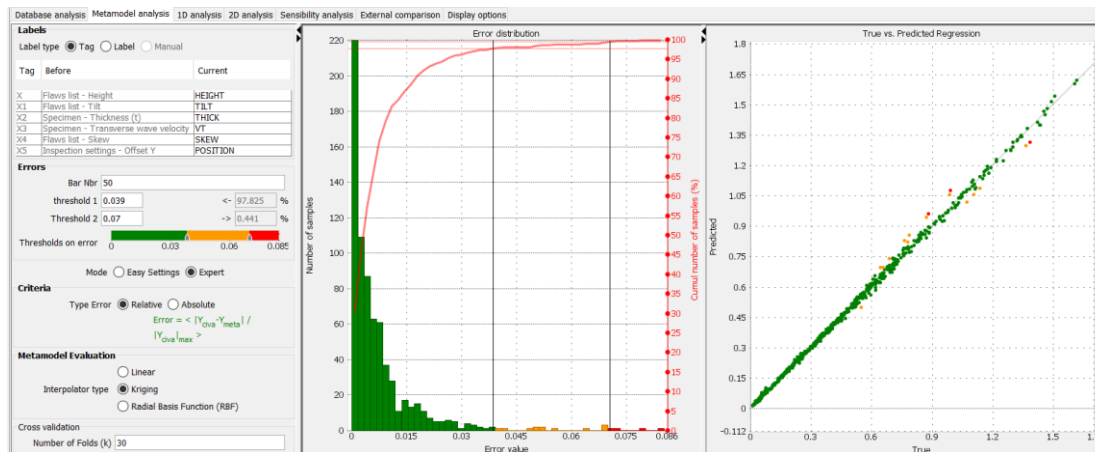

MODEL-BASED RELIABILITY ASSESSMENT

Meta-models for POD ESTIMATION

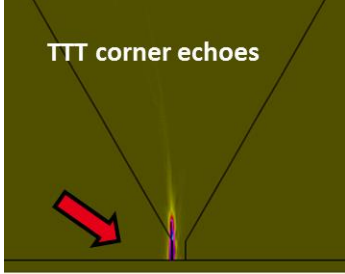

- Definition of the variability of the parameters Tilt, c_T , Thickness:

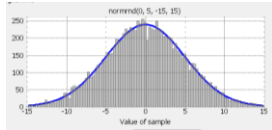

$$N(0, \sigma_{tilt})$$

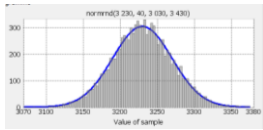

$$N(3290, \sigma_{cT})$$

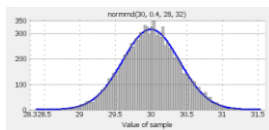

$$N(21, \sigma_{thick})$$

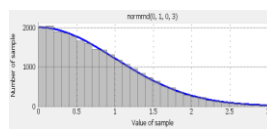

$$N(0, \sigma_{SKEW})$$

- Meta-model computations (MC sampling):
50000 evaluations in 2s thanks to Metamodel

Number of characteristic values	50
Number of samples (/character)	1000

- POD estimation : Hit-miss (logit)

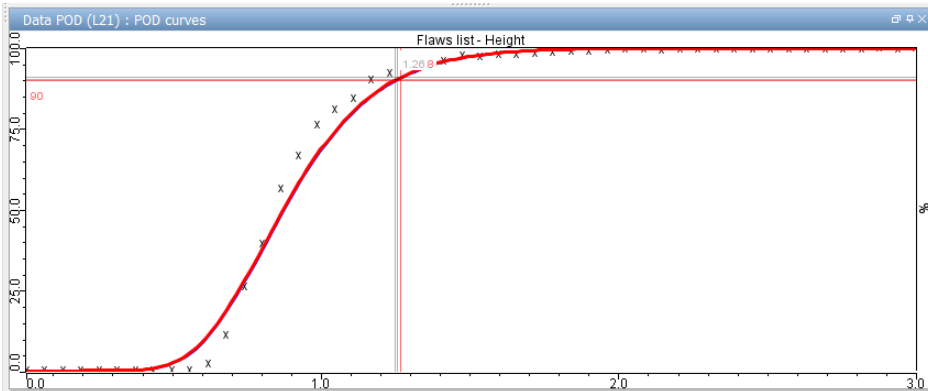
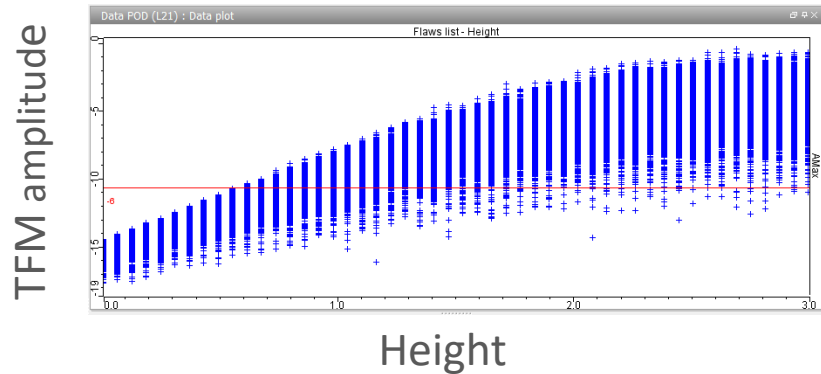

— Logit
x x x x x Hit-miss ratio

POD	90 %
a	1.25
a _{conf.}	1.26

MODEL-BASED RELIABILITY ASSESSMENT

Meta-models for quantitative SENSITIVITY ANALYSIS

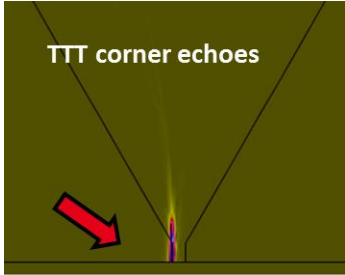

Computation of the Sobol Index

Measure the relative importance of the influential parameters

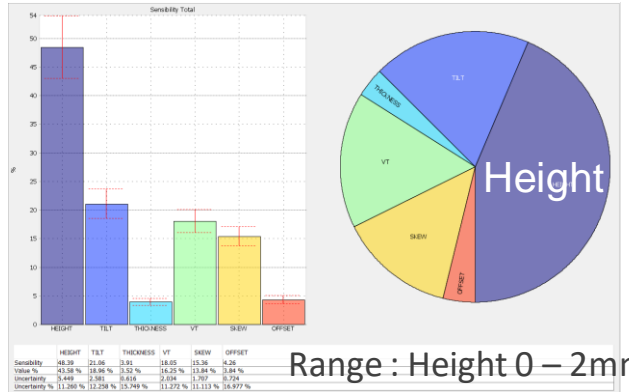
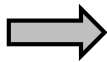
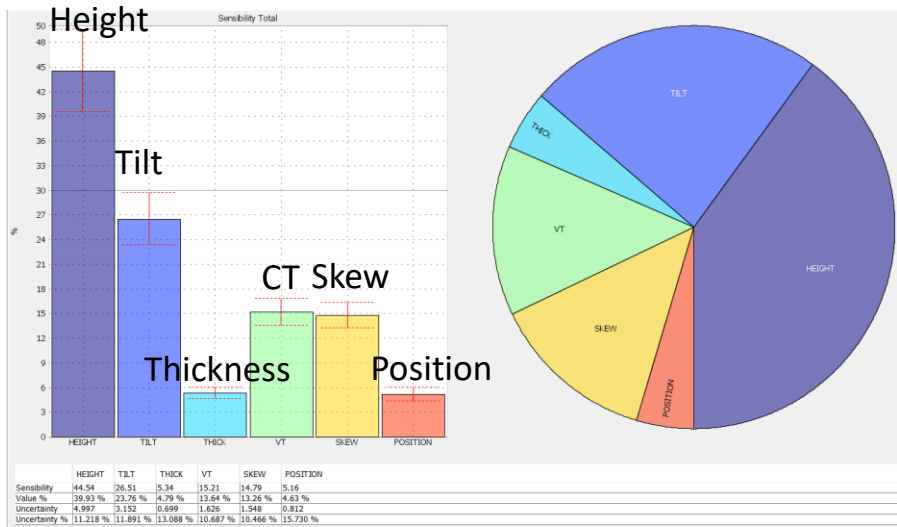

Range : Height 0 – 2mm

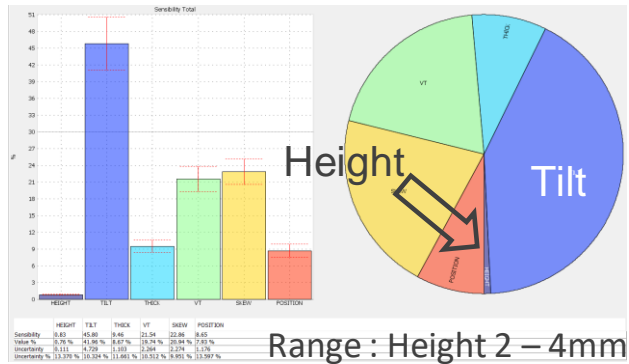

Range : Height 2 – 4mm

Determination of worst cases



Insights for a deterministic technical qualification (driving trials and mock-ups)

Performance demonstration:

- **Reliability**: The ability of the technique to detect defects under realistic conditions
- **Accuracy**: the effectiveness of the technique to size the defect

Modelling has been proven to be helpful for reliability assessment (MAPOD)

Can we imagine similar **model-based accuracy assessment** (accounting for « uncertainty/variability » of influent parameters) ?



The response is YES but I have no time to give details today.

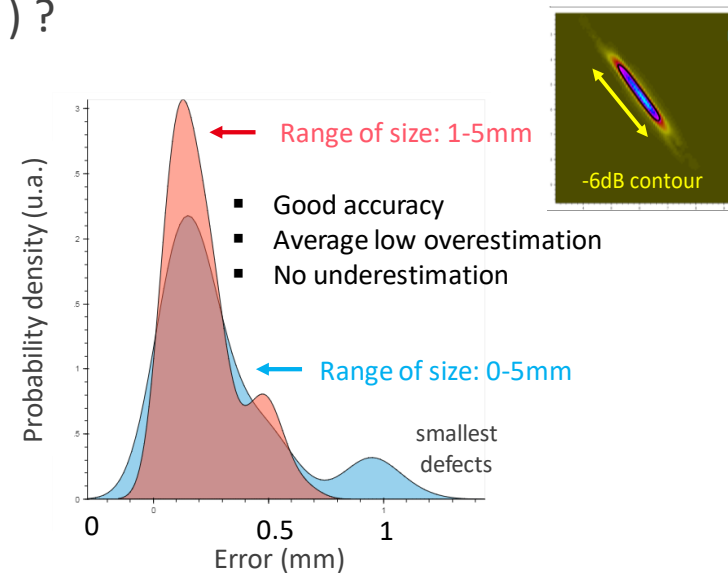

S. Le Berre, X. Artusi, R. Miorelli, E. Iakovleva, P. Calmon, *Simulation and processing tools for the design and performance evaluation of FMC-TFM techniques*, to be published in QNDE 2018 Proc.

HUMAN FACTORS, SIMULATION AND NDE RELIABILITY

How to include Human factors in NDE Reliability process ?

- Growing concern on this issue over the world.

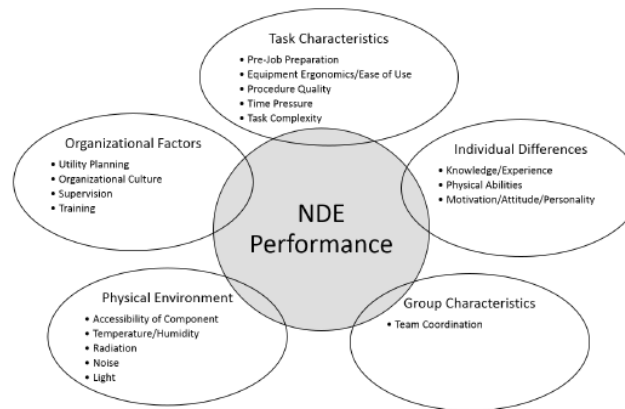
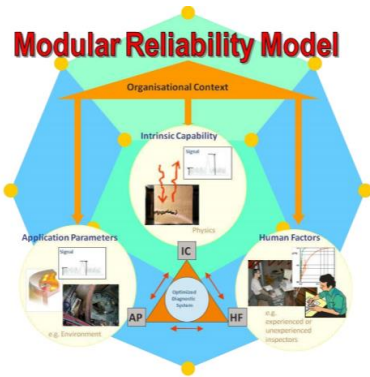

Figure 2. NDE performance influencing factors.



From G. Selby, EPRI, ICNDE 2016

From European-American workshop on NDE reliability and BAM works

From A. D'AGOSTINO, NRC, 2017

- In France, National funded project launched in 2017

AGENCE NATIONALE DE LA RECHERCHE
ANR

FOEHN



HUMAN FACTORS, SIMULATION AND NDE RELIABILITY

How to include Human factors in NDE Reliability process ?

One idea: Monitoring the inspection to capture gesture variability FOEHN

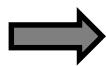

Introduction in MAPOD of realistic variabilities
(probe position/orientation)

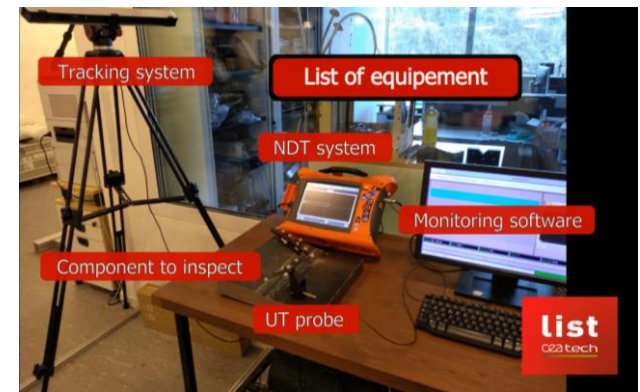
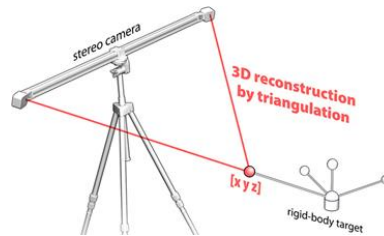

Further step: Coupled to real time simulation, offers the possibility to carry out POD studies in **representative conditions** with **no need of real mock-ups**.

From D. Rodat's PhD, Dec. 2018

3D tracking of
transducer position
($x, y, z, \psi, \theta, \varphi$)

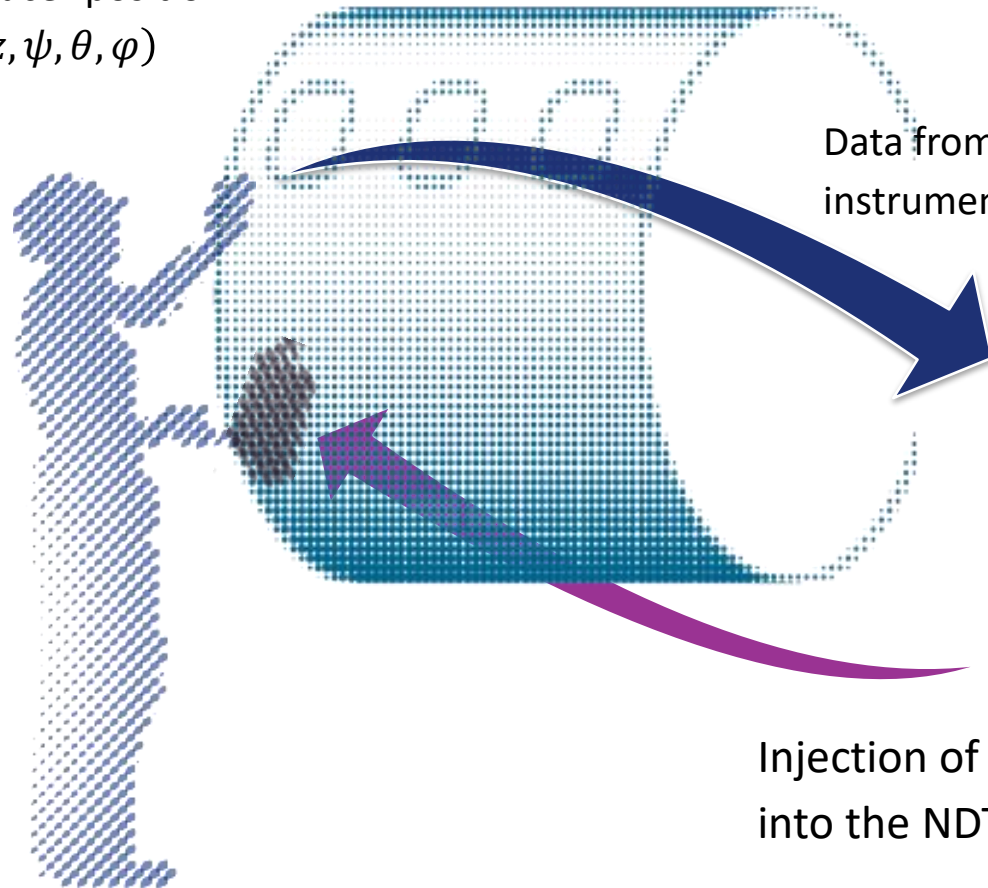

Data from tracking
instrumentation

Definition of the scenario
(introduction of defect)

SIGNAL SYNTHESISER



NDT signals do not come from
the physical mock-up but
from a real-time synthesis.

Injection of the simulation
into the NDT display.

D. Rodat, F. Guibert, N. Dominguez, and P. Calmon, 'Operational NDT Simulator, Towards Human Factors Integration in Simulated Probability Of Detection', in *43rd Rev. Prog. in QNDE*, AIP Conf. Proc. **1806**, 140004 (2017).

- Proof of concept achieved for UT of composite materials.
- Data driven models based on real data for the synthesis of:

3D «ultrasonic texture» due to backscattered noise

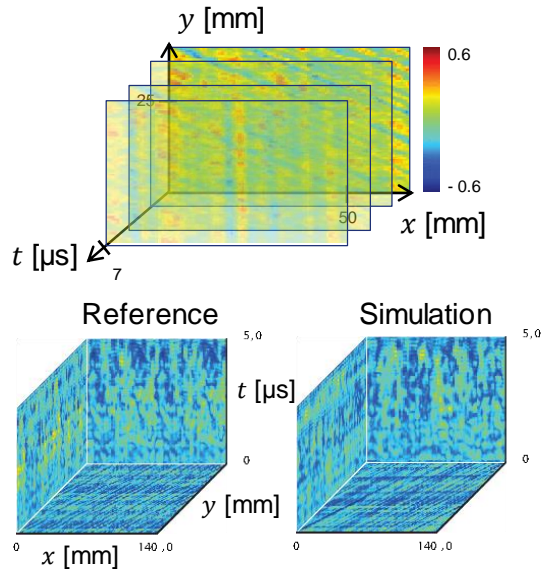

Adaptation of Markov random field (computer graphics algo.)

Ultrasonic response of impact damages (Cscan)

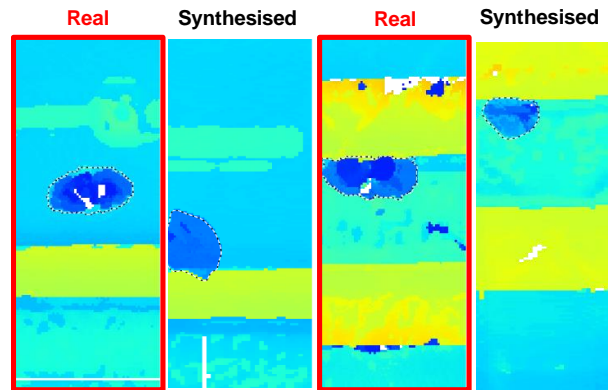

Phenomenological model based on the observation of real Cscans
Realism tested on operators

Ultrasonic responses of FBH

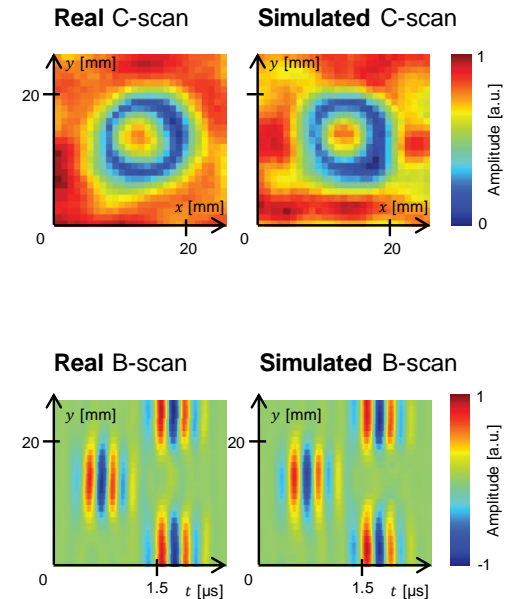

Kriging model enriched by Physics

COMPUTATIONAL TOOLS FOR DIAGNOSTICS:

Imaging, inversion, data analytics

BACKGROUND: FMC-TFM TECHNIQUES



- FMC-TFM: Today fast expanding Ultrasonic Array imaging technique

Principle

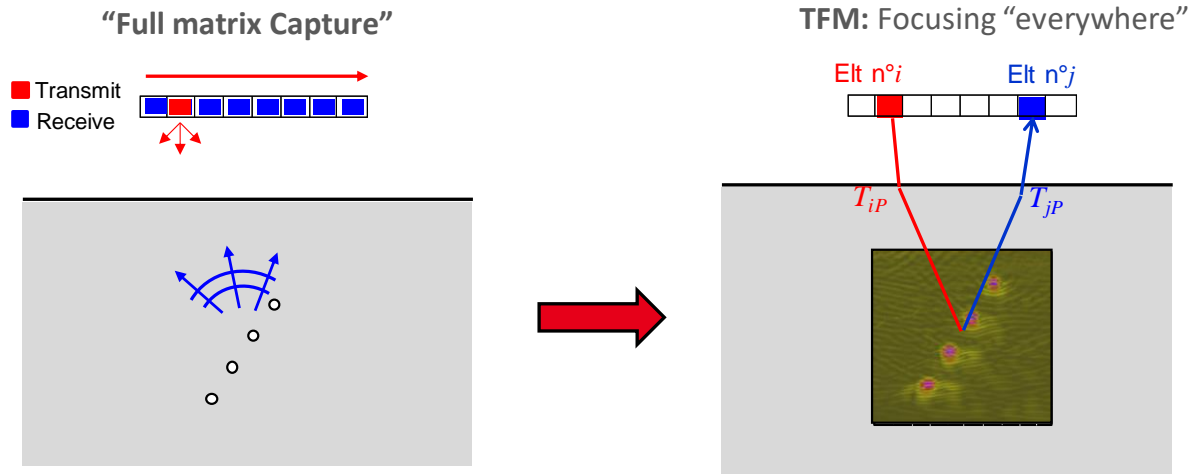

- **FMC:** Acquisition of the signals for all the pairs of T-R elements
- **TFM:** Processing based on the computation of Time of Flights for all the pixels in the image
- Numerous advantages over conventionnal PAUT

Model-based imaging !

How to correct the effect of a lack of knowledge on the material properties ?

➔ Optimization of the imaging : iterative process using metamodels

Sensitivity to the (unknown) material properties

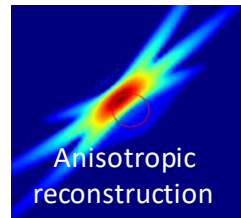
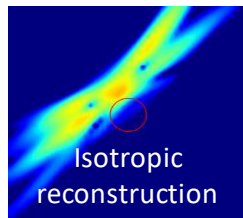
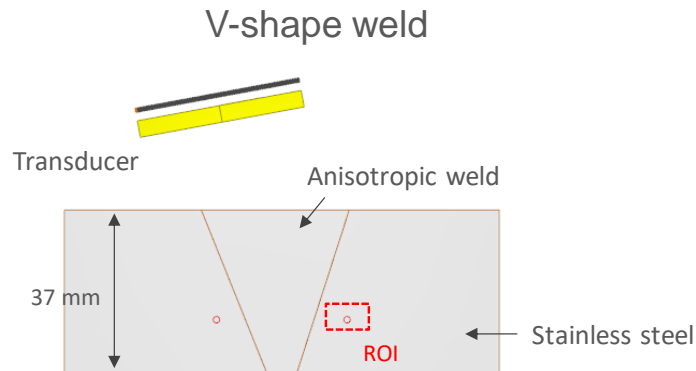

Simulated images

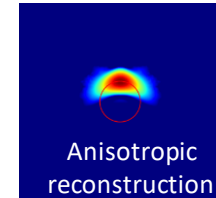
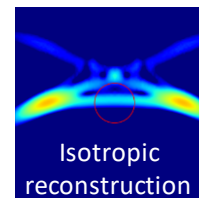
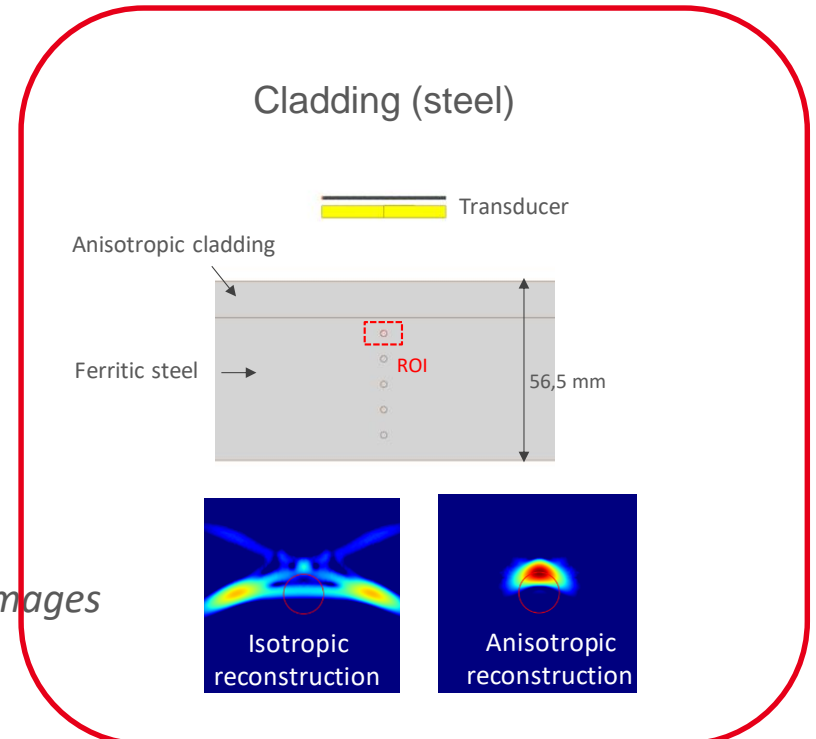

First results on experimental data (cladded component) :

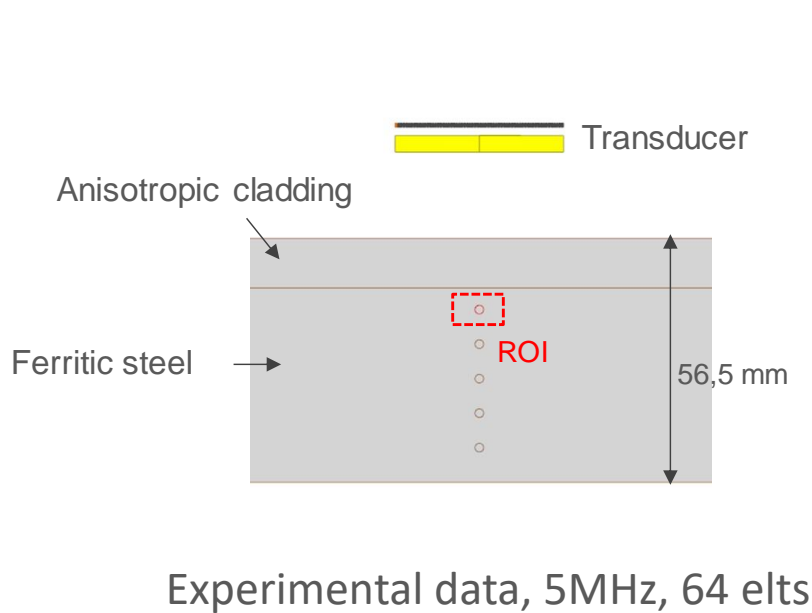

Initial image

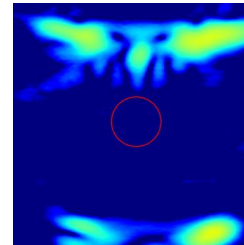

Initial guess

$$C_{ij} = \begin{pmatrix} 250 & 115 & 176 & 0 & 0 & 0 \\ 115 & 250 & 151 & 0 & 0 & 0 \\ 176 & 151 & 197 & 0 & 0 & 0 \\ 0 & 0 & 0 & 117 & 0 & 0 \\ 0 & 0 & 0 & 0 & 131 & 0 \\ 0 & 0 & 0 & 0 & 0 & 58 \end{pmatrix} \text{ GPa}$$

Optimization scheme

Final image

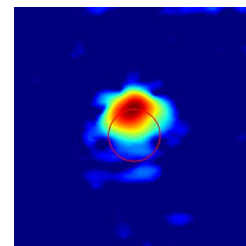

Final guess

$$C_{ij} = \begin{pmatrix} 258 & 115 & 161 & 0 & 0 & 0 \\ 115 & 250 & 151 & 0 & 0 & 0 \\ 161 & 151 & 247 & 0 & 0 & 0 \\ 0 & 0 & 0 & 117 & 0 & 0 \\ 0 & 0 & 0 & 0 & 112 & 0 \\ 0 & 0 & 0 & 0 & 0 & 58 \end{pmatrix} \text{ GPa}$$

BACKGROUND: ELASTIC GUIDED WAVES FOR SHM

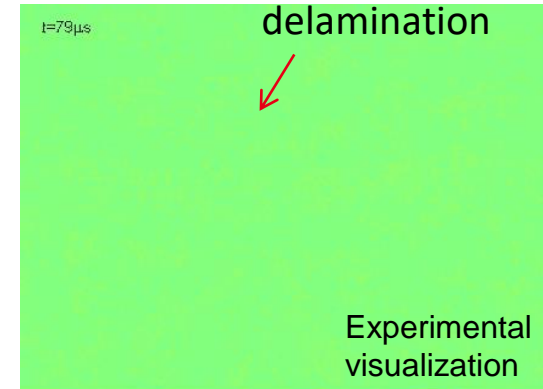
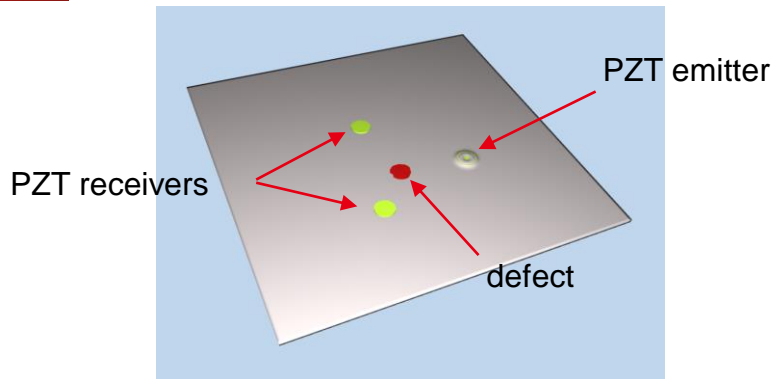

Distributed PZT sensors to emit and receive Guided waves in large structures

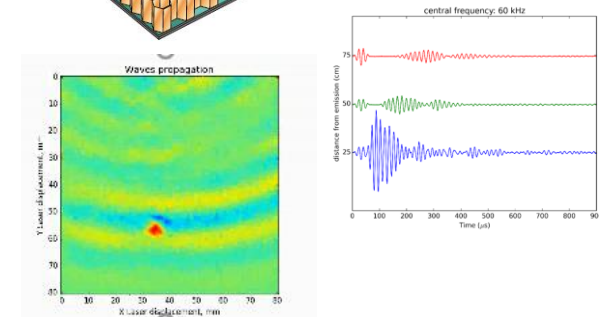
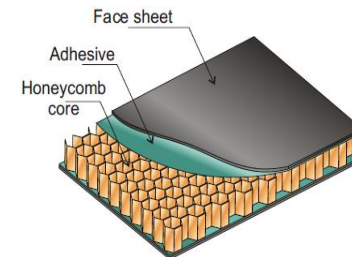
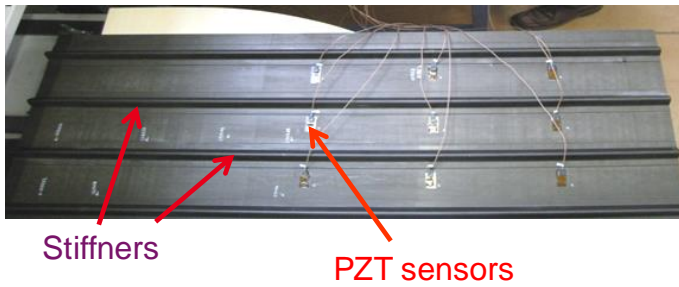

SIMULATION OF GW-SHM: DESIGN + POD + DIAGNOSTIC

- In progress: Development of a CIVA-SHM module
Based on the SEM code : High order FEM + Macromesh

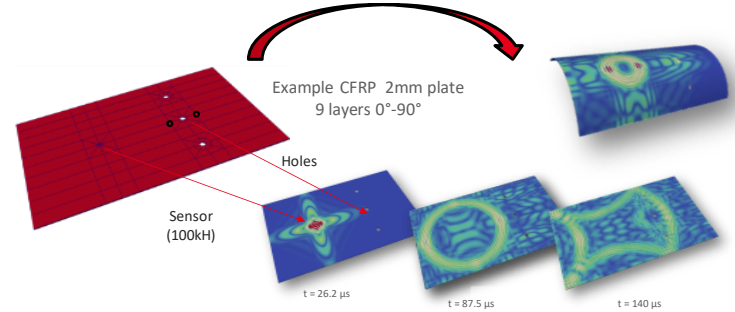

- Evaluated on the recent NASA benchmark (2018)
100 to 1000 x faster !

Benchmark
EFIT
COMSOL
ABAQUS/I
ABAQUS/E
ANSYS

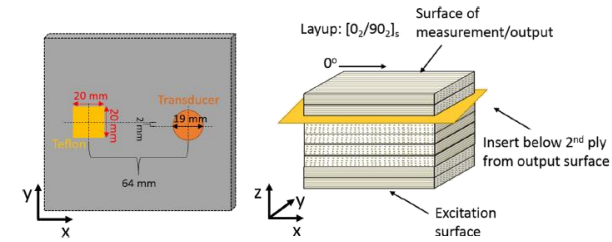

- Experimental validation (signals + images)

Al plate, 3 mm

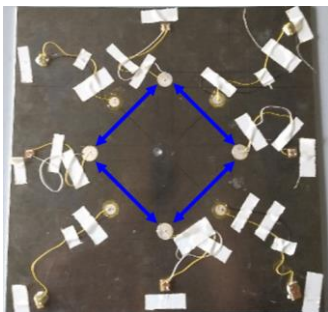

Comparison of signals in pristine

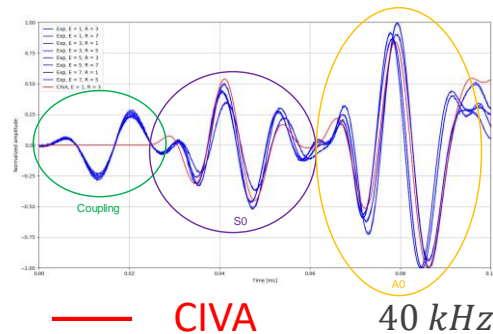

Simulation of imaging algorithms

Experimental

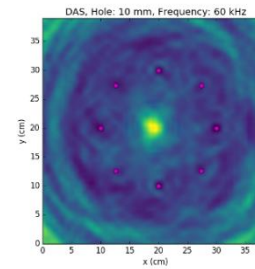

Simulated

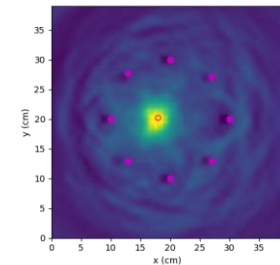

- Imaging/detection relies on comparison to pristine (reference) signals
- Imaging algorithms embedding more or less sophisticated model

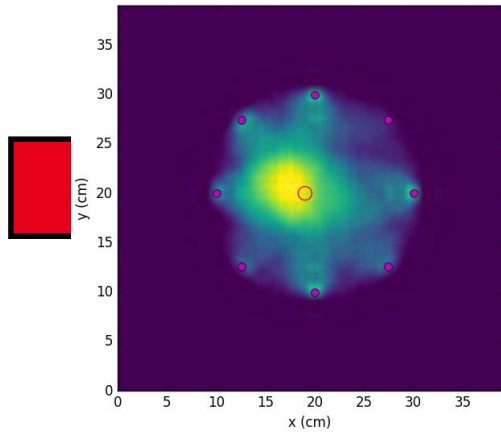

RAPID (Reconstruction Algorithm for Probabilistic Inspection of Damages)

Correlation between pristine and unknown state. **No model**

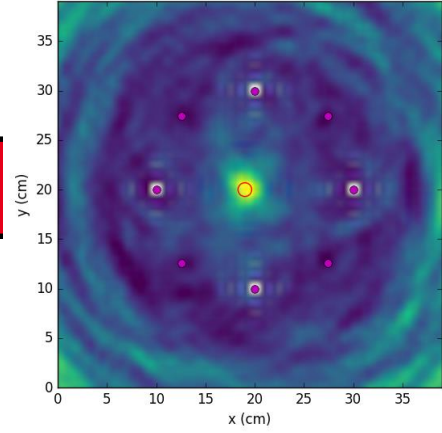

DAS (Delay And Sum)

Sommation of residual signals delayed by **theoretical times of flight**

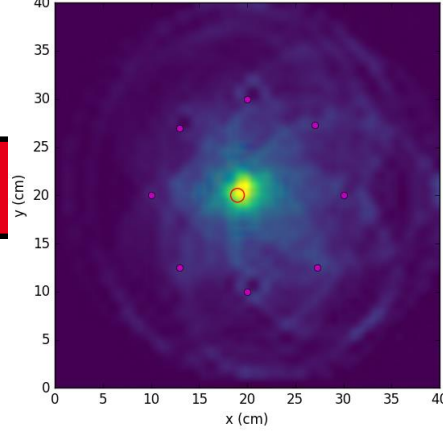

Excitelet

Correlation between residual signals and **theoretical signals at every pixel**

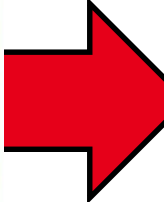

Beyond imaging: Automatic characterization of the defect

Method : Machine learning based inversion

Offline phase: learning the « inverse model »

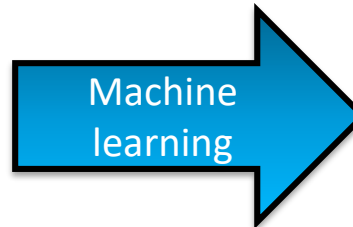
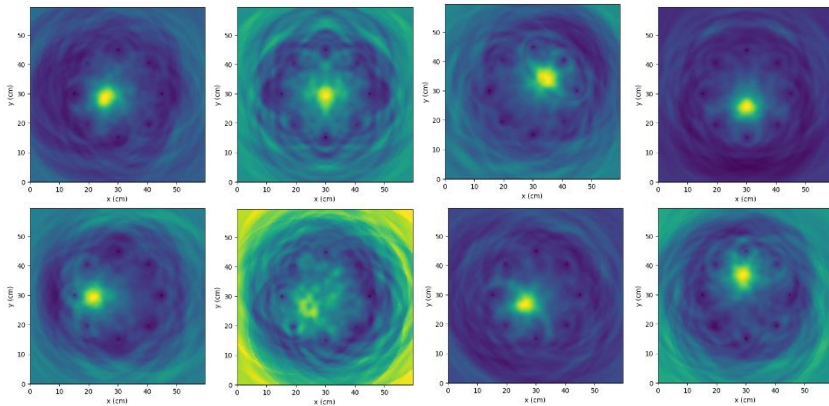

Numerical database (350 simulated images)
Various defect size and position

- Data: Guided wave images (DAS, Excitelet) of holes
- **One required step:** Dimensionality reduction (here PCA)
- Construction of the « inverse metamodel »: Regression (SVM, KRR...) or classification

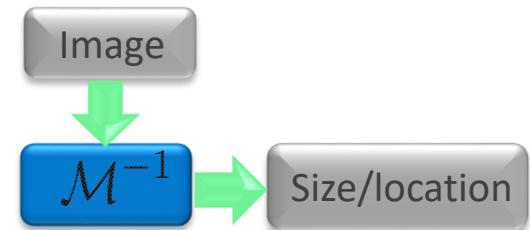

Beyond imaging: Automatic characterization of the defect (size)

Method : Machine learning based inversion

Online phase: Exploitation of the « Inverse metamodel »

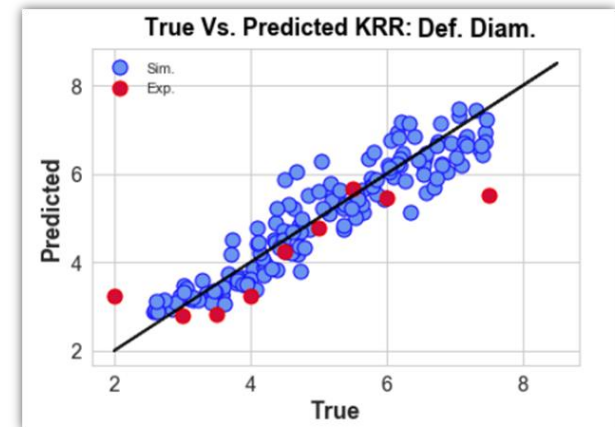
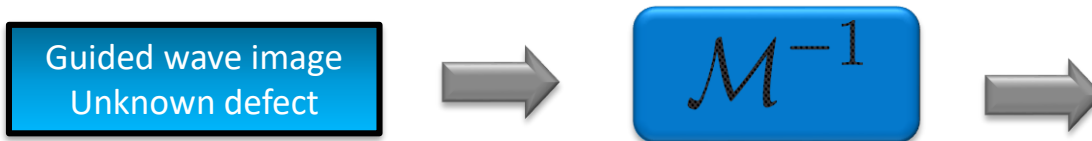

Results

Proof of concept:

- Application to numerical data base (test base, 150 images)
- Average absolute error of 0,3mm in sizing

First results on experimental data:

- Excellent prediction

Predicted size VS true size

Blue: Numerical data

Red: Experimental data

CONCLUSIVE REMARKS

CONCLUSIVE REMARKS

- An always more central role of modelling for fulfilling the challenges of NDE&SHM
- In complement to classical “physics based models” a growing importance of “data based” models built from numerical or real data.
- The use of these meta-models makes possible intensive/real time computations.
- Paves the way for new reliability assessment methodology: Probabilistic AND deterministic, integration of human related factors, accuracy assessment...
- Models are embedded in imaging algorithms and they can feed automatic diagnostic based on iterative inversion or machine learning.

Thank you for your attention

Principal contributors to this talk:

E. Demaldent, A. Imperiale

C. Reboud, S. Leberre

R. Miorelli, D. Rodat

O. Mesnil, A. Kulakovskiy

B. Chapuis, X. Artusi

C. Ménard, S. Robert



Commissariat à l'énergie atomique et aux énergies alternatives
Institut List | CEA SACLAY NANO-INNOV | BAT. 861 – PC142
91191 Gif-sur-Yvette Cedex - FRANCE
www-list.cea.fr

Établissement public à caractère industriel et commercial | RCS Paris B 775 685 019