

# Highlighting and Modeling of Inter-ply Percolation Phenomenon in Stratified Composite

Banda Kane<sup>1</sup>, Guillaume Wasselynck<sup>1</sup>, Didier Trichet<sup>1</sup>, and Gérard Berthiau<sup>1</sup>

<sup>1</sup>Nantes University, IREENA, UR 4642, 37 Boulevard de l'Université, CS 90406, F-44600 Saint-Nazaire, France

## Motivation

### Electromagnetic induction heating of composite material

- Very promising technology for aircraft and spatial industry
- Less energy and short cycle time

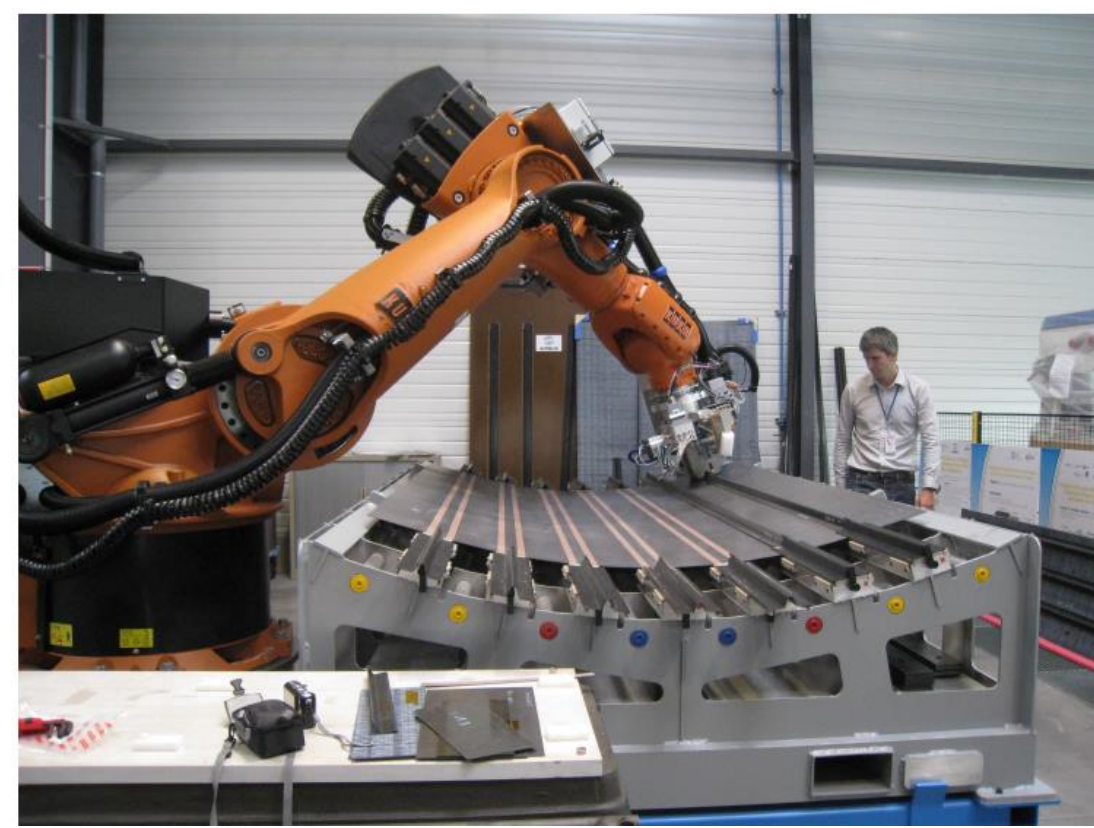
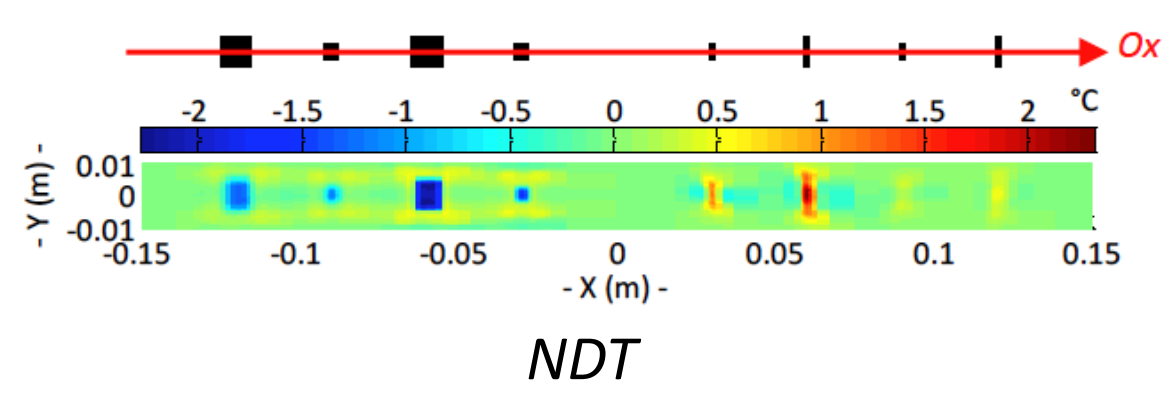

Welding

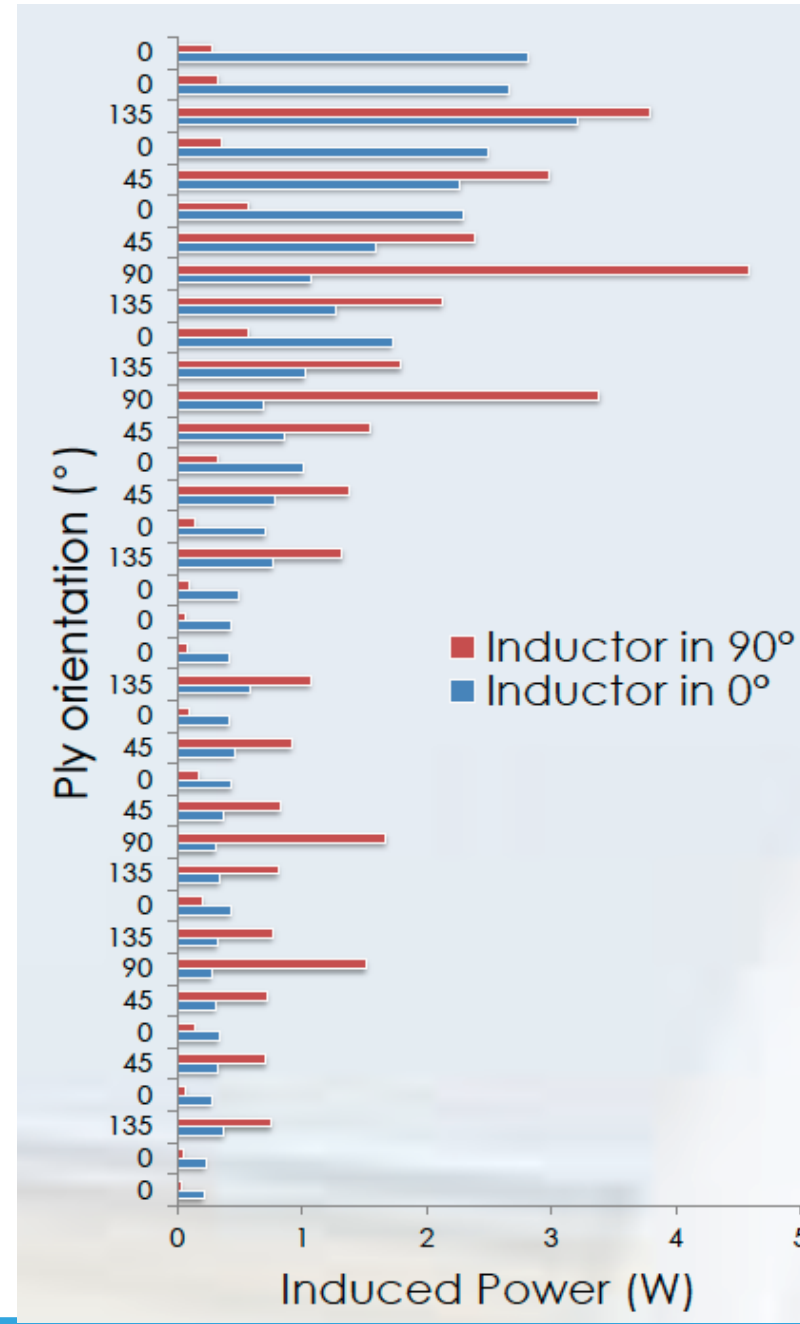
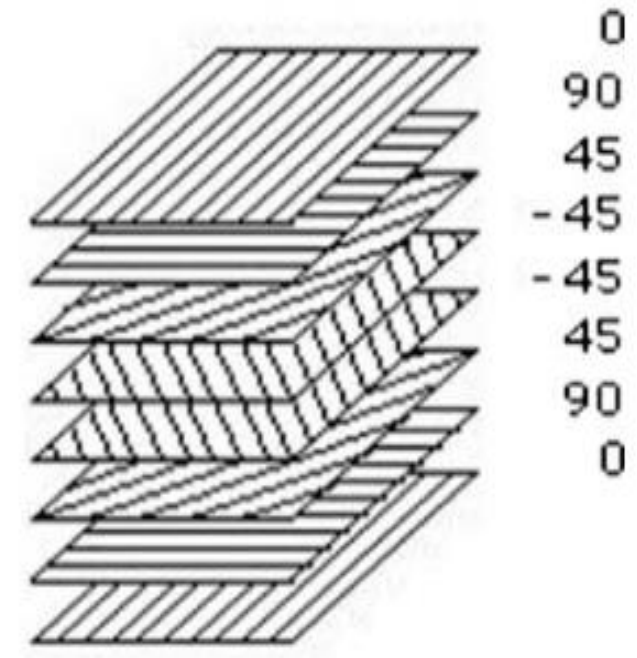

## CRFP Homogenization [1]

Each ply is divided into several Representative Equivalent Volume (REV) with a good statistical representation

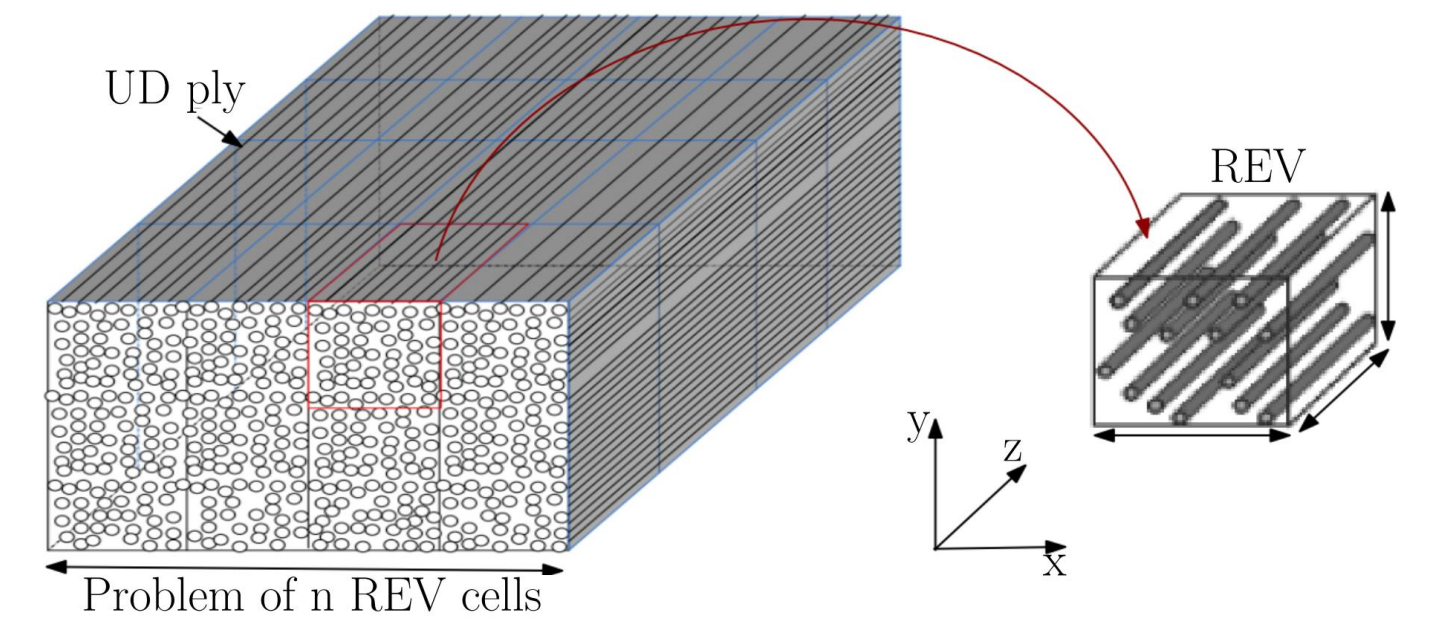

[1] B. Kane, A. Pierquin, G. Wasselynck and D. Trichet, "Coupled Numerical and Experimental Identification of Geometrical Parameters for Predicting the Electrical Conductivity of CFRP Layers," in IEEE Trans. Magn., vol. 56, no. 2, pp. 1-4, 2020.

## Previous works [2]

Electrical tensor calculated only for one fold with the help of virtual material homogenization procedure

$$[\sigma_{0^\circ}] = \begin{pmatrix} 39000 & 0 & 0 \\ 0 & 7.7 & 0 \\ 0 & 0 & 7.7 \end{pmatrix} \text{ S/m} \xrightarrow{\text{mathematical operation}} [\sigma_{90^\circ}] = \begin{pmatrix} 7.7 & 0 & 0 \\ 0 & 39000 & 0 \\ 0 & 0 & 7.7 \end{pmatrix} \text{ S/m}$$

### CONDUCTIVITY MEASUREMENTS

Specimen	SEQUENCE	Conductivity	
		Transverse	Thickness
1	(0) <sub>7</sub>	8.51 S/m	2.07 S/m
2	(0) <sub>7</sub>	7.28 S/m	1.73 S/m
3	(0/90) <sub>3</sub> /0	14744 S/m	5.02 S/m

- Generation of a 3D geometry of the REV taking into account the randomness of the position of the electrical contacts;
- Determining an equivalent impedance network thanks to the generated geometry ;

Not affect the conductivity according to the thickness of the ply

[2] G. Wasselynck, D. Trichet, and J. Fouladgar, "Determination of the electrical conductivity tensor of a CFRP composite using a 3-D percolation model," IEEE Trans. Magn., vol. 49, no. 5, pp. 1825-1828, 2013.

Taking into account interface and relative orientation phenomena

## Calculation method

Generation of several REV cells using the geometry generation algorithm described in [1]

Stacking of two samples oriented at different angles

Use of an electrocinetic 3D model for contact resistance at the ply interface as a function of the angle between the plies and the contact depth,

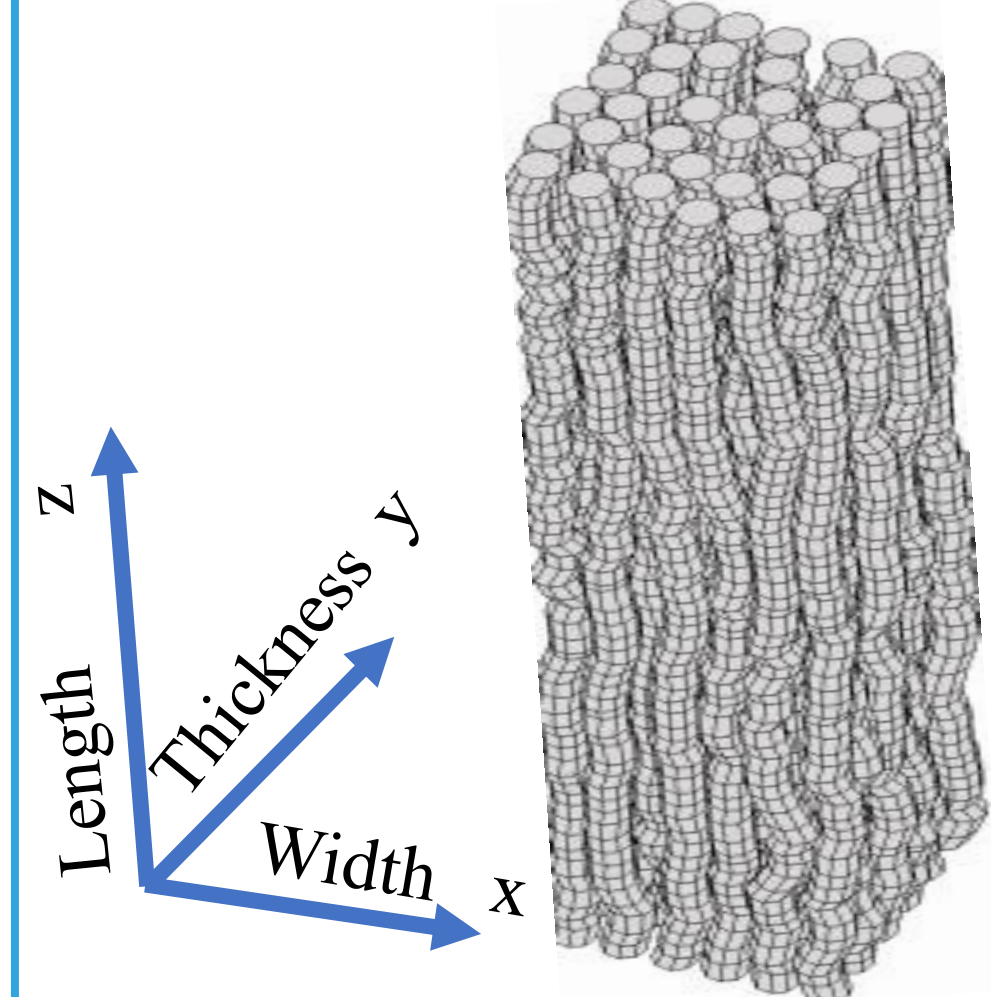

Edge cutting and electrical network coupling

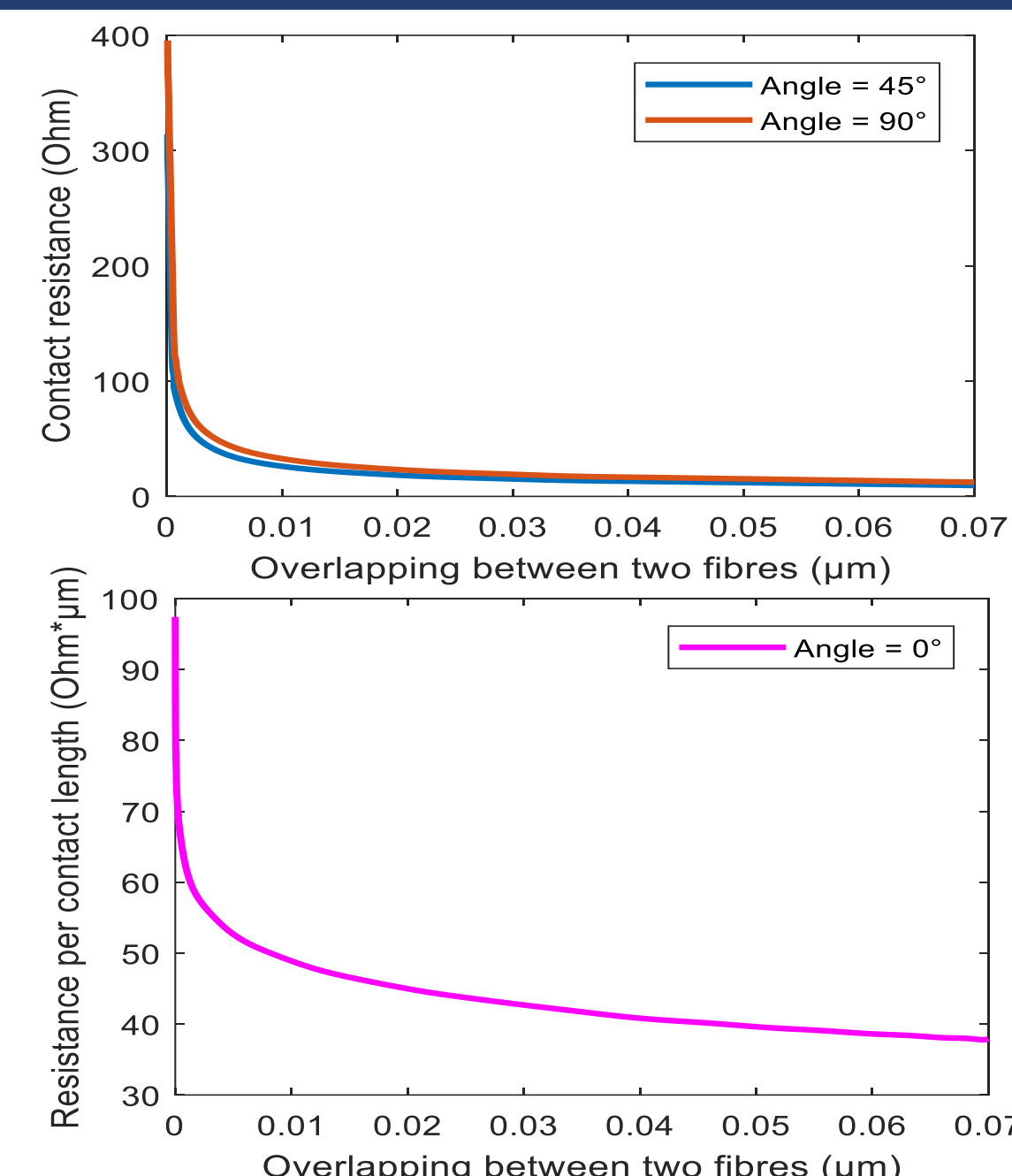
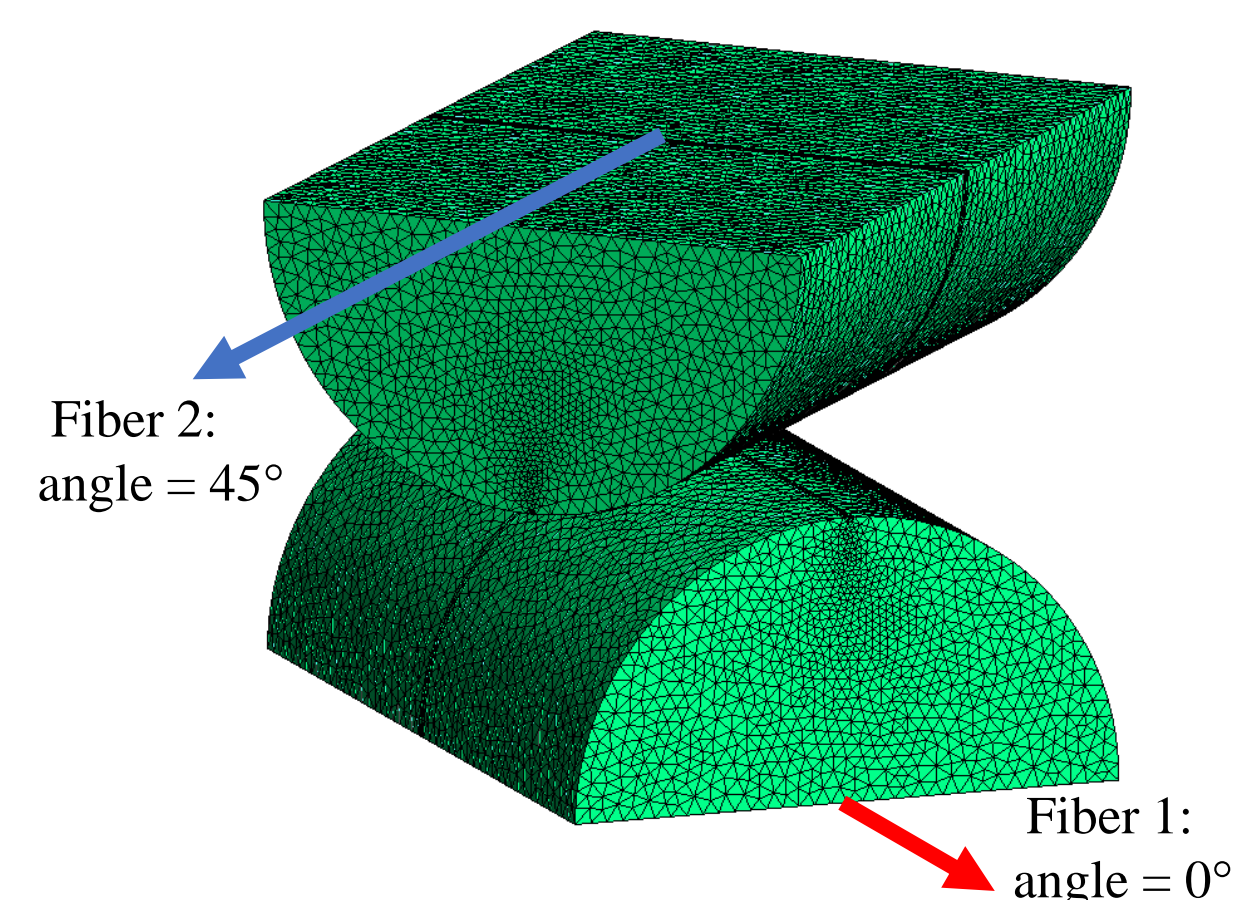
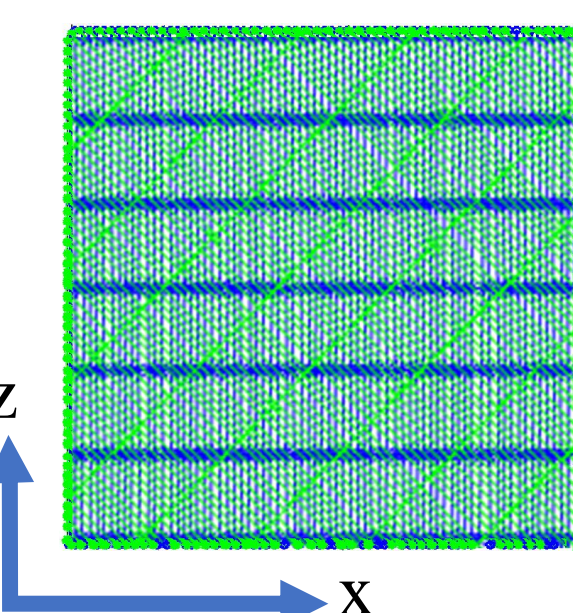

- Assembly of two classical REV with relative orientation to create a new REV which include interface phenomena

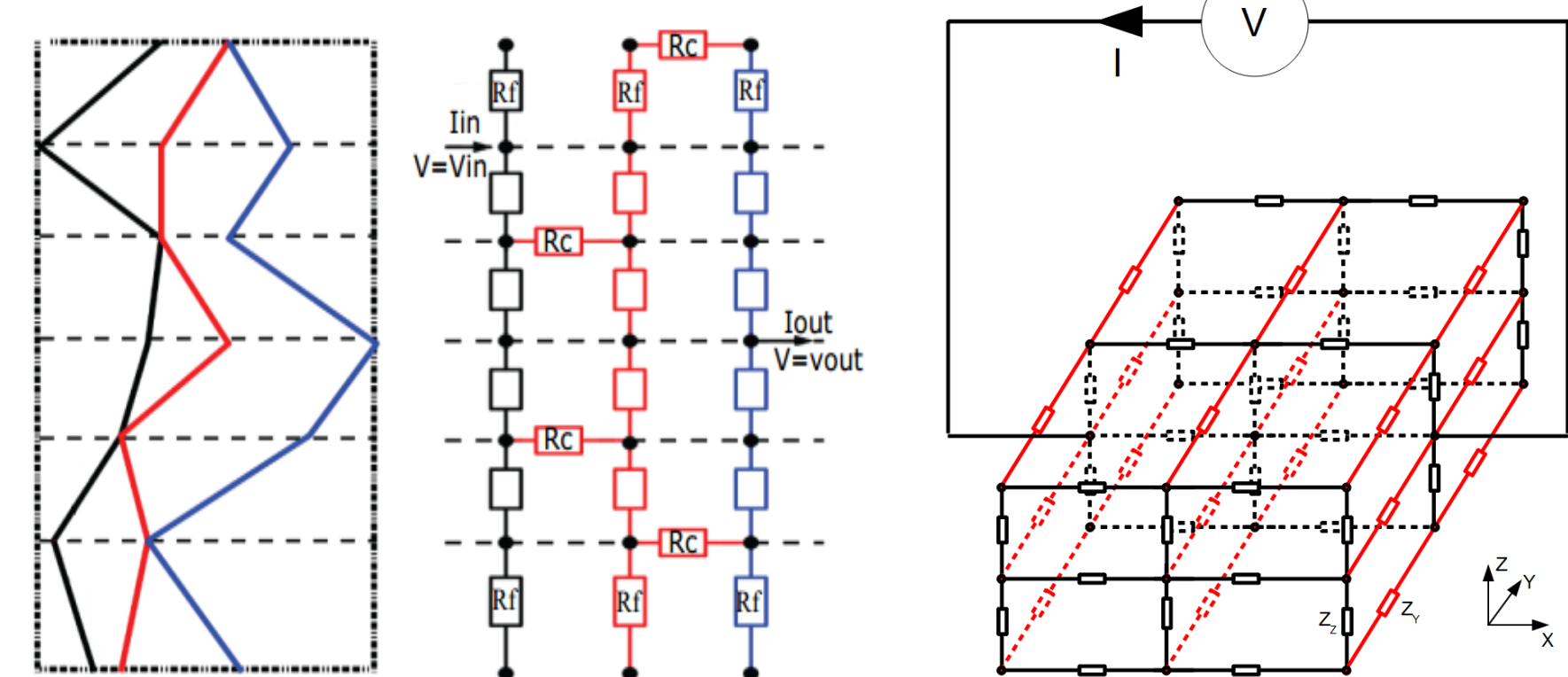

## Upgrading the model

- Influence of the stacking sequence of plies on the conductivity (S/m) according to the thickness

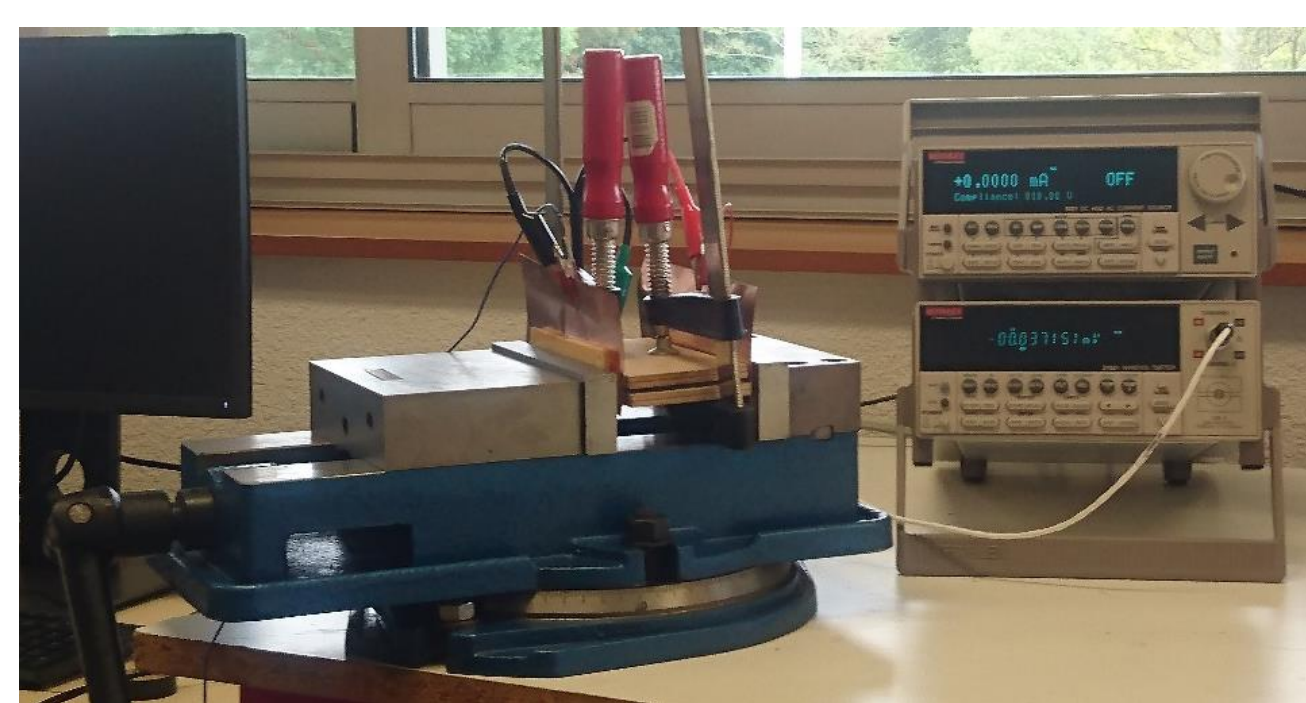
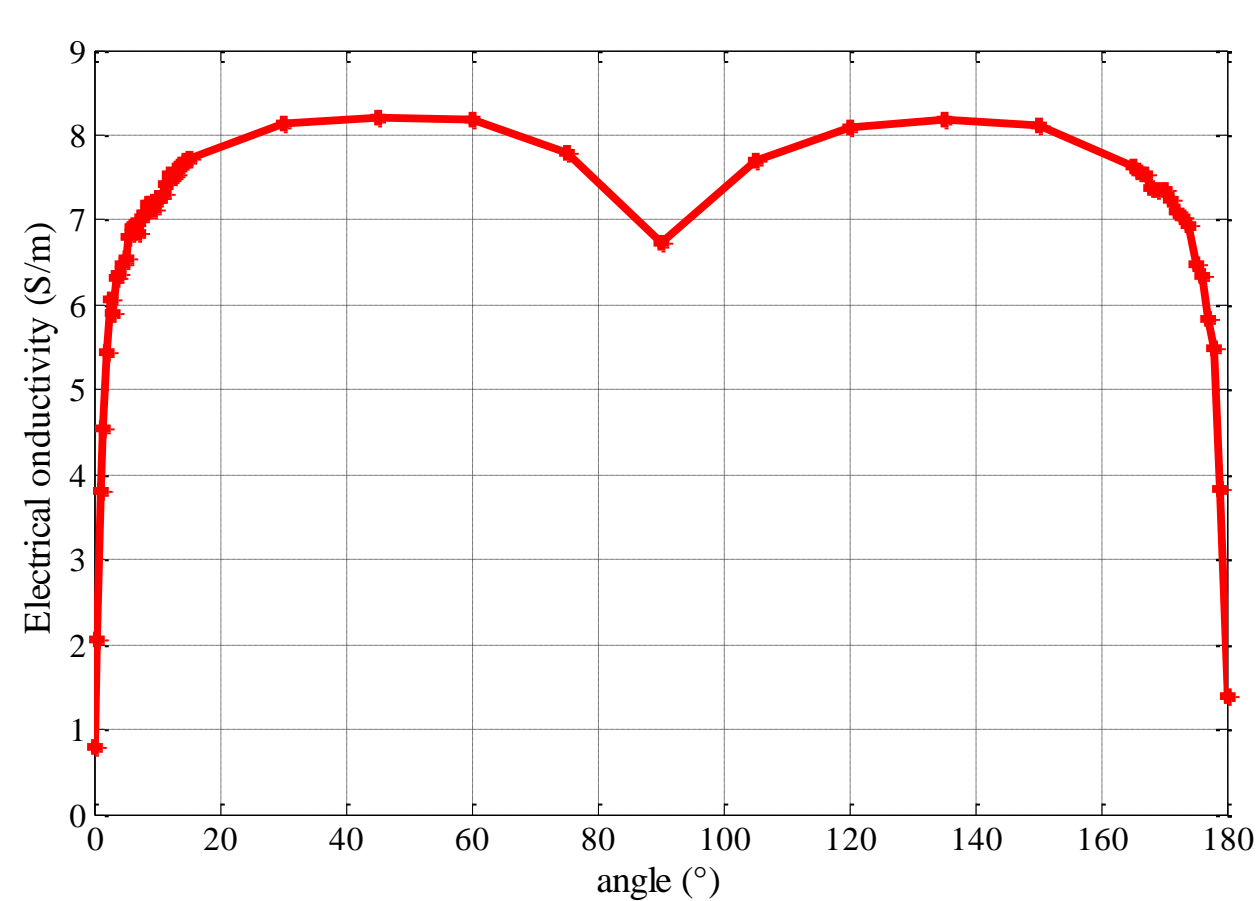

	Measured	Simulated
7 ply UD	1,68 ± 0,06	1,46 ± 0,048
11 ply QI	3,16 ± 0,14	4,33 ± 0,09
19 ply QI	2,56 ± 0,04	3,01 ± 0,067

- Interface thickness sensitivity in 3D simulations of a 11 ply QI and an inductor U with a reference divider factor of 5.

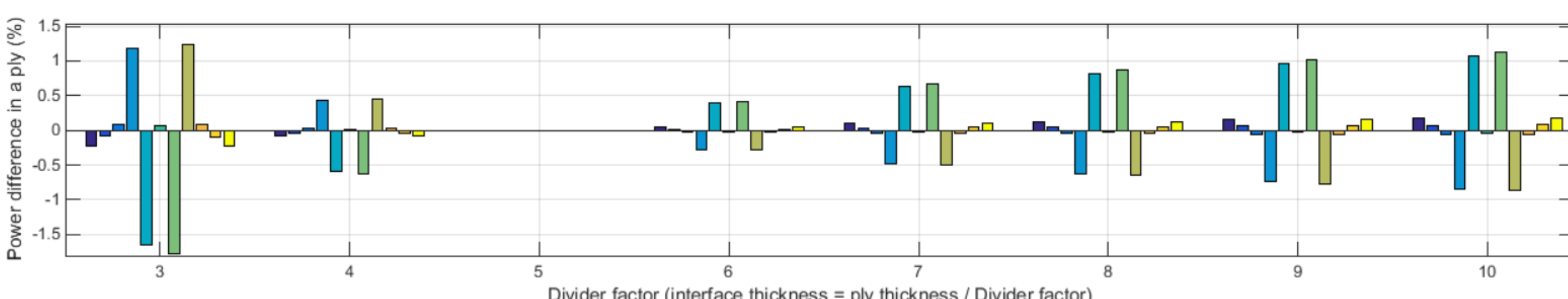

- Consideration of interface phenomena in 3D magneto-thermal simulations: Studies of the temperature map obtained with a 14 ply UD and an inductor U

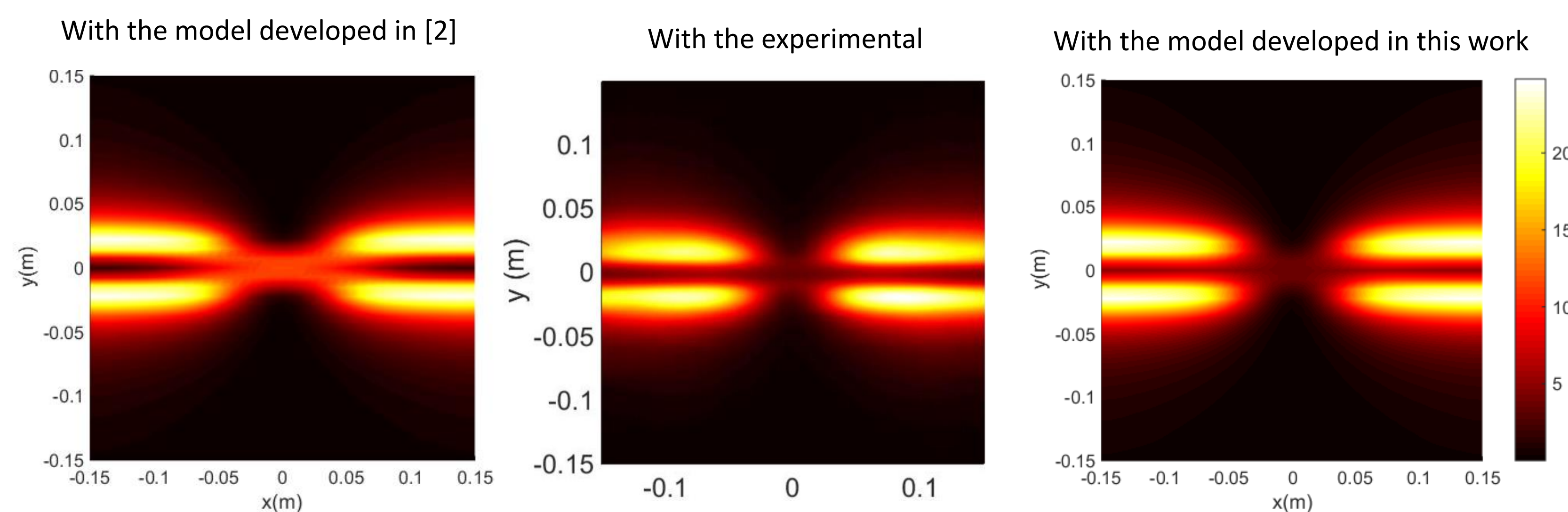

- Difference between the two models

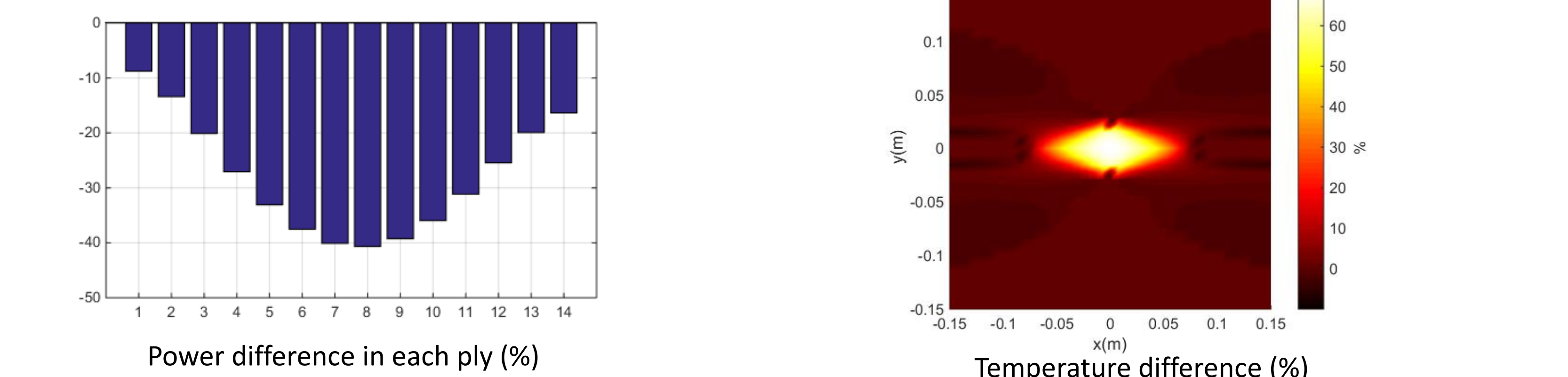

## Conclusion

- Variation of conductivity according to thickness as a function of the relative angle of orientation of fibers
- Very important impact of the sequence of plies on the conductivity value
- The impact is more pronounced at the interface of two plies oriented in the same direction
- The developed model gives results closer to the experimental than the old model

