



HAL
open science

Lode angle dependency due to anisotropic damage

A Mattiello, Rodrigue Desmorat

► **To cite this version:**

A Mattiello, Rodrigue Desmorat. Lode angle dependency due to anisotropic damage. International Journal of Damage Mechanics, 2021, 30 (2), pp.214-259. 10.1177/1056789520948563 . hal-04513689

HAL Id: hal-04513689

<https://hal.science/hal-04513689>

Submitted on 16 Apr 2024

HAL is a multi-disciplinary open access archive for the deposit and dissemination of scientific research documents, whether they are published or not. The documents may come from teaching and research institutions in France or abroad, or from public or private research centers.

L'archive ouverte pluridisciplinaire **HAL**, est destinée au dépôt et à la diffusion de documents scientifiques de niveau recherche, publiés ou non, émanant des établissements d'enseignement et de recherche français ou étrangers, des laboratoires publics ou privés.

Lode angle dependency due to anisotropic damage

A. Mattiello¹ and R. Desmorat²

Abstract

The lode angle dependency introduced by anisotropic damage evolution laws is analyzed in detail for initially isotropic materials. Many rupture criteria are obtained, under the proportional loading assumption, by the time integration of different anisotropic damage evolution laws $\dot{\mathbf{D}} = \dots$ among the three existing families : strain governed, stress governed and plastic strain governed. The cross-analysis of path independent rupture criteria and of anisotropic damage evolution laws finally allows us to improve the Lode angle dependency of (fully coupled) anisotropic damage models.

Keywords

continuum damage mechanics, rupture criterion, induced anisotropy, plasticity, third invariant

Introduction

Since the pioneering work of Johnson et al (1956, 1962), Freudenthal and Geiringer (1958), Cockroft and Latham (1968), Hayhurst (1972) and Leckie and Hayhurst (1974), the material sensitivity to the local stress state has been studied in the literature for many different alloys. Nowadays it is widely accepted that damage of metallic materials is governed by plasticity and enhanced by the stress state (Rice and Tracey, 1969, Gurson, 1977, Lemaitre and Chaboche, 1985, 1991, Lemaitre et al, 2009). Depending on the nature of the alloy and on the damaging process leading to rupture, particular stress states can be more detrimental than others. Under brittle failure conditions, the maximum principal local stress has to be considered (Johnson et al, 1956, Leckie and Hayhurst, 1974, Di Iorio et al, 2007, Lindner, 2016). Furthermore, some materials exhibit a particular sensitivity to shear. Examples of multiaxiality effect can be found in the pioneering works of Johnson et al (1960, 1962), of Leckie and Hayhurst (1974) as well as in recent ones (Nahshon and Hutchinson, 2008, Xue, 2007, Lou and Huh, 2013, Papasidero et al, 2015, Defaïsse et al, 2018).

Since complex stress states are encountered in structures, the key point for components design is to formulate damage evolution laws and/or rupture criteria which properly describe the sensitivity to the stress multiaxiality of the damaging process. A first way of modeling consists in enriching the yield/rupture criteria and/or the isotropic damage laws with the stress tensor invariants. A second way is to formulate anisotropic damage evolution laws (Chaboche, 1979).

The development in the 1970s of the isotropic failure criteria for tertiary creep was closely linked to the development of damage models. Indeed, Hayhurst (1972) introduced his equivalent stress for multiaxial creep, a linear combination of maximum principal stress $\sigma_{\text{Max}} = \sigma_1$, of hydrostatic stress $\sigma_H = \text{tr } \boldsymbol{\sigma} / 3$ and of von Mises stress $\sigma_{eq} = (\frac{3}{2} \boldsymbol{\sigma}' : \boldsymbol{\sigma}')^{1/2}$ (with $\boldsymbol{\sigma}'$ the deviatoric stress tensor), allowing for some modularity in the description of the isochronous creep curves. Scalar equations for void nucleation and growth have

¹ Safran Aircraft Engines, Rond Point René Ravaud, 77550 Moissy Cramayel, France

² Université Paris-Saclay, ENS Paris-Saclay, CNRS, LMT - Laboratoire de Mécanique et Technologie, 91190, Gif-sur-Yvette, France

Email: rodrigue.desmorat@ens-paris-saclay.fr

later been proposed in (Dyson and McLean, 1977, Gurson, 1977, Chu and Needleman, 1980) leading to the formulation of the GTN model (Tvergaard and Needleman, 1984) in which void growth is enhanced by the stress triaxiality

$$T_X = \frac{1}{3} \frac{\text{tr } \boldsymbol{\sigma}}{\sigma_{eq}} = \frac{\sigma_H}{\sigma_{eq}}. \quad (1)$$

The damage enhancement by stress triaxiality has then been accounted for in Lemaitre damage evolution law *via* a triaxiality function R_ν (Lemaitre, 1984, 1985, Lemaitre and Chaboche, 1985, 1991).

On the other hand, damage induced anisotropy was modeled in the works of Rabotnov (1969), Martin and Leckie (1972) and Hayhurst and Leckie (1973), where a (scalar) damage variable D was associated with the maximum principal stress only, namely $\sigma_{\text{Max}} = \sigma_1$. An effective stress was defined as follows: $\tilde{\sigma}_1 = \sigma_1/(1 - D)$, $\tilde{\sigma}_2 = \sigma_2$, $\tilde{\sigma}_3 = \sigma_3$, with σ_i the principal stresses. A more rigorous—fourth order tensorial—damage framework was derived in (Chaboche, 1979, Leckie and Onat, 1981, Onat, 1984) (see also the works of Ortiz (1985), Ju (1989) and even of Chaboche (1978) for an eight order damage tensor). In a more practical manner, a second order tensor for damage has been considered by Murakami and Ohno (1978), Cordebois and Sidoroff (1982), Ladevèze (1983), Murakami (1988). Other anisotropic damage models can be found in literature for concrete (Bazant and Gambarova, 1984, Bazant and Prat, 1988a, Ramtani et al, 1992, Govindjee et al, 1995, Fichant et al, 1997, Kuhl and Ramm, 1998, Badel et al, 2007, Halm and Dragon, 1998, Meschke et al, 1998, Desmorat et al, 2007, Pröchtel and Häußler-Combe, 2008, Chambart et al, 2014) as well as for metals (Chaboche, 1984, Papa and Taliercio, 1996, Steinmann and Carol, 1998, Lemaitre et al, 2000, Carol et al., 2001, Menzel and Steinmann, 2001, Menzel et al, 2002, Billardon and Pétry, 2005, Desmorat and Cantournet, 2008, Nguyen et al, 2011, Brüning et al, 2013, Badreddine et al, 2015, Yue et al, 2015, Wulfinghoff et al, 2017).

Focusing on materials exhibiting a failure sensitivity to shear, studies have shown that for such materials no standard ductile rupture modeling did work well on the entire range of stress triaxiality and that the third stress invariant had to be considered (Xue, 2007, Nahshon and Hutchinson, 2008, Li et al, 2011, Malcher et al, 2012, Papisidero et al, 2015, Defaisse et al, 2018). Isotropic damage/porosity growth formulations enriched by the third stress invariant have then been proposed. For instance, extensions of weakly coupled GTN model can be found in (Nahshon and Hutchinson, 2008, Gao et al, 2011, Danas and Ponte Castañeda, 2012), extensions of fully coupled isotropic Lemaitre's type damage models in (Cao et al, 2014, Malcher and Mamiya, 2014). Accordingly, new rupture criteria have then been formulated as post-processing/uncoupled approaches.

We point out that it is often possible to derive an uncoupled rupture criterion from an existing fully coupled damage model by assuming monotonic proportional loading and by neglecting the coupling of elasto-plasticity with damage (Lemaitre (1984, 1992), see also the review by Bai and Wierzbicki (2015) and the works of Mohr and Marcadet (2015) and of Defaisse et al (2018)). For instance, in the case of Nahshon and Hutchinson (2008) extension of fully coupled GTN model, the void volume fraction ϕ follows the rate equation

$$\dot{\phi} = (1 - \phi) \text{tr } \dot{\boldsymbol{\epsilon}} + \kappa \phi (1 - \mathcal{L}^2) \dot{p}, \quad (2)$$

with $\boldsymbol{\epsilon}$ the total strain tensor, p the isotropic accumulated plastic strain, $\dot{\boldsymbol{\epsilon}}^p$ being plastic strain rate tensor,

$$p = \int \sqrt{\frac{2}{3} \dot{\boldsymbol{\epsilon}}^p : \dot{\boldsymbol{\epsilon}}^p} dt. \quad (3)$$

In (2) κ is a material constant or a function and $\mathcal{L} = \cos 3\Theta \in [-1, 1]$ is dimensionless Lode (1926) parameter, *i.e.* the normalized third invariant of deviatoric stress tensor, $\Theta \in [0, \frac{\pi}{3}]$ being Lode angle (precisely defined in Section "Lode angle dependency of existing criteria"). Let us then follow Defaisse et al (2018) and replace the volume conservation term $(1 - \phi) \text{tr } \dot{\boldsymbol{\epsilon}}$ in (2) by a Rice and Tracey void growth term $A \exp(aT_X) \dot{p}$ (governed by the accumulated plastic strain p and enhanced by the stress triaxiality T_X),

$$\dot{\phi} \approx A \exp(aT_X) \dot{p} + \kappa \phi (1 - \mathcal{L}^2) \dot{p}, \quad (4)$$

which is generalized into

$$\dot{\phi} \approx A \exp(aT_X) \dot{p} + \kappa \phi (1 - |\mathcal{L}|^m) \dot{p}, \quad (5)$$

with A , a and m assumed as material constants. Assuming furthermore $\kappa\phi = Ab = \text{const}$, the accumulated plastic strain to rupture is then, by time integration in monotonic proportional loading up to a critical porosity ϕ_c (Defaisse et al, 2018):

$$p = \frac{\phi_c}{A [\exp(aT_X) + b(1 - |\mathcal{L}|^m)]}. \quad (6)$$

It depends both on the stress triaxiality and on the third invariant of the deviatoric stress tensor (through Lode parameter \mathcal{L}). The value $m = 2$ will next be referred to as Nahshon-Hutchinson limiting case, even if a (slightly) different definition for Lode parameter is used (Section "*Lode angle dependency of existing criteria*").

If the third invariant has to be introduced explicitly in isotropic damage laws (Cao et al, 2014, Malcher and Mamiya, 2014), this may not be necessary for anisotropic damage. Indeed, Desmorat (2012, 2016), qualitatively, and Badreddine et al (2015), quantitatively in a fully coupled approach, have shown that an effect of the third invariant is automatically accounted for when anisotropic damage is used. The objective of present work is to illustrate this property in a systematic manner and to qualify the kind of Lode angle effect obtained in octahedral planes from different evolution laws for induced anisotropic damage. Most of these tensorial evolution laws, for symmetric second order damage tensor \mathbf{D} of components D_{ij} , have the generic form

$$\dot{\mathbf{D}} = A \langle \dot{\mathbf{\Delta}} \rangle_+ \quad \left(\text{i.e. } \dot{D}_{ij} = A \langle \dot{\mathbf{\Delta}} \rangle_{+ij} \right), \quad (7)$$

possibly generalized as (Desmorat et al, 2010)

$$\dot{\mathbf{D}} = A \left(\zeta \langle \dot{\mathbf{\Delta}} \rangle_+ + (1 - \zeta) |\dot{\mathbf{\Delta}}| \right) \quad \left(\text{i.e. } \dot{D}_{ij} = A \left(\zeta \langle \dot{\mathbf{\Delta}} \rangle_{+ij} + (1 - \zeta) |\dot{\mathbf{\Delta}}|_{ij} \right) \right), \quad (8)$$

with $\mathbf{\Delta}$ the second order tensor governing the damage growth, ζ a material parameter, and A a material constant (or a function of the stress triaxiality (Lemaitre, 1984), but not of the stress level nor of the Lode angle itself in a first analysis). The simplest laws consider $\mathbf{\Delta} = \boldsymbol{\epsilon}$, the total strain tensor, or $\mathbf{\Delta} = \tilde{\boldsymbol{\sigma}}$, the effective stress tensor, or $\mathbf{\Delta} = \boldsymbol{\epsilon}^p$, the plastic strain tensor. The notations $\langle \dot{\mathbf{\Delta}} \rangle_+$ and $|\dot{\mathbf{\Delta}}|$ stand respectively for the positive part and the absolute value of symmetric second order tensor $\dot{\mathbf{\Delta}}$ in terms of principal values (Lemaitre and Desmorat, 2005). They ensure that $\dot{\mathbf{D}}$ is positive semidefinite for any loading, proportional or not.

In order to study theoretically the Lode angle effect, not on one but, in a systematic manner, on several anisotropic damage evolution laws $\dot{\mathbf{D}} = \dots$, it is needed to make a few simplifying assumptions (so that a derivation similar to the one for void growth law (2) can be performed). First of all, the analysis is restricted next to initially isotropic materials and when plasticity is involved that it obeys the von Mises (1928) criterion. The systematic study of the effect of the hydrostatic stress $\sigma_H = \text{tr } \boldsymbol{\sigma} / 3$ on rupture is left to further work and each criterion is plotted only in the octahedral plane at a constant and sufficiently high σ_H (or, in several cases, at a constant triaxiality T_X). To obtain closed form expressions for the rupture conditions, our analysis is restricted to the so-called monotonic proportional loading for which the principal stress directions as well as the ratios of the principal stresses remain fixed, with no unloading (the normal to yield surfaces remain then constant). The damage threshold, below which there is no damage (Lemaitre, 1984), is neglected. Our analysis is also restricted to two strain governed damage laws (Section *Strain induced damage anisotropy*), three stress governed damage laws (Section "*Stress induced damage anisotropy*") and finally to two plastic strain governed anisotropic damage laws (Section "*Plastic strain induced damage anisotropy*").

Note that, when plotted, the rupture criteria will be most often normalized with respect to rupture condition at vanishing Lode angle (at $\Theta = 0$, i.e. $\mathcal{L} = 1$). This choice will allow us to better compare the Lode angle dependency introduced by each criterion/damage law in octahedral plane.

Outline. The first section is dedicated to the description of the Lode angle dependency of existing rupture criteria. This first section is mainly a literature survey, but in which one summarizes and compares both

the mechanical engineering standard failure criteria and the civil engineering ones. The second, third and fourth sections address then the Lode angle dependency inherent in the damage evolution laws, written in a rate form $\dot{\mathbf{D}} = \dots$, of fully coupled anisotropic damage models. For the sake of relative simplicity, both the proportional loading and the post-processing (uncoupled) assumptions are made, so that, originality of the present work, the Lode angle dependency obtained for many different anisotropic damage laws is plotted and analyzed. Load angle dependency enhancements of the anisotropic damage evolution laws are furthermore proposed. Examples of such enhanced fully coupled damage models are given in Appendix B.

Lode angle dependency of existing criteria

Isotropic criterion functions $f = f(\boldsymbol{\sigma})$, defining either plasticity or rupture surfaces, are function of the three polynomial invariants

$$I_1(\boldsymbol{\sigma}) = \text{tr } \boldsymbol{\sigma}, \quad I_2(\boldsymbol{\sigma}) = \frac{1}{2} ((\text{tr } \boldsymbol{\sigma})^2 - \text{tr}(\boldsymbol{\sigma}^2)), \quad I_3(\boldsymbol{\sigma}) = \det \boldsymbol{\sigma}, \quad (9)$$

of the stress tensor (the coefficients of characteristic polynomial of $\boldsymbol{\sigma}$). As the incompressibility or the deviation to incompressibility plays a major role in (visco-)plasticity of metals, soils and rocks, the splitting between deviatoric and hydrostatic parts is often performed, defining the deviatoric stress tensor

$$\mathbf{s} = \boldsymbol{\sigma}' = \boldsymbol{\sigma} - \frac{1}{3} \text{tr } \boldsymbol{\sigma} \mathbf{1}, \quad (10)$$

More generally $(\cdot)' = (\cdot) - \frac{1}{3} \text{tr}(\cdot) \mathbf{1}$ stands for the deviatoric part.

The engineering set of invariants

$$\sigma_H = \frac{1}{3} I_1(\boldsymbol{\sigma}) = \frac{1}{3} \text{tr } \boldsymbol{\sigma}, \quad \sigma_{eq} = \sqrt{-3I_2(\mathbf{s})} = \sqrt{\frac{3}{2} \mathbf{s} : \mathbf{s}}, \quad \mathcal{L} = \frac{27}{2} \frac{I_3(\mathbf{s})}{(-3I_2(\mathbf{s}))^{3/2}}, \quad (11)$$

is considered instead of (9), with σ_H the hydrostatic (or mean) stress, σ_{eq} the von Mises equivalent stress and \mathcal{L} the Lode parameter (Lode, 1926). The contraction notation $\mathbf{a} : \mathbf{b}$ stands for scalar product $a_{ij}b_{ij}$. Any isotropic criterion $f = f(\boldsymbol{\sigma})$ can then be expressed as a function of σ_H , σ_{eq} and \mathcal{L} only.

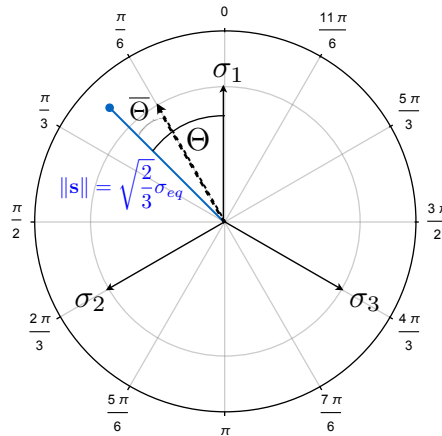

Figure 1. Lode angle Θ and azimuthal Lode angle $\bar{\Theta}$ in octahedral plane.

Lode parameter is a rational invariant of $\boldsymbol{\sigma}$ (in fact of \mathbf{s}), it is such as $\mathcal{L} \in [-1, 1]$ so that two Lode angles Θ and $\bar{\Theta}$ are usually defined from following equality,

$$\mathcal{L} = \frac{27}{2} \frac{\det \mathbf{s}}{\sigma_{eq}^3} = \cos 3\Theta = -\sin 3\bar{\Theta}. \quad (12)$$

Θ (resp. $\bar{\Theta}$) is an invariant equivalent to \mathcal{L} . The first one is the standard Lode angle

$$\Theta = \frac{1}{3} \arccos \mathcal{L} \in \left[0, \frac{\pi}{3}\right], \quad (13)$$

the second one is the azimuthal angle,

$$\bar{\Theta} = \Theta - \frac{\pi}{6} = -\frac{1}{3} \arcsin \mathcal{L} \in \left[\frac{\pi}{6}, -\frac{\pi}{6}\right]. \quad (14)$$

A nice feature is that Lode angle allows for an explicit determination of the principal stresses σ_i and to prescribe their ranking (here $\sigma_1 \geq \sigma_2 \geq \sigma_3$),

$$\sigma_i = \sigma_H + \frac{2}{3} \sigma_{eq} \cos \theta_i \quad \begin{cases} \theta_1 = \Theta, \\ \theta_2 = \Theta - \frac{2\pi}{3}, \\ \theta_3 = \Theta + \frac{2\pi}{3}, \end{cases} \quad (15)$$

the principal deviatoric stresses being then $s_i = \frac{2}{3} \sigma_{eq} \cos \theta_i$. Let us point out that $\sigma_1 = \max_i \sigma_i = \sigma_{\text{Max}}$ is the maximum principal stress.

The two Lode angles are represented in the octahedral plane (Fig. 1), the plane normal to hydrostatic axis $\sigma_1 = \sigma_2 = \sigma_3$ in the principal stresses space $(\sigma_1, \sigma_2, \sigma_3)$. At vanishing hydrostatic stress $\sigma_H = \frac{1}{3}(\sigma_1 + \sigma_2 + \sigma_3) = 0$ this plane is called the deviator plane or π -plane. The distance to the origin of the plane is simply the quadratic norm of deviatoric stress tensor \mathbf{s} , related to von mises equivalent stress as

$$\|\mathbf{s}\| = \sqrt{s_{ij}s_{ij}} = \sqrt{\frac{2}{3}} \sigma_{eq}. \quad (16)$$

A Lode angle $\Theta = 0$ ($\mathcal{L} = 1$, $\bar{\Theta} = -\frac{\pi}{6}$, tensile meridian) represents uniaxial tension combined with hydrostatic stress, whereas $\Theta = \frac{\pi}{6}$ ($\mathcal{L} = 0$, $\bar{\Theta} = 0$, shear meridian) is associated with shear stress combined with hydrostatic stress, while $\Theta = \frac{\pi}{3}$ ($\mathcal{L} = -1$, $\bar{\Theta} = \frac{\pi}{6}$, compressive meridian) corresponds to equi-biaxial tension combined with hydrostatic stress. The cases $\Theta = 0$ or $\Theta = \frac{\pi}{3}$ ($\mathcal{L} = \pm 1$, $\bar{\Theta} = \pm \frac{\pi}{6}$) of two equal principal stresses $\sigma_2 = \sigma_3$ or $\sigma_1 = \sigma_2$ correspond to axisymmetric stress states. Xue (2007), Coppola et al (2009), Bai and Wierzbicki (2010), Danas and Ponte Castañeda (2012), Mohr and Marcadet (2015), Papisidero et al (2015), Defaisse et al (2018) and others authors (see the review by Bai and Wierzbicki (2015)), have shown the strong influence of Lode parameter/angle on the damage growth and on the ductile rupture properties of metallic materials, for instance when shear states of stress are under consideration and when a low ductility in shear is exhibited.

Note that there are similar but different definitions for so-called Lode parameter. In addition to $\mathcal{L} = \cos 3\Theta$ defined Eq. (12), one has (Lode, 1926)

$$L = -\frac{3s_2}{s_1 - s_3} \in [-1, 1], \quad (17)$$

and the following definition (Xue, 2007),

$$L = -\frac{6\bar{\Theta}}{\pi} = 1 - \frac{6\Theta}{\pi} \in [-1, 1]. \quad (18)$$

Definitions (17) and (18) are not identical but they are very close (see Fig. 2).

We consider next isotropic criterion functions for rupture $f = f(\boldsymbol{\sigma})$ rewritten $f = f(\sigma_H, \sigma_{eq}, \Theta)$ —some derived from existing yield criteria or equivalent stresses—expressed as

$$f = \hat{\sigma} - k \leq 0, \quad (19)$$

with $\hat{\sigma} = \hat{\sigma}(\boldsymbol{\sigma})$ the criterion equivalent stress homogeneous in $\boldsymbol{\sigma}$, more precisely it is such as $\hat{\sigma}(\lambda\boldsymbol{\sigma}) = \lambda\hat{\sigma}(\boldsymbol{\sigma})$ for any positive scalar λ . The different criteria loci, all assumed at rupture in present work,

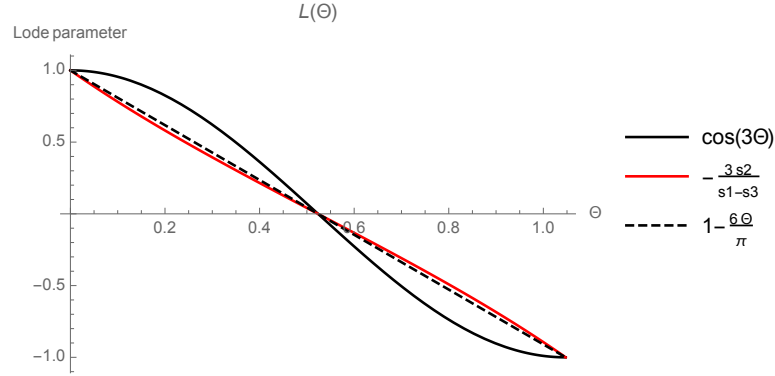

Figure 2. Different definitions of a Lode parameter $\mathcal{L}(\Theta)$ or $L(\Theta)$ belonging to interval $[-1, 1]$.

correspond to $f = 0$. One does not exclude a possible dependency of k with respect to hydrostatic stress $\sigma_H = \frac{1}{3} \text{tr } \boldsymbol{\sigma}$, such as in case of Drucker-Prager extension of von Mises criterion or as in case of Xue (2007) nonlinear failure criteria.

We focus on the Lode dependency so that the different rupture loci are plotted in octahedral plane only, mostly at constant (given) hydrostatic stress σ_H , sometimes at constant (given) stress triaxiality T_X . No details are given next concerning the nonlinear hydrostatic stress or triaxiality effects, for these refer to the works of Rice and Tracey (1969), Ottosen (1977), Lemaitre and Chaboche (1985, 1991), Lemaitre (1992) and more recently at low triaxiality of Bao and Wierzbicki (2004) or of the authors cited in the titles of next Subsections. Note last that it is sufficient to plot any isotropic locus in the angle range $[0, \frac{\pi}{3}]$ when vertical axis of octahedral plane of Fig. 1 corresponds to the maximum principal stress σ_1 , when axis at $\frac{2\pi}{3}$ corresponds to median principal stress σ_2 ($\sigma_1 \geq \sigma_2 \geq \sigma_3$) and when axis at $\frac{4\pi}{3}$ corresponds to minimum principal stress σ_3 . For the sake of clarity, we will plot the following rupture loci in the whole range $[0, 2\pi]$, *i.e.* we will not make the ranking assumption $\sigma_1 \geq \sigma_2 \geq \sigma_3$ when plotting.

Hershey-Hosford (1954-1972) criterion and its limiting cases

Hershey (1954) and Hosford (1972) have defined an equivalent stress $\hat{\sigma}$ that generalizes both von Mises and Tresca stresses, depending on the value of material parameter n ,

$$\hat{\sigma} = \left[\frac{1}{2} \left(|\sigma_1 - \sigma_2|^n + |\sigma_2 - \sigma_3|^n + |\sigma_3 - \sigma_1|^n \right) \right]^{1/n}. \quad (20)$$

Altogether with Eq. (15), rupture criterion $f = \hat{\sigma} - k = 0$ gives the von Mises stress at rupture at zero Lode angle as $\sigma_{eq(\Theta=0)} = k$ so that for Lode angle Θ :

$$\frac{\sigma_{eq}}{\sigma_{eq(\Theta=0)}} = \left(\frac{2^{1-n} 3^n}{\mathcal{H}(\Theta)} \right)^{1/n}, \quad (21)$$

where $\mathcal{H}(\Theta)$ is Hershey-Hosford function, such as $\mathcal{H}(0) = 2^{1-n} 3^n$,

$$\mathcal{H}(\Theta) = \left| \cos \Theta - \cos \left(\Theta + \frac{2\pi}{3} \right) \right|^n + \left| \cos \left(\Theta - \frac{2\pi}{3} \right) - \cos \left(\Theta + \frac{2\pi}{3} \right) \right|^n + \left| \cos \left(\Theta + \frac{2\pi}{3} \right) - \cos \Theta \right|^n. \quad (22)$$

For both cases $n = 2$ and $n = 4$ a von Mises behavior (Lode angle independent, black circle of Fig. 3) is recovered with

$$\frac{\sigma_{eq}}{\sigma_{eq(\Theta=0)}} = 1. \quad (23)$$

For $n = 6$ and for $n = 8$, respectively,

$$\frac{\sigma_{eq}}{\sigma_{eq(\Theta=0)}} = \left[\frac{9}{11 - 2 \cos^2 3\Theta} \right]^{1/6} \quad \text{and} \quad \frac{\sigma_{eq}}{\sigma_{eq(\Theta=0)}} = \left[\frac{27}{43 - 16 \cos^2 3\Theta} \right]^{1/8}, \quad (24)$$

of corresponding loci plotted in red in Fig. 3.

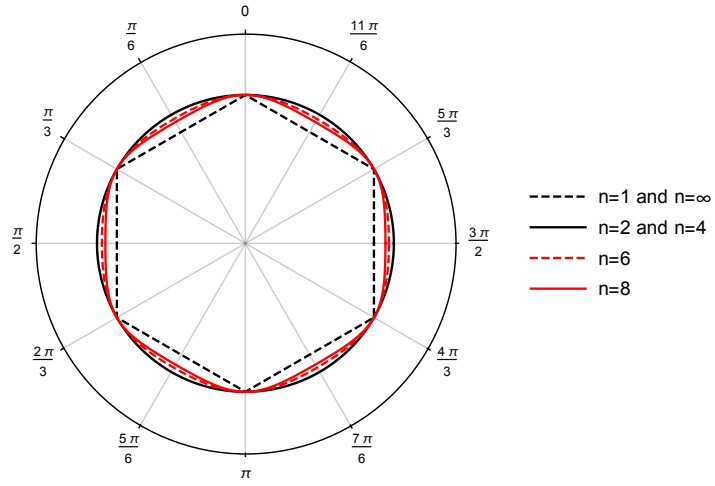

Figure 3. Normalized Hershey-Hosford locus $\sigma_{eq}/\sigma_{eq(\Theta=0)}$ in octahedral plane, for different values of exponent n .

Hershey-Hosford criterion is symmetric tension *w.r.t* compression, with in particular $\sigma_{eq(\Theta=\pi/3)} = \sigma_{eq(\Theta=0)}$. When $n = 1$ or $n \rightarrow \infty$, Tresca criterion is recovered (dashed black polygon of Fig. 3). For any value of n the locus lies between Tresca's one and von Mises' one. This means that for $\Theta = \pi/6$ (as in case of pure shear) one always has $\sigma_{eq(\Theta=\pi/6)} < \sigma_{eq(\Theta=0)}$ at given hydrostatic stress. For $n = 6$ and for $n = 8$, respectively,

$$\frac{\sigma_{eq(\Theta=\pi/6)}}{\sigma_{eq(\Theta=0)}} = 0.967 \quad \text{and} \quad \frac{\sigma_{eq(\Theta=\pi/6)}}{\sigma_{eq(\Theta=0)}} = 0.943. \quad (25)$$

Mohr-Coulomb criterion and its limiting cases

Introducing the angle of internal friction $\phi \geq 0$, a material parameter, the equivalent stress for Mohr-Coulomb criterion is

$$\hat{\sigma} = \frac{\sigma_1 - \sigma_3}{2} + \frac{\sigma_1 + \sigma_3}{2} \sin \phi. \quad (26)$$

For $\phi = 0$ Mohr-Coulomb criterion recovers Tresca criterion of maximum shear stress $f = \frac{1}{2} \max_{i,j} |\sigma_i - \sigma_j| - k \leq 0$ (dashed locus of Fig. 4), for $\phi = \frac{\pi}{2}$ it recovers the maximum principal tensile stress criterion $f = \sigma_{\text{Max}} - k \leq 0$ (red locus of Fig. 4) as $\sigma_{\text{Max}} = \max_i \sigma_i = \sigma_1$.

At rupture, $f = \hat{\sigma} - k = 0$ altogether with the expression (15) for the principal stresses, $\sigma_i = \sigma_H + \frac{2}{3} \sigma_{eq} \cos \theta_i$, writes

$$\frac{\sigma_{eq}}{3} \left[\left(\cos \Theta - \cos \left(\Theta + \frac{2\pi}{3} \right) \right) + \left(\cos \Theta + \cos \left(\Theta + \frac{2\pi}{3} \right) \right) \sin \phi \right] = k - \sigma_H \sin \phi, \quad (27)$$

so that at given hydrostatic stress:

$$\frac{\sigma_{eq}}{\sigma_{eq(\Theta=0)}} = \frac{3 + \sin \phi}{2 \left[(1 + \sin \phi) \cos \Theta - (1 - \sin \phi) \cos \left(\Theta + \frac{2\pi}{3} \right) \right]}, \quad (28)$$

where the normalization by von Mises stress at zero Lode angle $\sigma_{eq}(\Theta=0) = 3(k - \sigma_H \sin \phi)/(3 + \sin \phi)$ and at the given σ_H is made. The case $\phi = \frac{\pi}{6}$ is plotted in black in octahedral plane (Fig. 4) showing that

$$\sigma_{eq}(\Theta=\frac{\pi}{3}) \geq \sigma_{eq}(\Theta=\frac{\pi}{6}) \geq \sigma_{eq}(\Theta=0). \quad (29)$$

For smaller values of ϕ , Mohr-Coulomb criterion can model materials such as at rupture the following ranking holds (at a given σ_H still),

$$\sigma_{eq}(\Theta=\frac{\pi}{3}) \geq \sigma_{eq}(\Theta=0) \geq \sigma_{eq}(\Theta=\frac{\pi}{6}), \quad (30)$$

with $\sigma_{eq}(\Theta=\frac{\pi}{3}) = \sigma_{eq}(\Theta=0) \geq \sigma_{eq}(\Theta=\frac{\pi}{6})$ for Tresca limit $\phi = 0$.

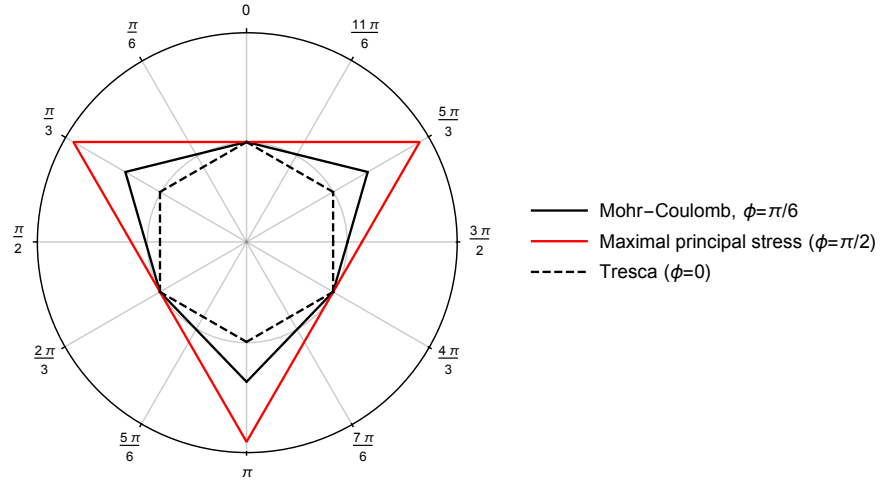

Figure 4. Normalized Mohr-Coulomb locus $\sigma_{eq}/\sigma_{eq}(\Theta=0)$ at given hydrostatic stress in octahedral plane, for different values of friction angle ϕ .

Hershey-Hosford-Coulomb criterion

Mohr and Marcadet (2015) have extended Mohr-Coulomb criterion to ductile rupture (of two Dual-Phase steels and a TRIP-assisted steel) by substituting the Tresca shear stress $\frac{1}{2}(\sigma_1 - \sigma_2)$ in Eq. (26) by half the Hosford equivalent stress (20). A further extension to severe loading paths changes can be found in (Papasidero et al, 2015) with application to aluminum alloy 2024-T351. Recall that the applicability of (modified) Mohr-Coulomb criteria to ductile rupture was shown by Bai and Wierzbicki (2010).

The Mohr and Marcadet (2015) criterion stress has for expression

$$\hat{\sigma} = \frac{1}{2^{1+\frac{1}{n}}} \left[\left(|\sigma_1 - \sigma_2|^n + |\sigma_2 - \sigma_3|^n + |\sigma_3 - \sigma_1|^n \right) \right]^{1/n} + \frac{\sigma_1 + \sigma_3}{2} \sin \phi. \quad (31)$$

The same calculations as those of subsection "Mohr-Coulomb criterion and its limiting cases" end up to the following equation for the von Mises stress at rupture

$$\frac{\sigma_{eq}}{\sigma_{eq}(\Theta=0)} = \frac{3 + \sin \phi}{2^{1-\frac{1}{n}} [\mathcal{H}(\Theta)]^{1/n} - 2 \cos \left(\Theta - \frac{2\pi}{3} \right) \sin \phi}, \quad (32)$$

which generalizes Eq. (28), at given hydrostatic stress still. Corresponding rupture loci are shown in Fig. 5 for $n = 8$ and in Fig. 6 for $n = 20$ for five different angles of internal friction ϕ . The modeling has some flexibility, the dissymmetry tension-compression is modeled and rounded angles are obtained thanks to

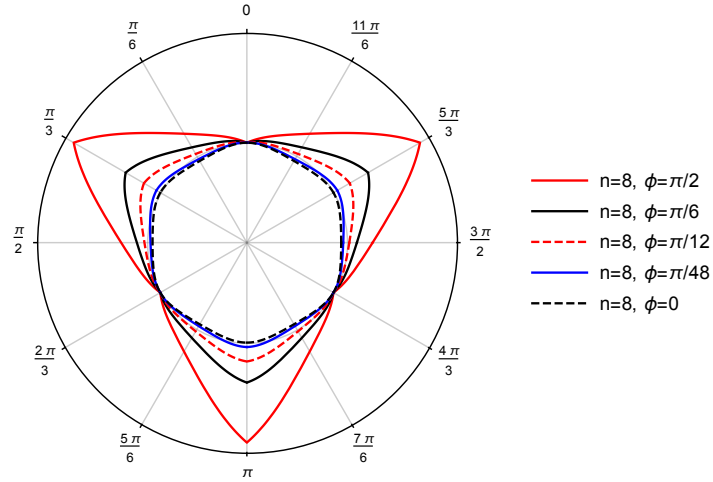

Figure 5. Normalized Hershey-Hosford-Coulomb locus $\sigma_{eq}/\sigma_{eq}(\Theta=0)$ at given hydrostatic stress in octahedral plane, for exponent $n = 8$ and different values of ϕ .

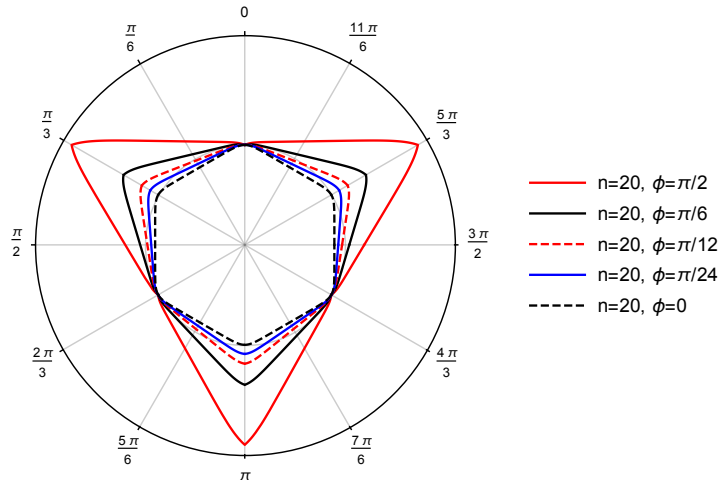

Figure 6. Normalized Hershey-Coulomb locus $\sigma_{eq}/\sigma_{eq}(\Theta=0)$ at given hydrostatic stress in octahedral plane, for exponent $n = 20$ and different values of ϕ .

Hershey-Hosford exponent n . Convexity can be lost, depending of the material parameters, but recall that it is not required for rupture surfaces.

For both initial Mohr-Coulomb criterion and recent Hosford-Coulomb criterion the shear-like behavior ($\Theta = \frac{\pi}{6}$) can be obtained as softer —*i.e.* with lower von Mises stress to rupture— than for the extremal values $\Theta = 0$ and $\Theta = \frac{\pi}{3}$ of Lode angle, by taking small values of angle ϕ (see the examples $n = 8$, $\phi = \frac{\pi}{48}$ of Fig. 5 and $n = 8$, $\phi = \frac{\pi}{24}$ of Fig. 6). But in that case the dissymmetry tension-compression is reduced: the rupture conditions for $\Theta = 0$ and $\Theta = \frac{\pi}{3}$ become close.

Hayhurst (1972) criterion

The following creep equivalent stress,

$$\hat{\sigma} = \alpha\sigma_{\text{Max}} + 3\beta\sigma_H + (1 - \alpha - \beta)\sigma_{eq}, \quad (33)$$

has been introduced by Hayhurst in 1972 for multiaxial creep applications (more precisely for the calculation of the isochronous creep rupture curves of metallic materials, see also (Leckie and Hayhurst, 1974, Lemaitre and Chaboche, 1985, 1991). The maximum principal stress is recovered when $\alpha = 1$ and Sdobyrev (1958) creep equivalent stress corresponds to $\alpha + \beta = 1$.

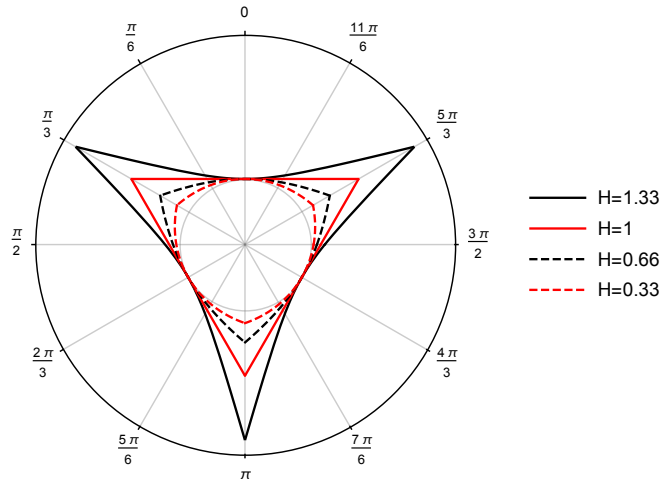

Figure 7. Normalized Hayhurst locus $\sigma_{eq}/\sigma_{eq}(\Theta=0)$ at given hydrostatic stress in octahedral plane, for different values of $H = \alpha/(1 - \beta)$.

At rupture ($f = 0$), Hayhurst criterion gives for a given hydrostatic stress,

$$(1 - \alpha - \beta)\sigma_{eq} + \alpha s_1 = k - (\alpha + 3\beta)\sigma_H, \quad (34)$$

with $s_1 = \frac{2}{3}\sigma_{eq} \cos \Theta$ the maximum principal deviatoric stress. After normalization one gets the following Lode angle dependency of von Mises stress at rupture,

$$\frac{\sigma_{eq}}{\sigma_{eq}(\Theta=0)} = \frac{1}{1 - H + H \cos \Theta}, \quad (35)$$

where we have set $H = \alpha/(1 - \beta)$. The particular case $H = 0$ gives a Lode angle independent criterion (Drucker-Prager (1952) criterion if $\beta \neq 0$, hydrostatic stress dependent). The von Mises stress rupture loci in octahedral plane are plotted in Fig. 7 for positive values of dimensionless parameter H . Except for the existence of a corner at $\Theta = \frac{\pi}{3}$ (instead of a rounded angle) there are similarities in the octahedral plane with the Mohr-Coulomb criteria for $H \geq 0.33$ / $\phi \geq \frac{\pi}{12}$. Recall that when $H \rightarrow 0$ the limit case for Hayhurst criterion is von Mises circle.

Willam and Warnke (1974) criterion

A well-known criterion for the plasticity of geomaterials is Willam-Warnke yield criterion,

$$f = \frac{\sigma_{eq}}{r(\Theta)} + \sigma_H \tan \varphi - k, \quad (36)$$

built in order to ensure the convexity —without corners— of the 3D yield surface for a simple range of a single material parameter (eccentricity factor $e \in [\frac{1}{2}, 1]$). In the octahedral plane the yield locus has the

polar equation of an ellipse between angles $-\pi/3$ and $\pi/3$ around each principal stress σ_i , setting (Willam and Warnke, 1974):

$$r(\theta) = \frac{2(1 - e^2) \cos \Theta + (2e - 1) \sqrt{4(1 - e^2) \cos^2 \Theta + 5e^2 - 4e}}{e((2e - 1)^2 + 4(1 - e^2) \cos^2 \Theta)}. \quad (37)$$

The values $e = 1$ and $e = \frac{1}{2}$ correspond respectively to Drucker-Prager (1952) and to Sdobyrev (1958) criteria. At given hydrostatic stress, the locus of von Mises stress normalized by $\sigma_{eq(\Theta=0)} = k - \sigma_H \tan \varphi$ assumed positive simply is

$$\frac{\sigma_{eq}}{\sigma_{eq(\Theta=0)}} = r(\theta). \quad (38)$$

Except for the smoothness property (and therefore except around $\Theta = \frac{\pi}{3}$), Willam-Warnke criterion with $e \in [\frac{1}{2}, 1]$ behaves qualitatively similarly as Hayhurst criterion (see the loci plotted in octahedral plane for different values of parameter e , Fig. 8).

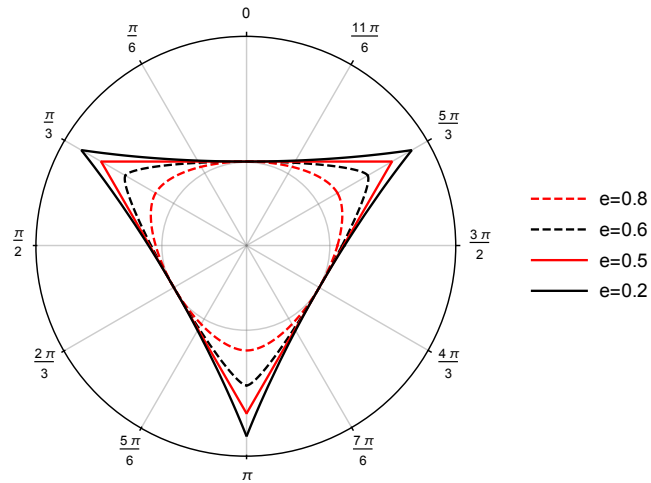

Figure 8. Normalized Willam-Warnke locus $\sigma_{eq}/\sigma_{eq(\Theta=0)}$ at given hydrostatic stress σ_H in octahedral plane, for different positive values of eccentricity parameter e .

Xue (2007) criterion of first kind

For the first Xue criterion, dedicated to ductile rupture, the locus representing the fracture strain p is made of straight lines in the octahedral plane and, thus, forms the "six point star" polygon of Fig. 9 (note that a similar shape is obtained by Lou and Huh (2013)). The criterion is directly expressed as

$$\frac{p}{p(\Theta=0)} = \frac{\sqrt{\chi^2 - \chi + 1}}{1 + \left(\frac{\sqrt{3}}{\gamma} - 2\right) \min(\chi, 1 - \chi)}, \quad (39)$$

with γ a material parameter $p(\Theta=0)$ a nonlinear function of the hydrostatic stress. The criterion depends on

$$\chi = \frac{\sigma_2 - \sigma_3}{\sigma_1 - \sigma_3} = \frac{\sin \Theta}{\sin(\Theta + \frac{\pi}{3})} = \frac{\sin(\bar{\Theta} + \frac{\pi}{6})}{\cos \bar{\Theta}}, \quad (40)$$

function equivalently of principal stresses σ_i , of Lode angle Θ or, as considered in the original work of Xue (2007), of azimuthal Lode angle $\bar{\Theta} = \Theta - \frac{\pi}{6}$.

Setting as new material parameter

$$\phi = \arctan(\sqrt{3} - 2\gamma). \quad (41)$$

Eq. (39) takes then the form

$$\frac{p}{p(\Theta=0)} = \frac{\cos\left(\frac{\pi}{6} + \phi\right)}{\cos\left(|\bar{\Theta}| + \phi\right)}. \quad (42)$$

Xue criterion is symmetric with respect to $\Theta = \pi/6$, the same fracture accumulated plastic strain or equivalent stress are obtained at $\Theta = 0$ and at $\Theta = \pi/3$. It has a quite different shape than previous criteria (the "six point star" shape). The fracture loci obtained for values of γ lower than 1 are plotted in Fig. 9. The value $\gamma = 0.4$, i.e. $\phi = 0.75$ not far from $\frac{\pi}{4}$ was measured by Xue (2007) for aluminum alloy 2024-T351. In order to illustrate the modeling modularity, values of γ larger than 1 corresponding to $\phi \geq -\frac{\pi}{12}$ are considered in Fig. 10, for which the larger accumulated plastic strain to rupture is obtained at $\Theta = \frac{\pi}{6}$.

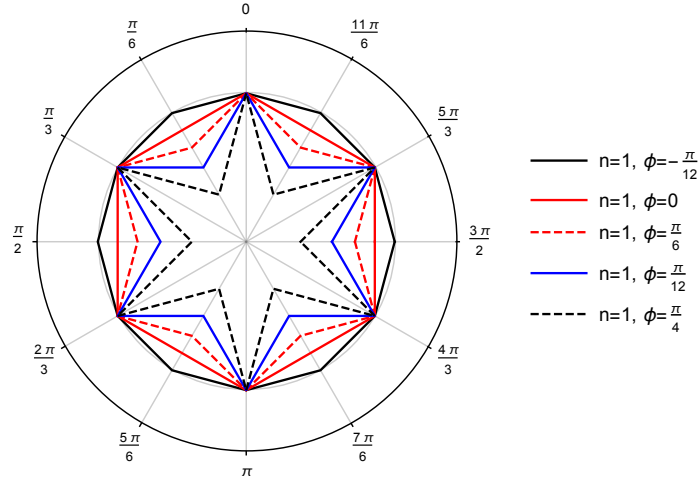

Figure 9. Normalized Xue (2007) locus of first kind $p/p(\Theta=0) = (\sigma_{eq} - \sigma_y)/(\sigma_{eq(\Theta=0)} - \sigma_y)$ at given hydrostatic stress in octahedral plane, case of linear hardening $n = 1$, for different negative values of parameter ϕ .

Xue (2007) criterion of second kind

The Xue criterion of second kind links the same stress states at $\Theta = 0$, $\Theta = \frac{\pi}{6}$, $\Theta = \frac{\pi}{3}$ than first kind criterion, not by straight lines but by branches of a general Archimedean spiral (Fig. 11, it is also symmetric with respect to shear meridian $\Theta = \frac{\pi}{6}$, $\bar{\Theta} = 0$). The corresponding accumulated plastic strain to rupture is given by

$$\frac{p}{p(\Theta=0)} = \gamma + (1 - \gamma) \left| \frac{6\Theta}{\pi} - 1 \right|^m = \gamma + (1 - \gamma) \left| \frac{6\bar{\Theta}}{\pi} \right|^m, \quad (43)$$

with the accumulated plastic strain to rupture $p(\Theta=0)$ at zero Lode angle function of σ_H only (through γ).

If one assume furthermore the power law hardening,

$$\sigma_{eq} = \sigma_y + Kp^n, \quad (44)$$

with σ_y the yield stress and K and n as material constants. Then, at rupture still, Eq. (43) becomes

$$\frac{\sigma_{eq} - \sigma_y}{\sigma_{eq}(\Theta = 0) - \sigma_y} = \left[\gamma + (1 - \gamma) \left| \frac{6\Theta}{\pi} - 1 \right|^m \right]^n, \quad (45)$$

which gives the same plot than Fig. 11 for linear hardening (but in practice a weaker lode angle effect on σ_{eq} due to the threshold σ_y). Nonlinear hardening ($n < 1$) increases the Lode angle effect in terms of stress.

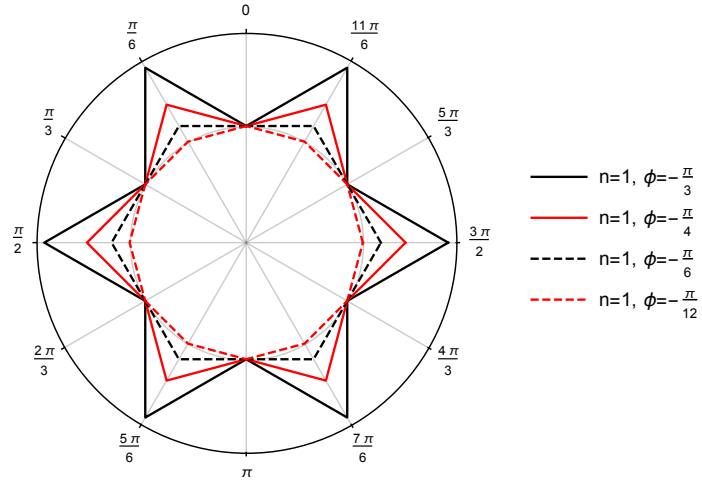

Figure 10. Normalized Xue (2007) locus of first kind $p/p_{(\Theta=0)} = (\sigma_{eq} - \sigma_y)/(\sigma_{eq(\Theta=0)} - \sigma_y)$ at given hydrostatic stress in octahedral plane, case of linear hardening $n = 1$, for different negative values of parameter ϕ .

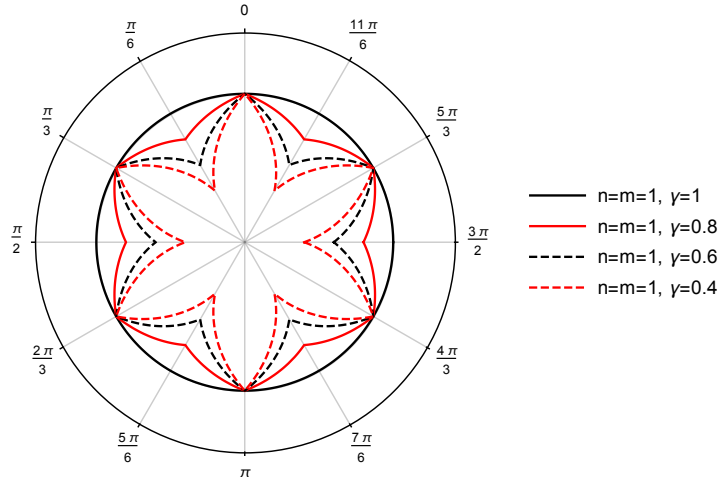

Figure 11. Normalized Xue (2007) locus of second kind $p/p_{(\Theta=0)} = (\sigma_{eq} - \sigma_y)/(\sigma_{eq(\Theta=0)} - \sigma_y)$ at given hydrostatic stress in octahedral plane, case of linear hardening $n = 1$, for $m = 1$ and different values of γ .

Defaïsse et al (2018) criterion and its Nahshon-Hutchinson (2008) limiting case

The Defaïsse et al (2018) rupture criterion (Eq. (6)), developed for ML340 ultra-high strength highly alloyed steel, is also written in terms of accumulated plastic strain to rupture p . It is here normalized by the value $p_{(\Theta=0)} = A^{-1}\phi_c \exp(-aT_X)$ at Lode angle $\Theta = 0$:

$$\frac{p}{p_{(\Theta=0)}} = \frac{1}{1 + B(1 - |\mathcal{L}|^m)}, \quad B = b \exp(-aT_X), \quad (46)$$

with for Lode parameter either, as considered by Nahshon and Hutchinson (2008),

$$\mathcal{L} = \cos 3\Theta = \frac{27 \det \mathbf{s}}{2 \sigma_{eq}^2}, \quad (47)$$

or, as in original work of Defaïsse et al (2018),

$$\mathcal{L} = L = -\frac{3s_2}{s_1 - s_2}. \quad (48)$$

The stress triaxiality $T_X = \sigma_H / \sigma_{eq}$ is assumed constant for plotting. The rupture criterion, plotted in Fig. 12, is symmetric with respect to shear meridian at $\Theta = \frac{\pi}{6}$, $\bar{\Theta} = 0$. At $\Theta = \frac{\pi}{6}$, $\frac{p}{p(\Theta=\frac{\pi}{6})} = \frac{1}{1+B}$. A positive value for B gives a lower ductility along shear meridian $\Theta = \frac{\pi}{6}$, a negative value of B (not plotted) gives a larger ductility along shear meridian.

As stated in the Introduction, the limiting case $m = 2$, $\mathcal{L} = \cos 3\Theta$, is consistent with the (fully coupled) porosity growth law made Lode angle dependent by Nahshon and Hutchinson (2008).

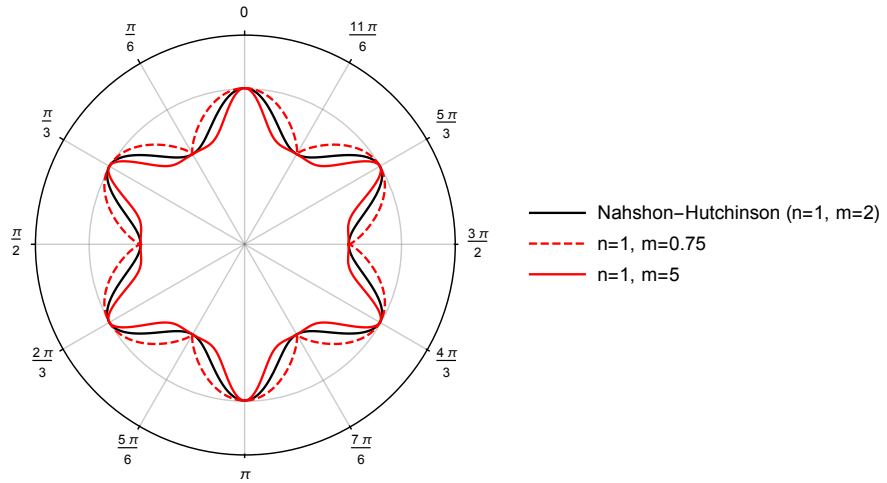

Figure 12. Normalized Defaïsse et al (2018) locus $p/p(\Theta=0) = (\sigma_{eq} - \sigma_y) / (\sigma_{eq(\Theta=0)} - \sigma_y)$ at given stress triaxiality in octahedral plane, case $\mathcal{L} = \cos 3\Theta$ with linear hardening $n = 1$, for $B = 0.5$ and different values of exponent m .

Furthermore, if one assumes power law hardening $\sigma_{eq} = \sigma_y + Kp^n$, then, at rupture at given stress triaxiality T_x still, rupture occurs at

$$\frac{\sigma_{eq} - \sigma_y}{\sigma_{eq}(\Theta = 0) - \sigma_y} = \frac{1}{[1 + B(1 - |\mathcal{L}|^m)]^n}. \quad (49)$$

Remark that when $m = 2$ with $\mathcal{L} = \cos 3\Theta$, right-hand side of (49) is strictly equal to Lode angle dependency of Eq. (25) for Hershey-Hosford criterion with $n = 1/6$ (with then $B = \frac{16}{27} \approx 0.59$) or $n = 1/8$ (with then $B = \frac{2}{9} \approx 0.22$). But the stress triaxiality effect is different (it is absent from Hershey-Hosford criterion). Fig. 13 shows that "six point star" shapes —similar to those due to Xue criteria— are obtained in octahedral plane (but here at given stress triaxiality).

We mention that, again, nonlinear hardening ($n < 1$) increases the Lode angle effect in terms of stress.

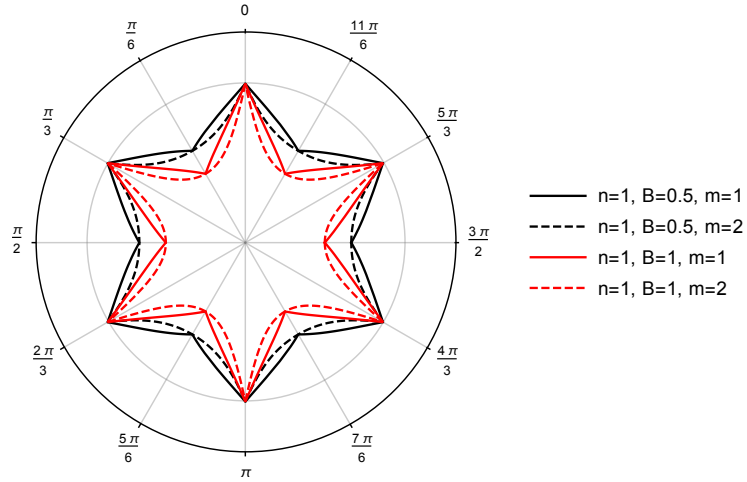

Figure 13. Normalized Defaïsse et al (2018) locus $p/p(\Theta=0) = (\sigma_{eq} - \sigma_y)/(\sigma_{eq(\Theta=0)} - \sigma_y)$ at given stress triaxiality in octahedral plane, case $\mathcal{L} = L = -3s_2/(s_1 - s_3)$ with linear hardening $n = 1$, for different values of B and of exponent m .

Mazars (1984) criterion

We finish this Section by another criterion for geomaterials, mainly dedicated to concrete: Mazars (1984, 1986) criterion. It is expressed in terms of principal strains ϵ_i , by means of an equivalent strain

$$\hat{\epsilon} = \sqrt{\sum_{i=1}^3 \langle \epsilon_i \rangle^2}, \quad (50)$$

with positive part $\langle \epsilon_i \rangle = \max(0, \epsilon_i)$. Mazars equivalent stress is therefore defined as

$$\hat{\sigma} = E\hat{\epsilon} \quad (51)$$

Isotropic elasticity is assumed, with E Young's modulus, ν Poisson's ratio, so that rupture at $f = \hat{\sigma} - k = 0$ writes

$$\sqrt{\sum_{i=1}^3 \langle (1 - 2\nu)\sigma_H + (1 + \nu)s_i \rangle^2} = k, \quad (52)$$

where the $s_i = \frac{2}{3}\sigma_{eq} \cos \theta_i$ are the principal deviatoric stresses (with $\theta_1 = \Theta$, $\theta_2 = \Theta - \frac{2\pi}{3}$, $\theta_3 = \Theta + \frac{2\pi}{3}$).

At given stress triaxiality $T_X = \sigma_H/\sigma_{eq}$, normalizing this time by the value $\sigma_{eq(\Theta=0, T_X=1)} = k/\sqrt{3(1 - 2\nu)^2 + \frac{2}{3}(\nu + 1)^2}$ at $\Theta = 0$ and $T_X = 1$, one obtains

$$\frac{\sigma_{eq}}{\sigma_{eq(\Theta=0, T_X=1)}} = \sqrt{\frac{3(1 - 2\nu)^2 + \frac{2}{3}(\nu + 1)^2}{\mathcal{M}(\Theta)}}, \quad (53)$$

with Mazars function

$$\mathcal{M}(\Theta) = \sum_{i=1}^3 \left\langle (1 - 2\nu)T_X + \frac{2}{3}(1 + \nu) \cos \theta_i \right\rangle^2. \quad (54)$$

The corresponding rupture loci are plotted in Fig. 14 for different values of the stress triaxiality. The shapes of the loci vary from a triangular one similar—but rounded—to the maximum principal tensile stress one at

$T_X = -1/3$ to Mises/Drucker-Prager circle (no Lode angle dependency) at $T_X = 1$, passing by a Willam-Warnke shape of Fig. 8 at eccentricity $e = 0.8 - 0.9$ for $T_X \in [0, \frac{1}{3}]$ (range of in-plane shear/uniaxial tension).

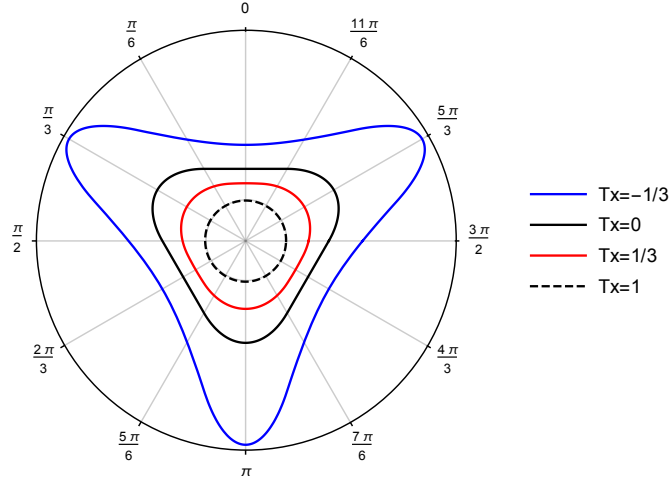

Figure 14. Normalized Mazars locus $\sigma_{eq}/\sigma_{eq}(\Theta=0, T_X=1)$ at given stress triaxiality T_X in octahedral plane, for different values of T_X .

Lode angle dependency from damage evolution laws: the case of strain induced damage anisotropy

We have seen the different shapes in octahedral plane of several rupture criteria. We now consider strain governed damage evolution suitable for quasi-brittle materials such as concrete (Dougill, 1976, Bazant and Kim, 1979, Mazars, 1984, 1986, Ramtani et al, 1992). The loading is assumed monotonic proportional.

Simple strain governed anisotropic damage law $\dot{\mathbf{D}} = A \langle \dot{\boldsymbol{\epsilon}} \rangle_+$

Let us first study the Lode angle dependency of the simple anisotropic (tensorial) damage evolution law

$$\dot{\mathbf{D}} = A \langle \dot{\boldsymbol{\epsilon}} \rangle_+ \quad \left(\text{i.e. } \dot{D}_{ij} = A \langle \dot{\epsilon} \rangle_{+ij} \right), \quad (55)$$

where $\langle \mathbf{a} \rangle_+$ denotes the positive part in terms of principal values of symmetric second order tensor \mathbf{a} (Ladevèze, 1983, 1995, Ladevèze and Lemaitre, 1984, Ortiz, 1985, Halm and Dragon, 1998). Eq. (55) ($\dot{D}_{ij} = A \langle \dot{\epsilon} \rangle_{+ij}$ in terms of components) leads to damage growth when at least one principal strain ϵ_i is positive (usually when a threshold is overpassed, but recall that it is taken to zero in present work).

Rupture in monotonic proportional loading occurs at $\max_i D_i = D_c$, with D_c the critical damage, *i.e.*

$$A \max_i \epsilon_i = \frac{A}{E} [(1 - 2\nu) \sigma_H + (1 + \nu) s_1] = D_c, \quad (56)$$

if post-processing assumption $\tilde{\boldsymbol{\sigma}} = \boldsymbol{\sigma}$ is made and where maximum principal deviatoric stress is $s_1 = \frac{2}{3} \sigma_{eq} \cos \Theta$.

At given hydrostatic stress, normalizing by $\sigma_{eq}(\Theta = 0) = 3(ED_c/A - (1 - 2\nu) \sigma_H)/2(1 + \nu)$, von Mises stress to rupture σ_{eq} for this simple anisotropic damage law obeys then to

$$\frac{\sigma_{eq}}{\sigma_{eq}(\Theta = 0)} = \frac{1}{\cos \Theta}, \quad (57)$$

which has for rupture locus in octahedral plane the one of maximum principal stress (red triangle) of Fig. 4.

Remark that if the rupture locus in octahedral plane is plotted at given stress triaxiality, it is quite different as Eq. (56) writes then

$$D_c = \frac{A}{E} \left[(1 - 2\nu) T_X + (1 + \nu) \frac{2}{3} \cos \Theta \right] \sigma_{eq}, \quad (58)$$

so that in that case one gets, at rupture still,

$$\frac{\sigma_{eq}}{\sigma_{eq}(\Theta = 0)} = \frac{1}{1 - H + H \cos \Theta} \quad \text{with} \quad H = \frac{2(1 + \nu)}{3(1 - 2\nu) T_X + 2(1 + \nu)}, \quad (59)$$

which is Eq. (35) obtained from Hayhurst criterion but here with H stress triaxiality dependent. The corresponding rupture loci in octahedral plane for $T_X \geq -2(1 + \nu)/3(1 - 2\nu)$ (i.e. $T_X \geq -1.33$ for $\nu = 0.2$, $T_X \geq -2.17$ for $\nu = 0.3$) are the ones plotted in Fig. 7 for different positive values of H .

Anisotropic damage law $\dot{\mathbf{D}} = \dot{\lambda} \langle \boldsymbol{\epsilon} \rangle_+^\alpha$

Let us also study the Lode angle dependency induced by the following anisotropic damage evolution law for quasi-brittle materials,

$$\dot{\mathbf{D}} = A \frac{\langle \boldsymbol{\epsilon} \rangle_+^\alpha}{\hat{\epsilon}^\alpha} \dot{\hat{\epsilon}} \quad \left(\text{i.e. } \dot{D}_{ij} = A \frac{\langle \boldsymbol{\epsilon} \rangle_{+ij}^\alpha}{\hat{\epsilon}^\alpha} \dot{\hat{\epsilon}} \right), \quad (60)$$

introduced in (Desmorat, 2004, Desmorat et al, 2007). For damage exponent $\alpha = 1$ it is a particular case of the induced anisotropic damage law $\dot{\mathbf{D}} = \dot{\lambda} \langle \boldsymbol{\epsilon} \rangle_+$ (or $\dot{D}_{ij} = \dot{\lambda} \langle \boldsymbol{\epsilon} \rangle_{+ij}$ in terms of components) derived by normality with respect to Mazars criterion function $F = \hat{\epsilon} - \kappa$ in (Ramtani et al, 1992). A and α are the damage parameter and $\dot{\lambda} = A \dot{\hat{\epsilon}} / \hat{\epsilon}^\alpha \geq 0$ is the damage multiplier. Only the two values $\alpha = 1$ and $\alpha = 2$ have been considered for the exponent so far.

In order to gain closed-form expressions we assume that the anisotropic damage direction $\langle \boldsymbol{\epsilon} \rangle_+ / \hat{\epsilon}$ remain constant during monotonic proportional loading. At rupture by maximum principal damage equal to critical damage ($\max_i D_i = D_c$, damage threshold still neglected), one gets

$$A (\max \epsilon_i)^\alpha \hat{\epsilon}^{1-\alpha} = D_c. \quad (61)$$

Further post-processing assumption $\tilde{\boldsymbol{\sigma}} = \boldsymbol{\sigma}$ gives at given stress triaxiality $T_X = \sigma_H / \sigma_{eq}$

$$\sigma_{eq} = \frac{E D_c}{A \left((1 - 2\nu) T_X + \frac{2}{3} (1 + \nu) \cos \Theta \right)^\alpha \mathcal{M}(\Theta)^{\frac{1-\alpha}{2}}}, \quad (62)$$

with $\mathcal{M}(\Theta)$ Mazars function (54), and finally

$$\frac{\sigma_{eq}}{\sigma_{eq}(\Theta=0, T_X=1)} = \left(\frac{5 - 4\nu}{3(1 - 2\nu) T_X + 2(1 + \nu) \cos \Theta} \right)^\alpha \left(\frac{3(1 - 2\nu)^2 + \frac{2}{3}(\nu + 1)^2}{\mathcal{M}(\Theta)} \right)^{\frac{1-\alpha}{2}}, \quad (63)$$

by normalization by von Mises stress $\sigma_{eq}(\Theta=0, T_X=1)$ at vanishing Lode angle and at stress triaxiality $T_X = 1$. We have $\nu = 0.2$ for concrete Poisson's ratio. The corresponding rupture loci are plotted in Fig. 15 to 17 for the two values $\alpha = 1, 2$ of damage exponent and for different stress triaxiality. The rupture loci are found similar those those obtained with Hayhurst criterion (see Fig. 7). They are non convex when the stress triaxiality becomes negative (Fig. 16 and 17), the standard choice $\alpha = 1$ being probably better for concrete-like materials. But note that for compressive/confined loadings, either a more sophisticated anisotropic damage evolution law or/and a two yield/damage criterion modeling are usually needed (Papa and Taliercio, 1996, Fichant et al, 1997, Meschke et al, 1998, Salari et al, 2004, Badel et al, 2007, Desmorat, 2016).

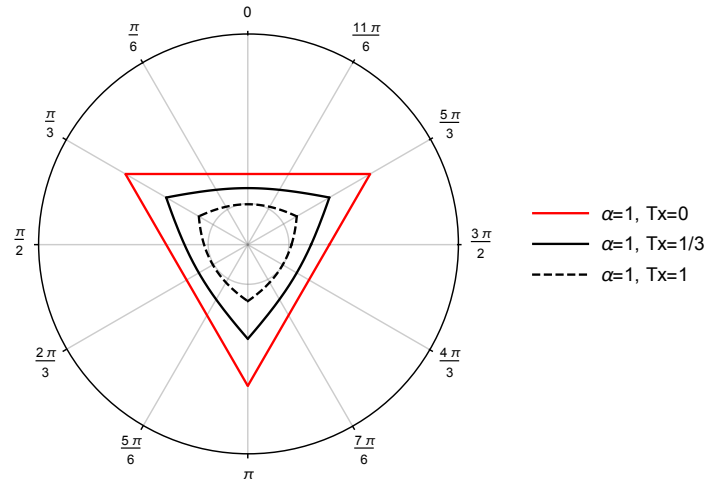

Figure 15. Normalized locus $\sigma_{eq}/\sigma_{eq}(\Theta=0, T_X=1)$ obtained from damage law (60) with $\alpha = 1$, at given stress triaxiality T_X in octahedral plane, for different values of the stress triaxiality.

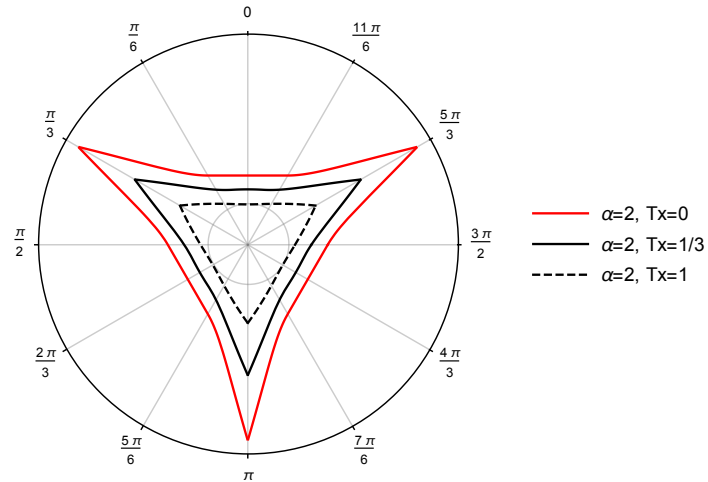

Figure 16. Normalized locus $\sigma_{eq}/\sigma_{eq}(\Theta=0, T_X=1)$ obtained from damage law (60) with $\alpha = 2$, at given stress triaxiality T_X in octahedral plane, for different values of the stress triaxiality.

Lode angle dependency from damage evolution laws: the case of stress induced damage anisotropy

Stress governed damage models are common, they were initially proposed for isotropic damage —of metals (Kachanov, 1958, Rabotnov, 1969, Hayhurst, 1972), of concrete (Mazars et al, 1990), of glass or ceramics (Denoual et al, 1997)— but also for anisotropic damage (Denoual and Hild, 2000). More precisely, due to the phenomenon of stress softening at high damage level, the damage rate is assumed function of the effective stress* $\tilde{\sigma}$ and of its rate $\dot{\tilde{\sigma}} = \frac{d}{dt} \tilde{\sigma}$. At low damage $\tilde{\sigma} \approx \sigma$. From the principle of strain equivalence

*see (Murakami and Ohno, 1978, Chaboche, 1979, Cordebois and Sidoroff, 1982, Ladevèze and Lemaitre, 1984, Murakami, 1988, Lemaitre, 1992, Lemaitre and Desmorat, 2005, Desmorat, 2016) for definitions.

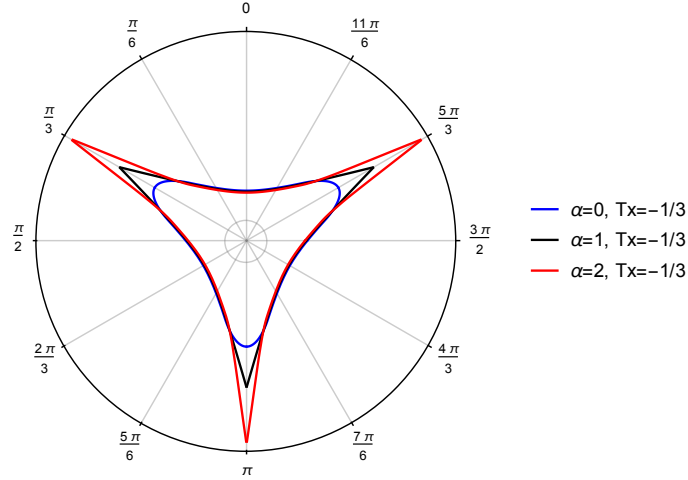

Figure 17. Normalized locus $\sigma_{eq}/\sigma_{eq}(\Theta=0, T_X=1)$ obtained from damage law (60) at stress triaxiality $T_X = -1/3$ in octahedral plane, for different values of damage exponent α .

(Lemaitre, 1971, Lemaitre and Dufailly, 1977) the effective stress does not soften when damage grows as it is always related to the elastic strain tensor $\epsilon^e = \epsilon - \epsilon^p$ by undamaged Hooke's tensor \mathbb{E} (of Young's modulus E and Poisson's ratio ν of the virgin material) as $\tilde{\sigma} = \mathbb{E} : \epsilon^e$ (see Appendix B for the full coupling with anisotropic damage).

For the sake of simplicity, we will make again the post-processing assumption, leading to $\tilde{\sigma} = \sigma$ (uncoupling with damage). As before we will neglect the damage threshold and consider that damage occurs from the very beginning of the loading (assumed monotonic and proportional). Comments on the nonlinearity of damage growth will be made in Section "Nonlinearity of anisotropic damage".

Simple stress governed anisotropic damage law $\dot{\mathbf{D}} = A \langle \dot{\tilde{\sigma}} \rangle_+$

The simplest (effective) stress governed anisotropic damage law is obtained from positive part—in terms of principal values—of the rate of $\Delta = \tilde{\sigma}$ as $\dot{\mathbf{D}} = A \langle \dot{\tilde{\sigma}} \rangle_+$ (i.e. $\dot{D}_{ij} = A \langle \langle \dot{\tilde{\sigma}} \rangle_+ \rangle_{ij}$ in terms of components) or with the post-processing assumption

$$\dot{\mathbf{D}} = A \langle \dot{\tilde{\sigma}} \rangle_+ \quad \left(\dot{D}_{ij} = A \langle \dot{\tilde{\sigma}} \rangle_{+ij} \right). \quad (64)$$

In proportional loading, this gives $\dot{D}_i = A \langle \dot{\sigma}_i \rangle$ with $\langle x \rangle = \max(0, x)$ standard positive part of a scalar. Rupture at critical damage $\max_i D_i = D_c$ occurs at $\sigma_1 = \sigma_{\text{Max}} = D_c/A$, condition already obtained with isotropic damage by Mazars et al (1990) and which corresponds exactly to the rupture criterion of maximum principal tensile stress (red triangles in octahedral planes of Fig. 4, 7 and 8).

Parametrized stress governed anisotropic damage law

With $\tilde{\mathbf{s}} = \tilde{\sigma}'$ deviatoric effective stress tensor we now set:

$$\Delta = \alpha_0 \tilde{\sigma}_H \mathbf{1} + \alpha_1 \tilde{\mathbf{s}} + \alpha_2 \frac{\tilde{\mathbf{s}}^2}{\tilde{\sigma}_{eq}^2} + \alpha_3 \frac{\tilde{\mathbf{s}}^3}{\tilde{\sigma}_{eq}^3}, \quad (65)$$

i.e. $\Delta_{ij} = \alpha_0 \tilde{\sigma}_H \delta_{ij} + \alpha_1 \tilde{s}_{ij} + \alpha_2 \frac{(\tilde{\mathbf{s}}^2)_{ij}}{\tilde{\sigma}_{eq}^2} + \alpha_3 \frac{(\tilde{\mathbf{s}}^3)_{ij}}{\tilde{\sigma}_{eq}^3}$, as the variable homogeneous to a stress which governs the damage growth and its anisotropy, the coefficients α_i being considered as constants. Eq. (65) is not the most general expression but it gives back strain governed law (55) (by $\alpha_0 = (1 - 2\nu)/E$,

$\alpha_1 = (1 + \nu)/E$, $\alpha_2 = \alpha_3 = 0$, with E and ν the elasticity parameters), and it allows to generalize the anisotropic damage evolution law (64) as $\dot{\mathbf{D}} = A \langle \dot{\Delta} \rangle_+$, giving under the post-processing assumption $\tilde{\sigma} = \sigma$,

$$\dot{\mathbf{D}} = A \left\langle \frac{d}{dt} \left(\alpha_0 \sigma_H \mathbf{1} + \alpha_1 \mathbf{s} + \alpha_2 \frac{\mathbf{s}^2}{\sigma_{eq}} + \alpha_3 \frac{\mathbf{s}^3}{\sigma_{eq}^2} \right) \right\rangle_+, \quad (66)$$

i.e. $\dot{D}_{ij} = A \left\langle \frac{d}{dt} \left(\alpha_0 \sigma_H \mathbf{1} + \alpha_1 \mathbf{s} + \alpha_2 \frac{\mathbf{s}^2}{\sigma_{eq}} + \alpha_3 \frac{\mathbf{s}^3}{\sigma_{eq}^2} \right) \right\rangle_{+ij}$, with $\mathbf{s} = \sigma'$ deviatoric stress tensor of components σ'_{ij} and A a damage parameter. Note that

$$\frac{\mathbf{s}^2}{\sigma_{eq}^2} = \frac{\mathbf{s}^{2'}}{\sigma_{eq}^2} + \frac{2}{9} \mathbf{1}. \quad (67)$$

The spherical term (the term in second order identity tensor $\mathbf{1}$), the term in \mathbf{s} and the term in \mathbf{s}^2 are present in the evolution law by Brünig et al (2013) governing the tensorial damage strain tensor (not directly the damage variable). The term in \mathbf{s}^3 is not, probably due to the fact that Cayley-Hamilton theorem allows to rewrite \mathbf{s}^3 in terms of \mathbf{s} and spherical terms. Applied to deviatoric stress tensor \mathbf{s} this theorem gives explicitly

$$\frac{\mathbf{s}^3}{\sigma_{eq}^3} = \frac{1}{3} \frac{\mathbf{s}}{\sigma_{eq}} + \frac{2}{27} \cos 3\Theta \mathbf{1}, \quad (68)$$

by use of definitions (11) and (12) of von Mises stress σ_{eq} and of Lode angle Θ . Evolution law (66) rewrites then

$$\dot{\mathbf{D}} = A \left\langle \frac{d}{dt} \left(\left(\alpha_0 \sigma_H + \frac{2}{27} (3\alpha_2 + \alpha_3 \cos 3\Theta) \sigma_{eq} \right) \mathbf{1} + \left(\alpha_1 + \frac{1}{3} \alpha_3 \right) \mathbf{s} + \alpha_2 \frac{\mathbf{s}^{2'}}{\sigma_{eq}} \right) \right\rangle_+. \quad (69)$$

An interesting feature —due to the consideration of the term in \mathbf{s}^3 in the tensorial damage law— is that appears an isotropic dependency on Lode angle (in $\sigma_{eq} \cos 3\Theta \mathbf{1} = \sigma_{eq} \mathcal{L} \mathbf{1}$).

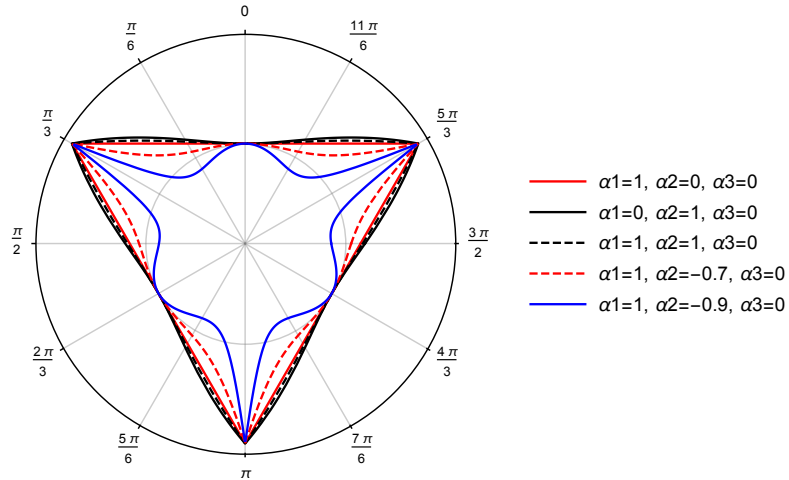

Figure 18. Normalized locus $\sigma_{eq}/\sigma_{eq}(\Theta=0)$ in octahedral plane obtained from uncoupled damage law (66) at given hydrostatic stress i , for $\alpha_3 = 0$.

Writing that the maximum principal damage in proportional loading reaches the critical value D_c gives (no damage threshold):

$$\frac{2}{27} (3\alpha_2 + \alpha_3 \cos 3\Theta) \sigma_{eq} + \left(\alpha_1 + \frac{1}{3} \alpha_3 \right) s_1 + \alpha_2 \frac{s_1^2}{\sigma_{eq}} = \frac{D_c}{A} - \alpha_0 \sigma_H, \quad (70)$$

with $s_1 = \frac{2}{3}\sigma_{eq} \cos \Theta$ the maximum principal deviatoric stress, so that at given hydrostatic stress,

$$\frac{\sigma_{eq}}{\sigma_{eq}(\Theta=0)} = \frac{3\alpha_1 + 3\alpha_2 + \frac{4}{3}\alpha_3}{2\alpha_2 + (3\alpha_1 + \alpha_3) \cos \Theta + \alpha_2 \cos 2\Theta + \frac{1}{3}\alpha_3 \cos 3\Theta}. \quad (71)$$

The corresponding rupture loci are plotted at given hydrostatic stress in Fig. 18 and 20 for a few sets of parameters. For $\alpha_3 = 0$ (Fig. 18, no isotropic term in $\cos 3\Theta$), one do not see much difference between α_1 term only and α_2 term only when $\alpha_2 \geq 0$, except for the ripples for the modeling with $\alpha_1 = 0$ (non convex) compared to the modeling with $\alpha_2 = 0$ (triangle of maximum principal tensile stress recovered). When $\alpha_2 \leq -0.8$, with $\alpha_3 = 0$ still, the von Mises at rupture at $\Theta = \frac{\pi}{6}$ is found lower than both $\sigma_{eq}(\Theta=0)$ and $\sigma_{eq}(\Theta=\frac{\pi}{3})$. This is also the case for the sets of parameters of Fig. 19 at negative values of α_3 . But this "ghost shape" in octahedral plane does not look like any of the literature criteria recalled in Section "Lode angle dependency of existing criteria". The loci with $\alpha_2 = 0$ are non convex (Fig. 20), they show a larger von Mises stress at rupture at $\Theta = \frac{\pi}{3}$ (equibiaxial tension meridian) than at $\Theta = \frac{\pi}{6}$ (shear meridian) than $\Theta = 0$ (tension meridian). For $\alpha_2 = 0$ and α_3 negative such as $|\alpha_3| \ll \alpha_1$ "ghost shapes" in octahedral plane similar to those of Fig. 19 are obtained.

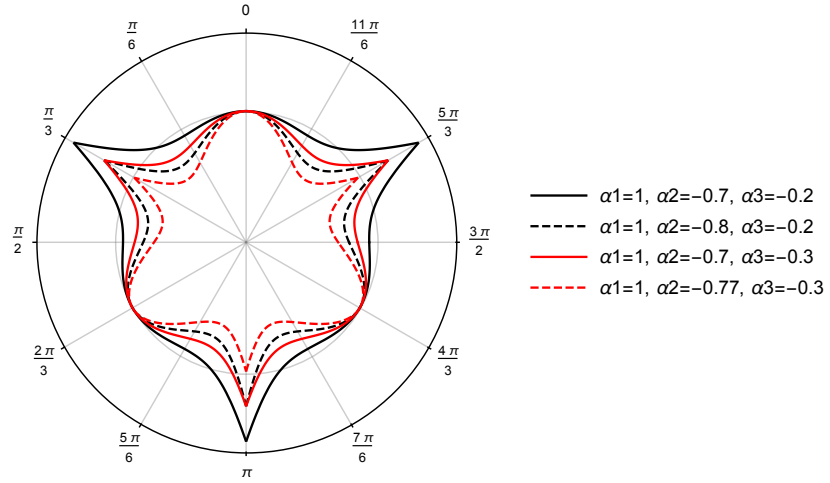

Figure 19. Normalized locus $\sigma_{eq}/\sigma_{eq}(\Theta=0)$ in octahedral plane obtained from uncoupled damage law (66) at given hydrostatic stress, for two values of α_3 negative.

We mention that similar shapes of rupture loci in octahedral plane than those of Fig. 20 (*i.e.* non convex with $\sigma_{eq}(\Theta=\frac{\pi}{3}) \geq \sigma_{eq}(\Theta=\frac{\pi}{6}) \geq \sigma_{eq}(\Theta=0)$) are obtained if $\Delta = \alpha_0 \tilde{\sigma}_H \mathbf{1} + \alpha_1 \tilde{\mathbf{s}} + \alpha_2 \tilde{\mathbf{s}}^{2l}/\tilde{\sigma}_{eq}$ is set (with $\tilde{\mathbf{s}}^{2l}$ the deviatoric part of $\tilde{\mathbf{s}}^2$) leading, in the uncoupled/post-processing approach, to

$$\dot{\mathbf{D}} = A \left\langle \frac{d}{dt} \left(\alpha_0 \sigma_H \mathbf{1} + \alpha_1 \mathbf{s} + \alpha_2 \frac{\mathbf{s}^{2l}}{\sigma_{eq}} \right) \right\rangle_+. \quad (72)$$

Anisotropic damage laws leading to modular rupture criteria

The previous anisotropic damage laws do not represent a Lode angle effect similar to the ones obtained from Xue (2007) or Defaisse et al (2018) criteria (plotted in Fig. 9, 10, 11 and 12).

Two modular anisotropic damage evolution laws are the following, with $\langle \cdot \rangle_+$ the positive part of a symmetric second order tensor in terms of principal values still,

- Modular anisotropic damage law A:

$$\dot{\mathbf{D}} = A \left\langle \frac{d}{dt} \left\{ \tilde{\mathbf{s}} + \left[\frac{2a}{3} \tilde{\sigma}_{eq} \left(1 - \omega \left(\cos 3\tilde{\Theta} \right)^m \right) + r \tilde{\sigma}_H \right] \mathbf{1} \right\} \right\rangle_+, \quad (73)$$

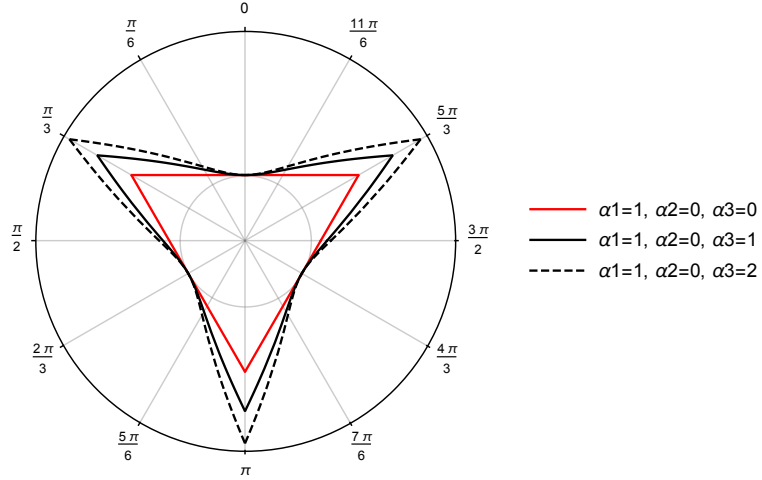

Figure 20. Normalized locus $\sigma_{eq}/\sigma_{eq}(\Theta=0)$ in octahedral plane obtained from uncoupled damage law (66) at given hydrostatic stress, for $\alpha_2 = 0$.

$$i.e. \dot{D}_{ij} = A \left\langle \frac{d}{dt} \left\{ \tilde{\mathbf{s}} + \left[\frac{2a}{3} \tilde{\sigma}_{eq} \left(1 - \omega \left(\cos 3\tilde{\Theta} \right)^m \right) + r \tilde{\sigma}_H \right] \mathbf{1} \right\} \right\rangle_{+ij};$$

- Modular anisotropic damage law B:

$$\dot{\mathbf{D}} = A \left\langle \frac{d}{dt} \left\{ \tilde{\mathbf{s}} + \left[\frac{2a}{3} \tilde{\sigma}_{eq} \left(1 - \omega \left| \cos 3\tilde{\Theta} \right|^m \right) + r \tilde{\sigma}_H \right] \mathbf{1} \right\} \right\rangle_{+}, \quad (74)$$

$$i.e. \dot{D}_{ij} = A \left\langle \frac{d}{dt} \left\{ \tilde{\mathbf{s}} + \left[\frac{2a}{3} \tilde{\sigma}_{eq} \left(1 - \omega \left| \cos 3\tilde{\Theta} \right|^m \right) + r \tilde{\sigma}_H \right] \mathbf{1} \right\} \right\rangle_{+ij};$$

the second one having an absolute value around the isotropic contribution in $\cos 3\tilde{\Theta}$. For law A, m has to be an integer. Both laws A and B are equivalent of course for an even damage exponent m . Scalars A , a , ω and m are the damage parameters, possibly hydrostatic stress dependent, and r may be a function of the hydrostatic stress. Both damage laws use the effective Lode angle

$$\tilde{\Theta} = \frac{1}{3} \arccos \left(\frac{27 \det \tilde{\mathbf{s}}}{2 \tilde{\sigma}_{eq}^3} \right) \in \left[0, \frac{\pi}{3} \right]. \quad (75)$$

The case $a = 0$, $r = 1$, recovers simple anisotropic damage law $\dot{\mathbf{D}} = A \langle \dot{\tilde{\sigma}} \rangle_{+}$. The case $\omega = 1$ is a (tensorial) generalization of Hayhurst rupture criterion. The case $\omega = 1$, $a, r \gg 1$, corresponds to a Lode angle independent isotropic (spherical) damage law.

For rupture at maximum principal damage equal to critical damage D_c under the post-processing assumption $\tilde{\sigma} = \sigma$, $\tilde{\Theta} = \Theta$, they give, at given hydrostatic stress,

$$\sigma_{eq} = \frac{\frac{3}{2} A^{-1} D_c - r \sigma_H}{\cos \Theta + a (1 - \omega (\cos 3\Theta)^m)} \quad (\text{for modular damage law A}), \quad (76)$$

$$\sigma_{eq} = \frac{\frac{3}{2} A^{-1} D_c - r \sigma_H}{\cos \Theta + a (1 - \omega |\cos 3\Theta|^m)} \quad (\text{for modular damage law B}), \quad (77)$$

or, in their normalized form, the two Lode angle dependent modular rupture criteria:

$$\frac{\sigma_{eq}}{\sigma_{eq}(\Theta=0)} = \frac{1}{1 - \alpha + \beta \cos \Theta + (\alpha - \beta) (\cos 3\Theta)^m} \quad (\text{for modular damage law A}), \quad (78)$$

$$\frac{\sigma_{eq}}{\sigma_{eq}(\Theta=0)} = \frac{1}{1 - \alpha + \beta \cos \Theta + (\alpha - \beta) |\cos 3\Theta|^m} \quad (\text{for modular damage law B}), \quad (79)$$

where

$$\alpha = \frac{1 - a\omega}{1 + a(1 - \omega)}, \quad \beta = \frac{1}{1 + a(1 - \omega)}, \quad (80)$$

with the particular cases:

- $\alpha = \beta = 1$ gives back the Lode angle effect of maximum principal tensile stress (red triangle of Fig. 4),
- $\alpha = \beta = H$ gives back the Lode angle effect (35) of Hayhurst (1972) criterion (plotted in Fig. 7),
- $\beta \rightarrow 0$, $\alpha < 0$ and $m = 2$ gives back the Lode angle effect of Nahshon and Hutchinson (2008) criterion (black locus of Fig. 12),
- $\beta \rightarrow 0$, $\alpha < 0$ for damage law B gives back the Lode angle effect (46) of Defaïsse et al (2018) criterion (red loci of Fig. 12)

The corresponding rupture loci in octahedral plane at given hydrostatic stress are given in Fig. 21 to 23 for several sets of parameters. Very different shapes can be obtained, showing the modularity of proposed damage modeling. For instance, the modeling allows to recover shapes of rupture loci similar to the ones proposed by Xue (2007).

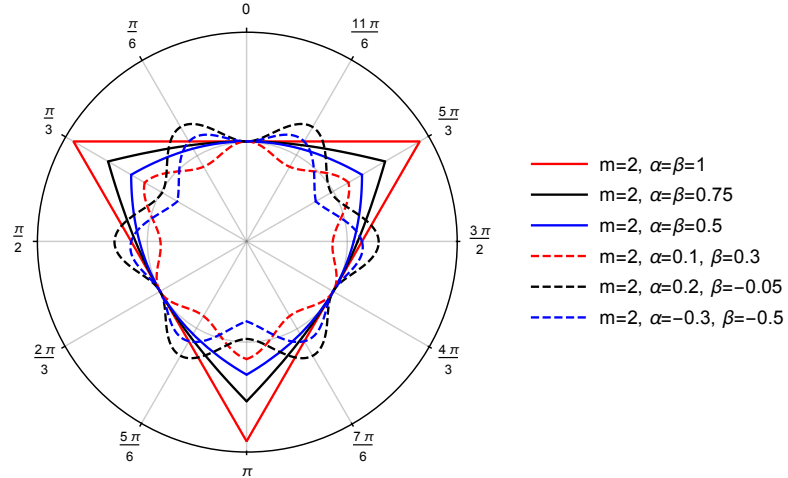

Figure 21. Normalized rupture locus $\sigma_{eq}/\sigma_{eq}(\Theta=0)$ at given hydrostatic stress in octahedral plane, obtained from modular damage laws (73)-(74), for $m = 2$ and different α, β .

Depending on the values of α, β , the criterion of maximum principal stress may be overpassed at small Lode angle Θ (see Fig. 21 and 22). Note then that it is possible to enforce that at $\Theta = \frac{\pi}{6}$ the ratio $\rho_S = \sigma_{eq}(\Theta=0)/\sigma_{eq}(\Theta=\frac{\pi}{6})$ is the same as for the maximum principal stress locus ($= \cos(\pi/6)$), by setting

$$\alpha = 1 + \frac{\sqrt{3}}{2} (\beta - 1). \quad (81)$$

This feature is illustrated by the blue dashed locus of Fig. 22 and 21 with parameters $\alpha = -0.3$ and $\beta = -0.5$ for which $1 + \frac{\sqrt{3}}{2} (-0.5 - 1) = -0.299$. More generally one can enforce any prescribed (measured) values of the ratios

$$\rho_S = \frac{\sigma_{eq}(\Theta=0)}{\sigma_{eq}(\Theta=\frac{\pi}{6})} \quad \text{and} \quad \rho_C = \frac{\sigma_{eq}(\Theta=0)}{\sigma_{eq}(\Theta=\frac{\pi}{3})}, \quad (82)$$

by taking for α and β the following values:

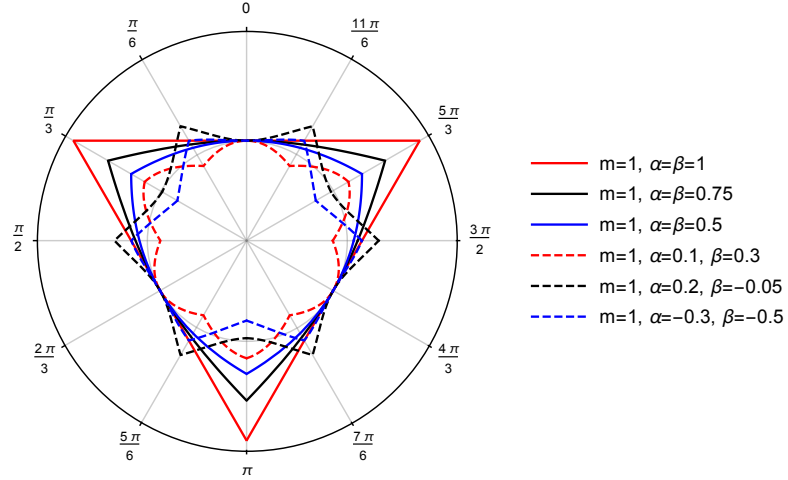

Figure 22. Normalized rupture locus $\sigma_{eq}/\sigma_{eq}(\Theta=0)$ at given hydrostatic stress in octahedral plane, obtained from modular damage law B (Eq. (74)), for $m = 1$ and different α, β .

- for modular damage law A, with m integer:

$$\alpha = \frac{2(-1)^m (\rho_S - 1) + \sqrt{3}(\rho_C - 1) - \rho_S + 1}{1 - \sqrt{3} + (-1)^m (\sqrt{3} - 2)}, \quad \beta = \frac{2((-1)^m (\rho_S - 1) + \rho_C - \rho_S)}{1 - \sqrt{3} + (-1)^m (\sqrt{3} - 2)}; \quad (83)$$

- for modular damage law B (and also for law A with m even):

$$\alpha = 1 - \rho_S + \sqrt{3}(1 - \rho_C), \quad \beta = 2(1 - \rho_C). \quad (84)$$

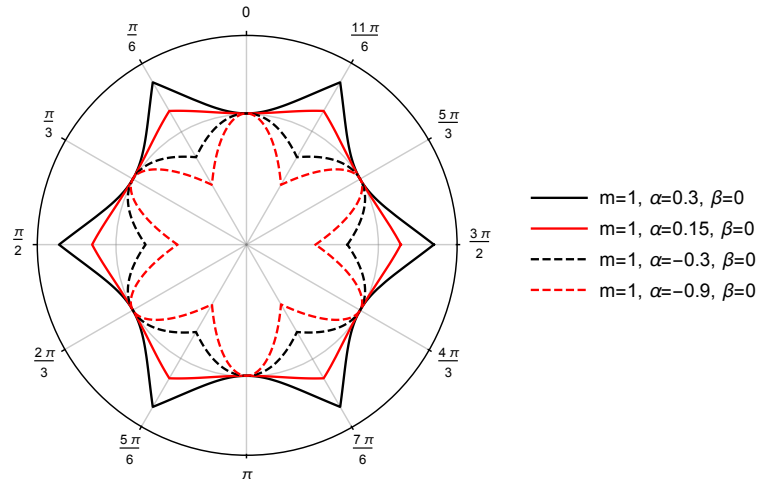

Figure 23. Normalized rupture locus $\sigma_{eq}/\sigma_{eq}(\Theta=0)$ at given hydrostatic stress in octahedral plane, obtained from modular damage law B (Eq. (74)), for $m = 1$ and $\beta = 0$.

Fig. 24 gives the rupture loci obtained from anisotropic damage law A (without absolute value around $\cos 3\Theta$) for the same sets of parameters as those of Fig. 22 (case $m = 1$, odd then). Due to $\alpha = \beta$, the

results for the continuous curves are independent from m . The results for the dashed curves do not look satisfactory so that we will always prefer to use the modular damage law B. This parametric study confirms the interest of the term in $|\cos 3\Theta|^m$ introduced for ductile rupture by Defaisse et al (2018).

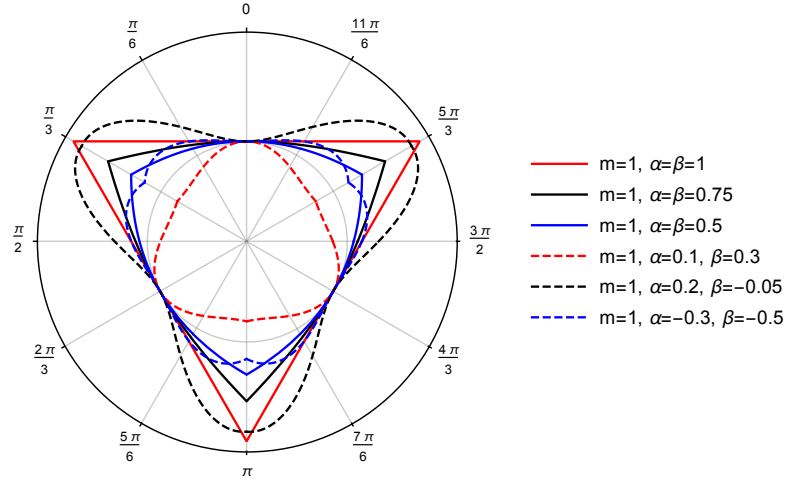

Figure 24. Normalized rupture locus $\sigma_{eq}/\sigma_{eq}(\Theta=0)$ at given hydrostatic stress in octahedral plane, obtained from damage law A (Eq. (73) without absolute value around $\cos 3\Theta$), for the sets of parameters of Fig. 22.

Lode angle dependency from damage evolution laws: the case of plastic strain induced damage anisotropy

Most damage models for ductile rupture of metals consider damage growth governed by plasticity, through the accumulated plastic strain p , and enhanced by the stress triaxiality (Gurson, 1977, Tvergaard and Needleman, 1984, Lemaitre and Chaboche, 1985, 1991, Rousselier, 1987, Lemaitre, 1992, Besson, 2009b). An extension of Lemaitre's damage law to induced anisotropic damage has been proposed by Lemaitre et al (2000) as

$$\dot{\mathbf{D}} = \left(\frac{\tilde{Y}}{S}\right)^s |\dot{\epsilon}^p| \quad \left(\text{i.e. } \dot{D}_{ij} = \left(\frac{\tilde{Y}}{S}\right)^s |\dot{\epsilon}^p|_{ij}\right), \quad (85)$$

with \mathbf{D} the symmetric second order damage tensor, $|\dot{\epsilon}^p|$ the absolute value of plastic strain rate tensor in terms of principal values (so that in terms of components $\dot{D}_{ij} = \left(\frac{\tilde{Y}}{S}\right)^s |\dot{\epsilon}^p|_{ij}$), and:

$$\tilde{Y} = \frac{\tilde{\sigma}_{eq}^2 \tilde{R}_\nu}{2E}, \quad \tilde{R}_\nu = \frac{2}{3}(1 + \nu) + 3(1 - 2\nu) \left(\frac{\tilde{\sigma}_H}{\tilde{\sigma}_{eq}}\right)^2. \quad (86)$$

S and s are the damage parameters and $\tilde{\sigma}_H/\tilde{\sigma}_{eq} = \text{tr } \tilde{\sigma}/3(\tilde{\sigma})_{eq} = \tilde{T}_X$ is the effective stress triaxiality. The cross identification of the parameters for law (85) from those for isotropic Lemaitre's damage law is performed in (Desmorat and Otin, 2008). A second extension, taking into account the micro-cracks close effect is detailed in (Lemaitre and Desmorat, 2005).

When the hardening is saturated, then $\tilde{\sigma}_{eq} \approx \sigma_u = \text{const}$ (the ultimate stress) so that damage law (85) writes $\dot{\mathbf{D}} = A |\dot{\epsilon}^p|$ with

$$A = \left(\frac{\sigma_u^2 \tilde{R}_\nu}{2E}\right)^s. \quad (87)$$

Scalar A is function of \tilde{T}_X only (through \tilde{R}_ν) and not of Lode angle.

Anisotropic damage law $\dot{\mathbf{D}} = A \left(\zeta |\dot{\epsilon}^p| + (1 - \zeta) \langle \dot{\epsilon}^p \rangle_+ \right)$

We then set $\mathbf{\Delta} = \epsilon^p$ as the variable governing damage growth and anisotropy and we introduce the material parameter $\zeta \in [0, 1]$ allowing to generalize previous anisotropic damage law as (Desmorat et al, 2010)

$$\dot{\mathbf{D}} = A \left(\zeta |\dot{\epsilon}^p| + (1 - \zeta) \langle \dot{\epsilon}^p \rangle_+ \right) \quad \left(\text{i.e. } \dot{D}_{ij} = A \left(\zeta |\dot{\epsilon}^p| + (1 - \zeta) \langle \dot{\epsilon}^p \rangle_{+ij} \right) \right), \quad (88)$$

with absolute value $|\dot{\epsilon}^p|$ and positive part $\langle \dot{\epsilon}^p \rangle_+$ defined in terms of the principal values of plastic strain rate tensor $\dot{\epsilon}^p$. Von Mises (incompressible) plasticity is considered with

$$\dot{\epsilon}^p = \dot{p} \mathbf{n}, \quad \mathbf{n} = \frac{3}{2} \frac{\tilde{\mathbf{s}}}{\tilde{\sigma}_{eq}}, \quad p = \int \sqrt{\frac{2}{3} \dot{\epsilon}^p : \dot{\epsilon}^p} dt, \quad (89)$$

with Lode angle in terms of plastic strain rate equal to Lode angle in terms of effective stress $\tilde{\Theta}$,

$$\tilde{\Theta} = \frac{1}{3} \arccos \left(\frac{27 \det \tilde{\mathbf{s}}}{2 \tilde{\sigma}_{eq}^3} \right) = \frac{1}{3} \arccos \left(\frac{4 \det \dot{\epsilon}^p}{\dot{p}^3} \right) \in \left[0, \frac{\pi}{3} \right]. \quad (90)$$

With further post-processing assumption $\tilde{\sigma} = \sigma$, $\tilde{\mathbf{s}} = \mathbf{s}$, $\tilde{\Theta}$ becomes equal to Lode angle Θ in terms of stress. We get then

$$\dot{\mathbf{D}} = \frac{3A}{2} \left(\zeta \left| \frac{\mathbf{s}}{\sigma_{eq}} \right| + (1 - \zeta) \left\langle \frac{\mathbf{s}}{\sigma_{eq}} \right\rangle_+ \right) \dot{p}. \quad (91)$$

At constant A in proportional loading (due to constant stress triaxiality), $\max_i D_i = D_c$ gives

$$D_c = A \max_i \left(\zeta |\cos \theta_i| + (1 - \zeta) \langle \cos \theta_i \rangle \right) p, \quad (92)$$

i.e.

$$D_c = A \max \left(\cos \Theta, -\zeta \cos \left(\Theta - \frac{2\pi}{3} \right) \right) p, \quad (93)$$

due to $\cos \theta_1 = \cos \Theta \in [\frac{1}{2}, 1]$, $\cos \theta_2 = \cos \left(\Theta - \frac{2\pi}{3} \right) \in [-\frac{1}{2}, \frac{1}{2}]$, $\cos \theta_3 = \cos \left(\Theta + \frac{2\pi}{3} \right) \in [-1, -\frac{1}{2}]$. Normalizing by $p_{(\Theta=0)}$ the plastic strain at rupture at zero Lode angle:

$$\frac{p}{p_{(\Theta=0)}} = \frac{\max \left(1, \frac{\zeta}{2} \right)}{\max \left(\cos \Theta, -\zeta \cos \left(\Theta - \frac{2\pi}{3} \right) \right)}. \quad (94)$$

The corresponding rupture loci are plotted in Fig. 25, in octahedral plastic strain plane this times (with Θ also the Lode angle of ϵ^p in proportional loading). Parameter ζ gives a modularity sufficient for most metallic materials, more precisely for those with at higher ductility in shear (at $\Theta = \frac{\pi}{6}$). Engineering applications are described in (Lemaitre and Desmorat, 2005, Lemaitre et al, 2009). Note that 3D iso-damage surfaces with shapes in octahedral planes similar to those of Fig. 25 have by obtained by Badreddine et al (2015) from a fully coupled anisotropic damage model (without/with micro-cracks closure effect, in finite strains framework).

The modeling (88) does not apply by itself to recent alloys with low —below tension and equi-biaxial tension— ductility in shear such as those recently studied in (Bao and Wierzbicki, 2004, Xue, 2007, Bai and Wierzbicki, 2010, Mohr and Marcadet, 2015, Papisidero et al, 2015, Defaisse et al, 2018).

Parametrized plastic strain governed anisotropic damage law

The idea is then to complete previous plastic strain governed damage law by the isotropic term giving the modularity of evolution law (74). Having in mind that linear hardening writes $\dot{\sigma}_{eq} = \dot{p}/K$ (with K the plastic modulus) and that isotropic elasticity law with incompressible plasticity linearly relates the

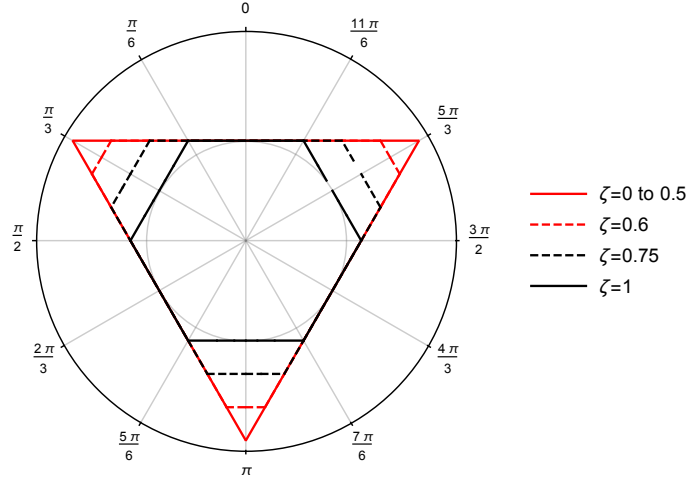

Figure 25. Normalized rupture locus $p/p_{(\Theta=0)}$ in octahedral plane, obtained from anisotropic damage law (88) for different values of parameter ζ .

hydrostatic stress σ_H to the volumetric strain $\text{tr } \epsilon$ as $\sigma_H = \frac{E}{3(1-2\nu)} \text{tr } \epsilon$, we take $\zeta = 0$ and write

$$\dot{\mathbf{D}} = \left\langle A \dot{\epsilon}^p + B \left(1 - \omega \left| \cos 3\tilde{\Theta} \right|^m\right) \dot{p} \mathbf{1} + C \text{tr } \dot{\epsilon} \mathbf{1} \right\rangle_+, \quad (95)$$

i.e. in terms of components

$$\dot{D}_{ij} = \left\langle A \dot{\epsilon}^p + B \left(1 - \omega \left| \cos 3\tilde{\Theta} \right|^m\right) \dot{p} \mathbf{1} + C \text{tr } \dot{\epsilon} \mathbf{1} \right\rangle_{+ij}, \quad (96)$$

with A , B , ω , m as material parameters, and where C may be a function of $\text{tr } \epsilon$ and/or simply function of the sign of $\text{tr } \dot{\epsilon}$ in order to make $C \text{tr } \dot{\epsilon}$ always positive or zero. The positive part in Eq. (95) ensures that $\dot{\mathbf{D}}$ is always positive semi-definite. The isotropic (spherical) term $\tilde{\mathcal{I}} \mathbf{1}$, with $\tilde{\mathcal{I}} = B \left(1 - \omega \left| \cos 3\tilde{\Theta} \right|^m\right) \dot{p} + C \text{tr } \dot{\epsilon}$, is chosen symmetric with respect to shear meridian $\Theta = \frac{\pi}{6}$. The non symmetry will be gained from anisotropic term $A \dot{\epsilon}^p$.

When $\omega = 0$, the isotropic contribution $\tilde{\mathcal{I}}$ is proportional to the porosity growth rate $\dot{\phi}$ with nucleation term of Chu and Needleman (1980), Lode angle independent and proportional to \dot{p} . When $\omega = 1$, $m = 2$, and when B and C are made function of the void volume fraction as $B = a\kappa\phi$, $C = a(1 - \phi)$, the isotropic contribution $\tilde{\mathcal{I}}$ is proportional to the porosity growth rate $\dot{\phi}$ considered by Nahshon and Hutchinson (2008) (Eq. (2)). In both cases, the anisotropic damage law (95) takes the form

$$\dot{\mathbf{D}} = \left\langle A \dot{\epsilon}^p + a \dot{\phi} \mathbf{1} \right\rangle_+. \quad (97)$$

In proportional loading, the maximum principal damage rate is the rate of the maximum principal damage. When positive, Eq. (95) gives

$$\max \dot{D}_i = A \max \dot{\epsilon}_i^p + B \left(1 - \omega \left| \cos 3\tilde{\Theta} \right|^m\right) \dot{p} + C \text{tr } \dot{\epsilon}, \quad (98)$$

where $C = C(\text{tr } \epsilon = \frac{3(1-2\nu)}{E} \sigma_H, \text{sign}(\text{tr } \dot{\epsilon}))$ and A , B , ω and m are assumed constant.

The same calculations than above (post-processing in monotonic proportional loading), with $\text{sign}(\text{tr } \dot{\epsilon}) = \text{const}$, -1 or 1 , with the principal plastic strains equal to $\epsilon_i^p = p n_i = p \cos \theta_i$ and then $\max_i \dot{\epsilon}_i^p = p \cos \Theta$

(due to $\tilde{\Theta} = \Theta$, $\tilde{T}_X = T_X$), give at rupture

$$p = \frac{D_c - \frac{3(1-2\nu)}{E} \int C d\sigma_H}{B + A \cos \Theta - B\omega |\cos 3\Theta|^m}, \quad (99)$$

and then, at given hydrostatic stress, the normalized plastic strain to rupture as

$$\frac{p}{p(\Theta=0)} = \frac{1}{1 - \alpha + \beta \cos \Theta + (\alpha - \beta) |\cos 3\Theta|^m}, \quad (100)$$

with

$$\alpha = \frac{A - B\omega}{A + B(1 - \omega)}, \quad \beta = \frac{A}{A + B(1 - \omega)}. \quad (101)$$

All the rupture loci shapes in octahedral planes at given σ_H of Fig. 21 to 23 can then be obtained — with exactly the same values of α, β — but for the ratios of plastic strains to rupture $p/p(\Theta=0)$ instead of $\sigma_{eq}/\sigma_{eq(\Theta=0)}$. They are then not replotted here.

Exactly as for the stress governed anisotropic damage law B of subsection "Anisotropic damage laws leading to modular rupture criteria", it is possible to enforce any prescribed values of both ratios $\rho_S = \sigma_{eq(\Theta=0)}/\sigma_{eq(\Theta=\frac{\pi}{6})}$ and $\rho_C = \sigma_{eq(\Theta=0)}/\sigma_{eq(\Theta=\frac{\pi}{3})}$ at given σ_H by setting $\alpha = 1 - \rho_S + \sqrt{3}(1 - \rho_C)$ and $\beta = 2(1 - \rho_C)$ (Eq. (84)).

Note finally that for saturating hardening, Eq. (114) still applies if one replaces A by Lemaitre's initial value $A = (\sigma_u^2 R_\nu / 2E)^s$ (Eq. (86)-(87) with $\tilde{T}_X = T_X$), stress triaxiality dependent.

Nonlinearity of anisotropic damage

In order to draw general conclusions, we finally focus our study on damage evolution laws for ductile materials.

Many nonlinear isotropic damage laws independent from the third (effective) stress invariant—including Rabotnov-Kachanov one, see Appendix A — have the generic form

$$\dot{D} = g_D(D) g_{\tilde{\sigma}}(\tilde{\sigma}_{eq}) g_{T_X}(T_X) g_p(p) \dot{p}, \quad (102)$$

of damage governed by plasticity and enhanced by mechanical variables, multiplicatively though the functions g_D , $g_{\tilde{\sigma}}$, g_{T_X} and g_p (functions of the damage variable D , of $\tilde{\sigma}_{eq} = \sigma_{eq}/(1 - D)$ the effective von Mises stress, of $T_X = \sigma_H/\sigma_{eq} = \tilde{\sigma}_H/\tilde{\sigma}_{eq} = \tilde{T}_X$ the stress triaxiality, of p the accumulated plastic strain). Remark that the nonlinearity with respect to the damage itself can be avoided in damage law (but it cannot in the full coupling with elasto-visco-plasticity) if the following change of damage variable is made,

$$d = \int_0^D \frac{dD}{g_D(D)}, \quad \dot{d} = g_{\tilde{\sigma}}(\tilde{\sigma}_{eq}) g_{T_X}(T_X) g_p(p) \dot{p}. \quad (103)$$

Taking $g_D(D) = (1 - D)^{-k}$ (as in Kachanov-Rabotnov pioneering damage law (117) and in extended Lemaitre law (119), see Appendix A), with $k \neq -1$:

$$d = \frac{1}{k+1} \left(1 - (1 - D)^{k+1} \right), \quad (104)$$

When $k = -1$:

$$d = -\ln(1 - D). \quad (105)$$

For anisotropic damage, the nonlinearity of the evolution laws are mainly of three kinds:

1. Nonlinearity *w.r.t* tensorial damage variable \mathbf{D} (of components D_{ij}), the rate $\dot{\mathbf{D}}$ in the anisotropic damage law being replaced by second order symmetric tensor

$$\dot{\mathbf{d}} = \mathcal{G}(\mathbf{D}, \dot{\mathbf{D}}) \quad \left(\text{i.e. } \dot{d}_{ij} = \mathcal{G}_{ij}(D_{kl}, \dot{D}_{kl}) \right), \quad (106)$$

ensuring the symmetry $\mathbf{D} = \mathbf{D}^T$ (i.e. $D_{ij} = D_{ji}$) of the damage tensor. Usually $\mathcal{G}(\mathbf{D}, \dot{\mathbf{D}})$ is symmetric semi-definite positive and homogeneous in $\dot{\mathbf{D}}$, $\mathcal{G}(\mathbf{D}, \lambda \dot{\mathbf{D}}) = \lambda \mathcal{G}(\mathbf{D}, \dot{\mathbf{D}})$.

2. Nonlinearity *w.r.t* the other mechanical variables, the scalars A , α_i , B , C of the previous anisotropic damage laws being made nonlinear functions of effective von Mises stress, of stress triaxiality and/or of accumulated plastic strain state (setting for example $A = g_{\tilde{\sigma}}(\tilde{\sigma}_{eq})g_{T_X}(T_X)g_p(p)$),
3. Nonlinearity *w.r.t* both tensorial damage variable and the other mechanical variables.

For first kind of nonlinearity, it is convenient to introduce the symmetric positive definite second order tensor (Ladevèze, 1983, 1995)

$$\mathbf{H} = (\mathbf{1} - \mathbf{D})^{-\frac{1}{2}}, \quad (107)$$

of components H_{ij} . A choice generalizing Eq. (104) to anisotropic damage is (case $k \neq -1$):

$$\mathcal{G}(\mathbf{D}, \dot{\mathbf{D}}) = -\frac{1}{k+1} \frac{d}{dt} (\mathbf{1} - \mathbf{D})^{k+1} = -\frac{1}{k+1} \frac{d}{dt} \mathbf{H}^{-2(k+1)}, \quad (108)$$

giving

$$\mathbf{d} = \frac{1}{k+1} \left(\mathbf{1} - \mathbf{H}^{-2(k+1)} \right). \quad (109)$$

In the case $k = -1$ a generalization of Eq. (105) is either direct use of

$$\mathbf{d} = -\ln(\mathbf{1} - \mathbf{D}) = 2 \ln \mathbf{H}, \quad (110)$$

or the use of pseudo-logarithmic damage rate tensor (Carol et al., 2001)

$$\mathcal{G}(\mathbf{D}, \dot{\mathbf{D}}) = \mathbf{H} \cdot \dot{\mathbf{D}} \cdot \mathbf{H}. \quad (111)$$

For choices (109) and (110), the critical damage criterion $\max_i D_i = D_c$ in terms of principal values of \mathbf{D} always coincides with the critical damage criterion $\max_i d_i = d_c$ in terms of \mathbf{d} , with for (109):

$$d_c = \frac{1}{k+1} \left(1 - (1 - D_c)^{k+1} \right), \quad (112)$$

and for (110):

$$d_c = -\ln(1 - D_c). \quad (113)$$

For choice (111) criterion $\max_i D_i = D_c$ coincides with criterion $\max_i d_i = d_c$ in proportional loading, as then the principal axes of damage tensor remain constant. In that case one also has $d_c = -\ln(1 - D_c)$. This derivations mean that all the post-processing/uncoupled results of Sections "Strain induced damage anisotropy", "Stress induced damage anisotropy" and "Plastic strain induced damage anisotropy" remain valid, without any change, whatever the nonlinearity with respect to the anisotropic damage itself.

For second and third kinds of nonlinearities, the time integration of damage law cannot always be performed in a closed form, even in proportional loading. If one focus on plasticity governed anisotropic damage law (95) with isotropic hardening $\tilde{\sigma}_{eq} = \sigma_y + R(p)$, with $\dot{\mathbf{D}}$ replaced by \mathbf{d} , and if one sets $A = A_0 g_{\tilde{\sigma}}(\tilde{\sigma}_{eq}) g_{T_X}(T_X) g_p(p)$, $B = B_0 g_{\tilde{\sigma}}(\tilde{\sigma}_{eq}) g_{T_X}(T_X) g_p(p)$, $C = 0$, with A_0 , B_0 , ω and m as material constants, one obtains (in proportional loading):

$$G(p) = \frac{D_c}{g_{T_X}(T_X)} \frac{1}{B_0 + A_0 \cos \Theta - B_0 \omega |\cos 3\Theta|^m}, \quad G(p) = \int_0^p g_{\tilde{\sigma}}(\sigma_y + R(p)) g_p(p) dp. \quad (114)$$

At given stress triaxiality this time, the plastic strain to rupture p obeys

$$\frac{G(p)}{G(p(\Theta=0))} = \frac{1}{1 - \alpha + \beta \cos \Theta + (\alpha - \beta) |\cos 3\Theta|^m}, \quad (115)$$

with now

$$\alpha = \frac{A_0 - B_0 \omega}{A_0 + B_0(1 - \omega)}, \quad \beta = \frac{A_0}{A_0 + B_0(1 - \omega)}. \quad (116)$$

Both the smoothness and the intensity of Lode angle effect (in octahedral plane) are affected by the nonlinearity of function $G(p)$. But the types of Lode angle effect obtained (*i.e.* at which value 0 , $\frac{\pi}{6}$ or $\frac{\pi}{3}$ of Lode angle Θ is the plastic strain to rupture minimum or maximum) remain then identical to those encountered in Fig. 21 to 23.

Conclusion

One has first plotted in octahedral plane several literature criterion functions for rupture of metals, of geomaterials and of concrete. The different shapes exhibited have then been compared to the rupture loci obtained by time integration of several (modular) anisotropic damage evolution laws in monotonic proportional loading for the rupture criterion $\max_i D_i = D_c$ in terms of maximum principal damage, with D_c the critical damage (Lemaitre and Chaboche, 1985, 1991).

The Lode angle dependency of the two total strain induced damage anisotropy laws (55) and (60) dedicated to quasi-brittle materials, *i.e.*

$$\dot{\mathbf{D}} = A \langle \dot{\boldsymbol{\epsilon}} \rangle_+ \quad \text{and} \quad \dot{\mathbf{D}} = A \frac{\langle \boldsymbol{\epsilon} \rangle_+^\alpha}{\hat{\epsilon}^\alpha} \dot{\boldsymbol{\epsilon}}, \quad \alpha = 1, 2,$$

has been studied. Then, in order to make the anisotropic damage models able to represent all types of Lode dependency effect encountered for metals and following the same theoretical approach, the recent datas concerning metallic materials with low ductility in shear have allowed us to properly enrich the stress/plastic strain based damage evolution laws:

- as the modular damage law B (Eq. (74), preferred to modular damage law A) for (effective) stress induced damage anisotropy,

$$\dot{\mathbf{D}} = A \left\langle \frac{d}{dt} \left\{ \tilde{\mathbf{s}} + \left[\frac{2a}{3} \tilde{\sigma}_{eq} \left(1 - \omega \left| \cos 3\tilde{\Theta} \right|^m \right) + r \tilde{\sigma}_H \right] \mathbf{1} \right\} \right\rangle_+,$$

$$\text{with } \tilde{\mathbf{s}} = \tilde{\boldsymbol{\sigma}}', \tilde{\sigma}_H = \frac{1}{3} \text{tr } \tilde{\boldsymbol{\sigma}} \text{ and } \tilde{\Theta} = \frac{27 \det \tilde{\mathbf{s}}}{2 \tilde{\sigma}_{eq}^3};$$

- and as the parametrized law (95) for plastic strain induced damage anisotropy,

$$\dot{\mathbf{D}} = \left\langle A \dot{\boldsymbol{\epsilon}}^p + B \left(1 - \omega \left| \cos 3\tilde{\Theta} \right|^m \right) \dot{p} \mathbf{1} + C \text{tr } \dot{\boldsymbol{\epsilon}} \mathbf{1} \right\rangle_+,$$

Let us conclude by the remark that one can plot in the —either stress or plastic strain— deviator plane the experimental loading paths, but one can also plot in the deviator plane the associated (computed) value of the maximum principal damage $\max_i D_i(t)$. Concerning the modeling, this is due to the property that any kinetic (rate) damage law $\frac{d}{dt} \mathbf{D} = \dots$ is able to follow the loading path, time increment by time increment, contrary to standard rupture criteria. This may prove interesting during the damage parameters identification process, for instance when some loading non proportionality occurs. In practice, this will be nevertheless not no easy to do as there may be some damage threshold and as the measurement of the damages D_{ij} at each time increments is a difficult task. Inverse methods will be needed (Nashed, 1987, Tanaka and Bui, 1993, Aster et al, 2005, Hild et al, 2015). In a natural (computing) way, one will end up by using fully coupled anisotropic damage models, such as the ones, enhanced by Lode angle dependency, described in Appendix B.

Author's note

A. Mattiello is now at EDF lab Paris-Saclay, Boulevard Monge, 91120 Palaiseau, France.

References

- Aster R. C., Borchers B. and Thurber C. H., Parameter Estimation and Inverse Problems, Elsevier Boston, 2005.
- Badel, P., Godard, V., Leblond, J., 2007. Application of some anisotropic damage model to the prediction of the failure of some complex industrial concrete structure. International Journal of Solids and Structures 44, 5848–5874.
- Badreddine H., Saanouni K., Nguyen T. D., Damage anisotropy and its effect on the plastic anisotropy evolution under finite strains, International Journal of Solids and Structures, 63, 11–31, 2015.

- Bai Y., Wierzbicki T., Application of extended Mohr-Coulomb criterion to ductile fracture, *Int. J. Fracture*, 161, 1–20, 2010.
- Bai Y., Wierzbicki T., A comparative study of three groups of ductile fracture loci in the 3D space, *Engineering Fracture Mechanics*, 135, 147–167, 2015.
- Bao Y., Wierzbicki T., On fracture locus in the equivalent strain and stress triaxiality space, *Int. J. Mech. Sci.*, 46(1), 81–98, 2004.
- Bazant Z. P., Kim S. S., Plastic fracturing theory for concrete, *J. Eng. Mech., ASCE*, 105, 407–428, 1979.
- Bazant Z.P., Gambarova P.G., Crack shear in concrete: Crack band microplane model, *J. Struc. Engrg.* 110 (1984) 2015–2036.
- Bazant, Z.P., Prat, P.C., 1988a. Microplane model for brittle-plastic material: I. Theory. *ASCE J. Eng. Mech.* 114, 1672–1688.
- Besson J., 2009, Continuum Models of Ductile Fracture: A Review, *International Journal of Damage Mechanics* 19(1), pp. 3–52.
- Billardon, R. and Pétry, C. (2005). Creep damage behaviour of a copper alloy on a large temperature range. In *ASME/ASCE/SES Conference on Mechanics and Materials (McMat2005)*, 1-3 juin, Baton Rouge, Louisiana, USA.
- Broberg H., A new criterion for brittle creep rupture, *ASME Journal of Applied Mechanics*, 41, 809–817, 1974.
- Brüning M., Gerke S., Hagenbrock V., Micro-mechanical studies on the effect of the stress triaxiality and the Lode parameter on ductile damage, *International Journal of Plasticity*, 50, 49–65, 2013.
- Cao T.-S., Gachet J.-M., Montmitonnet P., Bouchard P.-O., 2014, A Lode-dependent enhanced Lemaitre model for ductile fracture prediction at low stress triaxiality, *Engineering Fracture Mechanics*, 80–96.
- Carol, I., Rizzi, E., Willam, K., 2001. On the formulation of anisotropic elastic degradation. part I: Theory based on a pseudo-logarithmic damage tensor rate, *Int. J. of Solids and Structures*, 38(4), 491–518.
- Chaboche, J.-L., 1978. Description thermodynamique et phénoménologique de la viscoplasticité cyclique avec endommagement., *Doctorat d'Etat Université Paris VI and Technical report Onera 1978-3*.
- Chaboche, J.-L. (1979). Le concept de contrainte effective appliqué à l'élasticité et à la viscoplasticité en présence d'un endommagement anisotrope. In *Col. Euromech 115, Grenoble, Eds du CNRS 1982*.
- Chaboche, J.L. (1984). Anisotropic creep damage in the framework of continuum damage mechanics. *Nuclear Engineering and Design*, 79(3):309–319.
- Chambart M., Desmorat R., Gatuingt F., Intrinsic dissipation of a modular anisotropic damage model: Application to concrete under impact, *Engineering Fracture Mechanics*, 127, (2014), pp. 161–180.
- Chu C.C., Needleman A., Void nucleation effects in biaxially stretched sheets, *J. Eng. Mater. Technol.* 102, 249–256, 1980.
- Cockroft M., Latham D., Ductility and workability of metals. *Journal of the Institute of Metals*, 96, 33–39, 1968.
- Coppola, T., Cortse, L., Folgarait, P., The effect of stress invariants on ductile fracture limit in steels. *Engineering Fracture Mechanics*, 76, 1288–1302, 2009.
- Cordebois J.P., Sidoroff F., Anisotropic damage in elasticity and plasticity, *Journal de Mécanique Théorique et Appliquée*, numéro spécial, 45–60, 1982.
- Coulomb C.A., Essai sur une application des règles des maximis et minimis à quelques problèmes de statique relatifs à l'architecture, *Mémoires de mathématiques et de physique présentés à l'Académie Royale des Sciences par divers savants, et lus sans ses assemblées*, 7, 343–387, 1776.
- Danas K., Ponte Castañeda P., Influence of the Lode parameter and the stress triaxiality on the failure of elasto-plastic porous materials, *International Journal of Solids and Structures*, 2012, 49, 1325–1342.
- Defaisse C., Mazière M., Marcin L., Besson J., Ductile fracture of an ultra-high strength steel under low to moderate stress triaxiality, *Engineering Fracture Mechanics* 194, 301–318, 2018.
- Denoual C., Barbier G., Hild F., A probabilistic approach for fragmentation of brittle materials under dynamic loading, *C. R. Acad. Sci. Paris*, t. 325, Série II b, p. 685–691, 1997.
- Denoual C., Hild F., A Damage Model for the Dynamic Fragmentation of Brittle Solids. *Computer Methods in Applied Mechanics and Engineering*, 2000, 183, 247–258.

- Desmorat R., Modèle d'endommagement anisotrope avec forte dissymétrie traction/compression, 5e journées scientifiques du Regroupement Francophone pour la Recherche et la Formation sur le Béton (RF2B), Liège, Belgique, 5-6 July 2004.
- Desmorat, R. (2006). Positivity of intrinsic dissipation of a class of nonstandard anisotropic damage models. *Comptes Rendus de l'Académie des Sciences, Paris*, 334(10), 587–592.
- Desmorat R., Continuum approach in damage mechanics. In: Summer school hardening and damage of materials under finite deformations, constitutive modeling and numerical implementation. IBZ TU Dortmund, Germany, 3–7 September 2012. Available at: <http://www.lem3.fr/summerschool/00-Files/RD.pdf>.
- Desmorat R., 2016, Anisotropic damage modeling of concrete materials, *International Journal of Damage Mechanics*, 25(6), 818-852.
- Desmorat R., Gatuingt F., Ragueneau F., Nonlocal anisotropic damage model and related computational aspects for quasi-brittle materials, *Engineering Fracture Mechanics*, 74(10), 1539–1560, 2007.
- Desmorat R., Cantournet S., Modeling micro-defects closure effect with isotropic/anisotropic damage, *International Journal of Damage Mechanics*, vol. 17, pp. 65–96, 2008.
- Desmorat R., Otin S., Cross-identification isotropic/anisotropic damage and application to anisothermal structural failure, *Engineering Fracture Mechanics*, 75(11), 3446–3463, 2008.
- Desmorat R., Gatuing F., Ragueneau F., Nonstandard thermodynamics framework for robust computations with induced anisotropic damage, *International Journal of Damage Mechanics*, 19, 53– 73, 2010.
- Desmorat R. , Desmorat B. , Olive M. , Kolev B., Micromechanics based framework with second-order damage tensors, *European Journal of Mechanics / A Solids*, 69 88–98, 2018.
- Di Iorio, S., Briottet, L., Rauch, E. F., and Guichard, D. (2007). Plastic deformation, damage and rupture of PM Ti-6Al-4V at 20 K under monotonic loading. *Acta materialia*, 55(1), 105-118.
- Dougill J.W., On stable progressively fracturing solids, *Z. Angew Math. Phys.* 27, 423-437,1976.
- Drucker D. C., Prager W., Soil mechanics and plastic analysis for limit design, *Quarterly of Applied Mathematics*, 10(2), 157–165, 1952.
- Dyson, B. F., & McLean, D. (1977). Creep of Nimonic 80A in torsion and tension. *Metal science*, 11(2), 37-45.
- Fichant S., Pijaudier-Cabot G., La Borderie C., Continuum damage modelling : approximation of crack induced anisotropy, *Mechanics Research Communications*, 24(2):109–114, 1997.
- Freudenthal A. M, Geiringer H., The mathematical theories of the inelastic continuum. In *Elasticity and Plasticity*, Ed. S. Flugge, 229–433. Springer, 1958.
- Gao X., Zhang T., Zhou J., Graham S.M., Hayden M., Roe, C., On stress-state dependent plasticity modeling: significance of the hydrostatic stress, the third invariant of stress deviator and the non-associated flow rule, *International Journal of Plasticity*, 27(2), 217–231, 2011.
- Govindjee, S., Kay, G. J., Simo, J. C. (1995). Anisotropic modelling and numerical simulation of brittle damage in concrete. *International Journal for Numerical Methods in Engineering* 38(21), 3611-3633.
- Gurson A.L., Continuum theory of ductile rupture by void nucleation and growth – part I. Yield criteria and flow rules for porous ductile media. *J. Eng. Mat. Tech.* 99, 2–15,1977.
- Halm D., Dragon A., An anisotropic model of damage and frictional sliding for brittle materials. *European Journal of Mechanics – A/Solids*, 17, 439–460, 1998.
- Halphen, B., Nguyen, Q., 1975. Sur les matériaux standard généralisés. *Journal de Mécanique* 14, 39–63.
- Hayhurst D. R., Creep rupture under multiaxial states of stress, *J. Mech. Phys. Solids*, 20, No. 6, 381–390, 1972.
- Hayhurst D.R., Leckie F.A., The effect of creep constitutive and damage relationships upon the rupture time of a solid circular torsion bar, *J. Mech. Phys. Solids*, 21, 431–446,1973.
- Hild F., Bouterf A. and Roux S., Damage measurements via DIC, *International Journal of Fracture* volume, 191, 77–105, 2015.
- Hershey A. V., 1954, The plasticity of an isotropic aggregate of anisotropic face centred cubic crystals, *Journal of Applied Mechanics* 21:241–249.
- Hosford W. F., 1972, A generalized isotropic yield criterion, *Journal of Applied Mechanics*, 39, 607–609.
- Johnson A.E., Henderson J., Mathur V.D., Combined stress creep fracture of a commercial copper at 250 C, *Engineer. London*, 202, 261-265 and 299-301, 1956.

- Johnson, A. E., Henderson, J., & Mathur, Y. D. (1960). Complex Stress Creep Fracture of an Aluminium Alloy: An Investigation Conducted at an Elevated Temperature. *Aircraft Engineering and Aerospace Technology*, 32(6), 161-170.
- Johnson, A. E., Henderson, J., & Khan, B. (1962). Creep of a solid metallic bar or thick-walled tube of circular section, at elevated temperatures, when subject to various combinations of uniform bending moment, torque and axial load. *International Journal of Mechanical Sciences*, 4(3), 195-203.
- Ju, J., 1989. On energy-based coupled elastoplastic damage theories: Constitutive modeling and computational aspects. *Int. J. Sol. Struct.* 25, 803–833.
- Kachanov L. M., Time of the rupture process under creep conditions. *Izvestia Akademii Nauk SSSR, Otdelenie Tekhnicheskikh Nauk*, 8, 26–31, 1958.
- Kuhl E., Ramm E., On the linearization of the microplane model, *Mechanics of Cohesive-Frictional Materials* 3 (1998) 343-364.
- Ladevèze, P., 1983. Sur une théorie de l'endommagement anisotrope, internal report 34 of LMT-cachan, ENS Cachan, France.
- Ladevèze, P., 1995. Modeling and simulation of the mechanical behavior of cmcs. *High-Temperature Ceramic-Matrix Composites* 47, 53–63.
- Ladevèze P., Lemaitre J., Damage effective stress in quasi unilateral conditions, in: 16th Internat. Congr. Theor. Appl. Mech., Lyngby, Denmark, 1984.
- Leckie F.A., Hayhurst D.R., Creep rupture of structures, *Proc. R. Soc. Lond. A.*, 340, 323–347, 1974.
- Leckie, F. A. et Onat, E. T. Tensorial nature of damage measuring internal variables. In : *Physical non-linearities in structural analysis*. Springer, Berlin, Heidelberg, 1981. p. 140-155.
- Leckie, F. A., Onat, E. T., 1980. Tensorial nature of damage measuring internal variables. J. Hult and J. Lemaitre eds, Springer Berlin, Ch. *Physical Non-Linearities in Structural Analysis*, pp. 140–155.
- Lemaitre J., Evaluation of dissipation and damage in metals, *Proceedings of I.C.M. Kyoto, Japan*, 1971.
- Lemaitre J., Dufailly J., Modélisation et identification de l'endommagement plastique des métaux, 3e Congrès Français de Mécanique, Grenoble, 1977.
- Lemaitre J., How to use damage mechanics, *Nuclear Engineering and Design*, 80(2), 233–245, 1984.
- Lemaitre J., A Continuous Damage Mechanics Model for Ductile Fracture, *ASME Journal of Engineering Materials and Technology*, 107, 83–89.
- Lemaitre, J., Chaboche, J. L., *Mécanique des matériaux solides*, Dunod 1985, *Mechanics of solid materials*, Oxford University Press, 1991 (english translation).
- Lemaitre, J., Chaboche, J. L., Benallal A., Desmorat R., *Mécanique des matériaux solides*, Dunod 3rd Edition 2009.
- Lemaitre, J., A course on damage mechanics, Springer Verlag, 1992.
- Lemaitre, J., Desmorat, R., Sauzay, M., 2000. Anisotropic damage law of evolution. *Eur. J. Mech., A/ Solids* 19, 187–208.
- Lemaitre J., Desmorat R., *Engineering Damage Mechanics : Ductile, Creep, Fatigue and Brittle Failures*, Springer, 2005.
- Li H., Fu M.W., Lu J., Yang H., Ductile fracture: experiments and computations, *International Journal of Plasticity*, 27(2), 147–180, 2011.
- Lindner D., Towards the fracture prediction of turbomachinery disks: a contribution of the digital image correlation, PhD Université Paris-Saclay, 2016.
- Lode W. Versuche über den Einfluß der mittleren Hauptspannung auf das Fließen der Metalle Eisen, Kupfer und Nickel, *Zeitschrift für Physik*, 36, 913–39, 1926. <http://adsabs.harvard.edu/abs/1926ZPhy...36..913Lz>.
- Y. Lou, H. Huh, Extension of a shear-controlled ductile fracture model considering the stress triaxiality and the Lode parameter, *International Journal of Solids and Structures*, 50, 447–455, 2013.
- Malcher L., Andrade Pires F.M., César de Sá J.M.A., An assessment of isotropic constitutive models for ductile fracture under high and low stress triaxiality, *International Journal of Plasticity*, 30-31, 81–115, 2012
- Malcher L., Mamiya E.N., 2014, An improved damage evolution law based on continuum damage mechanics and its dependence on both stress triaxiality and the third invariant, *International Journal of Plasticity* 56, 232–261.
- Martin J. B., Leckie F. A., On the creep rupture of structures, *J. Mech. Phys. Solids*, 20, 223–238, 1972.

- Mazars, J., Application de la mécanique de l'endommagement au comportement non linéaire et à la rupture du béton de structure. Thèse d'Etat Université Paris 6, 1984.
- Mazars J., A description of micro and micro scale damage of concrete structure, *Engineering Fracture Mechanics*, 25(5-6), 729–737, 1986.
- Mazars J., Berthaud Y., Amtani S., The unilateral behaviour of damaged concrete, *Engineering Fracture Mechanics*, 35(4-5), 629–635, 1990.
- Menzel, A., Steinmann, P., 2001. A theoretical and computational setting for anisotropic continuum damage mechanics at large strains. *Int. J. Solids Struct.* 38, 9505–9523.
- Menzel, A., Ekh, M., Steinmann, P., Runesson, K., 2002. Anisotropic damage coupled to plasticity: Modelling based on the effective configuration concept. *Int. J. Numer. Meth. Eng.* 54, 1409-1430.
- Meschke, G., Lackner, R., Mang A., An anisotropic elastoplastic-damage model for plain concrete, *International Journal for Numerical Methods in Engineering*, 42, 703-727, 1998.
- Mises, R. V. (1928). *Mechanik der plastischen Formänderung von Kristallen*. ZAMM?Journal of Applied Mathematics and Mechanics/Zeitschrift für Angewandte Mathematik und Mechanik, 8(3), 161-185.
- Mohr O., *Abhandlungen aus dem Gebiete der Technischen Mechanik* (2nd ed). Ernst, Berlin, 1914.
- Mohr D., Marcadet S., Micromechanically-motivated Phenomenological Hosford-Coulomb Model for Predicting Ductile Fracture Initiation at Low Stress Triaxialites, *International Journal of Solids and Structures*, 67, 40–55, 2015.
- Murakami S., Ohno N., A constitutive equation of creep damage in polycrystalline metals, IUTAM Col. Euromech 111 "Constitutive Modelling in Inelasticity", Marienbad, Tchechoslovaquie, 1978.
- Murakami, S., 1988. Mechanical modeling of material damage. *ASME J. Appl. Mech.* 55, 280–286.
- Nahshon K, Hutchinson J., Modification of the Gurson model for shear failure, *Eur. J. Mech./A Solids*, 27(1), 1–17, 2008.
- Nashed Z. A., new approach to classification and regularization of ill-posed operator equations. In I. H. W. Eng, C. W. Groetsch (eds.), *Inverse and ill-posed problems*, 53–75. Academic Press, 1987.
- Nguyen T. Dung, Badreddine H., Saanouni K., Plasticité anisotrope non-associée couplée à un endommagement anisotrope en transformations finies, 20ème Congrès Français de Mécanique, Besançon, France, 29 august - 2 september 2011.
- Onat, E. T., 1984. Effective properties of elastic materials that contain penny shaped voids. *Int. J. Eng. Sci.* 22, 1013–1021.
- Ortiz M., A constitutive theory for the inelastic behavior of concrete, *Mechanics of Materials*, 4, 67–93, 1985.
- Ottosen N., A Failure Criterion for Concrete, *Journal of Engineering Mechanics*, 103(EM4), 527–535, 1977.
- Papa, E., Taliercio, A., Anisotropic damage model for the multi-axial static and fatigue behaviour of plain concrete, *Engineering Fracture Mechanics*, 55, 163–179, 1996.
- Papasidero J., Doquet V., Mohr D., Ductile fracture of aluminum 2024-T351 under proportional and non-proportional multi-axial loading: Bao-Wierzbicki results revisited, *International Journal of Solids and Structures* 69–70, 459–474, 2015.
- Pröchtel P., Häußler-Combe U., On the dissipative zone in anisotropic damage models for concrete, *International Journal of Solids and Structures*, 45(16), 2008, pp. 4384-4406.
- Rabotnov Y. N., *Creep problem in structural members*, North Holland Pub. Comp., Amsterdam, 1969.
- Ramtani, S., Berthaud, Y., Mazars, J., Orthotropic behaviour of concrete with directional aspects: modelling and experiments, *Nuclear Engineering and Design*, 133, 97–111, 1992.
- Rice J.R., Tracey D.M., On the ductile enlargement of voids in triaxial stress fields, *J. Mech. Phys. Solids*, 17, 201–217, 1969.
- Rousselier, G., Ductile fracture models and their potential in local approach of fracture. *Nuclear Engrg, Design* 105, 97–111, 1987.
- Saanouni K., Forster C., Ben Hatira F., On the Anelastic Flow with Damage, *International Journal of Damage Mechanics*, 3, 140–169, 1994.
- Salari M.R., Saeb S. a, Willam K. J., Patchet S. J., Carrasco R.C., A coupled elastoplastic damage model for geomaterials *Comput. Methods Appl. Mech. Engrg.*, 193, 2625–2643, 2004.

- Sdobyrev V. P., Long term strength of alloy EI-437B under complex stresses, *Izvestiia Akademii Nauk SSSR, Otdelenie Technicheskikh Nauk*, 4, 92–97, 1958.
- Steinmann, P., Carol, I., 1998. A framework for geometrically nonlinear continuum damage mechanics. *Int. J. Eng. Sci.* 36, 1793-1814.
- Tanaka M. and Bui H. D. (eds.), *Inverse problems in engineering mechanics*, Springer-Verlag, 1993. Proceedings of the IUTAM International Symposium on Inverse Problems in Engineering Mechanics, Tokyo, Japan, May 11-15, 1992.
- Tvergaard V., Needleman A., Analysis of the cup-cone fracture in a round tensile bar, *Acta Metall.* 32, 157–169, 1984.
- Willam K., Warnke E.P., Constitutive model for the triaxial behaviour of concrete. In *IABSE Proceedings*, 19, 1–30, 1975. Seminar on Concrete Structures Subjected to Triaxial Stresses, Bergamo, Italy May 17-19, 1974.
- Wulfinghoff S., Fassin M., Reese S., Damage growth criterion for anisotropic damage models motivated from micromechanics. *International Journal of Solids and Structures*, 121, 21–32, 2017.
- Xue L., Damage accumulation and fracture initiation in uncracked ductile solids subject to triaxial loading, *International Journal of Solids and Structures*, 44, 5163–5181, 2007.
- Yue Z. M., Soyarslan C., Badreddine H., Saanouni K., Tekkaya A. E., Identification of fully coupled anisotropic plasticity and damage constitutive equations using a hybrid experimental-numerical methodology with various triaxialities, *International Journal of Damage Mechanics*, 24(5) 683–710, 2015.

Appendix A – Nonlinear isotropic damage laws for ductile materials

In case of ductile materials, a generic evolution law for isotropic damage is $\dot{D} = g_D(D)g_{\tilde{\sigma}}(\tilde{\sigma}_{eq})g_{T_X}(T_X)g_p(p)\dot{p}$, with the following particular cases.

- $g_D(D) = (1 - D)^{r-k}$, $g_{\tilde{\sigma}}(\tilde{\sigma}_{eq}) = AK_N^N \tilde{\sigma}_{eq}^{r-N}$, $g_{T_X}(T_X) = g_p(p) = 1$ recovers Rabotnov-Kachanov (1969) creep-damage model

$$\dot{D} = A(1 - D)^{-k} \sigma_{eq}^r, \quad \dot{p} = \left(\frac{\sigma_{eq}}{K_N(1 - D)} \right)^N, \quad (117)$$

with K_N and N Norton's viscosity parameters.

- $g_D(D) = 1$, $g_{\tilde{\sigma}}(\tilde{\sigma}_{eq}) = \langle (\tilde{\sigma}_{eq} - \sigma_D) / S \rangle^s$, $g_p(p) = R'(p)$ with isotropic hardening $\tilde{\sigma}_{eq} = \sigma_y + R(p)$ gives back Lemaitre and Dufailly (1977) extension —by the introduction of damage threshold $\sigma_D \geq \sigma_y$ — of Broberg (1974) damage law,

$$\dot{D} = \left\langle \frac{\tilde{\sigma}_{eq} - \sigma_D}{S} \right\rangle^s \langle \dot{\tilde{\sigma}}_{eq} \rangle. \quad (118)$$

- $g_D(D) = (1 - D)^{-k}$, $g_{\tilde{\sigma}}(\tilde{\sigma}_{eq}) = \tilde{\sigma}_{eq}^{2s} / (2ES)^s$, $g_{T_X}(T_X) = R_\nu^s = [\frac{2}{3}(1 + \nu) + 3(1 - 2\nu)T_X^2]^s$, $g_p(p) = 1$ gives

$$\dot{D} = (1 - D)^{-k} \left(\frac{Y}{S} \right)^s \dot{p}, \quad Y = \frac{\sigma_{eq}^2 R_\nu}{2E(1 - D)^2}, \quad (119)$$

which is the generalization of Lemaitre's damage law used in (Saanouni et al, 1994, Yue et al, 2015). In (Cao et al, 2014, Malcher and Mamiya, 2014), the damage strength S is made Lode angle dependent.

- $g_D(D) = g_{\tilde{\sigma}}(\tilde{\sigma}_{eq}) = 1$, $g_{T_X}(T_X) = R_\nu^s$, $g_p(p) = Ap^{2ns}$ gives back Lemaitre (1985) damage law for ductile plastic damage

$$\dot{D} = AR_\nu^s p^{2ns} \dot{p}, \quad (120)$$

and particular case $2sn + 1 \rightarrow q$, $s \rightarrow 0$, $g_p(p) = qD_c p^{q-1} / \epsilon_{pR}^q$,

$$\dot{D} = qD_c \left(\frac{p}{\epsilon_{pR}} \right)^{q-1} \frac{\dot{p}}{\epsilon_{pR}}, \quad (121)$$

used by Xue (2007) with the plastic strain to rupture ϵ_{pR} made dependent on both hydrostatic stress and Lode angle.

Appendix B – Lode angle enhanced fully coupled anisotropic damage models

Let us follow (Lemaitre et al, 2000, Lemaitre and Desmorat, 2005), and consider the enthalpy density $\rho\psi^* = \sup_{\boldsymbol{\epsilon}}(\boldsymbol{\sigma} : \boldsymbol{\epsilon} - \rho\psi)$, instead of the (strain dependent) energy density $\rho\psi$, expressed as

$$\rho\psi^* = \frac{1}{4G} \text{tr}(\boldsymbol{\sigma}'\mathbf{H}\boldsymbol{\sigma}'\mathbf{H}) + \frac{1}{18K} (g(\mathbf{H})\langle \text{tr} \boldsymbol{\sigma} \rangle_+^2 + \langle \text{tr} \boldsymbol{\sigma} \rangle_-^2) + \boldsymbol{\sigma} : \boldsymbol{\epsilon}^p - w_s, \quad (122)$$

with ρ the density, G and K the shear and bulk moduli, $(\cdot)'$ the deviatoric part. The (scalar) micro-defects closure effect function

$$g(\mathbf{H}) = 1 - \eta + \frac{1}{3}\theta \text{tr} \mathbf{H}^2 + \frac{1}{9}(\eta - \theta)(\text{tr} \mathbf{H})^2, \quad (123)$$

is considered, with η and θ as material parameters ($\eta \geq \theta \geq 0$), and such that $g(\mathbf{1}) = 1$. Expression (123) unifies both the phenomenological approach of Desmorat (2016) dedicated to concrete (for which $\theta = \eta = 1$, $\boldsymbol{\epsilon}^p = 0$, $w_s = 0$) and a micro-mechanics based approach (Desmorat et al, 2018, $\theta = \eta/10$). The stored energy density does not vanish for metals, for which $w_s = G(r) + \frac{1}{3}C_X \boldsymbol{\alpha} : \boldsymbol{\alpha}$, with r the isotropic hardening state variable, $\boldsymbol{\alpha}$ the kinematic hardening (tensorial) one and C_X a material parameter (Lemaitre and Chaboche, 1985, 1991). The state laws write

$$\begin{aligned} \boldsymbol{\epsilon} &= \rho \frac{\partial \psi^*}{\partial \boldsymbol{\sigma}} = \frac{1}{2G} (\mathbf{H}\boldsymbol{\sigma}'\mathbf{H})' + \frac{1}{9K} (g(\mathbf{H})\langle \text{tr} \boldsymbol{\sigma} \rangle_+ + \langle \text{tr} \boldsymbol{\sigma} \rangle_-) \mathbf{1} + \boldsymbol{\epsilon}^p, \\ \boldsymbol{\sigma} &= \rho \frac{\partial \psi^*}{\partial \boldsymbol{\epsilon}^p}, \\ \mathbf{Z} &= \rho \frac{\partial \psi^*}{\partial \mathbf{H}} = \frac{1}{2G} \boldsymbol{\sigma}'\mathbf{H}\boldsymbol{\sigma}' + \frac{1}{18K} \langle \text{tr} \boldsymbol{\sigma} \rangle_+^2 \frac{\partial g(\mathbf{H})}{\partial \mathbf{H}}, \\ R &= -\rho \frac{\partial \psi^*}{\partial r} = \frac{dG(r)}{dr}, \\ \mathbf{X} &= -\rho \frac{\partial \psi^*}{\partial \boldsymbol{\alpha}} = \frac{1}{3} C_X \boldsymbol{\alpha}. \end{aligned}$$

The first one allows to define the symmetric effective stress tensor,

$$\tilde{\boldsymbol{\sigma}} = \tilde{\mathbf{s}} + \frac{1}{3} (g(\mathbf{H})\langle \text{tr} \boldsymbol{\sigma} \rangle_+ + \langle \text{tr} \boldsymbol{\sigma} \rangle_-) \mathbf{1}, \quad \tilde{\mathbf{s}} = (\mathbf{H}\boldsymbol{\sigma}'\mathbf{H})'. \quad (124)$$

According to Clausius-Duhem inequality $\mathcal{D} = \boldsymbol{\sigma} : \dot{\boldsymbol{\epsilon}}^p - R \dot{r} - \mathbf{X} : \dot{\boldsymbol{\alpha}} + \mathbf{Z} : \dot{\mathbf{H}} \geq 0$ and to the generalized normality rule for plasticity (Halphen and Nguyen, 1975), the intrinsic dissipation writes

$$\mathcal{D} = \mathcal{D}^p + \mathcal{D}^d \geq 0, \quad \begin{cases} \mathcal{D}^p = \dot{\lambda} [\boldsymbol{\sigma} : \frac{\partial F}{\partial \boldsymbol{\sigma}} + R \frac{\partial F}{\partial R} + \mathbf{X} : \frac{\partial F}{\partial \mathbf{X}}] \geq 0, \\ \mathcal{D}^d = \mathbf{Z} : \dot{\mathbf{H}} \geq 0. \end{cases}$$

with $\dot{\lambda} \geq 0$ the plastic multiplier. The plastic dissipation \mathcal{D}^p is positive for usual plasticity potentials $F = F(\tilde{\boldsymbol{\sigma}}, R, \mathbf{X})$ (coupled with damage through the effective stress (124)), which are convex with respect to $\tilde{\boldsymbol{\sigma}}$, R and \mathbf{X} (Lemaitre, 1992). The dissipation due to damage \mathcal{D}^d is always positive (Desmorat, 2006, Chambart et al, 2014) thanks *i*) to the specific shear-bulk splitting in Eq. (122), *ii*) to the choice (123), with $\eta \geq \theta \geq 0$, for function $g(\mathbf{H})$ (therefore convex in \mathbf{H}) and *iii*) to the property stating that “ \mathcal{D} is definite positive” (satisfied by all damage evolution laws exposed in the present work).

For concrete, a fully coupled anisotropic damage model is obtained by setting $w_s = 0$, $F = 0$ ($r = 0$, $\boldsymbol{\epsilon}^p = \boldsymbol{\alpha} = 0$) and by considering either one of the strain based anisotropic damage laws $\dot{\mathbf{D}} = A \langle \dot{\boldsymbol{\epsilon}} \rangle_+$ or $\dot{\mathbf{D}} = \dot{\lambda} \langle \boldsymbol{\epsilon} \rangle_+$ (see Desmorat et al (2007)) or the stress based anisotropic damage law $\dot{\mathbf{D}} = A \langle \tilde{\boldsymbol{\sigma}} \rangle_+$, or one among the Lode angle enhanced laws (66) or (72), or in a more general manner Eq. (74) possibly extended as

$$-\frac{1}{k+1} \frac{d}{dt} \mathbf{H}^{-2(k+1)} = A \left\langle \frac{d}{dt} \left\{ \tilde{\mathbf{s}} + \left[\frac{2a}{3} \tilde{\boldsymbol{\sigma}}_{eq} \left(1 - \omega \left| \cos 3\tilde{\Theta} \right|^m \right) + r \tilde{\boldsymbol{\sigma}}_H \right] \mathbf{1} \right\} \right\rangle_+. \quad (125)$$

For metals, a fully coupled elasto-plasticity / anisotropic damage model is obtained by using a plasticity governed anisotropic damage law, either $\dot{\mathbf{D}} = A (\zeta |\dot{\epsilon}^p| + (1 - \zeta) \langle \dot{\epsilon}^p \rangle_+)$ (see Desmorat et al (2010)), or a law among the Lode angle enhanced anisotropic damage ones, as previous Eq. (125) or Eq. (95) possibly extended as

$$-\frac{1}{k+1} \frac{d}{dt} \mathbf{H}^{-2(k+1)} = A \left\langle \dot{\epsilon}^p + b \left(1 - \omega \left| \cos 3\tilde{\Theta} \right|^m \right) \dot{p} \mathbf{1} + c \operatorname{tr} \dot{\epsilon} \mathbf{1} \right\rangle_+. \quad (126)$$

In any case, the prefactor A can be changed into a stress triaxiality dependent function, setting for example (Rice and Tracey, 1969, Lemaitre, 1984, 1992) $A = A_0 \tilde{R}_\nu^s$ with $\tilde{R}_\nu = \exp(-a\tilde{T}_X)$ or $\tilde{R}_\nu = \frac{2}{2}(1 + \nu) + 3(1 - 2\nu) \langle \tilde{T}_X \rangle_+^2$ with $\tilde{T}_X = \tilde{\sigma}_H / \tilde{\sigma}_{eq}$.