



**HAL**  
open science

# Estimation of constituent properties of concrete materials with an artificial neural network based method

J Xue, J. Shao, Nicolas Burlion

## ► To cite this version:

J Xue, J. Shao, Nicolas Burlion. Estimation of constituent properties of concrete materials with an artificial neural network based method. *Cement and Concrete Research*, 2021, 150, 10.1016/j.cemconres.2021.106614 . hal-04508816

**HAL Id: hal-04508816**

**<https://hal.science/hal-04508816>**

Submitted on 22 Jul 2024

**HAL** is a multi-disciplinary open access archive for the deposit and dissemination of scientific research documents, whether they are published or not. The documents may come from teaching and research institutions in France or abroad, or from public or private research centers.

L'archive ouverte pluridisciplinaire **HAL**, est destinée au dépôt et à la diffusion de documents scientifiques de niveau recherche, publiés ou non, émanant des établissements d'enseignement et de recherche français ou étrangers, des laboratoires publics ou privés.



Distributed under a Creative Commons Attribution - NonCommercial 4.0 International License



30 trained by using this dataset. Various types of validation of the ANN model are  
31 performed. It is found that the proposed ANN based model can effectively predict the  
32 frictional coefficient and cohesion of porous cement paste at the microscopic scale  
33 with a very good accuracy.

34

35 **Keywords:** Multi-scale modeling; homogenization; parameter identification; artificial  
36 neural network; concrete; heterogeneous materials

37

## 38 **1. Introduction**

39 Concrete materials are widely used in engineering structures. The  
40 characterization of short and long term physical and mechanical properties is crucial  
41 for the analysis of stability and durability of concrete structures. Like most  
42 engineering materials, concrete materials are heterogeneous composites with complex  
43 and multi-scale micro-structures. It is well-known that their macroscopic properties  
44 are inherently related to micro-structural compositions and evolutions at different  
45 scales. Based on experimental data, many macroscopic models have been developed  
46 for describing mechanical behaviors of concretes. In general, these models are not  
47 able to explicitly establish links between macroscopic properties and micro-structural  
48 parameters. To overcome this shortcoming, micro-mechanical approaches have been  
49 developed for estimating macroscopic mechanical properties of concrete composites  
50 in terms of microstructural parameters and constituent properties. In particular, by  
51 using nonlinear homogenization techniques, a number of analytical strength criteria  
52 have been established for heterogeneous materials containing pores and inclusions at  
53 different scales (Maghous et al., 2009; Shen et al., 2013; Shen et al. 2017; Shen et al.  
54 2020). Basic on such criteria, full elastic-plastic models have been formulated by  
55 considering hardening or damage (Shen et al., 2012; Bignonnet et al., 2016; Shen and  
56 Shao, 2016; Shen et al. 2020a; Aldakheel, 2020). On the other hand, based on the full  
57 simulations of representative volume elements by using suitable numerical methods,  
58 different types of numerical homogenization techniques have also been developed for

59 the prediction of macroscopic responses of materials with complex micro-structures  
60 (Cao et al., 2018a; Cao et al. 2018b; Cao et al., 2020). A number of micromechanical  
61 models have been successively applied to cement-based materials (Ghorbanbeigi et al.,  
62 2016; Paiva et al., 2017; Konigsberger et al. 2018; Zhang et al., 2020).

63 For all these micro-mechanics based models, the estimation of macroscopic  
64 mechanical properties is inherently based on the description of microstructures and  
65 local mechanical properties of constituent phases. For instance, for concrete materials,  
66 typical microstructures are composed of cement paste (solid matrix), voids, inclusions  
67 and interface transition zones. In many previous models, the local plastic yield or  
68 strength criterion of the solid matrix is generally described the Drucker-Prager (DP)  
69 linear function which is characterized by frictional and cohesion coefficients.  
70 Therefore, the identification of such local mechanical properties at microscopic scales  
71 is the key issue of micro-mechanical approaches. Advanced multi-scale testing  
72 methods have been developed in order to realize direct measurement of local  
73 mechanical properties, for instance nanoindentation and micro-bending tests  
74 (Nemecek et al., 2016; Konigsberger et al., 2018; Qian et al., 2018; Lau et al., 2019).  
75 However, in most cases, these experimental techniques are so far used for the  
76 identification of local elastic properties and tensile strength at a given scale. It is not  
77 easy to apply these techniques at different scales. In most case, optimal inversion  
78 methods are usually adopted for the estimation of microscopic properties using  
79 macroscopic measurements. The efficiency of these methods is not fully guaranteed  
80 for cases of several parameters to be identified. More efficient and systematic  
81 methods should be developed.

82 During the recent years, machine-learning (ML) based methods have been  
83 rapidly developed in various engineering fields including materials science and  
84 technology. Indeed, based on a deep training, such fully data-driven methods have  
85 been proven to be a powerful and versatile problem-solving tool for both multi-scale  
86 characterization and design of different types of engineering materials and structures.  
87 For instance and without wanting to give an exhaustive review, anisotropic masonry

88 failure properties have been investigated with Artificial Neural Networks (Asteris and  
89 Plevris, 2017). Stochastic vulnerability of masonry structures has further been  
90 assessed (Asteris et al. 2019). ML based solutions have also been applied to mapping  
91 and holistic design of natural hydraulic lime mortars (Apostolopoulou et al. 2020).  
92 Some authors have proposed a hybrid combination of surrogate machine learning  
93 models to predict concrete compressive strength (Asteris et al. 2021). Peak particle  
94 velocity caused by blasting was predicted by using combinations of boosted-CHAID  
95 and SVM Models with various kernels (Zeng et al. 2021). In some recent studies,  
96 some authors have tried to estimate macroscopic strength of porous materials by using  
97 Artificial Neural Networks (Shen et al. 2020b).

98       Therefore, among different types of ML-based solutions, Artificial Neural  
99 Networks (ANN) are one of the mostly adopted methods. The ANN can accurately  
100 identify and learn underlying relationships between input and output data without  
101 considering explicit mathematical equations (Haykin, 2010). Besides, ANN-based  
102 solutions are viewed as an effective alternative to traditional statistical analysis  
103 techniques for function approximation and data fitting due to regardless of  
104 assumptions about mathematical models (Rahman and Zhang, 2018). This type of  
105 method has also been applied to identify constituent properties of concrete materials,  
106 for instance, to identify the nanoscopic elastic modulus of different phases of  
107 cementitious matrix (Ford et al. 2020), to get the abrasion performance of the fly  
108 ash-based geopolymer (Lau et al. 2019). Some authors have also used the ANN  
109 method to investigate the effect of carbon nanotubes on mechanical properties of  
110 novel cement formulations (Konstantopoulos et al., 2020).

111       However, in most previous studies, the emphasis was put on the estimation of  
112 macroscopic physical and mechanical properties. Among studies on the identification  
113 of constituents mechanical properties, most are limited to elastic ones. Very few  
114 studies are available on the estimation of failure or strength properties of constituents.  
115 Moreover, in most previous studies, only one material scale was considered at the  
116 same time while concrete materials are multi-scale composites. Therefore, there is

117 clearly a need to perform further investigations on the identification of strength  
118 properties of constituents in multi-scale heterogeneous materials such as concrete.  
119 This is the main objective of this work.

120 For this purpose, based on the artificial neural networks (ANN) technique, a new  
121 numerical method is developed for the identification of local strength parameters of  
122 solid cement paste by taking into account simultaneously effects of pores and  
123 inclusions. In particular, an original strategy is developed by the combination of an  
124 ANN model with an analytical strength criterion issued from three steps of nonlinear  
125 homogenization. This one has the advantage of easily constructing a large data set by  
126 using analytical solutions, for the ANN model training and verification. The present  
127 paper is organized in three main parts. In Section 2, an analytical macroscopic  
128 strength criterion for concrete-like composites is presented. With this model, a  
129 sensitivity study is performed to identify the key microstructural parameters  
130 controlling the macroscopic strength of materials and to formulate a simplified  
131 analytical macroscopic strength criterion. The general procedure to build an ANN  
132 model is presented in Section 3. The ANN model is used in Section 4 for the  
133 prediction of the local friction and cohesion coefficients of porous cement phase at the  
134 microscopic scale. Its accuracy is clearly demonstrated through comparisons with  
135 analytical solutions. Some concluding remarks are finally presented in Section 5.

## 136 **2. Sensitivity analysis of microstructural parameters**

137 In order to identify the key microstructural parameters controlling the  
138 macroscopic strength of concrete materials, a sensitivity study is first performed. It is  
139 worth noticing that micro-structures of concrete materials are generally complex. For  
140 instances, different types of Calcium silicate hydrate (C-S-H) are formed in cement  
141 paste. Voids and inclusions of different sizes are distributed at different scales. The  
142 macroscopic mechanical properties of concrete materials are inherently affected by  
143 their local counterparts of constituent phases, their morphology, porosity and  
144 volumetric fraction of inclusions. Further, interface transition zones (ITZ) are created  
145 around aggregates and pores. They can significantly affect the macroscopic

146 mechanical properties of materials. It is hard to consider all these micro-structural  
147 parameters at the same time.

148 In this study, the following methodology is adopted. We shall take advantage of  
149 some analytical solutions issued from rigorous nonlinear homogenization techniques  
150 to establish explicit relations between macroscopic strength of concrete and local  
151 strength properties of cement paste, pores and inclusions. In this way, the macroscopic  
152 strength criteria can be formulated in a closed form. Typical strength parameters such  
153 as uniaxial compression and tension strengths can be very easily calculated with any  
154 numerical simulations. Therefore, in view of ANN training, it is very easy to construct  
155 a large data set with very simple calculations with the help of analytical strength  
156 criteria. However, the shortcoming of this study is that the micro-structural  
157 morphology of concrete materials should be simplified in order to establish analytical  
158 strength criteria. For instance, it is mathematically very difficult to derive analytical  
159 strength criteria by considering pores, inclusions and ITZ at the same time. As a  
160 consequence, the effect of ITZ is omitted in this study. It could be taken into account  
161 in future investigations by using direct numerical simulations of concrete  
162 micro-structures to construct data set.

163 With this basic idea, the objective of sensitivity study presented here is to  
164 hierarchize the influences of different micro-structural parameters on macroscopic  
165 strength. Based on this study, a simplified formulation of the macroscopic strength  
166 criterion is proposed.

## 167 **2.1 Presentation of analytical strength criterion and problem statement**

168 Based on the methodology presented above, we consider here concrete or rock  
169 like composites containing two populations of pores and a family of inclusions at  
170 three separate scales. The representative volume element (RVE) of heterogeneous  
171 material is illustrated in Fig. 1.

172 At the macroscopic scale ( $cm$ ), the material is represented by a homogenized  
173 equivalent medium (HEM) whose strength properties are to be predicted. At the  
174 mesoscopic scale ( $mm$ ), mineral inclusions (quartz and calcite grains, aggregates etc.)

175 are distributed in a quasi-continuous matrix (for instance clay matrix or cement paste).  
 176 At the microscopic scale ( $\mu m$ ), this matrix phase contains a family of (large) pores  
 177 (inter-particle pores of a few hundreds of nanometers to micrometers). At the  
 178 nanoscopic scale ( $nm$ ), small pores (intra-particle pores of a few nanometers) are  
 179 embedded inside solid particles.

180

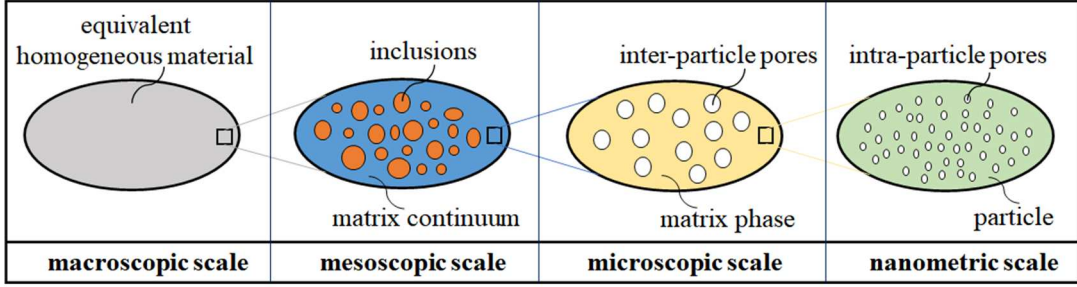

Fig. 1. RVE of heterogeneous materials with two families of pores and inclusions.

181

182 It is assumed that the solid phase at the nanoscopic scale is described by a  
 183 pressure-sensitive Drucker-Prager type yield or strength criterion:

$$F^s = \tilde{\sigma}_d + T(\tilde{\sigma}_m - h) \leq 0 \quad (1)$$

184 where  $\tilde{\sigma}$  denotes the stress tensor of the solid phase.  $\tilde{\sigma}_m = \text{tr}\tilde{\sigma}/3$  is the mean stress.

185  $\tilde{\sigma}_d$  is the deviatoric stress defined as  $\tilde{\sigma}_d = \sqrt{\tilde{\sigma}' : \tilde{\sigma}'}$ , with  $\tilde{\sigma}'$  being the deviatoric

186 part of the stress tensor. The parameter  $T$  denotes the frictional coefficient and  $h$  the

187 hydrostatic tensile strength (also related to internal cohesion) of the solid phase at the

188 nanoscopic scale. By performing three steps of nonlinear homogenization with the

189 modified secant method (Maghous et al., 2009; Shen et al., 2013, Cao et al., 2020),

190 one obtains the following close-form of the macroscopic strength criterion:

$$F = \frac{A + \frac{2B\rho}{3}}{1 + \frac{3\rho}{2} - \frac{5\rho}{6(\frac{A}{B} + 1)}} \Sigma_d^2 + B\Sigma_m^2 + C\Sigma_m - \left( D + \frac{4BD + C^2}{6A} \rho \right) = 0 \quad (2)$$

191 with the following coefficients:

$$A = \frac{1 + \frac{2f}{3}}{T^2} \left( \frac{6T^2 - 13f - 6}{4T^2 - 12f - 9} \phi + 1 \right), \quad B = \frac{\frac{3+f}{2}}{T^2} \phi + \frac{3f}{2T^2} - 1, \quad (3)$$

$$C = 2(1-f)(1-\phi)h, \quad D = (1-f)^2(1-\phi)^2h^2.$$



192 In this criterion,  $\Sigma$  is the macroscopic stress tensor,  $\Sigma_m = tr\Sigma/3$  is the mean stress  
 193 and  $\Sigma_d = \sqrt{\Sigma' : \Sigma'}$  is the deviatoric stress with  $\Sigma'$  being the macroscopic deviatoric  
 194 stress tensor.  $\rho$  represents the volume fraction of inclusions,  $\phi$  is the large porosity  
 195 at the microscopic scale while  $f$  being the small porosity at the nanometric scale.

196 The strength criterion (2) is now applied to the case of uniaxial stress loading. At  
 197 failure state, one has  $\Sigma_d = R$ ,  $\Sigma_m = (-1/3)R$ , with  $R$  being the failure strength  
 198 which can be determined by the following relation.

$$\left( \frac{A + \frac{2B\rho}{3}}{1 + \frac{3\rho}{2} - \frac{5\rho}{6\left(\frac{A}{B} + 1\right)}} + \frac{B}{9} \right) R^2 - \frac{C}{3}R - \left( D + \frac{4BD + C^2}{6A}\rho \right) = 0 \quad (4)$$

199 The above quadratic equation admits one positive and one negative solution,  
 200 which respectively corresponds to the uniaxial tensile strength  $R_t$  and the uniaxial  
 201 compression strength  $R_c$ . Therefore, by knowing the microstructural parameters  
 202 parameters  $(\rho, \phi, f)$  and the nanoscopic strength properties of solid cement particles  
 203  $(T, h)$ , it is easy to calculate the two basic macroscopic strength parameters  $(R_c, R_t)$ .  
 204 But the objective here is to solve the corresponding inverse problem, consisting of  
 205 identifying the values of the nanoscopic strength properties of solid cement particles  
 206  $(T, h)$  from the easily measurable macroscopic strength parameters  $(R_c, R_t)$ .

## 207 2.2 Sensitivity analysis

208 Before going to the resolution of the inverse problem, a sensitivity analysis is  
 209 first realized. The objective is to quantify the dependency of two macroscopic  
 210 strength parameters  $(R_c, R_t)$  on the three microstructural parameters  $(\rho, \phi, f)$  in  
 211 order to define their relative impact on the macroscopic strength.

212 Different types of methods are available for performing sensitivity analysis,  
 213 including one-at-a-time method (OAT) (Czitrom, 1999; Saltelli and Annoni, 2010),  
 214 the derivative-based local approaches (Cacuci et al., 2005; Griewank and Walther,  
 215 2008), the regression analysis (Galton et al., 1989), the variance-based methods

216 (so-called Sobol method) (Sobol, 2001; Saltelli, 2002; Saltelli et al., 2010), the  
 217 variogram analysis of response surfaces (VARs) (Razavi and Gupta, 2016a; Razavi  
 218 and Gupta, 2016b), the Scatter plots (Paruolo et al., 2013) and others. The Sobol  
 219 method is used in this paper because it can measure the sensitivity across the whole  
 220 input space (i.e., the global method), handle nonlinear responses, and measure the  
 221 impact of interactions in non-additive systems (Saltelli, 2002).

222 For the simplicity of presentation, only the influence of input parameters  
 223  $(\rho, \phi, f, T, h)$  on the uniaxial compression strength  $R_c$  using Eq. (4) is analyzed here.  
 224 For this purpose, the relationship between  $R_c$  and the input parameters is written as:

$$R_c = g(\mathbf{X}) \quad (5)$$

225 where  $\mathbf{X} = [\rho, \phi, f, T, h]$ . The calculation sequence of sensitivity analysis is as  
 226 follows.

227 **Step 1:** Randomly generate two independent 1000×5 sample matrices, i.e. each row is  
 228 a sample point in the hyperspace of 5 dimensions. The value range of the parameter is:  
 229  $\rho \in [0, 1]$ ,  $\phi \in [0, 1]$ ,  $f \in [0, 0.5]$ ,  $T \in [0, 1]$ ,  $h \in [0, 80]$ . The generated matrices are  
 230 recorded as  $\mathbf{A}$ ,  $\mathbf{B}$ .

$$\mathbf{A} = \begin{bmatrix} \rho_1 & \phi_1 & f_1 & T_1 & h_1 \\ \rho_2 & \phi_2 & f_2 & T_2 & h_2 \\ \vdots & \vdots & \vdots & \vdots & \vdots \\ \rho_{1000} & \phi_{1000} & f_{1000} & T_{1000} & h_{1000} \end{bmatrix} \quad (6)$$

231

$$\mathbf{B} = \begin{bmatrix} \rho_1^* & \phi_1^* & f_1^* & T_1^* & h_1^* \\ \rho_2^* & \phi_2^* & f_2^* & T_2^* & h_2^* \\ \vdots & \vdots & \vdots & \vdots & \vdots \\ \rho_{1000}^* & \phi_{1000}^* & f_{1000}^* & T_{1000}^* & h_{1000}^* \end{bmatrix} \quad (7)$$

232 **Step 2:** Build 5 further 1000×5 matrices  $\mathbf{A}_B^{(i)}$ , with  $i = 1, 2, \dots, 5$ , such that the  $i$ -th

233 column of  $\mathbf{A}_B^{(i)}$  is equal to the  $i$ -th column of  $\mathbf{B}$ , and the remaining columns are from

234  $\mathbf{A}$ . For instance  $\mathbf{A}_B^{(3)}$  is as follows:

$$\mathbf{A}_B^{(3)} = \begin{bmatrix} \rho_1 & \phi_1 & f_1^* & T_1 & h_1 \\ \rho_2 & \phi_2 & f_2^* & T_2 & h_2 \\ \vdots & \vdots & \vdots & \vdots & \vdots \\ \rho_{1000} & \phi_{1000} & f_{1000}^* & T_{1000} & h_{1000} \end{bmatrix} \quad (8)$$

235

236 **Step 3:** Calculate the estimators by the method proposed in (Janson, 1999; Saltelli et  
 237 al. 2010) with Eqs. (9)-(11).  $(\mathbf{A})_j$  denotes the  $j$ -th row of the matrix  $\mathbf{A}$ ,  $(\mathbf{B})_j$  is the  
 238  $j$ -th row of the matrix  $\mathbf{B}$ , and  $(\mathbf{A}_B^{(i)})_j$  represents the  $j$ -th row of the matrix  $\mathbf{A}_B^{(i)}$ .

$$V_{X_i}(E_{X \sim i}(Y|X_i)) = \frac{1}{1000} \sum_{j=1}^{1000} g(\mathbf{B})_j \left( g(\mathbf{A}_B^{(i)})_j - g(\mathbf{A})_j \right) \quad (9)$$

$$E_{X \sim i}(V_{X_i}(Y|X \sim i)) = \frac{1}{2000} \sum_{j=1}^{1000} \left( g(\mathbf{A})_j - g(\mathbf{A}_B^{(i)})_j \right)^2 \quad (10)$$

$$V(Y) = \frac{1}{1000} \sum_{j=1}^{1000} g(\mathbf{A})_j^2 - \left( \frac{1}{N} \sum_{j=1}^N g(\mathbf{A})_j \right)^2 \quad (11)$$

239 **Step 4:** Calculate the sensitivity indices using the estimators of step 3. The Sobol  
 240 sensitivity index is defined as the ratio of partial variance to total variance (Sobol,  
 241 2001). The first and total sensitivity index is given by Eqs. (12) and (13).

$$S_i = \frac{V_{X_i}(E_{X \sim i}(Y|X_i))}{V(Y)} \quad (12)$$

$$S_{Ti} = 1 - \frac{V_{X \sim i}(E_{X_i}(Y|X \sim i))}{V(Y)} = \frac{E_{X \sim i}(V_{X_i}(Y|X \sim i))}{V(Y)} \quad (13)$$

242

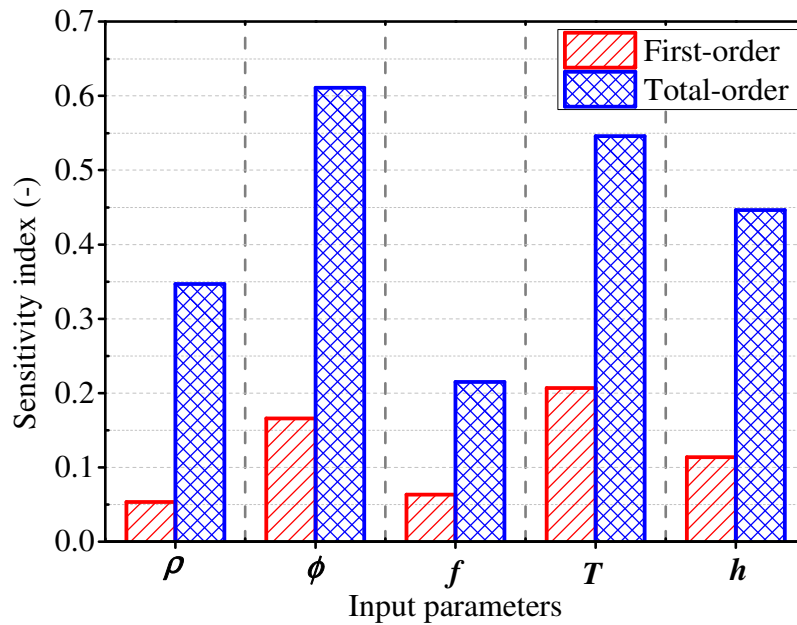

Fig. 2. Results of first-order and total-order index for input parameters.

243 The first-order and total-order indexes of five input parameters based on the  
 244 Sobol method are presented in Fig. 2. Regarding the first-order sensitivity index, the  
 245 three most relevant input features in order are  $T > \phi > h$ , while the two most  
 246 non-significant features in order is  $f > \rho$ . For the total-order sensitivity index, the  
 247 relevant input features in order are  $\phi > T > h > \rho > f$ . At the same time, there is a  
 248 drastic difference between the first-order and total-order indexes for the same  
 249 parameter. These results are consistent with the fact that the total-order sensitivity  
 250 index considers the interaction among the input variables. According to the results  
 251 obtained, one can consider that the small porosity  $f$  has the least influence on the  
 252 macroscopic uniaxial compression strength. Very similar results can be obtained for  
 253 the uniaxial tensile strength.

### 254 2.3 Simplification of analytical strength criterion

255 Based on the sensitivity study presented above, it seems that the effect of the  
 256 nanoscopic porosity  $f$  on the macroscopic strength is relatively small. On the other  
 257 hand, the porosity at the nanoscopic scale is also not easy to be accurately measured.  
 258 In order to facilitate the solution of inverse problem, the microstructure of  
 259 heterogeneous materials is simplified into three representative scales instead of four  
 260 scales shown in Fig. 1. It is physically assumed that the intra-particle pores are  
 261 merged into the solid cement paste phase, as suggested in (Konigsberger et al., 2018).  
 262 The simplified microstructure is illustrated in Fig. 3.

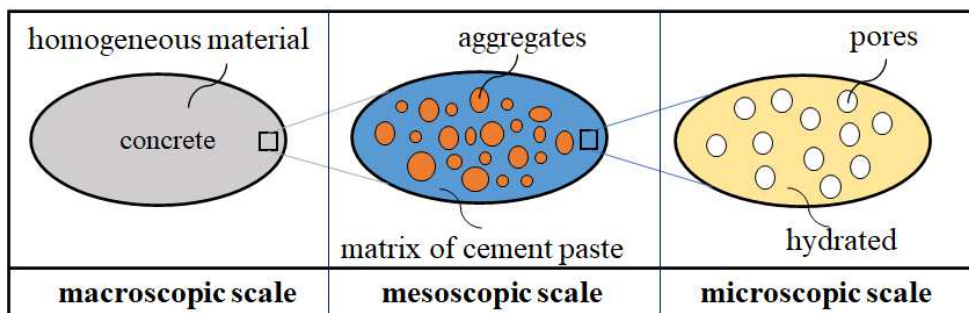

Fig. 3. Simplified RVE of concretes with pores and aggregates.

264

265 Accordingly, the macroscopic strength can be now obtained by making three  
 266 steps of homogenization. This is equivalent to set  $f = 0$  in the criterion (2) and the  
 267 related coefficients (3). The simplified macroscopic strength criterion is expressed as:

$$F' = \frac{A' + \frac{2B'\rho}{3}}{1 + \frac{3\rho}{2} - \frac{5\rho}{6\left(\frac{A'}{B'} + 1\right)}} \Sigma_d^2 + B' \Sigma_m^2 + C' \Sigma_m - \left( D' + \frac{4B'D' + C'^2}{6A'} \rho \right) = 0 \quad (14)$$

268 with the following coefficients:

$$A' = \frac{1}{T'^2} \left( \frac{6T'^2 - 6}{4T'^2 - 9} \phi + 1 \right), \quad B' = \frac{3}{2T'^2} \phi - 1, \quad (15)$$

$$C' = 2(1 - \phi)h', \quad D' = (1 - \phi)^2 h'^2.$$

269 It is worth noticing that in the initial strength criterion (2), the parameters  $T$  and  $h$   
 270 respectively represents the frictional and cohesion coefficients of solid cement paste at  
 271 the nanoscopic scale. In the simplified criterion (14), the parameters  $T'$  and  $h'$   
 272 denotes the frictional and cohesion coefficients of the porous cement paste at the  
 273 microscopic scale. That means that their values include implicitly the effect of  
 274 nanoscopic pores on the strength properties of cement paste.

275 One considers again the uniaxial compression or tension test. At the failure state,  
 276 the strength criterion (14) becomes:

$$\left( \frac{A' + \frac{2B'\rho}{3}}{1 + \frac{3\rho}{2} - \frac{5\rho}{6\left(\frac{A'}{B'} + 1\right)}} + \frac{B'}{9} \right) R^2 - \frac{C'}{3} R - \left( D' + \frac{4B'D' + C'^2}{6A'} \rho \right) = 0 \quad (16)$$

277 Two solutions of this equation correspond to the uniaxial tensile strength  $R_t$  and  
 278 compressive strength  $R_c$ . These two macroscopic strength coefficients are functions  
 279 of the microstructural parameters  $\rho, \phi$  and the microscopic strength parameters  
 280  $T', h'$ . The inverse problem to be solved here is the determination of two microscopic  
 281 strength parameters  $T', h'$  from the known values of microstructural parameters  $\rho, \phi$   
 282 and the macroscopic strength properties  $(R_c, R_t)$ , which can be easily measured by  
 283 standard testing methods. This is a strongly nonlinear problem which is solved by an  
 284 ANN-based method in this study.

### 3. Main steps of building an ANN model

The ANN originated from the biological nervous system and is optimized and applied to the deep learning algorithms (McCulloch and Pitts, 1943). The basic ANN is composed of artificial neurons connected to each other. The connections between neurons are used to transmit signals (called synapses). Each neuron first receives signals, then processes them, and finally sends signals to the neurons connected to it. Such ANNs are able to learn from observational data in the so-called training process and then to predict unknown results. The use of ANNs provides an efficient way to solve large size regression or classification problems. In this section, the main steps of establishing an ANN model are introduced.

Depending on the physical problems and the selected hyper-parameters, the original dataset is generally divided into three parts (train dataset, validation dataset, and test dataset) (Frank et al., 2014). The three parts of dataset are introduced into the model for training and testing. If the test results are satisfactory, the training ends. Otherwise, it is decided to continue the training process to optimize the hyper-parameters of the model, and the amount of original data can be increased if possible. The flowchart for building an ANN model is illustrated in Fig. 4.

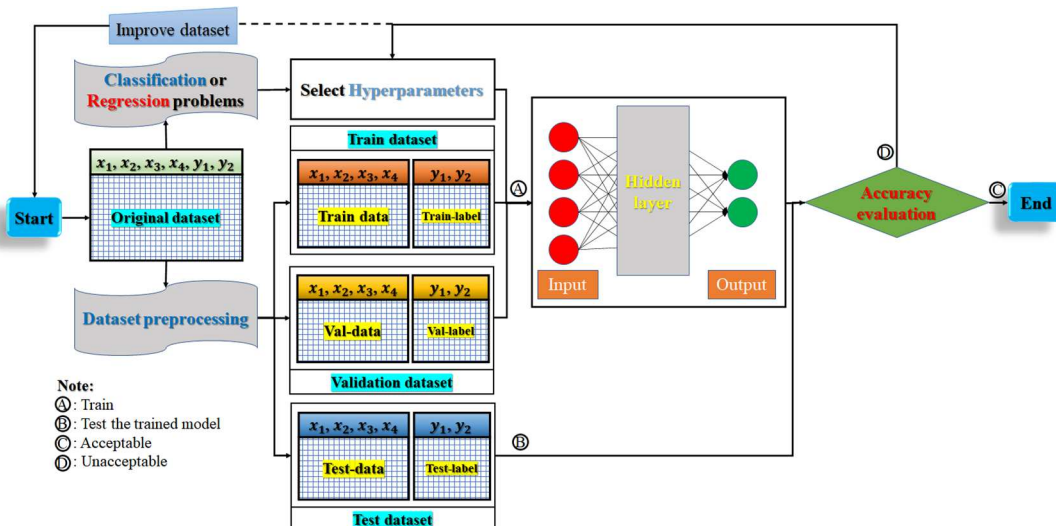

Fig. 4. Flowchart for building an ANN model

#### 3.1 Original dataset preprocessing

305 The ANN modeling is based on the dataset, which is composed of input-data and  
 306 output-label. The classification of input and output is determined according to the  
 307 physical nature of problem. Meanwhile, it is difficult to obtain an accurate training  
 308 model for different scales of input data (Haykin, 2010). Therefore, the preprocessing  
 309 of the original data is very important to the modelling.

310 The preprocessing of the dataset includes two parts in general, one is the  
 311 reasonable division of the dataset, and the other is the normalization or  
 312 standardization of the dataset. The division of the dataset is mainly to complete the  
 313 training and testing of the model, the commonly used allocation ratio is 60%, 20%  
 314 and 20% for train, validation and test respectively (Hashemi et al., 2020; Jiang et al.,  
 315 2020). The normalization or standardization of input and output data is to prevent  
 316 overriding between different scales of numbers and premature saturation of hidden  
 317 nodes (Haykin, 2010). This is completed by using Equation (17) (Ozgoren et al. 2013;  
 318 Jiang et al., 2020) or (18) (Ciaburro et al., 2020):

$$x_i = 0.8 \left( \frac{k_i - k_{min}}{k_{max} - k_{min}} \right) + 0.1 \quad (17)$$

319 where  $i$ ,  $k_i$ ,  $x_i$ ,  $k_{max}$ ,  $k_{min}$  are the serial number of the dataset, the actual value of  
 320 the data, the normalized value, the maximum and minimum values of  $k_i$  in the data  
 321 samples, respectively.

$$x_i = \frac{k_i - \mu}{\sigma} \quad (18)$$

322 where  $\mu$  and  $\sigma$  are the mean and standard deviation in the data samples,  
 323 respectively.

324 For the convenience of description, one takes 4-inputs and 2-outputs containing  
 325 10,000 series of original dataset as an example. This does not lose generality. In the  
 326 beginning, the original dataset ( $10k \times 6$  represents 10,000 rows and 6 columns) is  
 327 randomly divided into two groups, one is the train group ( $8k \times 6$ ), the other is the test  
 328 group ( $2k \times 6$ ). Subsequent, split the train group into two parts train-data (input  
 329 parameters:  $8k \times 4$ ) and train-label (output parameters:  $8k \times 2$ ). Similarly, the test  
 330 group also turns into two parts, namely, test-data ( $2k \times 4$ ) and test-label ( $2k \times 2$ ).  
 331 Besides, Eq. (17) or (18) is used to normalize the train-data and test-data of the

332 previous step. It is worth noticing that the train-label and test-label do not need to be  
 333 normalized. At the last, to make the prediction results of the model more accurate,  
 334 10,000 sets of data are selected from the train-label and the normalized train-data to  
 335 make up a validation dataset, which is composed of validation-data ( $2k \times 4$ ) and  
 336 validation-label ( $2k \times 2$ ). In this way, the required train dataset, validation dataset,  
 337 and test dataset are obtained. The detailed steps are indicated in Fig. 5. The data set  
 338 used in this study can be found in the shared file mentioned in the Supplementary  
 339 Information at the end of this paper.

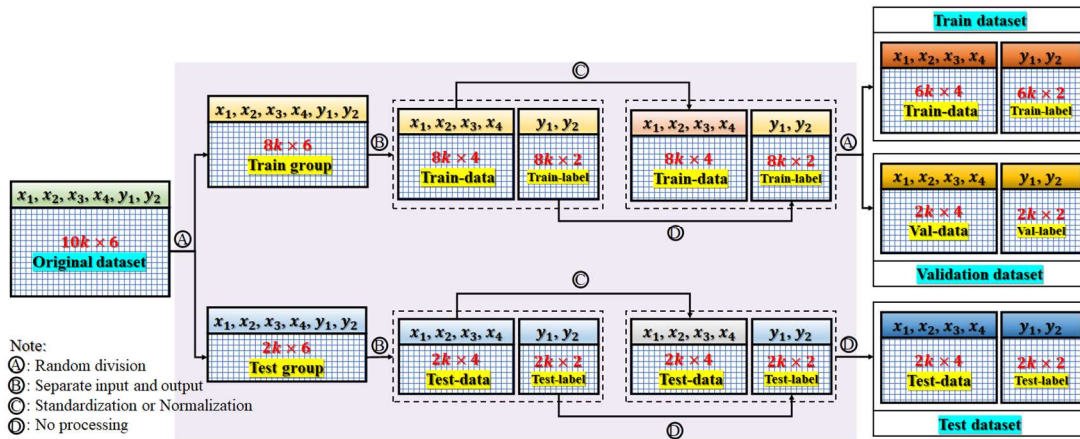

Fig. 5 Original dataset preprocessing process

### 340 3.2 Determination of network structure and algorithm

341 There are several types of ANNs such as feed-forward, radial basis function, and  
 342 recurrent neural networks. For most engineering problems (Ghritlahre and Prasad,  
 343 2018; Jiang et al., 2020; Guijo-Rubio et al., 2020, Shen et al., 2020), the most  
 344 commonly used one is the feed-forward neural network structure with the  
 345 back-propagation (BP) algorithm (Fig. 6). The BP neural network is then adopted in  
 346 this study.

347



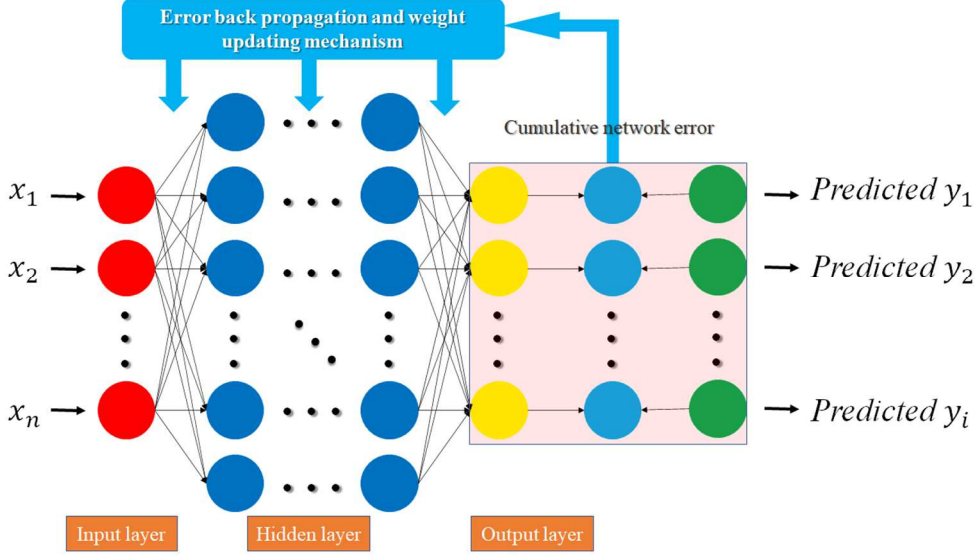

Fig. 6. A multi-layer feed-forward ANN model with a back-propagation algorithm

348

349 A neural network has multiple layers, including one input, one output, and one or  
 350 more hidden layers with a specific number of neurons in each layer. The neurons in  
 351 each layer have two functions: the summation and activation, which are used to sum  
 352 the weighted inputs and to activate this summation to produce the outputs,  
 353 respectively. The internal structure of a neuron is described in Fig. 7. The  $l$ -th layer  
 354 has  $n$  neurons while the  $(l - 1)$ -th layer has  $m$  neurons. The input/output relationship  
 355 of a neuron is indicated in a matrix form as follows:

$$a_i^l = \sigma \left( \sum_{j=1}^m \mathbf{w}_{ij}^l \mathbf{a}_j^{l-1} + \mathbf{b}_i^l \right) \quad (19)$$

356 where  $\mathbf{w}_{ij}^l$  is the weight matrix from the  $(l - 1)$ -th layer to the  $l$ -th layer,  $\mathbf{b}_i^l$  is the  
 357 bias vector for inputs on the  $l$ -th layer, The indices range  $i = 1, 2, \dots, n$ , and  $j =$   
 358  $1, 2, \dots, m$ .  $\sigma$  represents the activation function. The most widely used activation  
 359 functions are :  $\sigma(x) = \tanh x$  (hyperbolic tangent),  $\sigma(x) = \max(0, x)$  (ReLU),  
 360  $\sigma(x) = \frac{1}{1 + \exp(-x)}$  (Sigmoid),  $\sigma(x) = \ln(1 + \exp x)$  (Softplus) and  $\sigma(x) = x$   
 361 (linear) etc. It is worth noticing that the values of weight coefficient and bias are  
 362 essential for the ANN based simulation. Detailed and interesting discussions on this  
 363 aspect have been presented in some recent studies (Asteris and Mokos, 2020; Le et al.,  
 364 2021; Asteris et al., 2021; Armaghani et al., 2021). However, it is not easy to present

365 their values directly in the paper. The values of weights and bias used in the present  
 366 study are given in the shared file mentioned in the Supplementary Information at the  
 367 end of the paper.

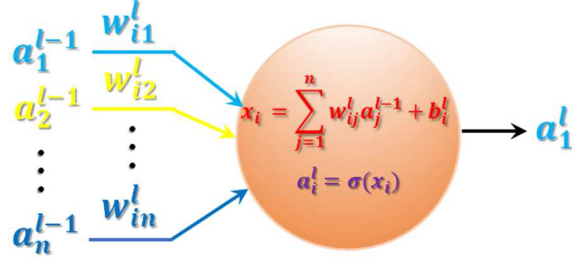

Fig. 7. Artificial neuron

368

369 After the network is established, the model needs to be trained with the  
 370 preprocessed dataset to achieve the target output. The training process is through  
 371 adjusting the weights and bias of the network to obtain minimizing the defined loss  
 372 function (or cost function), e.g., the mean squared error (MSE) defined in Eq. (20)  
 373 (Ashrafian et al., 2020) between the target output and the predicted output for  
 374 regression problems. At the validation phase, the mean absolute error (MAE) defined  
 375 in Eq. (21) (Ashrafian et al., 2020) is used.

$$MSE = \frac{1}{n} \sum_{i=1}^n [ f(x_i) - y_i ]^2 \quad (20)$$

$$MAE = \frac{1}{n} \sum_{i=1}^n |f(x_i) - y_i| \quad (21)$$

376 in which  $f(x_i)$  denotes the ANN prediction,  $y_i$  is the true value. Note that in order  
 377 to speed up the training procedure, the gradient of loss function over all the training  
 378 inputs will be approximated by the one over a small number batch-size (mini-batch),  
 379 randomly chosen from training data.

380 In the BP neural network with a gradient-based optimization algorithm, the  
 381 cumulative network error between its final output and the actual value is  
 382 back-propagated to quickly adjust the values of the weights in the whole network as  
 383 shown in Fig. 6. For more theoretical details about ANN training, readers can refer to  
 384 some reference literatures (Hassan et al., 2009; Deo and Sahim, 2015; Ghritlahre and

385 Prasad, 2018; Ford et al. 2020; Hashemi et al., 2020; Guijo\_Rubio et al., 2020;  
 386 Delgado et al., 2020; Ghorpade et al., 2020; Hegde and Rokseth, 2020). In this paper,  
 387 the algorithm for first-order gradient-based optimization of stochastic objective  
 388 functions is adopted (Chang et al., 2019). It is based on adaptive estimates of  
 389 lower-order moments:

$$g_t = \nabla_{\theta} J(\theta_{t-1}), m_t = \beta_1 m_{t-1} + (1 - \beta_1) g_t, \quad (22)$$

$$v_t = \beta_2 v_{t-1} + (1 - \beta_2) g_t^2, \hat{m}_t = \frac{m_t}{1 - \beta_1^t}, \hat{v}_t = \frac{v_t}{1 - \beta_2^t}, \theta_t = \theta_{t-1} - \frac{\alpha \times \hat{m}_t}{\sqrt{\hat{v}_t + \varepsilon}}$$

390 where  $m_t$  and  $v_t$  are the first-order and second-order momentum.  $\beta_1$  and  $\beta_2$  are  
 391 their exponential decay rate while  $\hat{m}_t$  and  $\hat{v}_t$  are the corresponding modifications of  
 392  $m_t$  and  $v_t$ .  $\alpha$  indicates the learning rate.  $\varepsilon$  is a very small constant to avoid  
 393 denominator to be zero.

394

### 395 3.3 Verification of the trained ANN model

396 The test datasets are used to verify the prediction ability of the optimized ANN  
 397 model. To have a more comprehensive and better comparison, some statistical error  
 398 analysis parameters are used as criteria to evaluate the model.

399 The important statistical parameters used in this study include the relative error  
 400 (RE), absolute relative error (ARE), average absolute relative error (AARE),  
 401 maximum absolute relative error (Max-ARE), and coefficient of determination ( $R^2$ )  
 402 (Hashemi et al., 2020). These parameters can be calculated as follows:

$$\mu_i = \frac{x_{ipr} - x_{iac}}{x_{iac}} \times 100\% \quad (23)$$

$$\mu_{ia} = |\mu_i| \quad (24)$$

$$\bar{\mu} = \frac{\sum_{i=1}^n \mu_{ia}}{n} \quad (25)$$

$$\mu_{max} = \max(\mu_{ia}) \quad (26)$$

$$R^2 = 1 - \frac{\sum_{i=1}^n (x_{iac} - x_{ipr})^2}{\sum_{i=1}^n (x_{ipr} - \bar{x})^2}, \bar{x} = \frac{\sum_{i=1}^n x_{iac}}{n} \quad (27)$$

403 In these relations,  $x_{iac}$  represents  $i$ -th actual value,  $x_{ipr}$  represents  $i$ -th predicted  
 404 value,  $\mu_i$  represents  $i$ -th RE,  $\mu_{ia}$  represents  $i$ -th ARE,  $\bar{\mu}$  represents AARE,  $\mu_{max}$   
 405 represents Max-ARE.

406

#### 407 **4. An ANN model to estimate $T'$ and $h'$**

408 This section describes the building of an ANN method based model to predict  $T'$   
409 and  $h'$  and the evaluation of the developed model.

##### 410 **4.1 Original dataset source**

411 Based on Eq. (16), the purpose here is to generate the dataset  $(\rho, \phi, T', h', R_c, R_t)$ .  
412 In this study, a loop algorithm is used to generate 10,000 sets of data. The core steps  
413 of the calculation are as follows.

414 **Step 1:** Randomly assign values to the four parameters  $(\rho, \phi, T', h')$  respectively. The  
415 selected value ranges are  $\rho \in [0, 1]$ ,  $\phi \in [0, 1]$ ,  $T' \in [0, 1]$ ,  $h' \in [0, 80]$ . Then, go to step  
416 2.

417 **Step 2:** Check whether each set assigned in the step 1 meets the requirement that the  
418 denominator is not zero for the mathematical definition. Here one refers to:  $T' \neq 0$ ,  
419  $4T'^2 - 9 \neq 0$ ,  $A' \neq 0$ ,  $B' \neq 0$ ,  $\frac{A'}{B'} + 1 \neq 0$ ,  $1 + \frac{3\rho}{2} - \frac{5\rho}{6(\frac{A'}{B'} + 1)} \neq 0$ . If it meets the  
420 mathematical conditions, go to step 3, otherwise return to step 1.

421 **Step 3:** Bring the sets that meet the requirements in step 2 into Eq. (16) and solve it.  
422 Then, go to step 4.

423 **Step 4:** Judge if the product of the two roots in step 3 is less than 0 (It is stipulated  
424 that the compressive strength value is positive and the tensile strength value is  
425 negative in Eq. (16), so the solution of the equation must be one positive and one  
426 negative). If the product is less than 0, go to step 5, else return to step 1.

427 **Step 5:** The positive roots of Eq. (16) solved in step 4 are assigned to compressive  
428 strength  $R_c$ , while the absolute value of negative root is assigned to tensile strength  
429  $R_t$ . Then, go to step 6.

430 **Step 6:** Check whether each value of  $R_c$  and  $R_t$  respectively meets:  $1 < R_c < 100$   
431 and  $\frac{1}{20} * R_c < R_t < \frac{1}{10} * R_c$  (for most ordinary concrete materials, the compressive  
432 strength is generally between 1 to 100 MPa, and the tensile strength is  $\frac{1}{20}$ - $\frac{1}{10}$  times  
433 the compressive strength (Gaedicke et al., 2020)). If yes, print  $\rho, \phi, T', h', R_c, R_t$ ;

434 Else, return to step 1.

435 The flowchart for generating the dataset is shown in Fig. 8. A Python script was  
 436 developed to automate the collection of data through the above process.

437

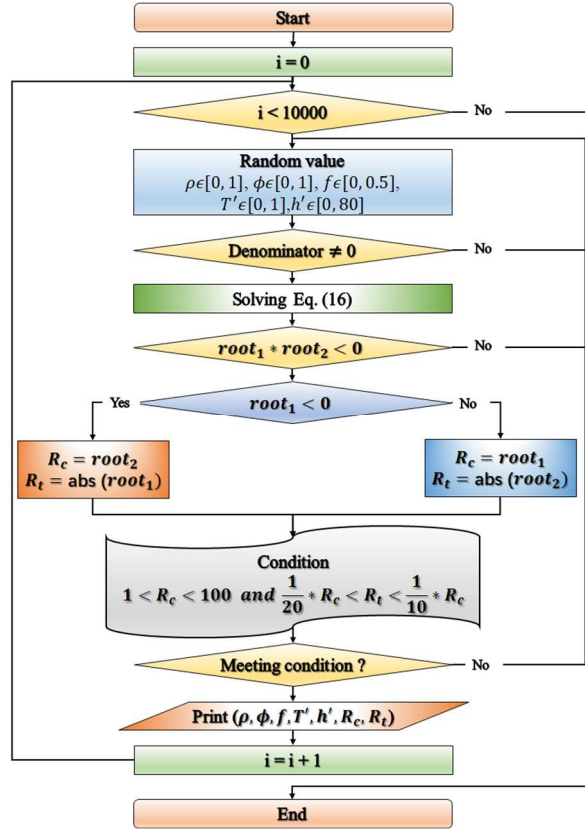

Fig. 8 The flowchart for data generation

## 438 4.2 Construction of the ANN model

439 In this study, an advanced open-source neural network library Keras (2020) is  
 440 used to train the ANN model, able to run on TensorFlow (by Google), CNTK (by  
 441 Microsoft), or Theano (Team et al., 2016). TensorFlow is employed in this work to  
 442 solve the regression problem consisting in predicting the values of  $T'$  and  $h'$ . A BP  
 443 neural network with four hidden layers and 100 neurons in each is constructed. The  
 444 network structure is shown in Fig. 9. It is important to outpoint that the choice of  
 445 ANN architecture is the first important step in developing an ANN model that best  
 446 suits the problem in hand. Unfortunately, there is no guidance for selecting the  
 447 optimal ANN architecture. For instance, the number of layers and neurons are two  
 448 hyper-parameters of the model, which cannot be learnt during the training process. In

449 the present work, inspired by previous studies on similar problems (Asteris and  
450 Plevris, 2017; Asteris and Mocos, 2020; Ford et al. 2020; Konstantopoulos et al.,  
451 2020), preliminary calculations were performed by taking different numbers of layers  
452 and neurons. The accuracy and loss function were compared. Based on such  
453 comparisons, the ANN architecture shown in Fig. 9 is chosen. As it will be shown in  
454 Section 4.3, this architecture provides a very high accuracy. The input/output data and  
455 hyper-parameters for this study are presented in Table 1. The MSE is used as the loss  
456 function and the Adam ( $\beta_1 = 0.9$ ,  $\beta_2 = 0.999$ ,  $\alpha = 0.001$ ,  $\varepsilon = 10e^{-8}$ ) is adopted  
457 as the optimizer. The training and validation processes are illustrated in terms of the  
458 MAE. Further, the Batch-size is 50 and maximum number of epochs is 10,000 for  
459 training.

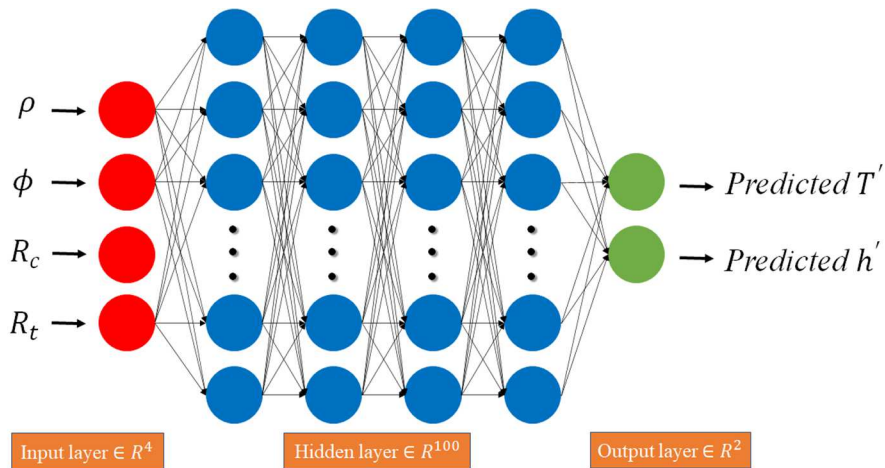

Fig.9. Established BP neural network model

460

461

Table 1: Hyper-parameters of the ANN model for prediction of  $T'$  and  $h'$

Input layer	Hidden layer	Output layer	Loss function	Optimizer
$\rho, \phi, R_c, R_t$	$4 \times 100 \times \text{ReLU}$	$T', h'$	MSE	Adam

462

463

464

465

466

467

468

Another important step for constructing an ANN model is the choice of activation function. As mentioned in sub-section 3.2, there are five widely used activation functions for ANN models. In order to make our choice, we have made preliminary calculations in order to compare these five functions, by using 6000 data sets for training, 2000 for validation and 2000 for test of the ANN model. It was seen that the output results of the activation functions ReLU, sigmoid and softplus were

469 among the best ones in terms of MAE, MSE and  $R^2$ . The differences between them  
 470 were very small. The quality of two other functions was clearly below these three. As  
 471 ReLU is well-known in literature and widely used in previous studies, it is taken in  
 472 this work. It is a traditional and efficient activation function with two main advantages:  
 473 more efficient gradient descent and back propagation, and simpler calculation process.  
 474

### 475 4.3 Verification of the trained model

476 The evolutions of the loss function and the MAE of the training set and the  
 477 validation set in the training data are illustrated in Fig. 10 as functions of the number  
 478 of epochs. It can be seen that the proposed neural network model converges very  
 479 quickly. After continuous learning and self-adjustment of the network, the loss  
 480 function drops rapidly. Simultaneously, the MAE is further reduced. The final values  
 481 of MAE and loss function are  $1.03625 \times 10^{-3}$  and  $2.05 \times 10^{-6}$  for the training dataset  
 482 and  $8.18333 \times 10^{-4}$ ,  $1.36 \times 10^{-6}$  for the validation dataset.  
 483

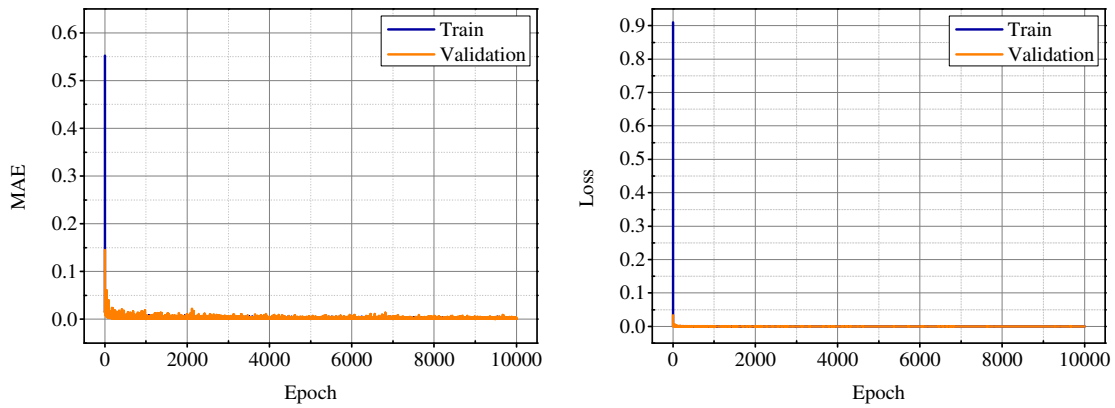

Fig. 10. MAE and loss function evolution during training process

484

485 In order to evaluate the accuracy of ANN-based model, in Fig. 11, one shows the  
 486 relative errors of predicted  $T'$  and  $h'$  for 2,000 selected data. For the value of  $T'$ ,  
 487 most of the relative errors are between  $\pm 0.15$  while those of  $h'$  are between  $\pm 0.25$ . In  
 488 Fig. 12, one plots the predicted values versus exact ones to visualize their correlations.  
 489 Very high values of  $R^2$  are obtained ( $0.997$  for  $T'$  and  $1$  for  $h'$ ). These results  
 490 indicate the high prediction accuracy of the BP neural network model.

491

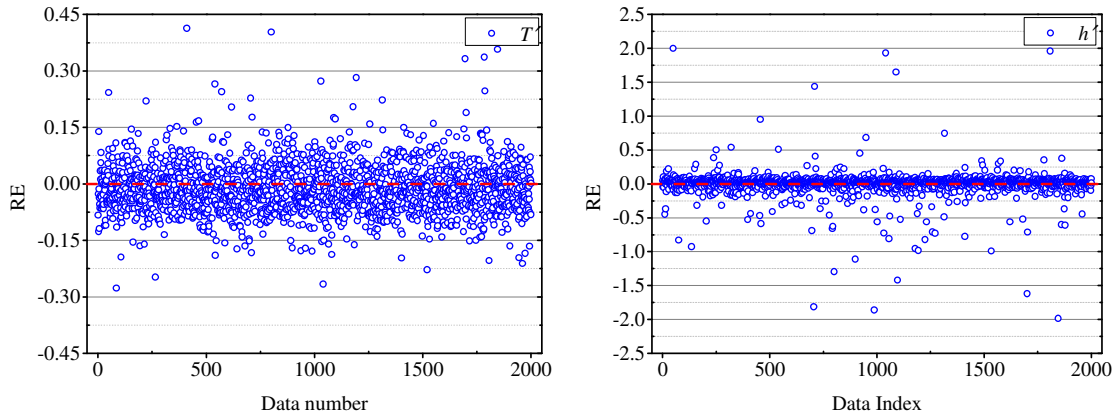

Fig. 11: Relative errors (RE) of predicted microscopic strength parameters

492

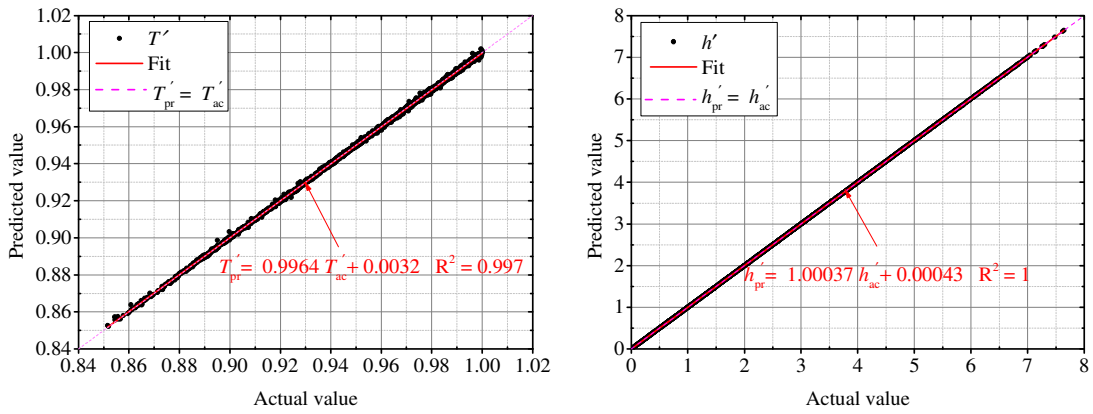

Fig. 12: Correlation between predicted and exact values of  $T'$  and  $h'$

493

494

495

496

497

498

499

Further, in Fig. 13, one shows the direct comparisons between the predicted and exact values of  $T'$  and  $h'$  for 200 data sets, together with the relative errors (RE). It can be seen that for most of the selected data points, the relative errors are relatively small (except several noises). This again demonstrates that the BP neural network model has a high accuracy.



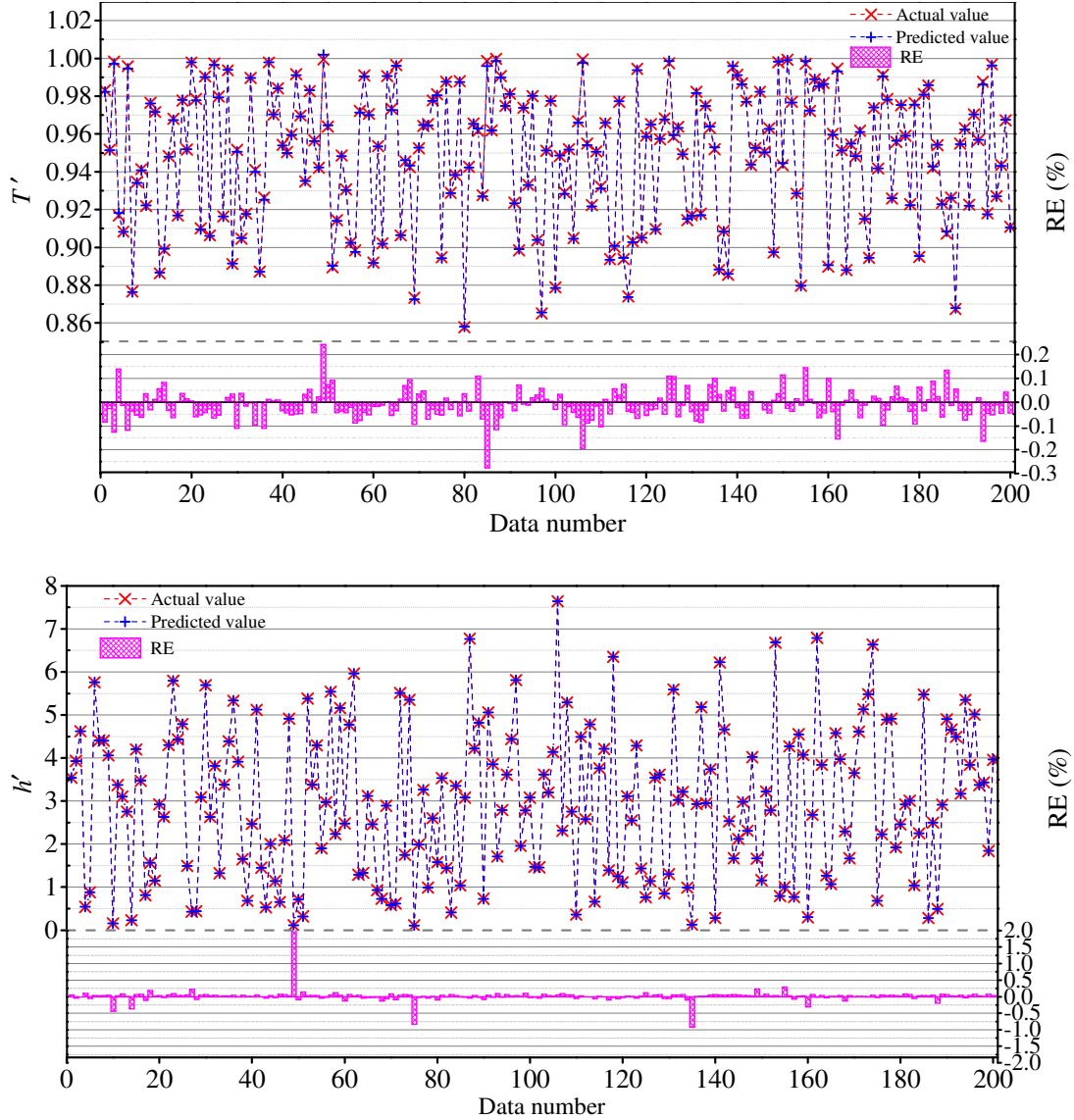

Fig. 13. Comparisons between predicted and exact values of  $T'$  and  $h'$  for 200 data sets

500

501 In order to better understand the error origin of the proposed model, more  
 502 detailed analyses are presented in Fig. 14 and Fig. 15. From Fig. 14, one can see that  
 503 the Max-ARE of  $T'$  and  $h'$  are 0.41% and 2.0%, and their AARE are 0.05% and  
 504 0.07%, respectively. In addition, ARE of  $T'$  is less than 0.13% for 95% of the data,  
 505 and higher than 0.27% for only 0.5%. Similarly, ARE of  $h'$  is 1.42% for 95% of the  
 506 data and 0.2% for only 0.5%. In Fig. 15, the values of ARE are classified in four  
 507 levels respectively in terms of  $ARE > 1\%$ ,  $0.5\% < ARE < 1\%$ ,  $0.2\% < ARE < 0.5\%$ ,  
 508 and  $ARE < 0.2\%$ . The amount of data whose error is less than 1% occupies more than

509 99.4% for predicting  $T'$  and  $h'$ . There is an excellent predictive accuracy for the  
 510 ANN-based model. The detailed comparisons between the test data obtained from the  
 511 analytical strength criterion and the predicted values of friction  $T'$  and cohesion  $h'$   
 512 are also presented in the shared file mentioned in the Supplementary Information at  
 513 the end of the paper.

514 However, it is worth noticing that for engineering application purpose, it would  
 515 be necessary to check the accuracy of the ANN based method by comparing  
 516 numerical predictions with experimental results. We recall that the main objective of  
 517 the present work is to identify the microscopic strength parameters (friction and  
 518 cohesion) of porous cements paste from the measured macroscopic strength  
 519 parameters (uniaxial compression and tension strengths). Therefore, for a complete  
 520 experimental validation, it is need to have a complete set of experimental data on  
 521 concrete samples with known micro-structures for which both macroscopic and  
 522 microscopic strength parameters are measured. Unfortunately, we do not have so far  
 523 such data in hand. We shall take up this exciting challenge in future studies. Therefore,  
 524 the accuracy of the proposed ANN based model is verified by comparisons with the  
 525 analytical solutions.

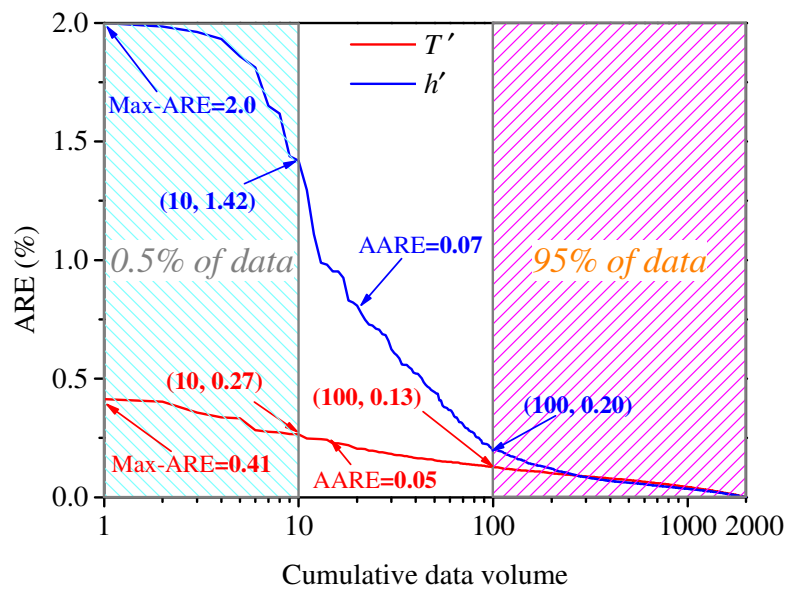

Fig. 14. ARE distribution of  $T'$  and  $h'$

526

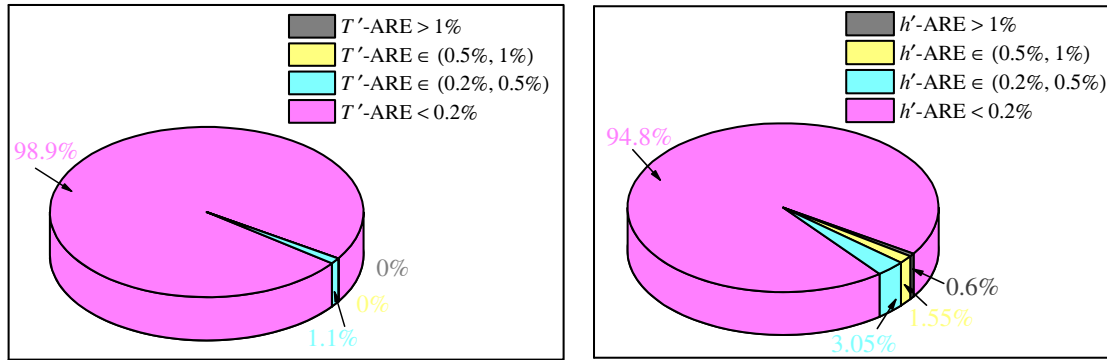

Fig. 15. Proportions of errors of  $T'$  and  $h'$  in terms of four levels of ARE

## 527 5. Conclusions

528 In this paper, an ANN based numerical method has been developed for  
 529 identification of microscopic strength properties of concrete-like composites. This  
 530 method can be also applied to other types of heterogeneous materials. Therefore, this  
 531 machine-learning method provides an efficient way for the calibration of local  
 532 properties of constituent phases at different scales, a crucial challenge of multi-scale  
 533 modeling of heterogeneous materials.

534 In the present study, the dataset used for training and validation was generated  
 535 with the help of a close-form strength criterion issued from an analytical  
 536 homogenization procedure. This dataset can be enriched by any other kinds of data,  
 537 either from direct numerical simulations of micro-structures or experimental tests.

538 In the case considered here, the proposed method has shown a very good  
 539 accuracy for the prediction of frictional coefficient and cohesion of cement paste at  
 540 the microscopic scale. The ANN model contained a BP algorithm and four hidden  
 541 layers with 100 neurons in each one. With a database of 10,000 sets, the probability of  
 542 the absolute relative error (ARE) of less than 1% exceeds 99%.

543 In future studies, with the enrichment of dataset by adding results from direct  
 544 simulations of different types of micro-structures, in particular by considering ITZ, it  
 545 will be possible to directly evaluate macroscopic mechanical properties of concrete  
 546 materials, for which any analytical homogenization solutions cannot be found. Also,  
 547 with the ANN based inverse optimization method proposed here, it will be also  
 548 identify local mechanical properties of constituents in complex micro-structural

549 morphology such as those of ITZ. As an exciting challenge, the efficiency of the  
550 proposed ANN based method can also be verified by suitable experimental data. For  
551 this purpose, multi-scale laboratory tests should be performed on typical concrete  
552 samples with controlled micro-structures (porosity, mineral compositions,  
553 morphology) for which both macroscopic and microscopic mechanical properties can  
554 be measured.

### 555 **Acknowledgements:**

556 The scholarship provided by the China Scholarship Council (CSC, grant No.  
557 201908230319) to the first author is gratefully acknowledged.

### 558 **References:**

- 559
- 560 1. F. Aldakheel, A microscale model for concrete failure in poro-elasto-plastic media,  
561 *Theoretical and Applied Fracture Mechanics* 107 (2020) 102517
  - 562 2. Apostolopoulou, M., Asteris, P.G., Armaghani, D.J., Douvika, M.G., Lourenço,  
563 P.B., Cavaleri, L., Bakolas, A., Moropoulou, A., Mapping and holistic design of  
564 natural hydraulic lime mortars, *Cement and Concrete Research*, 136 (2020),  
565 106167
  - 566 3. Armaghani, D.J., Mamou, A., Maraveas, C., Roussis, P.C., Siorikis, V.G.,  
567 Skentou, A.D. and Asteris, P.G., Predicting the unconfined compressive strength  
568 of granite using only two non-destructive test indexes, *Geomechanics and*  
569 *Engineering* 25(4) (2021): 317-330
  - 570 4. A. Ashrafian, F. Shokri, M.J. Taheri Amiri, Z.M. Yaseen, M. Rezaie-Balf,  
571 Compressive strength of Foamed Cellular Lightweight Concrete simulation: New  
572 development of hybrid artificial intelligence model, *Construction and Building*  
573 *Materials* 230 (2020) 117048
  - 574 5. Asteris, P.G., Plevris, V., Anisotropic Masonry Failure Criterion Using Artificial  
575 Neural Networks, *Neural Computing and Applications*, 28 (8) (2017): 2207-2229
  - 576 6. Asteris, P.G., Moropoulou, A., Skentou, A.D., Apostolopoulou, M., Mohebkah,  
577 A., Cavaleri, L., Rodrigues, H., Varum, H. (2019). Stochastic vulnerability  
578 assessment of masonry structures: Concepts, modeling and restoration Aspects,  
579 *Appl. Sci.*, 9(2) (2019), 243
  - 580 7. Asteris, P.G., Mokos, V.G., Concrete Compressive Strength using Artificial  
581 Neural Networks, *Neural Computing and Applications*, 32 (2020), 1807-1826
  - 582 8. Asteris, P.G., Skentou, A.D., Bardhan, A., Samui, P., Pilakoutas, K., Predicting  
583 concrete compressive strength using hybrid ensembling of surrogate machine  
584 learning models, *Cement and Concrete Research*, 145 (2021), 106449

- 585 9. Asteris, P.G., Lemonis, M.E., Nguyen, T.A., Van Le, H., Pham, B.T., Soft  
586 computing-based estimation of ultimate axial load of rectangular concrete-filled  
587 steel tubes, *Steel and Composite Structures* 39(4) (2021), 471
- 588 10. F. Bignonnet, L. Dormieux, D. Kondo, A micro-mechanical model for the  
589 plasticity of porous granular media and link with the Cam clay model,  
590 *International Journal of Plasticity* 79 (2016) 259-274.
- 591 11. D.G. Cacuci, M. Ionescu-Bujor, I.M. Navon, Sensitivity and uncertainty analysis,  
592 volume II: applications to large-scale systems, CRC press 2005.
- 593 12. Y.J. Cao, W.Q. Shen, J.F. Shao, N. Burlion, Influences of micro-pores and  
594 meso-pores on elastic and plastic properties of porous materials, *European*  
595 *Journal of Mechanics - A/Solids* 72 (2018) 407-423.
- 596 13. Y.J. Cao, W.Q. Shen, N. Burlion, J.F. Shao, Effects of inclusions and pores on  
597 plastic and viscoplastic deformation of rock-like materials, *International Journal*  
598 *of Plasticity* 108 (2018) 107-124.
- 599 14. Y.J. Cao, W.Q. Shen, J.F. Shao, W. Wang, A novel FFT-based phase field model  
600 for damage and cracking behavior of heterogeneous materials, *International*  
601 *Journal of Plasticity* 133 (2020) 102786.
- 602 15. Y.J. Cao, W.Q. Shen, J.F. Shao, W. Wang, A multi-scale model of plasticity and  
603 damage for rock-like materials with pores and inclusions, online, *Int. J. Rock*  
604 *Mechanics and Mining Science*
- 605 16. Z. Chang, Y. Zhang, W. Chen, Electricity price prediction based on hybrid model  
606 of adam optimized LSTM neural network and wavelet transform, *Energy* 187  
607 (2019) 115804.
- 608 17. S.J. Chen, W.H. Duan, Z.J. Li, T.B. Sui, New approach for characterisation of  
609 mechanical properties of cement paste at micrometre scale, *Materials & Design*  
610 87 (2015) 992-995.
- 611 18. G. Ciaburro, G. Iannace, M. Ali, A. Alabdulkarem, A. Nuhait, An artificial neural  
612 network approach to modelling absorbent asphalts acoustic properties, *Journal of*  
613 *King Saud University - Engineering Sciences* (2020).
- 614 19. V. Czitrom, One-Factor-at-a-Time versus Designed Experiments, *The American*  
615 *Statistician* 53(2) (1999) 126-131.
- 616 20. J.M.P.Q. Delgado, F.A.N. Silva, A.C. Azevedo, D.F. Silva, R.L.B. Campello, R.L.  
617 Santos, Artificial neural networks to assess the useful life of reinforced concrete  
618 elements deteriorated by accelerated chloride tests, *Journal of Building*  
619 *Engineering* 31 (2020) 101445.
- 620 21. R.C. Deo, M. Sahin, Application of the Artificial Neural Network model for  
621 prediction of monthly Standardized Precipitation and Evapotranspiration Index  
622 using hydrometeorological parameters and climate indices in eastern Australia,  
623 *Atmospheric Research* 161-162 (2015) 65-81.
- 624 22. E. Ford, S. Kailas, K. Maneparambil, N. Neithalath, Machine learning approaches  
625 to predict the micromechanical properties of cementitious hydration phases from  
626 microstructural chemical maps, *Construction and Building Materials* 265 (2020)  
627 120647.

- 628 23. H. Frank, H. Holger, L.-B. Kevin, An Efficient Approach for Assessing  
629 Hyperparameter Importance, PMLR, 2014, pp. 754-762.
- 630 24. C. Gaedicke, A. Torres, K.C.T. Huynh, A. Marines, A method to correlate  
631 splitting tensile strength and compressive strength of pervious concrete cylinders  
632 and cores, *Construction and Building Materials* 125 (2016) 271-278.
- 633 25. F. Galton, Kinship and Correlation, *Statist. Sci.* 4(2) (1989) 81-86.
- 634 26. H.K. Ghritlahre, R.K. Prasad, Exergetic performance prediction of solar air heater  
635 using MLP, GRNN and RBF models of artificial neural network technique,  
636 *Journal of environmental management* 223 (2018) 566-575.
- 637 27. Ghorbanbeigi, H., Shen, W.Q., Yurtdas, I., Shao, J.F., A micro-mechanics based  
638 model for concrete materials subjected to carbonation, *International Journal for  
639 Numerical and Analytical Methods in Geomechanics* 40(2016): 1203-1218
- 640 28. V.G. Ghorpade, V.S. Koneru, Pattern recognition neural network model for  
641 experimental based compressive strength graded self compacting concrete,  
642 *Materials Today: Proceedings* (2020).
- 643 29. A. Griewank, A. Walther, Evaluating derivatives: principles and techniques of  
644 algorithmic differentiation, SIAM2008.
- 645 30. D. Guijo-Rubio, A.M. Durán-Rosal, P.A. Gutiérrez, A.M. Gómez-Orellana, C.  
646 Casanova-Mateo, J. Sanz-Justo, S. Salcedo-Sanz, C. Hervás-Martínez,  
647 Evolutionary artificial neural networks for accurate solar radiation prediction,  
648 *Energy* 210 (2020) 118374.
- 649 31. A. Hashemi Fath, F. Madanifar, M. Abbasi, Implementation of multilayer  
650 perceptron (MLP) and radial basis function (RBF) neural networks to predict  
651 solution gas-oil ratio of crude oil systems, *Petroleum* 6(1) (2020) 80-91.
- 652 32. A.M. Hassan, A. Alrashdan, M.T. Hayajneh, A.T. Mayyas, Prediction of density,  
653 porosity and hardness in aluminum–copper-based composite materials using  
654 artificial neural network, *Journal of Materials Processing Technology* 209(2)  
655 (2009) 894-899.
- 656 33. S. Haykin, *Neural Networks and Learning Machines*, 3/E, Pearson Education  
657 India2010.
- 658 34. J. Hegde, B. Rokseth, Applications of machine learning methods for engineering  
659 risk assessment – A review, *Safety Science* 122 (2020) 104492.
- 660 35. M.J.W. Jansen, Analysis of variance designs for model output, *Computer Physics  
661 Communications* 117(1) (1999) 35-43.
- 662 36. H. Jiang, Z. Xi, A. A. Rahman, X. Zhang, Prediction of output power with  
663 artificial neural network using extended datasets for Stirling engines, *Applied  
664 Energy* 271 (2020) 115123.
- 665 37. keras, 2020. <https://keras.io/>.
- 666 38. M. Königsberger, M. Hlobil, B. Delsaute, S. Staquet, C. Hellmich, B. Pichler,  
667 Hydrate failure in ITZ governs concrete strength: A micro-to-macro validated  
668 engineering mechanics model, *Cement and Concrete Research* 103 (2018) 77-94.
- 669 39. G. Konstantopoulos, E.P. Koumoulos, C.A. Charitidis, Testing Novel Portland  
670 Cement Formulations with Carbon Nanotubes and Intrinsic Properties Revelation:

- 671 Nanoindentation Analysis with Machine Learning on Microstructure  
672 Identification, *Nanomaterials* 10(4) (2020).
- 673 40. C.K. Lau, H. Lee, V. Vimonsatit, W.Y. Huen, P. Chindaprasirt, Abrasion  
674 resistance behaviour of fly ash based geopolymer using nanoindentation and  
675 artificial neural network, *Construction and Building Materials* 212 (2019)  
676 635-644.
- 677 41. Le, T.T., Asteris, P.G., Lemonis, M.E., Prediction of axial load capacity of  
678 rectangular concrete-filled steel tube columns using machine learning techniques,  
679 *Engineering with Computers* (2021), in press,  
680 <https://doi.org/10.1007/s00366-021-01461-0>
- 681 42. S. Maghous, L. Dormieux, J.F. Barthélémy, Micromechanical approach to the  
682 strength properties of frictional geomaterials, *European Journal of Mechanics -*  
683 *A/Solids* 28(1) (2009) 179-188.
- 684 43. W.S. McCulloch, W. Pitts, A logical calculus of the ideas immanent in nervous  
685 activity, *The bulletin of mathematical biophysics* 5(4) (1943) 115-133.
- 686 44. J. Nemecek, V. Králík, V. Šmilauer, L. Polívka, A. Jäger, Tensile strength of  
687 hydrated cement paste phases assessed by micro-bending tests and  
688 nanoindentation, *Cement and Concrete Composites* 73 (2016) 164-173.
- 689 45. Y.O. Ozgoren, S. Cetinkaya, S. Sarıdemir, A. Cicek, F. Kara, Predictive modeling  
690 of performance of a helium charged Stirling engine using an artificial neural  
691 network, *Energy Conversion and Management* 67 (2013) 357-368.
- 692 46. P. Paruolo, M. Saisana, A. Saltelli, Ratings and rankings: voodoo or science?,  
693 *Journal of the Royal Statistical Society: Series A (Statistics in Society)* 176(3)  
694 (2013) 609-634.
- 695 47. H. Paiva, A.S. Silva, A. Velosa, P. Cachim, V.M. Ferreira, Microstructure and  
696 hardened state properties on pozzolan-containing concrete, *Construction and*  
697 *Building Materials* 140 (2017) 374-384.
- 698 48. R. Qian, Y. Zhang, C. Liu, L. Yang, G. Liu, W. She, Quantitative characterization  
699 of three-dimensional pore structure in hardened cement paste using X-ray  
700 microtomography combined with centrifuge driven metal alloy intrusion,  
701 *Materials Characterization* 145 (2018) 277-283.
- 702 49. A.A. Rahman, X. Zhang, Prediction of oscillatory heat transfer coefficient for a  
703 thermoacoustic heat exchanger through artificial neural network technique,  
704 *International Journal of Heat and Mass Transfer* 124 (2018) 1088-1096.
- 705 50. S. Razavi, H.V. Gupta, A new framework for comprehensive, robust, and efficient  
706 global sensitivity analysis: 1. Theory, *Water Resources Research* 52(1) (2016)  
707 423-439.
- 708 51. S. Razavi, H.V. Gupta, A new framework for comprehensive, robust, and efficient  
709 global sensitivity analysis: 2. Application, *Water Resources Research* 52(1) (2016)  
710 440-455.
- 711 52. A. Saltelli, P. Annoni, How to avoid a perfunctory sensitivity analysis,  
712 *Environmental Modelling & Software* 25(12) (2010) 1508-1517.

- 713 53. A. Saltelli, P. Annoni, I. Azzini, F. Campolongo, M. Ratto, S. Tarantola, Variance  
714 based sensitivity analysis of model output. Design and estimator for the total  
715 sensitivity index, *Computer Physics Communications* 181(2) (2010) 259-270.
- 716 54. A. Saltelli, Making best use of model evaluations to compute sensitivity indices,  
717 *Computer Physics Communications* 145(2) (2002) 280-297.
- 718 55. W.Q. Shen, Y.J. Cao, J.F. Shao, Z.B. Liu, Prediction of plastic yield surface for  
719 porous materials by a machine learning approach, *Materials Today*  
720 *Communications* 25 (2020) 101477.
- 721 56. W.Q. Shen, D. Kondo, L. Dormieux, J.F. Shao, A closed-form three scale model  
722 for ductile rocks with a plastically compressible porous matrix, *Mechanics of*  
723 *Materials* 59 (2013) 73-86.
- 724 57. W.Q. Shen, J.F. Shao, An incremental micro-macro model for porous  
725 geomaterials with double porosity and inclusion, *International Journal of*  
726 *Plasticity* 83 (2016) 37-54.
- 727 58. W.Q. Shen, J.F. Shao, Y.J. Cao, S.S. Wang, W.Y. Xu, A micromechanics-based  
728 enhanced plastic damage model including localization analysis for heterogeneous  
729 geomaterials, *Computers and Geotechnics* 122 (2020) 103512.
- 730 59. W.Q. Shen, J.F. Shao, D. Kondo, B. Gatmiri, A micro–macro model for clayey  
731 rocks with a plastic compressible porous matrix, *International Journal of*  
732 *Plasticity* 36 (2012) 64-85.
- 733 60. W.Q. Shen, J.F. Shao, Z.B. Liu, A. Oueslati, G. De Saxcé, Evaluation and  
734 improvement of macroscopic yield criteria of porous media having a  
735 Drucker-Prager matrix, *International Journal of Plasticity* 126 (2020) 102609.
- 736 61. W.Q. Shen, J. Zhang, J.F. Shao, D. Kondo, Approximate macroscopic yield  
737 criteria for Drucker-Prager type solids with spheroidal voids, *International*  
738 *Journal of Plasticity* 99 (2017) 221-247.
- 739 62. Shen WQ, Cao YJ, Liu ZB, Shao JF (2020), A multiscale elastoplastic  
740 constitutive model for geomaterials with a porous matrix-inclusion microstructure,  
741 *Computers and Geotechnics* 126, doi.org/10.1016/j.compgeo.2020.103683
- 742 63. Z. Shen, Y. Bi, Y. Wang, C. Guo, MLP neural network-based recursive sliding  
743 mode dynamic surface control for trajectory tracking of fully actuated surface  
744 vessel subject to unknown dynamics and input saturation, *Neurocomputing* 377  
745 (2020) 103-112.
- 746 64. T. Team, R. Al-Rfou, G. Alain, A. Almahairi, C. Angermueller, D. Bahdanau, N.  
747 Ballas, F. Bastien, J. Bayer, A. Belikov, A. Belopolsky, Y. Bengio, A. Bergeron, J.  
748 Bergstra, V. Bisson, J. Blecher Snyder, N. Bouchard, N.  
749 Boulanger-Lewandowski, X. Bouthillier, Y. Zhang, Theano: A Python framework  
750 for fast computation of mathematical expressions, (2016)
- 751 65. Zeng, J., Roussis, P.C., Mohammed, A.S., Maraveas, C., Fatemi, S.A., Armaghani,  
752 D.J., Asteris, P.G., Prediction of Peak Particle Velocity Caused by Blasting  
753 through the Combinations of Boosted-CHAID and SVM Models with Various  
754 Kernels. *Appl. Sci.* 11 (2021), 3705



755 66. H. Zhang, Y. Xu, Y. Gan, Z. Chang, E. Schlangen, B. Savija, Microstructure  
756 informed micromechanical modelling of hydrated cement paste: Techniques and  
757 challenges, *Construction and Building Materials* 251 (2020) 118983.  
758