



HAL
open science

Fault-tolerant switched reluctance motor propulsion system for eVTOLs

Marcin Biczyski, Rabia Sehab, James F Whidborne, Guillaume Krebs, Patrick Luk

► **To cite this version:**

Marcin Biczyski, Rabia Sehab, James F Whidborne, Guillaume Krebs, Patrick Luk. Fault-tolerant switched reluctance motor propulsion system for eVTOLs. 12th EASN International Conference on "Innovation in Aviation & Space for opening New Horizons", Oct 2022, Barcelone (ES), Spain. pp.012065, 10.1088/1742-6596/2526/1/012065 . hal-04508671

HAL Id: hal-04508671

<https://hal.science/hal-04508671>

Submitted on 18 Mar 2024

HAL is a multi-disciplinary open access archive for the deposit and dissemination of scientific research documents, whether they are published or not. The documents may come from teaching and research institutions in France or abroad, or from public or private research centers.

L'archive ouverte pluridisciplinaire **HAL**, est destinée au dépôt et à la diffusion de documents scientifiques de niveau recherche, publiés ou non, émanant des établissements d'enseignement et de recherche français ou étrangers, des laboratoires publics ou privés.



Distributed under a Creative Commons Attribution 4.0 International License

PAPER • OPEN ACCESS

Fault-tolerant switched reluctance motor propulsion system for eVTOLs

To cite this article: M Biczyski *et al* 2023 *J. Phys.: Conf. Ser.* **2526** 012065

View the [article online](#) for updates and enhancements.

You may also like

- [Optimum design and research of switched reluctance motor for electric vehicle based on Motor-Cad](#)
J Q Xu and Z S Liu
- [A New Optimization Method for Pole-arc Parameters of Variable-gap Two-phase Switched Reluctance Motor](#)
Ruihao Wang, Junling Huo, Xiaowei Pan et al.
- [Effect of the forces of one-way magnetic attraction on the reliability of the bearing unit of the traction switched reluctance motor](#)
Y Y Miroshnichenko

PRIME
PACIFIC RIM MEETING
ON ELECTROCHEMICAL
AND SOLID STATE SCIENCE

HONOLULU, HI
Oct 6–11, 2024

Abstract submission deadline:
April 12, 2024

Learn more and submit!

Joint Meeting of
The Electrochemical Society
•
The Electrochemical Society of Japan
•
Korea Electrochemical Society

Fault-tolerant switched reluctance motor propulsion system for eVTOLs

M Biczyski^{1,2,3}, R Sehab¹, J F Whidborne², G Krebs³ and P C K Luk²

¹ ESTACA - Campus Ouest, Rue Georges Charpak, 53061 Laval, France

² Cranfield University, College Road, MK43 0AL Cranfield, UK

³ GeePs - Group of electrical engineering - Paris, Plateau de Moulon, 3 rue Joliot-Curie, 91192 Gif-sur-Yvette, France

E-mail: mbiczyski@gmail.com

Abstract. eVTOLs are receiving a lot of attention as a potential solution to urban air mobility challenges. Many configurations are multirotors, which are open loop unstable, therefore very susceptible to actuator failures. Due to their usually short mission duration (20-30 min), fault-tolerance of the propulsion system is of greater importance than reliability. Thus, novel approaches to enhance this capability are required. This study proposes a new fault-tolerant propulsion system using 4-phase switched reluctance motors. It is designed for an 8-10 kg scale multirotor eVTOL, to replace redundant coaxial brushless DC motors with a single fault-tolerant drive. Acknowledging the role of fault-tolerant control algorithms, the propulsion system is validated in terms of the loss of effectiveness metric, typically used in the evaluation of control solutions. The switched reluctance motor propulsion system was found to be highly resilient to open phase and current sensor faults, but susceptible to position sensor faults. This can, however, be mitigated with sensorless control solution. Extending the findings to full-scale eVTOLs is also discussed.

1. Introduction

EASA [1] has published the results of a study on societal concerns for Urban Air Mobility (UAM). In regard to air taxis, the three main concerns are **environmental, noise and vibration, and safety**. The environmental issues encompass (negative) impact on animals, noise pollution, impact from production, and climate impact from operation. Noise annoyance comes not only from magnitude, but also the unfamiliarity of the sound. This creates a requirement for precise vibration control around the 3 kHz frequency, to which humans are especially sensitive [1]. Safety, though, is of paramount importance, because multirotor vehicles are open loop unstable, thus require constant control to be able to fly. This is why they are especially vulnerable to actuating system faults. However, for this specific application, and for the short mission duration, the ability to continue working in the faulty conditions - fault-tolerance - seems to be of a higher importance than reliability (time worked without fault) [2, 3].

The current solution of using Brushless DC (BLDC) motor-based actuating system has multiple possible points of failure, some of them related to rare-earth magnets used (demagnetization, cogging, voltage induction in unpowered phases, etc.). There are, of course, ways of mitigating these issues, such as winding or motor redundancy, but these may not be



suitable for every environment. Therefore, this work proposes an alternative multirotor actuating system using Switched Reluctance (SR) motors, details its design and control and analyzes the influence of three common types of faults (open phase, current sensor and position sensor).

The paper is organized as follows: Section 2 describes the main ideas of the proposed actuating system, specifically focusing on SR motor design; Section 3 covers software implementation of the system, motor control and fault models; Section 4 shows and discusses healthy and faulty behavior; Section 5 addresses the usage of SR technology in eVTOL vehicles; and Section 6 summarizes the findings.

2. Proposed solution

SR motor actuating systems for multirotor applications are a novel approach, thus there are no commercial system of this kind available on the market. Therefore, this study considers a custom-designed system including a propeller, electric motor, converter and a motor controller. A sizing methodology based on [4] was used to obtain a design of a system using an 18 inch propeller and intended for a 8-10 kg vehicle.

In this study, the focus is directed towards obtaining a system that is a good representation of the SR technology, rather than optimizing the performance. Therefore, the motor and converter topologies chosen are conventional and typical for general applications.

The main element of the actuating system is the SR motor. For increased fault-tolerance, the motor is a 4-phase 8/6 conventional design with 71 mm outer diameter. The main parameters are presented in Table 1. The design was obtained and prepared for manufacture using an approach described in [5]. Figure 1 shows the completed, manufactured rotor and shaft assembly, placed in the stator.

Phases	4
Stator teeth	8
Rotor teeth	6
Outer Diameter	71.0 mm
Stator bore	40.4 mm
Airgap	0.2 mm
Voltage	22.2 - 25.2 V (6S LiPo)
Rated power	640 W
Rated speed	5500 RPM
Rated torque	1.1 Nm
Rated current	32 <i>A_{r.m.s.}</i>
Rated efficiency	73%



Table 1: Summary of SR motor parameters.

Figure 1: Manufactured SR motor - wound stator, rotor and shaft.

3. Actuating system simulation

The designed actuating system is implemented using Simcenter Amesim 17 software. The simulation allows for healthy and faulty operation mode analysis, with typical faults injected into the system at different stages of operation. In addition, parameter uncertainties and sensor output errors can also be simulated.

The control system chosen for the study is based on a cascade PI loops - four inner loops for phase current control and one outer loop for speed control. The control structure is shown in Figure 2. This arrangement allows to retain the phase separation of the SR motor and its fault-tolerance capabilities. The PI controller parameters were selected manually trying to minimize the 5% response settling time.

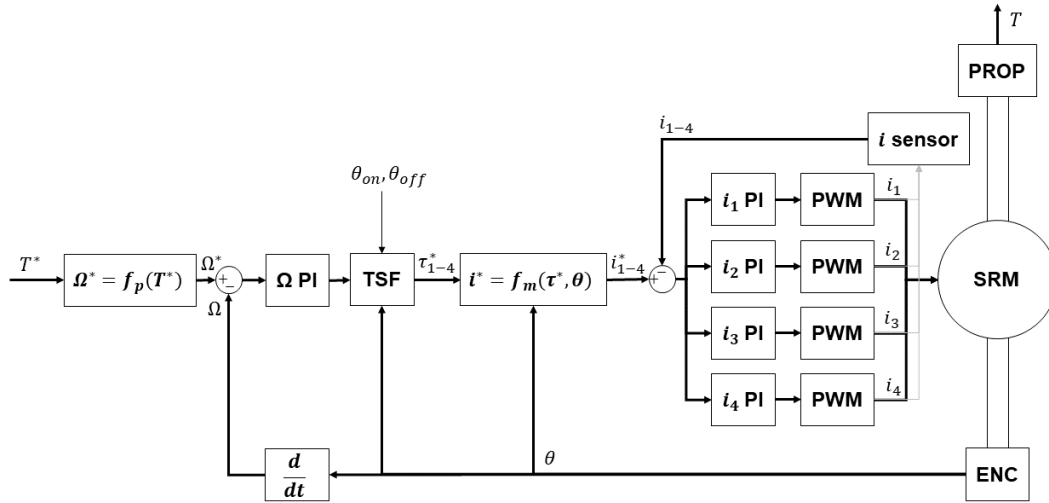

Figure 2: Block diagram of SR motor actuating system.

3.1. Fault definitions

This study makes a distinction between two types of faults: uncertainties and failures. The difference comes from the way these are implemented in the simulation.

Uncertainty is defined as a change of parameter from the baseline (design). It is assumed to be pre-existing at the start of the simulation. The error magnitude (positive or negative) is expressed as a percentage, so that 0% means the baseline value. This allows to find the ranges of acceptable deviation that result in a specific performance degradation, specifically ranges for no performance decrease and 5% decrease.

Failure state is binary, either fully occurring or not at all. However, it can be injected into the simulation at specified times (0.0, 1/0 and 2.5 s), therefore allowing to analyze the behavior at various output levels. This also makes it possible to analyze multiple faults occurring simultaneously, whether in the same or different components. A specific set of failures was used for sensors: zero signal, maximum signal and random signal, which is supposed to model any other type of failure.

In multicopter vehicles, a major source of fault-tolerance is the vehicle control system [6, 7]. Studies on this topic typically simplify actuating system faults with a simple percentage metric called Loss of Effectiveness (LOE):

$$\text{LOE} = \frac{T - T^*}{T^*} \times 100\%, \quad (1)$$

where T and T^* are the thrust and thrust demand. This number, expressed in percent, describes how much thrust (collective or per rotor) is lost after a fault. Specifically, failures are described by the LOE measured 0.49 s after the fault is injected. While in Table 2 the uncertainties are presented using LOE at the end of 1.0 s simulation with WOT thrust demand, in Figures 4 and 6 the effectiveness ($T/T^* \times 100\%$) and the 95% response time metrics are used. This gives a better view into the dynamics of the response and allows to discern if the steady state was reached.

4. Results and discussion

This study focuses on three kinds of faults: winding open phase faults, position sensor faults and current sensor faults. The first is of interest, as high fault-tolerance in this area would offer a major benefit over BLDC motor drives. There is only a single position sensor in the SR motor actuating system (due to weight constraint) and it is crucial for efficient motor control, so the system's behavior during such faults needs to be known. Similarly, although there are four current sensors (one in each phase), they are also crucial for motor control and need to be analyzed.

The results are presented through Tables 2 and 3, as described in the previous section. The term "n/a" is used to denote that the negative error values were not investigated while "-" means that no loss of effectiveness was observed in the analyzed domain. The term "fail" is used where the simulation did not complete.

Table 2: Summary of uncertainty analysis study.

Component	Uncertainty type	negative error value		positive error value	
		5% bound	0% bound	0% bound	5% bound
Phase A curr. sensor	delay	n/a	n/a	8×10^{-5} s	8×10^{-5} s
All phases curr. sensors	delay	n/a	n/a	8×10^{-5} s	8×10^{-5} s
	offset	-10 A	-6 A	2 A	5 A
	noise	n/a	n/a	20%	36%
Position sensor	gain	-0.010	-0.004	0.004	0.010
	noise	n/a	n/a	3%	5%
	initial pos. offset	-2°	-1°	1°	3°
	sampling period	n/a	n/a	$10^{0.8}$ s	$10^{1.1}$ s
	resolution	-	-	-	-

Table 3: Summary of failure simulation studies at start-up and stable conditions.

Component	Failure	0% thrust LOE	50% thrust LOE	100% thrust LOE
Phase A curr. sensor	zero value	fail	fail	fail
	max. value	0.48%	43%	15%
	random signal	fail	0.48%	0.58%
All phases curr. sensors	zero value	fail	fail	fail
	maximum value	100%	78%	87%
	random signal	fail	fail	11%
Phase A	open circuit (high side)	0.33%	0.40%	15%
	open circuit (low side)	0.47%	0.42%	15%
Phases A&B	open circuit	3%	0.56%	39%
Phases A&C	open circuit	3%	0.43%	39%
Phases A&B&C	open circuit	56%	18%	63%
Position sensor	zero value	101%	82%	89%
	max. value	101%	82%	90%
	random signal	100%	99%	99%

4.1. Open phase faults

There is only a slight difference in LOE between an open circuit failure (Figure 3a) on the high or low side of the converter, so this distinction is not kept for other simulations. The recovery from the fault is very quick when injected at $t_{fault} = 0.0$ s (<0.1 s) and almost instantaneous when injected at $t_{fault} = 1.0$ s (improvement over [8]). It seems that **the only adverse effect of a loss of a single phase is limiting the maximum thrust value** to a certain level. However, in the case of open circuit faults in multiple phases, not only does the maximum torque drop, but the response time also increases, which is clearly shown in Figures 3b and 3c. However, the resulting LOE in case of a loss of phase does not correspond to $25\% \times$ the number of lost phases, but is considerably lower, as shown by [9]. This shows that the other phases can easily share part of the load. This is a great benefit in terms of fault-tolerance, especially considering that thrust produced with only two phases conducting is around the value of 2.5 kg.f, so it allows for safe hover of the vehicle.

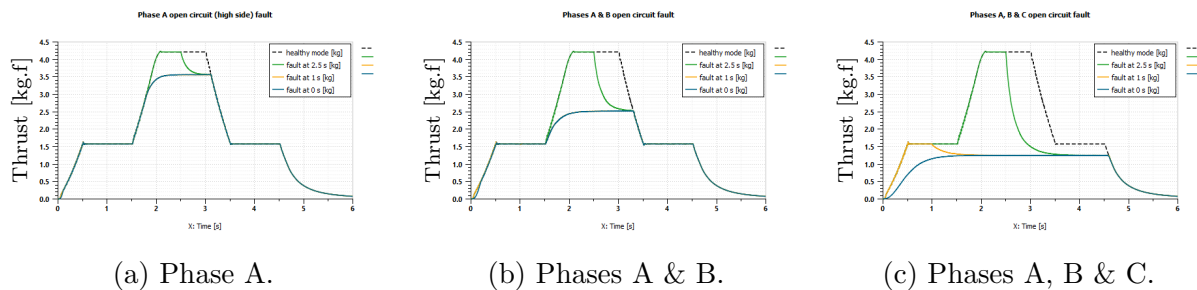

Figure 3: Analysis of multiple phase failures.

4.2. Current sensor faults

The base signal delay of the phase current sensor is 5×10^{-6} s. As shown in Figure 4a, this can be increased by a further 8×10^{-5} s (equal to about 3° mech. at 6300 RPM) without any change in output parameters. Phase current sensor noise also does not seem to affect performance much, as shown in Figure 4c. However, in this case it is high frequency (100 kHz), thus outside the system bandwidth.

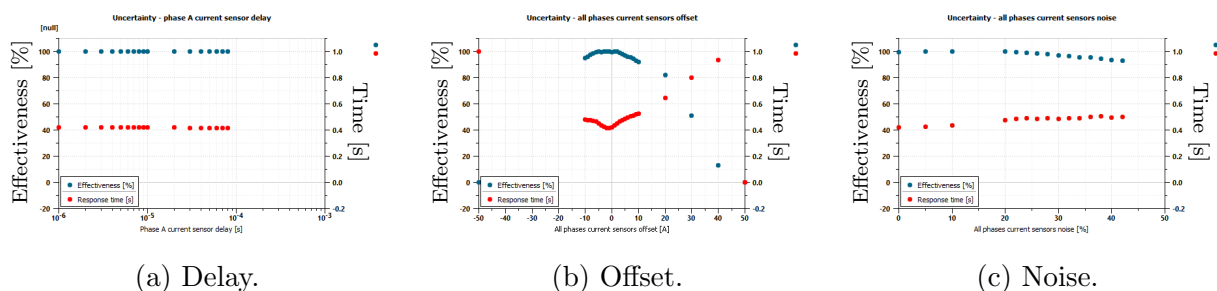

Figure 4: Analysis of uncertainties in current sensors of all phases.

For positive offset values Figure 4b is predictable - due to the sensor offset (or constant bias), the demand value is reached for lower real current, therefore storing less energy in the field and resulting in close-to-linear drop in effectiveness and system response time. Although mathematically it would make sense for the negative part of the domain to be symmetrical to

the positive part (current never reaching zero, reducing energy conversion area), it is more non-linear. This is most likely due to the small energy conversion area increase due to current higher than demanded, but limited by non-linear saturation. In addition, for high magnitude negative error values the simulation does not complete, for the same reasons as for high delay. The edge cases of 50 A and -50 A represent the edge cases of always conducting or not conducting at all and can be ignored, as these are also modeled as faults.

Zero output of a single current sensor causes the simulation to stop due to the current value being too high, as shown in Figure 5a. However, the maximum current sensor signal (Figure 5b) forces the controller into outputting current reducing signal. This makes that phase behave exactly like an open circuit fault (Figure 3a). This is important, as it shows that no other currents are induced in this phase, eliminating the risk to other components. Therefore, it is recommended to set up the current sensing system so that loss of power (or other similar faults) results in sending maximum value of a signal, to protect against over-current. Unfortunately, random signal failure (Figure 5b) results in an unexpected behavior with two of the simulations failing and one completing only with slight noise in the thrust.

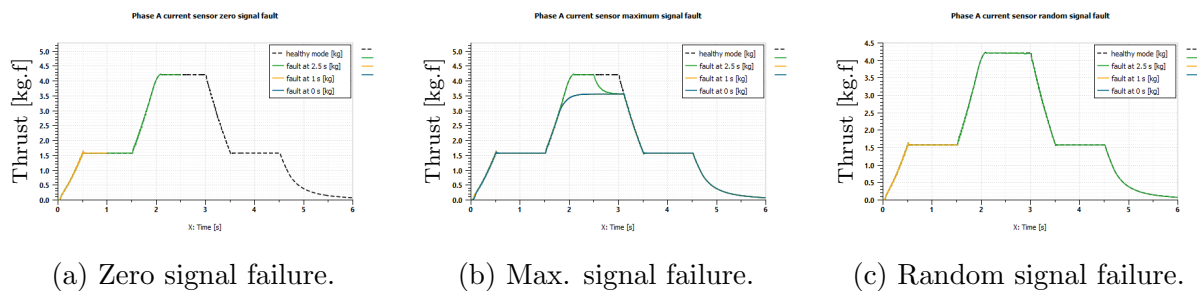

Figure 5: Analysis of phase A current sensor failures.

When applying current sensor failures to all phases, results for zero and random signals are repeated. However, fault-tolerance in case of maximum signal is lost, as now all phases behave like an open circuit fault, thus the motor is not supplied with any current and cannot operate.

4.3. Position sensor faults

The position sensor signal is very sensitive to gain-type uncertainties, as shown in Figure 6a. This is due to the multiplicative nature of the uncertainty, therefore the longer the motor operates, the higher the error value gets. This can be (partially) solved with an additional method of obtaining position data or resetting the position with every evolution. This is a feature of the Heidenhain ERN 1020 used for the test-bench, but has not been modeled in the simulator. In addition, Figure 6b shows the periodical nature of the sensor output signal characteristic.

Some degree of tolerance is found in terms of the sampling period, in the form of a gradual decrease of effectiveness, as shown in Figure 6c. The decrease in response time is due to lower steady state thrust value, therefore being quicker to reach. However, what is surprising, is the fact that neither effectiveness nor response time is affected by changes in the encoder resolution (with default being 2048).

As has already been established above, a position sensor is very vulnerable to uncertainties or other disruptions to its signal. This is confirmed in Figure 7, where each type of fault results in complete loss of effectiveness. Interesting is the fact that in case of zero and max signal faults, a tiny periodic response is produced, most likely caused by the rotor teeth oscillating at the aligned position.

The dependence on a single position sensor for motor control makes the actuating system vulnerable to sensor faults or its incorrect calibration. Even tiny deviations of measurements

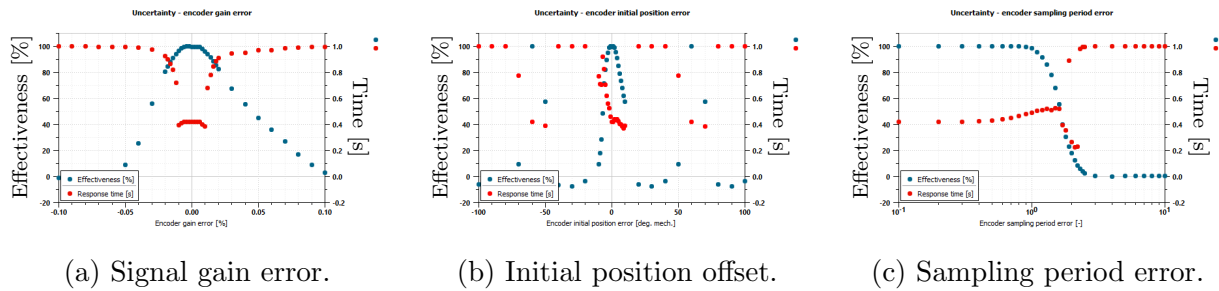

Figure 6: Analysis of uncertainties in incremental encoder.

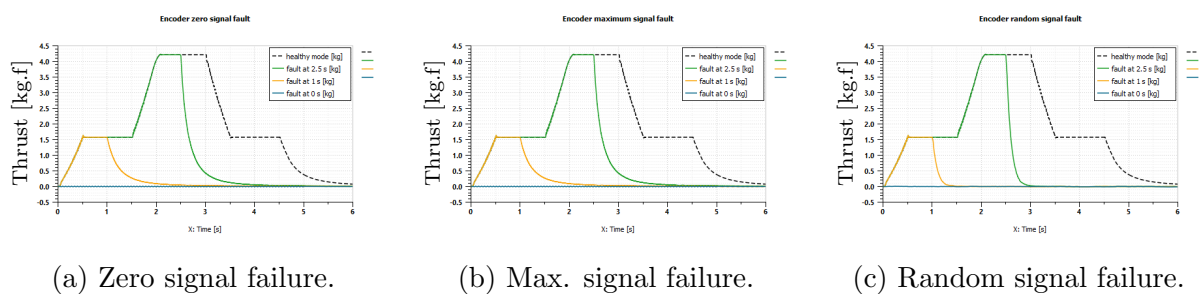

Figure 7: Analysis of encoder failures.

from the actual position lead to significant performance degradation. That is why it is **crucial to introduce redundancy**, whether in the form of multiple physical sensors or a single sensor augmented with a sensorless method. Unfortunately, Hall arrays, which are common in brushless DC drives, cannot be used due to the lack of permanent magnets, thus the lack of a permanent magnetic field. Purely sensorless method is also possible (due to its higher reliability), but the potential quality of the measurement is unknown.

5. Application to full scale eVTOL vehicles

Using a SR motor actuating system at the eVTOL scale can have impact on their introduction into public airspace and the societal acceptance. As shown in the introduction, the three main concerns are environmental, vibration and safety. The simple structure of SR motors is highly sustainable, as it consists only of easily available electrical steel and copper windings, thus making it easy to source and recycle.

When scaling up the presented actuating system - to the eVTOL level, the fault-tolerance capabilities are retained, as these are a derivative of the drive topology - separation of phases and the lack of permanent magnets. Performance wise, a quadratic increase in torque with size and a cubical increase in weight can be expected [10]. However, at higher vehicle sizes the weight constraints are more flexible and the end-winding influence (that had to be counteracted at the scale presented) is diminished, thus allowing for thinner stator teeth and yoke.

A major concern in SR drives is the high level of torque ripple. In multirotor air vehicles applications, where the motor is connected to a propeller and the system's output is measured as thrust. It is clear from Figure 8 that the typical thrust ripple (per arm) is only about 3 g, due to high propeller inertia. Considering the vehicle's weight (8-10 kg depending on configuration) and inertia, the influence should be minimal. However, the vibration from motor operation is within the human hearing range, but should be much quieter than the accompanying propeller noise.

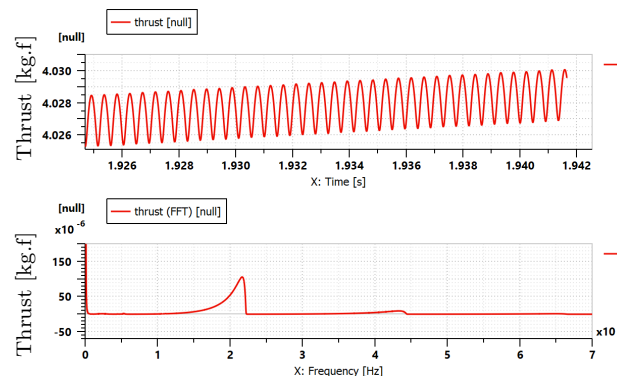

Figure 8: Thrust ripple at high motor speed and the FFT of the acceleration from stall to WOT.

6. Conclusion

There are multiple concerns regarding the introduction of multirotor eVTOLs into public airspace. Three main societal concerns are environmental, noise and vibration, and safety. To address those concerns, especially safety (understood here as fault-tolerance), an alternative actuating system based on switched reluctance motors is developed for an 8-10 kg scale demonstrator multirotor vehicle. This work presents design, control and operation in healthy and faulty conditions. Out of the three kinds of faults analyzed, SR actuating systems are highly resilient against open circuit and current sensor faults. This is a major improvement over brushless DC motors [11, 12]. However, these systems are vulnerable towards position sensor faults, thus require additional redundancy - either as a physical sensor or by using a sensorless control method. The work also addresses the issue of scaling up the system to the eVTOL level and comments on the SR actuating system in regard to the societal issues. Finally, this work highlights the potential of reluctance torque machines and phase separation in the safety critical aerospace applications.

References

- [1] EASA 2021 Study on the societal acceptance of urban air mobility in Europe Tech. rep. McKinsey & Company
- [2] White R 1995 *IV IEEE International Power Electronics Congress. Technical Proceedings. CIEP 95* (IEEE) pp 121–128 ISBN 0-7803-3071-4
- [3] Chen H, Yang H, Chen Y and Iu H H C 2016 *IEEE Transactions on Power Electronics* **31** 2395–2408 ISSN 08858993
- [4] Biczyski M, Sehab R, Whidborne J F, Krebs G and Luk P 2020 *Journal of Advanced Transportation* **2020** 1–14 ISSN 0197-6729
- [5] Biczyski M, Sehab R, Krebs G, Whidborne J F and Luk P 2021 *International Conference on More Electric Aircraft (MEA2021)* P2-20 (Bordeaux, France) pp 1–5
- [6] Zhang X, Zhang Y, Su C Y and Feng Y 2010 *48th AIAA Aerospace Sciences Meeting Including the New Horizons Forum and Aerospace Exposition*
- [7] Xulin L and Yuying G 2018 *Proceedings of the 30th Chinese Control and Decision Conference, CCDC 2018* 1818–1824
- [8] Tursini M, Villani M, Fabri G and Di Leonardo L 2017 *Electric Power Systems Research* **142** 74–83 ISSN 03787796
- [9] Castellini L, Cuscineti U, Lucidi S and Villani M 2016 *Proceedings - 2015 IEEE International Electric Machines and Drives Conference, IEMDC 2015* vol January (IEEE) pp 1678–1682 ISBN 9781479979417
- [10] Gu Q and Stiebler M 1997 *ETEP* **7** 301–310
- [11] Spée R and Wallace A K 1990 *IEEE Transactions on Industry Applications* **26** 259–266 ISSN 19399367
- [12] He H and Yang J 2017 *2017 3rd IEEE International Conference on Control Science and Systems Engineering (ICCSSE)* (IEEE) pp 355–358 ISBN 978-1-5386-0483-0