



**HAL**  
open science

# Constitutive Relation Error Estimators and Adaptivity in Structural Engineering

Pierre Ladevèze

► **To cite this version:**

Pierre Ladevèze. Constitutive Relation Error Estimators and Adaptivity in Structural Engineering. Adaptive Finite Elements in Linear and Nonlinear Solid and Structural Mechanics, Springer Vienna, pp.257-319, 2005, 9783211380604. 10.1007/3-211-38060-4\_5 . hal-04508069

**HAL Id: hal-04508069**

**<https://hal.science/hal-04508069>**

Submitted on 29 Apr 2024

**HAL** is a multi-disciplinary open access archive for the deposit and dissemination of scientific research documents, whether they are published or not. The documents may come from teaching and research institutions in France or abroad, or from public or private research centers.

L'archive ouverte pluridisciplinaire **HAL**, est destinée au dépôt et à la diffusion de documents scientifiques de niveau recherche, publiés ou non, émanant des établissements d'enseignement et de recherche français ou étrangers, des laboratoires publics ou privés.

# Constitutive Relation Error Estimators and Adaptivity in Structural Engineering

Pierre Ladevèze

LMT-Cachan (ENS Cachan / CNRS / Univ. Paris 6)  
61, avenue du Président Wilson  
94235 Cachan Cedex - France  
E-Mail : ladeveze@lmt.ens-cachan.fr

**Abstract:** The basic aspects of error estimators based on residuals on the constitutive relations which have been developed for the past 20 years in particular at Cachan are given. The crucial point is detailed; it is the construction of equilibrated stress fields from the computed finite element solution and the data. Adaptive computational strategies are also described and applied to 2 and 3D engineering examples.

**Key words:** Error estimator, Adaptivity, Finite element, Elasticity, Plasticity, Damage, Dynamic, Modelling error, Model updating.

## 1. Introduction

Quite a lot of error estimators are available for mastering finite element calculation; the state of the art can be found in (Ainsworth and Oden 1993) (Babuska et al. 1994) (Ladevèze and Oden 1998). We deal herein with a particular family introduced in Ladevèze (1975) (1977) which has been developed, in particular at Cachan, for more than 20 years (see also (Ladevèze 1995)). It is named Constitutive Relation Errors (CRE) because these a posteriori error estimators are based on residual errors on constitutive relations. The principle is simple; to the finite element displacement-stress solution, one associates a new one which verifies exactly the most reliable equations (kinematic constraints, equilibrium equations). Therefore, its quality, i.e. the quality of the f.e. analysis is defined by the residual error on the constitutive relation. Their worth lies first in their easy extension to time-dependent non linear problems : (visco)-plasticity, damage, large displacements, dynamics. The CRE also have a strong physical interpretation. Another important property is the fact that the global effectivity index in elasticity is greater than 1. The CRE are then deemed conservative. For an enhanced CRE estimator, this property also holds locally for elasticity problems (Ladevèze and Rougeot 1997).

A central and crucial point is the construction of equilibrated stresses for which we have developed explicit or quasi-explicit general methods. The recovered stress is determined in terms of the computed finite element solution and of the data. The key is what we call “prolongation conditions” which are the link between the f.e. solution and the stress to recover.

Comparison between CRE estimators and other error estimators are also given in addition to the work done in (Strouboulis and Haque 1992) (Babuska et al. 1994, 1997). The estimator ERpB3 developed and used by Babuska, Strouboulis et al. coincides with our standard and practical CRE estimator for linear problems.

Adaptive computational strategies are also described and applied to 2D and 3D engineering examples. For time-dependent nonlinear problems, specific error indicators (time discretization, space discretization, iteration stopping) are introduced to adapt all the computational parameters for a given accuracy.

## Summary

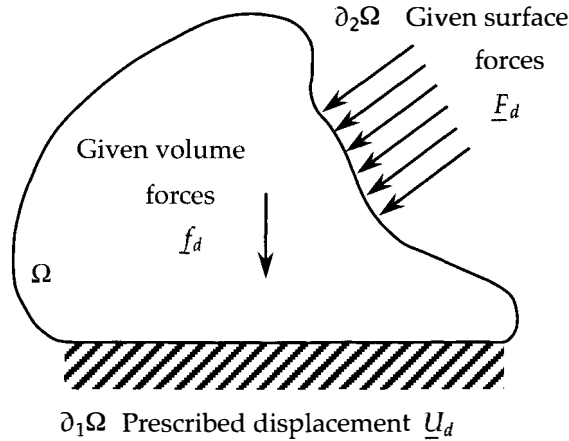
1. Introduction
2. Constitutive Relation Error Estimators in Elasticity
  - 2.1. The Reference Problem to Be Solved - Notations
  - 2.2. Principle of Constitutive Relation Error
  - 2.3. Quality of Constitutive Relation Errors
3. A General Method for Recovering Equilibrated Stress from the f.e. Stress and the Data
  - 3.1. Prolongation Conditions
  - 3.2. Main features of the Standard Recovery Method
  - 3.3. Main Features of the New Version
4. Adaptivity and Optimal Mesh for Steep Gradient Elasticity Problems
  - 4.1. Influence of the Regions with Steep Gradients
  - 4.2. Calculation of the Convergence Coefficient Density
  - 4.3. Optimal Mesh Calculation
  - 4.4. 2D Examples
  - 4.5. 3D Examples
  - 4.6. Remarks
5. Constitutive Relation Errors for f.e. Analysis Considering (Visco)Plasticity and Damage - Adaptivity
  - 5.1. The Drucker CRE Estimator
  - 5.2. The Dissipation CRE Estimator
  - 5.3. Extension of the Dissipation CRE Estimator to (Visco-)Plasticity and Damage
  - 5.4. Error Estimation and Adaptivity for (Visco)-Plastic Structures without Softening
  - 5.5. Enhanced Drucker Error Estimator for (Visco)-Plasticity without Softening
  - 5.6. First Numerical Experiments for (Visco)-Plastic Structures with Softening
6. Constitutive Relation Error for f.e. Dynamic Analysis
  - 6.1. The Reference Problem to Be Solved
  - 6.2. Constitutive Relation Error Estimators
  - 6.3. Test: One Dimension f.e. Dynamic Analysis
  - 6.4. Comparison with other indicators
7. Constitutive relation modelling error in dynamics and model updating
  - 7.1. The forced vibration problem
  - 7.2. Classical CRE Estimator
  - 7.3. Reliable and Less Reliable Experimental Data
  - 7.4. Constitutive Relation Modelling Error
  - 7.5. Organization of the Updating Process
  - 7.6. Test 1: Influence of the Amount of Experimental Information
  - 7.7. Test 2: Eigh-Bay Truss

## 2 Constitutive Relation Error Estimators in Elasticity

CRE have been introduced for linear problems in Ladevèze (1975) (1977) and developed for thermal problems in (Ladevèze and Leguillon 1983) and for elasticity problems in (Ladevèze, Coffignal and Pelle 1986) and (Ladevèze, Pelle and Rougeot 1992). Nearly incompressible elastic materials have been studied in (Gastine et al. 1992). A further study introducing an enhanced CRE estimator can be found in (Ladevèze and Rougeot 1997).

### 2.1 The Reference Problem to be Solved - Notations

The studied structure initially occupies a domain  $\Omega$  with a boundary  $\partial\Omega$ . We will consider small displacements, quasi-static loadings and isothermal conditions. The time interval of interest is denoted by  $[0, T]$ . The structure, for all  $t$  belonging to  $[0, T]$ , is placed in an "environment" characterized by a displacement  $\underline{U}_d$  on a part  $\partial_1\Omega$  of the boundary of  $\Omega$ , a surface force density  $\underline{F}_d$  on  $\partial_2\Omega$ , the part of  $\partial\Omega$  complementary to  $\partial_1\Omega$ , and a volume force density  $\underline{f}_d$  on the domain  $\Omega$ .



**Figure 1.** Schematic diagram of the environment (i.e. the imposed conditions)

The problem which describes the evolution of the structure on  $[0, T]$  is:

Find the displacement  $\underline{U}(\underline{M}, t)$  and the stress  $\underline{\sigma}(\underline{M}, t)$  with  $(t \in [0, T])$  and  $(\underline{M} \in \Omega)$ , which satisfy:

- kinematic constraints:

$$\underline{U} \in \mathcal{Z}^{[0, T]}; \quad \underline{U}|_{\partial_1\Omega} = \underline{U}_d \text{ on } ]0, T[ \quad (1)$$

- equilibrium equations (principle of virtual work):

$$\begin{aligned} \underline{\sigma} &\in \mathcal{S}^{[0, T]}; \forall t \in ]0, T[ \quad \forall \underline{U}^* \in \mathcal{U}_{ad, 0} \\ \int_{\Omega} \text{Tr} [\underline{\sigma} \varepsilon (\underline{U}^*)] d\Omega &= \int_{\Omega} \underline{f}_d \circ \underline{U}^* d\Omega + \int_{\partial_2 \Omega} \underline{F}_d \circ \underline{U}^* dS \end{aligned} \quad (2)$$

- constitutive relation:

$$\forall t \in ]0, T[ \quad \forall \underline{M} \in \Omega \quad \underline{\sigma}|_t = \mathbf{A} \left( \varepsilon \left( \dot{\underline{U}}|_{\tau} \right); \tau \leq t \right) \quad (3)$$

$\varepsilon (\underline{U})$  denotes the strain associated with the displacement  $\left( \varepsilon (\underline{U})_{ij} = \frac{1}{2} (U_{i,j} + U_{j,i}) \right)$ .  $\mathcal{U}^{[0, T]}$  is the space containing the displacement field  $\underline{U}$  defined on  $\Omega \times ]0, T[$ , and  $\mathcal{S}^{[0, T]}$  is the space containing the stresses, likewise defined on  $\Omega \times ]0, T[$ . Finally,  $\mathcal{U}_{ad, 0}$  is the vector space of the specified virtual velocities. The operator  $\mathbf{A}$ , which is given and generally single-valued, characterizes the mechanical behavior of the material.

Let us denote by  $\mathcal{U}_{ad}^{[0, T]}$  the space of displacements verifying the kinematic constraints (1).  $\mathcal{S}_{ad}^{[0, T]}$  is the space of stresses which are solutions to the equilibrium equations (2).

Let us start with the simplest family of problems, the elasticity problems. One looks for the final state of the structure at  $t = T$ ; then, the problem to be solved does not depend on the time. Moreover, the constitutive relation (3) becomes:

$$\underline{\sigma} = \mathbf{K} \varepsilon (\underline{U}) \quad (4)$$

where  $\mathbf{K}$  denotes the Hooke's tensor which is symmetric and positive definite. The spaces of admissible displacement and stress are  $\mathcal{U}_{ad}$  and  $\mathcal{S}_{ad}$ .

The densities  $\underline{U}_d, \underline{f}_d, \underline{F}_d$  are known at  $t = T$ .

## 2.2 Principle of Constitutive Relation Errors

Let us consider that the finite element solution has been computed using a displacement approach. The finite element displacement-stress pair  $(\underline{U}_h, \underline{\sigma}_h)$  is then known, the stress  $\underline{\sigma}_h$  being f.e. equilibrated.

The principle behind our approach is to associate a new displacement-stress pair denoted by  $(\hat{\underline{U}}_h, \hat{\underline{\sigma}}_h)$ , which is admissible i.e. belonging to  $\mathcal{U}_{ad} \times \mathcal{S}_{ad}$ , to the data and the finite element displacement-stress pair. This pair verifies the most reliable equations of the reference problem to be solved ; its quality, and thus the quality of the f.e. solution is measured through the residue related to the verification of the constitutive relation. It verifies also what we call the "prolongation conditions" which are relations with the finite element solution.

**Definition of CRE.** The displacement  $\hat{\underline{U}}_h$  is generally taken as  $\underline{U}_h$ . The crucial point is to build a stress  $\hat{\underline{\sigma}}_h$  associated to both  $\underline{\sigma}_h$  and the data, which verifies the equilibrium equations. We will return later to this problem ; let  $(\hat{\underline{U}}_h, \hat{\underline{\sigma}}_h)$  be a displacement-stress pair belonging to  $\mathcal{U}_{ad} \times \mathcal{S}_{ad}$ . The relative constitutive relation error is:

$$\varepsilon^2 = \frac{\|\hat{\underline{\sigma}}_h - \underline{\sigma}(\hat{\underline{U}}_h)\|^2}{\frac{1}{2}(\|\hat{\underline{\sigma}}_h\|^2 + \|\underline{\sigma}(\hat{\underline{U}}_h)\|^2)} \quad (5)$$

where:

$$\|\underline{\sigma}\|^2 = \int_{\Omega} \text{Tr}[\underline{\sigma} \mathbf{K}^{-1} \underline{\sigma}] d\Omega \text{ and } \underline{\sigma}(\hat{\underline{U}}_h) = \mathbf{K} \underline{\varepsilon}(\hat{\underline{U}}_h)$$

Introducing the contribution to the error of the element  $E \in \mathbf{E}$ , one gets:

$$\varepsilon^2 = \sum_{E \in \mathbf{E}} \varepsilon_E^2 \quad (6)$$

It is also possible to introduce a local error :

$$[\varepsilon_{loc}]^2 = \sup_{E \in \mathbf{E}} \left[ \varepsilon_E^2 \frac{\Omega}{\Omega_E} \right]$$

**Stress prolongation conditions for a f.e. displacement approach.** In the standard recovery method, the prolongation condition is the strong one defined by :

$$\begin{aligned} & \forall E \in \mathbf{E} \\ & \forall i \in \mathbf{I} \quad \int_E (\hat{\underline{\sigma}}_h - \underline{\sigma}_h) \underline{\text{grad}} \omega_i d\Omega = 0 \text{ (strong P.C.)} \end{aligned}$$

where  $\omega_i$   $i \in \mathbf{I}$  are the f.e. shape functions.

In a last version, the prolongation condition is weaker :

$$\begin{aligned} & \forall E \in \mathbf{E} \\ & \forall i \in \bar{\mathbf{I}} \subset \mathbf{I} \quad \int_E (\hat{\underline{\sigma}}_h - \underline{\sigma}_h) \underline{\text{grad}} \omega_i d\Omega = 0 \text{ (weak P.C.)} \end{aligned}$$

$\bar{\mathbf{I}}$  is associated with non-vertex nodes.

**Link to the classical error.** The CRE is related to the classical error by the Prager-Synge theorem :

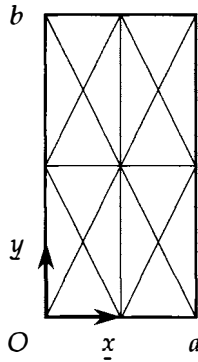
$$\frac{\|\sigma_{\text{ex}} - \sigma_h^*\|^2}{\frac{1}{2} (\|\hat{\sigma}_h\|^2 + \|\sigma(\hat{U}_h)\|^2)} = \frac{\varepsilon^2}{4}$$

where  $\sigma_h^* = \frac{1}{2} \left( \hat{\sigma}_h + \sigma(\hat{U}_h) \right)$  and  $\sigma_{\text{ex}}$  is the exact stress.

### 2.3 Quality of Constitutive Relation Errors

Let us first recall the global effectivity index :  $\frac{\|\hat{\sigma}_h - \sigma_h\|}{\|\sigma_{\text{ex}} - \sigma_h\|}$

**A first comparison for thermal problems.** The results have been derived in (Babuska et al. 1994). They concern a 2D thermal problem solved with a periodic mesh, the shape ratio being  $b/a$  (Figure 2)



**Figure 2.** Cell mesh

Figure 3 shows that the constitutive relation has an excellent behavior for thermal problems.

**Test 1: f.e. calculations with anisotropic mesh.** For the sake of simplicity, the Hooke's tensor is the identity. Two CRE estimators have been compared among themselves and with the ZZ2 error estimator. It is the original ZZ2 introduced in (Zienkiewicz and Zhu 1992) which is the one being implemented.

Effectivity index

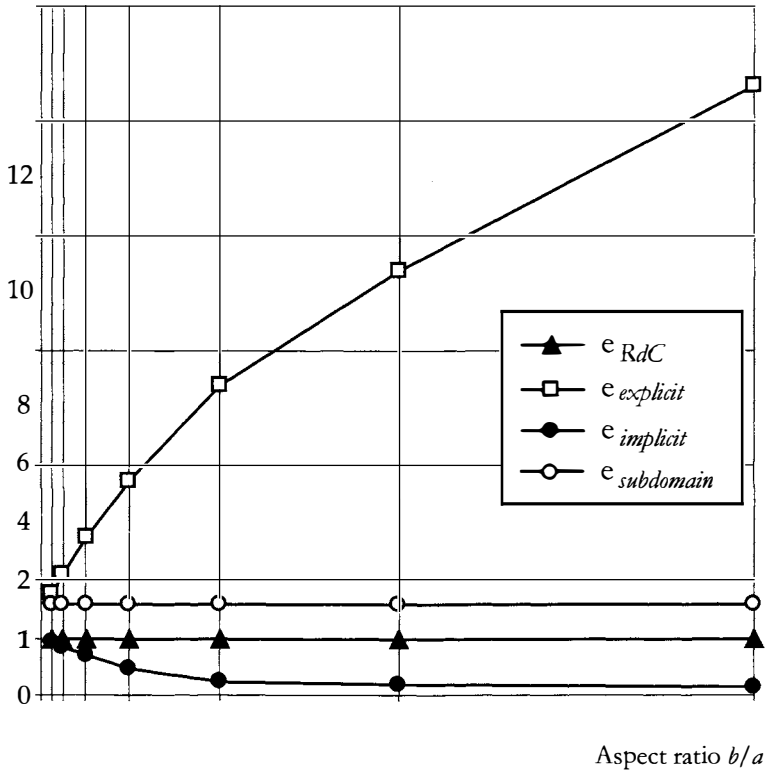


Figure 3. Effectivity indexes for different error estimators (thermal problem)

The initial standard CRE estimator is associated to the strong prolongation condition and a completely explicit recovering technique. The “new” CRE recovering estimator uses a weak prolongation condition and a semi-explicit recovering technique which will be described later.

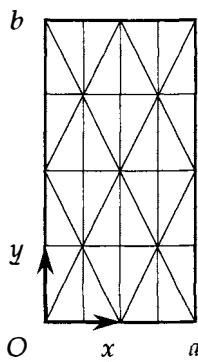
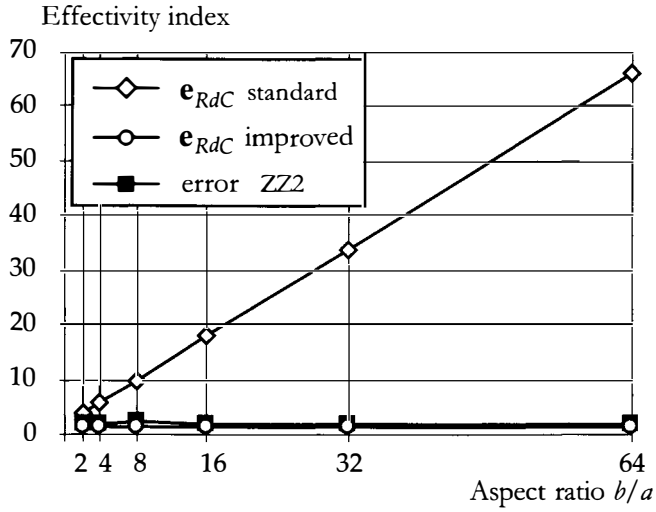


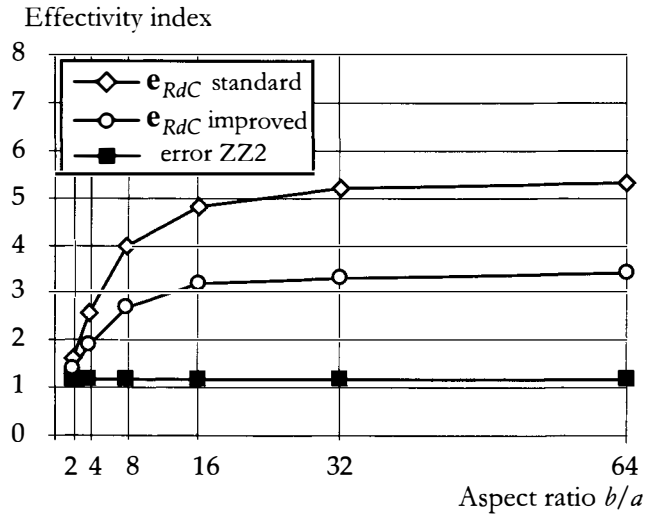
Figure 4. Anisotropic mesh



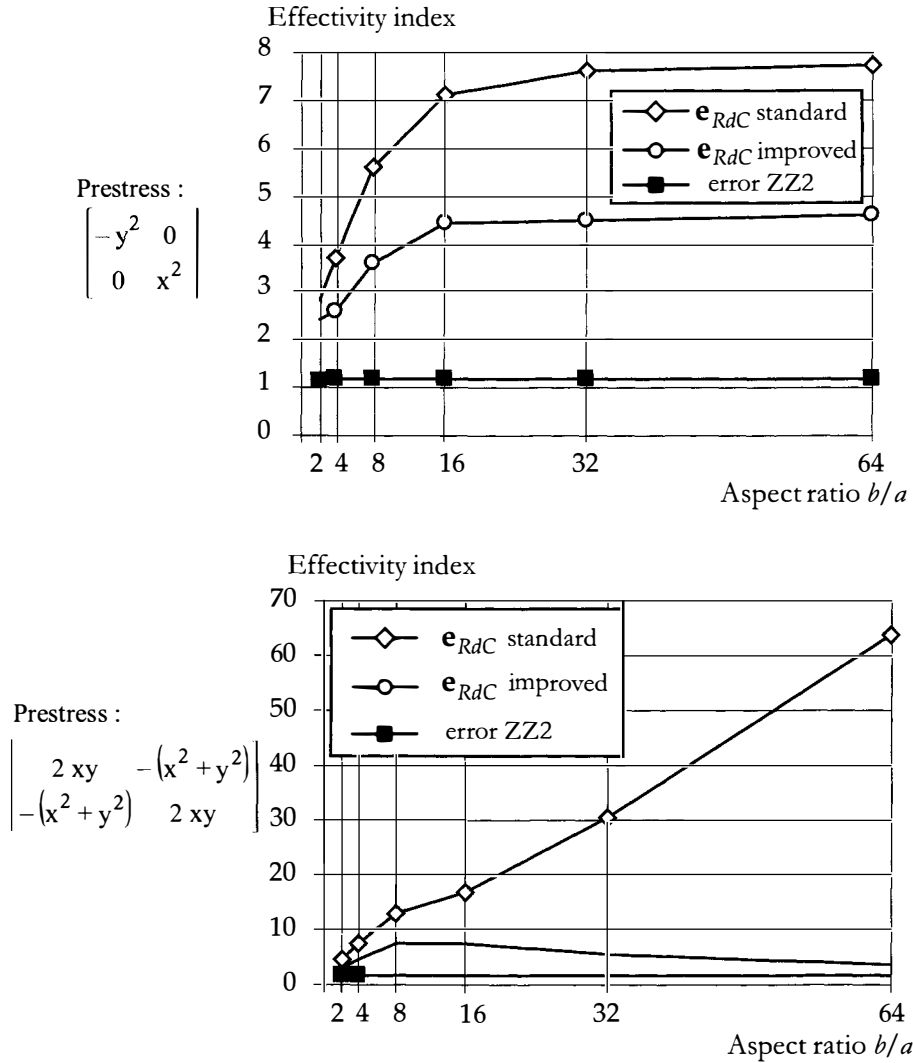
Figure 4 shows the studied structure and its mesh; the shape ratio  $l/H$  is a parameter. Four loadings are considered; they are defined by 2D prestresses which are polynomials of degree 2 and satisfy the interior equilibrium and compatibility equations.



$$\text{Prestress : } \begin{vmatrix} -2xy & y^2 - x^2 \\ y^2 - x^2 & 2xy \end{vmatrix}$$



$$\text{Prestress : } \begin{vmatrix} y^2 - x^2 & 2xy \\ 2xy & x^2 - y^2 \end{vmatrix}$$



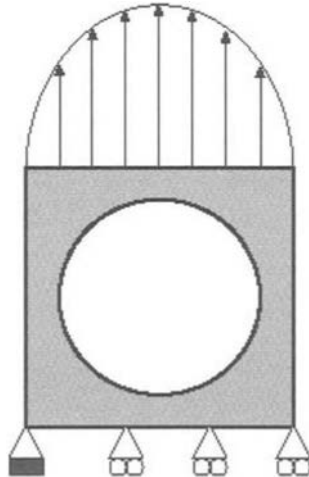
**Figure 5.** Effectivity index versus shape ratio for different error estimators (P2 element)

It appears that the last error estimator is much better than the standard one for large values of the shape ratio. Its behavior is satisfactory. When the ZZ2 error estimator is included in the comparison, the best error estimator becomes the ZZ2 for the three last cases, and they are equivalent for the first one.

A deeper study is given in [Ladevèze and Pelle 2000]. It is proved that with a slight modification, the standard CRE estimator becomes satisfactory for large values of the shape ratio. This modified standard CRE estimator follows an idea of Babuska and Strouboulis which

is to solve numerically the stress recovery problem that one gets on each element. We will come back on this point later.

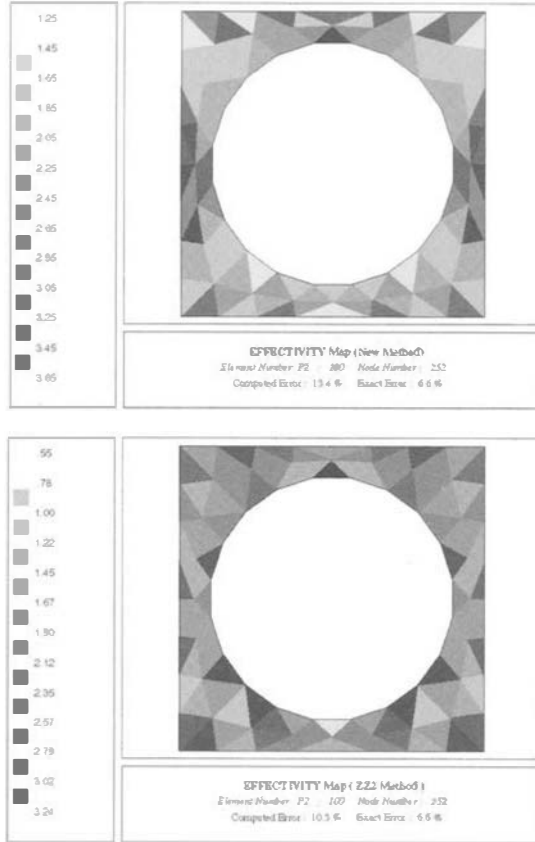
**Test 2: 2D elasticity problems with stiff stress gradient.**



**Figure 6.** Test 2

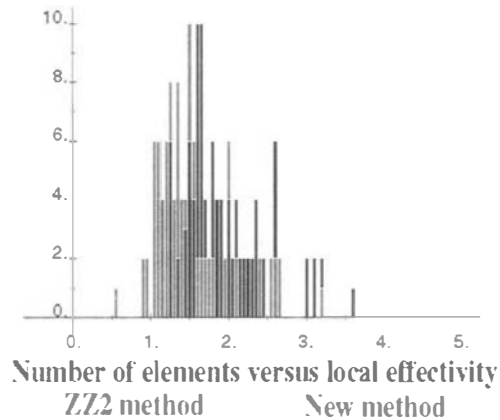
This example is a better representation of the commonly-encountered f.e. problems. Figure 6 displays the reference problem to be solved. Figure 7 gives the local effectivity index maps for the three error estimators. The global effectivities are:

constitutive relation error (standard version)	: 2.6
constitutive relation error (new version)	: 2.0
<i>ZZZ</i>	: 1.6



**Figure 7.** Local effectivity map for different estimators

Figure 8 presents the number of elements versus local element effectivity for two error estimators: ZZ2 and the last version of the error on constitutive relation. It appears, and this is an important point, that the local effectivity indexes are greater than 1. This property has been verified in many other tests; this error concerning stresses is then to be deemed “conservative” locally. Globally, this property is a mathematical result, consequence of the Prager-Syngé theorem.



**Figure 8.** Number of elements versus local element effectivity for both ZZ2 error estimator and the new one

**Remarks.**

- The error estimator ERpB+3 developed by Babuska and Strouboulis coincides with our modified standard CRE estimator for which the stress recovery problem on each element is solved numerically. They have done numerous studies concerning its quality.
- An iterative technique has been introduced recently by (Strouboulis et al. 2000) in order to get guaranteed upper and lower bounds of the error.
- To derive global error estimators is a first necessary step. A further one is to derive error estimators for engineering local quantities such as stresses, displacements, intensity factors... Several methods have recently been proposed; the idea is to approximate numerically an extractor operator which is a kind of Green operator. A general method based on CRE estimators has been proposed in (Ladevèze et al. 1999). For the particular case of stresses, our new CRE estimator seems to be sufficient for getting upper bound of the local error; further studies are in progress. Other works concerning local error estimators can be found in (Rannacher and Suttmeier 1998) (Peraire and Patera 1998) (Oden and Prudhomme 1999) (Ciral and Ramm 1998) (Strouboulis et al. 2000);

**3 A General Method for Recovering Equilibrated Stress from the f.e. Stress and the Data**

Other research works have been carried out in order to recover more or less equilibrated stress: (Ainsworth and Oden 1997) (Bank and Weiser 1985), (Babuska, Strouboulis et al. 1994), (Kelly 1984), (Stein et al. 1998), (Wiberg and Abdulwahab 1992)...

Our recovery method has been introduced in Ladevèze (1975) (1977) and further developed in several papers: Ladevèze and Leguillon (1983), Ladevèze et al. (1986) (1991), Ladevèze and Maunder (1996) (1997). The key is what has been termed: the “prolongation condition”.

### 3.1 Prolongation Conditions

In the standard recovery method, the strong prolongation condition is:

$$\begin{aligned} \forall E \in \mathbf{E} \\ \forall i \in \mathbf{I} \quad \int_E (\hat{\sigma}_h - \sigma_h) \underline{\text{grad}} \omega_i \, d\Omega = 0 \quad (\text{strong P.C}) \end{aligned} \quad (7)$$

$\hat{\sigma}_h$  is the S.A. stress we want to build.  $E$  denotes an arbitrary element and  $(\omega_i; i \in \mathbf{I})$  the f.e. scalar shape functions.  $\mathbf{I}$  is the set of the f.e. nodes.

In the last version, the prolongation condition is weaker:

$$\begin{aligned} \forall E \in \mathbf{E} \\ \forall i \in \bar{\mathbf{I}} \subset \mathbf{I} \quad \int_E (\hat{\sigma}_h - \sigma_h) \underline{\text{grad}} \omega_i \, d\Omega = 0 \quad (\text{weak P.C}) \end{aligned} \quad (8)$$

$\bar{\mathbf{I}}$  is associated with non-vertex nodes.

### 3.2 Main features of the Standard Recovery Method

**Main property.** Let us recall the strong prolongation condition:

$$\begin{aligned} \forall E \in \mathbf{E} \\ \forall i \in \mathbf{I} \quad \int_E (\hat{\sigma}_h - \sigma_h) \underline{\text{grad}} \omega_i \, d\Omega = 0 \end{aligned}$$

which can be written using the Stokes formula and  $\hat{\sigma}_h \in \mathcal{S}_{\text{ad}}$ :

$$\begin{aligned} \forall E \in \mathbf{E} \quad \forall i \in \mathbf{I} \\ \int_{\partial E} \hat{\sigma}_h \underline{n} \omega_i \, dS = - \int_E \underline{f}_d \omega_i \, d\Omega + \int_E \sigma_h \underline{\text{grad}} \omega_i \, d\Omega \end{aligned} \quad (9)$$

This last relation introduces the element tractions on the boundaries of the elements, representing in fact their projections on the shape functions. The element traction due to the environment of element  $E$  is denoted by  $\eta_E \hat{\underline{F}}_h$ , where  $\hat{\underline{F}}_h$  is defined on the element's boundaries.  $\eta_E$  is a scalar function also defined on the element's edges. The edge's set will be denoted  $\Gamma$ .

The  $\eta_E$  function depends on the element  $E$ ; it has on each side a constant value: +1, -1 or 0. Moreover, for two adjacent elements, we prescribe that:  $\eta_E + \eta_{E'} = 1$  on the common edge  $\Gamma_{EE'}$  (Figure 9).

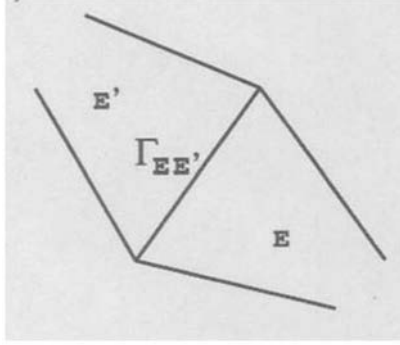


Figure 9. Definition of  $\eta_E$

Taking:

$$\eta_E \hat{F}_{\underline{h}} = \left[ \hat{\mathcal{C}}_h \Big|_{E^-} \underline{n} \right]_{\partial E} \quad (10)$$

the strong prolongation condition then becomes:

$$\int_{\partial E} \eta_E \hat{F}_{\underline{h}} \omega_i \, dS = - \int_E f_{\underline{d}} \omega_i \, d\Omega + \int_E \mathcal{C}_h \underline{\text{grad}} \omega_i \, d\Omega \equiv Q_E(i) \quad (11)$$

Let  $\mathbf{F}_{\text{ad}}$  be the equilibrated element's traction space; these tractions verify the prescribed external loading on  $\partial_2 \Omega$  and the global equilibrium conditions on each element. Let us now present the main property which demonstrates that the prolongation condition is in fact the key.

**Property.** The element tractions  $\hat{F}_{\underline{h}}$  are equilibrated if the following conditions hold:

$$\forall E \in \mathbf{E} \quad \forall i \in \mathbf{I}$$

$$\int_{\partial E} \eta_E \hat{F}_{\underline{h}} \omega_i \, dS = \int_E \mathcal{C}_h \underline{\text{grad}} \omega_i \, d\Omega - \int_E f_{\underline{d}} \omega_i \, d\Omega$$

where:

-  $\eta_E \hat{F}_{\underline{h}}$  verifies the prescribed traction on  $\partial_2 \Omega$ , and

- the rigid body displacements for each element can be expressed in terms of the shape - functions. The proof can be found in (Ladevèze and Leguillon 1983). Let us note that the third condition is practically always satisfied.

**Equilibrated traction recovery.** Several cases should be distinguished:

- *Non-vertex node interior to  $\Omega$ :* Let  $\Gamma_{EE'}$  be a common boundary to adjacent elements E and E'.  $\omega_i$  is the scalar shape function associated with an internal node to  $\Gamma_{EE'}$ . The f.e. equilibrium leads to:

$$\int_E \sigma_h \underline{\text{grad}} \omega_i \, d\Omega + \int_{E'} \sigma_h \underline{\text{grad}} \omega_i \, d\Omega = \int_E \underline{f}_d \omega_i \, d\Omega + \int_{E'} \underline{f}_d \omega_i \, d\Omega \quad (12)$$

and then to:

$$\underline{Q}_E(i) + \underline{Q}_{E'}(i) = 0 \quad (13)$$

Using the prolongation condition, one obtains:

$$\begin{aligned} \int_{\Gamma_{EE'}} \eta_E \hat{\underline{F}}_h \omega_i \, dS &= \underline{Q}_E(i) \\ \int_{\Gamma_{EE'}} \eta_{E'} \hat{\underline{F}}_h \omega_i \, dS &= \underline{Q}_{E'}(i) \end{aligned}$$

It follows that:

$$\int_{\Gamma_{EE'}} \hat{\underline{F}}_h \omega_i \, dS = \eta_E \underline{Q}_E(i) = \eta_{E'} \underline{Q}_{E'}(i) \quad (14)$$

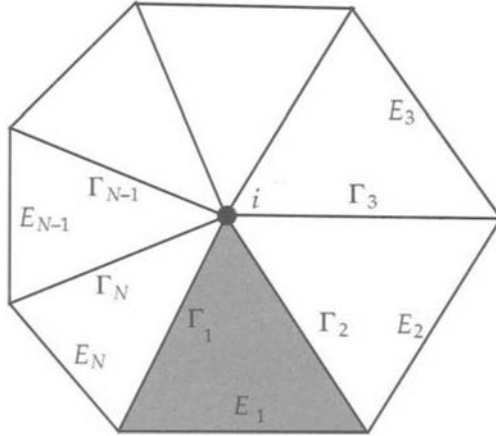
- *Vertex interior to  $\Omega$ :* Figure 10 specifies the notations. Let:

$$\underline{b}_j = \int_{\Gamma_j} \eta_{E_j} \hat{\underline{F}}_h \omega_i \, dS \quad (15)$$

The prolongation condition, written for the elements connected to vertex i, leads to the reduced linear system:



$$\begin{cases} \underline{b}_1 - \underline{b}_2 = \underline{Q}_{E_1}(i) \\ \underline{b}_2 - \underline{b}_3 = \underline{Q}_{E_2}(i) \\ \dots \\ \underline{b}_n - \underline{b}_1 = \underline{Q}_{E_n}(i) \end{cases} \quad (16)$$



**Figure 10.** Projection on a vertex

This system admits a solution if the sum of the second members is equal to zero:

$$\sum_{i=1}^n \underline{Q}_{E_j}(i) = 0 \quad (17)$$

$\omega_h$  verifies the f.e. equilibrium; it follows that condition (17) holds. However, the linear system (16) admits an infinite number of solutions. Among them, we choose the one which minimizes:

$$(\underline{b}_1, \dots, \underline{b}_n) \rightarrow \sum_{j=1}^n \frac{(\underline{b}_j - \underline{b}_j^m)^2}{p_j^2} \quad (18)$$

where:

- $\underline{b}_j^m$  is an average computed with the f.e. stress vectors for two adjacent elements  $E_j, E_{j-1}$  having a common edge  $\Gamma_j$ .
  - $p_j$  is a weight ( $p_j^2 = L_j^2$ ;  $L_j$ : length of  $\Gamma_j$ ).
- *Other cases:* The treatment of all other cases is very similar to that for the previous ones.

Remarks:

- The cost function (18) does not have a strong mechanical interpretation.
- Several variants concerning traction recovery can be easily introduced (see (Ladevèze and Maunder 1996, 1997)).
- 

To recover element tractions from their projections on the shape functions, the process is straightforward.

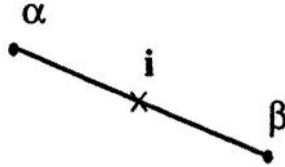


Figure 11. Element boundary  $\Gamma$

One supposes that the element traction on  $\Gamma$  is a linear combination of the restrictions on  $\Gamma$  of the shape functions (figure 11).

$$\hat{\underline{F}}_h|_{\Gamma} = \underline{A}_{\alpha} \omega_{\alpha}|_{\Gamma} + \underline{A}_{\beta} \omega_{\beta}|_{\Gamma} + \sum_{i \in \bar{i}} \underline{A}_i \omega_i|_{\Gamma} \quad (19)$$

**Equilibrated stress recovery.** This work is to be performed element-by-element. For the element  $E$ , Figure 12 specifies the problem to be solved.

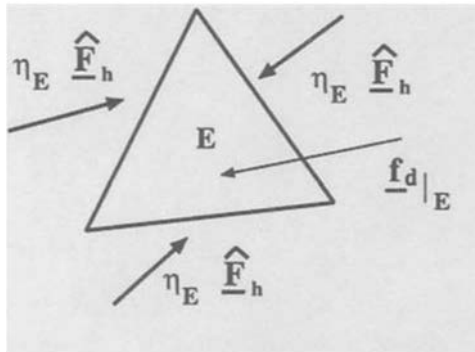


Figure 12. Equilibrated element stress recovery

Several techniques have been developed in order to derive  $\hat{\sigma}_h|_E$  explicitly. At the present time, we prefer to use numerical techniques involving high order elements; generally we use one element of degree  $p+3$ ,  $p$  being the element degree of the displacement approach. Such a modified standard error estimator coincides with ERpB+3 estimator of Babuska and Strouboulis.

### 3.3 Main Features of the New Version

Let us recall the weak prolongation condition:

$$\forall E \in \mathbf{E} \quad \forall i \in \bar{\mathbf{I}} \subset \mathbf{I} \quad \int_E (\hat{\mathcal{C}}_h - \mathcal{C}_h) \underline{\text{grad}} \omega_i \, d\Omega = 0 \quad (20)$$

$\bar{\mathbf{I}}$  does not contain any vertices.

**Equilibrated traction recovery.** The element traction projections are completely defined for the shape functions  $\omega_i$  with  $\omega_i|_i \in \mathbf{I}$ . Following the method used previously, it results that the element traction on  $\Gamma$  (see Figure 11) can be written:

$$\hat{\underline{F}}_h|_\Gamma = \underline{A}_\alpha \omega_\alpha|_\Gamma + \underline{A}_\beta \omega_\beta|_\Gamma + \sum_{i \in \bar{\mathbf{I}}} \underline{A}_i \omega_i|_\Gamma$$

where:

- the high-degree part  $\sum_{i \in \bar{\mathbf{I}}} \underline{A}_i \omega_i|_\Gamma$  is completely defined. If necessary, additional prolongation conditions are introduced.
- $\underline{A}_\alpha, \underline{A}_\beta$  are parameters.

Let  $\underline{A}$  be the column formed with all  $\underline{A}_\alpha, \underline{A}_\beta$ ; the corresponding space is  $\mathbf{A}$ .  $\hat{\underline{F}}_h$  has to be admissible ( $\hat{\underline{F}}_h \in \mathbf{F}_{\text{ad}}$ ); then,  $\underline{A}$  has to belong to a certain subspace of  $\mathbf{A}$  denoted by  $\mathbf{A}_{\text{ad}}$ .

**Equilibrated stress recovery.** For fixed  $\underline{A} \in \mathbf{A}_{\text{ad}}$ ,  $\hat{\mathcal{C}}_h$  is built as in the previous fashion element-by-element.

**Optimal value for  $\underline{A}$ .** The best value of  $\underline{A}$  is defined by the following minimization problem:

$$\underline{A}_{\mathbf{A}_{\text{ad}}} \rightarrow J_2(\underline{A}) = \frac{1}{2} \underline{A}^t \mathbb{H} \underline{A} - \underline{Z}^t \underline{A}$$

$J_2(\underline{A})$  is the complementary potential energy. The matrix  $\mathbb{H}$  and the second member  $\underline{Z}$  can be built up element-by-element. More details can be found in Ladevèze and Rougeot (1997).

**Practical method.** Let us recall that  $\underline{A}$  has been defined on the set of element boundaries, denoted by  $\Gamma$ . For "smooth" zones of  $\Omega$ , we take the values given by the standard recovery method for the components of  $\underline{A}$  associated with the boundaries. "Non-smooth" zones are those zones located around corner points, deformed elements,... For such zones, better values for the corresponding components of  $\underline{A}$  are computed. In particular,  $\underline{A}$  can be split into:

$$\begin{bmatrix} \tilde{\underline{A}} \\ \tilde{\underline{A}}_0 \end{bmatrix}$$

where  $\tilde{\underline{A}}$  (resp.  $\tilde{\underline{A}}_0$ ) is related to the non-smooth zones (resp. smooth zones).

Using the conjugate gradient technique, and with some iterations, one then minimizes:

$$\begin{bmatrix} \tilde{\underline{A}} \\ \tilde{\underline{A}}_0 \end{bmatrix} \rightarrow J_2 \left( \begin{bmatrix} \tilde{\underline{A}} \\ \tilde{\underline{A}}_0 \end{bmatrix} \right)$$

$$\mathbf{A}_{ad} \rightarrow \mathbf{R}$$

The initial value for  $\tilde{\underline{A}}$  is the one given by the standard recovery method. This practical method is driven by the following quality indicator:

$$\underline{r} = \|\underline{A}_0 - \underline{Z}\| \quad (21)$$

where  $\underline{A}_0$  is the value given by the standard recovery method.

## 4. Adaptivity and Optimal Mesh for Steep Gradient Elasticity Problems

### 4.1 Influence of the Regions with Steep Gradients

To give a mesh with a criterion of prescribed error, one must know the convergence rate  $q$  of the error  $\epsilon$  as a function of the element size  $h$ :

$$\epsilon = O(h^q)$$

Theoretical results show that for smooth problems the convergence rate  $q$  depends only on the type of element used:

$$q = p$$

with, for example:

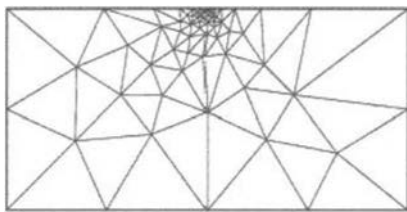
- $p = 1$  for 3-node elements
- $p = 2$  for 6-node elements.

Figure 13 shows the results obtained on a cracked plate, meshed with 6-node elements. For the optimization, we impose on each element  $q = 2$ . We notice that the prescribed error (2%) is not achieved; therefore, the mesh is not optimal.

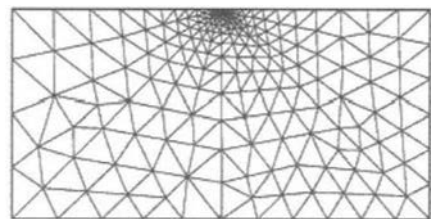
For this example, the error does not converge with the degree of the shape functions. In fact, when steep gradient regions appear in the structure (singularities, for instance), the convergence rate  $q$  is determined by the following formula (Ciarlet 1978) (Azziz and Babuska 1972):

$$q = \min(\alpha, p)$$

where  $\alpha$  is the strength of the singularity (local solution such as  $u = r^\alpha f(\theta)$ ) and  $p$  the degree of the shape functions. If we impose  $q = \alpha = 1/2$  (strength of the singularity in crack tip:  $1/2$ ), we obtain a mesh with 53.907 elements. Without making the finite element analysis, which is too expensive, it is evident that this mesh is not optimal.



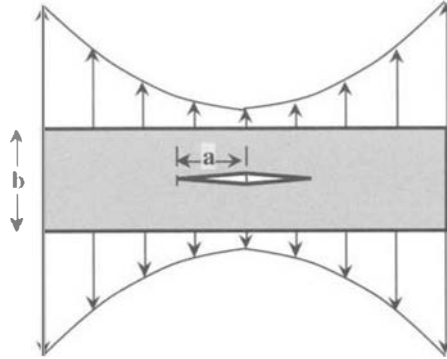
*Initial mesh*  
124 6 node elements  
273 nodes  $\epsilon = 11,34 \%$



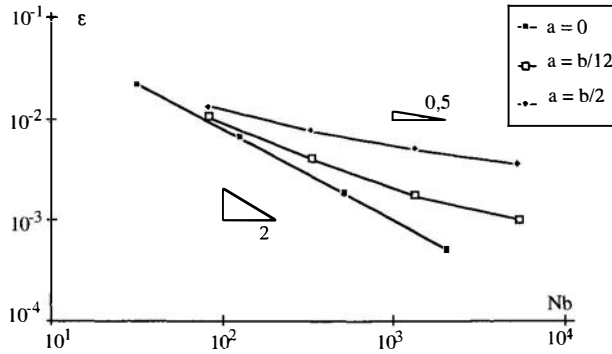
*Optimized mesh*  
448 6 node elements  
953 nodes  $\epsilon = 4,2 \%$

**Figure 13.** Optimization without taking into account steep gradients (prescribed error : 2%)

The explanation is that theoretical results have been demonstrated only for  $h$  tending to 0, so this behavior is asymptotic. We consider a cracked plate of width  $4b$  and of height  $b$  loaded in mode I with a parabolic effort (Figure 14). When we change the length  $a$  of the crack, one notices a different evolution of the error as a function of the number of elements (Figure 15). For  $a = 0$ , the problem of a plate without crack loaded in traction, the convergence rate is about 1.8, a value close to 2 which is the theoretical rate of the 6-node triangular element. On the other hand, for  $a = b/12$ , the convergence rate varies from 1.33 to 0.79 and for  $a = b/2$  from 0.85 to 0.52, a value near  $\alpha$  which is only obtained asymptotically when  $h$  is very small.



**Figure 14.** Cracked plate with a parabolic given traction



**Figure 15.** Error versus number of elements for different lengths of crack

#### 4.2 Calculation of the Convergence Coefficient Density

The definition and the calculation method are given in (Coorevits et al. 1992). To illustrate it, let us consider the case of the cracked plate.

The computation of the convergence coefficients requires two steps:

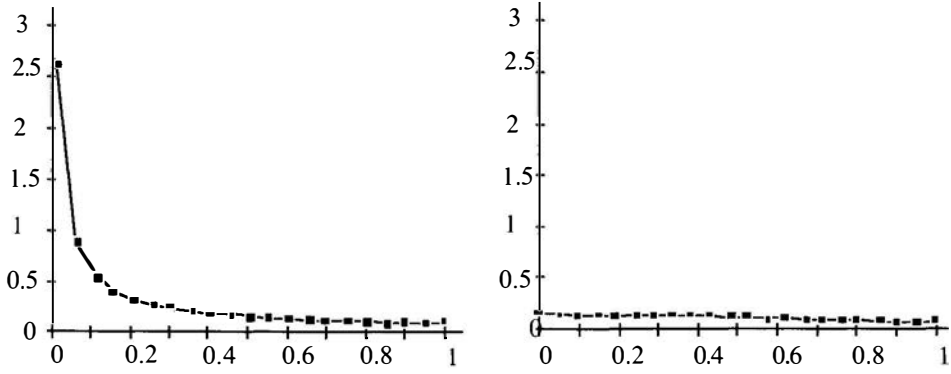
- detection of the singularities and, more generally, of the steep gradient regions ;
- computation of the convergence coefficients  $p_E$  in these regions.

The computation of the local error indicator  $\bar{\epsilon}_E$  defined by:

$$\bar{\epsilon}_E^2 = \frac{|\Omega|}{|E|} \epsilon_E^2 \quad (22)$$

(where  $\epsilon_E$  denotes the contribution to the relative error,  $|E|$  the area of the element,  $|\Omega|$  the area of the structure) allows the detection of the steep gradient regions. Indeed, we notice that the local errors are larger in these areas (Figure 16) than in the interior. Therefore, a

comparison of this quantity with an *average error* identifies regions where the coefficient  $P_E$  must be computed.

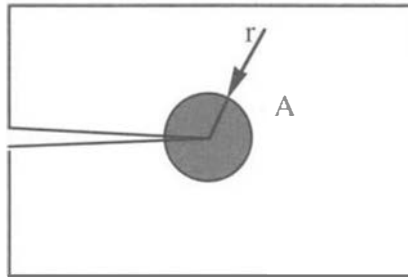


**Figure 16.** Local error at the crack tip and at an interior node in the  $X_1$ -direction

To illustrate the method, let us consider the case of a cracked plate. To compute  $P_E$ , we use the energy density  $\bar{e}_h$  defined at every node by:

$$\bar{e}_h(r) = \frac{1}{|A|} \int_A \text{Tr} \left[ \sigma_h \mathbf{K}^{-1} \sigma_h \right] \frac{dA}{2}$$

where  $|A|$  denotes the measure of the area of the radius  $r$  (figure 17).

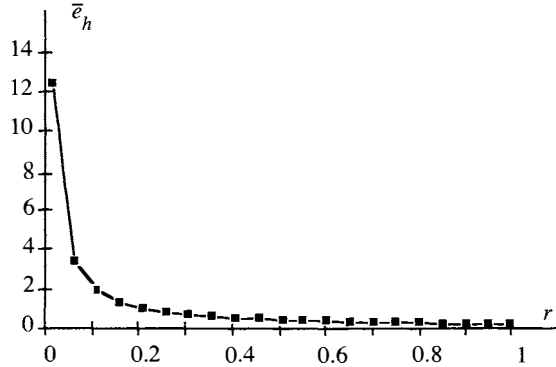


**Figure 17.** Area  $A$  of radius  $r$  at the crack tip

Figure 18 shows this energy density  $\bar{e}_h$  as a function of the distance  $r$  from the crack tip. The theoretical energy density  $e$  can be written as:

$$e(r) = k r^{2(\alpha-1)} + c \tag{23}$$

where  $k$  and  $c$  denote constants depending on the mechanical problem, and  $\alpha$  the strength of the singularity, since the singular part of the displacement solution is  $u = r^\alpha \underline{f}(\theta)$ . The identification of the theoretical expression of  $e$  with the computed energy density  $e_h$  by the least square method gives a coefficient  $\bar{\alpha}$  close to the theoretical value  $\alpha$ . In the case of the crack, we obtain  $\bar{\alpha} = 0.52$  ( $\alpha = 0.5$ ).



**Figure 18.** Energy density  $e_h$  as a function of the distance  $r$  from the crack tip

For the elements in the singularity region, we impose  $p_E = \bar{\alpha}$  ; for the other elements of the structure  $p_E = p$  .

In practice, this method of identification allows us to account for not only the singularities but also the steep gradients which are not singularities. In addition, we find that the steep gradients are at the edge of the structure. The computation is made only for the nodes close to the boundary and consequently needs very little CPU time.

### 4.3 Optimal Mesh: Definition and Calculation

Let us consider that a first finite element analysis has lead to the global error  $\epsilon$  and the element contributions  $\epsilon_E$  .

**Definition.** A mesh  $T^*$  is named optimal if the corresponding global error  $\epsilon^*$  is equal to the error  $\epsilon_0$  prescribed by the user and if its number of elements  $N^*$  is minimum.

This definition introduced by Pelle can be found in (Ladevèze, Coffignal and Pelle 1986). It improves the previous one developed in (Ladevèze and Leguillon 1981, 1983) which is still classically used and for which the local contributions  $\epsilon_E^*$  are prescribed  $E^*$  uniform.

**Calculation.** Since the topology of the optimal mesh  $T^*$  is better described by a map of nodal sizes, the problem of optimization will be written as a function of those. In addition, the meshes are isotropic (for example, the ideal element is the equilateral triangle), but the elements may have rapidly varying size. The mesher, therefore, respects the prescribed surface at every node of an element  $E$  of the initial mesh  $T$ , and generates a regular distribution of the



new elements of the mesh  $\mathcal{T}^*$  inside the element  $E$ . The size for an isotropic mesh depends on the square root of the area, so we assume a linear distribution of the square of the sizes. The number of elements  $N_E^*$  can be estimated by:

$$N_E^* = \frac{1}{|E|} \int_E \frac{h_E^2}{\sum_{i=1}^3 h_i^{*2} \lambda_i} dE \quad (24)$$

and the contribution  $\epsilon_E^*$  of an element to the global error by:

$$\epsilon_E^* = \frac{1}{|E|} \int_E \frac{\left( \sum_{i=1}^3 h_i^{*2} \lambda_i \right)^{p_E}}{h_E^{2p}} \epsilon_E^2 dE \quad (25)$$

where  $|E|$  denotes the surface of the element,  $h_E$  its size,  $p_E$  its computed convergence coefficient,  $h_i^*$  the desired sizes at the three nodes of the element  $E$  and  $\lambda_i$  the barycentric coordinates. Consequently we have to solve the following problem:

$$\text{Minimize } N^* = \sum_E N_E^* \text{ with } \sum_E \epsilon_E^{*2} = \epsilon_0^2$$

This problem of optimization is solved using Lagrange multipliers; the conditions of optimality are numerically solved with an iterative process.

The control of optimality is crucial in judging the efficiency of the method. In some cases, the prescribed accuracy can be obtained without a minimum number of elements. The control is obtained by the following method: on the optimized mesh if the computed error  $\epsilon^*$  is near the prescribed error  $\epsilon_0$ , we recompute the size map for an imposed error equal to  $\epsilon^*$ . If the mesh  $\mathcal{T}^*$  is perfectly optimal, the size modification coefficient  $r_E$ , defined by:

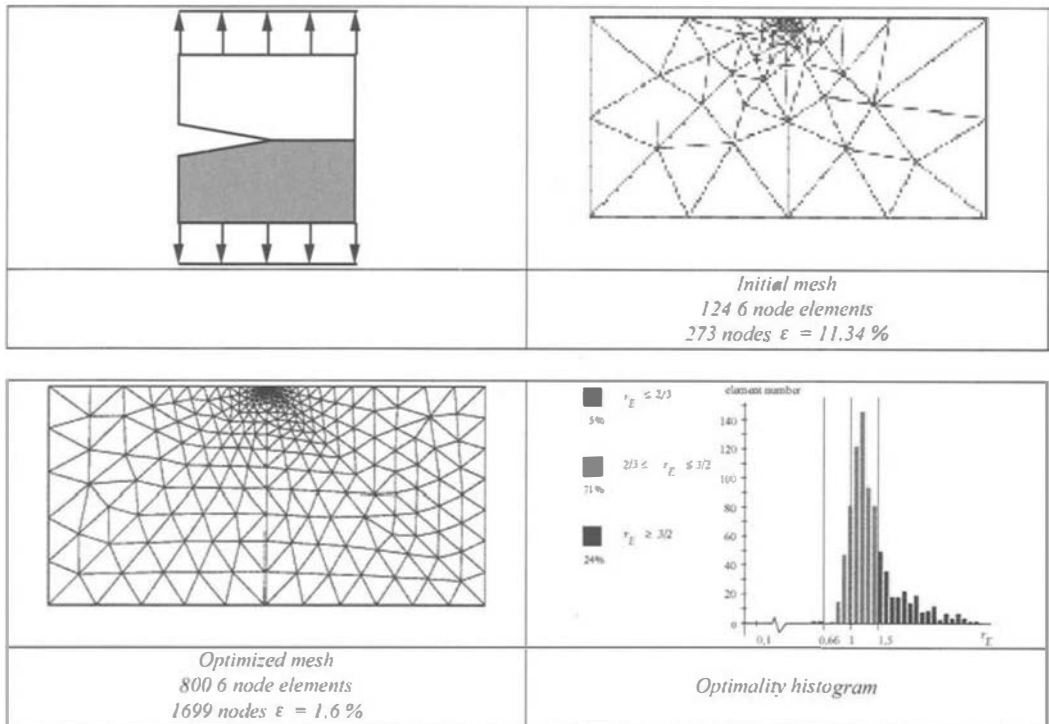
$$r_E = \frac{\frac{1}{3} \sum_{i=1}^3 h_i^*}{h_E} \quad (26)$$

must be equal to 1. The map of these coefficients allows us to appreciate the quality of the obtained meshes.

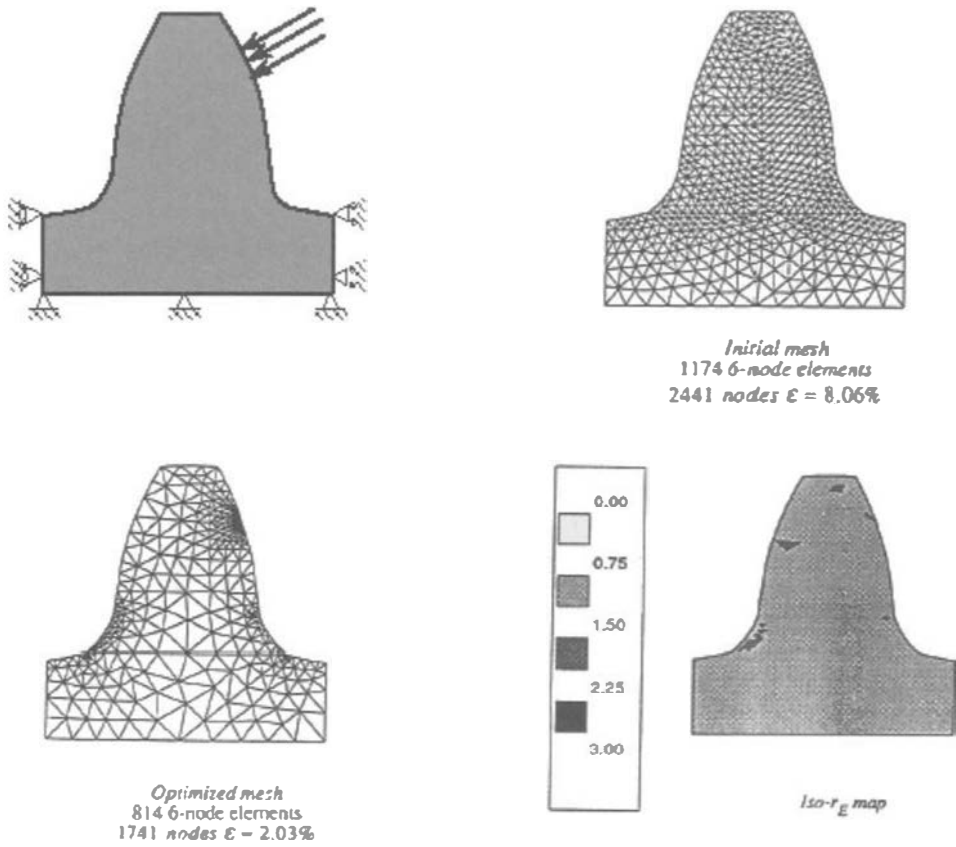
*Remark :* If the first mesh is too coarse, several intermediate meshes could be needed.

#### 4.4 2D Examples

Quite a lot of examples have been done in (Ladevèze and Leguillon 1981, 1983) (Ladevèze, Coffignal and Pelle 1986) (Ladevèze, Pelle and Rougeot 1991) (Coorevits et al. 1992) (Coorevits, Dumeau and Pelle 1997). Two of them are shown here: the cracked plate and the gear tooth.



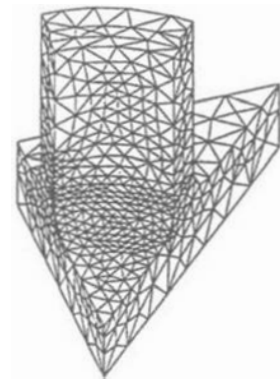
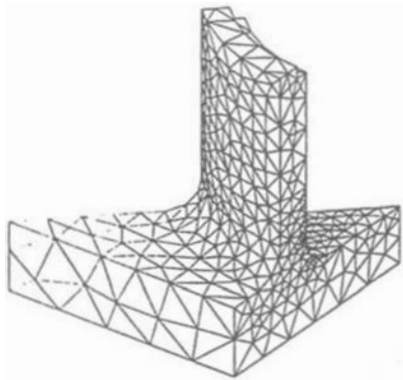
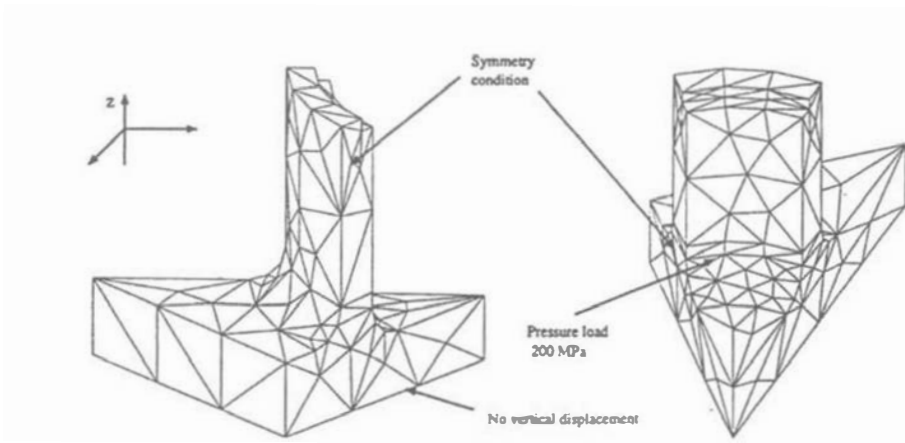
**Figure 19.** Cracked plate - prescribed error  $\epsilon_0 = 2\%$



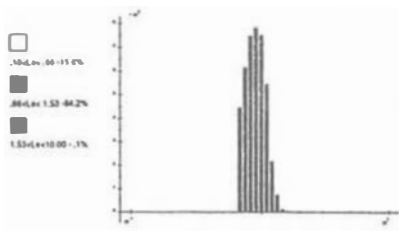
**Figure 20. Gear tooth - prescribed error  $\epsilon_0 = 2\%$**

#### 4.5 3D Examples

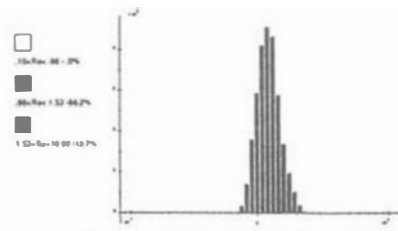
Several 3D mesh adaptations are done in (Coorevits, Dumeau and Pelle 1996, 1997). Here is shown a structure meshed with 10-nodes tetrahedra. The prescribed error is 7%.



Optimised mesh - 5,008 elements - 8,012 nodes -  $\epsilon=6.97\%$



Coefficient of size respect



Coefficient of size modification

Figure 21. 3D mesh adaptation - prescribed error : 7%

#### 4.6 Remarks

Other examples can be found in (Ladevèze and Pelle 2000). Extension of CRE estimators to plate elements has been done in (Ladevèze 1975) (Boisse and Coffignal 1998) (Boisse et al. 1999).

### 5. Constitutive Relation Errors for f.e. Analysis Considering (Visco)Plasticity and Damage - Adaptivity

A posteriori error estimators based on constitutive relation residuals are developed to measure the quality of finite element computations of structures which exhibit plastic / viscoplastic behavior with softening. All the classical error sources involved in the computation over the studied time interval are taken into account: the space discretization (the mesh), the time discretization and the iterative technique used to solve the nonlinear discrete problem.

Concerning nonlinear problems, it is important to distinguish between time-dependent and time-independent problems. For the late type, let us mention Babuska and Rheinboldt (1982) for the design of estimates for nonlinear elasticity problems of rods, Johnson and Hansbo (1991) for Hencky-type plasticity problems, and Verfurth (1996) for the proof of bounds on the error. For nonlinear time-dependent problems, plasticity and viscoplasticity problems were treated in (Bass and Oden 1987) (Rannacher and Suttmeier 1998) (Boroomand and Zienkiewicz 1998), strain localization in (Wunderlich et al. 1998) (Aubry et al. 1992) (Peric et al. 1994) (Pijaudier-Cabot et al. 1995) and large strains in (Bussy et al. 1985) (Fourment and Chenot 1995) (Brink and Stein 1998). Most of the proposed error estimators for time-dependent nonlinear problems are simply error estimators devised for usual linear or nonlinear problems and applied at each time step. Thus, the error due to the time discretization can not be taken into account. At the present time, only the constitutive relation error estimators are able to take into account all sources of error.

For plasticity and viscoplasticity problems without softening, two kinds of error estimators - named "Drucker error estimator" and "dissipation error estimator" - have been respectively introduced in (Ladevèze, Coffignal and Pelle 1986) (Gallimard, Ladevèze and Pelle 1996) and in (Ladevèze and Moes 1998, 1999). It is important to note that for the dissipation constitutive relation error estimator, a link with the "solution error" similar to the Prager-Synge theorem has been proved (Ladevèze 1999).

An extended damage model coupled with plasticity and viscoplasticity is investigated for the dissipation constitutive relation error estimator. A first attempt is given in (Ladevèze, Moes and Douchin 1999). New error estimators are introduced; they are based on the convexity properties of the state equations and of the state evolution laws. Numerical examples are shown.

#### 5.1 The Drucker CRE Estimator

Let us come back to the time-dependent problem defined by the equations (1), (2) (3).

The densities  $\underline{U}_d$ ,  $\underline{f}_d$  and  $\underline{F}_d$  are known on  $[0, T]$ . We also consider that the finite element solution has been computed using a displacement approach. The finite element displacement-stress pair  $(\underline{U}_h, \underline{\sigma}_h)$  is then known at the time value  $t_m$  with  $m \in [0, 1, \dots, n]$ . Supposing that

the data are piecewise linear on  $[0, T]$ , it is easy to extend the f.e. solution on  $[0, T]$ . Let us also denote it by  $(\underline{U}_h, \underline{\sigma}_h)$ . Several f.e. stresses are available ; here, the stress  $\underline{\sigma}_h$  is f.e. equilibrated on  $[0, T]$ .

The principle behind our approach is to associate a new displacement-stress pair denoted by  $(\hat{\underline{U}}_h, \hat{\underline{\sigma}}_h)$ , which is admissible i.e. belonging to  $\mathcal{U}_{ad}^{[0, T]} \times \mathcal{S}_{ad}^{[0, T]}$ , to the data and the finite element displacement-stress pair. This pair verifies the most reliable equations of the reference problem to be solved ; its quality, and thus the quality of the f.e. solution, is measured through the residue related to the verification of the constitutive relation on  $[0, T]$ .

The displacement  $\hat{\underline{U}}_h$  is generally taken as  $\underline{U}_h$  on  $[0, T]$ . The crucial point is always to build a stress  $\hat{\underline{\sigma}}_h$  which verifies the equilibrium equations on  $[0, T]$ . The recovery method described previously is still used for any time value  $t_m$  with  $m \in [0, 1, \dots, n]$ .  $\hat{\underline{\sigma}}_h$  is taken piecewise linear on  $[0, T]$ . Let  $(\hat{\underline{U}}_h, \hat{\underline{\sigma}}_h)$  be a displacement-stress pair belonging to  $\mathcal{U}_{ad}^{[0, T]} \times \mathcal{S}_{ad}^{[0, T]}$ .

For materials satisfying Drucker's stability inequality, a constitutive relation error has been introduced in (Ladevèze 1985) and associated error estimators in (Ladevèze et al. 1986) and (Gallimard et al. 1996). A broad class of plasticity and viscoplasticity models enter into this category. Let us assume that this inequality is satisfied; denoting  $(\hat{\underline{U}}_h, \hat{\underline{\sigma}}_h)$  by  $(\underline{U}_{KA}, \underline{\sigma}_{SA})$ , we can associate to it, by using the constitutive relation, a stress  $\underline{\sigma}_{KA}$  and a strain  $\underline{\varepsilon}_{KA}$ , defined on  $\Omega \times [0, T]$ . Then, the following is derived:

$$\eta(\underline{M}, t) = \int_0^t dt \operatorname{Tr} [(\underline{\sigma}_{SA} - \underline{\sigma}_{KA})(\dot{\underline{\varepsilon}}_{SA} - \dot{\underline{\varepsilon}}_{KA})] \quad (27)$$

The main results are:

- $\eta$  is positive or null on  $\Omega \times [0, T]$ ,
- $(\underline{U}_{KA}, \underline{\sigma}_{KA})$  is the exact solution on  $\Omega \times [0, T]$  if and only if  $\eta$  is equal to zero on  $\Omega \times [0, T]$ .

The global error on constitutive relation at T is then:

$$\varepsilon_T = \left[ \sup_{t \in [0, T]} \int_{\Omega} \eta(\underline{M}, t) d\Omega \right]^{1/2} / D \quad (28)$$

$$D^2 = \frac{1}{2} \int_0^T \int_{\Omega} dt d\Omega [\operatorname{Tr} [\underline{\sigma}_{KA} \dot{\underline{\varepsilon}}_{KA}] + \operatorname{Tr} [\underline{\sigma}_{SA} \dot{\underline{\varepsilon}}_{SA}]]$$

This includes all sources of error: space discretization, time discretization, etc. A local error can also be introduced:

$$\varepsilon_{T,loc} = \sup_{\substack{t \in ]0, T[ \\ \underline{M} \in \Omega}} \left[ \eta(\underline{M}, t) \text{mes} \Omega \right]^{1/2} / D \quad (29)$$

*Remark* : Most applications which have been done, have used the standard recovery method; this method does not depend on the constitutive relation. Some works in progress use the weak prolongation condition; a minimization procedure is then introduced. For example, one minimizes at any time  $t_m$ ,  $m \in [1, 2 \dots, n]$  the free energy written in term of stresses (Gallimard et al. 2000).

## 5.2 The Dissipation CRE Estimator

This kind of error has been introduced in (Ladevèze 1989) and detailed in (Ladevèze 1999). Associated error estimators are described in (Ladevèze and Moës 1998, 1999).

The reference problem to be solved is reformulated introducing the internal variables framework. Then, the state of the material at the point  $\underline{M}$  and at the time  $t$  is defined by the inelastic strain  $\varepsilon_p$  and additional internal variables denoted by  $\mathbf{X}$  (hardening variables, damage variables, ...). The force associated to  $\mathbf{X}$  is denoted by  $\mathbf{Y}$ . Therefore, one is looking for  $s \equiv (\underline{U}, \dot{\varepsilon}_p, \dot{\mathbf{X}}, \sigma, \mathbf{Y})$  defined on the time-space domain  $]0, T[ \times \Omega$ , the corresponding space being  $\mathbf{S}^{]0, T[}$ .

Moreover, equations are divided into two groups :

- The first group - related to the free energy - defines the *admissibility* of a solution. It combines the equilibrium equations, the kinematic constraints and the state equations. The corresponding subspace is  $\mathbf{S}_{ad}^{]0, T[}$ .

$$\begin{aligned} \bullet \underline{U} &\in \mathcal{Z}_{ad}^{]0, T[} & \sigma &\in \mathbf{S}_{ad}^{]0, T[} \\ \bullet \sigma &= \mathbf{K}(\varepsilon(\underline{U}) - \varepsilon_p) & \mathbf{Y} &= \Lambda \mathbf{X} \quad (\text{on } \Omega \times ]0, T[) \end{aligned} \quad (30)$$

- The second group - related to the dissipation - only includes the evolution laws. The quality of an admissible solution will be estimated through the quality of satisfaction of these laws.

$$\begin{pmatrix} \dot{\varepsilon}_p \\ -\dot{\mathbf{X}} \end{pmatrix} = \mathbf{B} \begin{pmatrix} \sigma \\ \mathbf{Y} \end{pmatrix} \quad \mathbf{X}|_{t=0} = 0 \quad (31)$$

The operators  $\Lambda$  and  $\mathbf{B}$  characterize the material. It is not restrictive to suppose that the material model is normal i.e. the operator  $\Lambda$  is linear (Ladevèze 1999).

Following the recovery technique used in the case of the Drucker error, one associates to the finite element solution and the data an admissible solution  $\hat{s}_h$  ( $\hat{s}_h \in \mathbf{S}_{ad}^{]0, T[}$ ). The only equations which are not a priori satisfied by  $\hat{s}_h$  are the evolution laws. The practical definition

of such an error depends on the form of the evolution laws. Most materials can be described by standard models; in this case, the dissipation error for any admissible solution  $\hat{s}$  is:

$$\eta(\hat{s})_{t, \underline{M}} \equiv \varphi(\hat{\mathbb{E}}_p, -\hat{\mathbf{X}}) + \varphi^*(\hat{\mathbb{C}}, \hat{\mathbf{Y}}) - \text{Tr}[\hat{\mathbb{C}} \hat{\mathbb{E}}_p] + \hat{\mathbf{Y}}^t \hat{\mathbf{X}} \quad (32)$$

where  $\varphi, \varphi^*$  are a couple of convex dual functions, named potentials of the evolution laws.

The main results are:

- $\eta$  is positive or null on  $\Omega \times [0, T]$
- $\hat{s}$  is the exact solution on  $\Omega \times [0, T]$  if and only if  $\eta$  is equal to zero on  $\Omega \times [0, T]$ .

The global dissipation error at time T is then:

$$\varepsilon_T \equiv \frac{\int_0^T \int_{\Omega} dt d\Omega \eta(\hat{s})}{D^2} \quad (33)$$

with:

$$D^2 \equiv 4 \sup_{t \in [0, T]} \left[ \frac{1}{2} \int_0^t \int_{\Omega} dt d\Omega [\varphi(\hat{\mathbb{E}}_p, -\hat{\mathbf{X}}) + \varphi^*(\hat{\mathbb{C}}, \hat{\mathbf{Y}})] + \frac{1}{2} \int_{\Omega} (\text{Tr}[\mathbf{K}^{-1} \hat{\mathbb{C}} \hat{\mathbb{C}}] + (\mathbf{\Lambda}^{-1} \hat{\mathbf{Y}})^t \circ \hat{\mathbf{Y}})_t d\Omega \right]$$

The implementation of the errors for the f.e. method is easy. Let us consider the classical incremental finite element method. The problem to be solved on  $[0, T]$  is divided into a succession of resolutions over  $[t_n, t_{n+1}]$  ( $n = 0, \dots, N$ ;  $t_0 = 0, t_{N+1} = T$ ). For the sake of simplicity, displacements, stresses prescribed forces and displacements are supposed to be time-continuous and piecewise linear within the subintervals. It follows that the recovery of an equilibrated stress over  $[0, T]$  can be done easily supposing also it is piecewise linear: the recovery method proposed in elasticity is applied at the time-step  $t_n$ .

Applied to the recovered  $\hat{s}_h$ , one obtains the value  $\varepsilon_{hT}$  of the dissipation error. A remarkable property of such an error is its link with the error between the exact and the admissible solutions which has been established in (Ladevèze 1999). This property is an extension of the famous Prager-Synge theorem valid in elasticity.

Several examples are detailed in (Ladevèze and Moës 1998, 1999).

Specific error indicators have been also introduced in (Ladevèze and Moës [1998, 1999]; they characterize:

- the space discretization:  $i_{\text{spce}}$ ,
- the time discretization:  $i_{\text{time}}$ ,
- the iteration stopping:  $i_{\text{ite}}$ .

*Remark.*

Extensions to non standard material can be easily done using the concept of bipotential introduced by de Saxcé (1992). CRE estimators using this formalism have been developed by Hjjaj (1999).



### 5.3 Extension of the Dissipation CRE Estimator to (Visco-)Plasticity and Damage

For the sake of simplicity, let us consider first elasticity coupled to isotropic damage.

**Elasticity coupled to isotropic damage.** One has :

$$\begin{aligned}\varpi &= (1 - d) \mathbf{K}_0 \varepsilon \quad 0 \leq d \leq 1 \\ Y &= \frac{1}{2} \text{Tr} \left[ \mathbf{K}_0 \varepsilon \varepsilon \right] \\ \dot{d} &= h' \left( \langle Y - Y_0 - \omega(d) \rangle_+ \right)\end{aligned}\tag{34}$$

where  $h'(0) = 0$ ,  $\omega(0) = 0$ ;  $h'(x) \geq 0$ ,  $\omega'(x) \geq 0$ ,  $\forall x \geq 0$ .

The scalar  $d$  is the damage variable whose value must stay between 0 (non-damaged material) and 1 (completely damaged material).  $\mathbf{K}_0$  is the elastic stiffness of the non-damaged material. It is a positive definite symmetric tensor. The evolution of  $d$  is driven by the strain energy  $Y$  through the positive material function  $h'$ . The damage may only grow (irreversible phenomena). The material parameter  $Y_0$  is the threshold under which  $d$  may not grow. As the damage proceeds, this threshold rises through the scalar material function  $\omega(\cdot)$  which introduces a "hardening" effect. Characterizing the "hardening" effect by the additional internal variable  $\alpha$  and denoting its associate variable by  $\beta$ , we may rewrite an equivalent form in which we distinguish the state laws:

$$\begin{aligned}\varpi &= (1 - d) \mathbf{K}_0 \varepsilon \quad 0 \leq d \leq 1 \\ Y &= \frac{1}{2} \text{Tr} \left[ \mathbf{K}_0 \varepsilon \varepsilon \right] \\ \beta &= \omega(\alpha)\end{aligned}\tag{35}$$

from the evolution laws:

$$\begin{aligned}\dot{d} &= h' \left( \langle Y - Y_0 - \beta \rangle_+ \right) \\ \dot{\alpha} &= -h \left( \langle Y - Y_0 - \beta \rangle_+ \right)\end{aligned}$$

and the initial conditions :  $d = \alpha = 0$  at  $t = 0$ .

Two bilinear forms are then introduced. First, a work bilinear form is introduced for describing the state laws:

$$\left( \varepsilon, Y, \beta, \varpi, d, \alpha \right) \rightarrow \text{Tr} \left[ \varpi \varepsilon \right] + Yd + \beta\alpha\tag{36}$$

We have proved in (Ladevèze, Moës and Douchin 1999) that the state laws can be defined through two dual potentials,  $\Psi(\varpi, d, \alpha)$  and  $\Psi^*(\varepsilon, Y, \beta)$ , which are convex functions. This result is not trivial. If the state laws are not verified, the constitutive relation residual is:

$$\eta_{\Psi}(\mathbb{E}, Y, \beta; \varpi, d, \alpha) = \Psi(\varpi, d, \alpha) + \Psi^*(\mathbb{E}, Y, \beta) - \text{Tr}[\varpi \mathbb{E}] - Yd - \beta\alpha \geq 0 \quad (37)$$

For the evolution laws, the dissipation bilinear form is used :

$$([\dot{d}, -\dot{\alpha}]; [Y, \beta]) \rightarrow Y\dot{d} - \beta\dot{\alpha}$$

Here, too, the evolution laws can be defined by two convex dual potentials,  $\varphi^*(Y, \beta)$  and  $\varphi(\dot{d}, -\dot{\alpha})$ ; the corresponding constitutive relation residual is:

$$\eta_{\varphi}(\dot{d}, -\dot{\alpha}, Y, \beta) = \varphi(\dot{d}, -\dot{\alpha}) + \varphi^*(Y, \beta) - Y\dot{d} + \beta\dot{\alpha} \geq 0 \quad (38)$$

A solution  $s \equiv (\mathbb{E}, Y, \beta, \varpi, d, \alpha)$  is called admissible on  $\Omega \times [0, T]$  if it verifies the equilibrium equations and the kinematic constraints. To be exact, it has to verify the state laws and the evolution laws too ; the value of the following constitutive relation residual must be zero:

$$e_t^2(s) \quad t \in [0, T] \quad (39)$$

with :

$$\bullet e_t = \sup_{0 \leq \tau \leq t} e_{\tau}$$

$$\bullet e_t(s) = \int_{\Omega} \eta_{\Psi}(\mathbb{E}, Y, \beta; \varpi, d, \alpha)|_t \, d\Omega + \int_0^t dt \int_{\Omega} \eta_{\varphi}(\dot{d}, -\dot{\alpha}; Y, \beta) \, d\Omega$$

The relative global error is:

$$\varepsilon_T^2(s) = \frac{e_{[0, T]}^2(s)}{\sup_{t \in (0, T)} d_t^2} \quad (40)$$

$$d_t^2 \equiv \int_{\Omega} [\varphi(\mathbb{E}, Y, \beta) + \varphi^*(\varpi, d, \alpha)]_t \, d\Omega + \int_0^t dt \int_{\Omega} \varphi(\dot{d}, -\dot{\alpha}) + \varphi^*(Y, \beta) \, d\Omega$$

*Remark:*

In the case of anisotropic damage, the damage needs to be expressed in a more complex manner than with a scalar  $d$ , for instance by a  $n$ -vector  $\underline{d}$ . Two dual convex potentials can be still introduced for defining the state laws if :

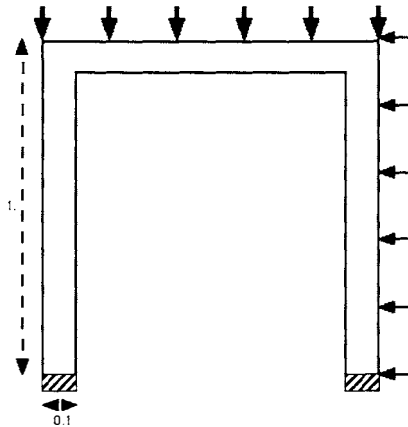
- $\underline{d} \rightarrow \mathbf{K}(\underline{d})$  is a linear function
  - $\mathbf{K}(0)$  is a positive definite operator.
- The proof is given in Ladevèze et al. (1999).

### Extension to (visco)-plasticity coupled to damage

(Visco)-plastic state laws and evolution laws have to be introduced. A posteriori error estimators are constructed following the previous approach which supposes two types of convexity. Let us note that bipotentials can be also used for describing both the state laws and evolution laws (De Saxcé 1992).

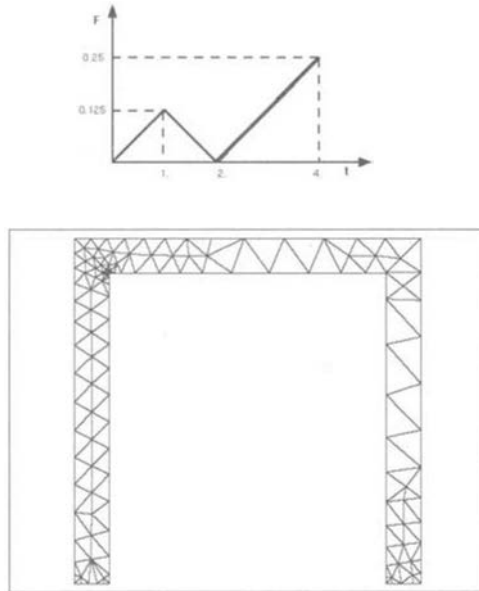
#### 5.4 Error Estimation and Adaptivity for (Visco)-Plastic Structures without Softening

Several experiments concerning both the Drucker error and the dissipation error have been done. Only, one example is reported here: the frame problem (Ladevèze and Moes 1998).



**Figure 22.** The geometry and applied loading on the frame

The frame, figure 22, is submitted to a growing then decreasing load on its right side (thin line in figure 23). Then, an increasing pressure is applied to its upper part (thick line in figure 23). The Prandtl-Reuss plastic model with linear hardening is considered. The optimized mesh in elasticity for an error of 10% is given figure 23. It is composed of 194 six-node triangular elements. Three time steps are used and the tolerance for the iterative technique is set to  $\delta_{\text{tol}} = 10^{-2}$ . The errors obtained are 28.15% for the dissipation error and 26.90% for the Drucker error.



**Figure 23.** Evolution of the loading and initial mesh optimized in elasticity, 194 six-nodes triangles

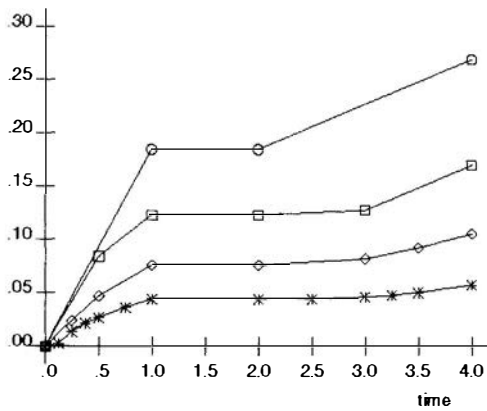
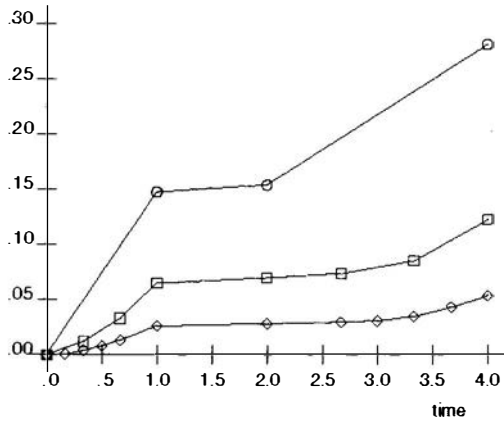
Adaptive procedures have been implemented for optimizing both the time discretization and the mesh discretization. For an asked accuracy of  $5 \cdot 10^{-2}$ , figures 24 and 25 give the final meshes. Figure 26 shows the evolutions of the two errors for the successive adaptive steps.



**Figure 24.** Final mesh optimized with the dissipation error, 661 six-node triangles, 11 time steps



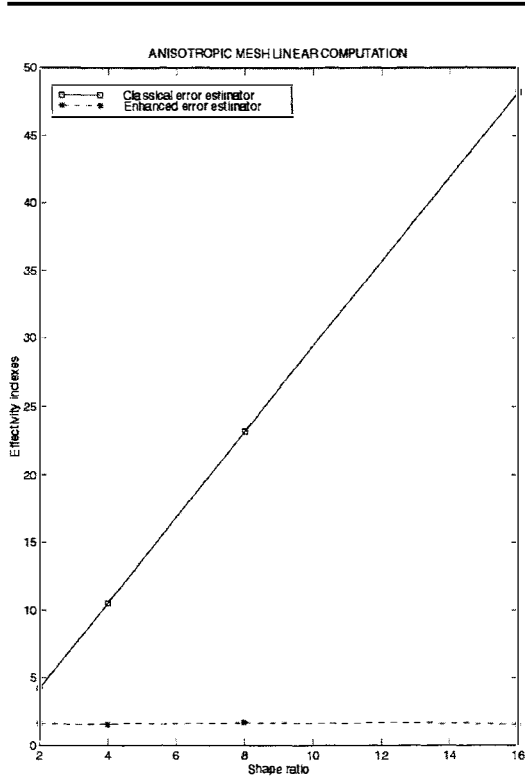
**Figure 25.** Final mesh optimized with Drucker error, 1286 six-node triangles, 12 time steps



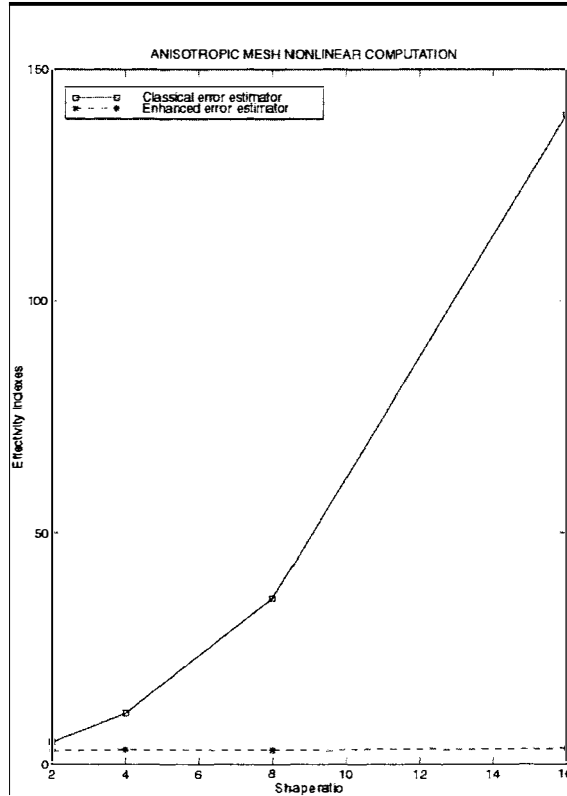
**Figure 26.** Time evolution of the error for the successive adaptive steps - the dissipation error on the top and the Drucker error on the bottom

### 5.5 Enhanced Drucker Error Estimator for (Visco)-Plasticity without Softening

The weak prolongation condition is introduced. The corresponding effectivity index is much better for quasi-perfect plasticity and for deformed element. The example developed in (Gallimard et al. 2000) is used ; the mesh can be seen figure 4 where  $1/H$  is the shape ratio. The loading is increasing; the studied prestress is the first one. Figures 27 and 28 give the effectivity indexes for standard error estimators and the enhanced one as a function of the shape ratio.



**Figure 27.** Effectivity index in elasticity versus shape ratio, for the classical and enhanced error estimators



**Figure 28.** Effectivity index in elastoplasticity versus shape ratio, for the classical and enhanced error estimator

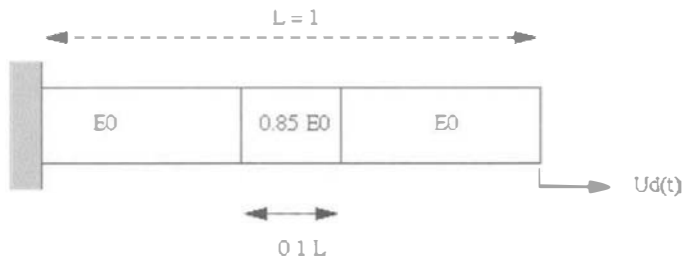
### 5.6 First Numerical Experiments for (Visco)-Plastic Structures with Softening

We consider a beam with a flaw shown figure 29, fixed on its left end and submitted to a growing displacement on its right end described figure 30. The length of the beam is 1 (dimensionless treatment of the problem). The behavior of the beam material is elastoplastic coupled to isotropic damage and follows equations (34). In fact, the initial yield stress  $R_0$  is chosen high enough to avoid plasticity. The state laws and the evolution laws derive from the potentials given in (37)-(38). The material parameters are:

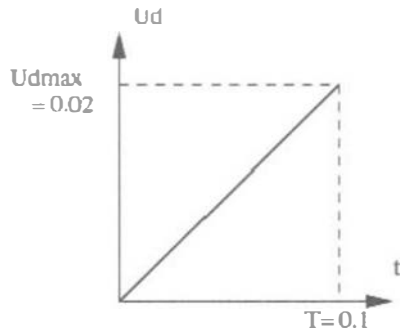
$$E_0 = 6350, \quad Y_0 = 0, \quad Y_c = 0.13, \quad k = 7000, \quad a = 1, \quad R_0 = 1000, \quad k_y = 22582, \quad m = 1$$

where  $E_0$  is the Young's modulus of the non damaged material.

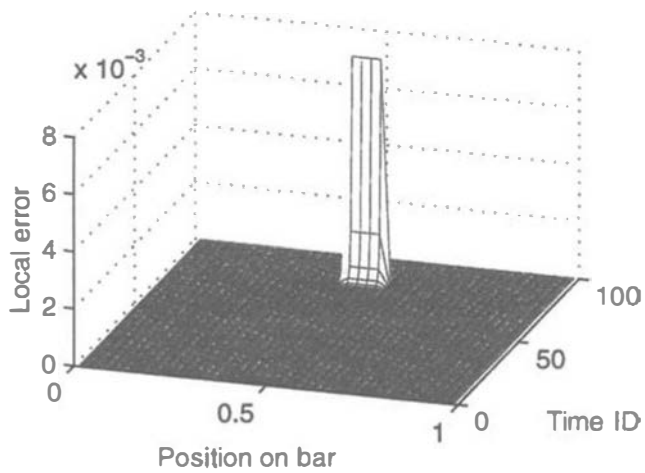
Figure 33 gives the evolution of the damage for a computation carried out with 100 time steps and a uniform mesh of 50 elements. A strong localization of the damage in the flaw region occurs as soon as  $d$  reaches 0.5.



**Figure 29.** Geometry and loading for the beam problem

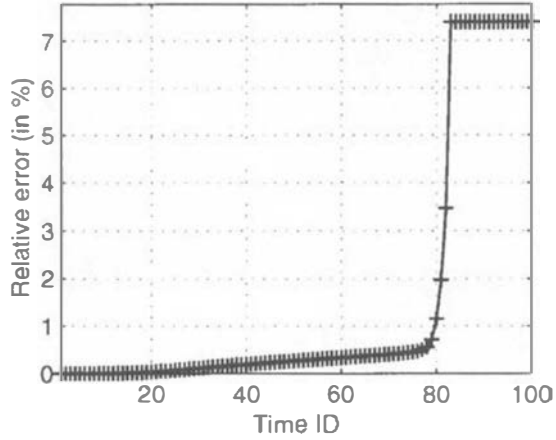


**Figure 30.** Evolution of the loading on the beam as a function of time



**Figure 31.** Local contributions to the error





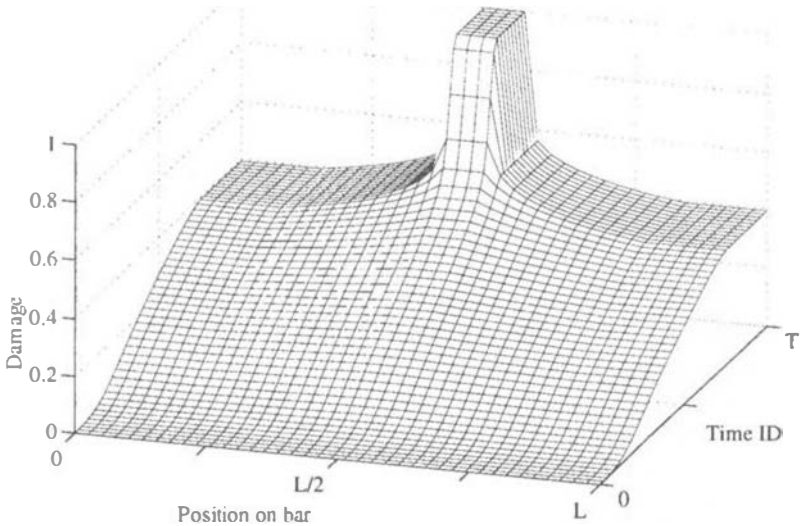
**Figure 32.** Contribution to the relative error through time

Figure 31 shows the space-time map of the local contributions to the error defined in (40). We note that the error is localized in the vicinity of the rupture. The evolution of the contribution to the relative error through time is given figure 32.

Table 1 shows the influence of the numerical parameters on the error.

**Table 1.** Influence of the numerical parameters on the error

nb steps	50	100	200	400	800	1600	3200	6400
error (%)	8,37	7,53	5,64	3,26	1,76	1,00	0,49	0,25



**Figure 33.** Damage scalar variable  $d$  as a function of time and space location on the bar

## 6 Constitutive Relation Error for f.e. Dynamic Analysis

Chapters 6 and 7 deal with a central and crucial question for structural dynamic models which, in fact, concerns the whole Mechanics. Three kinds of models can be distinguished: the continuum mechanics model, the numerical model and experimental simulations. Two categories of quality control can be differentiated.

First, one can study the situation where the reference is the continuum mechanics model, the approximated model being the numerical one. This situation is the usual one for which quite a lot of a posteriori error estimators have been derived. For dynamic problems, the main difficulty lies in building error estimators which maintain a satisfactory effectivity for problems encountered in practice. This difficulty has been previously highlighted in the literature, in particular in (Bouillard and Ihlenburg 1999). The error estimator described herein, is based on a recovering technique which gives an equilibrated displacement, stress and acceleration triplet; it fully takes advantage of the properties of the either explicit or implicit integration scheme used (Combe, Ladevèze and Pelle 1999).

The second situation is apparently only quite different, the approximated and reference models being respectively the continuum mechanics model and the experimental data. Error estimators can be built as extension to a posteriori error estimators quantifying the quality of a f.e. model with respect to the continua one. This is the line that we have been following for nearly 15 years leading to specific constitutive relation error estimators. More common are other works which enter into two categories. The first consists of the “direct” method (Berman and Nagy 1983) and (Kaouk and Zimmerman 1994). The model is corrected without really taking into account either the geometrical or mechanical characteristics of the structure. The second category encompasses “indirect” methods, which are also called sensitivity methods (Farhat and Hemez 1993). The model is corrected by acting on the structural parameters, such as the Young’s modulus, density, section etc. Most of the previous methods are particular cases of regularization techniques evoked in (Natke 1991, 1994).

For both situations the common stone introduced in this chapter is the concept of CRE in dynamics.

### 6.1 The Reference Problem to Be Solved

Let us consider again the problem defined by equations (1) (2) (3) with some modifications. At the initial time  $t = 0$ , the initial position is  $\underline{U}_0$  and the initial velocity  $\underline{V}_0$ . The quantity

$\rho \frac{d^2 \underline{U}}{dt^2}$  where  $\rho$  is the density is introduced as a full unknown, denoted by  $\underline{\Gamma}$ . The problem can

be written as follows:

Find  $\underline{U}(\underline{M}, t)$ ,  $\underline{\sigma}(\underline{M}, t)$ ,  $\underline{\Gamma}(\underline{M}, t)$  defined over  $\Omega \times ]0, T[$  such that they verify:

- Kinematics constraints and initial conditions :

$$\underline{U} \in \mathcal{U}^{[0, T]}, \underline{U} \Big|_{\partial_1 \Omega} = \underline{U}_d \text{ on } ]0, T[ \quad (41)$$

$$\underline{U}\Big|_{t=0} = \underline{U}_0, \quad \frac{d\underline{U}}{dt}\Big|_{t=0} = \underline{V}_0$$

- Equilibrium equations :

$$\underline{\sigma} \in \underline{S}^{[0, T]} \quad \underline{\Gamma}_d \in \underline{\gamma}^{[0, T]}$$

$$\forall \underline{U}^* \in \underline{u}_{ad, 0}$$

$$\forall t \in ]0, T[ \int_{\Omega} \underline{\Gamma} \circ \underline{U}^* d\Omega = - \int_{\Omega} \text{Tr} \left[ \underline{\sigma} \underline{\mathbb{E}}(\underline{U}^*) \right] d\Omega + \int_{\Omega} \underline{f}_d \circ \underline{U}^* d\Omega + \int_{\Omega} \underline{F}_d \circ \underline{U}^* \circ ds \quad (42)$$

- Constitutive relations :

$$\begin{aligned} \forall t \in ]0, T[ \quad \forall t \underline{M} \in \Omega \\ \underline{\sigma}\Big|_t = \mathbf{A} \left( \underline{\mathbb{E}} \left( \underline{\dot{U}}\Big|_{\tau} \right), \tau \leq t \right) \end{aligned} \quad (43)$$

$$\underline{\Gamma}\Big|_t = \rho \ddot{\underline{U}}\Big|_t \quad (44)$$

The use of  $\underline{\Gamma} = \rho \ddot{\underline{U}}$  as a constitutive relation, makes it possible to consider the acceleration quantity  $\underline{\Gamma}$  as being independent of the displacement field  $\underline{U}$ , and the link is recreated by this constitutive relation. The advantage of such an approach is to clearly separate the kinematic quantity  $\underline{U}$ , which satisfies the kinematic constraints and the initial conditions, from the dynamic fields  $(\underline{\sigma}, \underline{\Gamma})$  which satisfy the equilibrium equation.

## 6.2 Constitutive Relation Error Estimators

**Admissible quantities.** The notion of constitutive relation error is based on a partition of the reference problem's equations into two groups:

- kinematic constraints, initial conditions and equilibrium equation
- constitutive relations

*Definition:* A triplet  $s_{Ad} = (\underline{U}_{KA}, \underline{\sigma}_{DA}, \underline{\Gamma}_{DA})$  is admissible if:

- $\underline{U}_{KA}$  satisfies the kinematic constraints and the initial conditions (41), and
- $(\underline{\sigma}_{DA}, \underline{\Gamma}_{DA})$  satisfy the equilibrium equation (42).

The quality of  $s_{Ad}$  as an approximate solution to the reference problem can be assessed by the way in which the constitutive relations (43) and (44) are satisfied.

**The Drucker CRE estimator.** Given an admissible solution  $s_{Ad} = (\underline{U}_{KA}, \underline{\sigma}_{DA}, \underline{\Gamma}_{DA})$ , to the “kinematically-admissible” field  $\underline{U}_{KA}$ , the constitutive relations enable associating a stress field  $\underline{\sigma}_{KA}$  such that:

$$\underline{\sigma}_{KA} \Big|_t = \mathbf{A} \left( \underline{\dot{U}}_{KA} \Big|_\tau, \tau \in [0, t] \right) \quad \forall t \in [0, T] \quad (45)$$

along with an acceleration quantity field  $\underline{\Gamma}_{KA}$  such that:

$$\underline{\Gamma}_{KA} = \rho \underline{\ddot{U}}_{KA}$$

With respect to the “dynamically-admissible” fields  $(\underline{\sigma}_{DA}, \underline{\Gamma}_{DA})$ , the inverse constitutive relations also allow associating a strain field  $\underline{\dot{\varepsilon}}_{DA}$  such that:

$$\underline{\sigma}_{DA}(t) = \mathbf{A} \left( \underline{\dot{\varepsilon}}_{DA} \Big|_\tau, \tau \in [0, t] \right) \quad \forall t \in [0, T] \quad (46)$$

and a displacement field  $\underline{U}_{DA}$  such that:

$$\underline{\ddot{U}}_{DA} = \frac{1}{\rho} \underline{\Gamma}_{DA} \quad \underline{U}_{DA} \Big|_{t=0} = \underline{U}_0 \quad \underline{\dot{U}}_{DA} \Big|_{t=0} = \underline{V}_0$$

The extended Drucker residue is:

$$\eta(t, s_{Ad}) = \gamma \int_0^t (\underline{\Gamma}_{DA} - \underline{\Gamma}_{KA}) (\underline{\dot{U}}_{DA} - \underline{\dot{U}}_{KA}) d\Omega d\tau + (1-\gamma) \int_0^t \text{Tr}[(\underline{\sigma}_{DA} - \underline{\sigma}_{KA}) (\underline{\dot{\varepsilon}}_{DA} - \underline{\dot{\varepsilon}}(\underline{U}_{KA}))] d\Omega d\tau \quad (47)$$

where  $\gamma$  is a parameter ( $0 \leq \gamma \leq 1$ ) which enables balancing the two terms of  $\eta$ . A typical value is:  $\gamma = 0.5$ .

It is supposed that the material model verifies the Drucker’s stability conditions. Then, we have :

$$\begin{aligned} & \bullet \forall t \in [0, T] \quad \eta(t, s_{Ad}) \geq 0 \\ & \bullet \forall \underline{M} \in \Omega \\ & \bullet \{ \eta(t, s_{Ad}) = 0 \text{ on } \Omega \times [0, T] \} \Leftrightarrow \{ s_{Ad} : \text{exact solution} \} \end{aligned} \quad (48)$$

The global Drucker CRE estimator is defined by:

$$\varepsilon = \left| \sup_{t \in [0, T]} \int_{\Omega} \eta(t, s_{Ad}) d\Omega \right|^{1/2} / D \quad (49)$$

with:

$$D^2 = \sup_{t \in [0, T]} \int_0^t \int_{\Omega} dt d\Omega \left[ \gamma (\underline{\Gamma}_{DA} + \underline{\Gamma}_{KA}) \circ (\dot{\underline{U}}_{DA} + \dot{\underline{U}}_{KA}) + (1 - \gamma) \text{Tr}[(\mathbb{C}_{DA} + \mathbb{C}_{KA})(\dot{\underline{\varepsilon}}_{DA} + \dot{\underline{\varepsilon}}_{KA})] \right]$$

For elastic materials, one gets:

$$\eta(t, s_{Ad}) = \frac{\gamma}{2} \rho (\dot{\underline{U}}_{DA} - \dot{\underline{U}}_{KA})^2 \Big|_t + \frac{(1 - \gamma)}{2} \text{Tr}[(\underline{\varepsilon}_{DA} - \underline{\varepsilon}(\underline{U}_{KA})) \mathbf{K} (\underline{\varepsilon}_{DA} - \underline{\varepsilon}(\underline{U}_{KA}))] \Big|_t \quad (50)$$

In this case,  $\eta$  is interpreted as the distance between the KA and DA fields in terms of both the strain energy and the kinematic energy.

*Remarks:*

- If the admissible fields have also to satisfy  $\underline{\Gamma}_{DA} = \underline{\Gamma}_{CA} = \rho \ddot{\underline{U}}_{CA}$ , the error in the constitutive relation used in (Coorevits et al. 1992) is then found again.
- Let the exact solution be  $s_{ex} = (\underline{U}_{Ex}, \mathbb{C}_{Ex}, \underline{\Gamma}_{Ex})$ . The effectivity index is calculated considering that the “exact” error is:

$$\left| \sup_{t \in [0, T]} \int_{\Omega} \bar{\eta}(s_{Ex}, s_{Ad}) d\Omega \right|^{1/2} \quad (51)$$

with  $\bar{\eta}(s_{Ex}, s_{Ad}) = \frac{1}{2} \left[ \eta(t, \underline{U}_{Ex}, \mathbb{C}_{DA}, \underline{\Gamma}_{DA}) + \eta(t, \underline{U}_{KA}, \mathbb{C}_{Ex}, \underline{\Gamma}_{Ex}) \right]$ ,  $\eta$  being defined by (47).

**Recovery of an admissible  $\hat{s}_h$  from the data and the f.e. solution.** Generally speaking, practical approximations apply a finite element choice as well as a time integration scheme: the explicit central differences method, the implicit Newmark scheme, ...

The data are supposed to be piecewise linear over  $[0, T]$ ; therefore it is easy to recover  $\hat{s}_h$  over  $[0, T]$  from its values at the time  $t_n$   $n = 1, 2, \dots, N$  supposing the same property. Let  $s_{hn}$   $n = 1, 2, \dots, N$  be the finite element solution.

- Recovery of kinematically-admissible quantities

It is the displacement  $\hat{U}_{KA}$ . Let us consider that the central difference method is used. One prescribes :

$$\frac{d}{dt} \hat{U}_{KA} \Big|_t = \underline{V}_{ht} \quad t = t_0, t_{1/2}, t_1, \dots, t_N$$

The values  $\underline{V}_{ht}$  for  $t = t_0, t_{1/2}, t_1, \dots, t_N$  are derived from the f.e. solution  $\underline{V}_{ht}$  for  $t = t_{1/2}, \dots, t_{N-1/2}$  and the data  $\underline{V}_0$ .

One defines :

$$\underline{V}_{htn} = \frac{1}{2} (\underline{V}_{htn-1/2} + \underline{V}_{htn+1/2}) \quad n \in \{1, 2, \dots, N\}$$

Supposing  $\hat{U}_h$  piecewise linear, on the subinterval  $[t_n, t_{n+1/2}] [t_{n-1/2}, t_n] \quad n \in 1, 2, \dots, N$ ,  $\hat{U}_{CA}$  and then  $\hat{U}_{KA}$  are defined over  $[0, T]$ .

- Recovery of dynamically-admissible quantities

They are the stress  $\hat{\sigma}_{DA}$  and the acceleration quantity  $\hat{\Gamma}_{DA}$ . The corresponding quantities computed from the f.e. solution are  $\underline{\sigma}_{hn}$  and  $\underline{\Gamma}_{hn}$  at the time  $t_n \quad n \in 1, 2, \dots, N$ .  $\hat{\sigma}_{hn}$  and  $\hat{\Gamma}_{hn}$  are related to the f.e. solution by the strong prolongation condition which becomes in dynamics:

$$\int_E (\hat{\sigma}_{DA n} - \underline{\sigma}_{hn}) \underline{\text{grad}} \omega_i \, dE + \int_E (\hat{\Gamma}_{DA n} - \underline{\Gamma}_{hn}) \omega_i \, dE = 0 \quad (52)$$

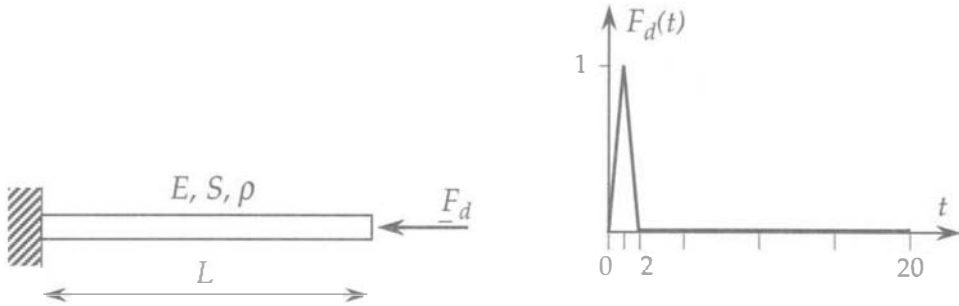
The tractions  $\hat{\Gamma}_{DA n}$  on the element edge are still linear combination of the restrictions of the shape functions  $\omega_i$  on the edges. For  $\hat{\Gamma}_{DA n}$ , several possibilities occur: it is a piecewise polynomial of degree  $k$  ( $0 \leq k \leq p$ ).  $k$  being a choice, there are several variants. Let  $\hat{\mathcal{Z}}_E^k$  be the corresponding subspace of admissible  $\hat{\Gamma}_{DA}$ , i.e. verifying (52); an additional prolongation condition is :

$$\begin{aligned} \forall E \in \mathbf{E} \quad \forall n \in 1, 2, \dots, N \\ \forall \hat{\Gamma}_{-}^* \in \hat{\mathcal{Z}}_E^k \quad \int_E \frac{1}{\rho} (\hat{\Gamma}_{DA n} - \underline{\Gamma}_{hn}) \circ (\hat{\Gamma}_{-}^* - \hat{\Gamma}_{DA n}) \, d\Omega = 0 \end{aligned} \quad (53)$$

This recovery technique is very similar to the one previously described in statics.

### 6.3 Test: One Dimensional f.e. Dynamic Analysis

We consider the problem described in figure 35.



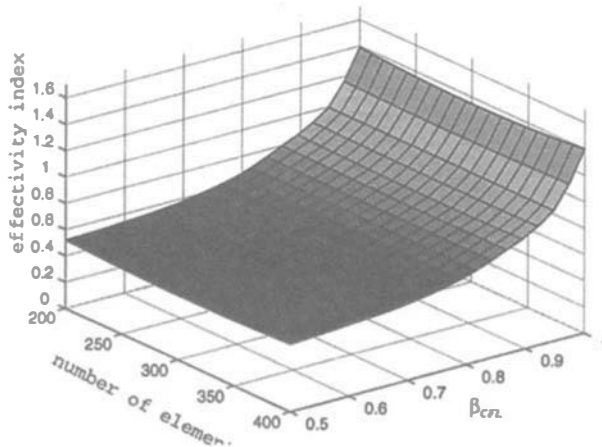
**Figure 35.** One dimensional dynamic problem

The finite element solution is computed using an explicit (0; 0.5) Newmark integration scheme. Since the analytical solution to such a problem is well-known, we compared the values of the estimator with the value of the exact error for various uniform meshes of the beam, as well as for different time step increments.

The time step size is evaluated in terms of its deviation from the courant condition :  $\beta_{CFL}$ . Then, the stability condition is written:

$$\Delta t = \beta_{CFL} \times \Delta t_{crit.} \leq \Delta t_{crit.} \quad (54)$$

Figure 36 shows the effectivity index in terms of the number of elements and of the deviation to the Courant condition. Over the zone where the time step has been chosen close to the critical time step ( $0.8 \leq \beta_{CFL} \leq 1$ ), the proposed estimator is very efficient.



**Figure 36 .** Effectivity index versus the number of elements and the deviation to the Courant condition

## 6.4 Comparison with Other Indicators

The previous test is simplified; one takes one element. It is a single degree of freedom problem where space does not play any role.

We compare the constitutive relation error estimator with other error indicators:

- the (Zienkiewicz et al. 1984) (Zienkiewicz and Xie 1991) indicator denoted here ZWX
- the (Li et al. 1993) indicator denoted LZW
- the (Wiberg and Li 1993) indicator denoted WL.

More details can be found in (Combe et al. 1999). Figure 37 shows the time evolution of the different estimated errors. It appears that the effectivity index of the CRE estimator is rather good.

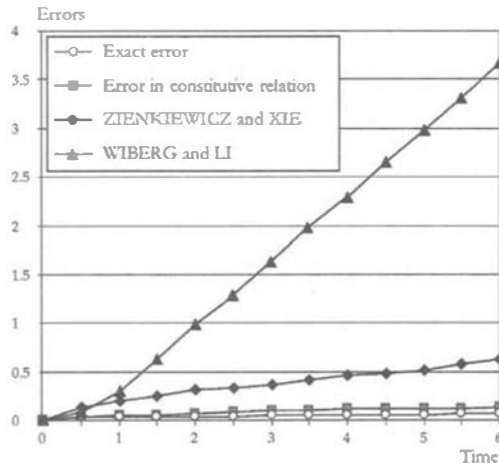


Figure 37. Time evolution of various estimated errors

## 7 Constitutive Relation Modelling Error in Dynamics and Model Updating

The principles of the constitutive relation modelling error are only recalled for the forced vibration problem. For further details, see (Ladevèze 1998).

The reference is made up of reliable quantities, such as reliable equations (e.g. the equilibrium equation) and accurate experimental data (e.g. frequencies and sensor locations). The constitutive relations and the less accurate experimental data (eigenmodes components and frequency response functions magnitudes) are treated separately. Therefore, a modified error on the constitutive relation is defined, in order to quantify the model quality with respect to our reference. In contrast with a lot of methods, the error defined herein has a strong mechanical



sense. Hence, the most erroneous regions are those providing the most significant contribution to the error. Nearly space uniform erroneous structural parameters can also be observed.

The parameter updating is performed by minimizing the modified constitutive relation error. Such an inverse problem without addition is ill-posed. Our updating process can be thought of as a regularization because it leads to a unique solution of the problem. It is iterative, and each iteration includes two steps. The first consists in localizing the most erroneous regions and then the most erroneous structural parameters, and the second is the correction of the parameters belonging to these regions. The updating process is stopped when a threshold error is reached. Several updating examples are shown.

The basic concept is the modelling CRE which has been introduced in (Ladevèze 1983, 1991) and developed in (Ladevèze, Reynier and Maia 1994) (Chouaki, Ladevèze and Proslie 1998) (Ladevèze and Chouaki 1999).

### 7.1 The forced vibration problem

The prescribed forces and displacements (complex numbers) are harmonic:

$$\begin{aligned} & \bullet \underline{f}_{d,\omega} \exp(i \omega t) \quad \underline{F}_{d,\omega} \exp(i \omega t) \\ & \bullet \underline{U}_{d,\omega} \exp(i \omega t) \end{aligned}$$

where  $\omega$  is the angular frequency. The forced vibration problem is:

Find the displacement, stress, acceleration force amplitudes and phases  $(\underline{U}(\underline{M}), \underline{\sigma}(\underline{M}), \underline{\Gamma}(\underline{M}))_{\omega}$   $\underline{M} \in \Omega$  such that they satisfy:

- the kinematic constraints:  $\underline{U} \in \mathcal{U}$

$$\underline{U} \Big|_{\partial_1 \Omega} = \underline{U}_{d,\omega} \quad (55)$$

- the equilibrium equation:  $(\underline{\Gamma}, \underline{\sigma}) \in \mathcal{S}$

$$- \int_{\Omega} \text{tr} \left[ \underline{\sigma} \underline{\varepsilon}(\underline{U}^*) \right] d\Omega + \int_{\Omega} \underline{f}_{d,\omega} \circ \underline{U}^* d\Omega + \int_{\partial_1 \Omega} \underline{F}_{d,\omega} \circ \underline{U}^* dS = \int_{\Omega} \underline{\Gamma} \circ \underline{U}^* d\Omega \quad (56)$$

$$\forall \underline{U}^* \in \mathcal{U}_{ad,0} = \left\{ \underline{U}^* / \underline{U}^* \Big|_{\partial_1 \Omega} = 0, \underline{U}^* \in \mathcal{U} \right\}$$

- the constitutive relations:

$$\underline{\sigma} = \underline{\mathbf{K}}_{\otimes}(\underline{U}) + \underline{\mathbf{B}}_{\otimes}(\underline{U}) i \omega = \bar{\underline{\mathbf{K}}}_{\otimes}(\underline{U}) \quad (57a)$$

$$\underline{\Gamma} = -\rho \omega^2 \underline{U} + \underline{\mathfrak{A}}(\underline{U}) i \omega = \bar{\underline{\mathfrak{A}}}(\underline{U}) \quad (57b)$$

$\mathcal{U}$  denotes the space of the displacement amplitudes defined over  $\Omega$  which possess a finite energy;  $\mathbf{K}$  is the Hooke's tensor which is positive definite and symmetric.  $\mathbf{B}$  and  $\mathfrak{a}$  are real, linear, symmetric and positive definite operators satisfying the Drucker's stability conditions;  $\rho$  is the mass density and  $\mathfrak{e}$  is the strain operator.

The Drucker stability conditions which are assumed, ensure the uniqueness of the solution, and they are satisfied by a large class of materials.

## 7.2 Classical CRE Estimator

Let us come back to the CRE definition in dynamics §6.2. For the given frequency  $\omega$ , we consider an amplitude triplet  $s = (\underline{U}_{KA}, \underline{\mathfrak{C}}_{DA}, \underline{\Gamma}_{DA})$  which is admissible. It follows that  $s$  verifies the kinematic constraints (55) and the equilibrium equations (56). Let  $\mathbf{S}_{ad, \omega}$  be the corresponding space. However,  $s$  does not verify the constitutive relations (57a) and (57b). Its quality is then defined by the following CRE:

$$\begin{aligned} \eta_{\omega}^2(s) = & \frac{\gamma}{2} \int_{\Omega} \text{Tr} \left[ (\mathbf{K} + \mathbf{T} \omega^2 \mathbf{B}) (\mathfrak{e}(\underline{U}_{KA}) - \mathfrak{e}_{DA}) (\mathfrak{e}(\underline{U}_{KA} - \mathfrak{e}_{DA})) \right] d\Omega \\ & + \frac{1-\gamma}{2} \int_{\Omega} \omega^2 (\rho \mathbb{1} + \mathbf{T} \mathfrak{a}) (\underline{U}_{KA} - \underline{U}_{DA}) \circ (\underline{U}_{KA} - \underline{U}_{DA})^* d\Omega \end{aligned} \quad (58)$$

(\*) signifies here conjugate.  $\mathbf{T}$  is a parameter which is a characteristic time determining the dissipation part in the error. Moreover, one has:

$$\begin{aligned} \mathfrak{e}_{DA} &= \bar{\mathbf{K}}^{-1} \underline{\mathfrak{C}}_{DA} \\ \underline{U}_{DA} &= \bar{\mathfrak{a}}^{-1} \underline{\Gamma}_{DA} \end{aligned} \quad (59)$$

$\gamma$  is a parameter belonging to  $[0, 1]$  that depends on the relative reliability of the constitutive relations (57a) and (57b). Its current value is 0.5. Then, the initial problem can be rewritten as follows:

$$\begin{aligned} & \text{Find } s_{\omega} \in \mathbf{S}_{ad, \omega} \\ & \text{minimizing } \eta_{\omega}^2(s') \text{ where } s' \in \mathbf{S}_{ad, \omega} \end{aligned} \quad (60)$$

$s$  admissible ( $s_{\omega} \in \mathbf{S}_{ad, \omega}$ ) means that the triplet satisfies exactly the reliable equations of the problem, the kinematical constraints and the equilibrium equation.

## 7.3 Reliable and Less Reliable Experimental Data

For the sake of simplicity, let us consider the problem where only one single excitation (or displacement) is prescribed at one point  $\underline{P}$ ; its direction is  $\underline{n}$ . At a given frequency  $\omega$ , the

components on  $\underline{n}$  of both the displacement and the force at  $\underline{P}$  are denoted  $\underline{u}_\omega$  and  $\underline{f}_\omega$ , respectively, the measured quantities being  $\tilde{\underline{u}}_\omega$  and  $\tilde{\underline{f}}_\omega$  ( $\tilde{\phantom{x}}$  means an experimental quantity).

Hence, we must distinguish between the reliable data and the less reliable data. It is considered here that the reliable ones are:

- the location of the excitation point;
- the excitation direction.

The less reliable experimental quantities are:

- $\tilde{\underline{u}}_\omega, \tilde{\underline{f}}_\omega$  or the transfer function  $\tilde{\alpha}$  defined as follows:

$$\tilde{\underline{u}}_\omega = \tilde{\alpha}_\omega \tilde{\underline{f}}_\omega \quad (61)$$

- the other measured response information: the displacements denoted  $\Pi \tilde{\underline{U}}_\omega$  and the forces denoted  $\Pi' \tilde{\underline{F}}_\omega$ .  $\Pi$  and  $\Pi'$  are projection operators that specify the parts of the measured displacements  $\tilde{\underline{U}}_\omega$  and forces  $\tilde{\underline{F}}_\omega$ , respectively.

To go further, a slight modification of the constitutive relation error must be carried out in order to include the fact that the data  $(\underline{U}_{d,\omega}, \underline{F}_{d,\omega}, \underline{f}_{d,\omega})$  are not entirely reliable quantities. First, the solution  $s$  of the problem is modified introducing two new variables  $\underline{u}_\omega$  and  $\underline{f}_\omega$ :

$$s = (\underline{U}, \underline{\mathcal{C}}, \underline{\Gamma}, \underline{u}_\omega, \underline{f}_\omega)$$

We still denote  $\mathbf{S}_{ad,\omega}$  the corresponding space of admissible  $s$ ; it contains only reliable data. Then, we add the constitutive relation error related to the model and to the quantities  $\underline{u}_\omega, \underline{f}_\omega$ :

$$\bar{\eta}_\omega^2(s) = \eta_\omega^2(s) + |\alpha_\omega \underline{f}_\omega - \underline{u}_\omega|^2 / |\alpha_\omega|$$

$\alpha_\omega$  is the model's transfer function between  $\underline{f}_\omega$  and  $\underline{u}_\omega$ .

Finally the problem (60) remains as follows:

$$\begin{aligned} &\text{Find } s_\omega \in \mathbf{S}_{ad,\omega} \\ &\text{minimizing } \bar{\eta}_\omega^2(s') \text{ where } s' \in \mathbf{S}_{ad,\omega} \end{aligned}$$

#### 7.4 Modelling Constitutive Relation Error

- Modified error on the constitutive relation at a given frequency  $\omega$

Now, in order to take into account the less reliable experimental information, a modified error on the constitutive relation is introduced. At a given frequency  $\omega$ , this error is written as follows:

$$\begin{aligned} e_{\omega}^2(s) = & \bar{\eta}_{\omega}^2(s) + \frac{r}{1-r} \left\{ \gamma \left\| \Pi \underline{U}_c - \Pi \tilde{\underline{U}}_{\omega} \right\|^2 + (1-\gamma) \left\| \Pi \underline{\Gamma}_s - \Pi \tilde{\underline{\Gamma}}_{\omega} \right\|^2 \right. \\ & \left. \times \frac{1}{2} \left[ \left| f - \tilde{f} \right|^2 |\alpha_{\omega}| + \frac{|u - \tilde{u}|^2}{|\alpha_{\omega}|} \right] \right\} \end{aligned} \quad (62)$$

Let us introduce the problem:

$$\begin{aligned} & \text{Find } s_{\omega} \in \mathbf{S}_{ad, \omega} \\ & \text{minimizing } e_{\omega}^2(s') \text{ where } s' \in \mathbf{S}_{ad, \omega} \end{aligned} \quad (63)$$

All the accurate quantities and equations have been introduced in  $\mathbf{S}_{ad, \omega}$  and are then verified exactly by the solution to problem (63). The less reliable equations and measured quantities are verified in a mean sense through the minimization of  $e_{\omega}^2$ .

The first term of  $e_{\omega}^2(s)$  contains the constitutive relations of the first analytical model. The second term is the square of a distance to the less reliable measured quantities.  $r/(1-r)$  depends on the relative quality.  $r = 0.5$  is the current value.  $\| \cdot \|$  and  $\| \cdot \|$  are energetic norms obtained after a standard condensation technique whose choice is not so critical.

- Modelling constitutive relation error on the studied frequency bandwidth

The error  $\varepsilon$  defines the quality of the model with respect to experimental data :

$$\varepsilon^2 = \int_{\omega_{\min}}^{\omega_{\max}} z(\omega) \bar{\eta}_{\omega}^2(s_{\omega}) / D_{\omega}^2(s_{\omega}) d\omega \quad (64)$$

The function  $z(\omega)$  is a weighting factor introduced in order to focus on some selected frequencies. This function is scaled such that:

$$\int_{\omega_{\min}}^{\omega_{\max}} z(\omega) d\omega = 1 \quad z(\omega) \geq 0 \quad (65)$$

Weighting factor examples can be given as follows:

$$\begin{aligned}
\bullet z(\omega) &= \frac{1}{\omega_{\max} - \omega_{\min}} \quad \text{over } |\omega_{\min}, \omega_{\max}| \\
\bullet z(\omega) &= \frac{1}{m} \sum_{i=1}^m \delta_{\omega_i}(\omega)
\end{aligned} \tag{66}$$

where  $\omega_i$  are the eigenfrequencies belonging to  $|\omega_{\min}, \omega_{\max}|$ , and  $\delta_{\omega_i}$  is the Dirac distribution associated with the value  $\omega_i$ .

$D_\omega(s_\omega)$  is used to introduce the relative error  $\bar{\eta}_\omega(s_\omega)/D_\omega(s_\omega)$  (without dimension). One uses a quantity similar to D in (49).

Then, if the structure is divided into substructures  $E \in \mathbf{E}$ , it is possible to define  $\epsilon_{E, \omega}$ , the contribution of the substructure E to the error such that:

$$\epsilon_\omega^2(s_\omega) = \sum_{E \in \mathbf{E}} \epsilon_{E, \omega}^2 \tag{67}$$

*Remarks:*

- The extension to multiple excitations does not involve additional difficulties.
- The transposition to the finite element framework is very straightforward; greater detail is provided in (Chouaki et al. 1998).
- The problem formulated above can be described using inverse problem terminology as follows:
  - the objective cost function:  $\epsilon^2$
  - the state variables:  $(\underline{U}, \varpi, \underline{\Gamma}, u_\omega, f_\omega)$  over  $\omega \in |\omega_{\min}, \omega_{\max}|$
  - the state equation: equilibrium equation
  - the constraints: kinematic constraints (I)
  - the model's parameters: Young's modulus, mass density, section, etc.

## 7.5 Organization of the Updating Process

The mathematical model depends on numerous structural parameters. Recalling that inverse problems are ill-posed, it is obvious that the correction of all the parameters will be very critical. Thus, a reasonable approach consists in improving only a few structural parameters at a time. This leads to an iterative process which is stopped when a threshold error is reached.

At the nth iteration, our method is staggered as follow.

- *The localization step.* The most erroneous regions are localized by solving the problem:

$$\begin{aligned}
&\text{find the substructures } E \in \mathbf{E} \text{ such that:} \\
&\epsilon_E \geq 0.8 \max_{E \in \mathbf{E}} \epsilon_E
\end{aligned} \tag{68}$$

- *The correction step.* Once the most erroneous regions have been localized, some structural parameters belonging to these regions can then be selected. The corresponding structural parameter subset is  $[\underline{\mathcal{K}}]_n$ . Hence, denoting by  $\underline{k}$  the structural parameter vector, the correction step is expressed as :

$$\left\{ \begin{array}{l} \text{find } \underline{k} \in [\underline{\mathcal{K}}]_n \\ \text{minimizing the total error } e^2(\underline{k}') \quad \underline{k}' \in [\underline{\mathcal{K}}]_n \end{array} \right. \quad (69)$$

where:

$$e^2(\underline{k}') = \int_{\omega_{\max}}^{\omega_{\min}} d\omega z(\omega) e_{\omega}^2(s_{\omega}, \underline{k}') / D_{\omega}^2(s_{\omega}, \underline{k}')$$

- *The iteration stopping error*

The iteration process is stopped when:

$$e(\underline{k}_n) \leq e_0$$

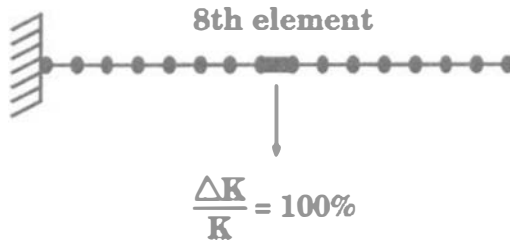
where  $e_0$  is a threshold which depends essentially on the experiment quality.

*Remark :* There is no regularization term in the modified error on the constitutive relation. Hence, the minimization of this error remains an ill-posed problem. Then, the updating process can be thought of as a regularization because it leads to an unique solution.

## 7.6 Test 1: Influence of the Amount of Experimental Information

The model is the finite element one. Discretization errors are not considered. The "experimental" data have been simulated from the finite element model in which some structural parameters have been modified.

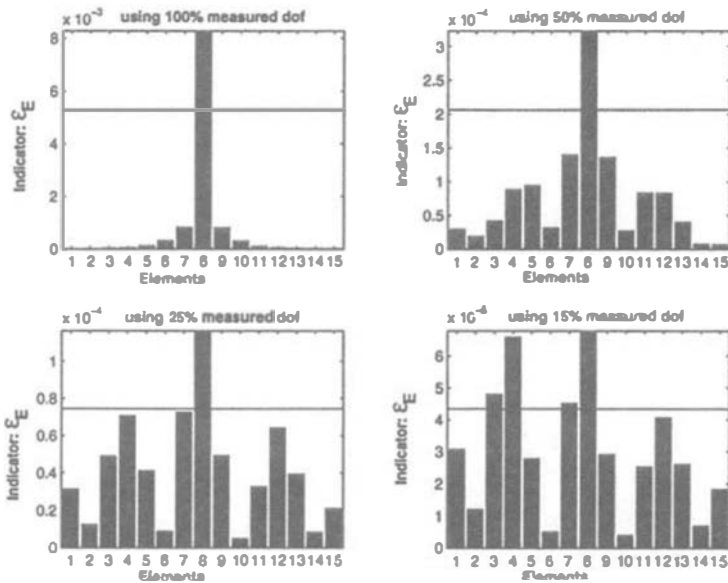
Test 1 concerns the clamped-free beam in figure 38. The structure is discretized using 15 beam elements (see table 2). The experimental data consist of frequency response functions, collected over the frequency bandwidth [0,20] Hz, comprising the first five eigenfrequencies. The "measured" frequency response functions have been simulated using the finite-element model, in which the Young's modulus of the eighth element has been increased by 100%. Figure 39 shows the results of the localization step with respect to the amount of experimental information. The results obtained with 15% measured degrees of freedom differ greatly from those obtained with 100% measured degrees of freedom.



**Figure 38. Clamped-free beam**

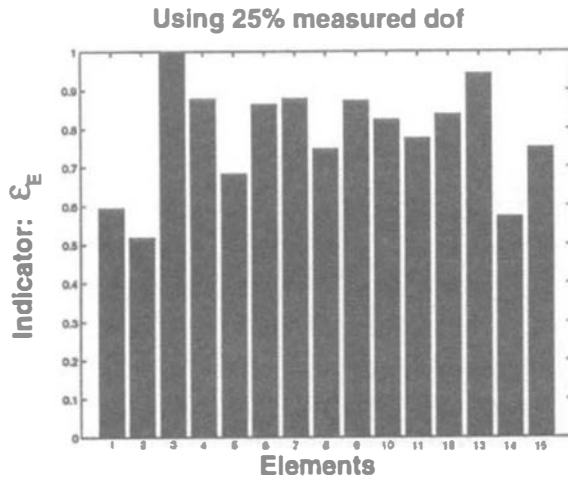
Total length	0.8 m
Section	$10^{-4} \text{ m}^2$
Young's modulus	$0.31 \times 10^8 \text{ N m}^{-2}$
Density	$7800 \text{ kg m}^3$
Damping	hysteretic
Damping loss factor	1%

**Table 2.** Characteristics of the structure



**Figure 39.** The localization capabilities with respect to the amount of experimental information

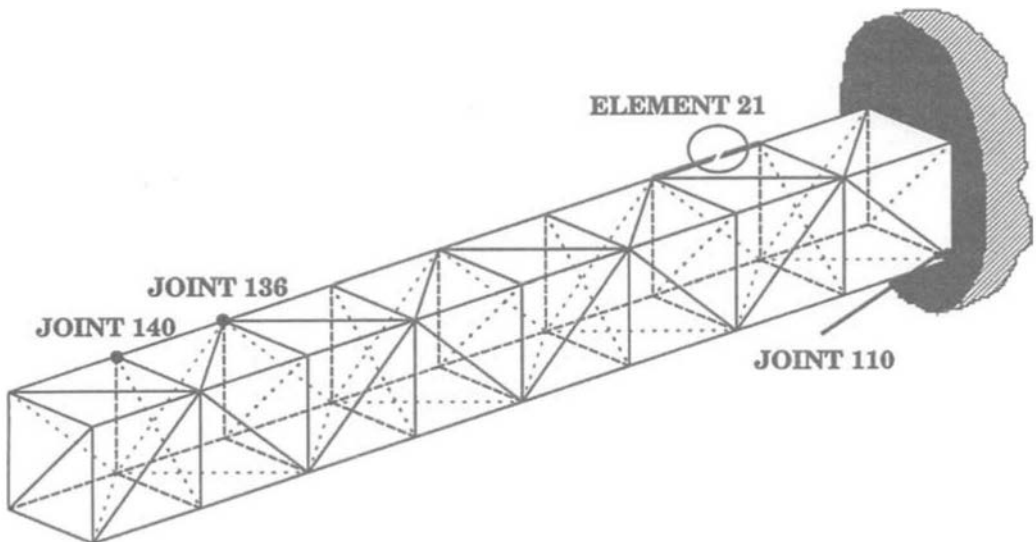
Now, in order to illustrate that the error on the constitutive relation is also able to detect uniform defects, the Young's moduli of the 15 elements have been increased by 100%. Then, figure 40 shows that the contributions of the various elements to the error are very close.



**Figure 40.** Uniform stiffness defect

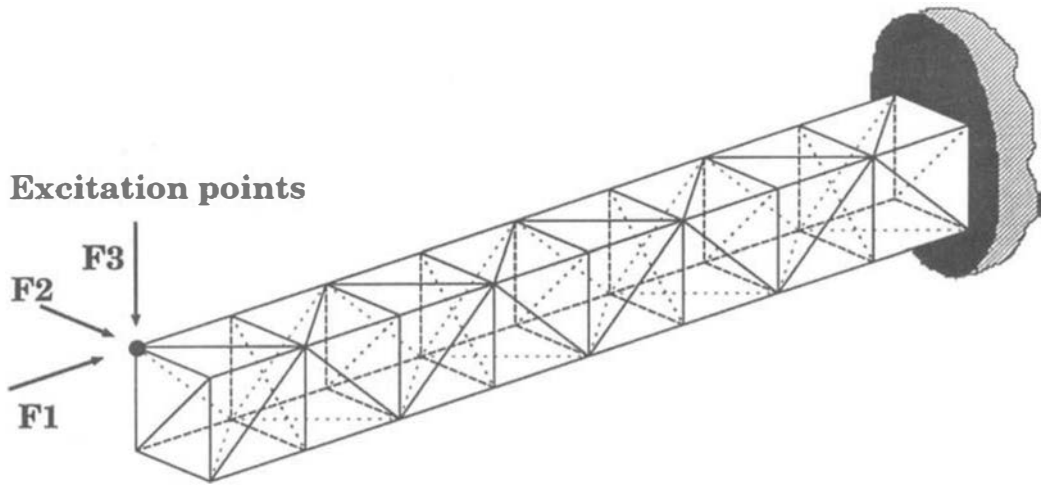
### 7.7 Test 2: Eight-Bay Truss

Industrial applications concern satellites, launchers, planes, etc. Here, we study the "Eight-Bay Truss" whose real configuration is described in Figure 41. The "experimental results" are computed with such a configuration. Tests conducted and experimental data collected are shown in Figure 42.



**Figure 41.** The real Eight-Bay Truss

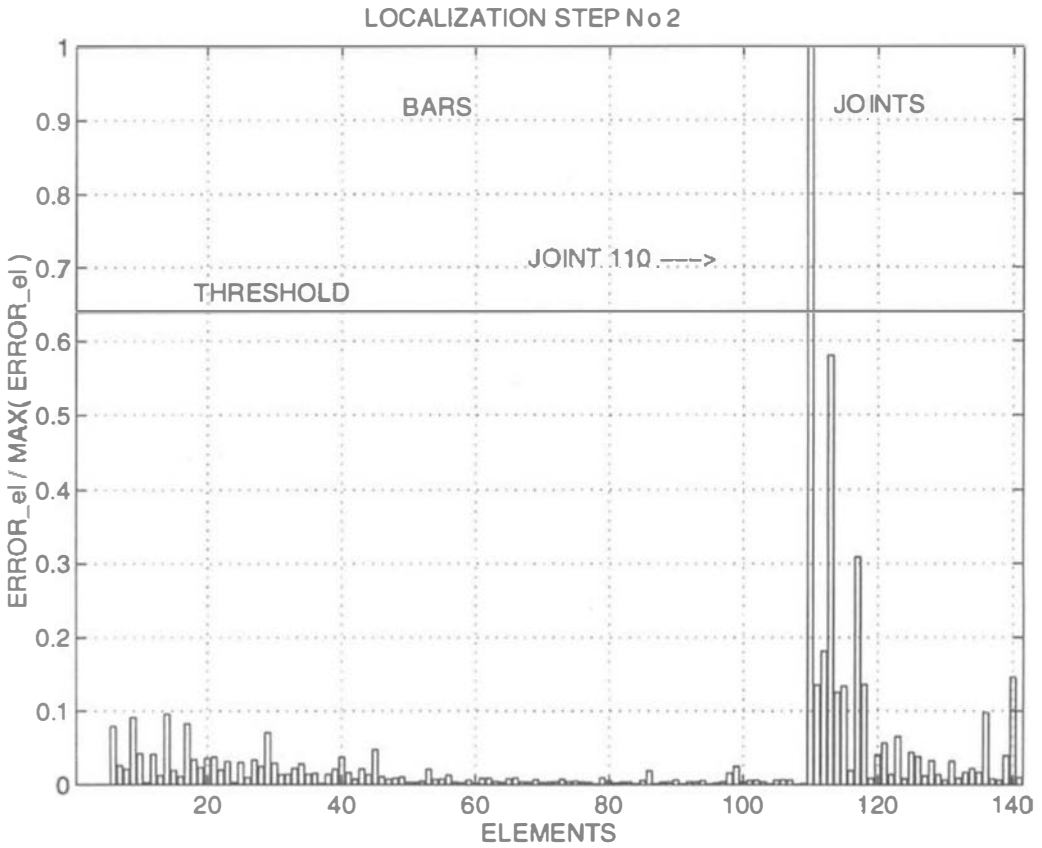




**Figure 42.** Tests conducted and experimental data collected

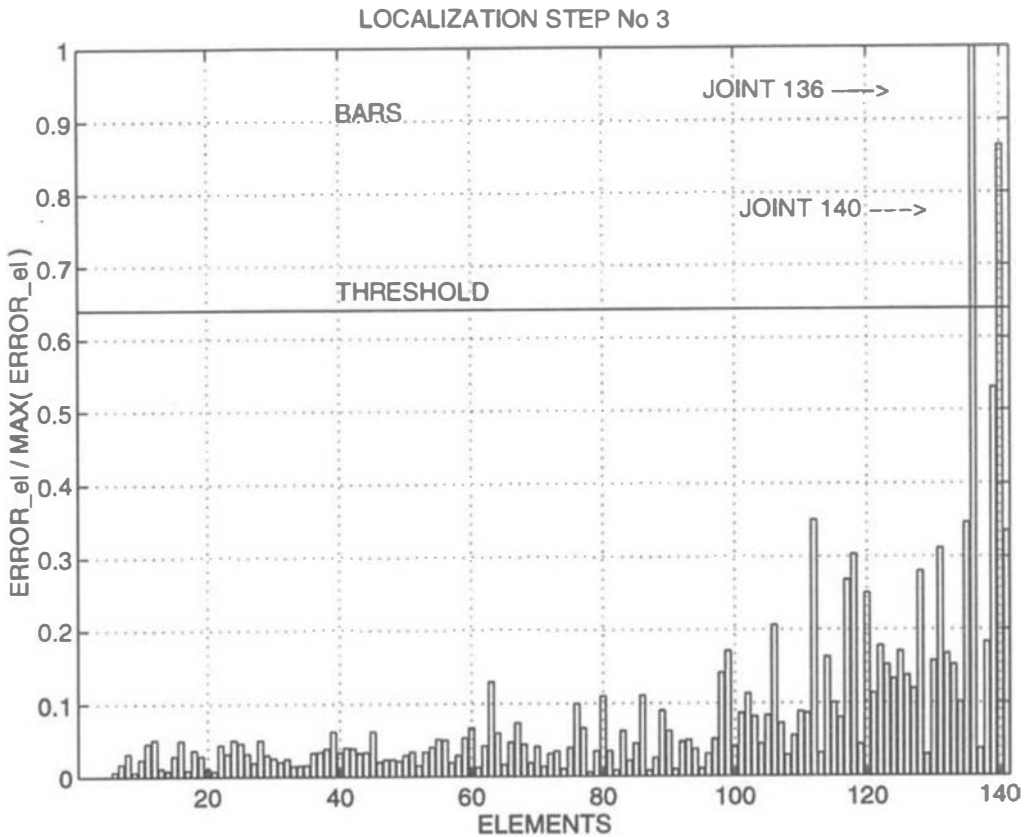
Elements and initial values of the structural parameters	First step	Second step	Exact values
<b>Bar 21</b>			
- Stiffness $p_k = 1$	$p_k := 0.0002$	corrected	$p_k := 0.0000$
- Mass : $p_m = 1$	$p_m = 1.0467$		$p_m = 1.0000$
<b>Joint 110</b>			
- Stiffness : $p_k = 1$	Not localized	$p_k = 0.5025$	$p_k = 0.5000$
- Mass : $p_m = 1$		$p_m = 1.0007$	$p_m = 1.0000$
Error	1.109	0.147	-

**Figure 43.** First and second updating steps



**Figure 44.** Error contributions of the various elements - second updating step

Figure 43 presents the structural parametric corrections and the global error value for the first two updating steps. The chart of error contributions to the global error of the various elements is given in Figure 44 for the second updating step; joint 110 appears clearly as an incorrectly modelled zone. The updating procedure normally has to be stopped after the second step because the error value (0.053) is small in comparison with the quality of the experimental results which have been contaminated by noise (level:  $\pm 3\%$ ). During this step, the modelling errors related to joints 136 and 140 have not yet been detected. If one were to proceed further, it would be possible to detect and then correct these errors. Figure 45 shows, for the third updating step, the chart of error contribution to the global error of the various elements; modelling errors for joints 136 and 140 are clearly indicated.



**Figure 45.** Error contributions of the various elements - third eventual updating step

## References

- Ainsworth, M., and Oden, J.T. (1997). A Posteriori Error Estimation in Finite Element Analysis, *Computational Methods Applied, Mechanical Engineering*, 142, 1-88
- Aubry, D., and Tie, B. (1992). Error Estimates, h-Adaptive Strategy and Hierarchical Concept for Non Linear Finite Element Method, *Proceedings of the First European Conference on Numerical Methods in Engineering*, Hirsch, Zienkiewicz and Oñate Editors, Bruxelles (Belgique), 17-24
- Azziz, K., and Babuska, I. (1972). *The Mathematical Foundations of the Finite Element Method with Applications to Partial Differential Equations*, Academic Press, New-York
- Babuska, I., and Rheinboldt, W.C. (1982). Computational Error Estimates and Adaptive Processes for Some Nonlinear Structural Problems, *Computational Methods Applied Mechanical Engineering*, 34, 895-937

- Babuska, I., Strouboulis, T., and Gangaraj, S.K. (1997). A Model Study of the Quality of a Posteriori Error Estimators for Finite Element Solutions of Linear Elliptic Problems with Particular Reference to the Behavior near the Boundary, *International Journal Numerical Method Engineering*, 40, 2521-2577
- Babuska, I., Strouboulis, T., Upadhyay, C.S., and Gangaraj, S.K. (1994). A Model Study of the Quality of a Posteriori Estimators for Linear Elliptic Problems: Error Estimation in the Interior of Patchwise Uniform Grids of Triangles, *Computational Methods Applied Mechanical Engineering*, 114, 307-378
- Babuska, I., Strouboulis, T., Upadhyay, C.S., Gangaraj, S.K., and Copps, K. (1994). Validation of a Posteriori Error Estimators by Numerical Approach, *International Journal Numerical Method Engineering*, 37, 1073-1123
- Bank, R.E., and Weiser, A. (1985). Some a Posteriori Error Estimators for Elliptic Partial Differential Equations, *Mathematics of Computations*, 44, 283-301
- Bass, J.M., and Oden, J.T. (1987). Adaptive Finite Element Methods for a Class of Evolution Problems in Viscoplasticity, *International Journal of Engineering. Sciences*, 25 (6), 623-653
- Berman, A., and E.J., Nagy (1983). Improvement of a Large Analytical Model Using Test Data, *AIAA Journal*, 21 1168-1173
- Boisse, P., and Coffignal, G. (1998). Error through the Constitutive Relation for Beams or  $C^0$  Plate Finite Element: Static and Vibration Analyses, *In Advances in Adaptive Computational Methods in Mechanics*, 493-512, Ladeveze and Oden Editors, Elsevier
- Boisse, P., Perrin, S., Coffignal, G., and Hadjeb, K. (1999). Error Estimation through the Constitutive Relation for Ressenner-Mindlin Plate Bending Element, *Computers and Structures*, 73, 615-627
- Boroomand, B. and Zienkiewicz, O.C. (1998). Recovery Procedures in Error Estimation and Adaptivity: Adaptivity in Nonlinear Problems of Elasto-Plasticity Behaviour, *In Advances in Adaptive Computational Methods in Mechanics*, 383-410, Ladeveze and Oden Editors, Elsevier
- Bouillard, P., and F., Ihlenburg (1998). Error Estimation and Adaptivity for the Finite Element Method in Acoustics, In: *Advances in Adaptive Computational Methods in Mechanics*; P. Ladevèze and J.T. Oden (Eds.), Elsevier 477-492
- Bouillard, P., and Ihlenburg, F. (1999). Error Estimation and Adaptivity for the Finite Element Method in Acoustic: 2d and 3d Applications, *Computational Methods Applied Mechanical Engineering*, 176, 147-164
- Brink, U., and E., Stein (1998). A posteriori error estimation in large-strain elasticity using equilibrated local Neumann problems, *Computational Methods in Applied Mechanics*, 161, 77-101
- Bussy, P., G., Coffignal, and P., Ladevèze (1985). Reliability and optimization of nonlinear finite element analyses, *in Proceedings of NUMETA'85*, Swansea
- Chouaki, A., P., Ladevèze, and L., Proslir (1998). Updating Structural Dynamic Models with Emphasis on the Damping Properties, *AIAA Journal*, 36, 1094-1099
- Ciarlet, P.G. (1978). *The Finite Element Method for Elliptic Problems*, North-Holland
- Cirak, F., and Ramm, E. (1998). A Posteriori Error Estimation and Adaptivity for Linear Elasticity Using the Reciprocal Theorem, *Computational Methods Applied Mechanical Engineering*, 156, 351-362

- Combe, J.P., Ladeveze, P., and Pelle, J.P. (1998). Constitutive Relation Error Estimator for Transient Finite Element Analysis, CD-ROM of Proceedings of the Fourth World Congress on Computational Mechanics, Buenos Aires (Argentine)
- Combe, J.P., Ladeveze, P., and Pelle, J.P. (1999). Constitutive Relation Error Estimator for Transient Finite Element Analysis, *Computational Methods Applied Mechanical Engineering*, 176 (1-4), 165-185
- Combe, J.P., P., Ladevèze, and J.P. Pelle (1999). Constitutive Relation Error Estimator for Transient Finite Element Analysis, *Proceeding ECCM 99*, Munich
- Coorevits, P., Dumeau, J.P., and Pelle, J.P. (1995). Maillages 3D Adaptatifs: Quelques Procédures pour Respecter une Carte de Taille, *Proceedings of Strucome 95*, Paris, 117-127
- Coorevits, P., Dumeau, J.P., and Pelle, J.P. (1996). Analyses Éléments Finis Adaptatives pour les Structures Tridimensionnelles en Élasticité, *Revue Européenne des Eléments Finis*, 5, n°3, 341-374
- Coorevits, P., Dumeau, J.P., and Pelle, J.P. (1997). Error Estimator and Adaptivity for three-dimensional Finite Element Analyses, In *Advances in Adaptive Computational Methods in Mechanics*, 443-458, Ladeveze and Oden Editors, Elsevier
- Coorevits, P., Ladeveze, P., and Pelle, J.P. (1992). Anisotropic Adaptive Mesh: Application to Transient Problems, *Proceedings of First European Conference on Numerical Methods in Engineering*, Bruxelles (Belgique)
- Coorevits, P., P., Ladevèze, and J.P., Pelle (1992). Anisotropic Adaptive Mesh: Application to Transient Problems, *Proceedings of the 1st European Conference on Numerical Methods in Engineering*, Brussels, 209-215
- Coorevits, P., Ladevèze, P., Pelle, J.P., and Rougeot, P. (1992). Some New Applications of a Method for the Control and Optimization of Finite Element Computations, In *New Advances in Computational Structural Mechanics*, Ladeveze and Zienkiewicz Editors, Elsevier, 205-217
- De Saxce, G. (1992). Une Généralisation de l'Inégalité de Fenchel et ses Applications aux Lois Constitutives, *Comptes-Rendus Académie des Sciences*, Paris, 314, li, 125-129
- Farhat, C., and F.M., Hemez (1993). Updating Finite-Element Dynamic Models using an Element-by-Element Sensitivity Methodology, *AIAA Journal*, 31, 1702-1711
- Fourment, L., and Chenot, J.L. (1995). Error estimators for viscoplastic materials: application to forming processes, *International Journal for Numerical Methods in Engineering*, 12(5), 469-490
- Gallimard, L., Ladeveze, P., and Pelle, J.P. (1996). Error Estimation and Adaptivity in Elastoplasticity, *International Journal for Numerical Method in Engineering*, 39, 189-217
- Gallimard, L., Ladeveze, P., and Pelle, J.P. (2000). An Enhanced Error Estimator on the Constitutive Relation for Plasticity Problems, *Computer and Structures*, à paraître
- Hjjaj, M. (1999). Sur la Classe de Matériaux Standards Implicites: Concept, Aspect Discrétisés et Estimation de l'Erreur a Posteriori, *Thèse de la Faculté Polytechnique*, Mons, Belgique
- Johnson, C., and Hansbo, P. (1991). Adaptive Finite Element Methods for Small Strain Elasto-Plasticity, *Proceedings of Iutam Conference on Finite Inelastic Deformations Theory and Applications*, Hannover (Allemagne)
- Kaouk, M., and D.C., Zimmerman (1994) Structural Damage Assessment Using a Generalized Minimum Rank Perturbation, *AIAA Journal*, 32, 836-842

- Kelly, D.W. (1984). The Self-Equilibration of Residuals and Complementary a Posteriori Error Estimates in the Finite Element Method, *International Journal Numerical Method Engineering*, 20, 1491-1506
- Ladevèze, P. (1983). Recalage de Modélisations des Structures Complexes, *Technical Report 33.11.01.4*, Aérospatiale, Les Mureaux
- Ladeveze, P. (1985). Sur une Famille d'Algorithmes en Mécanique des Structures, *Comptes-Rendus Académie des Sciences*, Paris, 300, Ii, 41-44
- Ladeveze, P. (1989). La Méthode à Grand Incrément de Temps pour l'Analyse des Structures à Comportement Non Linéaire décrit par Variables Internes, *Comptes-Rendus Académie des Sciences*, Paris, 309, II, 1095-1099
- Ladevèze, P. (1993). Constitutive Relation Error in Dynamics Theory and Application to Model Updating, *Internal Report 150* (in french)
- Ladevèze, P. (1998). A Modelling Error Estimator for Dynamic Structural Model Updating, In: *Advances in Adaptive Computational Methods in Mechanics*, P. Ladevèze and J.T. Oden (Eds.), Elsevier 135-51
- Ladeveze, P. (1999). *Nonlinear Computation Structural Mechanics, New Approaches and non Incremental Methods of Calculation*, Springer
- Ladeveze, P., and Chouaki, A. (1999). Application of a Posteriori Error Estimation for Structural Model Updating, *Inverse Problems*, 15, 49-00
- Ladevèze, P., Coffignal, G., and Pelle, J.P. (1986). Accuracy of Elastoplastic and Dynamic Analysis, In *Accuracy Estimates and Adaptive Refinements in Finite Element Computations*, Chap 11, 181-203, Babuska, Gago, Oliveira and Zienkiewicz Editors, J. Wiley
- Ladevèze, P., and Leguillon, D. (1981). Error Computation in Finite Element Method and Application, *Proceedings Gamni*, Dunod, Paris (France)
- Ladevèze, P., and Leguillon, D. (1983). Error Estimate Procedure in Finite Element Method and Application, *Siam Journal Num. Anal.*, 20 (3), 485-509
- Ladeveze, P., and Maunder, E.A.W. (1996). A General Method for Recovering Equilibrating Element Traction, *Computational Methods Applied Mechanical Engineering*, 137, 111-151
- Ladeveze, P., and Maunder, E.A.W. (1997). A General Methodology for Recovering Equilibrating Finite Element Traction and Stress Fields for Plates and Solid Elements, *Computational Ass. Mechanical and Engineering Sciences*, 4, 533-548
- Ladeveze, P., and Moes, N. (1998). A new a Posteriori Error Estimation for Nonlinear Time-Dependent Finite Element Analysis, *Computational Methods Applied Mechanical Engineering*, 157, 45-68
- Ladeveze, P., Moes, N., and Douchin, B. (1999). Constitutive Relation Error Estimations for (Visco) Plasticity Finite Element Analysis with Softening, *Computational Methods Applied Mechanical Engineering*, 176, 247-264
- Ladeveze, P., and Oden, J.T. (1998). *Advances in Adaptive Computational Methods in Mechanics*, Elsevier
- Ladevèze, P., Pelle, J.P., and Rougeot, P. (1991). Error Estimation and Mesh Optimization for Classical Finite Elements, *Engineering Computations*, 8, 69-80
- Ladevèze, P., M., Reynier, and N.M.M., Maia (1994). *Error on the Constitutive Relation in Dynamics Inverse Problems in Engineering*, 1st edition, ed. H.D. Bui et al. (Rotterdam: Balkema) 251-256

- Ladevèze, P., and Rougeot, P. (1997). New Advances on a Posteriori Error on Constitutive Relation in Finite Element Analysis, *Computational Methods Applied Mechanical Engineering*, 150, 239-249
- Ladevèze, P., Rougeot, P., Blanchard, P., and Moreau, J.P. (1999). Local Error Estimators for Finite Element Linear Analysis, *Computational Methods Applied Mechanical Engineering*, 176, 231-246
- Li, X.D., L.F., Zeng, and N.E., Wiberg (1993). A Simple Local Error Estimator and an Adaptive Time-Stepping Procedure for Direct Integration Method in Dynamic Analysis, *Com. in Numerical Method in Engineering*, 9 273-292
- Natke, H.G. (1991). Error Localization within a Spatially Finite-Dimensional Mathematical Model, *Computational Mechanics*, 8, 153-160
- Natke, H.G. (1994). Model Verification and Validation in Engineering, *Bulletin of Polish Academy Sciences Tech. Sciences*, 42 505-519
- Nobari, A.S., D.A., Robb, and D.J., Ewins (1993). Model Updating and Joint Identification Methods: Applications, Restrictions and Overlap, *Journal Modal. Anal.* 8, 93
- Oden, J.T., and Prudhomme, S. (1999). Goal-Oriented Error Estimation and Adaptivity for the Finite Element Method, *TICAM Report*, 99-15, Austin (U.S.A.)
- Peraire, J., and Patera, A.T. (1998). Bounds for Linear-Functional Outputs of Coercive Partial Differential Equations; Local Indicators and Adaptive Refinements, *In Advances in Adaptive Computational Methods in Mechanics*, 199-216, Ladeveze and Oden Editors, Elsevier
- Peric, D., Yu, J., and Owen, D.R.J. (1994). On Error Estimates and Adaptivity in Elastoplastic Solids: Application to the Numerical Simulation of Strain Localization in Classical and Cosserat Continua, *International Journal Numerical Method Engineering*, 37, 1351-1379
- Pijaudier-Cabot, G., Bode, L., and Huerta, A. (1995). Arbitrary Lagrangian Eulerian Finite Element Analysis of Strain Localization in Transient Problems, *International Journal Numerical Method Engineering*, 38 (24), 4171-4191
- Rannacher, R., and Suttmeier, F.T. (1998). A Posteriori Error Control and Mesh Adaptation for FE Models in Elasticity and Elasto-Plasticity, *In Advances in Adaptive Computational Methods in Mechanics*, 275-292, Ladeveze and Oden Editors, Elsevier
- Ren, Y., and C.F. ,Beards (1995). Identification of Joint Properties of a Structure using F.R.F. Data, *Journal Sound Vibration*, 186, 567-587
- Stein, E., F.J., Barthold, and M., Schmitdt (1997). Error Estimation Mesh Adaptivity for Elastoplastic Deformations, in D.R.J. Owen, E. Onate and E. Hinton (Eds.), *Proceedings of the Fifth International Conference on Computational Plasticity*, Barcelona 597-602
- Stein, E., Barthold, F.J., Ohnimus, S., and Schmidt, M. (1998). Adaptive Finite Element in Elastoplasticity with Mechanical Error Indicators and Neumann-Type Indicators, *In Advances in Adaptive Computational Methods in Mechanics*, 81-100, Ladeveze and Oden Editors, Elsevier
- Strouboulis, T., Babuska, I., Datta, D., Copps, K., and Gangaraj, S. (2000). A Posteriori Estimation and Adaptive Control of the Error in the Quantity of Interest, Part I: A Posteriori Estimation of the Error in the Von Mises Stress and the Stress Intensity Factors, *Computational Methods Applied Mechanical Engineering*, 181, 261-294
- Strouboulis, T., Babuska, I., and Gangaraj, S.K. (2000). Guaranteed Computable Error Bounds for the Exact Error in the Finite Element Solution, Part II: Bounds for the Energy Norm of the Error in two Dimension, *International Journal Numerical Method Engineering*,

- Wiberg, N.E., and Abdulwahab, F. (1992). An Efficient Post-Processing Technique for Stress Problems Based on Superconvergent Derivatives and Equilibrium, *In Numerical Methods in Engineering*, Hirsch, Periaux and Oñate Editors, Elsevier, 25-32
- Wiberg, N.B., and Li, X.D. (1993). A Post-Processing Technique and a Posteriori Error Estimate for the NEWMARK Method in Dynamic Analysis, *Earthquake Engineering. Structural Dynamic*, 22, 465-489
- Wunderlich, W., Cramer, H., and Steinl, G. (1998). An Adaptive Finite Element Approach in Associated and Non-Associated Plasticity Considering Localization Phenomena, *In Advances in Adaptive Computational Methods in Mechanics*, 293-308, Ladeveze and Oden Editors, Elsevier
- Zienkiewicz, O.C., Wood, W., Hine, N., and Taylor, R. (1984). A Unified Set of Single Step Algorithms. Part I: General Formulation and Applications, *International Journal Numerical Method Engineering*, 20, 1529-1552
- Zienkiewicz, O.C., and Xie, Y. (1991). A Simple Error Estimator and Adaptive Time Stepping Procedure for Dynamic Analysis, *Earthquake Engineering Structural Dynamic*, 20, 871-887
- Zienkiewicz, O.C., and Zhu, J.Z. (1992). The Superconvergent Patch Recovery and a Posteriori Error Estimates. Part I: The Recovery Technique, Part II: Error Estimates and Adaptivity, *International Journal Numerical Method Engineering*, 33, 1331-1382