



HAL
open science

Towards the development of an optical lattice clock using bosonic isotopes of mercury

Clara Zyskind, Manuel Andia, Changlei Guo, S. Bize

► **To cite this version:**

Clara Zyskind, Manuel Andia, Changlei Guo, S. Bize. Towards the development of an optical lattice clock using bosonic isotopes of mercury. IEEE IFCS-EFTF 2023, Jun 2023, Toyama, Japon, Japan. hal-04505900

HAL Id: hal-04505900

<https://hal.science/hal-04505900>

Submitted on 15 Mar 2024

HAL is a multi-disciplinary open access archive for the deposit and dissemination of scientific research documents, whether they are published or not. The documents may come from teaching and research institutions in France or abroad, or from public or private research centers.

L'archive ouverte pluridisciplinaire **HAL**, est destinée au dépôt et à la diffusion de documents scientifiques de niveau recherche, publiés ou non, émanant des établissements d'enseignement et de recherche français ou étrangers, des laboratoires publics ou privés.

Motivations and applications

- Metrology (redefinition of the SI second)
- Study variations of fundamental constants (fine structure constant α)
- Search for physics beyond the standard model (Dark Matter)
- Tests of General Relativity (equivalence principle, gravitational redshift)
- Applications in the field of chronometric geodesy

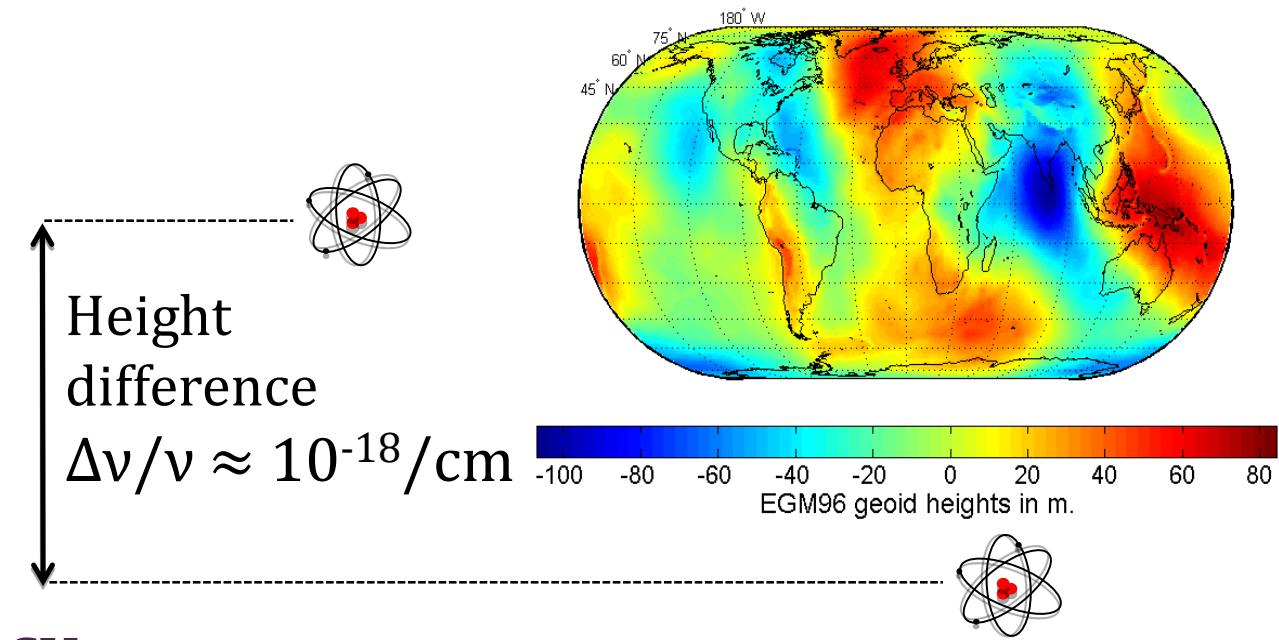

The choice of mercury

Exquisite properties for optical lattice clocks...

- Low sensitivity to black-body radiation shift (Yb/16, Sr/30)
 - Simple structure of the clock transition
 - High vapour pressure at room temperature (no oven, possibility for a 2D-MOT...)
 - 7 stable isotopes
 - Sensitive to variations of α
- ... that come at a price
- Deep-UV wavelengths hard to reach



Setup for quenching the bosonic transition

⇒ Goal : To produce high enough magnetic field to allow the bosonic transition with the highest coupling achievable

- External magnetic field \vec{B}_q obtained thanks to the 3D MOT coils in Helmholtz configuration and a switch mechanism to quickly reverse the current in one of the coils. Maximum field accessible in our setup : $B_q = 155 \times 10^{-4} T$
- Atoms are not ejected from the lattice when quenching is switched
- Residual magnetic field control system improved :
 - Zero of the magnetic field found and stable with a $1.5 \mu T$ precision
- Also an improved coupling between the probe laser and the atoms

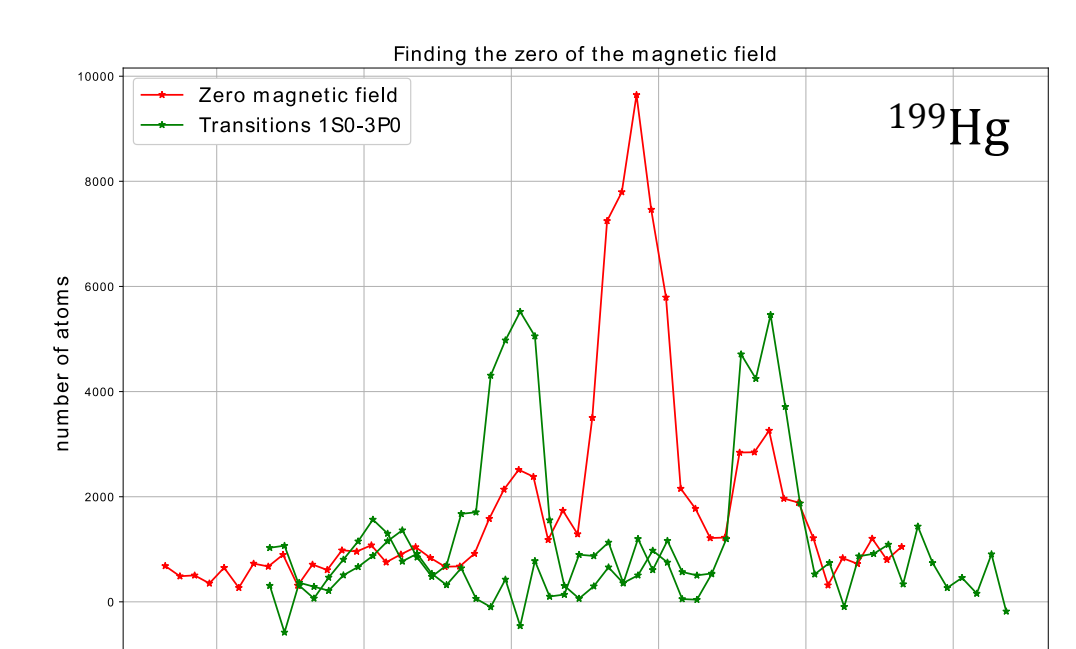
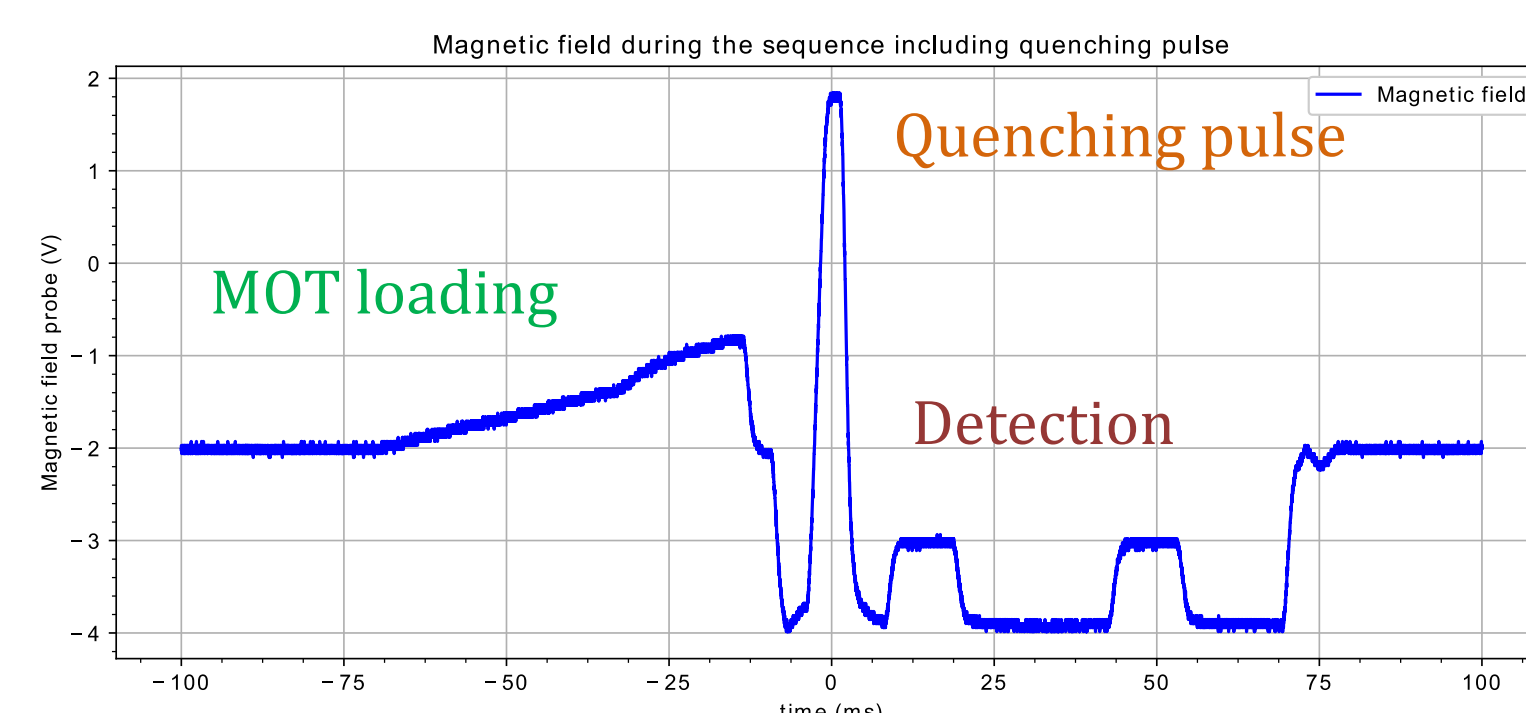
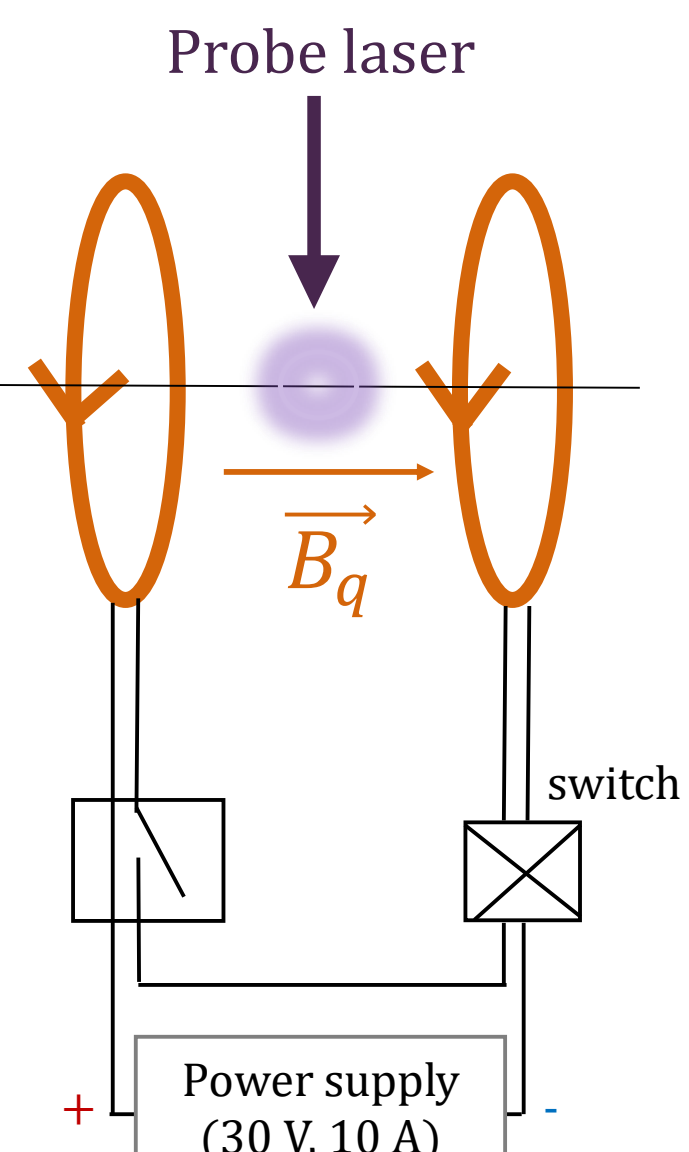

Experimental setup

- 10^6 atoms trapped in the 3D-MOT
- 1000 spin-polarised atoms in the lattice

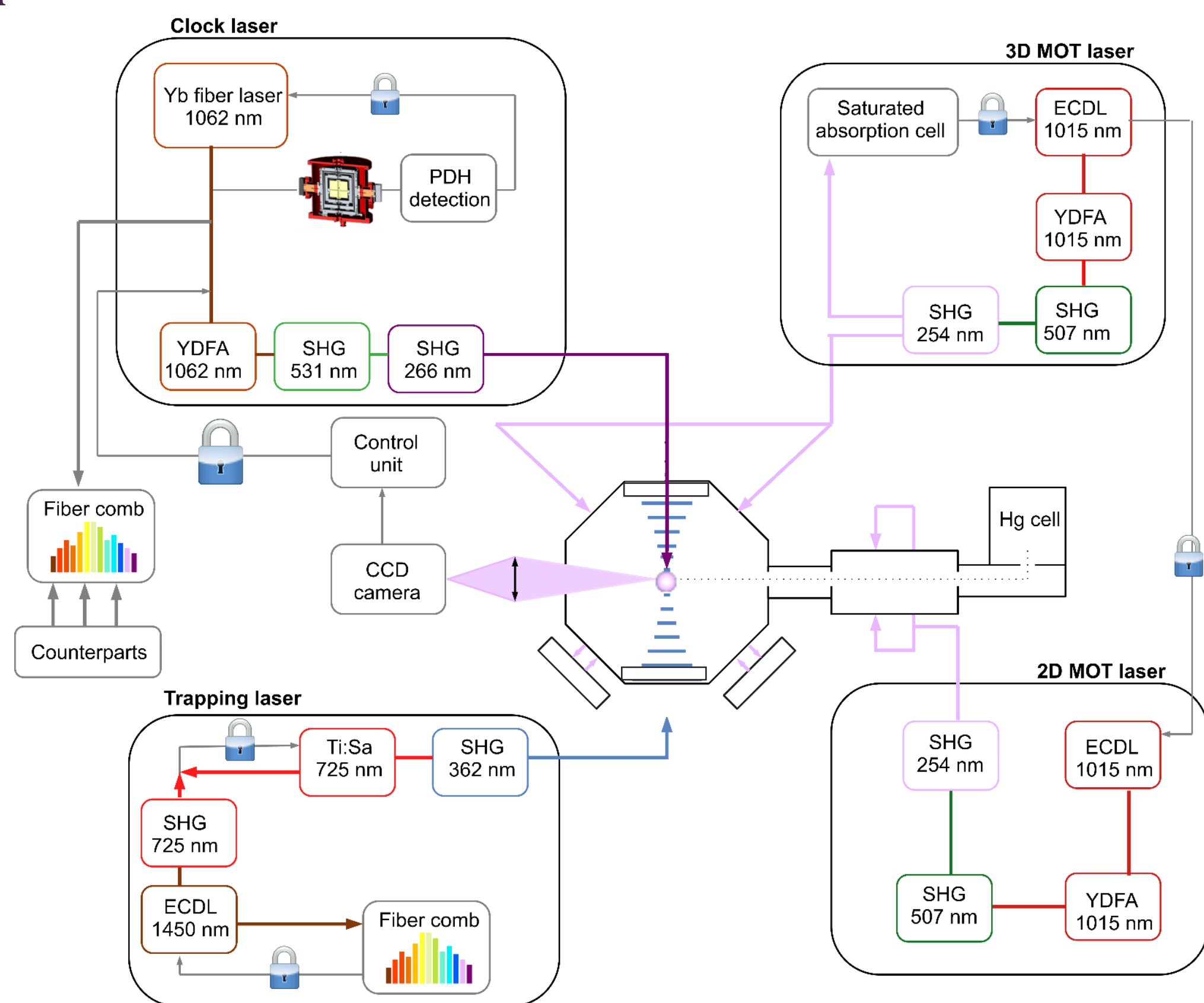

Setup to probe any of the mercury isotopes

⇒ Goal : To have a flexible ultrastable light which can probe any of the mercury isotopes (tuning of 10 GHz to access all transitions, fermions and bosons), with no additional noise

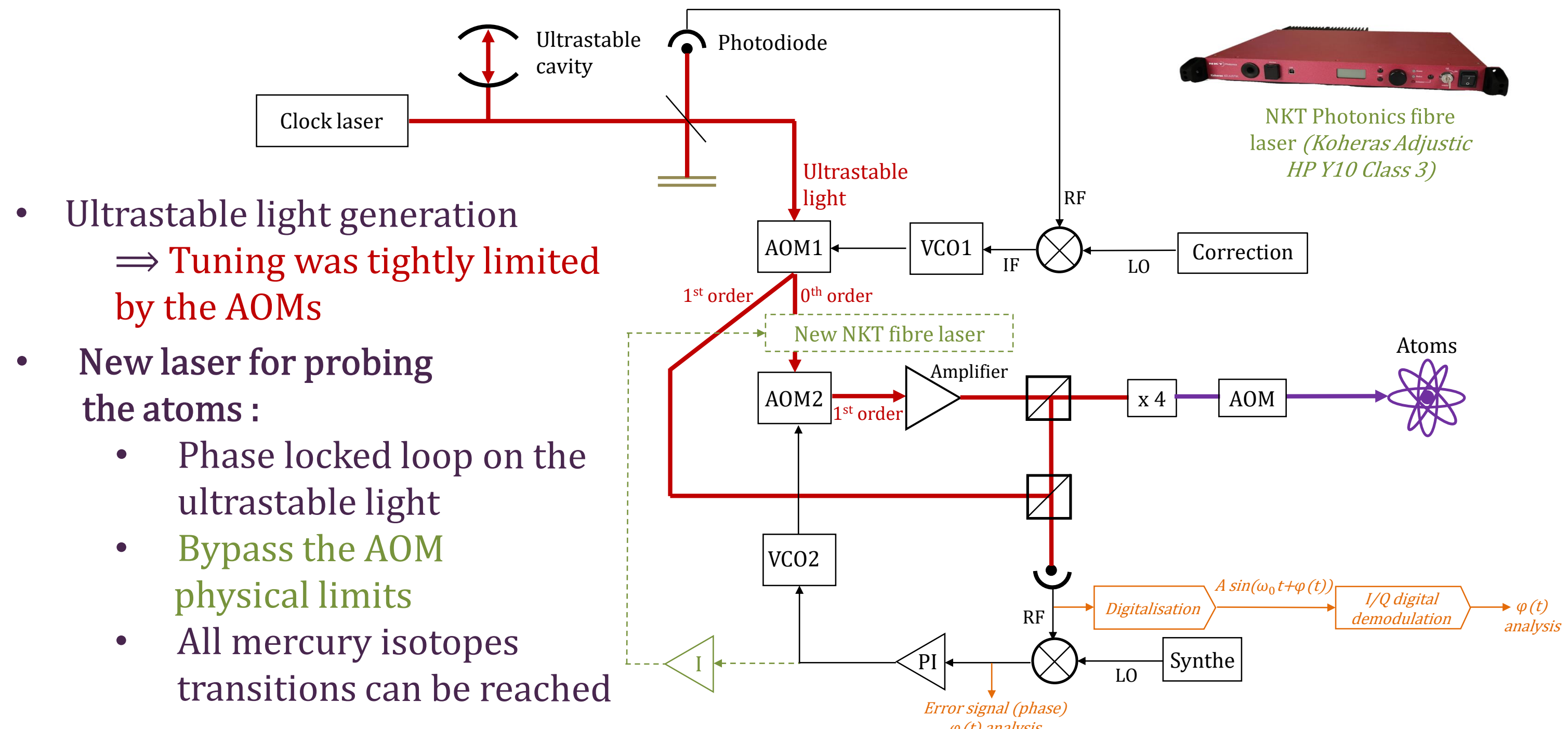

- Ultrastable light generation ⇒ Tuning was tightly limited by the AOMs
- New laser for probing the atoms :
 - Phase locked loop on the ultrastable light
 - Bypass the AOM physical limits
 - All mercury isotopes transitions can be reached

- New laser characterisation with 3 different methods :
 - Quasi free running laser and estimation of its linewidth is found to be 12.9 kHz
 - Error signal of the phase locked loop
 - Phase coherent analysis of optical beatnote

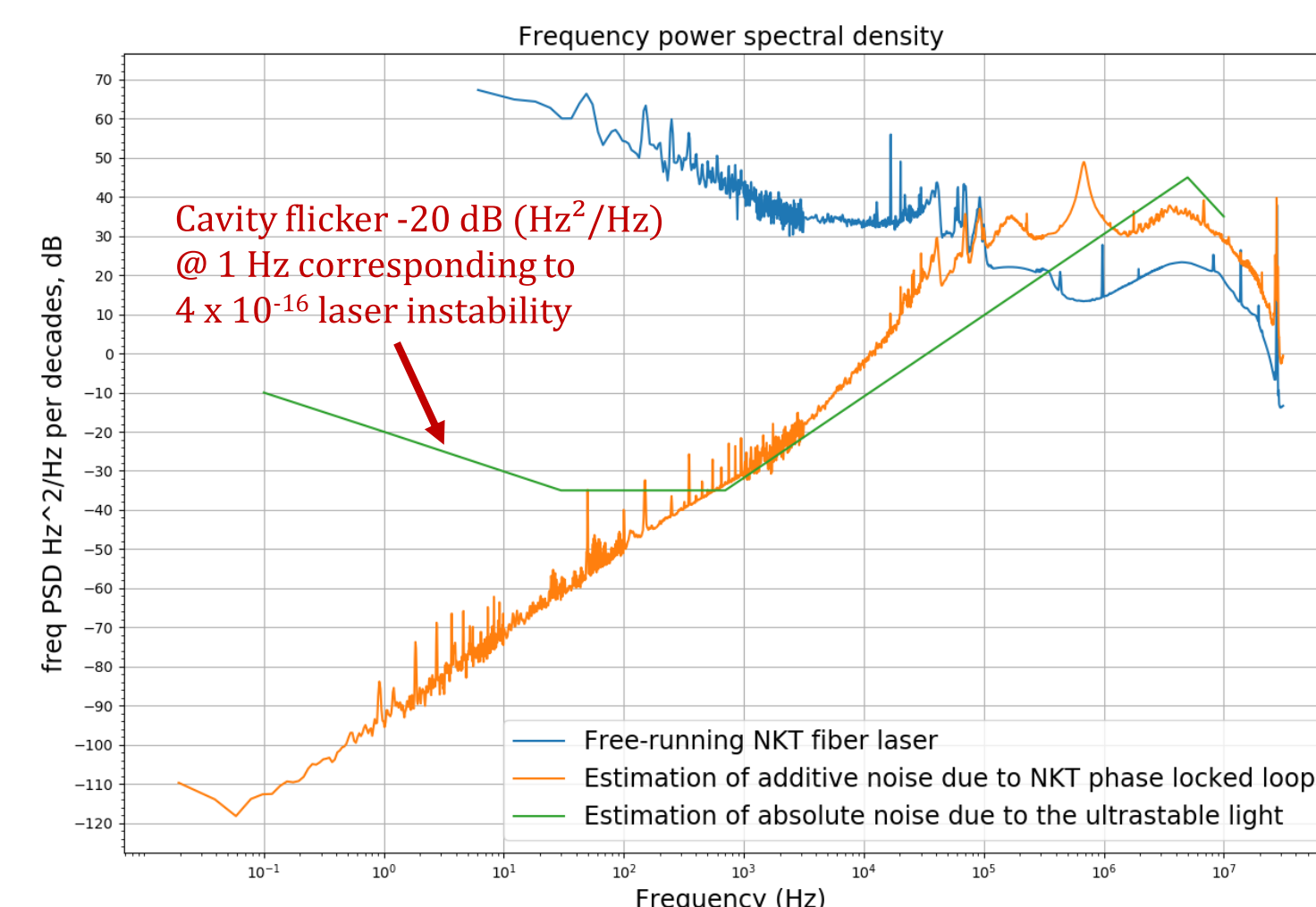

Green curve estimation of ultrastable light noise from [13].

- No significant additional noise at low frequencies for the new NKT fibre laser
 - Additive noise impact on clock is at the level of about 10^{-18} @1s via the Dick effect
- Power spectral density in range 1-100 Hz still defined by the cavity flicker noise

- Clock measurements with ^{199}Hg is giving good stabilities :

⇒ We can infer a stability @1s of about $8-9 \times 10^{-16}$ from curves on the right
 ⇒ Similar stabilities with the previous ultrastable laser scheme

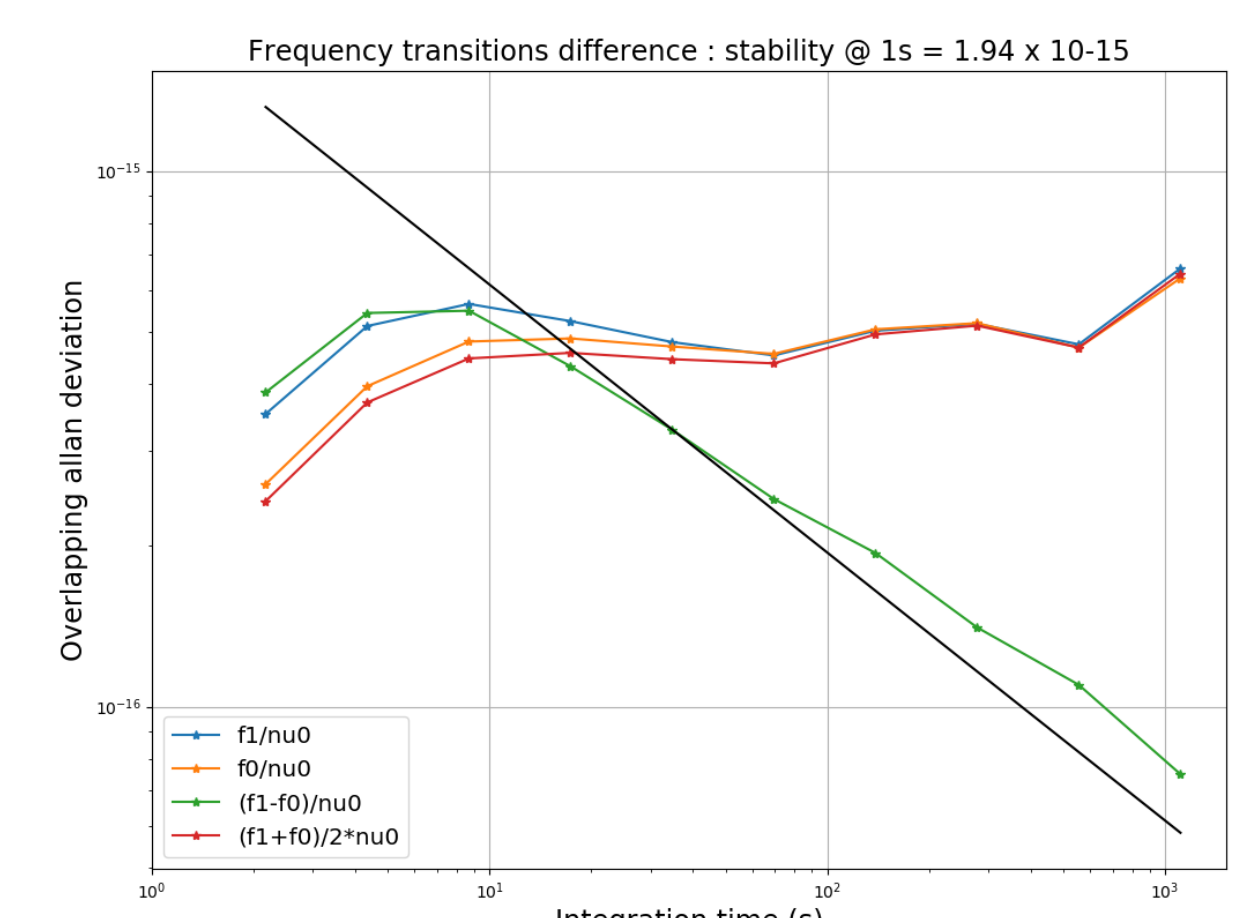

From fermionic isotopes to bosonic isotopes

Fermionic isotope ^{199}Hg

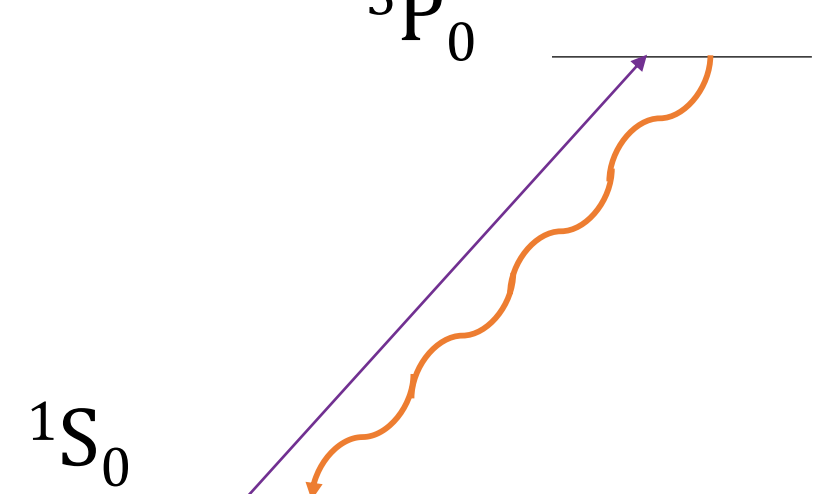

Bosonic isotope Ex : ^{198}Hg

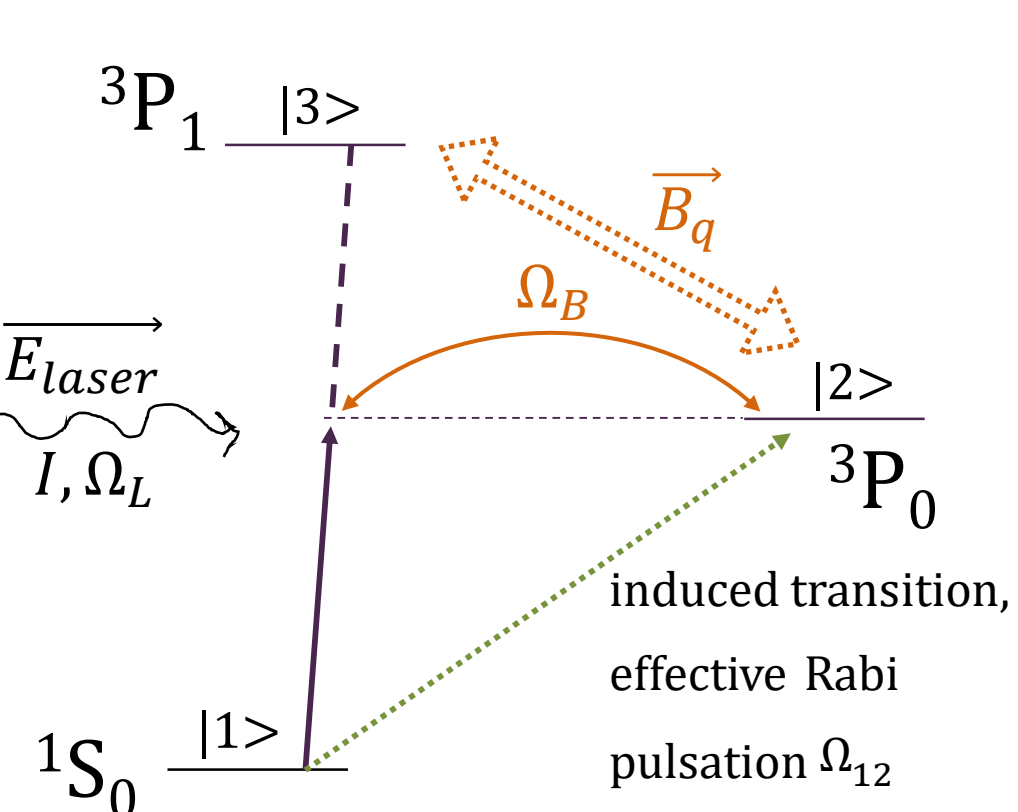

- Non zero nuclear spin
- Transition naturally allowed thanks to hyperfine mixing
- *But 3P_0 lifetime of $\sim 1,5 s$*
- *A limit to exploit new ultrastable lasers*
- Zero nuclear spin
- Forbidden transition but can be induced by an external magnetic field \vec{B}_q : « quenching »
- *Lifetime potentially unlimited and adjustable*
- *To be studied : High second order Zeeman shift and light shift*
- *Hyper Ramsey probing to circumvent them ?*

- Finding the bosonic clock transition (after [6])
 - High effective Rabi pulsation Ω_{12} needed ⇒ high magnetic field \vec{B}_q
 - Current experimental uncertainty for ^{198}Hg : 10.3 MHz [11]

^{198}Hg	Power [mW]	Intensity I [W/cm ²]	Magnetic field B [10 ⁻⁴ T]	Second order Zeeman shift $\frac{\Delta E}{2\pi}$ [10 ⁻¹⁴]	Rough estimate of the light shift $\frac{\Delta_L}{2\pi}$ [10 ⁻¹⁴]	Effective Rabi pulsation (low estimate) $\frac{\Omega_{12}}{2\pi}$ [Hz]
High coupling	1	1.59	155	-52.5	1.6	38.0
	0.1	0.159	155	-52.5	0.16	12.0

Figure of merit : $\xi = \frac{\Omega_{12}}{\sqrt{\Delta_L \Delta_B}}$
 ⇒ characterises the strength of the excitation compared to the field shifts

	Yb	Sr	Ca	Mg	Hg (estimation)
ξ	0.60	0.30	0.28	0.28	0.36

References

- [1] W.F. McGrew et al., *Nature*, p.1, 11 (2018)
- [2] A. D. Ludlow et al., *Review of Modern Physics*, 87, 7(2015)
- [3] S. Bize, *Comptes Rendus Physique*, 20, 1 (2019)
- [4] R. Tyumenov et al., *New Journal of Physics*, 18, 11 (2016)
- [5] K. Yamanaka et al., *Physical Review Letters*, 114, 238001 (2015)
- [6] A. V. Taichenachev et al., *Physical Review Letters*, 96, 3,(2006)
- [7] S. Origlia et al., *Physical Review A*, 98, 11 (2018)
- [8] S. Falke et al., *New Journal of Physics*, 16, 073023 (2014)
- [9] J. Lodewyck et al., *Metrologia*, 53, 1123,(2016)
- [10] N. Huntemann et al., *Physical Review Letters*, 116, 063001 (2016)
- [11] A. Kramida, *J. Res. Natl. Inst. Stand. Technol.*, 116, 599-619 (2011)
- [12] M. Andia et al., *Presentation at IFCS, 2020.*
- [13] S.T. Dawkins et al., *Appl Phys B*, 99, 41-46 (2010)
- [14] C. Guo et al., *Physical Review A*, 107, 033116 (2023)