



**HAL**  
open science

# Design and Implementation of BPSK Modulation Using USRP for IoT Healthcare

Namarig Mohemed Taha Abdelrahman Ahmed, Julio Cesar, Iyad Dayoub,  
Amin Babiker, Ahmed M.Alhassan, El Hadj Dogheche

► **To cite this version:**

Namarig Mohemed Taha Abdelrahman Ahmed, Julio Cesar, Iyad Dayoub, Amin Babiker, Ahmed M.Alhassan, et al.. Design and Implementation of BPSK Modulation Using USRP for IoT Healthcare. Mardi des chercheurs, Jun 2023, Valenciennes, France. hal-04504541

**HAL Id: hal-04504541**

**<https://hal.science/hal-04504541>**

Submitted on 7 Apr 2024

**HAL** is a multi-disciplinary open access archive for the deposit and dissemination of scientific research documents, whether they are published or not. The documents may come from teaching and research institutions in France or abroad, or from public or private research centers.

L'archive ouverte pluridisciplinaire **HAL**, est destinée au dépôt et à la diffusion de documents scientifiques de niveau recherche, publiés ou non, émanant des établissements d'enseignement et de recherche français ou étrangers, des laboratoires publics ou privés.



# Design and Implementation of BPSK Modulation Using USRP for IoT Healthcare

Namarig Mohamed Taha, Julio Cesar, Iyad Dayoub, Amin Babiker, Ahmed Mohamed Alhassan, & El Hadj Dogheche  
 Universit Polytechnique Hauts de France (UPHF), Institut Electronique Microelectronique et Nanotechnologie IEMN UMR 8520 CNRS Le Mont Houy  
 Valenciennes, France. [Namarig.MohamedTahaAbdelrahman@uphf.fr](mailto:Namarig.MohamedTahaAbdelrahman@uphf.fr)  
 University Al-Neelain, Sudan.

## Introduction

WBANs for IoT healthcare typically comprise a sensor node, a microcontroller, and a communication module. These sensors can sense real-time events and Transmit sensor data to a base station through wireless transmission[1]. Consequently, a dependable communication system is critical for delivering an appropriate base station without error. One of the primary concerns for receiving a signal at its destination is the modulator's reliability and accuracy [2].

## Objectives

1. Investigate the better modulator reliability and accuracy modulation scheme in WBAN.
2. Test different modulation techniques (BPSK, QPSK, and GMSK) to obtain the highest data rate for the WBSN.
3. Choose the best modulation that can be used in the IoT e-health application.

## Materials and Methods

We used the USRP B200mini device with the help of MATLAB and GNU Radio software to implement the BPSK modulation scheme. The BPSK modulator takes in a binary input stream and maps it onto a phase shift keying constellation. The modulated signal is then transmitted through the USRP device using an antenna. On the receiver side, the signal is received by another USRP device and demodulated to recover the original binary data. We evaluated the performance of our system in terms of bit error rate (BER) and signal-to-noise ratio (SNR) using a simulated channel with AWGN (Additive White Gaussian Noise) and compared it with the theoretical values.

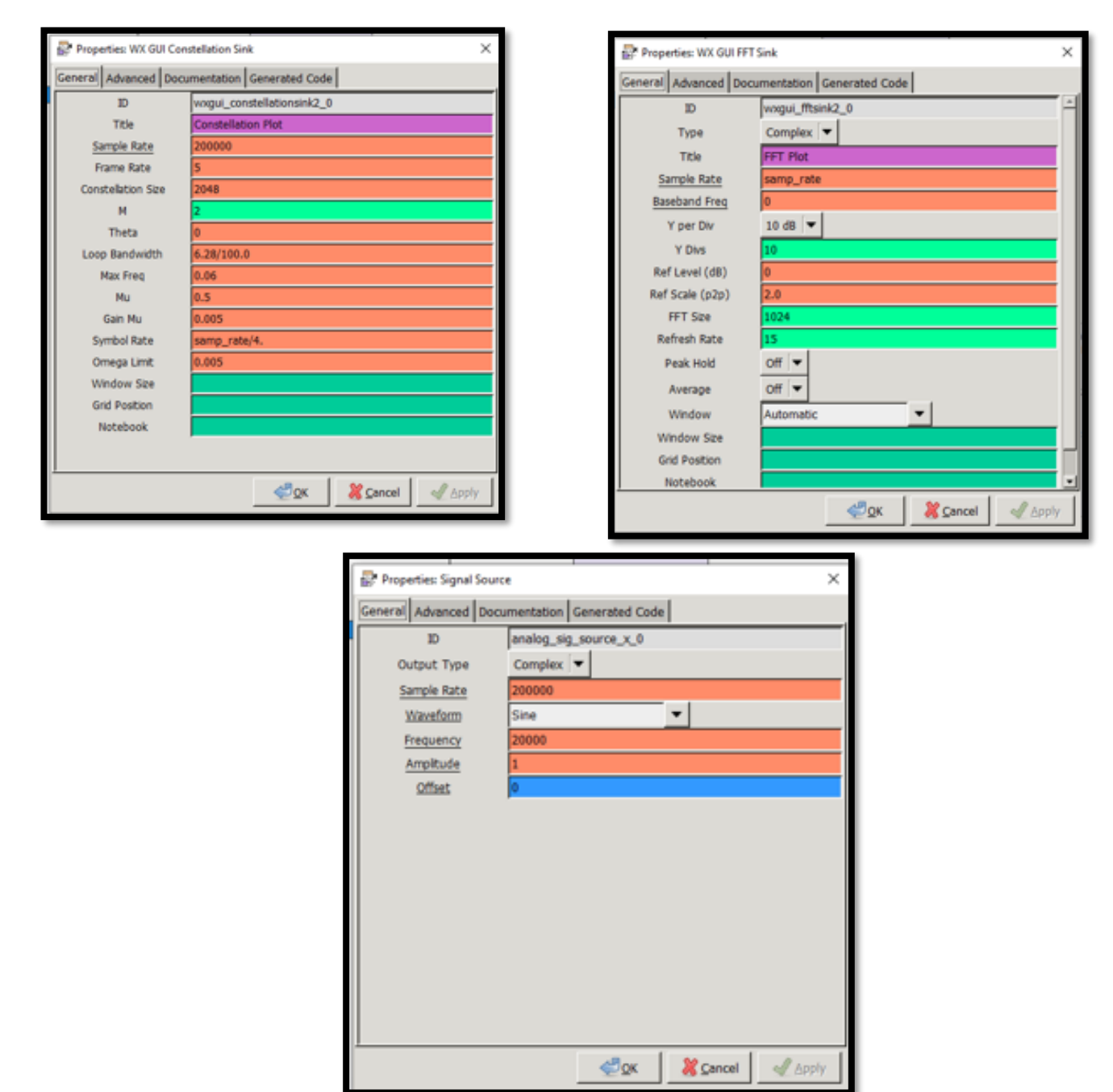
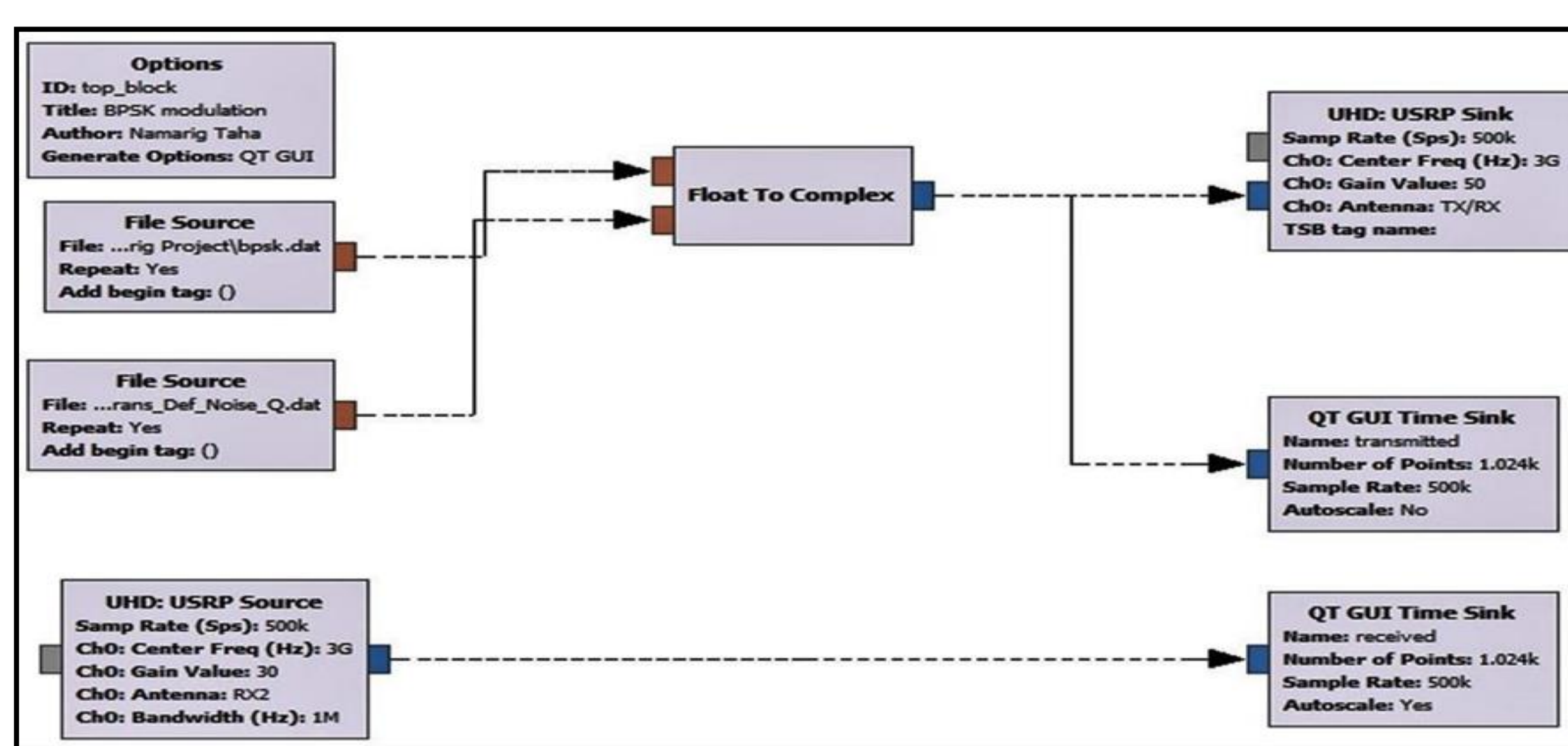
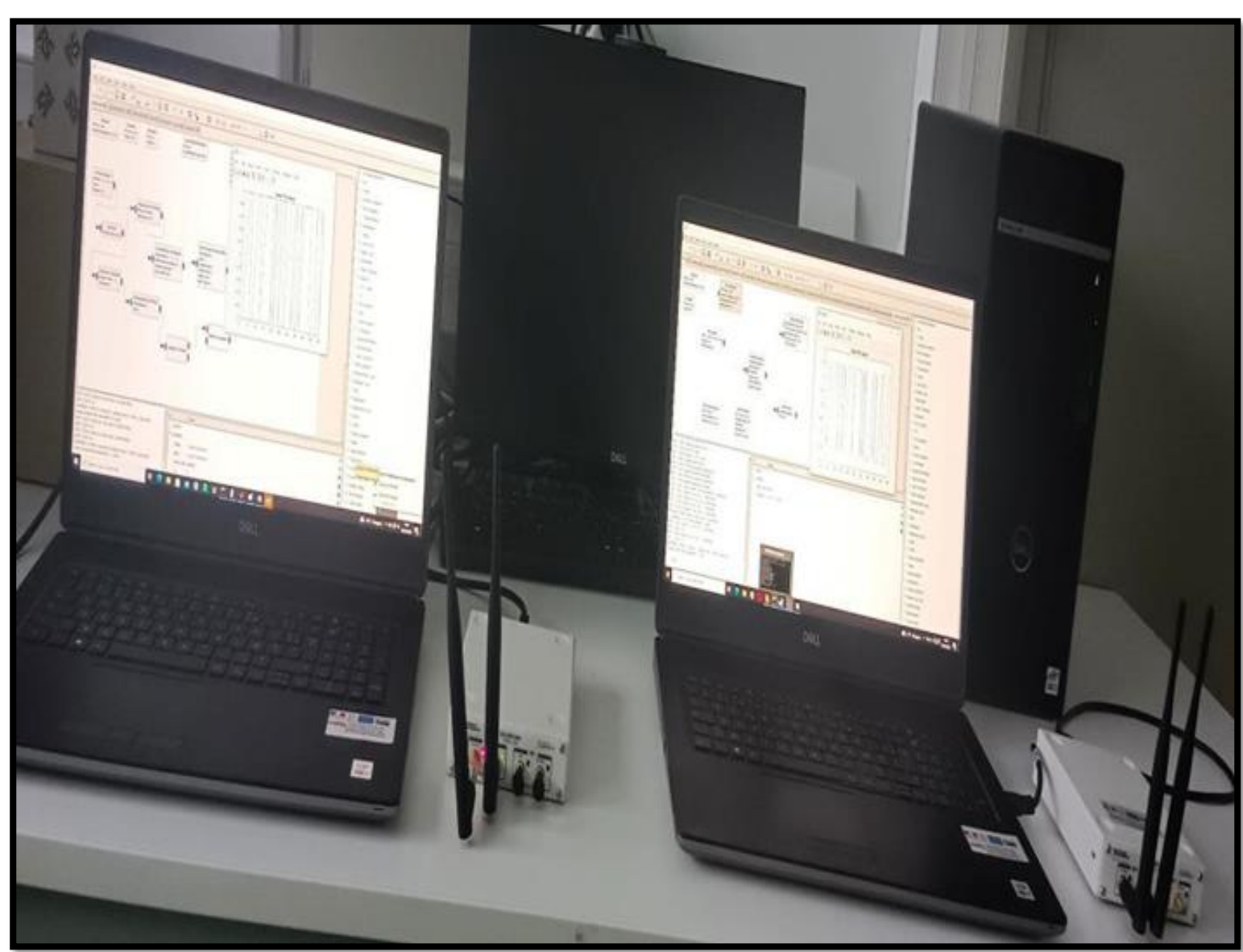

Fig. 1: Schematic Diagram for complete BPSK implementation

## Results and Discussion

The performance of BPSK modulation is shown in Figure (8), with the BER decreasing rapidly as the SNR increase until it reaches a minimum value, which is affected by the modulation scheme, channel characteristics, and receiver design. Our implementation has effectively attained a minimum bit error rate (BER) and higher signal-to-noise ratio (SNR) values, indicating the reliability and efficiency of the communication system. Moreover, implementation demonstrates robustness against radio-frequency interference, ensuring improved quality in transmitting medical information.

### - BPSK signal using raised cosine filtering

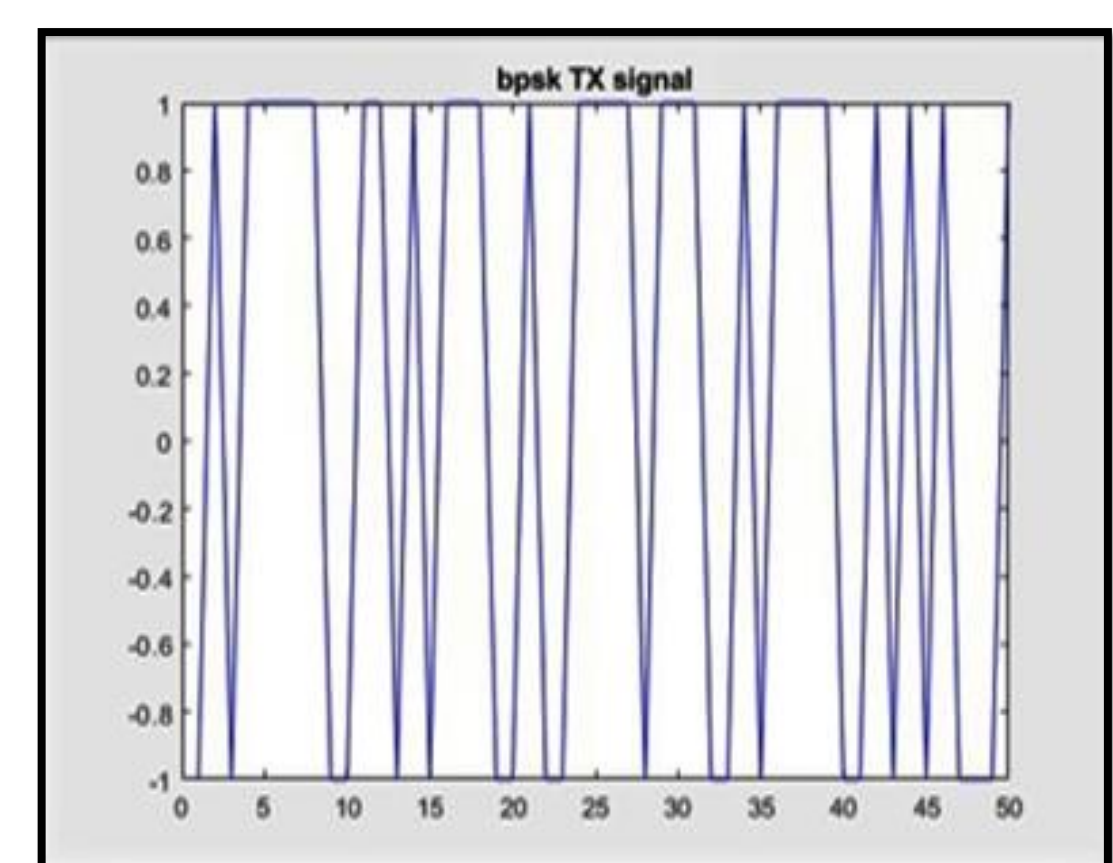

Fig. 2: BPSK transmit Signal

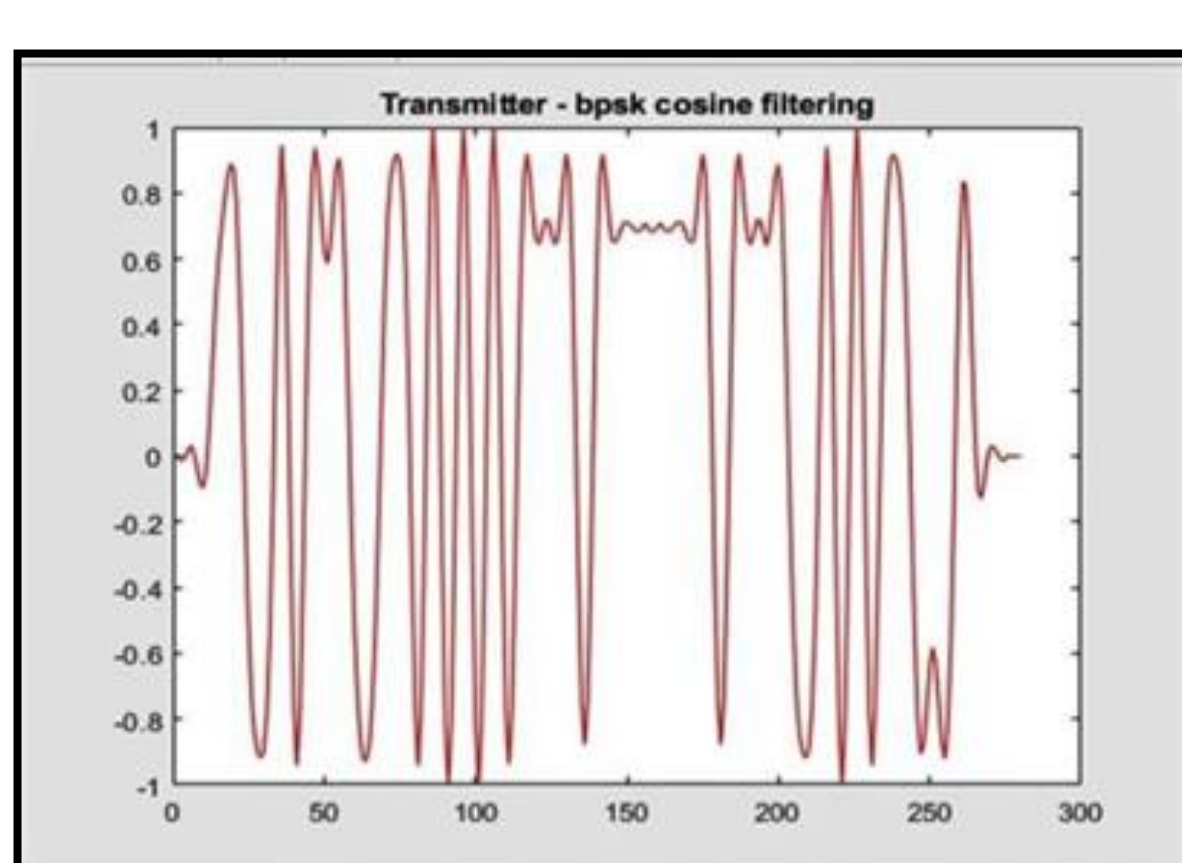

Fig. 3: BPSK cosine filtering

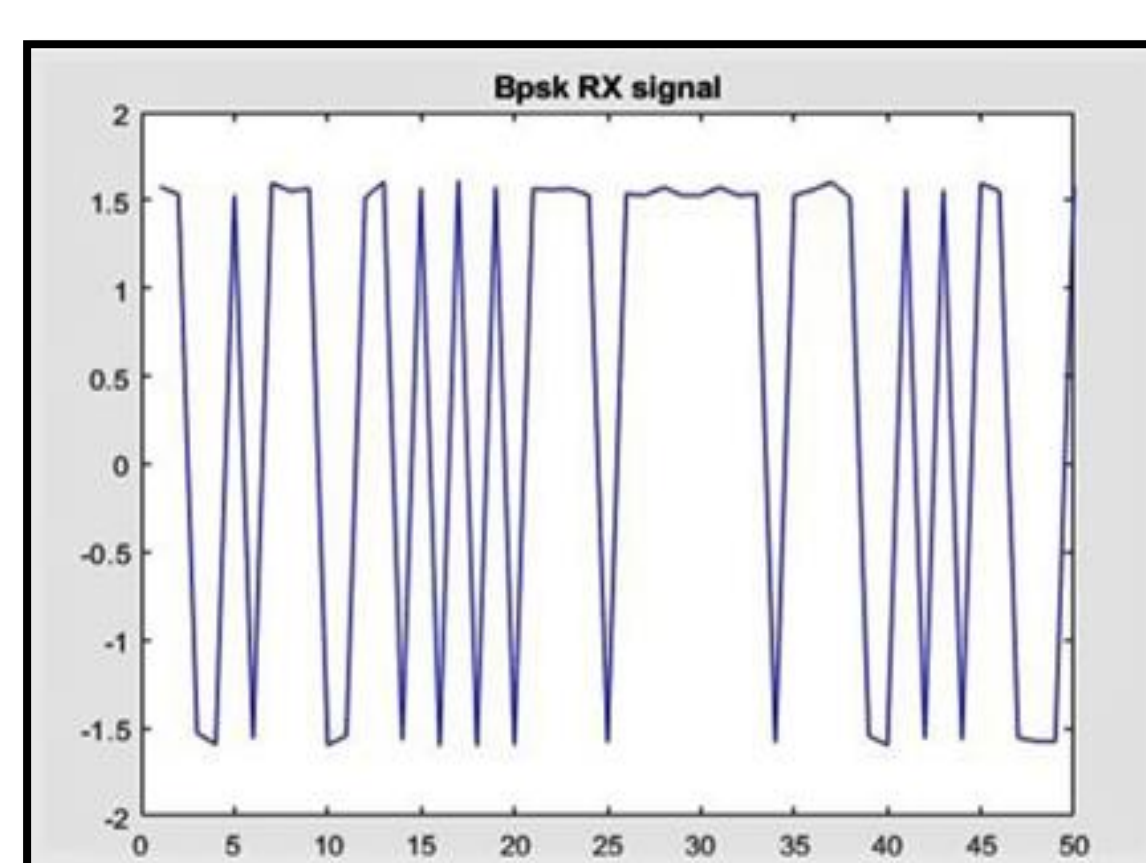

Fig. 4: BPSK received signal

### - BPSK Implementation in real-time

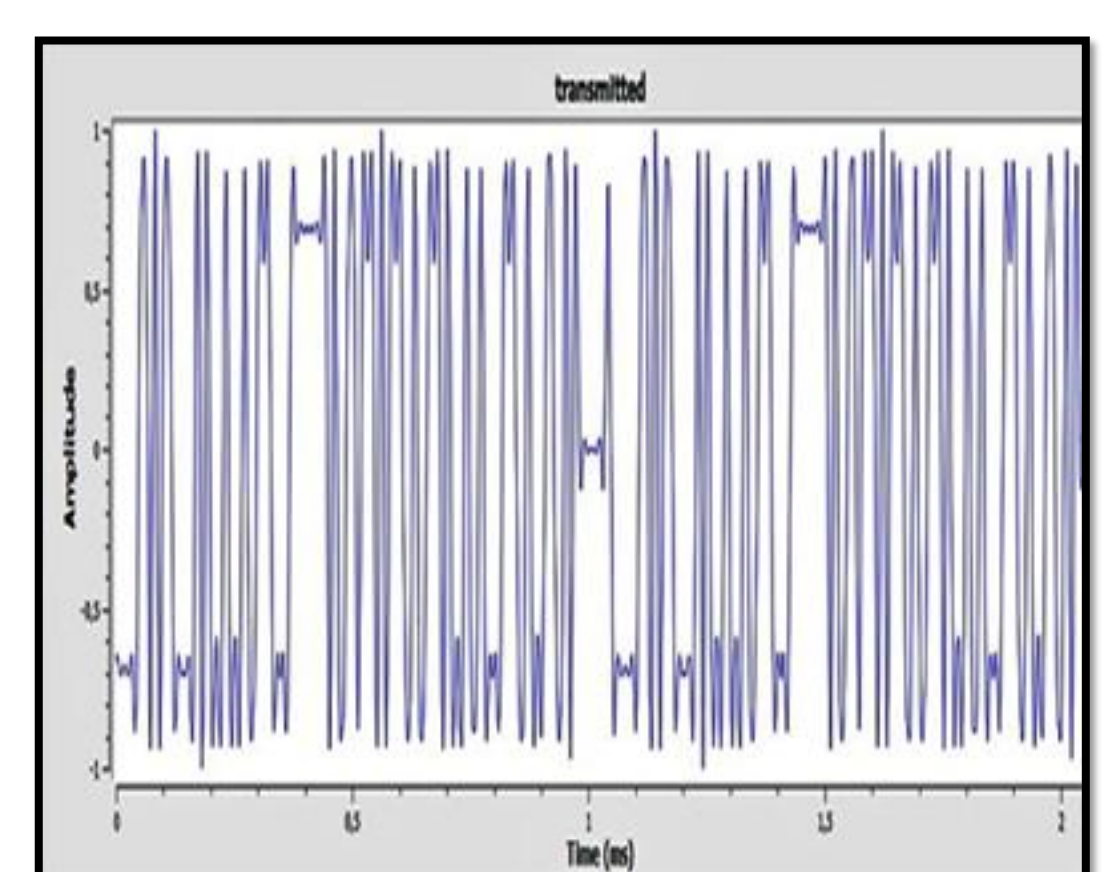

Fig. 5: Transmit signal

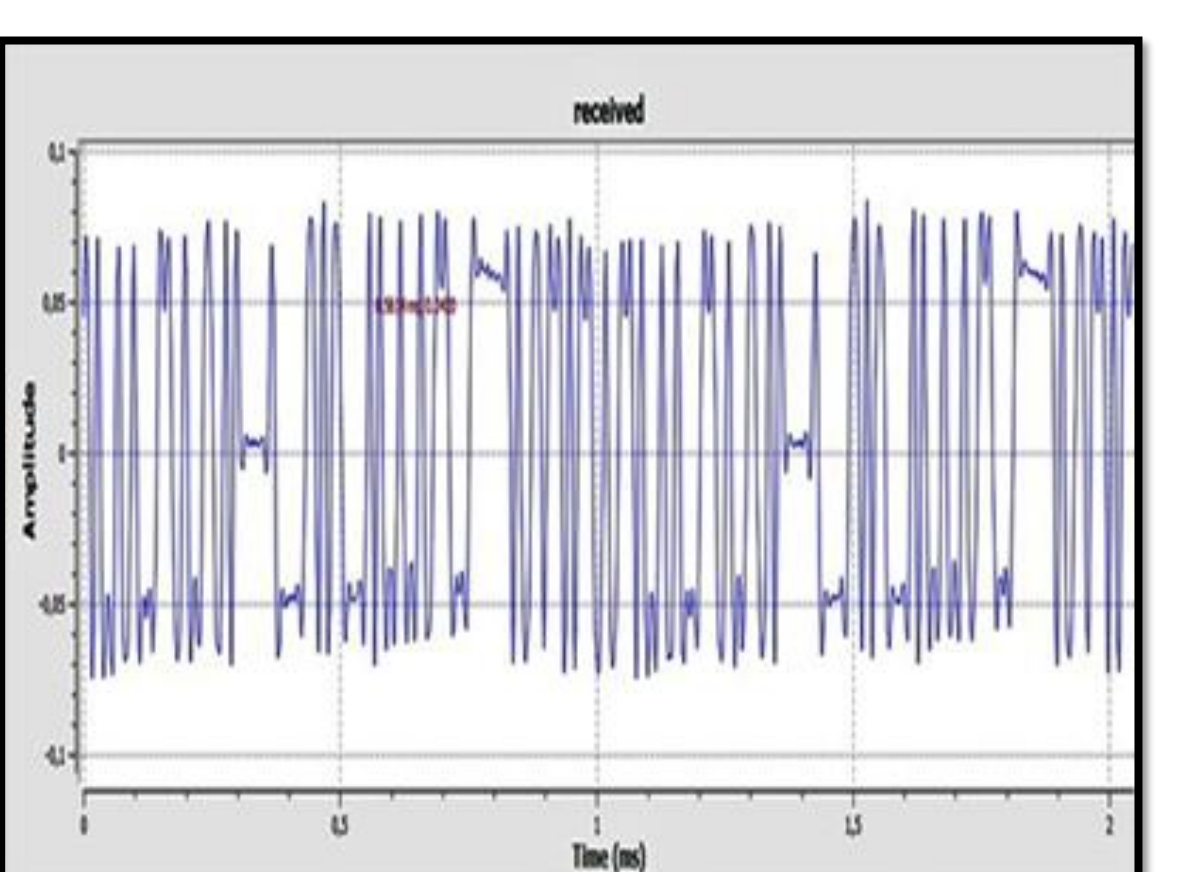

Fig. 6: Received signal

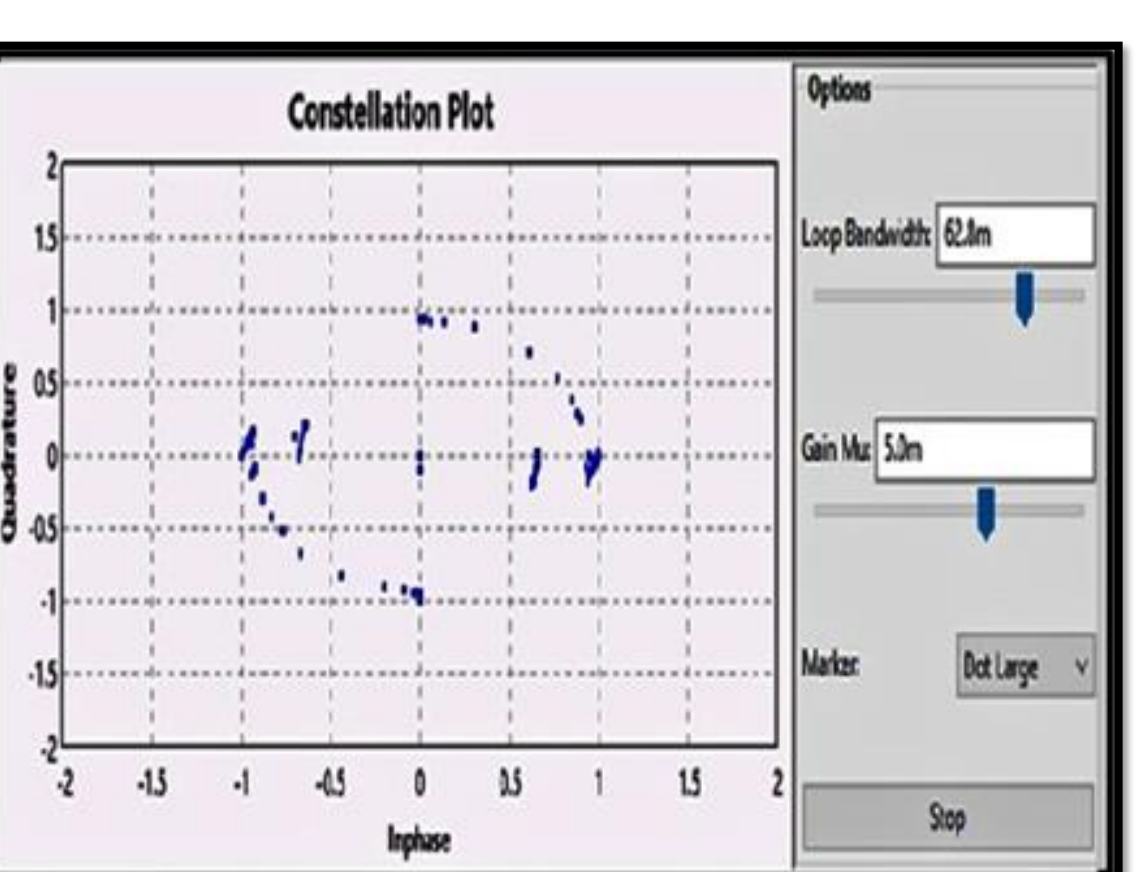

Fig. 7: Constellation plot

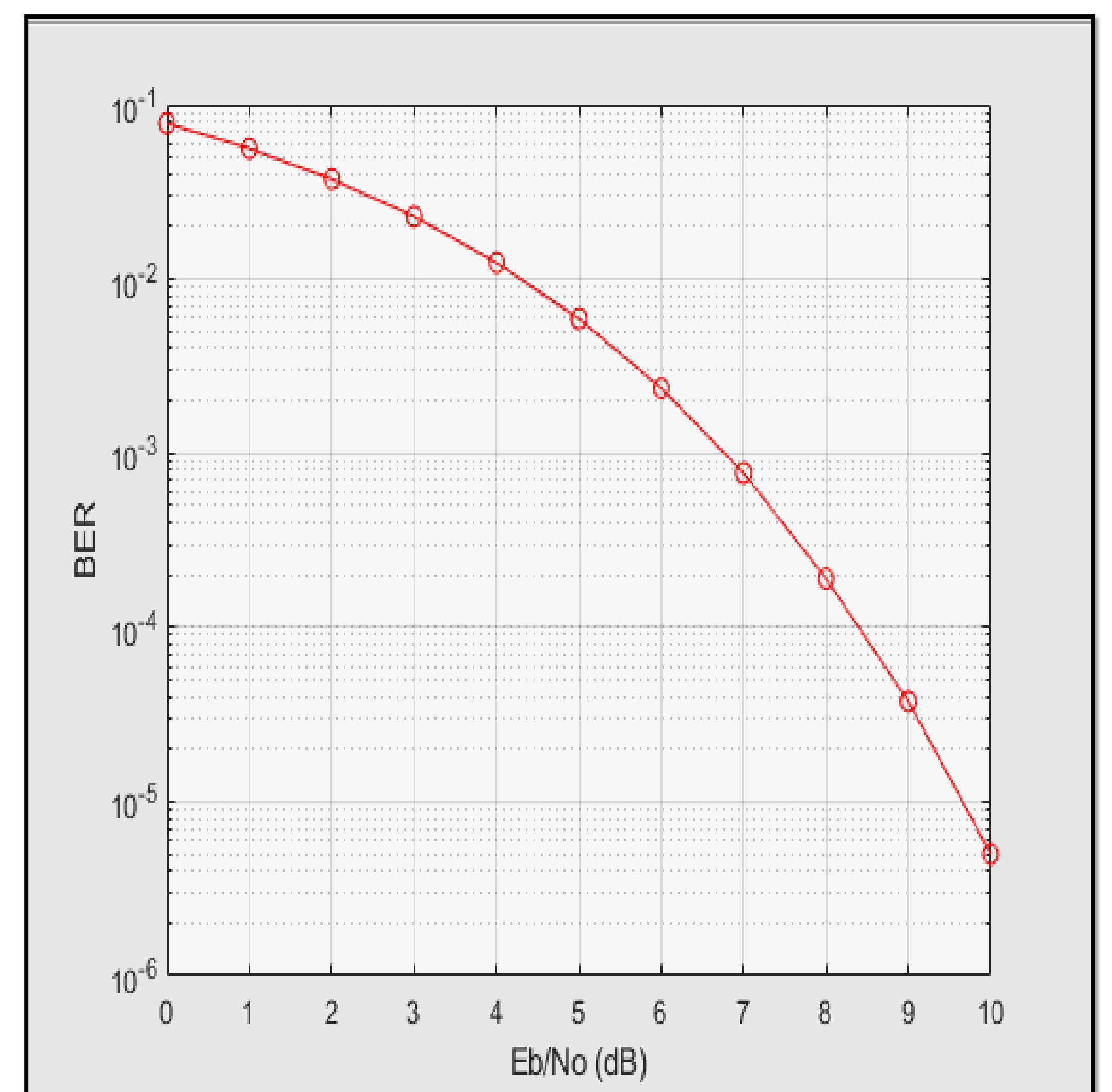

Fig. 8: BER vs SNR

## Conclusion

BPSK modulation with USRP offers a dependable and efficient approach for transmitting data over short distances while consuming minimal power. This system was tested in a laboratory environment and successfully transmitted and received medical data with a low bit error rate. We also demonstrated the ability to adapt to changing environments and interference by adjusting the receiver's gain and frequency. From Figure 6, 7, because we used an attenuator, ideal channel, and raised cosine filtering (to avoid spectral spreading), we can observe that the symbol error rate =0 and PDR =100%, which is very important in IoT eHealth applications.

## Acknowledgment

This research is supported by the Ministry of Higher Education, Research of the Republic of Sudan, Al-Neelain University, a French government scholarship, and the France Embassy in Sudan.

## References

- [1] PMP Joshi, SA Patil, and DC Shimpi. Design and implementation of bpsk audio transceiver using sdr. International Journals of Advanced mitter & re- Research in Computer Science and Software Engineering, 7(6):268-271, 2017.
- [2] Md Ershadul Haque and Md Sanwar Hossain. Reliability and accuracy analysis of bpsk and qam modulation scheme for assessing structural health data. European Journal of Scientific Research, 127(1):75-86, 2014