



HAL
open science

Study of gas pressure and flow rate influences on a 500W PEM fuel cell, thanks to the experimental design methodology

B. Wahdame, D. Candusso, Jean-Marie Kauffmann

► **To cite this version:**

B. Wahdame, D. Candusso, Jean-Marie Kauffmann. Study of gas pressure and flow rate influences on a 500W PEM fuel cell, thanks to the experimental design methodology. *Journal of Power Sources*, 2006, 156 (1), pp.92-99. 10.1016/j.jpowsour.2005.08.036 . hal-04493608

HAL Id: hal-04493608

<https://hal.science/hal-04493608v1>

Submitted on 7 Mar 2024

HAL is a multi-disciplinary open access archive for the deposit and dissemination of scientific research documents, whether they are published or not. The documents may come from teaching and research institutions in France or abroad, or from public or private research centers.

L'archive ouverte pluridisciplinaire **HAL**, est destinée au dépôt et à la diffusion de documents scientifiques de niveau recherche, publiés ou non, émanant des établissements d'enseignement et de recherche français ou étrangers, des laboratoires publics ou privés.

Study of gas pressure and flow rate influences on a 500W PEM fuel cell thanks to the experimental design methodology

B. Wahdame*, D. Candusso**, Jean-Marie Kauffmann*

* Laboratory of Electrical Engineering and Systems (L2ES) – EA 3898
University of Technology Belfort-Montbéliard (UTBM) & University of Franche-Comté (UFC)
L2ES-UTBM Bâtiment F, Technopôle – Rue Thierry Mieg, F 90010 BELFORT, France
E-mail: bouchra.wahdame@utbm.fr
Phone: 0033 (0)3 84 58 36 25
Fax: 0033 (0)3 84 58 36 36

** The French National Institute for Transport and Safety Research (INRETS)
Laboratory of New Technologies (LTN)
2 avenue du Général Malleret-Joinville, F 94114 Arcueil Cedex, France

Abstract-- The behaviour of a 500W PEM fuel cell stack, fed by pure hydrogen and humidified compressed air, is currently investigated on the fuel cell test platform of Belfort.

In this paper, the influences on the fuel cell performances of the gas pressure and flow rate parameters are studied. The fuel cell is operated in the pressure regulation mode: the gas flow rates are regulated thanks to mass flow controllers placed upstream of the stack and the gas pressures at stack inlets are controlled by regulation valves located downstream of the stack. The choice of the various tests to perform is made thanks to the experimental design methodology, which is a suitable technique to characterise, analyse and to improve a complex system such a fuel cell generator. In this study, the four physical factors considered are both hydrogen / air pressures and anode / cathode flow rates. Each factor has two levels, leading to a full factorial design requiring 16 experiments (16 current – voltage curves). The test bench developed at the laboratory allows setting the other factors (for instance: stack temperature, relative humidity and dew point temperature of the air at stack inlet) at fixed values. The test responses are the maximal output power and the efficiency computed for this power. Statistical sensitivity analyses (ANOVA analyses) are used to compute the effects and the contributions of the various factors to the fuel cell maximal power. The use of fractional designs shows also how it is possible to reduce the number of experiments. Some graphic representations are employed in order to display the results of the statistical analyses made for different current values.

Index Terms-- PEMFC, experimental design, Taguchi method, ANOVA.

INTRODUCTION

P ROTON Exchange (or Polymer Electrolyte) Membrane Fuel Cell (PEMFC) is considered as being one of the most promising technologies able to produce efficient and environmentally friendly energy for various applications. More and more attention is paid to PEMFC for powering electric vehicles especially because of its low temperature operation and its high power density. Nevertheless, PEMFC is not yet an economical solution for the transportation market area and some research have still to be led in order to reduce the FC generators costs, to improve their reliability as well as to find some solutions for the hydrogen distribution.

The L2ES laboratory based on the fuel cell test platform of Belfort is currently carrying research on a 500W PEMFC stack. The aim is to ensure for the FC proper and optimal operating conditions, leading to high power or efficiency delivery. This task is not easy especially because of the high number of control parameters such as: FC temperature, gas pressure, gas flow, relative humidity of hydrogen and air, profile of the load current... All these parameters have strong impacts on the FC voltage and are related among themselves by nonlinear relations, difficult to be modelled. Their values depend on the technological choices made for the ancillaries (for instance, the air pressure and flow levels are linked to the selected type of compressor and to its

characteristics).

A large number of experimental tests are often needed to correctly analyse the performances of a given FC system or to identify the parameters of a physical model. The Design of Experiment (DOE) method can be used in order to evaluate the respective impacts of the physical control parameters on the FC operation. The DOE method dates in fact back to the beginning of the last century with the work from Fisher (1925). The first users of these methods were agronomists who quickly included the interest of the experimental designs, in particular the possible reduction of the number of tests when many parameters are studied. In the Sixties, the DOE brought many innovations, mainly thanks to the work done by Doctor Genichi Taguchi [1]. This methodology is sometimes used by chemists [6] in order to characterise the fuel cell and its materials, to determine the most significant parameters, or to highlight the possible correlations between these ones.

In our work, DOE tests have been conducted with two objectives: to obtain the maximum of the power produced by the fuel cell and to reach the maximum of the fuel cell efficiency for given ranges of air / hydrogen flows and pressures. Experiment results are given and analysed in this paper.

I. EXPERIMENTAL SETUP

The PEMFC used in this study has been assembled with a sprayed catalyst layer (Gore MESA Primea Series 5510) and graphite distribution plates. Some data on the fuel cell are given in table I.

Table. I. Technical specifications of the fuel cell

Number of cells	20
Cell area	100cm ²
Operating temperature	20 to 65°C
Operating pressure	Max. 1.5bars _{abs} (0.5bars _{relative})
Nominal power output	500W
Operating power	0 to 800W
Media inlet	
Cathode	Humidified air
Anode	Pure hydrogen (dry)
Cooling	Demineralised water

In order to achieve the objectives of this study, we have adapted the DOE method to the available testbench in our laboratory (Fig. 1). The 500W stack was operated at atmospheric pressure with humidified air (dew point temperature of 25°C and relative humidity of 75% at stack inlet) and dry hydrogen. The air and hydrogen flows were controlled by flow regulators placed upstream of the stack. The pressures at stack inlets were controlled thanks to back pressure valves located downstream of the stack. The stack temperature was regulated at 55°C.

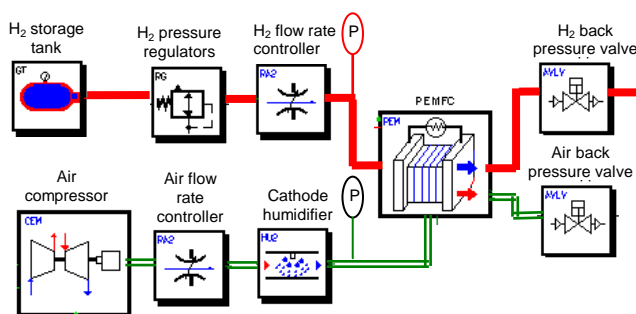

Fig. 1. Simplified scheme of the fuel cell testbench

During each one of the 16 tests, hydrogen and air flow rates were kept constant. For example, during the experiment presented below (Fig. 2), their values were respectively 8.5nl/min and 39.6nl/min. The hydrogen and air pressures were controlled progressively as the current was incremented by 5A or 2A steps. The output power increased progressively and so did the voltage drop of the stack. When any one of the 20 cell voltages was reaching the threshold of 380mV, the test was stopped.

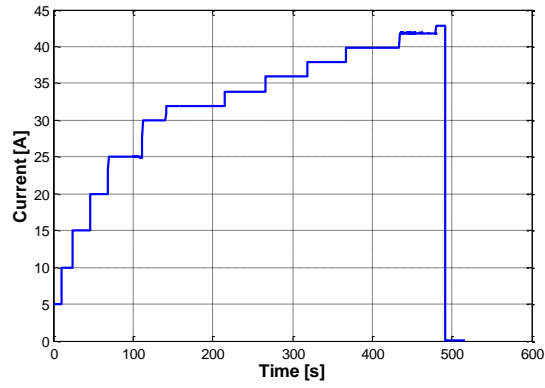

Fig. 2a. Evolution of the FC current

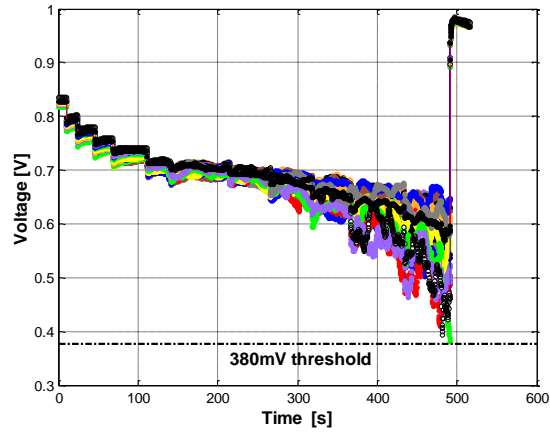

Fig. 2b. Evolution of the 20 cell voltages

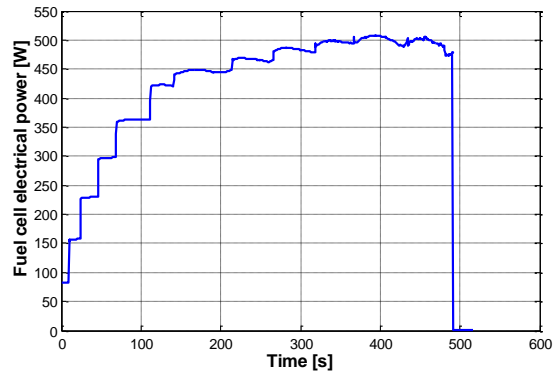

Fig. 2c. Evolution of the FC stack power

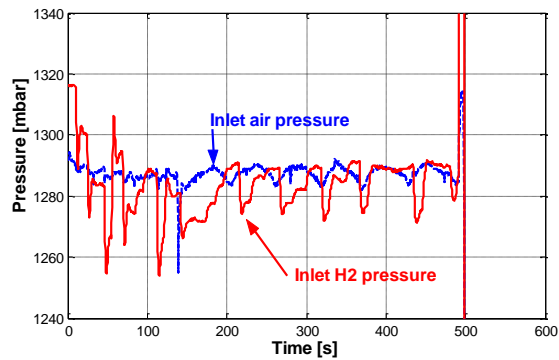

Fig. 2d. Evolution of the gas pressures at stack inlets

II. FULL FACTORIAL DESIGN

A Design of Experiment (DOE) is a structured, organised method to determine the relationship between the factors (X) affecting a process and the output of that process (Y). Here, the experimental design factors considered are: A: hydrogen pressure (PH₂), B: air pressure (Pair), C: hydrogen flow rate (DH₂), and D which is the air flow rate (Dair). The response Y is either the maximum FC output power or the efficiency computed for this power. The levels adopted for the factors are summed up in the following table.

Table. II. The levels used for the various experiments

Factors	Levels	
	Mini (i=-1)	Maxi (i=+1)
A : PH ₂	-1 : 1.3bars	1 : 1.4bars
B : Pair	-1 : 1.3bars	1 : 1.4bars
C : DH ₂	-1 : 5.5 nl/min	1 : 8.5 nl/min
D : Dair	-1 : 26.3 nl/min	1 : 39.6 nl/min

The levels were chosen taking into account the limits of the FC and also the ones of the testbench. Especially the limited pressure operating range specified by the FC manufacturer was restrictive for our tests. On the other hand, it could be considered that the small amplitude of pressure and gas flow parameters let the FC operate in a homogeneous physical domain. Therefore the hypothesis of linearity for these factors could be considered. This hypothesis had to be verified afterwards.

DOE can be very simple or very complicated according to the number of studied factors and formulated assumptions. The full factorial design of four presumed linear factors includes 2⁴ experiments (four factors with two levels each) [1] [2].

Table. III. Full factorial format for four linear factors

Test n°	A	B	C	D	ABCD
1	-	-	-	-	+
2	+	-	-	-	-
3	-	+	-	-	-
4	+	+	-	-	+
5	-	-	+	-	-
6	+	-	+	-	+
7	-	+	+	-	+
8	+	+	+	-	-
9	-	-	-	+	-
10	+	-	-	+	+
11	-	+	-	+	+
12	+	+	-	+	-
13	-	-	+	+	+
14	+	-	+	+	-
15	-	+	+	+	-
16	+	+	+	+	+

For the effect calculation, we have used the method of Yates. The notation used in Yates method is very practical if the studied factors have two levels. For instance, the effect A on level i is computed as follows:

$$E_{Ai} = \hat{Y}_{Ai} - \hat{Y} \quad (1)$$

where:

\hat{Y}_{Ai} is the average of the responses when the factor A is on level i,

\hat{Y} is the average of the responses for all the experiments.

In order to compare the 8 effects of the four factors, we represent these effects on a graph (Fig. 3) that is called: graph of the average effects. The maximal powers reached for the 16 experiments are plotted on the four graphs below, as well as the general average of these 16 Y values and the average of the stack powers when the considered X factor is on levels +1 / -1 (\hat{Y}_{Xi}). On the four graphs below, the greater the slope of the segment [$\hat{Y}_{X(-1)}$ $\hat{Y}_{X(+1)}$], the larger is the influence of the X factor [1] [2].

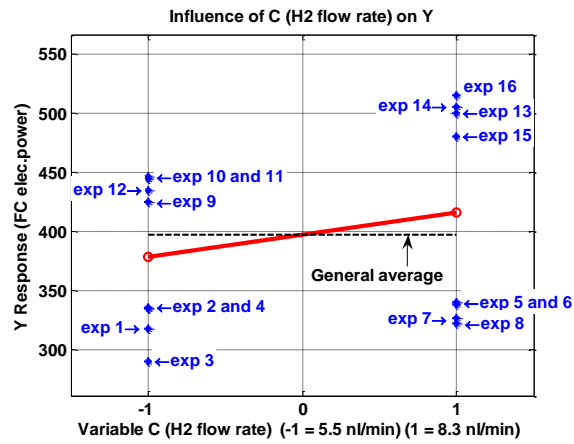
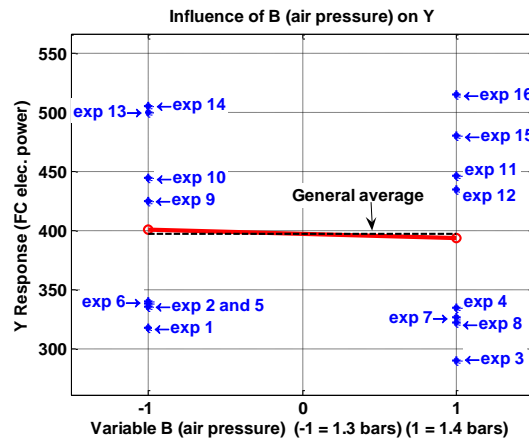
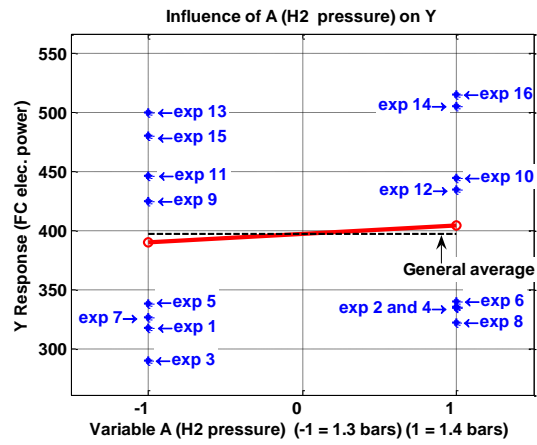

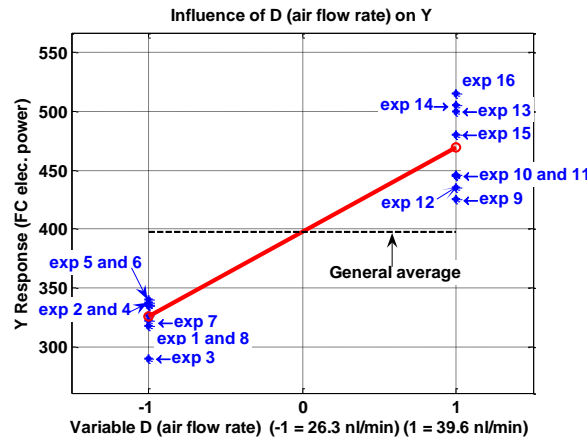

Fig. 3. Graphs of the mean effects for the four factors

The analysis of variance (ANOVA) is a commonly used tool to study and to estimate the factor influences over a process. A first ANOVA analysis is performed for the 16 reached maximal powers. Only first degree interactions (AB for instance) are taken into account. The analysis results are summed up in Table. IV.

Table. IV. ANOVA for the design of experiments L16 with maximal powers

Source	Sum Sq.	%	d. f.	Mean Sq.	fs	p-value
A (PH2)	749.4	0.8	1	749.4	2.99	0.144
B (Pair)	199.5	0.21	1	199.5	0.8	0.413
C (DH2)	5531.6	6	1	5531.6	22.1	0.005
D (Dair)	82010	88.5	1	82010	327	0
AB	21.4	2e-3	1	21.4	0.09	0.781
AC	78.8	5e-3	1	78.8	0.31	0.599
AD	8.3	≈0	1	8.3	0.03	0.863
BC	28.9	0.03	1	28.9	0.12	0.747
BD	213.9	0.23	1	213.9	0.85	0.397
CD	2512.5	2.71	1	2512.5	10	0.024
Error	1252.1	1.35	5	250.4		
Total	92607		15			

The ANOVA table has seven columns. The first one shows the source of the variability. The second one shows the sum of squares (Sum. Sq.) due to each source. The third one includes the percentage of contribution for each factor. The fourth one represents the degrees of freedom (d. f.) associated with each source. The fifth one contains the mean squares, which is the ratio: Sum. Sq. / d. f.. The sixth one shows the Fisher statistics (fs), which is the ratio of the mean squares. The seventh one shows the p-values for the Fisher statistics. The choice of a limit for the p-value, in order to determine whether or not a result is "statistically significant", is left to the researcher. It is common to declare a result significant if the p-value is less than 0.05 or 0.01 [1][2].

The ANOVA of Table. IV. shows that the air flow rate (factor D) is the most important factor with a contribution equal to 88.5% of the total variance. The effect of the factor C is the second most significant.

The reversible cell efficiency η_{rev} is the ratio between the electrical power output (P_{el}) and the product of the total enthalpy of the reaction (ΔH_f) with the hydrogen molar flow rate (N_{H_2}), as expressed by formula 2 [5].

$$\eta_{rev} = \frac{P_{el}}{-N_{H_2} \times \Delta H_f} \quad (2)$$

The efficiency is computed for each one of the 16 maximal electrical powers and a new ANOVA analysis is performed.

Table. V. ANOVA for DOE L16 with efficiencies at maximal powers

Source	Sum Sq.	%	d. f.	Mean Sq.	fs	p-value
A (PH2)	6.13	0.6	1	6.126	3.02	0.142
B (Pair)	1.05	0.1	1	1.051	0.52	0.503
C (DH2)	487.31	47	1	487.306	240.3	0

D (Dair)	527.85	50.9	1	527.851	260.3	0
AB	0.05	0	1	0.051	0.02	0.880
AC	1.5	0.14	1	1.501	0.74	0.428
AD	0.46	0.04	1	0.456	0.22	0.655
BC	0.02	0	1	0.016	0.01	0.933
BD	1.76	0.17	1	1.756	0.87	0.394
CD	0.86	0.08	1	0.856	0.42	0.544
Error	10.14	0.97	5	2.028		
Total	1037.1		15			

In Table. V., we can see that the efficiency of the 500W FC shows an important dependence on both factor D, with 50.9% of the total variance, and factor C with 47%.

III. FRACTIONAL FACTORIAL DESIGN

A fractional factorial DOE includes selected combinations of factors and levels. It is a carefully prescribed and representative subset of a full factorial design. A fractional factorial DOE is useful when the number of potential factors is relatively large because it reduces the total number of experiments required. A fractional design has to check the following properties: the first one is orthogonality and the second one is linked to the degrees of freedom.

The full factorial design required 2^k experiments where k is the number of two level factors. From a full factorial design, it is possible to reduce the runs to 8 ($= 2^{4-1}$) thanks to the design generator $D = \pm ABC$ and $ABCD = I$ (identity) (Table. III). In this way, a fractional factorial design is generated [2].

ANOVA is carried out for the 8 powers; the interactions are not taken into account (Table. VI.).

Table. VI. ANOVA table for the fractional factorial design
(FC maximal power is the output)

Source	Sum Sq.	%	d. f.	Mean Sq.	fs	p-value
A(PH2)	247.5	0.52	1	247.5	0.48	0.538
B(Pair)	52.5	0.11	1	52.5	0.1	0.770
C(DH2)	2397.8	5	1	2397.8	4.64	0.120
D(Dair)	42997.8	91	1	42997.8	83.26	0.003

The results obtained by means of the fractional design are close to the ones of the full factorial design; a very significant effect of the parameter D (air flow Dair) is found; it represents 91% of the total of contributions. In the same way, the efficiency study with a fractional factorial design reveals, as expected, that hydrogen and air flow rate influences are dominant over the fuel cell stack efficiency (Table. VII.).

Table. VII. ANOVA table for the fractional factorial design
(FC efficiency computed for the maximal power is the output)

Source	Sum Sq.	%	d. f.	Mean Sq.	fs	p-value
A(PH2)	1.62	0.3	1	1.62	8.53	0.061
B(Pair)	0.605	0.1	1	0.605	3.18	0.172
C(DH2)	262.205	48.7	1	262.205	1380	0
D(Dair)	273.78	50.8	1	273.78	1440.9	0

The 16 experiments and the ANOVA analyses performed with a full factorial design show that an increase of air flow is the best way to obtain the highest power and efficiency, for the range of flows and pressures considered. The use of the fractional design leads to the same conclusion, but only 8 instead of 16 experiments are needed.

IV. EXPERIMENTAL RESULT ANALYSIS AND DISCUSSION

A. The effects of pressure

It might be wondering that the effects of pressures are so low, even if the pressure range considered is small (0.1bar) as it has already been noticed. Indeed, the Nernst equation and also the expression of the activation overvoltages clearly show that increasing the pressures leads to a higher fuel cell voltage. The Nernst equation can be written as follows [5]:

$$E = E^{\circ} + \frac{RT}{2F} \ln \left(\frac{PH_2 \times (PO_2)^{1/2}}{PH_2O} \right) \quad (3)$$

where E° (about 1.2 V) is the limit voltage at standard pressure, PO_2 the partial pressure of oxygen (bar), PH_2O the partial pressure of water (bar) and PH_2 the partial pressure of hydrogen (bar).

The expression for the activation voltages can be derived from the Butler-Volmer equation:

$$\eta_{act} = \beta_1 + \beta_2 T + \beta_3 T \ln \left(\frac{PO_2}{P_0} \right) + \beta_4 T \ln(i) + \beta_5 \ln \left(\frac{PH_2}{P_0} \right) \quad (4)$$

where i is the current density (A/m^2), P_0 the reference pressure ($P_0 = 1 \text{ atm}$).

Each one of the 16 tests performed can be used to record a polarisation curve. On figure 4, two polarisation curves are plotted in the case of two different pressure levels.

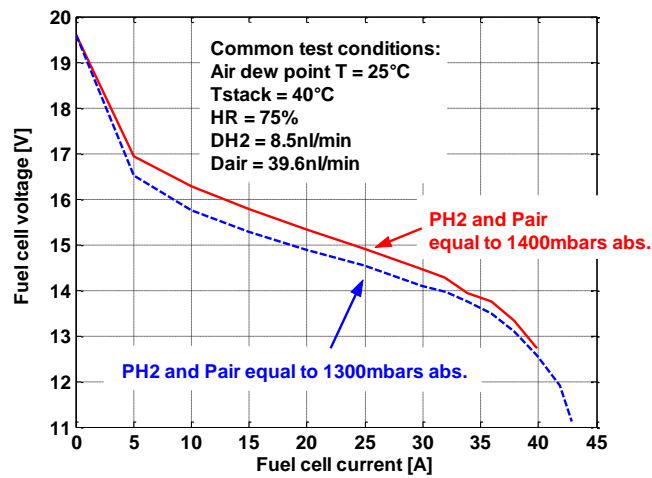

Fig. 4. Polarisation curves recorded for two hydrogen and air pressures

The gas pressure increase from 1.3 bars to 1.4 bars leads to an improvement of the FC performances. This contribution of the pressures to the FC voltage output (and thus to the power output) was not noticed in the results of the first experimental design, where we were only interested in the maximum power reached. A new study has been carried out for another operation point on the polarisation curve (for the same current value of 20A instead of the different current values corresponding to the maximal powers reached) with the aim to highlight the incidence of the pressures on the power delivered by the fuel cell. The results obtained by this procedure are shown in Table. VIII.

Table. VIII. ANOVA for DOE L16
(FC power computed for a 20A current is the output)

Source	Sum Sq.	%	d. f.	Mean Sq.	fs	p-value
A (PH ₂)	30.582	8.95	1	30.582	2.14	0.203
B (Pair)	51.407	15.05	1	51.407	3.6	0.116
C (DH ₂)	3.535	1.035	1	3.535	0.25	0.639
D (Dair)	165.897	48.58	1	165.897	11.63	0.019
AB	5.429	1.597	1	5.429	0.38	0.564
AC	5.382	1.576	1	5.382	0.38	0.565
AD	2.823	0.826	1	2.823	0.2	0.675
BC	0.961	0.28	1	0.961	0.07	0.805
BD	0	0	1	0	0	0.996
CD	4.121	1.206	1	4.121	0.29	0.613
Error	71.305	20.88	5	14.261		
Total	341.443		15			

The effects of the factors D (Dair), B (Pair) and A (PH₂) are more significant but they do not explain the total contribution. In

fact, there is a large error due to other influential parameters not taken into account [2]. The analysis of the variance performed for the efficiency of the fuel cell shows the very important effect of the hydrogen flow.

Table. IX. ANOVA for DOE L16
(FC voltage efficiency computed for a 20A current is the output)

Source	Sum Sq.	%	d. f.	Mean Sq.	fs	p-value
A (PH2)	0.176	0.039	1	0.176	1.51	0.274
B (Pair)	0.336	0.075	1	0.336	2.87	0.150
C (DH2)	444.577	99.42	1	444.577	3795.5	0
D (Dair)	1.221	0.273	1	1.221	10.42	0.023
AB	0.062	0.014	1	0.062	0.53	0.497
AC	0.009	0.002	1	0.009	0.08	0.792
AD	0.027	0.006	1	0.027	0.23	0.650
BC	0.002	≈0	1	0.002	0.02	0.900
BD	0.006	≈0	1	0.006	0.05	0.835
CD	0.16	0.036	1	0.16	1.37	0.295
Error	0.586	0.001	5	0.117		
Total	447.163		15			

B. The effects of flow rate

It is well-known that water management is of great importance for the PEMFC correct operation. Not only the membrane needs a certain moisture to reach a good conductivity; the FC performances depend also on the amount of water in the backing layers. In the case of a flooding, the catalytic sites in-depth are not fed by oxygen ("too wet" case). When the pores become too dry, the proton supply is not ensured ("too dry" case). The two cases lead to a reduction in the number of active sites and thus to a performance decrease. For the correct operation of our FC, the air humidity must be controlled. The studied FC needs quite high stoichiometry rates to operate properly. It seems that the air flow contributes actively to the evacuation of the water produced in the FC. The flow rates of gases have a strong influence on the moisture in our FC and especially on the draining away of the water from plate channels and gas diffusion layers.

C. Additional results

The tools developed for one particular current value can be used in order to understand the contribution and the influence of each parameter over the FC voltage, along the curve of polarisation. For instance, ANOVA analyses are performed for 6 various FC currents in the case of the FC voltage study. The contributions are plotted on the two graphs of Figure 5 (interactions are not taken into account).

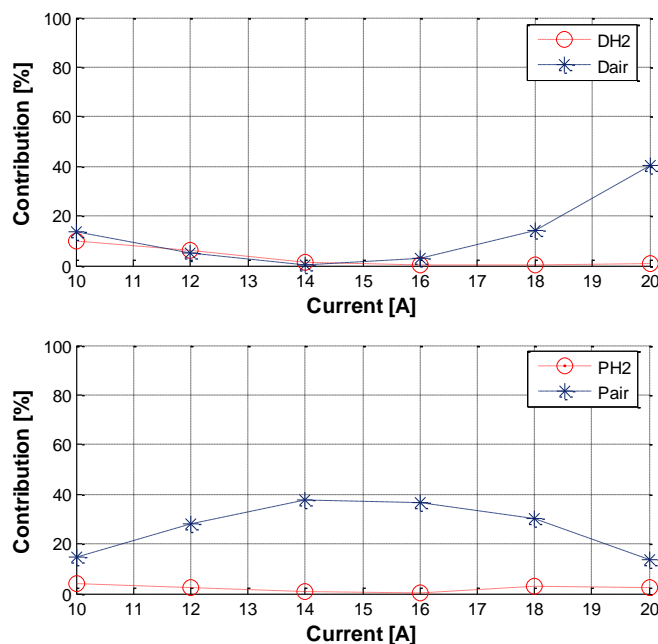

Fig. 5. Contribution of the four studied parameters to the FC voltage

V. CONCLUSION

The design of experiment method has been used in order to compute the effects of four factors (hydrogen pressure, air pressure, hydrogen flow rate and air flow rate) over the maximum power delivered by the FC and also over its efficiency at this operation conditions. First, two studies were executed: a full factorial design (16 experiments) and a fractional one (8 experiments). In both cases, we arrived to the same conclusion concerning the prevalent effects of the maximal air flow rate and hydrogen flow rate respectively on the maximal power and efficiency obtained. The studied FC needs relative high stoichiometry rates to deliver its maximal power. The major importance of the air flow highlighted in the study could explain the fact that FC manufacturers choose to develop "air breathing" technologies (or "convection style stacks"). Their operation type is very simple as the opened cathode can be fed by a blower. As there is no need for a compressor, the ancillary consumption is low. This kind of FC seems well adapted for low powers (<1kW). In the second part of the study, it was noticed that the pressures effects were very low, which seemed to be in contradiction with some simple physical considerations. Therefore a new study was done: we were no longer interested in the maximal power reached but in the power supplied at a given current. The results were appreciably different from the initial work insofar as it became possible to highlight the influences of air and hydrogen pressures on the power delivered.

Future works will concern the study of other physical factors (for instance: relative humidity and dew point temperature of gases at stack inlets). The methodologies initially developed for the 500W stack will be used in the framework of other projects concerning larger PEM stacks (5kW for instance). It could be also interesting to consider a physical model and to use the results of the experiment analyses with the aim at evaluating the model and its degree of complexity for a given application.

ACKNOWLEDGMENT

The authors are grateful to Mr F. Harel and X. François, engineers at the L2ES Laboratory for their important contributions to the experimental part of the work. They are also grateful to Mr Raed Kouta, associated professor at UTBM, for his help and his lectures about the experimental design methodology.

REFERENCES

- [1] M. Vigier, "Pratique des plans d'expériences - méthodologie Taguchi et compléments", *Les Editions d'Organisation*, c1988.
- [2] M. Pillet, "Les plans d'expériences par la méthode Taguchi ", *Les Editions d'Organisation*, 1999, c1997.
- [3] A. Bendell, J. Disney and W. A. Pridmore, "Taguchi methods: applications in world industry", *Bedbord (UK) : IFS*, c1989.
- [4] R. C. Dante, J. L. Escamilla, V. Madrigal, T. Theuss, J. de Dios Calderón, O. Solorza and R. Rivera, "Fractional factorial design of experiments for PEM fuel cell performance improvement", *International Journal of Hydrogen Energy*, Volume 28, Issue 3, March 2002, Pages 343-348.
- [5] J. Larminie, A. Dicks, "Fuel Cell Systems Explained", *WILEY* editions, November 2000.
- [6] Sleem-ur-Rahman, M. A. Al-Saleh and A. S. Al-Zakri, "Parametric study of the preparation of gas-diffusion electrodes for alkaline fuel cells by a filtration method", *Journal of Power Sources*, Volume 72, Issue 1, 30 March 1998, Pages 71-76.
- [7] F. Harel, X. François, S. Jemeï, S. Moratin, "Conception et réalisation d'un banc d'essai pour piles à combustibles à membrane de faibles puissances", Rapport Inrets LTE n°0310, May 2003.
- [8] F. Harel, S. Jemeï, X. François, M-C. Péra, D. Hissel, J-M. Kauffmann, "Experimental investigations on PEMFC: a test bench design", FDFC'02 France Deutschland Fuel Cell Conference, pp 65-72, November 2002, Forbach - France

Bouchra Wahdame got the French DEA and DESS Degrees (Master degrees) in Electrical Engineering from the University of Franche-Comté in 2003 and is currently PhD student at the L2ES laboratory in Belfort. Since 2003, she has been working on experiment designs for fuel cell systems.

Denis Candusso has been researcher at INRETS LTN since 2003 and has been working on fuel cell systems at the L2ES laboratory in Belfort.

Jean-Marie Kauffmann is Professor at the University of Franche-Comté and he is Director of the L2ES Laboratory.