



**HAL**  
open science

## Simulating experimental techniques: Kelvin Probe Force Microscopy NanoTechnology-NN22

James P. Connolly, J Alvarez, Jean-Paul Kleider, Mattia da Lisca, Vesselin Donchev, Ahmed Nejim

### ► To cite this version:

James P. Connolly, J Alvarez, Jean-Paul Kleider, Mattia da Lisca, Vesselin Donchev, et al.. Simulating experimental techniques: Kelvin Probe Force Microscopy NanoTechnology-NN22. 19th International Conference on Nanosciences & Nanotechnologies (NN22), Aristotle University of Thessaloniki, Jul 2022, Thessaloniki, Greece. hal-04492966

**HAL Id: hal-04492966**

**<https://hal.science/hal-04492966>**

Submitted on 19 Mar 2024

**HAL** is a multi-disciplinary open access archive for the deposit and dissemination of scientific research documents, whether they are published or not. The documents may come from teaching and research institutions in France or abroad, or from public or private research centers.

L'archive ouverte pluridisciplinaire **HAL**, est destinée au dépôt et à la diffusion de documents scientifiques de niveau recherche, publiés ou non, émanant des établissements d'enseignement et de recherche français ou étrangers, des laboratoires publics ou privés.



Horizon 2020

*NanoTechnology-NN22*



# Simulating experimental techniques : Kelvin Probe Force Microscopy

J.P. Connolly<sup>1</sup>, J. Alvarez<sup>1</sup>, J.-P. Kleider<sup>1</sup>, M. Da Lisca<sup>1,2</sup>, V. Donchev<sup>3</sup>, Ahmed Nejim<sup>4</sup>

<sup>1</sup> GeePs, UMR8507, CNRS, CentraleSupélec, Sorbonne Université, U. Paris Saclay, 11 R Joliot-Curie, 91192 Gif, France

<sup>2</sup> IPVF, Institut Photovoltaïque d'Île-de-France, 30 route Départementale 128, F91120, France

<sup>3</sup> Faculty of physics, Sofia University, blvd. James Bourchier, 5, 1164 Sofia, Bulgaria

<sup>4</sup> Silvaco Europe, Cambridge, UK

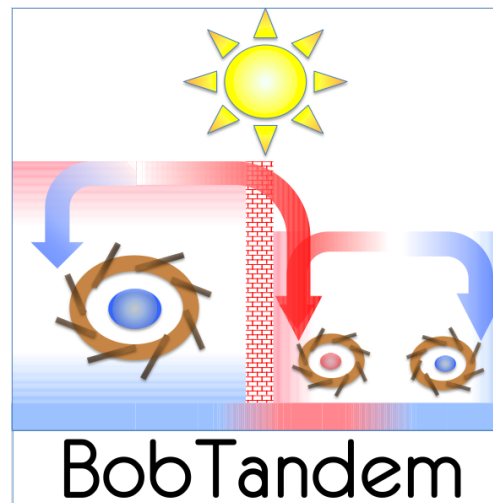

CentraleSupélec



## *Summary*

---

- Kelvin probe force microscopy : an introduction
- Analytical and numerical methods
- Simulating the experiment

# *Kelvin probe force microscopy*

---

- Measurement of **surface voltage** versus **incident photon energy**
- **Surface Photovoltage embodiment** : Light signal minus dark as a function of photon energy
- Semiconductor materials (surfaces, interfaces, and bulk) and optoelectronic devices
- Contactless technique and non destructive
- No need sample preparation or junction fabrication
- Information extracted : semiconductor type (n or p), electronic transitions (band-to-band, defect-band), **diffusion length**, **minority carrier-lifetime**, open-circuit voltage...
- Challenge : Analysis of surface techniques dominated by surface defects

=> Solution : Modelling

# Kelvin probe force microscopy : The technique

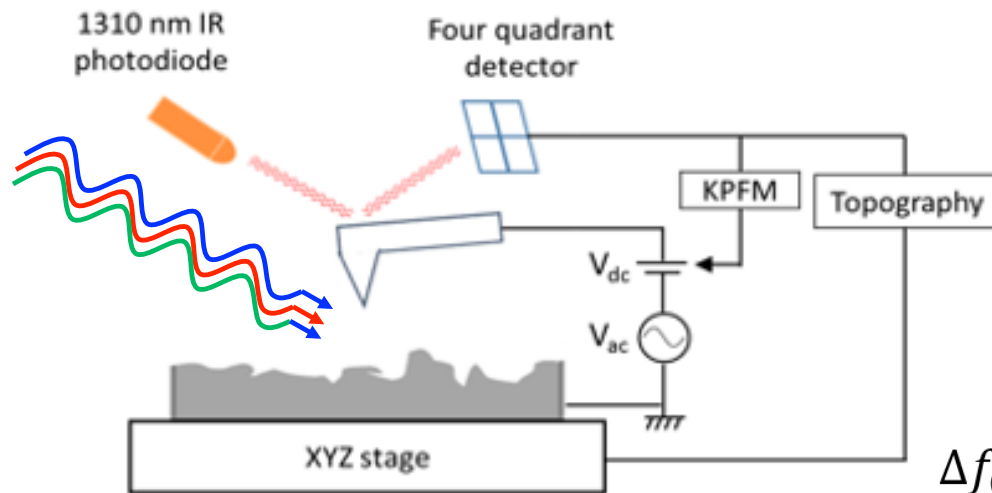

Two-pass mode scanning :

- 1<sup>st</sup> topography
- 2<sup>nd</sup> KPFM

## Amplitude Modulation

$$F_{\omega} = \frac{\partial C}{\partial z} (V_{DC} - CPD) V_{AC} \cos(\omega t)$$

## Frequency Modulation

$$\Delta f_0(\omega) \propto \frac{\partial F_{\omega}}{\partial z} = \frac{\partial^2 C}{\partial z^2} (V_{DC} - CPD) V_{AC} \sin(\omega t)$$

$$CPD_{KPFM} = \frac{(W_{sonde} - W_{surf})}{q}$$

# *Kelvin probe force microscopy : basic principle*

---

**DC light**

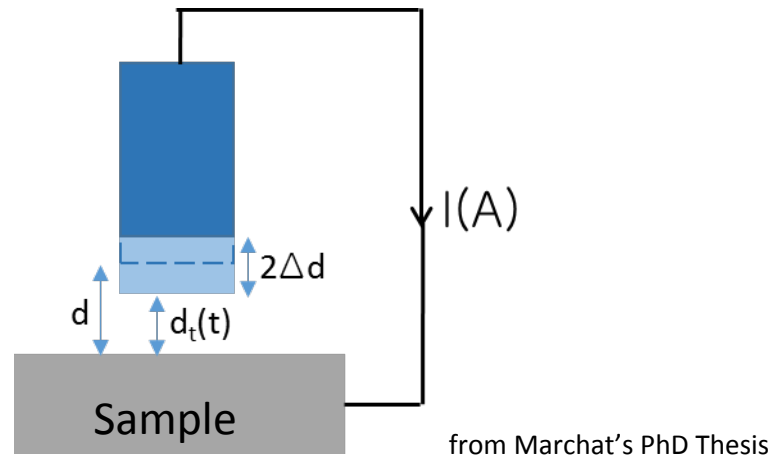

Vibrating probe/capacitor :  
**Kelvin probe**

# Kelvin probe force microscopy : CPD and SPV

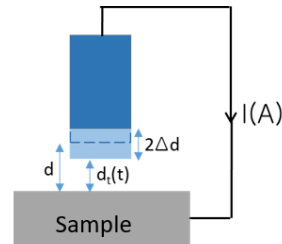

Surface Voltage or Contact Potential Difference (CPD)  
=> Work Function ( $W_F$ )



Lamp and Monochromator



SPV-Spectroscopy

# Kelvin probe force microscopy : Surfaces

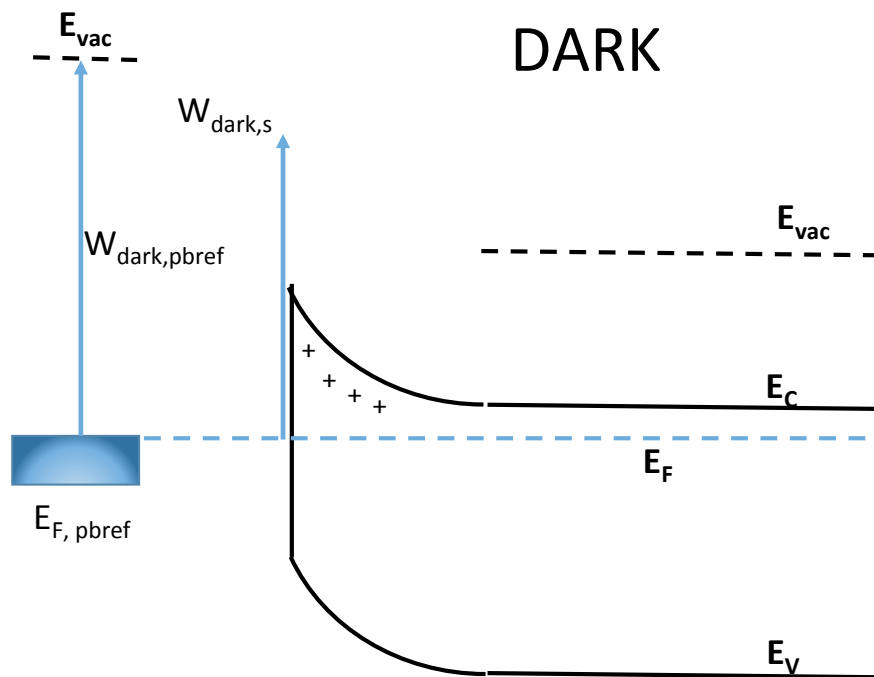

$$q \text{ CPD}_{\text{dark}} = W_{\text{dark, pbref}} - W_{\text{dark, s}}$$

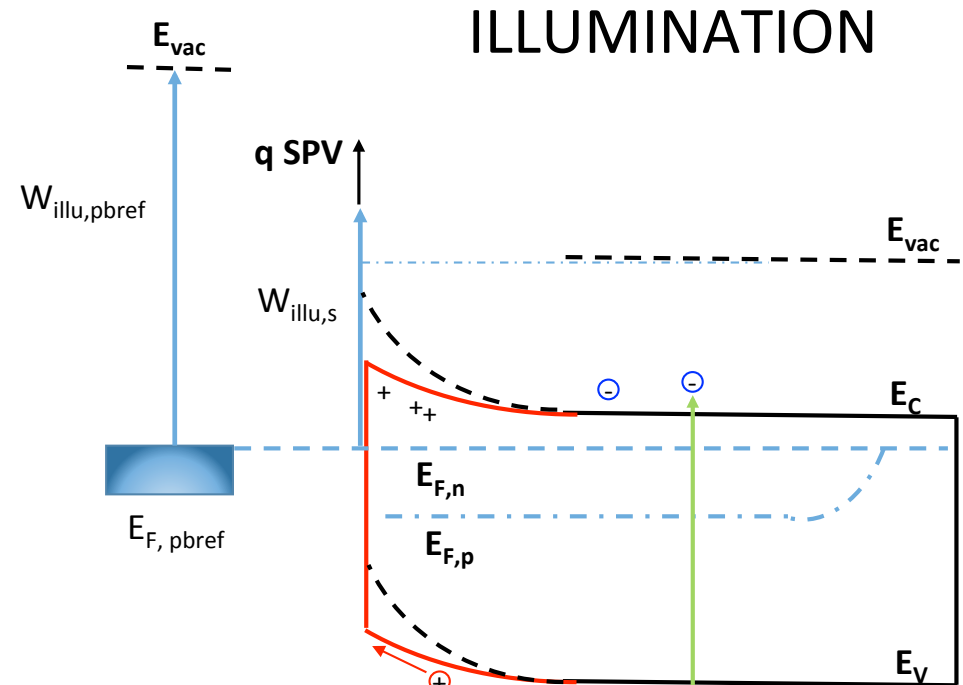

$$q \text{ CPD}_{\text{illu}} = W_{\text{illu, pbref}} - W_{\text{illu, s}}$$

$$\text{SPV} = (\text{CPD}_{\text{illu}} - \text{CPD}_{\text{dark}}) = - (W_{\text{illu, s}} - W_{\text{dark, s}}) / q = (E_{F, p} - E_{F, n}) / q$$

- Dark :** Work function affected by surface states / charges  
**Light :** Signal modified by QFL splitting



## *Analytical / numerical models sketch:*

---

### *Analytical model :*

- Charge :  $q(p-n+N_d-N_a)$  – electrons, holes, donors, acceptors
- Solve Poisson equation ([Matlab](#))

=> Surface field as a function of acceptor and donor defects

### *Numerical model :*

- Solve current and continuity numerically ([Silvaco](#))
- Arbitrary (within reason) defect distributions

### *The object :*

- Bulk silicon
- 2D surface acceptor and donor defect states (analytical)
- 3D surface acceptor and donor defect states (numerical)

# Analytical : equal trap capture cross section

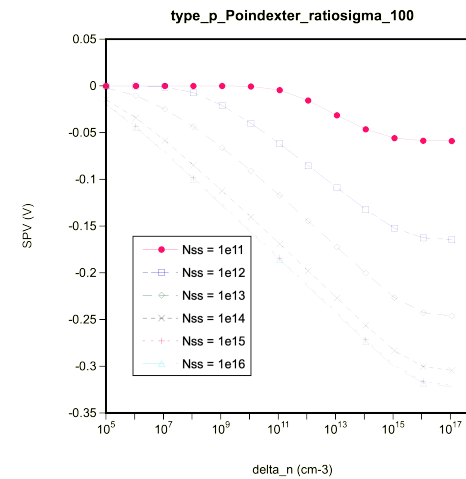
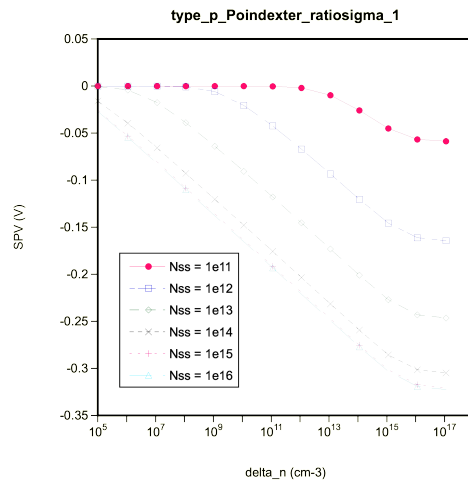

# Numerical : equal trap capture cross section

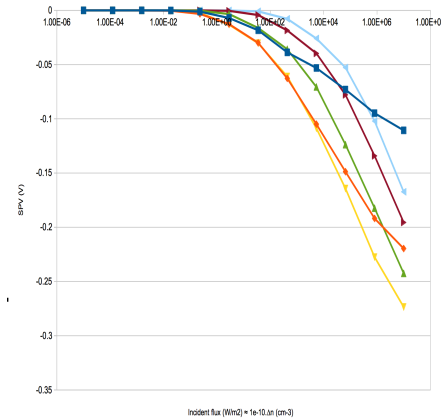
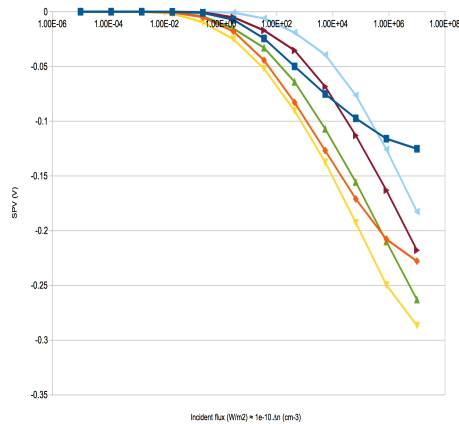

=> qualitative agreement in trends – future work.



# Reminder : Kelvin Probe Force Microscopy KPFM

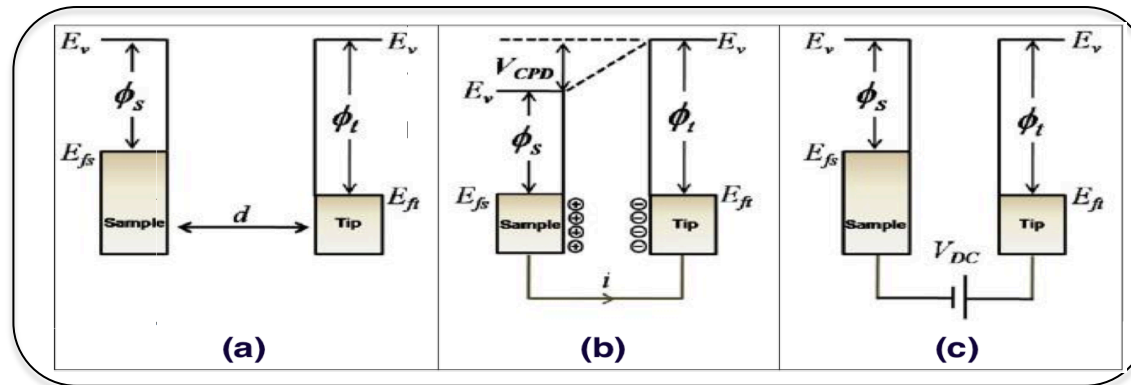

Kelvin probe force microscopy: work function measurement.

(a) Sample and tip far apart.

(b) Sample and tip in contact: Fermi levels align, current flows. The vacuum level step:  $V_{CPD}$

(c) External applied bias equal to  $V_{CPD}$  equilibrates vacuum levels.

=> Known KPFM tip vacuum and  $V_{CPD}$  levels gives sample work function.

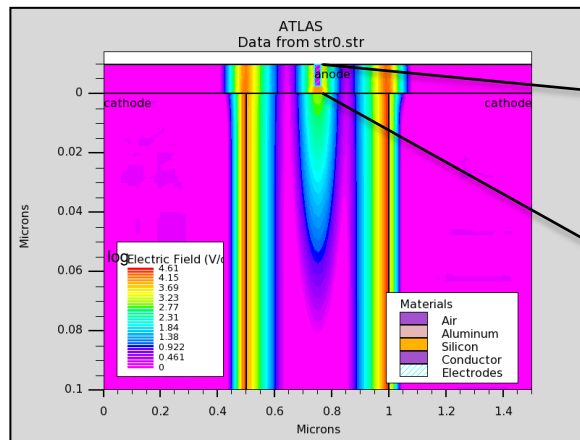

Fig. 2

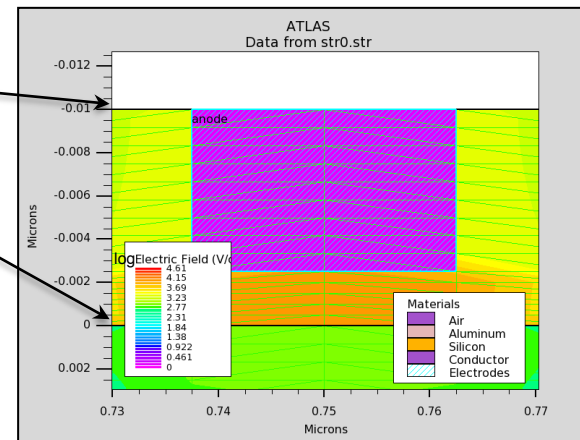
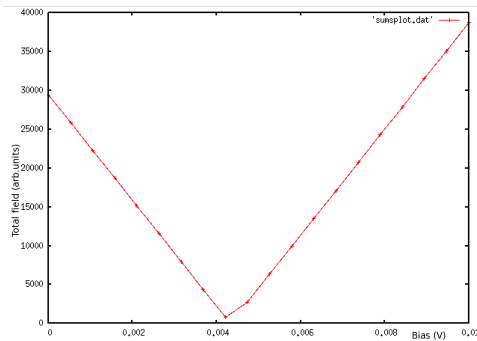
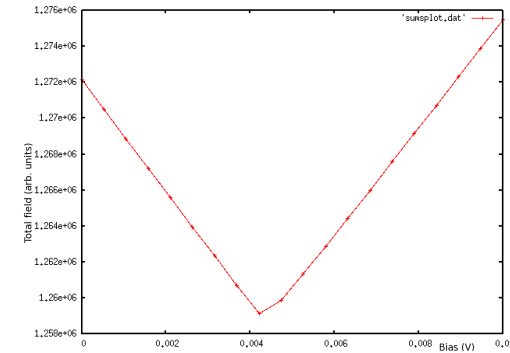

Fig. 3

# Solution method : minimum tip / probe field



No defects: "Gap" field as a function of applied bias:  
Minimum  $\approx 4\text{meV}$



"No defects: Bulk" field as a function of applied bias:  
Minimum  $\approx 4\text{meV}$

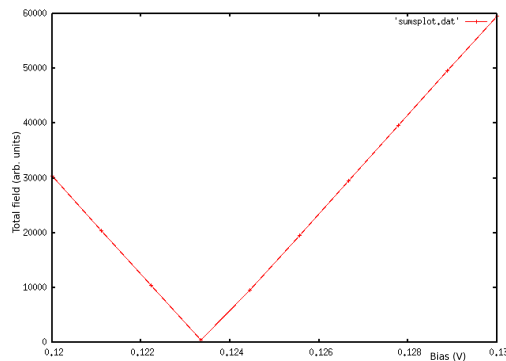

"Gap" field as a function of applied bias: Minimum  $\approx 50\text{meV}$

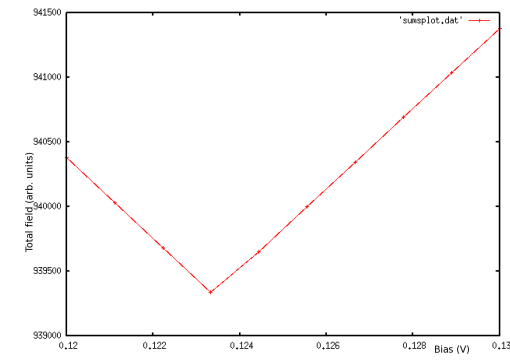

"Bulk" field as a function of applied bias: Minimum  $\approx 50\text{meV}$

"Gap" / "Bulk" methods for Vcpd comparison :

- Little difference for these doping levels
- Differences nevertheless expected

**$\Rightarrow$  Rapid "gap" or spot method preferred**

# Kelscan demonstration

Splash screen choice "1" – choose sample

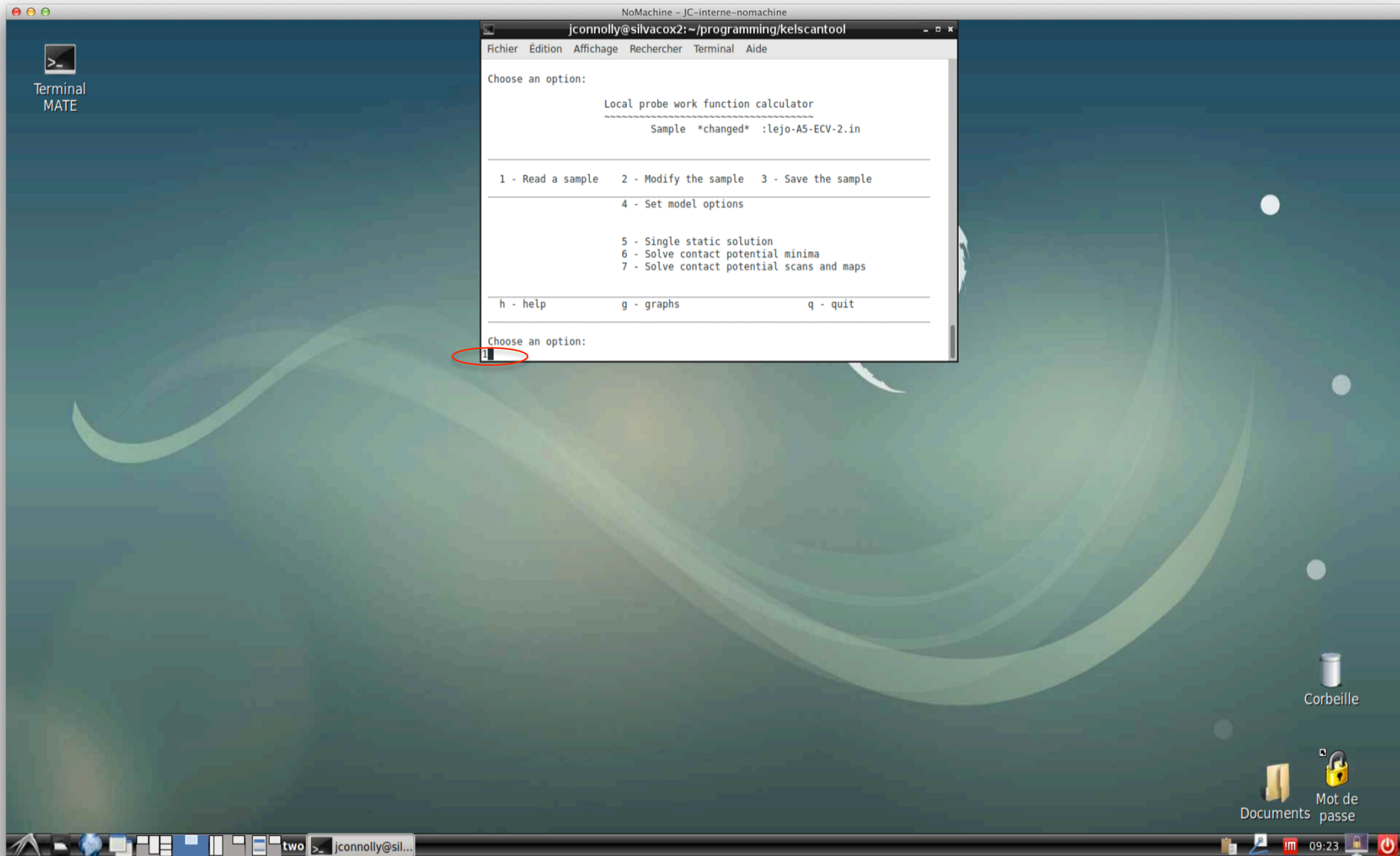

# Kelscan demonstration

## Sample choice



# Kelscan demonstration

## Sample modification menu

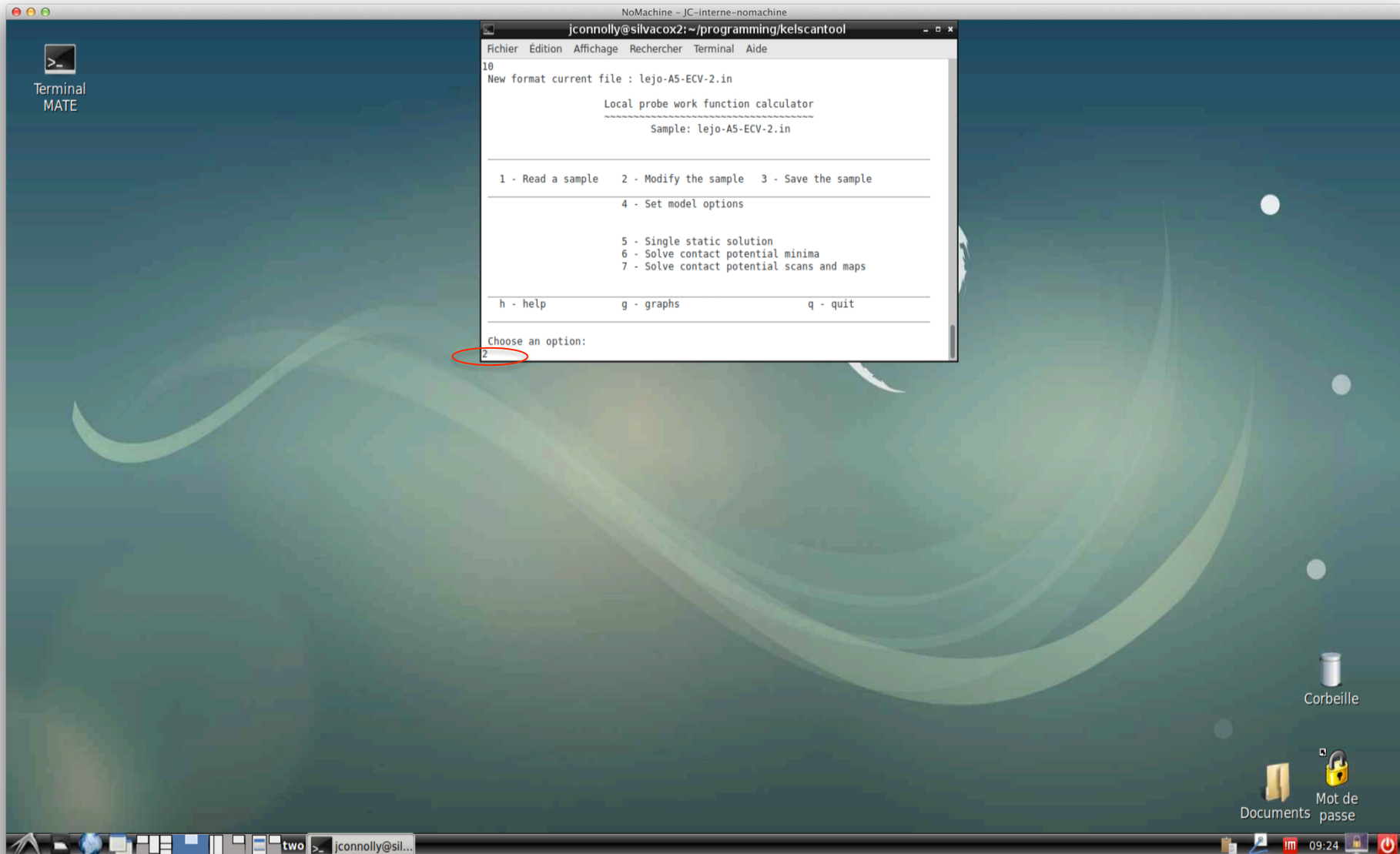



# Kelscan demonstration

The **sample file format**: Saves all simulation parameters shown here.  
Silvaco compatible : can be directly run by Silvaco Deckbuild

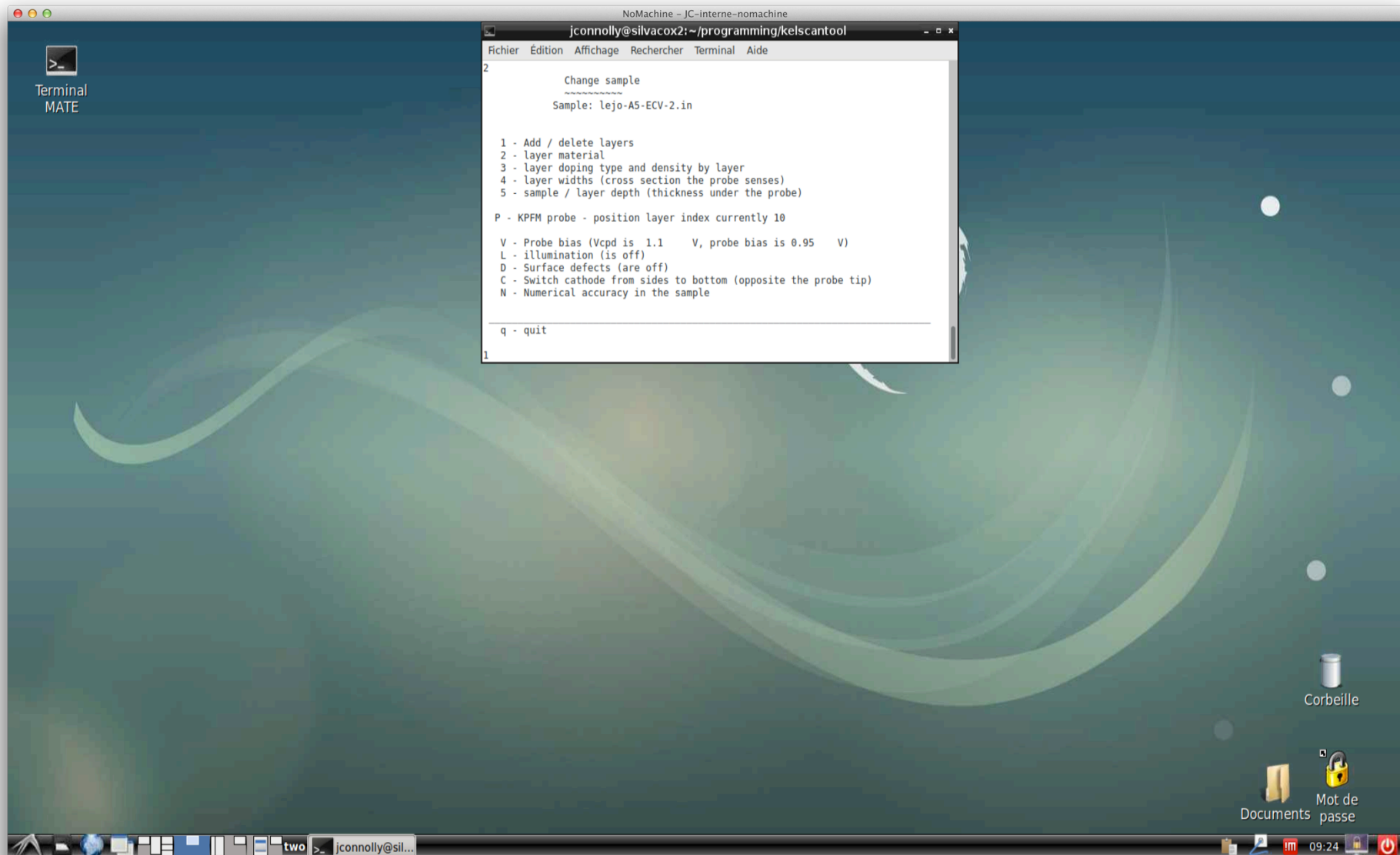

The screenshot shows a Linux desktop environment with a terminal window open. The terminal window title is "jconnolly@silvaco2: ~/programming/kelscantool". The terminal content displays the following text:

```
2
Change sample
-----
Sample: lejo-A5-ECV-2.in

1 - Add / delete layers
2 - layer material
3 - layer doping type and density by layer
4 - layer widths (cross section the probe senses)
5 - sample / layer depth (thickness under the probe)

P - KPFM probe - position layer index currently 10

V - Probe bias (Vcpd is 1.1 V, probe bias is 0.95 V)
L - illumination (is off)
D - Surface defects (are off)
C - Switch cathode from sides to bottom (opposite the probe tip)
N - Numerical accuracy in the sample

q - quit
1
```

# Kelscan demonstration

Sample properties of multi-layer sample simulating Lejo Joseph doping profile measurement

Terminal  
MATE

```
NoMachine - JC-interne-nomachine
jconnolly@silvacox2: ~/programming/kelscantool
Fichier Edition Affichage Rechercher Terminal Aide

Index   Width (um) Doping (/cm3) Type (p or n) Material (name)
-----
1)      0.750E-01  0.280E+20    p             silicon
2)      0.750E-01  0.330E+20    p             silicon
3)      0.750E-01  0.313E+20    p             silicon
4)      0.750E-01  0.295E+20    p             silicon
5)      0.750E-01  0.249E+20    p             silicon
6)      0.750E-01  0.184E+20    p             silicon
7)      0.750E-01  0.133E+20    p             silicon
8)      0.750E-01  0.723E+19    p             silicon
9)      0.750E-01  0.173E+19    p             silicon
10)     0.750E-01  0.261E+18    p             silicon
11)     0.750E-01  0.108E+18    n             silicon
12)     0.750E-01  0.178E+18    n             silicon
13)     0.750E-01  0.180E+18    n             silicon
14)     0.750E-01  0.150E+18    n             silicon
15)     0.750E-01  0.122E+18    n             silicon
16)     0.750E-01  0.214E+18    n             silicon
17)     0.750E-01  0.372E+16    n             silicon
18)     0.750E-01  0.512E+16    n             silicon
19)     0.750E-01  0.645E+16    n             silicon
20)     0.750E-01  0.117E+18    n             silicon

Add or delete (existing layers will be copied) ? (a/d or quit)
```

Corbeille  
Documents Mot de passe  
09:49

# Kelscan demonstration

## Doping levels

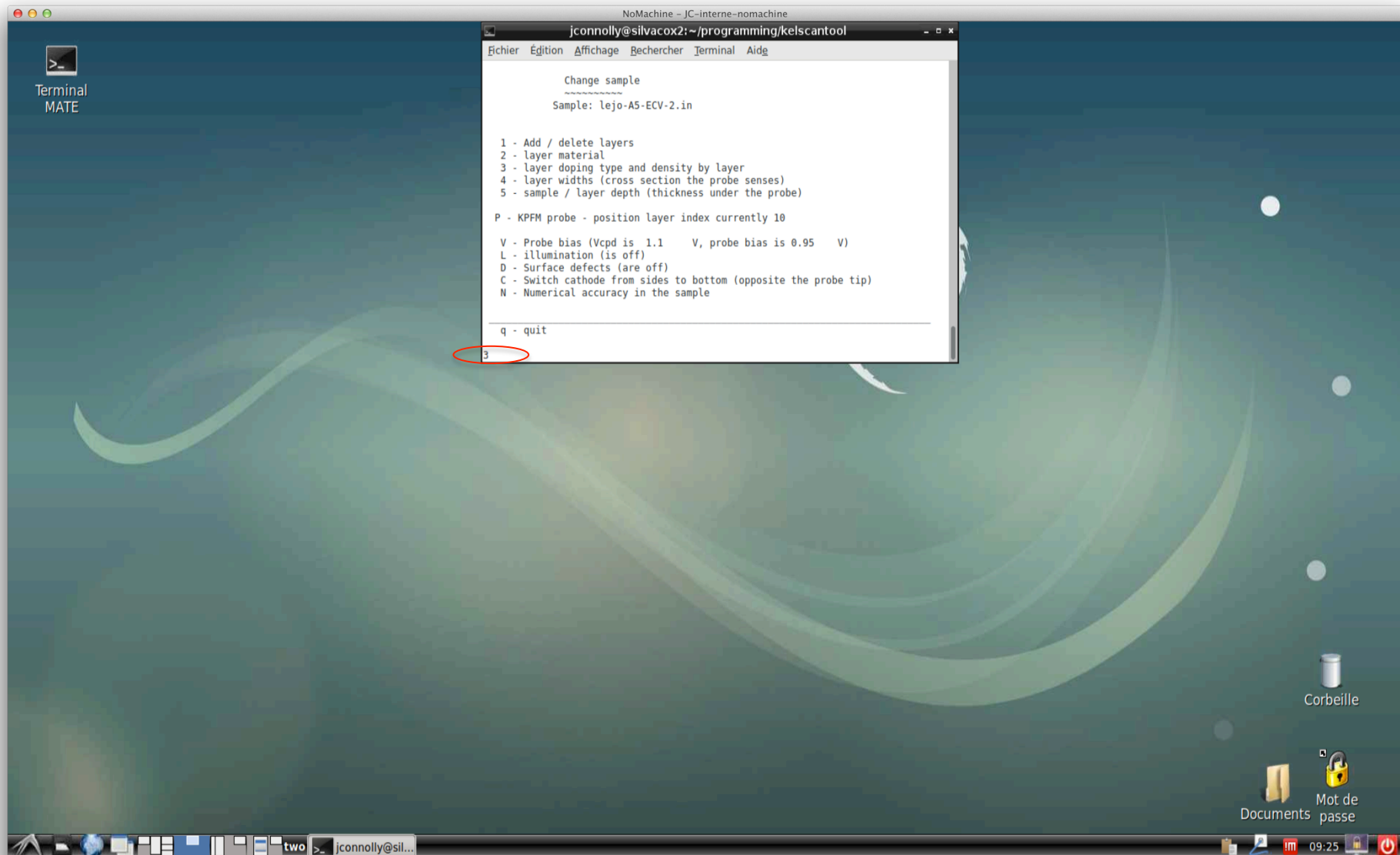

```

NoMachine - JC-interne-nomachine
jconnolly@silvacox2: ~/programming/kelscantool
Fichier Edition Affichage Rechercher Terminal Aide

Change sample
-----
Sample: lejo-A5-ECV-2.in

1 - Add / delete layers
2 - layer material
3 - layer doping type and density by layer
4 - layer widths (cross section the probe senses)
5 - sample / layer depth (thickness under the probe)

P - KPFM probe - position layer index currently 10

V - Probe bias (Vcpd is 1.1 V, probe bias is 0.95 V)
L - illumination (is off)
D - Surface defects (are off)
C - Switch cathode from sides to bottom (opposite the probe tip)
N - Numerical accuracy in the sample

q - quit
3

```

# Kelscan demonstration

## Doping levels and tonyplot doping graph

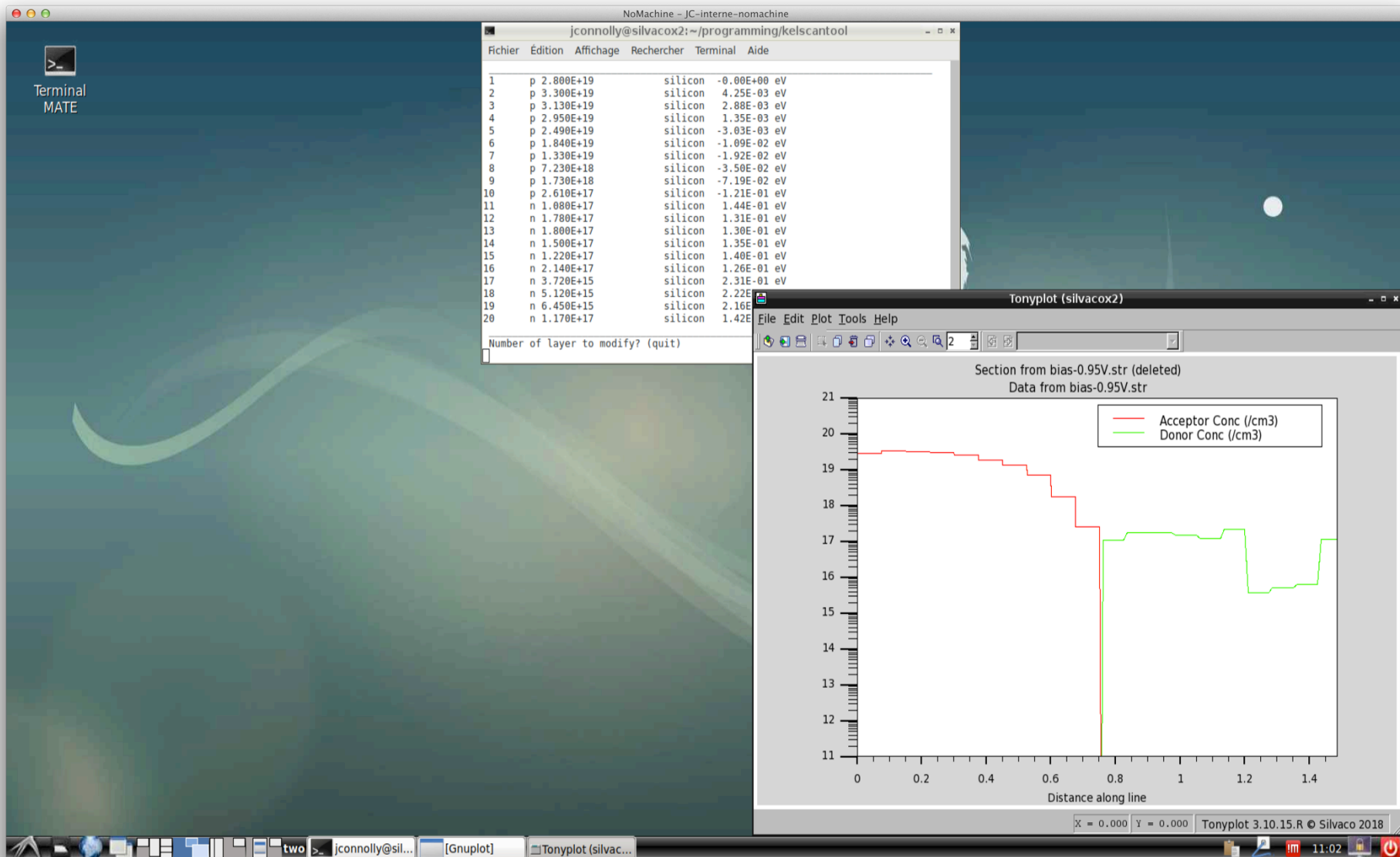

# Kelscan demonstration

## Sample modify – KPFM probe

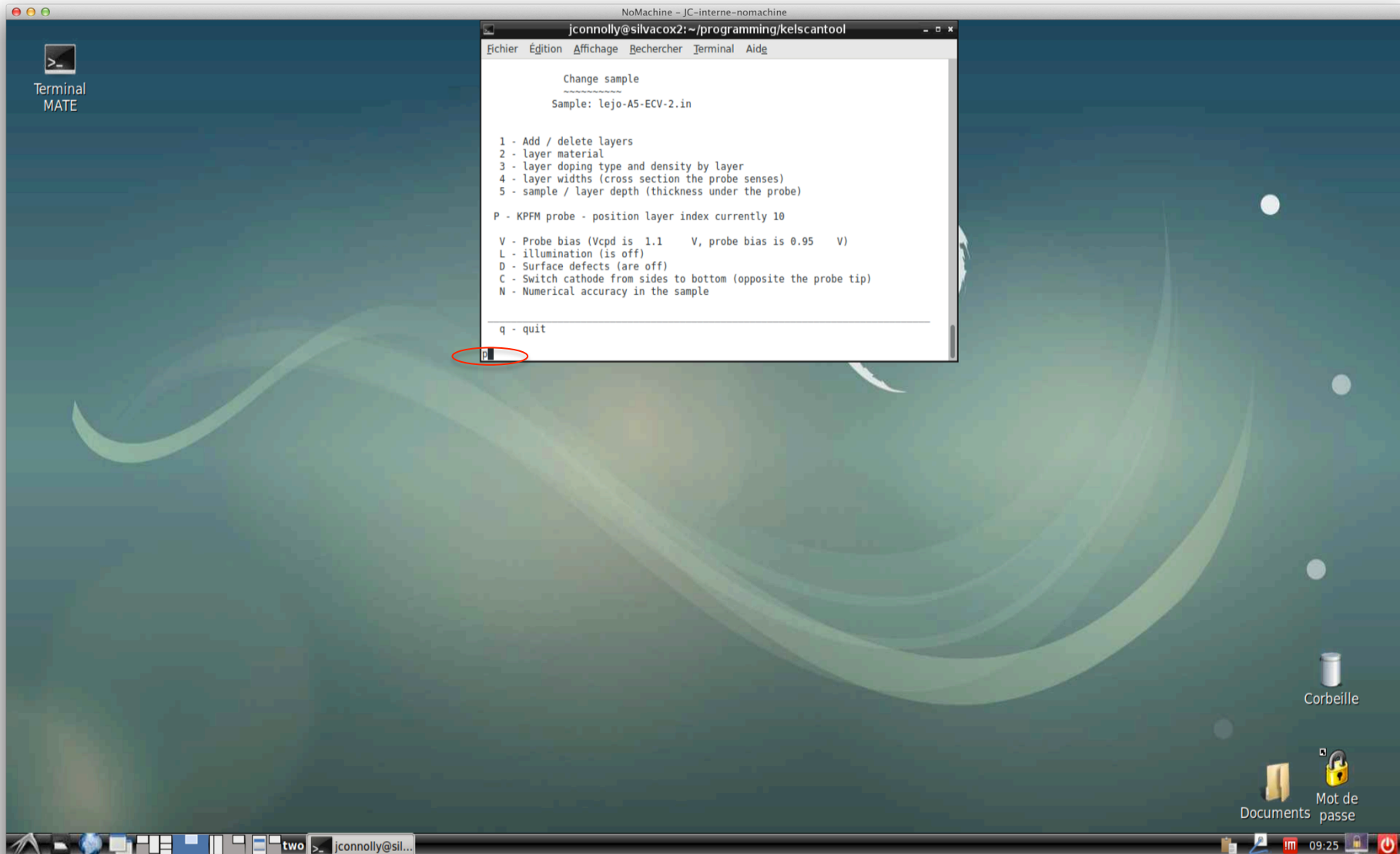

# Kelscan demonstration

## Sample modify – KPFM probe properties

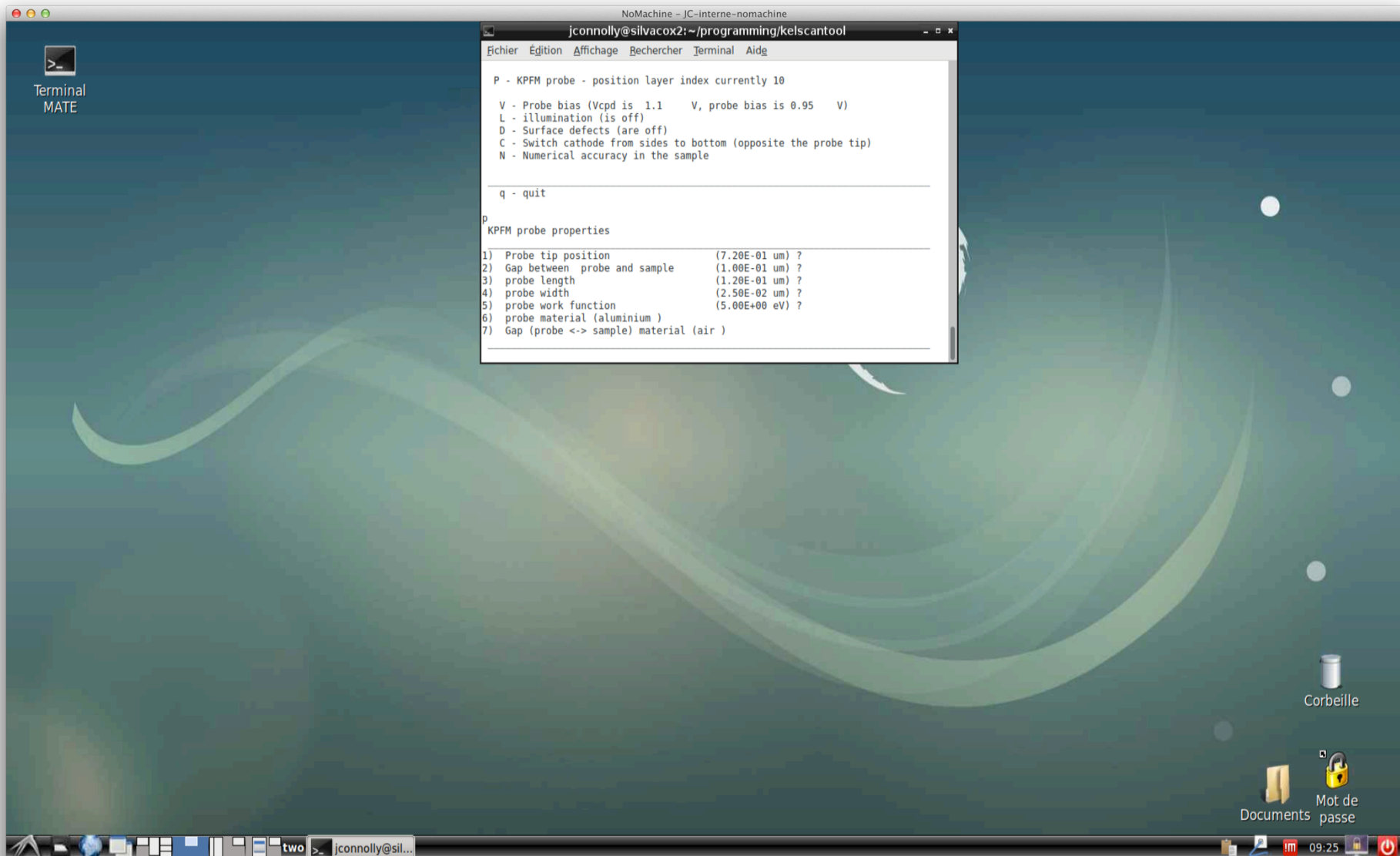

```
Terminal
MATE

NoMachine - JC-interne-nomachine
jconnolly@silvacox2:~/programming/kelscantool
Fichier Edition Affichage Rechercher Terminal Aide

P - KPFM probe - position layer index currently 10

V - Probe bias (Vcpd is 1.1 V, probe bias is 0.95 V)
L - illumination (is off)
D - Surface defects (are off)
C - Switch cathode from sides to bottom (opposite the probe tip)
N - Numerical accuracy in the sample

q - quit

P
KPFM probe properties
1) Probe tip position (7.20E-01 um) ?
2) Gap between probe and sample (1.00E-01 um) ?
3) probe length (1.20E-01 um) ?
4) probe width (2.50E-02 um) ?
5) probe work function (5.00E+00 eV) ?
6) probe material (aluminium)
7) Gap (probe <-> sample) material (air )
```

# Kelscan demonstration

Single solution of structure for specified structure including probe position, defects, and illumination

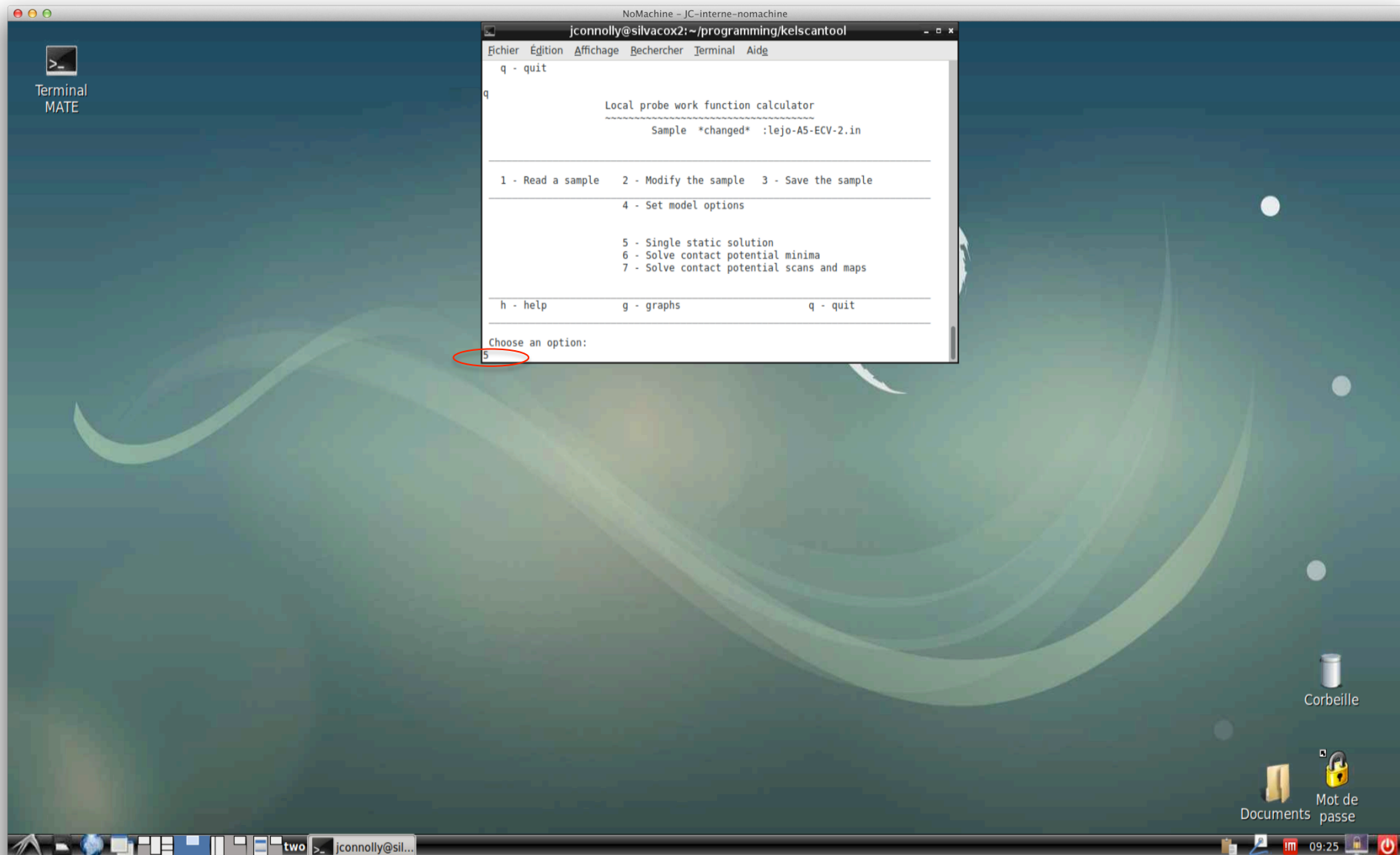

# Kelscan demonstration

Single solution showing acceptor type defects and fields in a multilayer structure

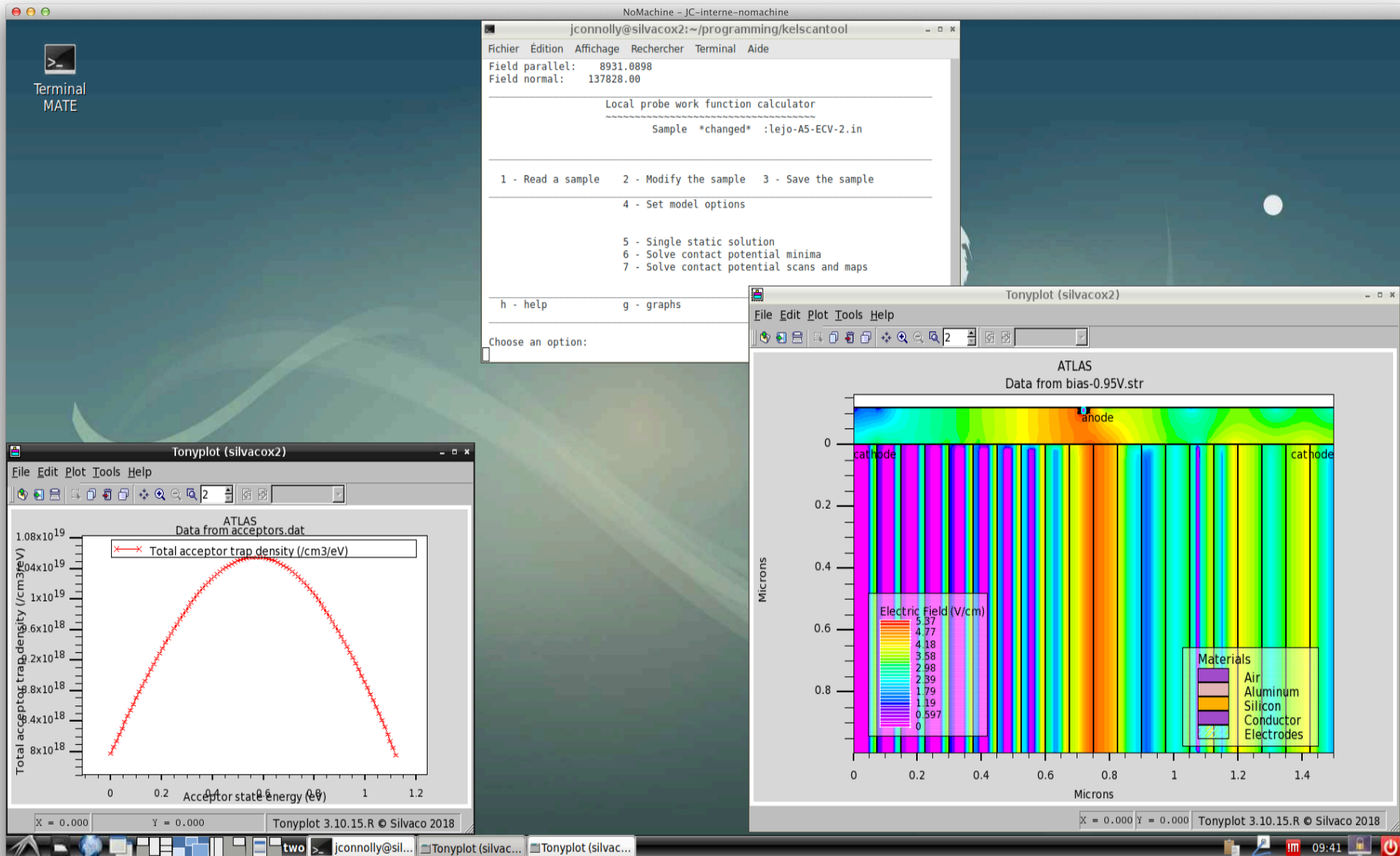



# Kelscan demonstration

Single solution Tonyplot parameter lists – here band structure and field

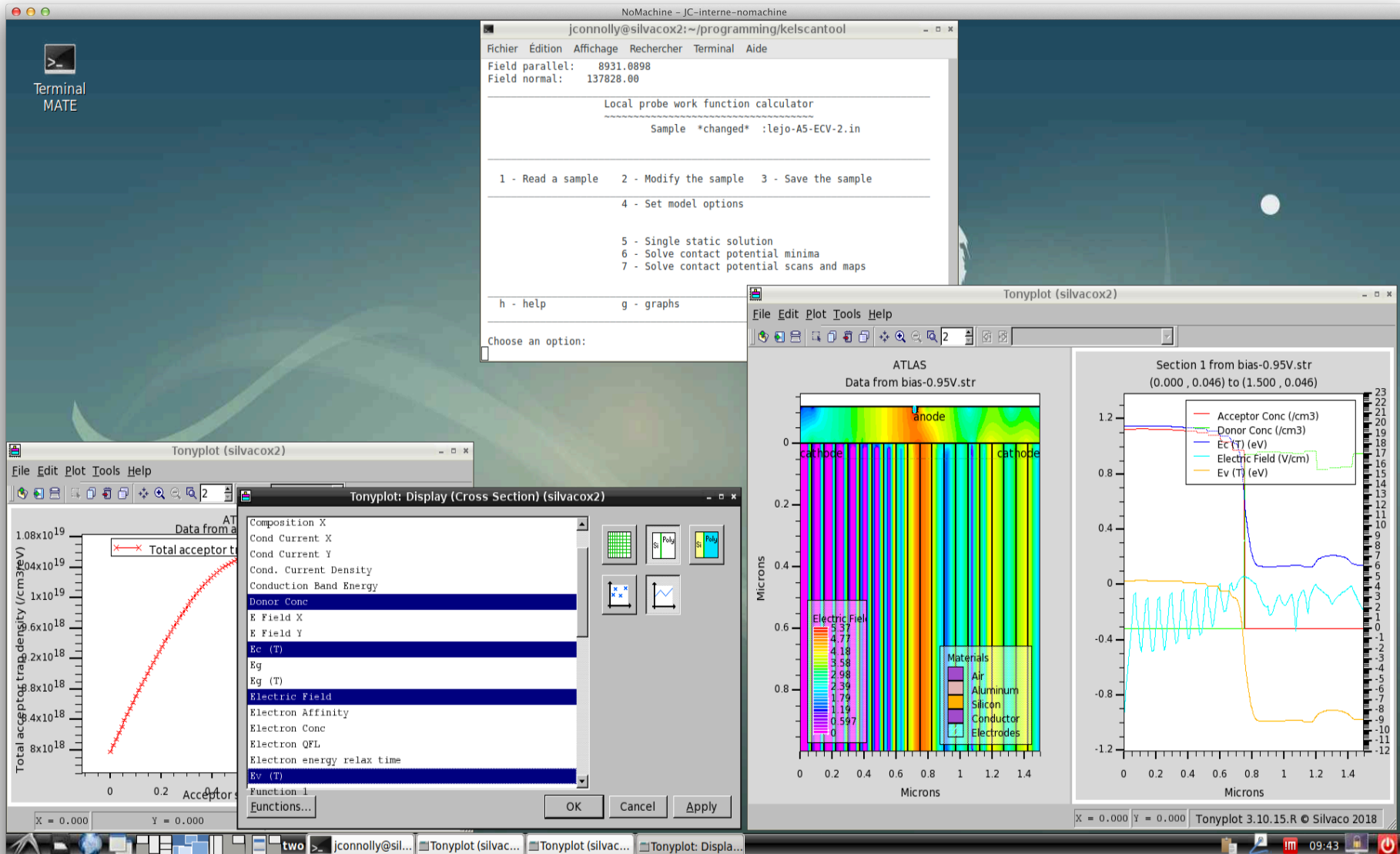

# Kelscan demonstration

The prime function : the contact potential solution

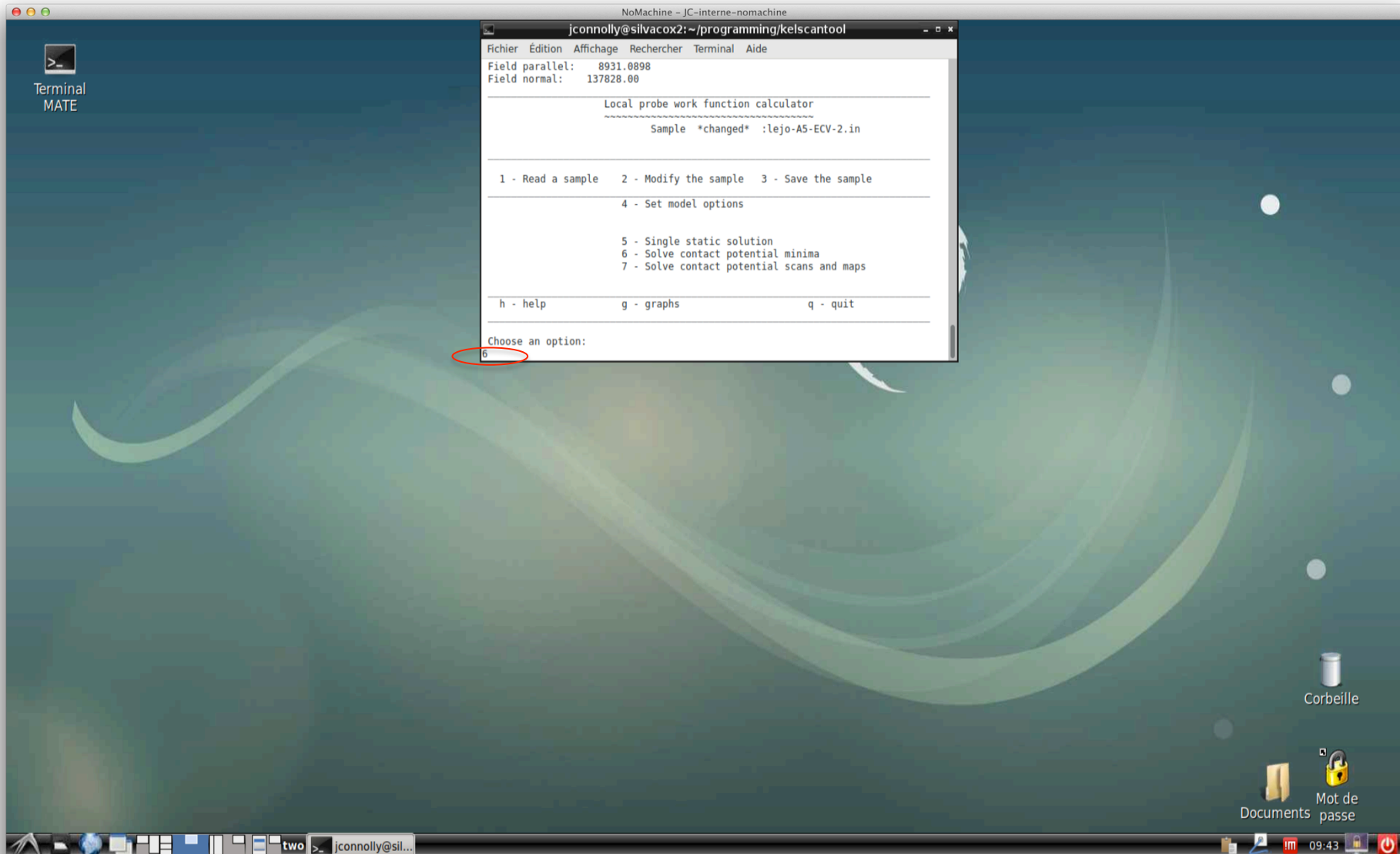

# Kelscan demonstration

A range of methods for flexibility: Spot method preferred (Speed).

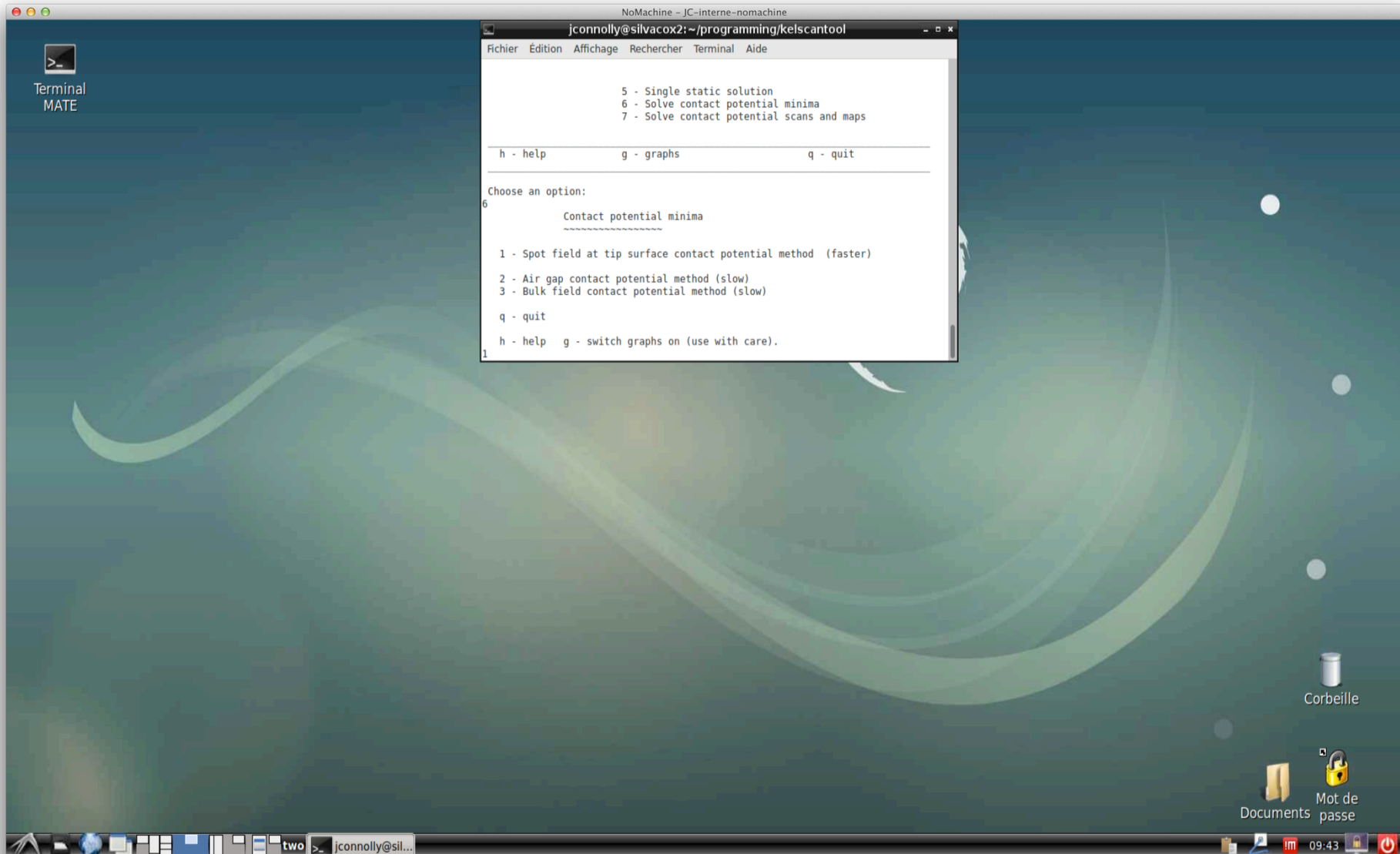

# Kelscan demonstration

Contact potential evaluated from two points (assumes linearity)

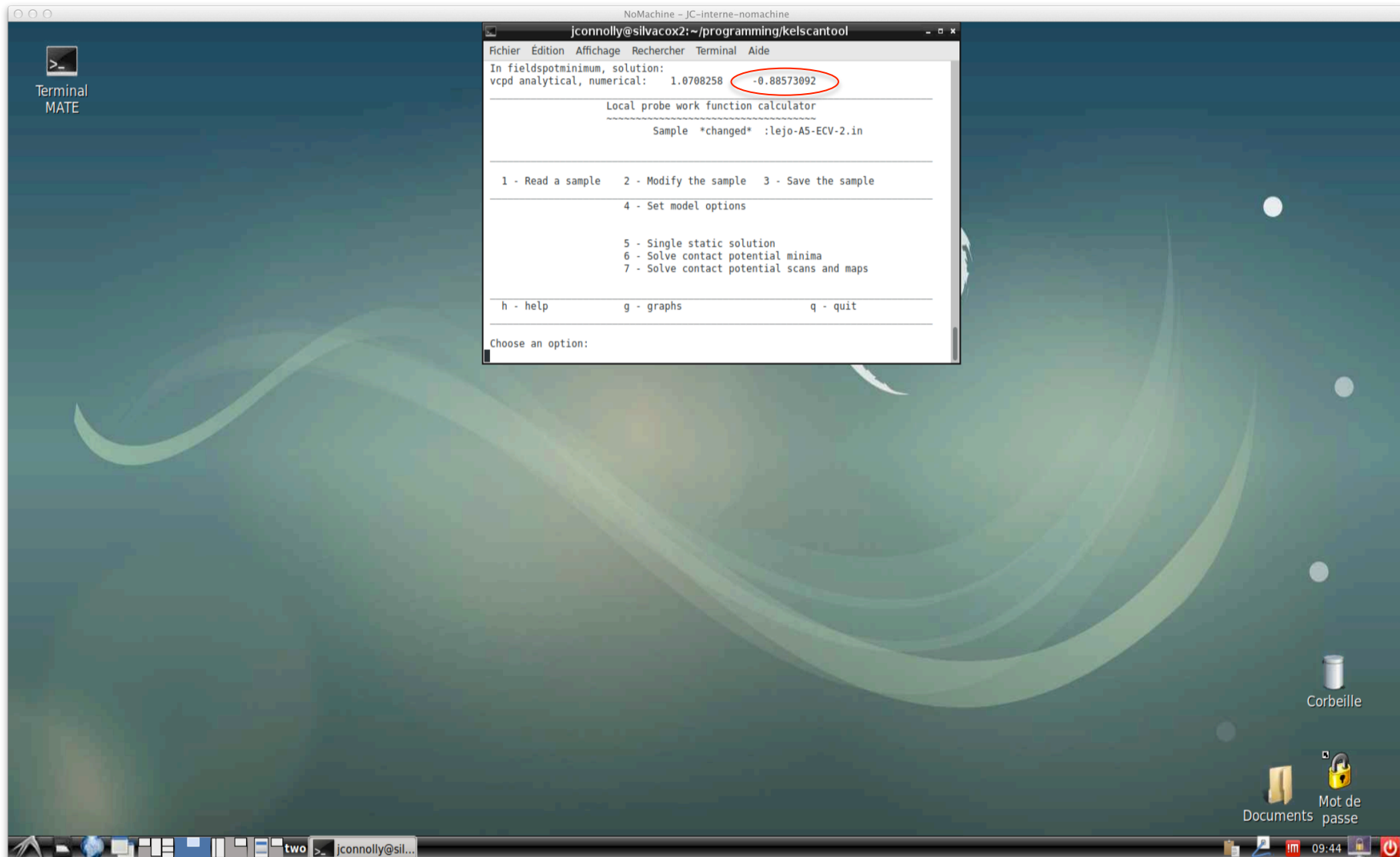

# Kelscan demonstration

## Contact potential scans

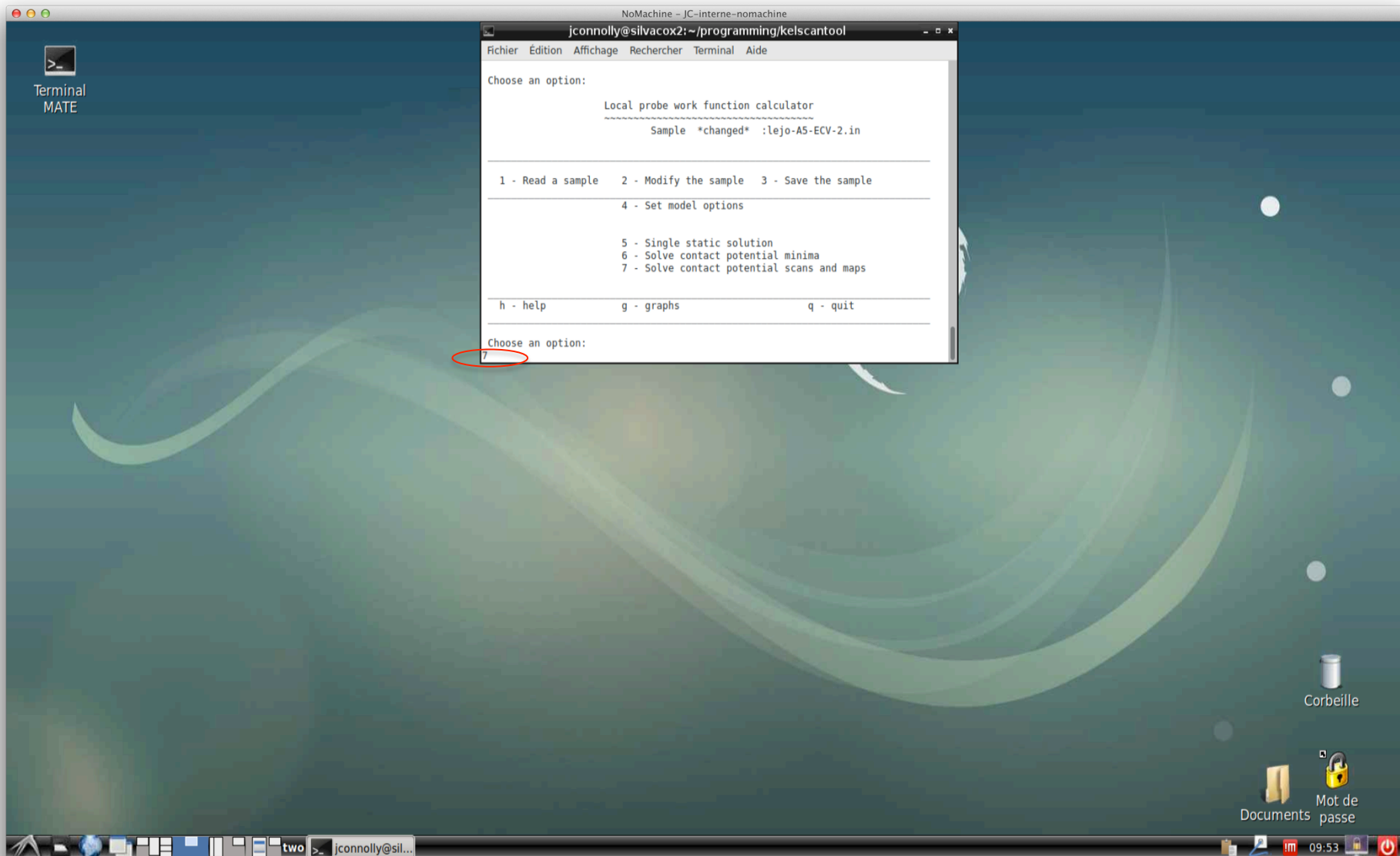

# Kelscan demonstration

## Contact potential scan over the surface

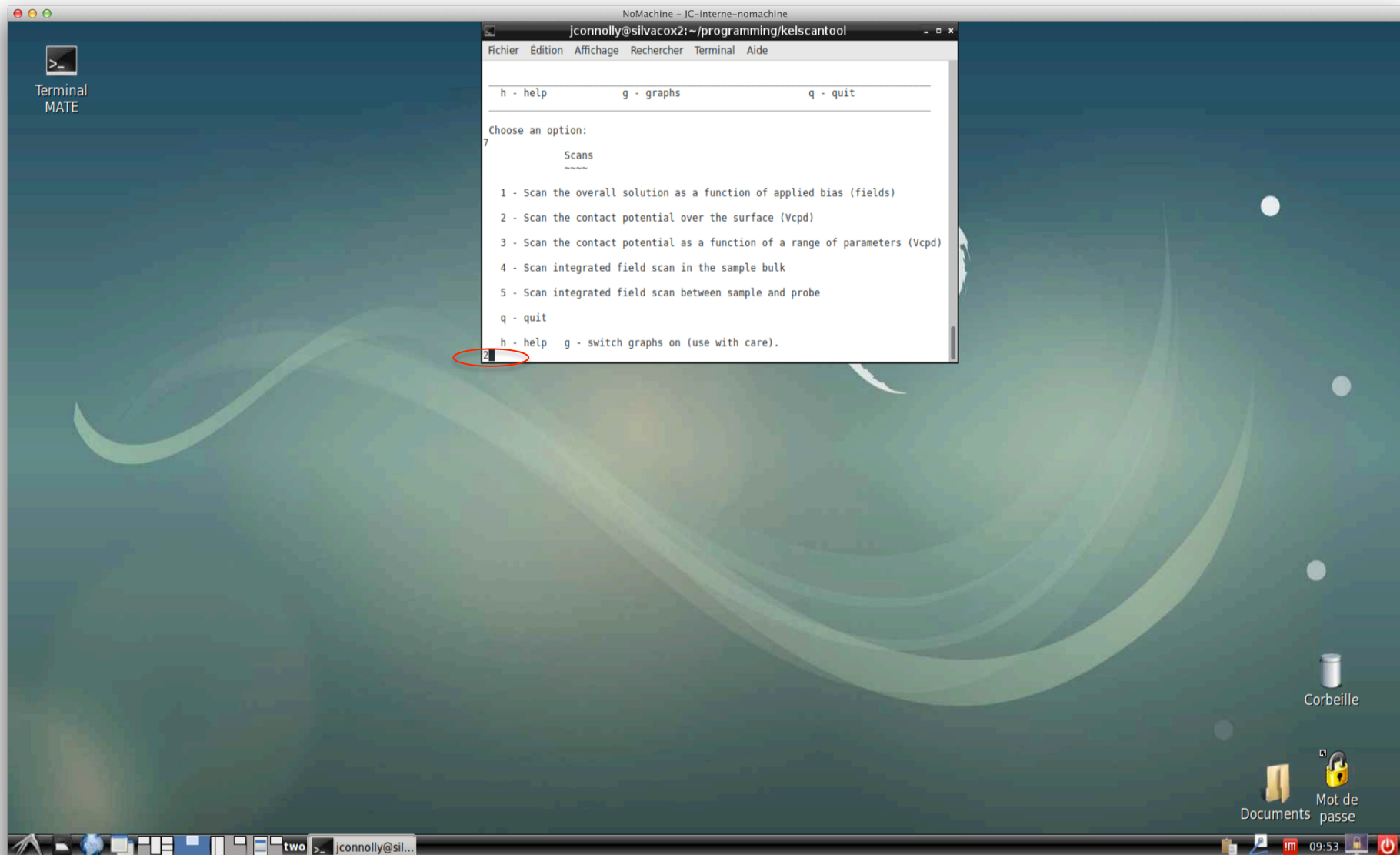

# Kelscan demonstration

Contact potential scan over the surface : range and resolution (integer grid spacing)

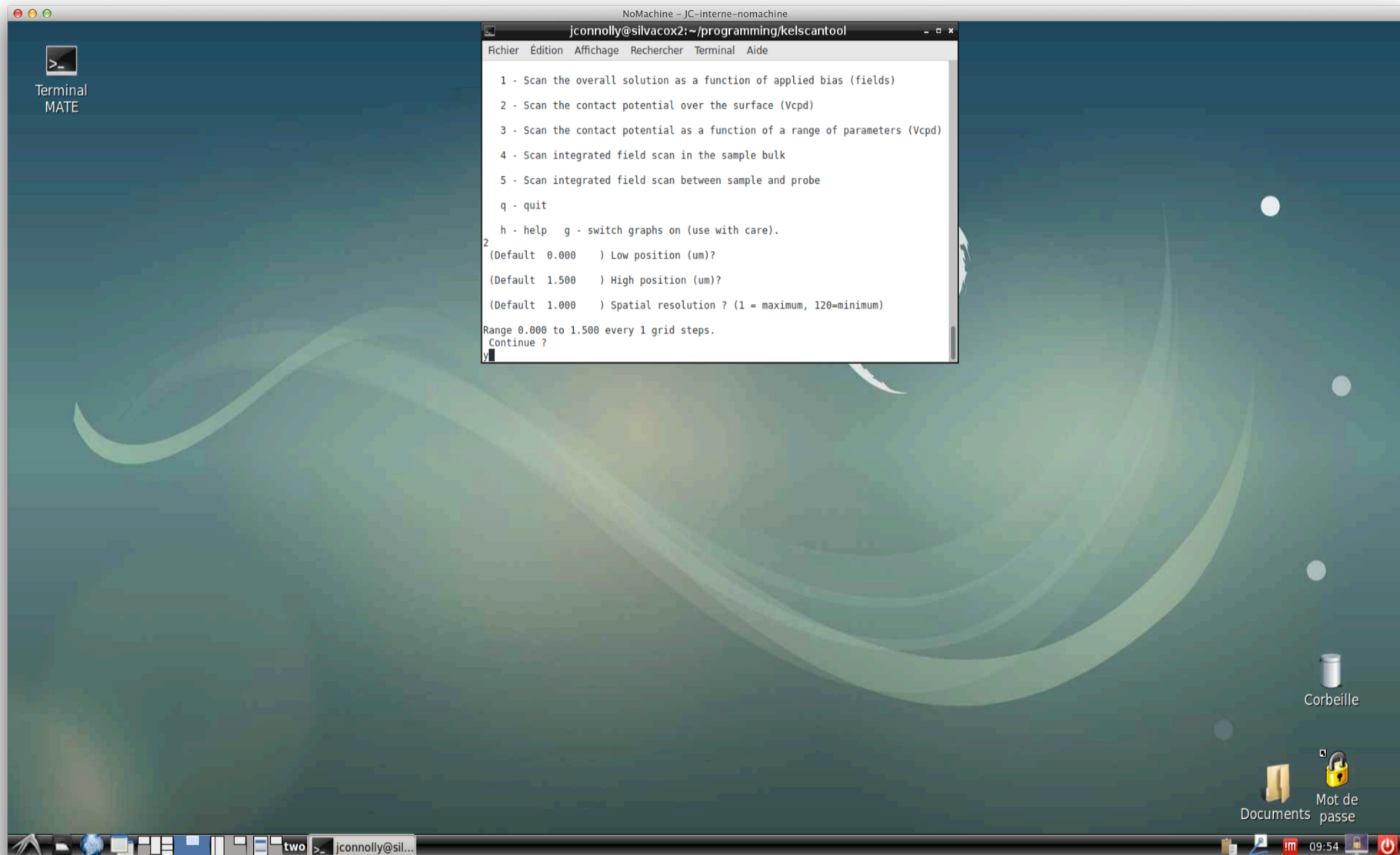

```

NoMachine - JC-interne-nomachine
jconnolly@silvacox2:~/programming/kelscantool
Fichier Edition Affichage Rechercher Terminal Aide

1 - Scan the overall solution as a function of applied bias (fields)
2 - Scan the contact potential over the surface (Vcpd)
3 - Scan the contact potential as a function of a range of parameters (Vcpd)
4 - Scan integrated field scan in the sample bulk
5 - Scan integrated field scan between sample and probe
q - quit
h - help g - switch graphs on (use with care).
2
(Default 0.000 ) Low position (um)?
(Default 1.500 ) High position (um)?
(Default 1.000 ) Spatial resolution ? (1 = maximum, 120=minimum)
Range 0.000 to 1.500 every 1 grid steps.
Continue ?
y

```

# Kelscan demonstration

## Contact potential scan : comparison with doping

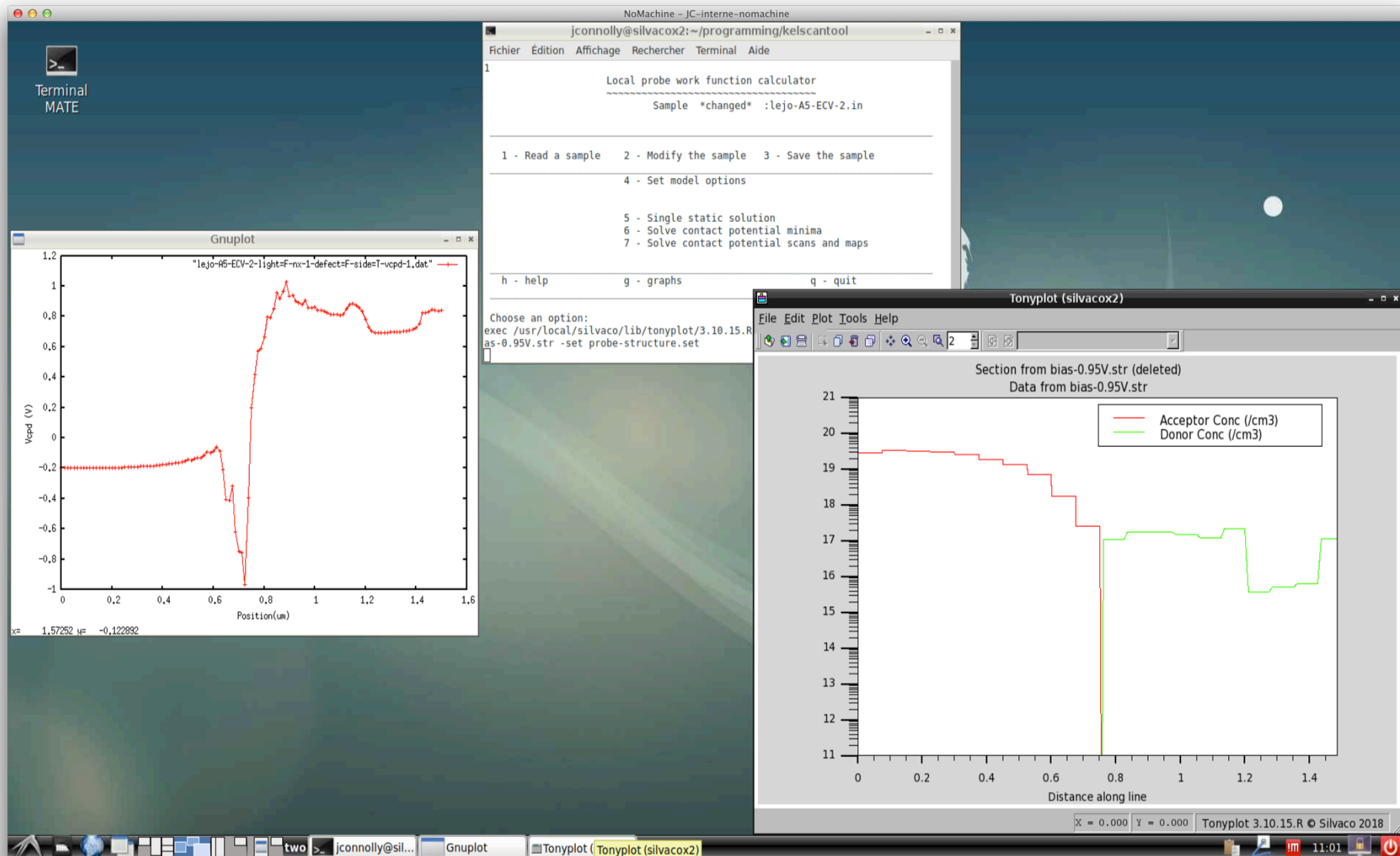



# Kelscan demonstration

Parameter scans : simple single layer homogeneous p-type Si

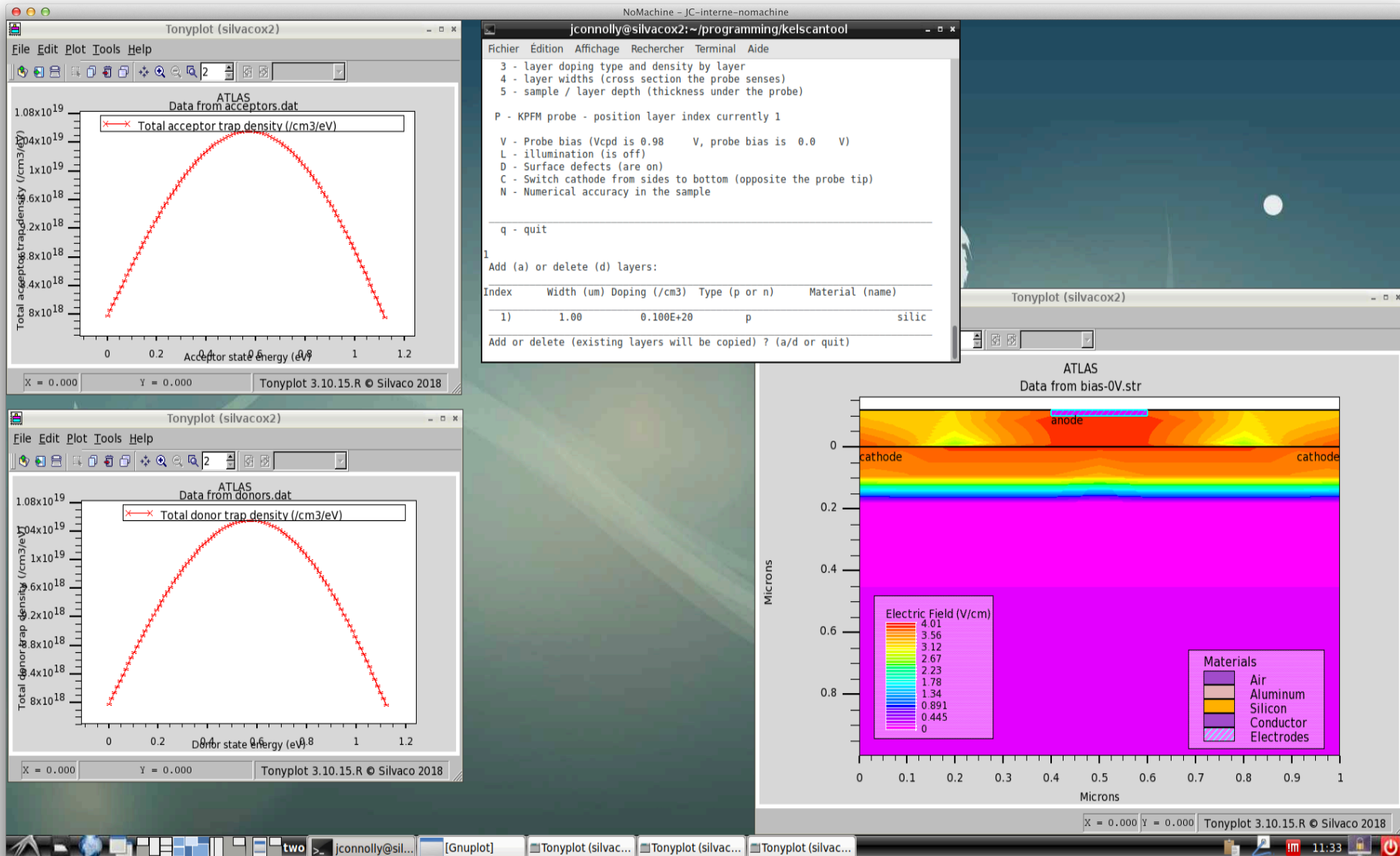

# Kelscan demonstration

## Scanning option 3 : Vcpd scans for a range of parameters

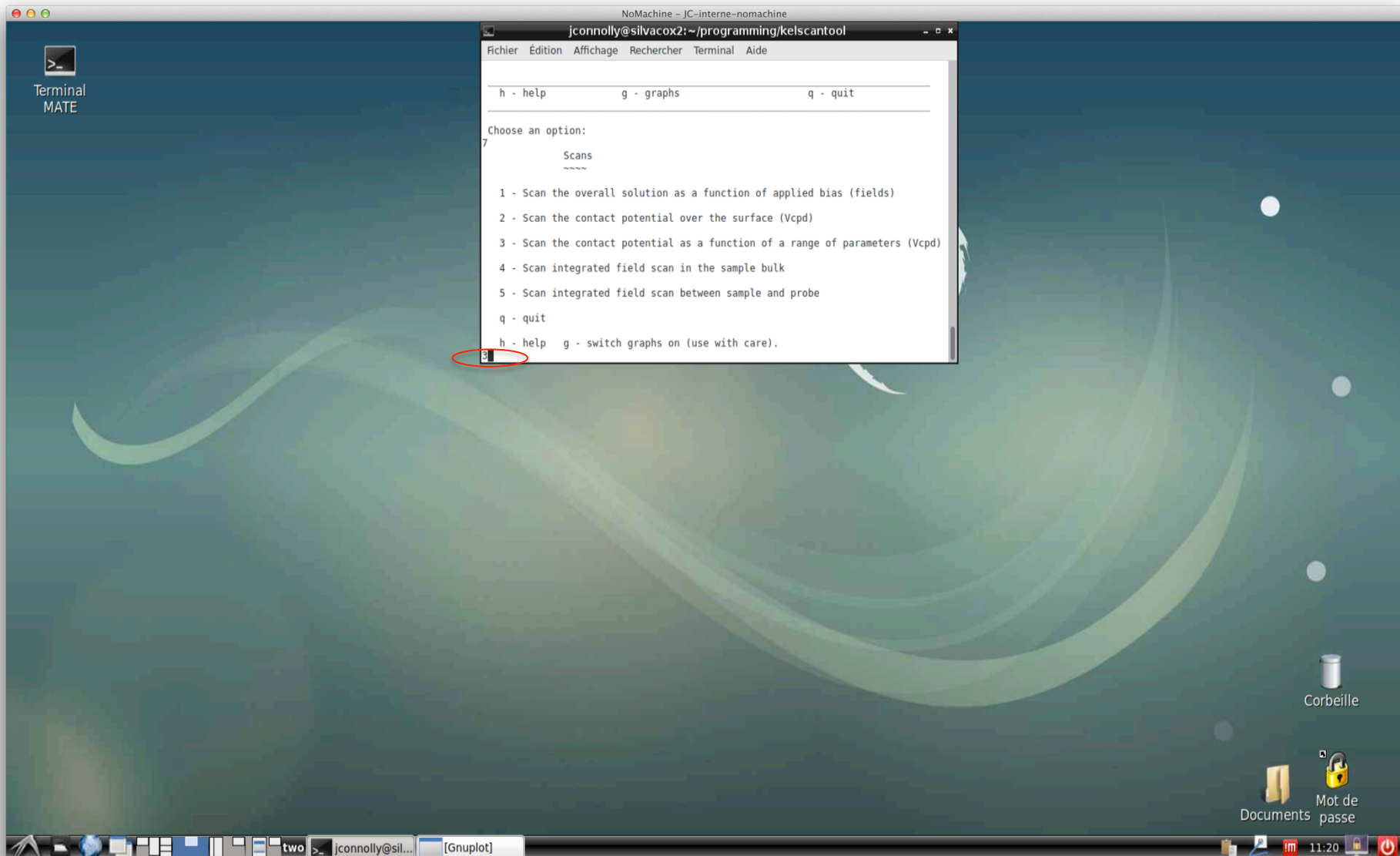

# Kelscan demonstration

2D scan example : First variable, acceptor defect peak density scan

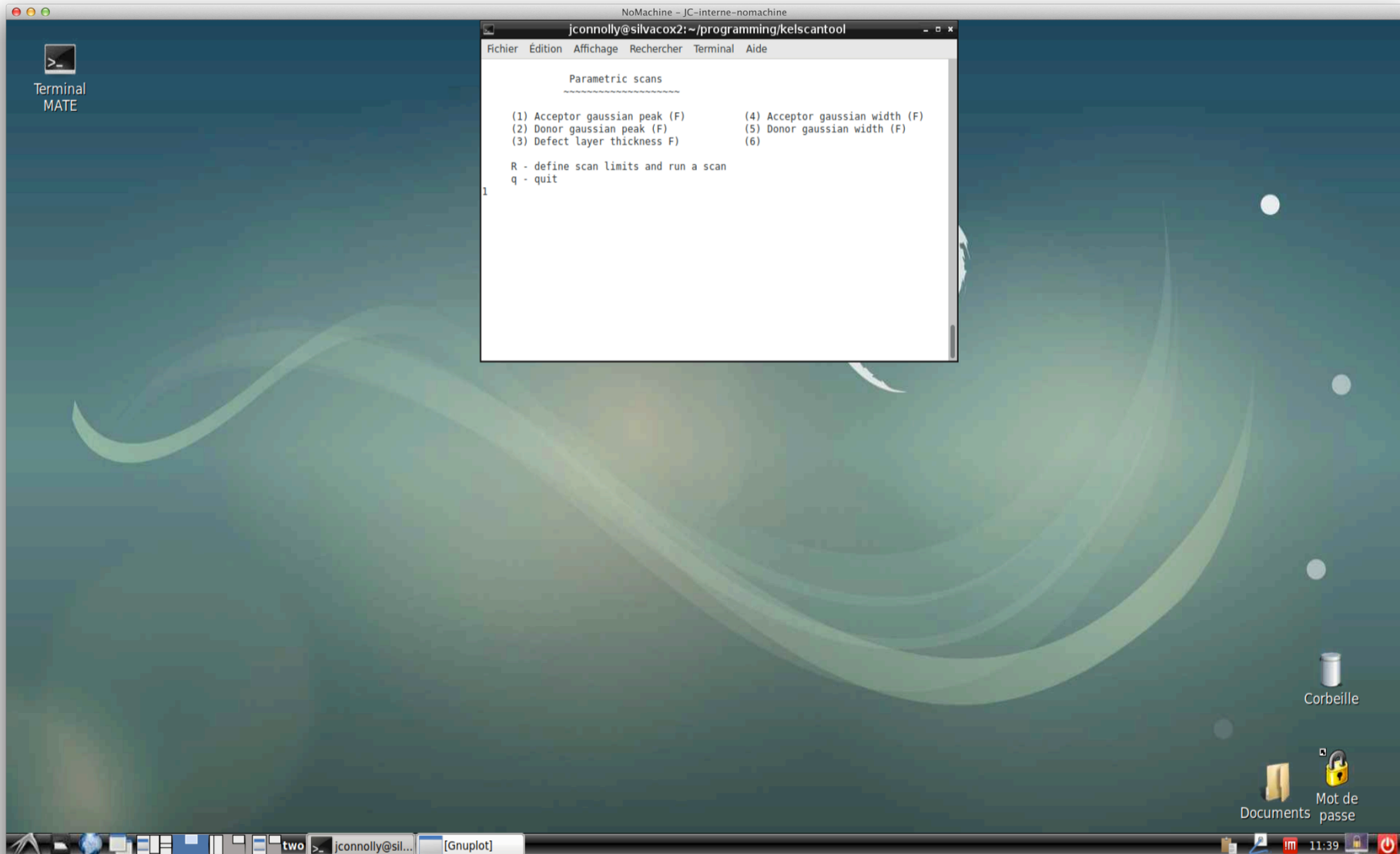

# Kelscan demonstration

2D scan example : Second variable, donor defect peak density scan

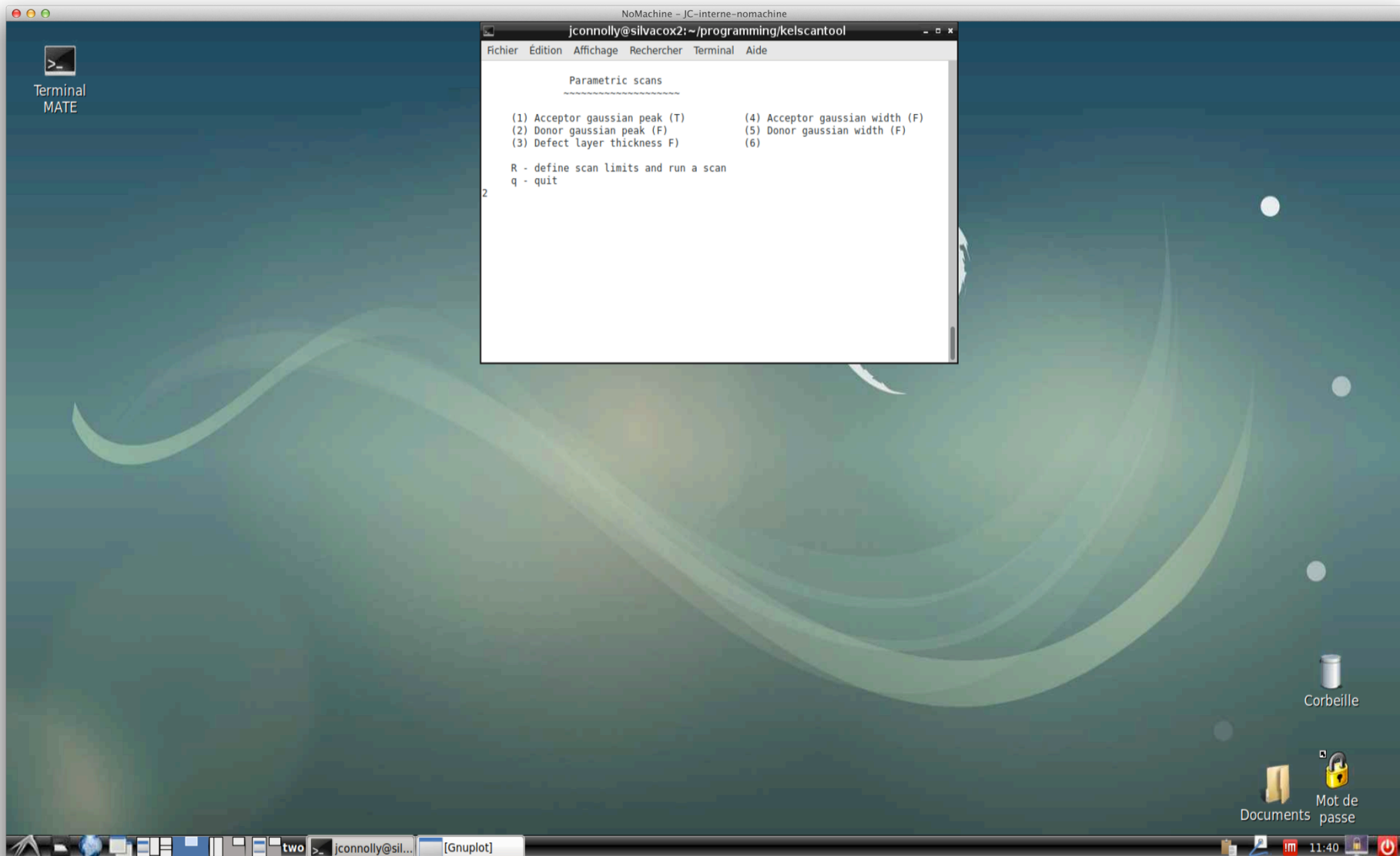

# Kelscan demonstration

## Run 2D profile

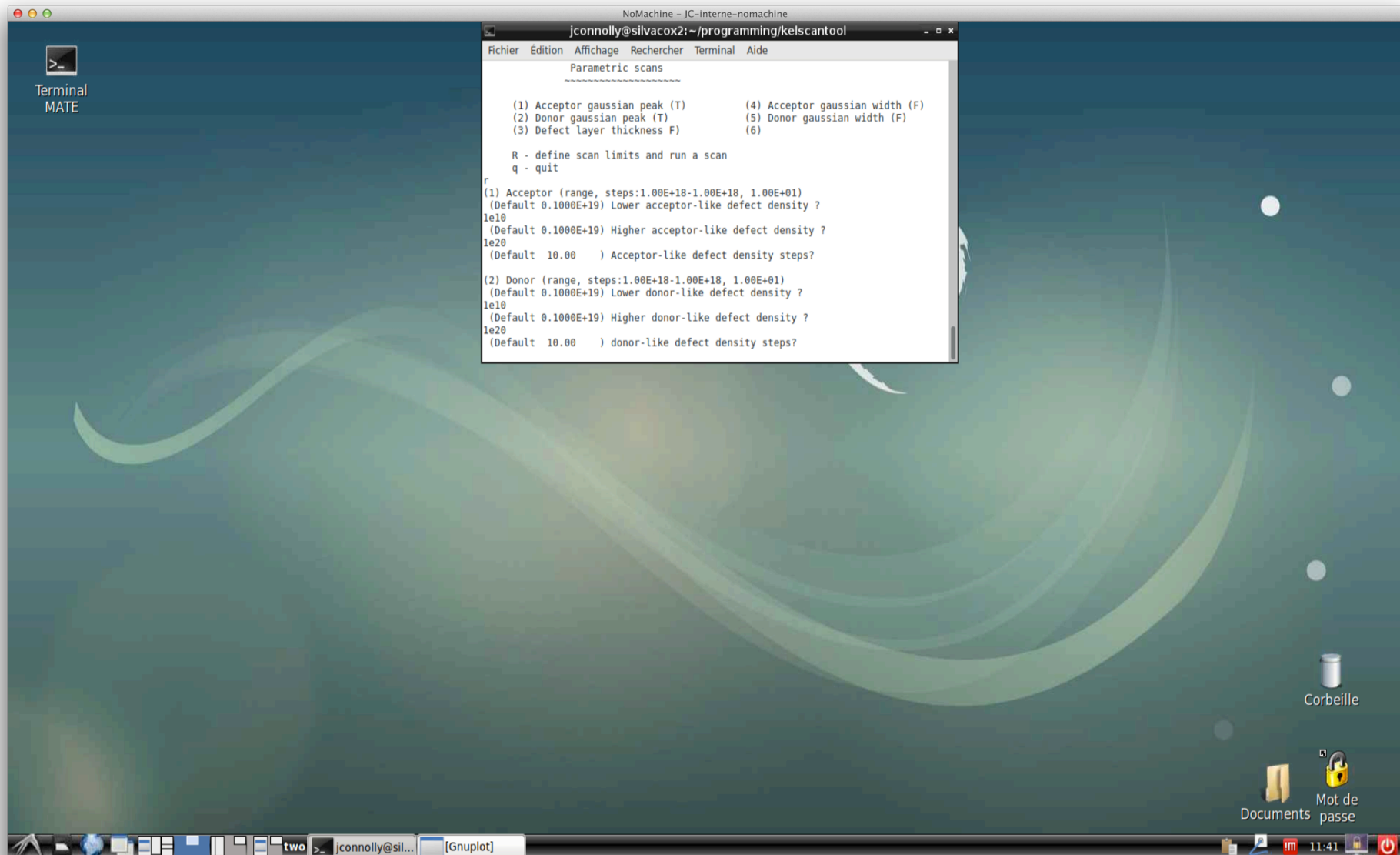

```
Terminal
MATE

NoMachine - JC-interne-nomachine
jconnolly@silvacox2: ~/programming/kelscantool
Fichier  Edition  Affichage  Rechercher  Terminal  Aide

Parametric scans
-----

(1) Acceptor gaussian peak (T)      (4) Acceptor gaussian width (F)
(2) Donor gaussian peak (T)        (5) Donor gaussian width (F)
(3) Defect layer thickness (F)     (6)

R - define scan limits and run a scan
q - quit

r
(1) Acceptor (range, steps:1.00E+18-1.00E+18, 1.00E+01)
(Default 0.1000E+19) Lower acceptor-like defect density ?
1e10
(Default 0.1000E+19) Higher acceptor-like defect density ?
1e20
(Default 10.00 ) Acceptor-like defect density steps?

(2) Donor (range, steps:1.00E+18-1.00E+18, 1.00E+01)
(Default 0.1000E+19) Lower donor-like defect density ?
1e10
(Default 0.1000E+19) Higher donor-like defect density ?
1e20
(Default 10.00 ) donor-like defect density steps?
```

# Kelscan demonstration

Resulting contact potential map : Data fitting identifies zone consistent with experiment

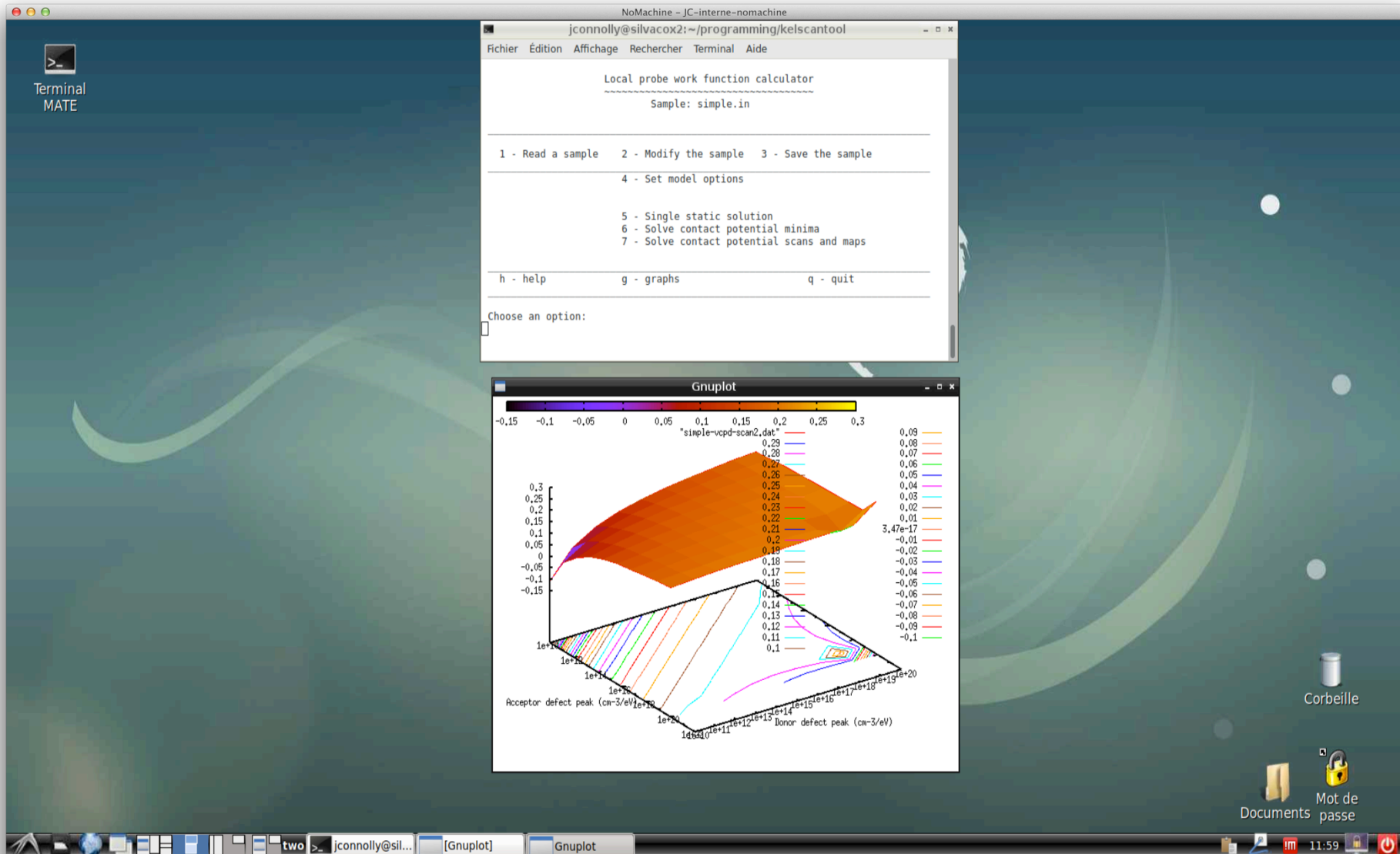

# Surface photovoltage simulations

## Definitions :

- SPV : The difference in light and dark work functions :  $SPV = \phi(Light) - \phi(Dark)$  independent of tip reference.
- Structure : Symmetric c-Si pn junctions (p-doped layer  $1E17cm^{-3}$   $0.3\mu m$  ; n-doped layer :  $1E17cm^{-3}$   $0.3\mu m$ )

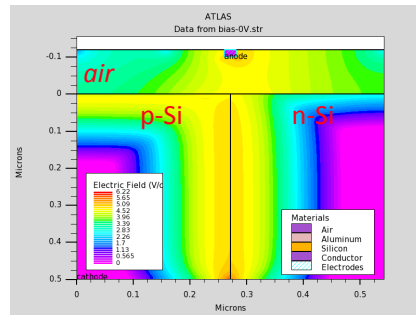

1) pn – surface donor defects  $1e19cm/2$

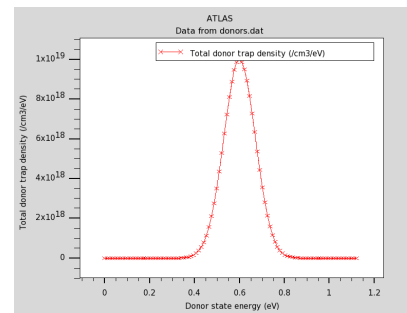

2) Surface defect donors

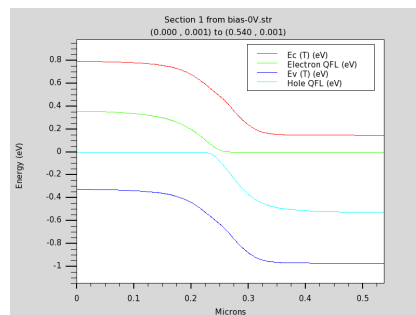

3) Surface transverse cut: Bands and populations (light)

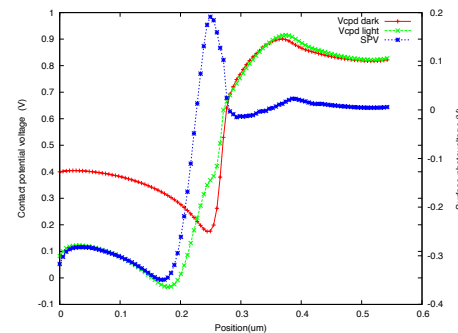

4) Surface photovoltage – p side

Surface donor defects : • p-side surface depletion and band bending.  
 • n-side close to charge neutral

=> SPV signal on p-side

# Surface photovoltage simulations

## Definitions :

- SPV : The difference in light and dark work functions :  $SPV = \varphi(Light) - \varphi(Dark)$  independent of tip reference.
- Structure : Symmetric c-Si pn junctions (p-doped layer  $1E17cm^{-3}$   $0.3\mu m$  ; n-doped layer :  $1E17cm^{-3}$   $0.3\mu m$ )

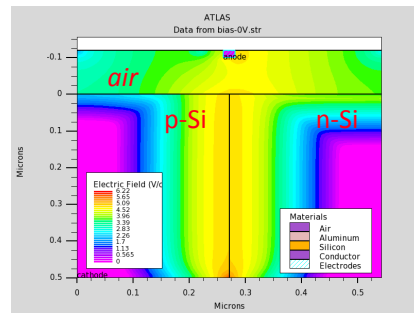

5) pn – surface acceptor defects  $1e19/cm^3$

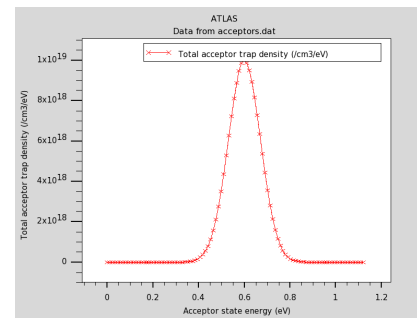

6) Surface acceptor distribution

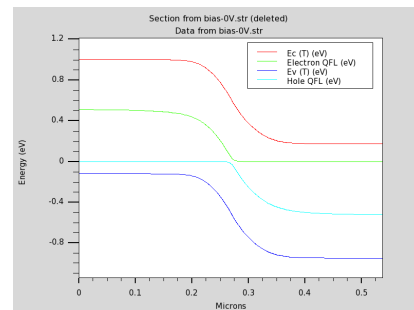

7) Surface transverse cut: Bands and populations (light)

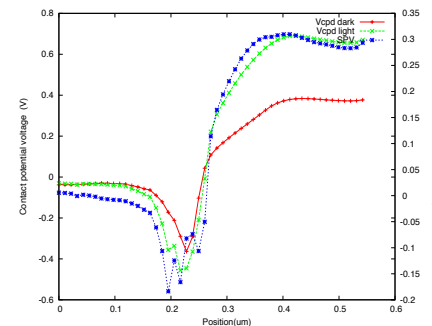

8) Surface photovoltage – n side

- Surface acceptor defects :
- p-side surface depletion and band bending.
  - n-side close to charge neutral

=> SPV signal on p-side



## Concluding remarks

---

### 1) *Focus of this presentation*

- *Introduction to advanced KPFM techniques*
- *Presentation of user friendly numerical modelling*

### 2) *Next steps :*

- *Refine description (KPFM tip size for example)*
- *Analyse real materials*

*=> Publication : NanoTexology partner EPJPV*

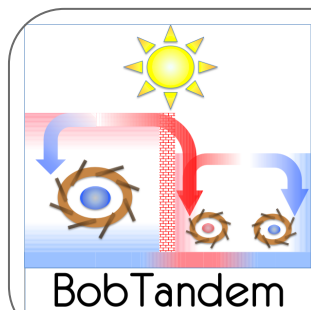

*Support for this work : H2020 - SolarEranet  
Project **BOBTandem** - 2019-2022  
<https://bobtandem.wordpress.com>*

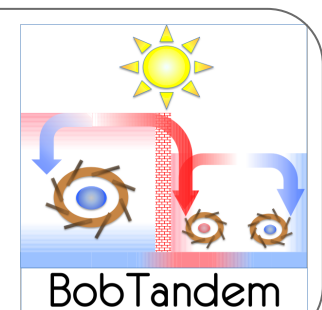



Horizon 2020

*NanoTechnology-NN22*

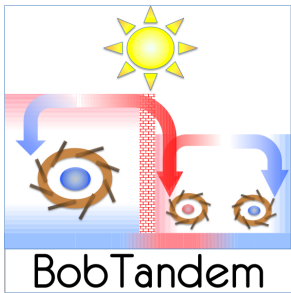

*Thank you for your attention*

